





# STHOR



20V Li-Ion



more on pages  
więcej na stronach 249-252



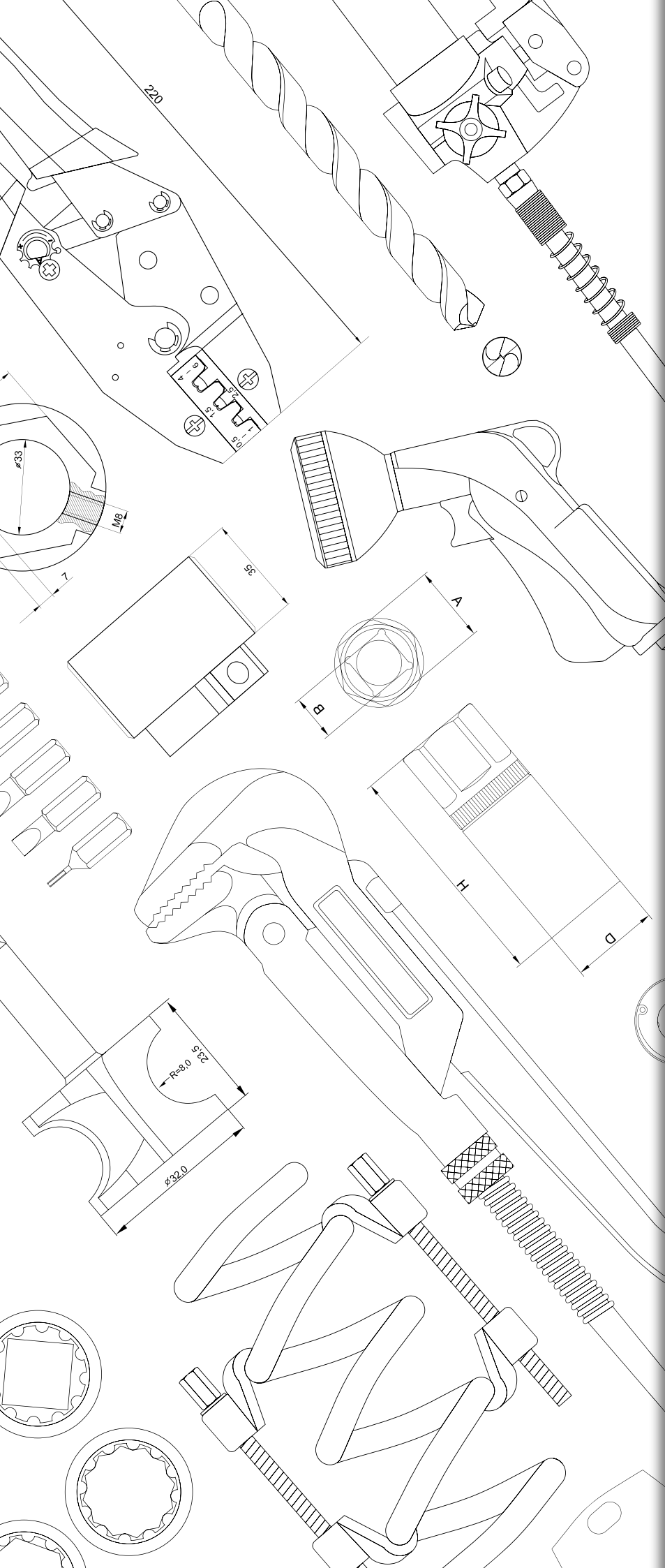

TOYA SA  
ul. Sołtysowicka 13-15  
51-168 Wrocław  
☎ (+48 71) 32 46 200

sales@yato.pl (sale)  
export@yato.pl (export)  
import@yato.pl (import)

ODDZIAŁ WARSZAWSKI  
Teren Mapletree Park Nadarzyn  
al. Kasztanowa 160  
05-831 Młochów k. Warszawy

☎ (+48 22) 73 82 800  
☎ (+48 22) 73 82 828  
sales@yato.pl (sale)  
export@yato.pl (export)



**1** **Spanners** 6-13

Klucze



**2** **Sockets, accessories & sets** 14-23

Klucze nasadowe, akcesoria i zestawy



**3** **Screwdrivers & screwdriver bits** 24-41

Wkrętaki i końcówki wkrętakowe



**4** **Pliers** 42-49

Szczypce



**5** **Electrician tools** 50-55

Narzędzia dla elektryków



**6** **Hammers, chisels, punches & axes** 56-67

Młotki, dłuta, przecinaki i siekiery



**7** **Clamps & vices** 68-73

Ściski i imadła





**8 Cutting tools** 74-117

Narzędzia tnące

**9 Plumbing tools** 118-127

Narzędzia hydrauliczne

**10 Fastening tools** 128-143

Narzędzia do łączenia

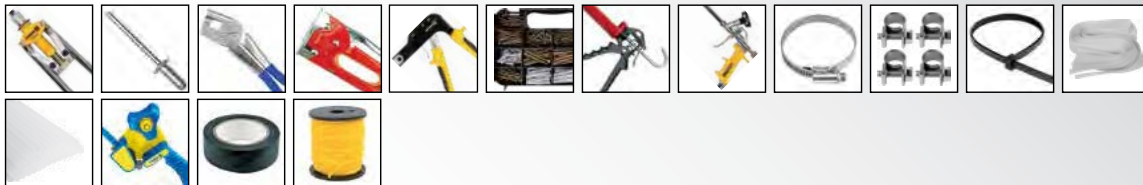
**11 Plastering & bricklaying tools** 144-185

Narzędzia budowlane i malarskie

**12 Measuring tools** 186-201

Narzędzia miernicze

**13 Pneumatic tools** 202-213

Narzędzia pneumatyczne

**14 Special automotive tools & equipment** 214-243

Narzędzia i wyposażenie warsztatu samochodowego





**15 Power tools & accessories** 244-273

Elektronarzędzia i akcesoria

**STWOR** **LUND** **FLO**



**16 Welding equipment** 274-279

Sprzęt spawalniczy



**17 Safes, padlocks & locks** 280-287

Sejfy, kłódki i zamki



**18 Accessories** 288-293

Akcesoria



**19 Bicycle accessories** 294-299

Akcesoria rowerowe



**20 Kitchen and home appliance** 300-329

Sprzęt AGD



**21 Household equipment** 330-355

Gospodarstwo domowe



## 22 Health & safety products Artykuły BHP

356-369



## 23 Electric products Artykuły elektryczne

370-383



## 24 Garden tools & power tools Narzędzia i elektronarzędzia ogrodowe

384-449



## 25 Sanitary ware & hydraulics Armatura sanitarna i hydraulika

450-485

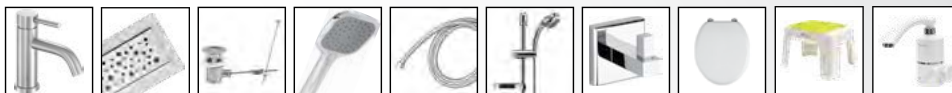

Memo



# 1

## Spanners Klucze



### Combination spanners Klucze płasko-oczkowe

8-10



Combination spanners & sets, polished head  
Klucze płasko-oczkowe i zestawy,  
polerowana główka.....

8

Combination spanners & sets, satin finish CrV  
Klucze płasko-oczkowe i zestawy,  
wykończenie satynowe CrV.....

9

### Combination ratchet wrenches Klucze płasko-oczkowe z grzechotką

10



Combination ratchet wrenches  
Klucze płasko-oczkowe z grzechotką.....

10

Combination ratchet wrench sets  
Zestawy kluczy płasko-oczkowych z grzechotką.....

10

### Double open end spanners Klucze płaskie

10-11



Double open end spanners & sets, polished head  
Klucze płaskie i zestawy, polerowana główka.....

10

Double open end spanner sets, satin finish CrV  
Zestawy kluczy płaskich,  
wykończenie satynowe CrV.....

11

### Bi-hexagonal ring spanners Klucze oczkowe odgięte

11



Bi-hexagonal ring spanner sets, polished head  
Zestawy kluczy oczkowych odgiętych, polerowana główka.....

11

### Open end swivel socket spanners Klucze płasko-nasadowe

11



### T-type deep socket wrenches Klucze nasadowe typu „T”

11

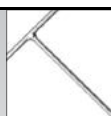

### Box end wrenches Klucze rurowe

11



### L-type wrenches Klucze nasadowe typu „L”

12



### Multipipe wrenches Klucze uniwersalne

12



### Double ratchet wrenches Klucze nasadkowe z grzechotką

12



### Adjustable wrenches Klucze nastawne

12-13



### Torque wrenches Klucze dynamometryczne

13





1

EN Combination spanner  
 PL Klucz płasko-oczkowy  
 DE Maulringschlüssel  
 RU Ключ комбинированный

CZ Plochý a očkový klíč  
 RO Cheie combinată  
 HU Kulcs villás-csillag  
 ES Combinada con llave de estrella



No.	Size / Rozmiar [mm]	
51060	6	200/1200
51070	7	200/1000
51080	8	60/600
51090	9	60/600
51100	10	50/600
51110	11	50/400
51120	12	50/400
51130	13	50/400
51140	14	50/300
51150	15	50/300
51160	16	50/200
51170	17	20/200
51180	18	25/200
51190	19	30/120
51200	20	20/160
51210	21	20/120
51220	22	30/120
51240	24	15/90
51270	27	15/60
51300	30	10/40
51320	32	10/40

EN Combination spanner set  
 PL Komplet kluczy płasko-oczkowych  
 DE Maulringschlüsselsatz  
 RU Набор ключей комбинированных  
 CZ Souprava plochých a očkových klíčů  
 RO Set chei combinate rasucite  
 HU Kulcskészlet, villás-csillag  
 ES Juego de combinadas con llave de estrella



No.	Size / Rozmiar [mm]	pcs / szt.	
51580	6, 8, 10, 11, 13, 14, 17, 19	8	5/50
51620	6, 7, 8, 9, 10, 11, 12, 13, 14, 17, 19, 22	12	5/20
51650	6, 7, 8, 9, 10, 11, 12, 13, 14, 15, 16, 17, 18, 19, 20, 21, 22, 23, 24, 25, 26, 27, 28, 30, 32	25	1/4

EN Combination spanner  
 PL Klucz płasko-oczkowy  
 DE Maulringschlüssel  
 RU Ключ комбинированный  
 CZ Plochý a očkový klíč  
 RO Cheie combinată  
 HU Kulcs villás-csillag  
 ES Combinada con llave de estrella



STHOR

No.	Size / Rozmiar [mm]	
51040	6	200/1200
51042	8	100/600
51044	10	50/600
51046	12	50/400
51047	13	50/400
51048	14	50/300
51049	15	50/300
51051	17	20/200

EN Combination spanner set  
 PL Komplet kluczy płasko-oczkowych  
 DE Maulringschlüsselsatz  
 RU Набор ключей комбинированных  
 CZ Souprava plochých a očkových klíčů  
 RO Set chei combinate rasucite  
 HU Kulcskészlet, villás-csillag  
 ES Juego de combinadas con llave de estrella



No.	Size / Rozmiar [mm]	pcs / szt.	
51560	8, 10, 12, 13, 14, 17	6	15/60
51590	6, 8, 10, 12, 13, 14, 17, 19	8	10/40
51630	6, 7, 8, 9, 10, 11, 12, 13, 14, 17, 19, 22	12	5/20
51640	6, 7, 8, 9, 10, 11, 12, 13, 14, 17, 19, 21, 24, 27, 32	15	2/12
51645	6, 7, 8, 9, 10, 11, 12, 13, 14, 15, 16, 17, 18, 19, 21, 22, 24, 27, 30, 32	20	2/8

EN Combination spanner set  
 PL Komplet kluczy płasko-oczkowych  
 DE Maulringschlüsselsatz  
 RU Набор ключей комбинированных  
 CZ Souprava plochých a očkových klíčů  
 RO Set chei combinate rasucite  
 HU Kulcskészlet, villás-csillag  
 ES Juego de combinadas con llave de estrella



VOREL

No.	Size / Rozmiar [mm]	pcs / szt.	
50850	8, 10, 12, 13, 14, 17	6	4/40
50861	6, 8, 10, 13, 14, 17, 19, 22	8	4/32
50871	6, 7, 8, 9, 10, 11, 12, 13, 14, 17, 19, 22	12	2/20

EN Combination spanner set  
 PL Komplet kluczy plasko-oczkowych  
 DE Maulringschlüsselsatz  
 RU Набор ключей комбинированных

CZ Souprava plochých a očkových klíčů  
 RO Set chei combinate rasucite  
 HU Kulcskészlet, villás-csillag  
 ES Juego de combinadas con llave de estrella

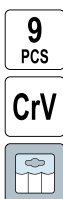

VOREL

No.	Size / Rozmiar	pcs / szt.	
50880	1/4" (6.3 mm), 5/16" (7.9 mm), 3/8" (9.5 mm), 7/16" (11.1 mm), 1/2" (12.7 mm), 9/16" (14.3 mm), 5/8" (15.9 mm), 1/16" (17.5 mm), 3/4" (19.0 mm)	9	10

EN Combination spanner set  
 PL Komplet kluczy plasko-oczkowych  
 DE Maulringschlüsselsatz  
 RU Набор ключей комбинированных

CZ Souprava plochých a očkových klíčů  
 RO Set chei combinate rasucite  
 HU Kulcskészlet, villás-csillag  
 ES Juego de combinadas con llave de estrella



VOREL

No.	Size / Rozmiar [mm]	pcs / szt.	
51720	8, 10, 12, 13, 14, 17	6	4/40
51721	6, 8, 10, 12, 13, 14, 17, 19	8	4/32
51722	6, 7, 8, 9, 10, 11, 12, 13, 14, 17, 19, 22	12	2/20

EN Combination spanner set  
 PL Komplet kluczy plasko-oczkowych  
 DE Maulringschlüsselsatz  
 RU Набор ключей комбинированных

CZ Souprava plochých a očkových klíčů  
 RO Set chei combinate rasucite  
 HU Kulcskészlet, villás-csillag  
 ES Juego de combinadas con llave de estrella



VOREL

No.	Size / Rozmiar [mm]	pcs / szt.	
51705	8, 10, 12, 13, 14, 15, 17, 19	8	30

EN Combination spanner  
 PL Klucz plasko-oczkowy  
 DE Maulringschlüssel  
 RU Ключ комбинированный  
 CZ Plochý a očkový klíč  
 RO Cheie combinată  
 HU Kulcs villás-csillag  
 ES Combinada con llave de estrella



1



VOREL

No.	Size / Rozmiar [mm]	
51671	6	20/400
51672	7	20/400
51673	8	20/400
51674	9	20/400
51675	10	20/320
51676	11	20/240
51677	12	20/240
51678	13	20/200
51679	14	20/200
51680	15	20/200
51681	16	20/200
51682	17	20/160
51683	18	20/160
51684	19	20/160
51685	20	20/120
51686	21	20/120
51687	22	20/120
51688	23	10/80
51689	24	10/80
51690	25	10/60
51691	26	10/40
51692	27	10/40
51693	28	10/40
51694	29	10/40
51695	30	10/40
51696	32	10/40

EN Combination spanner set  
 PL Komplet kluczy plasko-oczkowych  
 DE Maulringschlüsselsatz  
 RU Набор ключей комбинированных

CZ Souprava plochých a očkových klíčů  
 RO Set chei combinate rasucite  
 HU Kulcskészlet, villás-csillag  
 ES Juego de combinadas con llave de estrella



VOREL

No.	Size / Rozmiar [mm]	pcs / szt.	
51710	6, 8, 10, 11, 12, 13, 14, 15, 17, 18, 19, 22	12	20



1

- EN Combination spanner set
- PL Komplet kluczy płasko-oczkowych
- DE Maulringschlüsselsatz
- RU Набор ключей комбинированных
- CZ Souprava plochých a očkových klíčů
- RO Set chei combinate rascuite
- HU Kulcskészlet, villás-csillag
- ES Juego de combinadas con llave de estrella

25 PCS CrV



No.	Size / Rozmiar [mm]	pcs / szt.	
51715	6, 7, 8, 9, 10, 11, 12, 13, 14, 15, 16, 17, 18, 19, 20, 21, 22, 23, 24, 25, 26, 27, 28, 30, 32	25	4

- EN Combination ratchet wrench set
- PL Zestaw kluczy płasko-oczkowych z grzechotką
- DE Ratschenringmaulschlüssel-Satz
- RU Набор комбинированных ключей с трещоткой
- CZ Klíče ráčnové sada
- RO Set chei combinate
- HU Racsnis csillag-villás kulcs készlet
- ES Juego de llaves planas con matraca

4 PCS 72T 60Si2Mn CrV



No.	Size / Rozmiar [mm]	pcs / szt.	
52661	10, 13, 17, 19	4	10/20

- EN Double open end spanner set
- PL Komplet kluczy płaskich
- DE Doppelmaulschlüsselsatz
- RU Набор рожковых ключей
- CZ Souprava plochých klíčů
- RO Set chei fixe
- HU Villás kulcskészlet
- ES Juego de llaves fijas



No.	Size / Rozmiar [mm]	pcs / szt.	
50560	6x7, 8x9, 10x11, 12x13, 14x15, 16x17	6	20/80
50590	6x7, 8x9, 10x11, 12x13, 14x15, 16x17, 18x19, 20x22	8	10/40
50610	6x7, 8x9, 10x11, 12x13, 14x15, 16x17, 18x19, 20x22, 24x27, 30x32	10	5/20
50630	6x7, 8x9, 10x11, 12x13, 14x15, 16x17, 18x19, 20x22, 21x23, 24x26, 25x28, 27x32	12	5/15

- EN Combination ratchet wrench
- PL Klucz płasko-oczkowy z grzechotką
- DE Ratschenringmaulschlüssel
- RU Ключ комбинированный с трещоткой
- CZ Klíč očkoplochý ráčnový
- RO Cheie combinata cu crichet
- HU Csillag-villás kulcs racsnis
- ES Llave combinada fija abierta y carraca

72T 60Si2Mn CrV



No.	Size / Rozmiar [mm]	
52652	10	10/100
52653	11	10/100
52654	12	10/100
52655	13	10/100
52656	14	10/100
52657	15	10/100
52658	17	10/50
52659	19	10/50
52660	22	10/40

- EN Double open end spanner
- PL Klucz płaski
- DE Doppelmaulschlüssel
- RU Ключ рожковый
- CZ Plochý klíč
- RO Cheie fixă
- HU Villáskulcs
- ES Llave fija



No.	Size / Rozmiar [mm]	
50070	6x7	100/1000
50090	8x9	60/600
50100	8x10	60/600
50110	10x11	60/600
50120	10x13	50/500
50130	12x13	50/500
50150	14x15	50/300
50170	13x17	50/300
50190	17x19	30/180
50220	19x22	30/180
50270	24x27	25/100
50330	30x32	15/60

- EN Double open end spanner set
- PL Komplet kluczy płaskich
- DE Doppelmaulschlüsselsatz
- RU Набор ключей рожковых
- CZ Souprava plochých klíčů
- RO Set chei fixe
- HU Kulcskészlet, villás
- ES Juego de llaves fijas



No.	Size / Rozmiar [mm]	pcs / szt.	
50580	6x7, 8x9, 10x11, 12x13, 14x15, 16x17, 18x19, 20x22	8	10/40

EN Double open end spanner set  
 PL Komplet kluczy płaskich  
 DE Doppelmaulschlüsselsatz  
 RU Набор рожковых ключей  
 CZ Souprava plochých klíčů  
 RO Set chei fixe  
 HU Villás kulcskészlet  
 ES Juego de llaves fijas



**VOREL**

No.	Size / Rozmiar [mm]	pcs / szt.	
51740	6x7, 8x9, 10x11, 12x13, 14x15, 16x17	6	4/40
51741	6x7, 8x9, 10x11, 12x13, 14x15, 16x17, 18x19, 20x22	8	4/24

EN Bi-hexagonal ring spanner set  
 PL Komplet kluczy oczkowych odgiętych  
 DE Doppelringschlüsselsatz  
 RU Набор ключей накидных изогнутых  
 CZ Klíče očkové vyhnuté sada  
 RO Set chei inelare cu cot  
 HU Csillagkulcs készlet  
 ES Juego de llaves de estrella acodadas

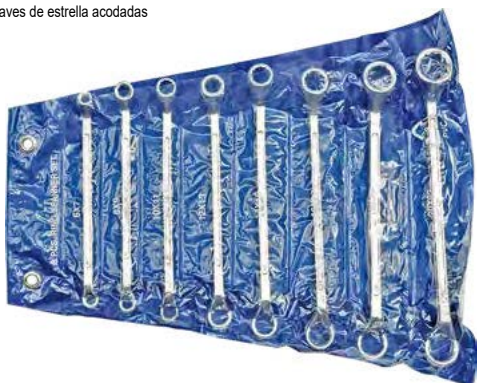

No.	Size / Rozmiar [mm]	pcs / szt.	
52580	6x7, 8x9, 10x11, 12x13, 14x15, 16x17, 18x19, 20x22	8	5/20

EN Socket wrench  
 PL Klucz nasadowy  
 DE Steckschlüssel  
 RU Ключ торцевой  
 CZ Nastrčný kľúč  
 RO Cheie tubulară  
 HU Nyeles dugókulcs  
 ES Llave tubular



No.	Socket size / Rozmiar nasadki [mm]	L [mm]	
56770	8	190	50
56710	8	380	50
56780	10	190	50
56720	10	380	50
56790	13	190	50
56730	13	380	50

EN Bi-hexagonal ring spanner set  
 PL Komplet kluczy oczkowych odgiętych  
 DE Doppelringschlüsselsatz  
 RU Набор ключей накидных изогнутых

CZ Klíče očkové vyhnuté sada  
 RO Set chei inelare cu cot  
 HU Csillagkulcs készlet  
 ES Juego de llaves de estrella acodadas



No.	Size / Rozmiar [mm]	pcs / szt.	
52630	6x7, 8x9, 10x11, 12x13, 14x15, 16x17, 18x19, 20x21, 22x23, 24x25, 26x27, 28x32	12	2/8

EN Open end swivel head socket wrench  
 PL Klucz płasko-nasadowy, przegubowy  
 DE Maul-Steckschlüssel  
 RU Ключ рожково-торцевой с шарниром

CZ Kľuč nasad. ploch.  
 RO Chei fixe-tubulare  
 HU Kulcs villás-dűgő  
 ES Combinada con vaso



No.	Size / Rozmiar [mm]	
52680	8	20/200
52700	10	20/200
52730	13	20/200
52740	14	20/200
52750	15	25/100
52770	17	25/100
52790	19	25/50
52820	22	25/50

EN Tubular socket wrench set  
 PL Zestaw kluczy rurowych  
 DE Rohrsteckschlüsselsatz  
 RU Набор ключей трубчатых  
 CZ Klíče trubkové  
 RO Chei pt. țevi  
 HU Csőkulcs  
 ES Llaves de tubería



No.	Size / Rozmiar [mm]	pcs / szt.	
52900	6x7, 8x9, 10x11, 12x13, 14x15, 16x17, 18x19, 20x22	10	6/24

**10**  
PCS





1

EN Socket wrench  
 PL Klucz nasadowy  
 DE Steckschlüssel  
 RU Ключ торцевой

CZ Nastrčný klíč  
 RO Cheie tubulară  
 HU Nyeles dugókulcs  
 ES Llave tubular



No.	Size / Rozmiar [mm]	
54600	6	80/320
54610	7	80/320
54620	8	50/200
54630	9	40/160
54640	10	40/160
54650	11	25/100
54660	12	25/100
54670	13	25/100
54680	14	20/80
54690	15	20/80
54700	16	12/48
54710	17	12/48
54720	18	10/40
54730	19	10/40
54750	21	6/24
54760	22	6/24
54780	24	6/24

EN Adjustable wrench  
 PL Klucz nastawny  
 DE Rollgabelschlüssel  
 RU Ключ разводной

CZ Nastavitelný klíč  
 RO Cheie reglabilă  
 HU Állítható svédkulcs  
 ES Llave ajustable tipo inglesa



VOREL

No.	L [mm]	
54061	200	6/60
54062	250	6/36
54063	300	6/24

EN Multipipe wrenches  
 PL Klucze uniwersalne  
 DE Universalschlüssel  
 RU Ключи универсальные  
 CZ Univerzální klíče  
 RO Chei universale  
 HU Univerzális kulcs  
 ES Juego de llaves universales



VOREL

No.	Size [mm]	pcs / szt.	
54000	9-22, 23-32	2	20/40

EN Double ratchet wrench  
 PL Klucz nasadowy z grzechotką  
 DE Gerüstratsche  
 RU Ключ торцевой с трещоткой  
 CZ Ráčnový klíč průchozí dvoustranný  
 RO Cheie tubulară dubla cu cichet  
 HU Kettős racsnis kulcs  
 ES Llave de vaso con carraca



32T



VOREL

No.	Size / Rozmiar [mm]	
52935	17x19	2/40
52936	19x22	2/40

EN Adjustable wrench  
 PL Klucz nastawny  
 DE Rollgabelschlüssel  
 RU Ключ разводной

CZ Nastavitelný klíč  
 RO Cheie reglabilă  
 HU Állítható svédkulcs  
 ES Llave ajustable tipo inglesa



VOREL

No.	L [mm]	Package	
54065	150		6/120
54066	200		6/60
54067	250		6/36
54068	300		6/24
54080	375		2/12
54081	450		2/6

EN Adjustable wrench  
 PL Klucz nastawny  
 DE Rollgabelschlüssel  
 RU Ключ разводной

CZ Nastavitelný klíč  
 RO Cheie reglabilă  
 HU Állítható svédkulcs  
 ES Llave ajustable tipo inglesa



**VOREL**

No.	L [mm]	
54070	150	6/120
54071	200	6/60
54072	250	6/36
54073	300	6/24

EN Torque wrench  
 PL Klucz dynamometryczny wychylny  
 DE Drehmomentschlüssel  
 RU Ключ динамометрический стрелочный  
 CZ Dynamometrický klíč  
 RO Cheie cu dinamometru  
 HU Nyomatékkulcs  
 ES Llave dinamométrico inclin.

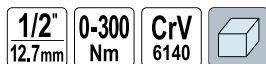

**VOREL**

No.	Ø	
57451	1/2" (12.7 mm)	16

EN Torque wrench  
 PL Klucz dynamometryczny wychylny  
 DE Drehmomentschlüssel  
 RU Ключ динамометрический стрелочный  
 CZ Dynamometrický klíč  
 RO Cheie cu dinamometru  
 HU Nyomatékkulcs  
 ES Llave dinamométrico inclin.

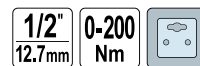

1



**VOREL**

No.	Ø	
57450	1/2" (12.7 mm)	6/24

EN Torque wrench  
 PL Klucz dynamometryczny  
 DE Drehmomentschlüssel  
 RU Ключ динамометрический  
 CZ Dynamometrický klíč  
 RO Cheie cu dinamometru  
 HU Nyomatékkulcs  
 ES Llave dinamométrica



**VOREL**

No.	Ø	L [mm]	Torque / Moment obrotowy [Nm]	Package	
57300	3/8" (9.5 mm)	270	13.6-108		20
57350	1/2" (12.7 mm)	465	28.0-210		10
57400	3/4" (19.0 mm)	625	68-406		10

Memo

# 2

## Sockets, accessories & sets Klucze nasadowe, akcesoria i zestawy





## Sockets Klucze nasadowe



16

### Hexagonal sockets 1/2"

Klucze nasadowe sześciokątne 1/2"..... 16

### Hexagonal sockets 3/4"

Klucze nasadowe sześciokątne 3/4"..... 16

### Universal wrench sockets

Nasadki uniwersalne..... 16

## Accessories Akcesoria



16-17

### Extension bars

Przedłużki..... 16

### Universal joints

Przeguby Cardana..... 16

### Sliding T-bars

Pokrętła typu „T”..... 17

### Speed braces

Rękojeści wygięte..... 17

## Ratchet handles Grzechotki



17-18

## Socket & tool sets Zestawy kluczy nasadowych i narzędziowych



18-23

### Socket sets 1/4"

Zestawy kluczy nasadowych 1/4"..... 18

### Socket sets 3/8"

Zestawy kluczy nasadowych 3/8"..... 18

### Socket sets 1/2"

Zestawy kluczy nasadowych 1/2"..... 18

### Socket sets 3/4"

Zestawy kluczy nasadowych 3/4"..... 19

### Tool sets

Zestawy narzędziowe..... 19

2

EN Hexagonal socket  
 PL Nasadka sześciokątna  
 DE Sechskantenschlüssel  
 RU Торцевая головка 6-гранная

CZ Šestihřanný nástavec  
 RO Cheie tubulară hexagonală  
 HU Hatszögű rátét  
 ES Boquilla hexagonal corta

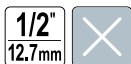

No.	Socket size / Rozmiar nasadki [mm]	Ø	
53100	10	1/2" (12.7 mm)	150/300
53120	12	1/2" (12.7 mm)	150/300
53130	13	1/2" (12.7 mm)	150/300
53140	14	1/2" (12.7 mm)	150/300
53150	15	1/2" (12.7 mm)	150/300
53170	17	1/2" (12.7 mm)	125/250
53180	18	1/2" (12.7 mm)	100/200
53190	19	1/2" (12.7 mm)	100/200
53220	22	1/2" (12.7 mm)	75/150
53240	24	1/2" (12.7 mm)	50/100

EN Universal wrench socket  
 PL Nasadka uniwersalna  
 DE Universal Steckschlüssel  
 RU Головка универсальная



No.	Socket size / Rozmiar nasadki [mm]	Ø	
53002	7-19	3/8" (9.5 mm)	8/48
53003	11-32	1/2" (12.7 mm)	6/24

EN Extension bar  
 PL Przedłużka  
 DE Verlängerung  
 RU Удлинитель для воротка



No.	Ø	L [mm]	
53610	1/2" (12.7 mm)	125	50/100
53630	1/2" (12.7 mm)	250	25/50

EN Extension bar  
 PL Przedłużka  
 DE Verlängerung  
 RU Удлинитель для воротка



No.	Ø	L [mm]	
53650	3/4" (19.0 mm)	100	60
53670	3/4" (19.0 mm)	200	25

EN Hexagonal socket  
 PL Nasadka sześciokątna  
 DE Sechskantenschlüssel  
 RU Торцевая головка 6-гранная

CZ Šestihřanný nástavec  
 RO Cheie tubulară hexagonală  
 HU Hatszögű rátét  
 ES Boquilla hexagonal corta

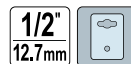

No.	Socket size / Rozmiar nasadki [mm]	Ø	
53332	10	1/2" (12.7 mm)	10/300
53335	13	1/2" (12.7 mm)	10/300
53336	14	1/2" (12.7 mm)	5/300
53337	15	1/2" (12.7 mm)	5/300
53338	16	1/2" (12.7 mm)	5/300
53339	17	1/2" (12.7 mm)	10/250
53340	18	1/2" (12.7 mm)	10/200
53341	19	1/2" (12.7 mm)	10/200

EN Hexagonal socket  
 PL Nasadka sześciokątna  
 DE Sechskantenschlüssel  
 RU Торцевая головка 6-гранная

CZ Šestihřanný nástavec  
 RO Cheie tubulară hexagonală  
 HU Hatszögű rátét  
 ES Boquilla hexagonal corta

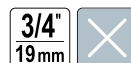

No.	Socket size / Rozmiar nasadki [mm]	Ø	
53400	22	3/4" (19.0 mm)	50
53410	24	3/4" (19.0 mm)	50
53420	27	3/4" (19.0 mm)	50
53430	30	3/4" (19.0 mm)	50
53440	32	3/4" (19.0 mm)	50
53450	36	3/4" (19.0 mm)	50
53460	38	3/4" (19.0 mm)	40
53470	41	3/4" (19.0 mm)	25
53480	46	3/4" (19.0 mm)	20
53490	50	3/4" (19.0 mm)	20

EN Universal joint  
 PL Przegub Cardana  
 DE Kardangelenk  
 RU Карданный шарнир  
 CZ Kardanový kloub  
 RO Articulație Cardanică  
 HU Kardán csukló  
 ES Articulación Cardan



No.	Ø	
53600	1/2" (12.7 mm)	50/100

EN Sliding T-bar  
 PL Pokrętko typu „T”  
 DE Handgriff mit Gleitstück  
 RU Вороток Т-образный

CZ Otočná račka typ „T”  
 RO Măner clupă tipul „T”  
 HU „T” alakú hajtókar  
 ES Mango tipo „T”



No.	Ø	L [mm]	
53700	1/2" (12.7 mm)	250	25/50

EN Speed brace  
 PL Rękojeść wygięta  
 DE Kurbelverlängerung  
 RU Вороток-коловорот

CZ Ohnutá rukojeť  
 RO Măner curbă (manivelă)  
 HU Hajlított markolat  
 ES Mango encorvado



No.	Ø	L [mm]	
53730	1/2" (12.7 mm)	400	40

EN Ratchet handle  
 PL Grzechotka  
 DE Hebelumschaltknarre  
 RU Трещотка

CZ Ráčna  
 RO Dispozitiv de prindere cu clichet  
 HU Racsnis hajtókar  
 ES Carraca



No.	Ø	L [mm]	
53561	1/4" (6.3 mm)	135	40/80
53563	1/2" (12.7 mm)	240	20/40

EN Ratchet handle  
 PL Grzechotka  
 DE Hebelumschaltknarre  
 RU Трещотка

CZ Ráčna  
 RO Dispozitiv de prindere cu clichet  
 HU Racsnis hajtókar  
 ES Carraca



No.	Ø	L [mm]	Number of teeth / Liczba zębów	
53571	1/4" (6.3 mm)	150	72	6/36
53572	3/8" (9.5 mm)	200	72	6/36
53573	1/2" (12.7 mm)	260	72	6/36

EN Sliding T-bar  
 PL Pokrętko typu „T”  
 DE Handgriff mit Gleitstück  
 RU Вороток Т-образный

CZ Otočná račka typ „T”  
 RO Măner clupă tipul „T”  
 HU „T” alakú hajtókar  
 ES Mango tipo „T”



No.	Ø	L [mm]	
53710	3/4" (19.0 mm)	450	20

EN Ratchet handle  
 PL Grzechotka  
 DE Hebelumschaltknarre  
 RU Трещотка

CZ Ráčna  
 RO Dispozitiv de prindere cu clichet  
 HU Racsnis hajtókar  
 ES Carraca



No.	Ø	
53500	1/4" (6.3 mm)	40/80
53520	3/8" (9.5 mm)	25/50
53540	1/2" (12.7 mm)	20/40

EN Flexible ratchet handle  
 PL Grzechotka przegubowa  
 DE Gelenk-Hebelumschaltknarre  
 RU Трещотка шарнирная

CZ Kloubová řehtačka  
 RO Antrenor cu clichet, flexibil  
 HU Csuklós racsnis  
 ES Llave de carraca articulada

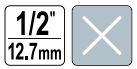

No.	Ø	L [mm]	
53560	1/2" (12.7 mm)	250	25/50

EN Ratchet handle  
 PL Grzechotka  
 DE Hebelumschaltknarre  
 RU Трещотка

CZ Ráčna  
 RO Dispozitiv de prindere cu clichet  
 HU Racsnis hajtókar  
 ES Carraca



No.	Ø	L [mm]	Number of teeth / Liczba zębów	
53575	1/4" (6.3 mm)	155	72	12/72
53576	3/8" (9.5 mm)	200	72	6/48
53577	1/2" (12.7 mm)	250	72	6/36



- EN Ratchet handle
- PL Grzechotka
- DE Hebelumschaltknarre
- RU Трещотка
- CZ Ráčna
- RO Dispozitiv de prindere cu clichet
- HU Racsnis hajtókar
- ES Carraca



No.	Ø	L [mm]	pcs / szt.	Box
53580	3/4" (19.0 mm)	500	10	

- EN Socket set
- PL Komplet nasadek z akcesoriami
- DE Sechskantenschlüssel-Einsatz
- RU Набор торцевых головок
- CZ Sada nástrčných klíčů a ráčny
- RO Trusă de scule
- HU Dugókulcs készlet racsnis hajtókarral
- ES Juego de boquillas con accesorios



1/4" (6.3 mm): 4, 4.5, 5, 5.5, 6, 7, 8, 9, 10, 11, 12 mm; 3/8" (9.5 mm): 13, 14, 17 mm; 3/8" (9.5 mm) x 21 mm; 3/8" (9.5 mm) x 70 mm; 1/4" (6.3 mm) x 3/8" (9.5 mm); 1/4" (6.3 mm) x 50 mm; 3/8" (9.5 mm) x 190 mm; 3/8" (9.5 mm)

No.	Ø	pcs / szt.	Box
58210	1/4" (6.3 mm), 3/8" (9.5 mm)	20	10

- EN Socket set
- PL Komplet nasadek z akcesoriami
- DE Sechskantenschlüssel-Einsatz
- RU Набор торцевых головок
- CZ Sada nástrčných klíčů a ráčny
- RO Trusă de scule
- HU Dugókulcs készlet racsnis hajtókarral
- ES Juego de boquillas con accesorios



1/2" (12.7 mm): 10, 11, 12, 13, 14, 15, 16, 17, 18, 19, 20, 21, 22, 23, 24, 27, 30, 32 mm; 1/2" (12.7 mm) x 21 mm; 1/2" (12.7 mm) x 125 mm; 1/2" (12.7 mm) x 250 mm; 1/2" (12.7 mm) x 250 mm; 1/2" (12.7 mm) x 240 mm; 1/2" (12.7 mm) x 390 mm

No.	Ø	pcs / szt.	Box
58260	1/2" (12.7 mm)	24	5

- EN Socket set
- PL Komplet nasadek z akcesoriami
- DE Sechskantenschlüssel-Einsatz
- RU Набор торцевых головок
- CZ Sada nástrčných klíčů a ráčny
- RO Trusă de scule
- HU Dugókulcs készlet racsnis hajtókarral
- ES Juego de boquillas con accesorios



1/4" (6.3 mm): 4, 4.5, 5, 5.5, 6, 6.5, 7, 8, 9, 10, 11, 12, 13 mm; 1/4" (6.3 mm) x 50 mm; 1/4" (6.3 mm) x 120 mm; 1/4" (6.3 mm)

No.	Ø	pcs / szt.	Box
58160	1/4" (6.3 mm)	16	20

- EN Socket set
- PL Komplet nasadek z akcesoriami
- DE Sechskantenschlüssel-Einsatz
- RU Набор торцевых головок
- CZ Sada nástrčných klíčů a ráčny
- RO Trusă de scule
- HU Dugókulcs készlet racsnis hajtókarral
- ES Juego de boquillas con accesorios



1/2" (12.7 mm): 8, 9, 10, 11, 12, 13, 14, 15, 16, 17, 18, 19, 20, 21, 22, 23, 24, 27, 30 mm; 1/2" (12.7 mm) x 125 mm; 1/2" (12.7 mm) x 250 mm; 1/2" (12.7 mm) x 240 mm; 1/2" (12.7 mm)

No.	Ø	pcs / szt.	Box
58240	1/2" (12.7 mm)	24	5

- EN Ratchet handle with socket set
- PL Komplet nasadek z grzechotką
- DE Sechskant-Steckschlüssel-Satz
- RU Трещотка с насадками
- CZ Sada nástrčných klíčů a ráčny
- RO Trusă de scule
- HU Dugókulcs készlet racsnis hajtókarral
- ES Matraca con boquillas

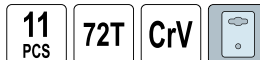

No.	Socket size / Rozmiar nasadki [mm]	L [mm]	Ø	Box
58600	5, 6, 7, 8, 9, 10, 11, 12, 13, 14	150	1/4" (6.3 mm)	6/24
58602	10, 11, 12, 13, 14, 15, 17, 19, 22, 24	260	1/2" (12.7 mm)	12

EN Socket set  
 PL Komplet nasadek z akcesoriami  
 DE Sechskantenschlüssel-Einsatz  
 RU Набор торцевых головок  
 CZ Sada nástrčných klíčů a ráčny  
 RO Trusă de scule  
 HU Dugókulcs készlet racsnis hajtókkal  
 ES Juego de boquillas con accesorios

**12** PCS **1/2"** 12.7mm **45T** AS-DRIVE



1/2" (12.7 mm): 10, 11, 12, 13, 14, 15, 17, 19, 21, 24 mm;  
 1/2" (12.7 mm);  
 1/2" (12.7 mm); 45T

No.	Ø	pcs / szt.	☐
58633	1/2" (12.7 mm)	12	5/10

EN Socket set  
 PL Komplet nasadek z akcesoriami  
 DE Sechskantenschlüssel-Einsatz  
 RU Набор торцевых головок

CZ Sada nástrčných klíčů a ráčny  
 RO Trusă de scule  
 HU Dugókulcs készlet racsnis hajtókkal  
 ES Juego de boquillas con accesorios

**14** PCS **3/4"** 19mm



3/4" (19.0 mm): 22, 24, 27, 30, 32, 36, 38, 41, 46, 50 mm;  
 3/4" (19.0 mm) x 100; 200 mm;  
 3/4" (19.0 mm) x 456 mm; 3/4" (19.0 mm) x 495 mm

No.	Ø	pcs / szt.	☐
58140	3/4" (19.0 mm)	14	2

EN Tool set  
 PL Zestaw narzędziowy  
 DE Werkzeug-Satz  
 RU Набор инструмента

CZ Sada nářadí  
 RO Trusă de scule  
 HU Szerszámkészlet  
 ES Juego de herramientas

**38** PCS **1/4"** 6.3mm

**45T** AS-DRIVE



1/4" (6.3 mm): 3.5, 4, 4.5, 5, 5.5, 6, 7, 8, 9, 10, 11, 12, 13, 14 mm;  
 1/4" (6.3 mm); 1/4" (6.3 mm); 1/4" (6.3 mm);  
 1/4" (6.3 mm); 1/4" (6.3 mm); 45T; 1/4" (6.3 mm); 1/4" (6.3 mm);  
 1/4" (6.3 mm); 4, 5.5, 6.5 mm; 1/4" (6.3 mm); PH1, PH2; 1/4" (6.3 mm); PZ1, PZ2;  
 1/4" (6.3 mm): T10, T15, T20, T25, T30, T40; 1/4" (6.3 mm): 3, 4, 5, 6, 8 mm

No.	Ø	pcs / szt.	☐
58640	1/4" (6.3 mm)	38	10

EN Ratchet handle with socket set  
 PL Komplet nasadek z grzechotką  
 DE Sechskant-Steckschlüssel-Satz  
 RU Трещотка с насадками  
 CZ Sada nástrčných klíčů a ráčny  
 RO Trusă de scule  
 HU Dugókulcs készlet racsnis hajtókkal  
 ES Matraca con boquillas

**19** PCS **1/2"** 12.7mm **45T**

AS-DRIVE



1/2" (12.7 mm): 8, 9, 10, 11, 12, 13, 14, 15, 16, 17, 19, 21, 22, 23, 24, 27, 30, 32 mm;  
 1/2" (12.7 mm); 45T

No.	Ø	pcs / szt.	☐
58634	1/2" (12.7 mm)	19	4/8

EN Socket set  
 PL Komplet nasadek z akcesoriami  
 DE Sechskantenschlüssel-Einsatz  
 RU Набор торцевых головок

CZ Sada nástrčných klíčů a ráčny  
 RO Trusă de scule  
 HU Dugókulcs készlet racsnis hajtókkal  
 ES Juego de boquillas con accesorios

**20** PCS **3/4"** 19mm



3/4" (19.0 mm): 22, 24, 26, 27, 28, 30, 32, 34, 36, 38, 41, 42, 45, 46, 48, 50 mm;  
 3/4" (19.0 mm) x 100; 200 mm;  
 3/4" (19.0 mm) x 456 mm;  
 3/4" (19.0 mm) x 495 mm

No.	Ø	pcs / szt.	☐
58150	3/4" (19.0 mm)	20	2

EN Tool set  
 PL Zestaw narzędziowy  
 DE Werkzeug-Satz  
 RU Набор инструмента

CZ Sada nářadí  
 RO Trusă de scule  
 HU Szerszámkészlet  
 ES Juego de herramientas

**42** PCS **1/4"** 6.3mm

**45T** AS-DRIVE



1/4" (6.3 mm): 4, 4.5, 5, 5.5, 6, 7, 8, 9, 10, 11, 12, 13, 14 mm; 1/4" (6.3 mm): 8, 9, 10, 11, 12, 13 mm;  
 1/4" (6.3 mm); 2 PCS; 1/4" (6.3 mm); 1/4" (6.3 mm); 1/4" (6.3 mm);  
 1/4" (6.3 mm); 45T; 1/4" (6.3 mm); 1/4" (6.3 mm); 1/4" (6.3 mm) x 1/4" (6.3 mm);  
 1/4" (6.3 mm); 3, 4, 5 mm; 1/4" (6.3 mm): PH0, PH1, PH2; 1/4" (6.3 mm): PZ0, PZ1, PZ2;  
 1/4" (6.3 mm): 6, 7, 8 mm; 1.5, 2, 2.5 mm

No.	Ø	pcs / szt.	☐
58641	1/4" (6.3 mm)	42	10

EN Tool set  
 PL Zestaw narzędziowy  
 DE Werkzeug-Satz  
 RU Набор инструмента

CZ Sada nářadí  
 RO Trusa de scule  
 HU Szerszámkészlet  
 ES Juego de herramientas

**56**  
PCS

**1/4"**  
6.3mm

**CrV**  
50BV30

**45T**

AS-DRIVE



1/4" (6.3 mm): 4, 4.5, 5, 5.5, 6, 7, 8, 9, 10, 11, 12, 13 mm; 1/4" (6.3 mm): E4, E5, E6, E7, E8, E10; CrV 50BV30; 1/4" (6.3 mm): 2 PCS; 1/4" (6.3 mm): 1/4" (6.3 mm); 1/4" (6.3 mm); 1/4" (6.3 mm); 1/4" (6.3 mm); 1/4" (6.3 mm) (F) x 3/8" (9.5 mm) (M); 1/4" (6.3 mm): 4, 5.5, 6.5 mm; 1/4" (6.3 mm): PH1, PH2, PH3; 1/4" (6.3 mm): PZ1, PZ2, PZ3; 1/4" (6.3 mm): T8, T10, T15, T20, T25, T30, T40; 1/4" (6.3 mm): 3, 4, 5, 7, 6, 8 mm

No.	Ø	pcs / szt.	Icon
58643	1/4" (6.3 mm)	56	10

EN Tool set  
 PL Zestaw narzędziowy  
 DE Werkzeug-Satz  
 RU Набор инструмента

CZ Sada nářadí  
 RO Trusa de scule  
 HU Szerszámkészlet  
 ES Juego de herramientas

**94**  
PCS

**1/2"**  
12.7mm

**1/4"**  
6.3mm

**45T**

AS-DRIVE



1/2" (12.7 mm): 10, 11, 12, 13, 14, 15, 16, 17, 18, 19, 20, 21, 22, 23, 24, 27, 30, 32; 1/4" (6.3 mm): 4, 4.5, 5, 5.5, 6, 7, 8, 9, 10, 11, 12, 13, 14 mm; 1/2" (12.7 mm): 14, 15, 17, 19 mm; 1/4" (6.3 mm): 6, 7, 8, 9, 10, 11, 12, 13 mm; 1/2" (12.7 mm); 2 PCS; 1/4" (6.3 mm); 2 PCS; 3/8" (9.5 mm) (F) x 1/2" (12.7 mm) (M); 1/4" (6.3 mm); 1/2" (12.7 mm); 1/4" (6.3 mm); 1/2" (12.7 mm): 16, 21 mm; 1/4" (6.3 mm); 1/2" (12.7 mm); 1/4" (6.3 mm); 45T; 1/4" (6.3 mm); 1/4" (6.3 mm); 1/2" (12.7 mm) x 5/16" (7.9 mm); 1/4" (6.3 mm) x 1/4" (6.3 mm); 1/2" (12.7 mm); 8, 10, 12 mm; 5/16" (7.9 mm): PH3, PH4; 5/16" (7.9 mm): PZ3, PZ4; 5/16" (7.9 mm): T40, T45, T50, T55; 5/16" (7.9 mm): 8, 10, 12, 14 mm; 1/4" (6.3 mm): 4, 5.5, 7 mm; 1/4" (6.3 mm): PH1, PH2; 1/4" (6.3 mm): PZ1, PZ2; 1/4" (6.3 mm): T8, T10, T15, T20, T25, T30; 1/4" (6.3 mm): 3, 4, 5, 6 mm; 1.5, 2, 2.5 mm

No.	Ø	pcs / szt.	Icon
58687	1/4" (6.3 mm), 1/2" (12.7 mm)	94	3

EN Tool set  
 PL Zestaw narzędziowy  
 DE Werkzeug-Satz  
 RU Набор инструмента

**22**  
PCS

**3/8"**  
9.5mm

**45T**

AS-DRIVE



3/8" (9.5 mm): 6, 7, 8, 9, 10, 11, 12, 13, 14, 15, 16, 17, 18, 19, 20, 21, 22 mm; 3/8" (9.5 mm); 3/8" (9.5 mm); 3/8" (9.5 mm); 45T

No.	Ø	pcs / szt.	Icon
58661	3/8" (9.5 mm)	22	10

EN Tool set  
 PL Zestaw narzędziowy  
 DE Werkzeug-Satz  
 RU Набор инструмента

CZ Sada nářadí  
 RO Trusa de scule  
 HU Szerszámkészlet  
 ES Juego de herramientas

**108**  
PCS

**1/2"**  
12.7mm

**1/4"**  
6.3mm

**CrV**  
50BV30

**45T**

AS-DRIVE



1/2" (12.7 mm): 10, 11, 12, 13, 14, 15, 16, 17, 18, 19, 20, 21, 22, 24, 27, 30, 32 mm; 1/4" (6.3 mm): 4, 4.5, 5, 5.5, 6, 7, 8, 9, 10, 11, 12, 13, 14 mm; 1/2" (12.7 mm): 14, 15, 17, 19, 22 mm; 1/4" (6.3 mm): 6, 7, 8, 9, 10, 11, 12, 13 mm; 1/2" (12.7 mm): E10, E11, E12, E14, E16, E18, E20, E24; 1/4" (6.3 mm): E4, E5, E6, E7, E8; CrV 50BV30; 1/2" (12.7 mm); 2 PCS; 1/4" (6.3 mm); 2 PCS; 3/8" (9.5 mm) (F) x 1/2" (12.7 mm) (M); 1/2" (12.7 mm); 1/4" (6.3 mm); 1/2" (12.7 mm); 1/4" (6.3 mm); 1/2" (12.7 mm): 16, 21 mm; 1/4" (6.3 mm); 1/2" (12.7 mm); 45T; 1/4" (6.3 mm); 1/2" (12.7 mm) (F) x 5/16" (7.9 mm) (F); 5/16" (7.9 mm): 8, 10, 12 mm; 5/16" (7.9 mm): PH3, PH4; 5/16" (7.9 mm): PZ3, PZ4; 5/16" (7.9 mm): T40, T45, T50, T55, T60; 5/16" (7.9 mm): 7, 8, 10, 12, 14 mm; 1/4" (6.3 mm): 4, 5.5, 6.5 mm; 1/4" (6.3 mm): PH1, PH2; 1/4" (6.3 mm): PZ1, PZ2; 1/4" (6.3 mm): T8, T10, T15, T20, T25, T27, T30; 1/4" (6.3 mm): 3, 4, 5, 6 mm; 1.5, 2, 2.5 mm

No.	Ø	pcs / szt.	Icon
58685	1/4" (6.3 mm), 1/2" (12.7 mm)	108	3



EN Tool set  
 PL Zestaw narzędziowy  
 DE Werkzeug-Satz  
 RU Набор инструмента

CZ Sada nářadí  
 RO Trusa de scule  
 HU Szerszámkészlet  
 ES Juego de herramientas

122 PCS 1/2" 12.7mm 1/4" 6.3mm CrV 50BV30

CrV 6150 45T AS-DRIVE

2



1/2" (12.7 mm): 12, 13, 14, 15, 16, 17, 18, 19, 20, 21, 22, 24, 27, 30, 32 mm; 1/4" (6.3 mm): 4, 4.5, 5, 5.5, 6, 7, 8, 9, 10, 11, 12, 13, 14 mm; 1/2" (12.7 mm): 10, 12, 13, 14, 17, 19 mm; 1/4" (6.3 mm): 4, 5, 6, 7, 8, 9 mm; 1/2" (12.7 mm): E10, E12, E14, E16, E18, E20, E22, E24; CrV 50BV30; 1/2" (12.7 mm), 1/4" (6.3 mm); 3/8" (9.5 mm) (F) x 1/2" (12.7 mm) (M); 3/8" (9.5 mm) (F) x 1/4" (6.3 mm) (M); 1/2" (12.7 mm), 1/4" (6.3 mm); 1/2" (12.7 mm): 16, 21 mm; 1/4" (6.3 mm); 1/4" (6.3 mm); 1/4" (6.3 mm) x 1/4" (6.3 mm); 1/4" (6.3 mm); 1/4" (6.3 mm); 3, 4, 5, 6 mm; 1/4" (6.3 mm); PH0, PH1, PH2; 1/4" (6.3 mm); PZ0, PZ1, PZ2; 1/4" (6.3 mm): 4.0, 5.5, 6.5 mm; 1/4" (6.3 mm); PH1, PH2, PH3; 1/4" (6.3 mm); PZ2, PZ3; 1/4" (6.3 mm): T8, T10, T15, T20, T25; 1/4" (6.3 mm): T10, T15, T20, T25, T40; 1/4" (6.3 mm): 3, 4, 5, 6 mm; 8, 9, 10, 11, 12, 13, 14, 15, 16, 17, 18, 19 mm; 4x100, 6.5x150, PH2x100, PH3x150 mm; CrV 6150; 160 mm; 160 mm; 180 mm; 250 mm; 300 g; 2, 2.5, 3, 4, 5, 6, 7, 8, 10 mm



No.	⊙	pcs / szt.	📦
58690	1/4" (6.3 mm), 1/2" (12.7 mm)	122	2

EN Tool set  
 PL Zestaw narzędziowy  
 DE Werkzeug-Satz  
 RU Набор инструмента

CZ Sada nářadí  
 RO Trusa de scule  
 HU Szerszámkészlet  
 ES Juego de herramientas

173 PCS 1/2" 12.7mm 3/8" 9.5mm 1/4" 6.3mm

CrV 50BV30 45T AS-DRIVE



1/2" (12.7 mm): 10, 11, 12, 13, 14, 15, 16, 17, 18, 19, 20, 21, 22, 23, 24, 27, 30, 32 mm; 3/8" (9.5 mm): 10, 11, 12, 13, 14, 15, 16, 17, 18, 19 mm; 1/4" (6.3 mm): 4, 4.5, 5, 5.5, 6, 7, 8, 9, 10, 11, 12, 13, 14 mm; 1/2" (12.7 mm): 16, 17, 18, 19, 22 mm; 3/8" (9.5 mm): 10, 11, 12, 13, 14, 15 mm; 1/4" (6.3 mm): 4, 5, 6, 7, 8, 9, 10 mm; 1/2" (12.7 mm): E18, E20, E24; 3/8" (9.5 mm): E10, E11, E12, E14, E16; 1/4" (6.3 mm): E4, E5, E6, E7, E8; CrV 50BV30; 1/2" (12.7 mm; 2 PCS), 3/8" (9.5 mm), 1/4" (6.3 mm; 2 PCS); 3/8" (9.5 mm) (F) x 1/2" (12.7 mm) (M); 1/2" (12.7 mm), 3/8" (9.5 mm), 1/4" (6.3 mm); 1/2" (12.7 mm): 16, 21 mm; 3/8" (9.5 mm): 18 mm; 1/4" (6.3 mm); 1/2" (12.7 mm), 3/8" (9.5 mm), 1/4" (6.3 mm); 45T; 1/4" (6.3 mm); 1/2" (12.7 mm) x 5/16" (7.9 mm), 3/8" (9.5 mm) x 5/16" (7.9 mm); 1/4" (6.3 mm) x 1/4" (6.3 mm); 5/16" (7.9 mm); 8, 10, 12 mm; 5/16" (7.9 mm); PH3, PH4; 5/16" (7.9 mm); PZ3, PZ4; 5/16" (7.9 mm): T40, T45, T50, T55, T60, T70; 5/16" (7.9 mm): T40, T45, T50, T55, T60, T70; 5/16" (7.9 mm): 7, 8, 10, 12, 14 mm; 1/4" (6.3 mm): T5, T6, T7; 1/4" (6.3 mm): T7, T10, T15, T20, T25, T27, T30, T40, T45; 1/4" (6.3 mm): M5, M6, M8; 1/4" (6.3 mm): RM5, RM6, RM7, RM8, RM9; 1/4" (6.3 mm): 4, 5.5, 6.5, 7 mm; 1/4" (6.3 mm): PH0, PH1, PH2; 1/4" (6.3 mm): PZ0, PZ1, PZ2; 1/4" (6.3 mm): T8, T9, T10, T15, T20, T25, T27, T30; 1/4" (6.3 mm): T8, T9, T10, T15, T20, T25, T27, T30; 1/4" (6.3 mm): 3, 4, 5, 6 mm; 1.25, 1.5, 2, 2.5, 3, 4, 5 mm



No.	⊙	pcs / szt.	📦
58688	1/4" (6.3 mm), 3/8" (9.5 mm), 1/2" (12.7 mm)	173	1

EN Tool set  
 PL Zestaw narzędziowy  
 DE Werkzeug-Satz  
 RU Набор инструмента

CZ Sada nařadí  
 RO Trusa de scule  
 HU Szerszámkészlet  
 ES Juego de herramientas

2



No.	Ø	pcs / szt.	
58700	1/4" (6.3 mm), 3/8" (9.5 mm), 1/2" (12.7 mm)	216	1

EN Tool set  
 PL Zestaw narzędziowy  
 DE Werkzeug-Satz  
 RU Набор инструмента

CZ Sada nařadí  
 RO Trusa de scule  
 HU Szerszámkészlet  
 ES Juego de herramientas

216 PCS 1/2" 12.7mm 3/8" 9.5mm 1/4" 6.3mm CrV 50BV30 45T AS-DRIVE



No.	Ø	pcs / szt.	
58691	1/4" (6.3 mm), 3/8" (9.5 mm), 1/2" (12.7 mm)	216	1

1/2" (12.7 mm): 10, 11, 12, 13, 14, 15, 17, 19, 20, 21, 22, 24, 27, 30, 32 mm; 3/8" (9.5 mm): 10, 11, 12, 13, 14, 15, 16, 17, 18, 19 mm; 1/4" (6.3 mm): 4, 4.5, 5, 5.5, 6, 7, 8, 9, 10, 11, 12, 13, 14 mm; 1/2" (12.7 mm): 16, 17, 18, 19, 22 mm; 3/8" (9.5 mm): 10, 11, 12, 13, 14, 15 mm; 1/4" (6.3 mm): 4, 5, 6, 7, 8, 9, 10 mm; 1/2" (12.7 mm): E20, E22, E24; 3/8" (9.5 mm): E10, E11, E12, E14, E16, E18; 1/4" (6.3 mm): E4, E5, E6, E7, E8; CrV 50BV30; 1/2" (12.7 mm): 2 PCS; 3/8" (9.5 mm): 1/4" (6.3 mm): 2 PCS; 1/2" (12.7 mm), 3/8" (9.5 mm), 1/4" (6.3 mm); 1/2" (12.7 mm): 16, 21 mm; 3/8" (9.5 mm): 18 mm; 1/2" (12.7 mm), 1/4" (6.3 mm); 1/2" (12.7 mm), 3/8" (9.5 mm), 1/4" (6.3 mm); 45T; 1/4" (6.3 mm); 1/4" (6.3 mm); 1/2" (12.7 mm) x 5/16" (7.9 mm), 3/8" (9.5 mm) x 5/16" (7.9 mm), 1/4" (6.3 mm) x 1/4" (6.3 mm); 5/16" (7.9 mm): 6, 6.5, 8 mm; 1/4" (6.3 mm): 4, 5.5, 6.5 mm; CrV 6140; 5/16" (7.9 mm): PH3, PH4; 1/4" (6.3 mm): PH1, PH2; CrV 6140; 5/16" (7.9 mm): PZ3, PZ4; 1/4" (6.3 mm): PZ1, PZ2; CrV 6140; 5/16" (7.9 mm): T25, T27, T30, T35, 2xT40, T45, T50; 1/4" (6.3 mm): T8, T10, T15, T20, T25; CrV 6140; 5/16" (7.9 mm): T27, T30, T35, T40, T45, T50; 1/4" (6.3 mm): T8, 2xT10, 2xT15, 2xT20, 2xT25, T40; CrV 6140; 5/16" (7.9 mm): 5.5, 6, 6.5, 7, 8 mm; 1/4" (6.3 mm): 3, 4, 5, 6 mm; CrV 6140; 1/4" (6.3 mm): 3, 4, 5, 6 mm; CrV 6140; 5/16" (7.9 mm): M5, M6, M8, M10; 1/4" (6.3 mm): M5, M6, M8; CrV 6140; 1/4" (6.3 mm): S1, S2; CrV 6140; 1/4" (6.3 mm): 1, 2, 3 mm; CrV 6140; 1/4" (6.3 mm): 6, 8, 10 mm; CrV 6140; 1/4" (6.3 mm): 4, 6, 8 mm; CrV 6140; 1/4" (6.3 mm): 6, 6.5, 8 mm; CrV 6140; 1/4" (6.3 mm): PH3, PH4; CrV 6140; 1/4" (6.3 mm): PZ3, PZ4; CrV 6140; 1/2" (12.7 mm): T55, T60; 1/4" (6.3 mm): T25, T27, T30, T35, T40 (2 PCS), T45, T50; CrV 6140; 1/4" (6.3 mm): T27, T30, T35, T40, T45, T50; CrV 6140; 1/4" (6.3 mm): 5.5, 6, 6.5, 7, 8 mm; CrV 6140; 1/4" (6.3 mm): M5, M6, M8, M10; CrV 6140; 8, 10, 11, 12, 13, 14, 15, 16, 17, 18, 19, 22 mm; 1.27, 1.5, 2, 2.5, 3, 4, 5 mm

1/2" (12.7 mm): 10, 11, 12, 13, 14, 15, 17, 19, 20, 21, 22, 24, 27, 30, 32 mm; 3/8" (9.5 mm): 10, 11, 12, 13, 14, 15, 16, 17, 18, 19 mm; 1/4" (6.3 mm): 4, 4.5, 5, 5.5, 6, 7, 8, 9, 10, 11, 12, 13, 14 mm; 1/2" (12.7 mm): 16, 17, 18, 19, 22 mm; 3/8" (9.5 mm): 10, 11, 12, 13, 14, 15 mm; 1/4" (6.3 mm): 4, 5, 6, 7, 8, 9, 10 mm; 1/2" (12.7 mm): E20, E22, E24; 3/8" (9.5 mm): E10, E11, E12, E14, E16, E18; 1/4" (6.3 mm): E4, E5, E6, E7, E8; CrV 50BV30; 1/2" (12.7 mm): 2 PCS; 3/8" (9.5 mm): 1/4" (6.3 mm): 2 PCS; 1/2" (12.7 mm), 3/8" (9.5 mm), 1/4" (6.3 mm); 1/2" (12.7 mm): 16, 21 mm; 3/8" (9.5 mm): 18 mm; 1/2" (12.7 mm), 1/4" (6.3 mm); 1/2" (12.7 mm), 3/8" (9.5 mm), 1/4" (6.3 mm); 45T; 1/4" (6.3 mm); 1/4" (6.3 mm); 1/2" (12.7 mm) x 5/16" (7.9 mm), 3/8" (9.5 mm) x 5/16" (7.9 mm), 1/4" (6.3 mm) x 1/4" (6.3 mm); 5/16" (7.9 mm): 6, 6.5, 8 mm; 1/4" (6.3 mm): 4, 5.5, 6.5 mm; 5/16" (7.9 mm): PH3, PH4; 1/4" (6.3 mm): PH1, PH2; 5/16" (7.9 mm): PZ3, PZ4; 1/4" (6.3 mm): PZ1, PZ2; 5/16" (7.9 mm): T25, T27, T30, T35, T40 (2 PCS), T45, T50; 1/4" (6.3 mm): T8, T10, T15, T20, T25; 5/16" (7.9 mm): T27, T30, T35, T40, T45, T50; 1/4" (6.3 mm): T8, 2xT10, 2xT15, 2xT20, 2xT25, T40; 5/16" (7.9 mm): 5.5, 6, 6.5, 7, 8 mm; 1/4" (6.3 mm): 3, 4, 5, 6 mm; 1/4" (6.3 mm): 3, 4, 5, 6 mm; CrV 6140; 5/16" (7.9 mm): M5, M6, M8, M10; 1/4" (6.3 mm): M5, M6, M8; CrV 6140; 1/4" (6.3 mm): S1, S2; CrV 6140; 1/4" (6.3 mm): 1, 2, 3 mm; 1/4" (6.3 mm): 6, 8, 10 mm; 1/4" (6.3 mm): 4, 6, 8 mm; 1/4" (6.3 mm): 6, 6.5, 8 mm; CrV 6140; 1/4" (6.3 mm): PH3, PH4; CrV 6140; 1/4" (6.3 mm): PZ3, PZ4; 1/2" (12.7 mm): T55, T60; 1/4" (6.3 mm): T25, T27, T30, T35, 2xT40, T45, T50; CrV 6140; 1/4" (6.3 mm): T27, T30, T35, T40, T45, T50; CrV 6140; 1/4" (6.3 mm): 5.5, 6, 6.5, 7, 8 mm; CrV 6140; 8, 10, 11, 12, 13, 14, 15, 16, 17, 18, 19, 22 mm; 1.27, 1.5, 2, 2.5, 3, 4, 5 mm



EN Tool set  
 PL Zestaw narzędziowy  
 DE Werkzeug-Satz  
 RU Набор инструмента

CZ Sada nářadí  
 RO Trusa de scule  
 HU Szerszámkészlet  
 ES Juego de herramientas

225 PCS   1/2" 12.7mm   3/8" 9.5mm   1/4" 6.3mm   CrV 6140   45T   AS-DRIVE   METRIC SAE  

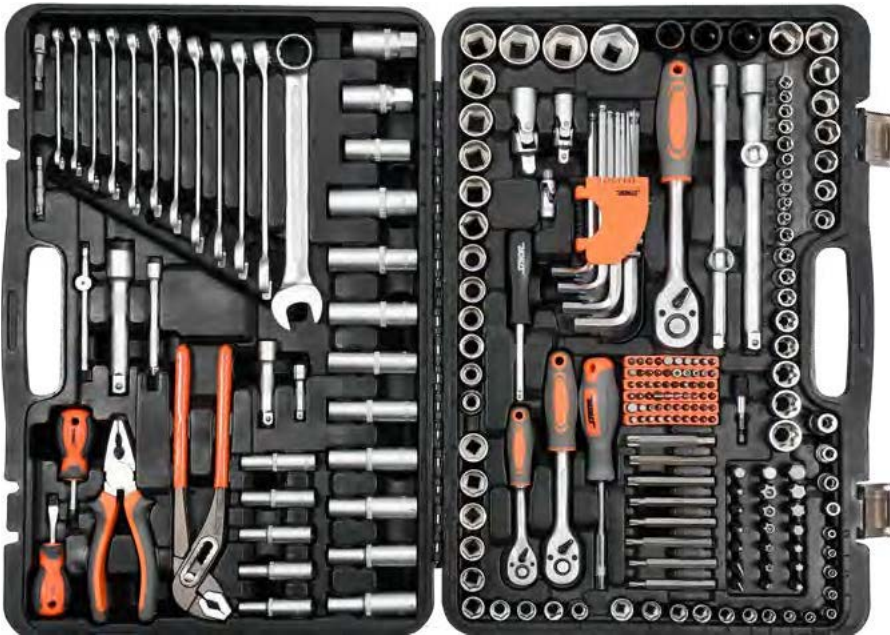

1/2" (12.7 mm): 10, 13, 15, 16, 17, 18, 19, 20, 21, 22, 23, 24, 27, 30, 32 mm; 3/8" (9.5 mm): 10, 11, 12, 13, 14, 15, 16, 17, 18, 19 mm; 1/4" (6.3 mm): 3.5, 4, 4.5, 5, 5.5, 6, 7, 8, 9, 10, 11, 12, 13, 14 mm; 1/2" (12.7 mm): 10, 11, 12, 13, 14, 15, 17, 19, 21 mm; 3/8" (9.5 mm): 6, 7, 8, 9, 10 mm; 1/2" (12.7 mm): 7/16" (11.1 mm), 1/2" (12.7 mm), 9/16" (14.3 mm), 5/8" (15.9 mm), 11/16" (17.5 mm), 3/4" (19.0 mm), 13/16" (20.6 mm), 7/8" (22.2 mm); 1/4" (6.3 mm): 1/4" (6.3 mm), 9/32" (7.1 mm), 5/16" (7.9 mm), 11/32" (8.7 mm), 3/8" (9.5 mm); 1/2" (12.7 mm): 17, 19, 21 mm; 1/2" (12.7 mm): E16, E18, E20, E22, E24; 3/8" (9.5 mm): E10, E11, E12, E14; 1/4" (6.3 mm): E4, E5, E6, E7, E8; 1/2" (12.7 mm): 2 PCS); 3/8" (9.5 mm): 2 PCS); 1/4" (6.3 mm): 2 PCS); 3/8" (9.5 mm) (F) x 1/2" (12.7 mm) (M), 1/2" (12.7 mm) (F) x 3/8" (9.5 mm) (M); 1/2" (12.7 mm), 3/8" (9.5 mm), 1/4" (6.3 mm); 1/2" (12.7 mm): 16, 21 mm; 3/8" (9.5 mm): 18 mm; 1/4" (6.3 mm); 1/2" (12.7 mm), 3/8" (9.5 mm), 1/4" (6.3 mm); 45T; 1/4" (6.3 mm); 1/4" (6.3 mm); 1/2" (12.7 mm) x 5/16" (7.9 mm), 3/8" (9.5 mm) x 5/16" (7.9 mm), 3/8" (9.5 mm) x 1/4" (6.3 mm), 1/4" (6.3 mm) x 1/4" (6.3 mm); 3/8" (9.5 mm) x 1/4" (6.3 mm), 1/4" (6.3 mm) x 1/4" (6.3 mm) (2 PCS); 1/4" (6.3 mm) x 1/4" (6.3 mm); 5/16" (7.9 mm): 8, 10 mm; 1/4" (6.3 mm): 3, 4, 5.5, 6.5, 7, 8, 9 mm; CrV 6140; 5/16" (7.9 mm): PH3, PH4; 1/4" (6.3 mm): PH0, PH1, PH2, PH3; CrV 6140; 5/16" (7.9 mm): PZ3, PZ4; 1/4" (6.3 mm): PZ0, PZ1, PZ2, PZ3; CrV 6140; 5/16" (7.9 mm): T20, T25, T27, T30, T40, T45, T50, T55 (L=75 mm); T40, T45, T50, T55, T60, T70 (L=30 mm); 1/4" (6.3 mm): T8, T9, T10, T15, T20, T25, T27, T30; 5/16" (7.9 mm): T40, T45, T50, T55, T60, T70; 1/4" (6.3 mm): T8, T9, T10, T15, T20, T25, T27, T30; 5/16" (7.9 mm): 10, 12, 14 mm; 1/4" (6.3 mm): 3, 4, 5, 6, 7, 8 mm; CrV 6140; 1/4" (6.3 mm): 4, 5, 6, 7, 8 mm; CrV 6140; 1/4" (6.3 mm): M5, M6, M8, M10; CrV 6140; 1/4" (6.3 mm): S1, S2; CrV 6140; 1/4" (6.3 mm): 1, 2, 3, 4; CrV 6140; 1/4" (6.3 mm): 6, 8, 10; CrV 6140; 1/4" (6.3 mm): 4, 6, 8, 10 mm; CrV 6140; 8, 9, 10, 11, 12, 13, 14, 15, 16, 17, 19, 22 mm; 6x38, PH2x38; 180 mm; 250 mm; 2, 2.5, 3, 4, 5, 6, 7, 8, 10, 12 mm

**STATOR**

No.	⊙	pcs / szt.	
58693	1/4" (6.3 mm), 3/8" (9.5 mm), 1/2" (12.7 mm)	225	1





Memo

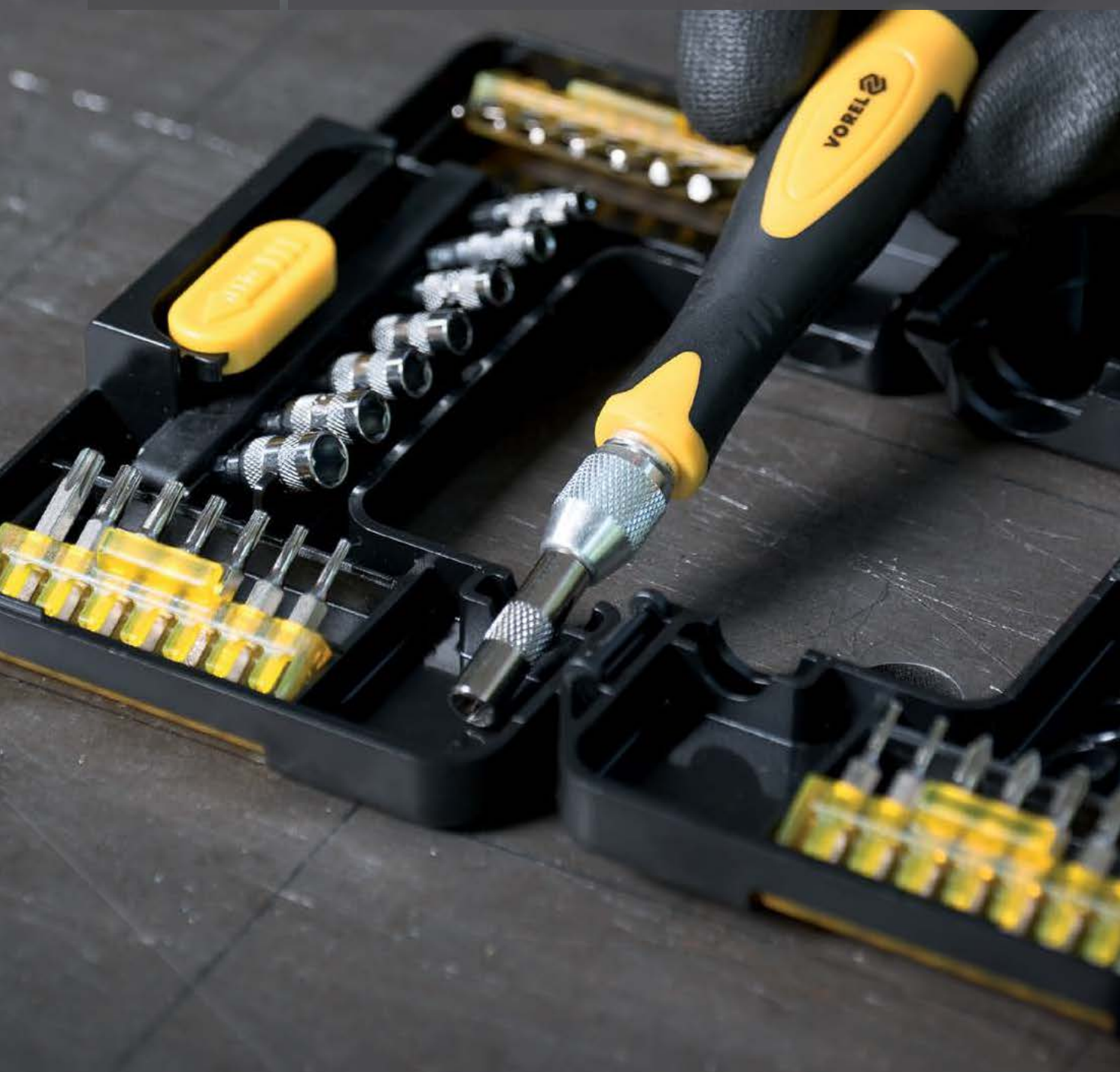

# 3

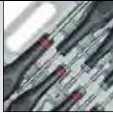
## Screwdrivers & screwdriver bits Wkrętaki i końcówki wkrętakowe

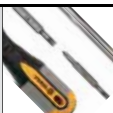

<b>Screwdrivers, 3 colour handle</b> Wkrętaki, trójkolorowa rączka		26-28	<b>Screwdriver sets</b> Zestawy wkrętaków		32-33
<b>Slotted screwdrivers</b> Wkrętaki płaskie		26	<b>Precision screwdrivers sets</b> Zestawy wkrętaków precyzyjnych		34-35
<b>Phillips screwdrivers</b> Wkrętaki krzyżakowe		26	<b>Screwdriver bits</b> Kończówki wkrętakowe		35-38
<b>Pozidrive screwdrivers</b> Wkrętaki „Pozidrive”		26	<b>Screwdriver bit sets</b> Zestawy końcówek wkrętakowych		35
<b>Torx screwdrivers</b> Wkrętaki „Torx”		26	<b>Screwdriver bit holders</b> Uchwyty do końcówek wkrętakowych		38
<b>Screwdriver sets</b> Komplety wkrętaków		26	<b>Nut setter sets</b> Zestawy nasadek magnetycznych do wkrętarek		38
<b>Ratchet screwdrivers</b> Wkrętaki z grzechotką		28	<b>Hex &amp; Torx keys &amp; sets</b> Klucze imbusowe i zestawy		39-41
<b>Screwdrivers HI-TEC &amp; sets</b> Wkrętaki HI-TEC i zestawy		28-29	<b>T-handle keys &amp; sets</b> Klucze imbusowe typu „T” i zestawy		39
<b>Slotted screwdrivers</b> Wkrętaki płaskie		28	<b>Hex keys</b> Klucze imbusowe „Hex”		40
<b>Phillips screwdrivers</b> Wkrętaki krzyżakowe		29	<b>Hex key sets</b> Zestawy kluczy imbusowych „Hex”		40
<b>Screwdriver sets</b> Komplety wkrętaków		29	<b>Torx &amp; Torx Tamperproof key sets</b> Zestawy kluczy imbusowych „Torx” i „Torx Tamperproof”		41
<b>Special &amp; impact screwdrivers</b> Wkrętaki specjalne i udarowe		29-32			
<b>Two way screwdrivers</b> Wkrętaki dwustronne		29			
<b>Ratchet screwdriver sets with bits</b> Zestawy wkrętaków z grzechotką i bitami		30			
<b>Impact screwdrivers</b> Wkrętaki udarowe		31			
<b>Telescopic screwdrivers</b> Wkrętaki teleskopowe		32			
<b>T-bar screwdrivers</b> Wkrętaki T-gryf		32			

EN Screwdriver  
 PL Wkrętkak  
 DE Schraubendreher  
 RU Отвёртка  
 CZ Šroubovák  
 RO Şurubelniţă  
 HU Csavarhúzó  
 ES Destornillador



3 VOREL

No.	⊖ [mm]	L [mm]	PCS ROBIE	
60912	2	75	12	96/384
60950	3	75	12	96/384
60951	3	100	12	96/384
60952	4	100	12	96/384
60913	4	150	12	96/384
60914	4	200	12	60/240
60915	5	38	12	60/240
60953	5	75	12	60/240
60954	5	100	12	60/240
60955	5	150	12	60/240
60916	5	200	12	36/144
60917	6	38	12	60/240
60956	6	100	12	36/144
60957	6	150	12	36/144
60958	6	200	12	36/144
60959	8	150	6	24/96
60918	8	250	6	24/96

EN Screwdriver  
 PL Wkrętkak  
 DE Schraubendreher  
 RU Отвёртка  
 CZ Šroubovák  
 RO Şurubelniţă  
 HU Csavarhúzó  
 ES Destornillador



VOREL

No.	⊕	L [mm]	PCS ROBIE	
60931	PZ0	75	12	96/384
60932	PZ0	100	12	96/384
60933	PZ1	75	12	60/240
60934	PZ1	100	12	60/240
60935	PZ1	200	12	36/144
60936	PZ2	100	12	36/144
60937	PZ2	150	12	36/144
60938	PZ2	200	12	36/144
60939	PZ3	150	8	24/96

EN Screwdriver set  
 PL Komplet wkręteków  
 DE Schraubendrehersatz  
 RU Набор отвёрток  
 CZ Zámečnické šroubováky  
 RO Şurubelnițe de lăcătușerie  
 HU Lakatos csavarhúzó  
 ES Juego de destornilladores



VOREL

No.	pcs / szt.	
60970	10	6/24

EN Screwdriver  
 PL Wkrętkak  
 DE Schraubendreher  
 RU Отвёртка  
 CZ Šroubovák  
 RO Şurubelniţă  
 HU Csavarhúzó  
 ES Destornillador

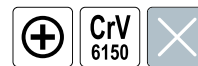

VOREL

No.	⊕	L [mm]	PCS ROBIE	
60920	PH00	65	12	96/384
60961	PH0	75	12	96/384
60962	PH0	100	12	96/384
60921	PH1	38	12	60/240
60963	PH1	75	12	60/240
60964	PH1	100	12	60/240
60965	PH1	150	12	60/240
60922	PH1	250	12	36/144
60923	PH2	38	12	60/240
60966	PH2	100	12	36/144
60967	PH2	150	12	36/144
60968	PH2	200	12	36/144
60924	PH2	250	12	36/144
60969	PH3	150	6	24/96

EN Screwdriver  
 PL Wkrętkak  
 DE Schraubendreher  
 RU Отвёртка  
 CZ Šroubovák  
 RO Şurubelniţă  
 HU Csavarhúzó  
 ES Destornillador



VOREL

No.	⊕	L [mm]	PCS ROBIE	
60880	T5	75	12	96/384
60881	T6	75	12	96/384
60882	T7	75	12	96/384
60883	T8	75	12	96/384
60885	T10	100	12	60/240
60886	T15	100	12	60/240
60887	T20	100	12	60/240
60888	T25	100	12	36/144
60889	T27	100	12	36/144
60890	T30	100	12	36/144
60891	T40	100	6	24/96



⊖ 3x75, 5x100, 6x100, 6x150, 8x150 mm; CrV 6150;  
 ⊕ PH0x75, PH1x75, PH2x100, PH2x150, PH3x150 mm; CrV 6150



EN Screwdriver set  
 PL Komplet długich wkrętaków  
 DE Schraubendrehersatz  
 RU Набор отверток

CZ Zámečnické šroubováky  
 RO Șurubelnițe de lăcătușerie  
 HU Lakatos csavarhőző  
 ES Juego de destornilladores

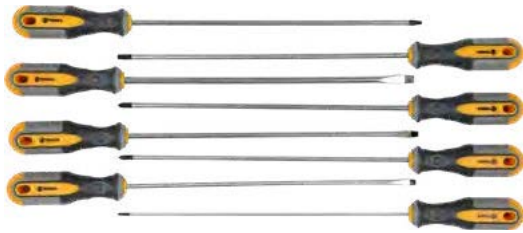
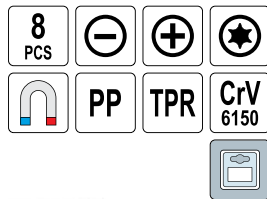

⊖ 5.5, 6.5, 8.0 mm (L=325 mm); CrV 6150;  
 ⊕ PH0, PH1, PH2 (L=325 mm); CrV 6150;  
 ⊗ T25, T30 (L=325 mm); CrV 6150



No.	pcs / szt.	
60990	8	10

EN Screwdriver set  
 PL Komplet wkrętaków  
 DE Schraubendrehersatz  
 RU Набор отвёрток  
 CZ Zámečnické šroubováky  
 RO Șurubelnițe de lăcătușerie  
 HU Lakatos csavarhőző  
 ES Juego de destornilladores

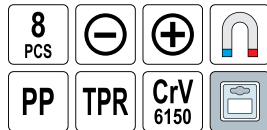

⊖ 3.0x75, 5.5x75, 6.5x38, 6.5x100 mm; CrV 6150;  
 ⊕ PH0x75, PH1x75, PH2x38, PH2x100 mm; CrV 6150



No.	pcs / szt.	
60782	8	6/24

EN Screwdriver set  
 PL Komplet wkrętaków  
 DE Schraubendrehersatz  
 RU Набор отвёрток

CZ Zámečnické šroubováky  
 RO Șurubelnițe de lăcătușerie  
 HU Lakatos csavarhőző  
 ES Juego de destornilladores

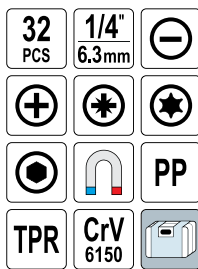

⊖ 4.0x75, 6.5x100, 8.0x150 mm; CrV 6150; ⊕ PH1x75, PH2x100 mm; CrV 6150; ⊗ PZ1x75, PZ2x100 mm; CrV 6150;  
 ⊖ 2.0x50, 2.5x50, 3.0x50 mm; CrV 6150; ⊕ PH00x50, PH0x50, PH1x50 mm; CrV 6150; ⊕ 1/4\"/>



No.	pcs / szt.	
60785	32	10

EN Screwdriver set  
 PL Komplet wkrętaków  
 DE Schraubendrehersatz  
 RU Набор отвёрток  
 CZ Zámečnické šroubováky  
 RO Șurubelnițe de lăcătușerie  
 HU Lakatos csavarhőző  
 ES Juego de destornilladores

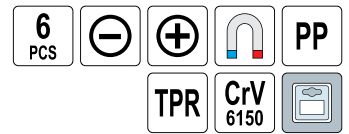

⊖ 5.5x75, 6.5x38, 6.5x100 mm; CrV 6150;  
 ⊕ PH1x75, PH2x38, PH2x100 mm; CrV 6150



No.	pcs / szt.	
60783	6	10/20

EN Screwdriver set  
 PL Komplet wkrętaków  
 DE Schraubendrehersatz  
 RU Набор отвёрток  
 CZ Zámečnické šroubováky  
 RO Șurubelnițe de lăcătușerie  
 HU Lakatos csavarhőző  
 ES Juego de destornilladores

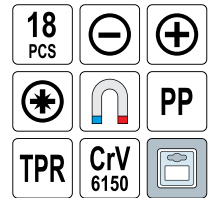

⊖ 5.5x75, 6.5x38, 6.5x100, 8.0x150 mm; CrV 6150; ⊕ PH1x75, PH2x38, PH2x100, PH3x150 mm; CrV 6150;  
 ⊖ 2.5x50, 3.0x50 mm; CrV 6150; ⊕ PH00x50, PH0x50 mm; CrV 6150; ⊗ T5x50, T6x50, T7x50, T8x50, T9x50, T10x50 mm; CrV 6150



No.	pcs / szt.	
60781	18	10

EN Screwdriver set  
 PL Komplet wkrętaków  
 DE Schraubendrehersatz  
 RU Набор отвёрток  
 CZ Zámečnické šroubováky  
 RO Șurubelnițe de lăcătușerie  
 HU Lakatos csavarhőző  
 ES Juego de destornilladores

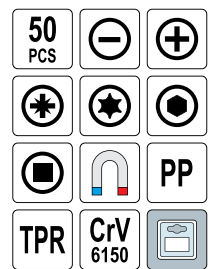

⊖ 4.0x75, 6.5x68, 6.5x100, 8.0x150 mm; CrV 6150; ⊕ PH1x75, PH2x38, PH2x100, PH3x150 mm; CrV 6150;  
 ⊖ 2.0x50, 2.5x50, 3.0x50 mm; CrV 6150; ⊕ PH00x50, PH0x50 mm; CrV 6150; ⊗ T6x50, T8x50, T10x50 mm; CrV 6150; □ 1/4\"/>



No.	pcs / szt.	
60780	50	6

- EN Screwdriver set
- PL Komplet wkrętek
- DE Schraubendrehersatz
- RU Набор отвёрток
- CZ Zámečnické šroubováky
- RO Șurubelnițe de lăcătușerie
- HU Lakatos csavarhúzó
- ES Juego de destornilladores

3



No.	pcs / szt.	
60750	100	3

- EN Ratchet screwdriver set
- PL Zestaw wkrętek z grzechotką
- DE Ralschenschraubendreher-Satz mit Einsätzen
- RU Отвёртка реверсивная с набором бит и торцевых головок
- CZ Ráčnový kloubový šroubovák
- RO Set surubelnița
- HU Dugókulcs és bit készlet csukló
- ES Juego con destornillador y carraca



□ 1/4" (6.3 mm): 5, 6, 7 mm (L=25 mm); ⊕ 1/4" (6.3 mm): PH1, PH1, PH2, PH2, PH3 (L=52 mm) ⊕ 1/4" (6.3 mm): T10, T15, T20, T25, T30 (L=52 mm); ○ 1/4" (6.3 mm): 4, 6 mm (L=52 mm); □ 1/4" (6.3 mm): 5, 6, 7, 8, 9, 10 mm; □ 1/4" (6.3 mm), 5/16" (7.9 mm), 11/32" (8.7 mm), 3/8" (9.5 mm), 7/16" (11.1 mm), 1/2" (12.7 mm); □ 1/4" (6.3 mm)



No.	pcs / szt.	
60975	29	6/24

- EN Screwdriver
- PL Wkrętkak
- DE Schraubendreher
- RU Отвёртка
- CZ Šroubovák
- RO Șurubelniță
- HU Csavarhúzó
- ES Destornillador



No.	⊖ [mm]	L [mm]	
61090	6	38	12/192

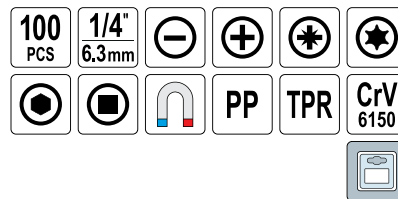

□ 1/4" (6.3 mm): 6, 7, 8, 9, 10, 11 mm (L=35 mm); CrV 6150; ⊖ 3.0x75, 4.0x100, 5.5x75, 5.5x100, 6.5x100, 6.5x150, 8.0x150 mm; CrV 6150; ⊕ PH0x75, PH1x75, PH1x100, PH1x150, PH2x100, PH2x150 mm; CrV 6150; ⊕ PZ0x75, PZ1x75, PZ2x100 mm; CrV 6150; ⊕ T10x75, T20x75, T25x100, T30x100 mm, CrV 6150; □ S0x75, S1x75, S2x100 mm; CrV 6150; ⊖ 2.5x50, 3.0x50 mm; CrV 6150; ⊕ PH00x50, PH0x50 mm; CrV 6150; ⊕ T6x50, T7x50, T8x50, T10x50 mm, CrV 6150; □ 1/4" (6.3 mm): 3, 3.5, 4, 4.5, 5, 5.5, 6, 6.5, 7, 8 mm (L=25 mm); CrV 6150; ⊕ 1/4" (6.3 mm): PH0 (2 PCS), PH1 (2 PCS), PH2 (3 PCS), PH3 (3 PCS) (L=25 mm); CrV 6150; ⊕ 1/4" (6.3 mm): PZ0 (2 PCS), PZ1 (2 PCS), PZ2 (3 PCS), PZ3 (3 PCS) (L=25 mm); CrV 6150; ⊕ 1/4" (6.3 mm): T6, T8, T10, T15, T20, T25, T27, T30, T35, T40 (L=25 mm); CrV 6150; □ 1/4" (6.3 mm): 2, 2.5, 3, 3.5, 4, 4.5, 5, 5.5, 6, 7 mm (L=25 mm); CrV 6150; □ 1/4" (6.3 mm): 1/8", 9/64", 5/32", 3/16", 7/32", 1/4" (L=25 mm); CrV 6150; □ 1/4" (6.3 mm): S0, S1, S2, S3 (L=25 mm); CrV 6150; □ 1/4" (6.3 mm); ⊕ SL5-PH1, SL6-PH2; CrV 6150

- EN Screwdriver
- PL Wkrętkak
- DE Schraubendreher
- RU Отвёртка
- CZ Šroubovák
- RO Șurubelniță
- HU Csavarhúzó
- ES Destornillador

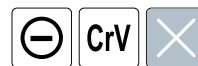

No.	⊖ [mm]	L [mm]	
61010	2.5	63	12/240
61020	3.2	75	12/240
61030	3.2	100	12/240
61040	3.2	150	12/240
61050	5.0	75	12/240
61060	5.0	100	12/240
61070	5.0	150	12/240
61080	5.0	200	12/240

- EN Screwdriver
- PL Wkrętkak
- DE Schraubendreher
- RU Отвёртка
- CZ Šroubovák
- RO Șurubelniță
- HU Csavarhúzó
- ES Destornillador

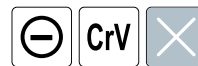

No.	⊖ [mm]	L [mm]	Driver / Zabierak	
61110	6	100	tak	12/144
61120	6	150	nie	12/144
61140	6	200	nie	12/144
61160	8	150	nie	6/72

EN Screwdriver  
 PL Wkrętak  
 DE Schraubendreher  
 RU Отвёртка  
 CZ Šroubovák  
 RO Șurubelniță  
 HU Csavarhúzó  
 ES Destornillador

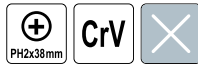

**VOREL**

No.	⊕	L [mm]	📦
61290	PH2	38	12/288

EN Screwdriver  
 PL Wkrętak  
 DE Schraubendreher  
 RU Отвёртка  
 CZ Šroubovák  
 RO Șurubelniță  
 HU Csavarhúzó  
 ES Destornillador

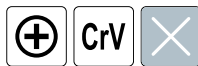

**VOREL**

No.	⊕	L [mm]	📦
61250	PH1	75	12/240
61260	PH1	100	12/240
61270	PH1	150	12/240
61280	PH1	200	12/240

EN Screwdriver set  
 PL Komplet wkrętek  
 DE Schraubendrehersatz  
 RU Набор отвёрток  
 CZ Zámečnické šroubováky  
 RO Șurubelnițe de lăcătușerie  
 HU Lakatos csavarhúzó  
 ES Juego de destornilladores

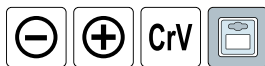

**VOREL**

No.	pcs / szt.	📦
61550	5	5/20

EN Screwdriver  
 PL Wkrętak  
 DE Schraubendreher  
 RU Отвёртка  
 CZ Šroubovák  
 RO Șurubelniță  
 HU Csavarhúzó  
 ES Destornillador



**VOREL**

No.	⊕	L [mm]	📦
61210	PH00	63	12/240
61220	PH0	75	12/240
61230	PH0	100	12/240
61240	PH0	150	12/240

EN Screwdriver  
 PL Wkrętak  
 DE Schraubendreher  
 RU Отвёртка  
 CZ Šroubovák  
 RO Șurubelniță  
 HU Csavarhúzó  
 ES Destornillador



**VOREL**

No.	⊕	L [mm]	Driver / Zaberak	📦
61300	PH2	100	nie	12/144
61320	PH2	150	nie	12/144
61340	PH2	200	nie	12/144
61350	PH2	250	nie	12/144

EN Two-way screwdriver  
 PL Wkrętak dwustronny  
 DE Umsteckschraubendreher  
 RU Отвёртка двухсторонняя  
 CZ Dvoustranný šroubovák  
 RO Șurubelniță dublu capăt  
 HU Kétoldalal csavarhúzó  
 ES Destornillador de dos caras

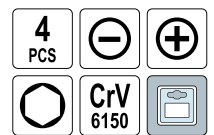

⊕ 5 mm-PH1; CrV 6150;  
 ⊕ 6 mm-PH2; CrV 6150;  
 ○ 6-8 mm; CrV 6150

**VOREL**

No.	pcs / szt.	📦
64654	4	12/72



EN Two-way screwdriver  
 PL Wkrętak dwustronny  
 DE Umsteckschraubendreher  
 RU Отвёртка двухсторонняя  
 CZ Dvoustranný šroubovák  
 RO Şurubelniţă dublu capăt  
 HU Kétoldalal csavarhúzó  
 ES Destornillador de dos caras



6 mm-PH2 (L=115 mm); CrV 6150



No.	pcs / szt.
64952	6/120

EN Screwdriver  
 PL Wkrętak  
 DE Schraubendreher  
 RU Отвёртка  
 CZ Šroubovák  
 RO Şurubelniţă  
 HU Csavarhúzó  
 ES Destornillador



No.	pcs / szt.
65041	7 25/100

EN Ratchet screwdriver set with bits  
 PL Zestaw wkrętak z grzechotką i bitami  
 DE Schraubendreher mit Ratche  
 RU Отвёртка реверсивная с набором бит  
 CZ Šroubovák z řehačkou  
 RO Şurubelniţă cu clichet  
 HU Racsnis csavarbehajtó  
 ES Juego con destornillador y carraca

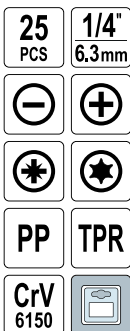

1/4" (6.3 mm): 4, 5, 6, 7, 6, 9, 10, 11, 12 mm; 1/4" (6.3 mm); (L=25 mm); CrV 6150; 1/4" (6.3 mm): 4, 5, 6 mm (L=25 mm); CrV 6150; 1/4" (6.3 mm): PH0, PH1, PH2, PH3 (L=25 mm); CrV 6150; 1/4" (6.3 mm): PZ0, PZ1, PZ2, PZ3 (L=25 mm); CrV 6150; 1/4" (6.3 mm): T10, T15, T20 (L=25 mm); CrV 6150



No.	pcs / szt.
65105	25 6/36

EN Precision screwdriver bits  
 PL Zestaw końcówek śrubokrętowych  
 DE Schraubendreherbitsatz  
 RU Набор специальных бит  
 CZ Sada bitov  
 RO Truse bit  
 HU Bitkészlet  
 ES Juego de llaves especiales

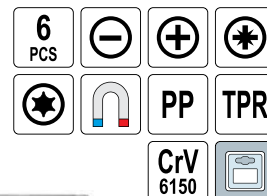

5-6 mm (L=150 mm); CrV 6150; PH1-PH2 (L=150 mm); CrV 6150; PZ1-PZ2 (L=150 mm); CrV 6150; T20-T25 (L=150 mm); CrV 6150; 5-6 mm (L=150 mm); CrV 6150



No.	pcs / szt.
64960	6 12/48

EN Ratchet screwdriver set with bits  
 PL Zestaw wkrętak z grzechotką i bitami  
 DE Schraubendreher mit Ratche  
 RU Отвёртка реверсивная с набором бит  
 CZ Šroubovák z řehačkou  
 RO Şurubelniţă cu clichet  
 HU Racsnis csavarbehajtó  
 ES Juego con destornillador y carraca



1/4" (6.3 mm): 3.5, 4, 5.5 mm (L=25 mm); 1/4" (6.3 mm): PH0, PH1, PH2 (L=25 mm); 1/4" (6.3 mm): PZ0, PZ1, PZ2 (L=25 mm); 1/4" (6.3 mm): T20, T25 (L=25 mm)



No.	pcs / szt.
64658	12 12/72

EN Ratchet screwdriver set with bits  
 PL Wkrętak z grzechotką i wymiennymi końcówkami  
 DE Schraubendreher mit Ratche  
 RU Отвёртки с набором бит  
 CZ Šroubovák z řehačkou  
 RO Şurubelniţă cu clichet  
 HU Racsnis csavarbehajtó  
 ES Juego con destornillador y carraca

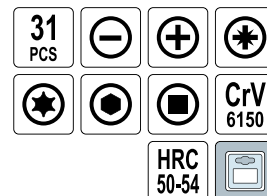

1/4" (6.3 mm): 3, 3.5, 4, 5, 5.5, 6 mm (L=25 mm); 1/4" (6.3 mm): PH0, PH1, PH2, PH3 (L=25 mm); 1/4" (6.3 mm): PZ0, PZ1, PZ2, PZ3 (L=25 mm); 1/4" (6.3 mm): T10, T15, T20, T25, T27, T30 (L=25 mm); 1/4" (6.3 mm): 2, 2.5, 3, 4, 5, 6 mm (L=25 mm); 1/4" (6.3 mm): S0, S1 (L=25 mm); 2.0x50 mm; PH00 x 50 mm



No.	pcs / szt.
64655	31 6/36

EN Ratchet screwdriver set with bits  
 PL Zestaw wkrętak z grzechotką i bitami  
 DE Schraubendreher mit Ratche  
 RU Отвёртка реверсивная с набором бит  
 CZ Šroubovák z fehtačkou  
 RO Şurubelniţă cu clichet  
 HU Racsnis csavarbehajtó  
 ES Juego con destornillador y carraca

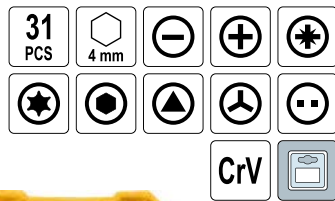

□ 1.0, 1.5, 2.0, 2.5, 3.0 mm; CrV; ⚙ PH000, PH00, PH0, PH1, PH2; CrV; ⚙ PZ0, PZ1; CrV; ⚙ T4, T5, T6, T7, T8, T10; CrV; ○ 0.7, 0.9, 1.3, 1.5, 2.0, 3.0 mm; CrV; △ 3.0 mm; CrV; ▽ 3.0 mm; CrV; ▽ 2.6 mm; CrV; ▽ 115 mm; CrV



No.	pcs / szt.	📦
65025	31	6/24

EN Ratchet screwdriver set with bits  
 PL Zestaw wkrętak z grzechotką i bitami  
 DE Schraubendreher mit Ratche  
 RU Отвёртка реверсивная с набором бит  
 CZ Šroubovák z fehtačkou  
 RO Şurubelniţă cu clichet  
 HU Racsnis csavarbehajtó  
 ES Juego con destornillador y carraca



EN Impact screwdriver  
 PL Wkrętak udarowy  
 DE Schlagschrauber  
 RU Отвёртка ударная  
 CZ Narazový šroubovák kovový  
 RO Şurubelniţă metalică cu percutor  
 HU Kézi ütvecsavarhúzó  
 ES Destornillador de percusión



No.	pcs / szt.	📦
65120	5	25

EN Ratchet screwdriver set with bits  
 PL Wkrętak z grzechotką i wymiennymi końcówkami  
 DE Schraubendreher mit Ratche  
 RU Отвёртки с набором бит  
 CZ Šroubovák z fehtačkou  
 RO Şurubelniţă cu clichet  
 HU Racsnis csavarbehajtó  
 ES Juego con destornillador y carraca

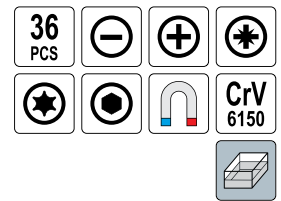

□ 1/4" (6.3 mm): 4, 4.5, 5, 6, 7, 8, 9, 10, 11, 12, 13 mm; □ 1/4" (6.3 mm): 3, 3.5, 4, 5.5 mm (L=25 mm); ⚙ 1/4" (6.3 mm): PH0, PH1, PH2, PH3 (L=25 mm); ⚙ 1/4" (6.3 mm): PZ0, PZ1, PZ2, PZ3 (L=25 mm); ⚙ 1/4" (6.3 mm): T10, T15, T20, T25, T27, T30 (L=25 mm); ○ 1/4" (6.3 mm): 3, 4 mm (L=25 mm); □ 50 mm



No.	pcs / szt.	📦
64660	36	6/24

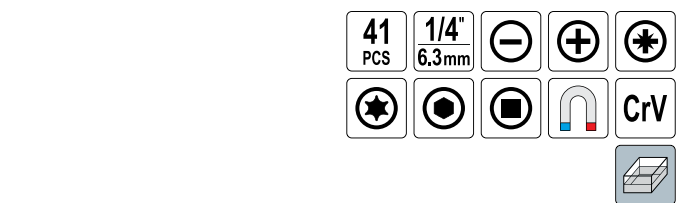

□ 1/4" (6.3 mm): 5, 6, 7, 8, 9, 10 mm (L=20 mm); CrV; □ 3.0, 4.0, 5.0, 6.0 mm, 1/8" (3.2 mm), 5/32" (4.0 mm), 3/16" (4.8 mm), 1/4" (6.3 mm); CrV; ⚙ PH0, PH1, PH2, PH3; CrV; ⚙ PZ0, PZ1, PZ2, PZ3; CrV; ⚙ T15, T20, T25, T30; CrV; ○ 3.0, 4.0, 5.0, 6.0 mm, 1/8" (3.2 mm), 5/32" (4.0 mm), 3/16" (4.8 mm), 1/4" (6.3 mm); CrV; □ S0, S1, S2, S3 mm; CrV; □ 1/4" (6.3 mm); (L=25 mm); CrV; □ 1/4" (6.3 mm); (L=60 mm); CrV



No.	pcs / szt.	📦
64385	41	6/24

EN Ratchet screwdriver set with bits  
 PL Zestaw wkrętak z grzechotką i bitami  
 DE Schraubendreher mit Ratche  
 RU Отвёртка реверсивная с набором бит  
 CZ Šroubovák z fehtačkou  
 RO Şurubelniţă cu clichet  
 HU Racsnis csavarbehajtó  
 ES Juego con destornillador y carraca

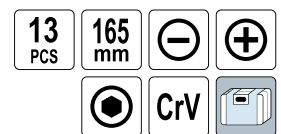

□ 5/16" (7.9 mm) x 1/2" (12.7 mm);  
 □ 5, 6, 8, 9 mm (L=35 mm);  
 ⚙ PH1, PH2, PH3, PH4 (L=35 mm);  
 ○ 4, 5, 6, 8 mm (L=35 mm)



No.	pcs / szt.	📦
65123	13	20

- EN Impact screwdriver
- PL Wkrętak udarowy
- DE Schlagschrauber
- RU Отвёртка ударная
- CZ Narazový šroubovák kovový
- RO Şurubelniţă metalică cu percutor
- HU Kézi ütvecsavarhúzó
- ES Destornillador de percusión

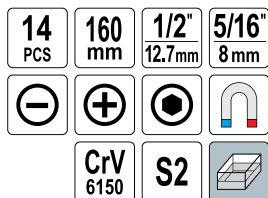

- 5/16" (7.9 mm) x 1/2" (12.7 mm);
- 4, 5, 6, 8, 9 mm (L=35 mm); S2;
- PH1, PH2, PH3 (L=35 mm); S2;
- 4, 5, 6, 8 mm (L=35 mm)



No.	pcs / szt.	☐
65124	14	20

- EN Screwdriver with magnetic telescopic pick-up tool
- PL Wkrętak z teleskopowym chwytakiem magnetycznym
- DE Schraubendreher mit auschiebbaren magnetischem Halter
- RU Отвёртка магнитная с битами
- CZ Magnetický ťoubovák-teleskop
- RO Şurubelniţă cu magnet-telescop
- HU Mágneses csavarbehajtó-teleszkop
- ES Destornillador magnético-telescop

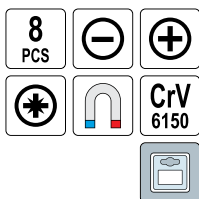

- 1/4" (6.3 mm): 3, 4, 5.5 mm (L=25 mm);
- 1/4" (6.3 mm): PH1, PH2 (L=25 mm);
- 1/4" (6.3 mm): PZ1, PZ2 (L=25 mm)



No.	pcs / szt.	☐
64650	8	12/72

- EN T-bar screwdriver
- PL Wkrętak T-gryf
- DE T-griff Schraubendrehersatz
- RU Отвёртка с Т-образной ручкой и насадками
- CZ Šroubovák T-gryf
- RO Set surubelniţa tip „T”
- HU Csavarbehajtó, T-gryf
- ES Destornillador T-grifo

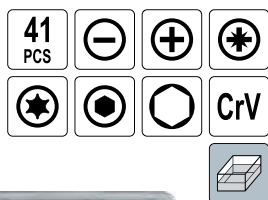

- 1/4" (6.3 mm): 4, 5, 6, 7 mm (L=25 mm); 1/4" (6.3 mm): PH1, PH2, PH3 (L=25 mm);
- 1/4" (6.3 mm): T10, T15, T20, T25, T30, T40 (L=25 mm); 1/4" (6.3 mm): PZ1, PZ2, PZ3 (L=25 mm);
- 1/4" (6.3 mm): 4, 5, 6 mm (L=25 mm); 1/4" (6.3 mm): 5, 6, 7, 8, 9, 10, 11, 12, 13 mm; CrV;
- 1/4" (6.3 mm): 3/16" (4.8 mm), 7/32" (5.6 mm), 1/4" (6.3 mm), 9/32" (7.1 mm), 5/16" (7.9 mm), 11/32" (8.7 mm), 3/8" (9.5 mm), 7/16" (11.1 mm), 1/2" (12.7 mm); CrV; 1/4" (6.3 mm) x 6 mm; 1/4" (6.3 mm)



No.	pcs / szt.	☐
65150	41	24

- EN Telescopic screwdriver, magnetic
- PL Wkrętak magnetyczny, teleskopowy
- DE Schraubendreher
- RU Отвёртка магнитная с битами
- CZ Magnetický ťoubovák -teleskop
- RO Surubelniţa telescopica cu magnet
- HU Mágneses csavarbehajtó-teleszkop
- ES Destornillador magnético-telescop



No.	pcs / szt.	☐
65045	7	25/100

- EN T-bar screwdriver
- PL Wkrętak T-gryf
- DE T-griff Schraubendrehersatz
- RU Отвёртка с Т-образной ручкой и насадками
- CZ Šroubovák T-gryf
- RO Set surubelniţa tip „T”
- HU Csavarbehajtó, T-gryf
- ES Destornillador T-grifo



No.	pcs / szt.	☐
65100	21	10/80

- EN Screwdriver set
- PL Komplet wkrętaków
- DE Schraubendrehersatz
- RU Набор отвёрток
- CZ Zámečnické šroubováky
- RO Şurubelniţe de lăcătuşerie
- HU Lakatos csavarhózó
- ES Juego de destornilladores



No.	pcs / szt.	☐
64060	6	20/60



EN Screwdriver set  
 PL Komplet wkrętaków  
 DE Schraubendrehersatz  
 RU Набор отвёрток  
 CZ Zámečnické šroubováky  
 RO Şurubelnițe de lăcătușerie  
 HU Lakatos csavarhózó  
 ES Juego de destornilladores

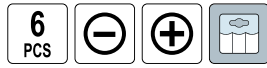

No.	pcs / szt.	Icon
64050	6	20/80

EN Screwdriver set  
 PL Komplet wkrętaków  
 DE Schraubendrehersatz  
 RU Набор отвёрток  
 CZ Zámečnické šroubováky  
 RO Şurubelnițe de lăcătușerie  
 HU Lakatos csavarhózó  
 ES Juego de destornilladores



No.	pcs / szt.	Icon
64090	6	10/60

EN Precision screwdriver bits and holder  
 PL Zestaw końcówek śrubokrętowych z uchwytem  
 DE Schraubendreherbitsatz mit Bithalter  
 RU Отвёртка с набором специальных бит  
 CZ Sada bitů s držákem  
 RO Truse bit + capete şurubel niță  
 HU Csavarhózó bit készlet  
 ES Juego de destornillador con puntas

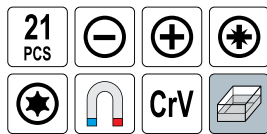

**VOREL**

No.	pcs / szt.	Icon
64370	21	10/60

EN Screwdriver set  
 PL Komplet wkrętaków  
 DE Schraubendrehersatz  
 RU Набор отвёрток  
 CZ Zámečnické šroubováky  
 RO Şurubelnițe de lăcătușerie  
 HU Lakatos csavarhózó  
 ES Juego de destornilladores

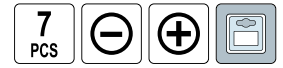

No.	pcs / szt.	Icon
64070	7	20/80

EN Ratchet screwdriver set with bits  
 PL Zestaw wkrętak z grzechotką i bitami  
 DE Schraubendreher mit Ratche  
 RU Отвёртка реверсивная с набором бит  
 CZ Šroubovák z fehtačkou  
 RO Şurubelnița cu clichet  
 HU Racsnis csavarbehajtó  
 ES Juego con destornillador y carraca

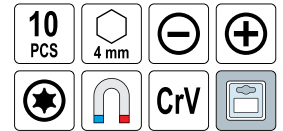

▯ 1.0, 1.5, 2.0 mm; CrV;  
 ⊕ PH00, PH0, PH1; CrV;  
 ⊕ T6, T7, T8; CrV

**VOREL**

No.	pcs / szt.	Icon
64400	10	8/144

EN Ratchet screwdriver set with bits  
 PL Zestaw wkrętak z grzechotką i bitami  
 DE Schraubendreher mit Ratche  
 RU Отвёртка реверсивная с набором бит  
 CZ Šroubovák z fehtačkou  
 RO Şurubelnița cu clichet  
 HU Racsnis csavarbehajtó  
 ES Juego con destornillador y carraca

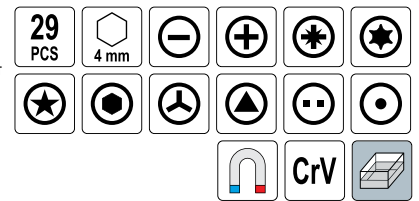

▯ 0.7, 1.0, 1.2, 1.5, 1.8 mm; CrV; ⊕ PH000, PH00, PH0, PH1; CrV; ⊕ PZ000, PZ00, PZ0, PZ1; CrV; ⊕ 0.7, 0.9, 1.3, 1.5, 2.0 mm; CrV; ⊕ T4, T5, T6, T7, T8; CrV; ⊕ 3.0 mm; CrV; ⊕ 3.0 mm; CrV; ⊕ 2.6 mm; CrV; ⊕ 2.0 mm; CrV; ⊕ 1.0 mm; CrV

**VOREL**

No.	pcs / szt.	Icon
64401	29	12/48

EN Precision screwdriver bits and holder  
 PL Zestaw końcówek śrubokrętowych z uchwytem  
 DE Schraubendreherbitsatz mit Bithalter  
 RU Отвертка с набором специальных бит  
 CZ Sada bitů s držákem  
 RO Truse bit + capete șurubel niță  
 HU Csavarhúzó bit készlet  
 ES Juego de destornillador con puntas

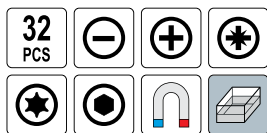

- 1/4" (6.3 mm): 1.0, 1.5, 2.0, 2.5, 3.0, 3.5, 4.0 mm;
- ⊕ 1/4" (6.3 mm): PH000, PH00, PH0, PH1;
- ⊕ 1/4" (6.3 mm): PZ0, PZ1;
- ⊕ 1/4" (6.3 mm): T4, T5, T6, T7, T8, T9, T10, T15, T20;
- 1/4" (6.3 mm): 0.7, 0.9, 1.3, 1.5, 2.0, 2.5, 3.0, 4.0 mm



No.	pcs / szt.	Image
64371	32	10/20

EN Precision screwdriver set  
 PL Zestaw wkrętek precyzyjnych  
 DE Präzisions-Feinmechanikersatz  
 RU Набор прецизионных отверток

CZ Šroubová sada pro jemnou mechaniku  
 RO Set șurubelnite  
 HU Órás csavarhúzó készlet  
 ES Destornilladores precisos

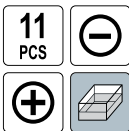

- ⊖ 0.9, 1.2, 1.4, 1.8, 2.4, 3.0 mm;
- ⊕ PH00, PH0, PH1

No.	pcs / szt.	Image
64330	11	25/100

EN Precision screwdriver bits and holder  
 PL Zestaw końcówek śrubokrętowych z uchwytem  
 DE Schraubendreherbitsatz mit Bithalter  
 RU Отвертка с набором специальных бит  
 CZ Sada bitů s držákem  
 RO Truse bit + capete șurubel niță  
 HU Csavarhúzó bit készlet  
 ES Juego de destornillador con puntas

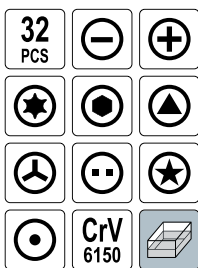

- 1/16" (1.6 mm), 5/64" (2.0 mm), 3/32" (2.4 mm), 1/8" (3.2 mm), 9/64" (3.6 mm), 5/32" (4.0 mm);
- ⊕ PH000, PH00, PH0, PH1, PH2; ○ 0.035" (0.9 mm), 1/16" (1.6 mm), 0.05" (1.8 mm), 5/64" (2.0 mm), 3/32" (2.4 mm), 1/8" (3.2 mm), 5/32" (4.0 mm);
- ⊕ T4, T5, T6, T7, T8, T10, T15, T20;
- ☆ 5/64" (2.0 mm); ○ 0.035" (0.9 mm); △ 1/8" (3.2 mm); ⊕ 1/8" (3.2 mm);
- ⊖ 7/64" (2.8 mm)



No.	pcs / szt.	Image
64396	32	10/50

EN Precision screwdriver set  
 PL Zestaw wkrętek precyzyjnych  
 DE Präzisions-Feinmechanikersatz  
 RU Набор прецизионных отверток

CZ Šroubová sada pro jemnou mechaniku  
 RO Set șurubelnite  
 HU Órás csavarhúzó készlet  
 ES Destornilladores precisos

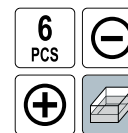

- ⊖ 1.4, 2.0, 2.4, 3.0 mm;
- ⊕ PH0, PH1

No.	pcs / szt.	Image
64310	6	20/100

EN Precision screwdriver bits and holder  
 PL Zestaw końcówek śrubokrętowych z uchwytem  
 DE Schraubendreherbitsatz mit Bithalter  
 RU Отвертка с набором специальных бит  
 CZ Sada bitů s držákem  
 RO Truse bit + capete șurubel niță  
 HU Csavarhúzó bit készlet  
 ES Juego de destornillador con puntas

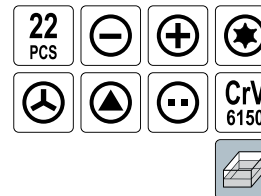

- 1/16" (1.6 mm), 5/64" (2.0 mm), 3/32" (2.4 mm), 1/8" (3.2 mm), 5/32" (4.0 mm);
- ⊕ PH000, PH00, PH0, PH1
- ⊕ T5, T6, T7, T8, T9, T10, T15, T20; △ 3.0 mm; ⊕ 3.0 mm;
- ⊖ 2.6 mm;



No.	pcs / szt.	Image
64395	22	10/50

EN Mobile phone repair tools set  
 PL Zestaw do naprawy telefonów komórkowych  
 DE Mobiltelefon Reparatur Satz  
 RU Набор инструмента для ремонта мобильных телефонов  
 CZ Nástroje na opravu mobilních telefonů  
 RO Set șurubelnite service telefoane mobile  
 HU Mobiltelefon-javítás szerszámkészlet  
 ES Herramientas de la reparación del teléfono móvil fijadas

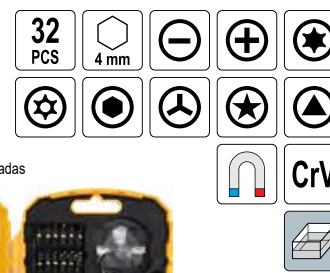

- 1.0, 2.0 mm; CrV; ⊕ PH000, PH00, PH0, PH1; CrV; ⊕ T2, T3, T4, T5, T6, T8, T10;
- CrV; ⊕ T7, CrV; ○ 1.5, 2.0 mm; CrV; ⊕ Y000, Y00, Y0; CrV; ☆ 0.8 (2 PCS), 1.2, 1.5 mm; CrV; △ 3.0 mm; CrV; ⊖ 4x75 mm; CrV



No.	pcs / szt.	Image
64384	32	6/48

EN Precision screwdriver set  
 PL Wkrętaki precyzyjne  
 DE Präzisions-Schraubendrehersatz  
 RU Набор отвёрток для точных работ  
 CZ Přesní šroubováky  
 RO Șurubelnițe precise  
 HU Precíziós csavarhúzó  
 ES Destornilladores precisos



No.	Tip size / Rozmiar grotu	pcs / szt.	
64553	1.4, 2.4, 3.0, PH00, PH0, PH1	6	10/60
64554	T5, T6, T7, T8, T9, T10	6	10/60

EN Screwdriver bit set  
 PL Zestaw końcówek śrubokrętowych  
 DE Schraubendreherbitsatz  
 RU Набор битов  
 CZ Sada šroubovacích bitů  
 RO Trusă biți  
 HU Csavarbit készlet  
 ES Juego de puntas para atornillar



1/4" (6.3 mm): 5, 6 mm (L=25 mm); CrV; 1/4" (6.3 mm): PH0, PH1, PH2 (L=25 mm); CrV; 1/4" (6.3 mm): PZ1, PZ2 (L=25 mm); CrV; 1/4" (6.3 mm): T15, T20 (L=25 mm); CrV; 1/4" (6.3 mm); (L=60 mm); CrV



No.	pcs / szt.	
65705	10	5/80

EN Screwdriver bit set  
 PL Zestaw końcówek śrubokrętowych  
 DE Schraubendreherbitsatz  
 RU Набор битов  
 CZ Sada šroubovacích bitů  
 RO Trusă biți  
 HU Csavarbit készlet  
 ES Juego de puntas para atornillar



No.	pcs / szt.	
66301	41	10/40

EN Screwdriver bit set  
 PL Zestaw końcówek śrubokrętowych  
 DE Schraubendreherbitsatz  
 RU Набор битов  
 CZ Sada šroubovacích bitů  
 RO Trusă biți  
 HU Csavarbit készlet  
 ES Juego de puntas para atornillar

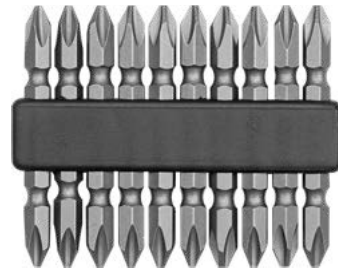

No.		L [mm]	pcs / szt.	
65700	PH2	60	10	25/100

EN Screwdriver bit set  
 PL Zestaw końcówek śrubokrętowych  
 DE Schraubendreherbitsatz  
 RU Набор битов  
 CZ Sada šroubovacích bitů  
 RO Trusă biți  
 HU Csavarbit készlet  
 ES Juego de puntas para atornillar

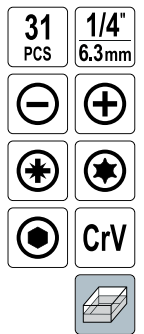

1/4" (6.3 mm): 3, 4, 5, 5.5, 6, 7 mm (L=25 mm); CrV; 1/4" (6.3 mm): PH0, PH1 (2 PCS), PH2 (2 PCS), PH3 (L=25 mm); CrV; 1/4" (6.3 mm): PZ0, PZ1 (2 PCS), PZ2 (2 PCS), PZ3 (L=25 mm); CrV; 1/4" (6.3 mm): T10, T15, T20, T25, T27, T30 (L=25 mm); CrV; 1/4" (6.3 mm): 2, 3, 4, 5, 5.5, 6 mm (L=25 mm); CrV; 1/4" (6.3 mm); (L=60 mm); CrV



No.	pcs / szt.	
66302	31	10/30

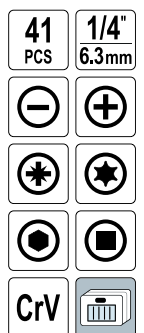

1/4" (6.3 mm): 3, 4, 5, 5.5, 6, 7 mm (L=25 mm); CrV; 1/4" (6.3 mm): PH0, PH1 (2 PCS), PH2 (4 PCS), PH3 (L=25 mm); CrV; 1/4" (6.3 mm): PZ0, PZ1 (2 PCS), PZ2 (4 PCS), PZ3 (L=25 mm); CrV; 1/4" (6.3 mm): T10, T15, T20, T25, T27, T30, T40 (L=25 mm); CrV; 1/4" (6.3 mm): 2, 2.5, 3, 4, 5, 5.5, 6 mm (L=25 mm); CrV; 1/4" (6.3 mm): S0, S1, S2, S3 (L=25 mm); CrV; 1/4" (6.3 mm); (L=60 mm); CrV



- EN Screwdriver bit set  
 PL Zestaw końcówek śrubokrętowych  
 DE Schraubendreherbitsatz  
 RU Набор битов
- CZ Sada šroubovacích bitů  
 RO Trusă biți  
 HU Csavarbit készlet  
 ES Juego de puntas para atornillar



- Ø 1/4" (6.3 mm): 3, 4, 5, 5.5, 6, 7 mm (L=25 mm); 4, 6 mm (L=50 mm); CrV;  
 ⚙ 1/4" (6.3 mm): PH0, PH1 (2 PCS), PH2 (5 PCS), PH3 (L=25 mm); PH1, PH2, PH3 (L=50 mm); CrV;  
 ⚙ 1/4" (6.3 mm): PZ0, PZ1 (2 PCS), PZ2 (5 PCS), PZ3 (L=25 mm); PZ1, PZ2, PZ3 (L=50 mm); CrV;  
 ⚙ 1/4" (6.3 mm): T10, T15, T20, T25, T27, T30, T40 (L=25 mm); T15, T20, T25 (L=50 mm); CrV;  
 ○ 1/4" (6.3 mm): 2, 2.5, 3, 4, 5, 5.5, 6 mm (L=25 mm); 4, 5, 6 mm (L=50 mm); CrV;  
 □ 1/4" (6.3 mm): S0, S1, S2, S3 (L=25 mm); CrV

No.	pcs / szt.	📦
66310	56	8/16

- EN Screwdriver bit set  
 PL Zestaw końcówek śrubokrętowych  
 DE Schraubendreherbitsatz  
 RU Набор битов
- CZ Sada šroubovacích bitů  
 RO Trusă biți  
 HU Csavarbit készlet  
 ES Juego de puntas para atornillar

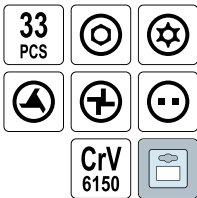

- ⚙ 1/4" (6.3 mm): T8, T10, T15, T20, T25, T27, T30, T35, T40 (L=25 mm); ⚙ 1/4" (6.3 mm): 5/64" (2.0 mm), 3/32" (2.4 mm), 7/64" (2.8 mm), 1/8" (3.2 mm), 9/64" (3.6 mm), 5/32" (4.0 mm) (L=25 mm); ⚙ 1/4" (6.3 mm): 2, 2.5, 3, 4, 5, 6 mm (L=25 mm); ⚙ 1/4" (6.3 mm): 1, 2, 3, 4 (L=25 mm); ⚙ 1/4" (6.3 mm): 6, 8, 10 (L=25 mm); ⚙ 1/4" (6.3 mm): 4, 6, 8, 10 (L=25 mm); ⚙ 1/4" (6.3 mm): (L=60 mm)

No.	pcs / szt.	📦
66330	33	12/60

- EN Screwdriver bit set  
 PL Zestaw końcówek śrubokrętowych  
 DE Schraubendreherbitsatz  
 RU Набор битов
- CZ Sada šroubovacích bitů  
 RO Trusă biți  
 HU Csavarbit készlet  
 ES Juego de puntas para atornillar



- ⚙ T20, T25, T30, T40, T45, T50, T55 (L=30 mm); T20, T25, T30, T40, T45, T50, T55 (L=75 mm);  
 ○ 4, 5, 6, 7, 8, 10, 12 mm (L=30 mm); 4, 5, 6, 7, 8, 10, 12 mm (L=75 mm); ○ M5, M6, M8, M10, M12 (L=30 mm); M5, M6, M8, M10, M12 (L=75 mm)

No.	pcs / szt.	📦
66410	40	10

- EN Screwdriver bit set  
 PL Końcówki śrubokrętowe do gipsów  
 DE Schraubendreherbitsatz  
 RU Насадки для быстрого завинчивания саморезов по гипсокартону
- CZ Konečky šroubovacové na sádku  
 RO Capete pt. ghips pt. șurubelniță  
 HU Csavarhúzóvégék gipszhez  
 ES Puntas con limitador



⚙ 1/4" (6.3 mm): PH2 (L=25 mm)

No.	pcs / szt.	📦
65800	2	12/144

- EN Screwdriver bit set  
 PL Zestaw końcówek śrubokrętowych  
 DE Schraubendreherbitsatz  
 RU Набор битов
- CZ Sada šroubovacích bitů  
 RO Trusă biți  
 HU Csavarbit készlet  
 ES Juego de puntas para atornillar



- ⚙ 3/8" (9.5 mm): T20, T25, T30, T40, T45, T50, T55 (L=30 mm); 3/8" (9.5 mm): T20, T25, T30, T40, T45, T50, T55 (L=75 mm); ○ 3/8" (9.5 mm): 4, 5, 6, 7, 8, 10, 12 mm (L=30 mm); 3/8" (9.5 mm): 4, 5, 6, 7, 8, 10, 12 mm (L=75 mm); ○ 3/8" (9.5 mm): M5, M6, M8, M10, M12 (L=30 mm); 3/8" (9.5 mm): M5, M6, M8, M10, M12 (L=75 mm); ⚙ 1/2" (12.7 mm) x 3/8" (9.5 mm); 3/8" (9.5 mm) x 3/8" (9.5 mm)

No.	pcs / szt.	📦
66400	40	10

- EN Screwdriver bit set  
 PL Zestaw końcówek śrubokrętowych  
 DE Schraubendreherbitsatz  
 RU Набор битов
- CZ Sada šroubovacích bitů  
 RO Trusă biți  
 HU Csavarbit készlet  
 ES Juego de puntas para atornillar



- ⚙ 3/8" (9.5 mm): T25, T30, T40, T45, T50, T55 (L=30 mm);  
 ⚙ 1/2" (12.7 mm) x 3/8" (9.5 mm)

No.	pcs / szt.	📦
66570	7	24/72

EN Screwdriver bit set  
 PL Zestaw końcówek śrubokrętowych  
 DE Schraubendreherbitsatz  
 RU Набор битов  
 CZ Sada šroubovacích bitů  
 RO Trusă biți  
 HU Csavarbit készlet  
 ES Juego de puntas para atornillar



3/8" (9.5 mm): T20, T25, T30, T40, T45, T50, T55 (L=30 mm); 3/8" (9.5 mm): T20, T25, T30, T40, T45, T50, T55 (L=75 mm);  
 1/2" (12.7 mm) x 3/8" (9.5 mm)



No.	pcs / szt.	20
66580	15	20

EN Screwdriver bit set  
 PL Zestaw końcówek śrubokrętowych  
 DE Schraubendreherbitsatz  
 RU Набор битов  
 CZ Sada šroubovacích bitů  
 RO Trusă biți  
 HU Csavarbit készlet  
 ES Juego de puntas para atornillar

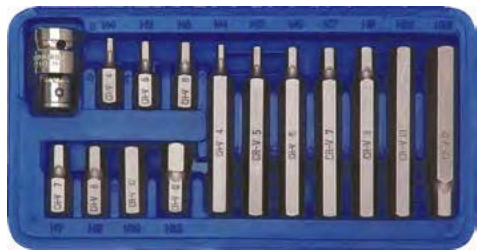
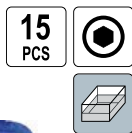

3/8" (9.5 mm): 4, 5, 6, 7, 8, 10, 12 (L=30 mm); 3/8" (9.5 mm): 4, 5, 6, 7, 8, 10, 12 (L=75 mm); 1/2" (12.7 mm) x 3/8" (9.5 mm)



No.	pcs / szt.	20
66720	15	20

EN Screwdriver bit set  
 PL Zestaw końcówek śrubokrętowych  
 DE Schraubendreherbitsatz  
 RU Набор битов  
 CZ Sada šroubovacích bitů  
 RO Trusă biți  
 HU Csavarbit készlet  
 ES Juego de puntas para atornillar



3/8" (9.5 mm): M5, M6, M8, M10, M12 (L=30 mm); 3/8" (9.5 mm): M5, M6, M8, M10, M12 (L=75 mm);  
 1/2" (12.7 mm) x 3/8" (9.5 mm)



No.	pcs / szt.	20
66770	11	20

EN Screwdriver bit set  
 PL Zestaw końcówek śrubokrętowych  
 DE Schraubendreherbitsatz  
 RU Набор битов

CZ Sada šroubovacích bitů  
 RO Trusă biți  
 HU Csavarbit készlet  
 ES Juego de puntas para atornillar

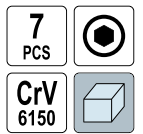

3/8" (9.5 mm): 4, 5, 6, 8, 10, 12 mm (L=30 mm); 1/2" (12.7 mm) x 3/8" (9.5 mm)



No.	pcs / szt.	24/72
66710	7	24/72

EN Screwdriver bit set  
 PL Zestaw końcówek śrubokrętowych  
 DE Schraubendreherbitsatz  
 RU Набор битов  
 CZ Sada šroubovacích bitů  
 RO Trusă biți  
 HU Csavarbit készlet  
 ES Juego de puntas para atornillar

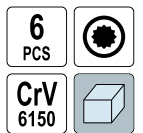

3/8" (9.5 mm): M5, M6, M8, M10, M12 (L=30 mm); 1/2" (12.7 mm) x 3/8" (9.5 mm)



No.	pcs / szt.	24/72
66760	6	24/72

EN Screwdriver bit set  
 PL Zestaw końcówek śrubokrętowych  
 DE Schraubendreherbitsatz  
 RU Набор битов  
 CZ Sada šroubovacích bitů  
 RO Trusă biți  
 HU Csavarbit készlet  
 ES Juego de puntas para atornillar

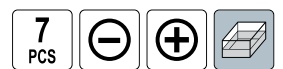

No.	pcs / szt.	20/200
66080	7	20/200

EN Screwdriver bit set  
 PL Zestaw końcówek śrubokrętowych  
 DE Schraubendreherbitsatz  
 RU Набор битов

CZ Sada šroubovacích bitů  
 RO Trusă biți  
 HU Csavarbit készlet  
 ES Juego de puntas para atornillar



No.	pcs / szt.	
66112	10	25/100

EN Screwdriver bit set  
 PL Zestaw końcówek śrubokrętowych  
 DE Schraubendreherbitsatz  
 RU Набор битов

CZ Sada šroubovacích bitů  
 RO Trusă biți  
 HU Csavarbit készlet  
 ES Juego de puntas para atornillar



No.	pcs / szt.	
66200	20	12/48

EN Screwdriver bit set  
 PL Komplet końcówek nasadowych  
 DE Bit-Sleckschlüsselsatz  
 RU Набор торцевых головок

CZ Sada nastrčných koncoviek  
 RO Set de capete tubulare  
 HU Csökülcsészlet  
 ES Juego de puntas de calar

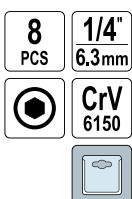

1/4" (6.3 mm): 5, 6, 7, 8, 9, 10, 11, 13 mm; CrV 6150

No.	pcs / szt.	
66113	8	25/50

EN Screwdriver bit set  
 PL Zestaw końcówek śrubokrętowych  
 DE Schraubendreherbitsatz  
 RU Набор битов

CZ Sada šroubovacích bitů  
 RO Trusă biți  
 HU Csavarbit készlet  
 ES Juego de puntas para atornillar



No.	pcs / szt.	
66210	20	12/48

EN Screwdriver bit holder  
 PL Uchwyt do końcówek śrubokrętowych  
 DE Bithalter  
 RU Магнитный держатель  
 CZ Držák na šroubovákovekoncevky  
 RO Capete șurubelniță  
 HU Szár a csavarhúzóvégekhöz  
 ES Mandril para puntas



No.		
65850		30/300

EN Angle adapter  
 PL Adapter kątowy  
 DE Winkelschrauber  
 RU Адаптер угловой для бит

CZ Úhel elektrická vrtačka připojení adaptéru  
 RO Dispozitiv unghiular de insurubat  
 HU Sarokcsavarozó adapter  
 ES Ángulo magnético bit driver adaptador

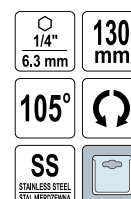

No.	1/4" (6.3 mm)	L [mm]	
65840		130	60



EN T-handle hex key  
 PL Klucz sześciokątny typu "T"  
 DE T-Griff Sechskant Stiftschlüssel  
 RU Ключ Hex T-образный с рукояткой  
 CZ Imbusový klíč s T-rukojetí  
 RO Cheie hexagonală tip "T"  
 HU Imbuskulcs T-markolattal  
 ES Llave Allen con mango en "T"

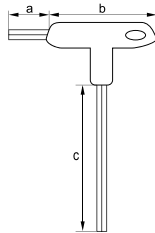

**VOREL**

No.	⊙ [mm]	a [mm]	b [mm]	c [mm]	📦
56640	2.0	10	59	100	24/240
56642	3.0	13	59	100	24/240
56643	4.0	13	76	150	24/192
56644	5.0	14	76	150	24/192
56645	6.0	14	76	150	24/192

EN T-handle hex key set  
 PL Zestaw kluczy sześciokątnych typu "T"  
 DE T-Griff Sechskant Stiftschlüsselsatz  
 RU Набор ключей Hex с T-образной рукояткой  
 CZ Sada imbusů "T" rukojetí  
 RO Set chei hexagonale tip "T"  
 HU Imbuskulcs T-markolattal készlet  
 ES Juego de llaves Allen con mango en "T"

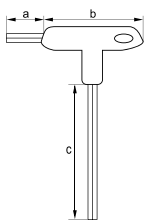

**VOREL**

No.	⊙ [mm]	a [mm]	b [mm]	c [mm]	pcs / szt.	📦
56649	2.5, 3, 4, 5, 6, 7, 8, 10	12, 13, 13, 14, 14, 16, 18, 20	59, 59, 76, 76, 76, 95, 95	100, 100, 150, 150, 150, 200, 200	8	12/24

EN T-handle hex key with ball  
 PL Klucz sześciokątny typu "T" z kulką  
 DE T-Griff Sechskant Stiftschlüssel mit Kugel  
 RU Ключ Hex T-образный с шаровой головкой  
 CZ T-tyr imbusového klíče s kulovou hlavou  
 RO Cheie hexagonală cu bila tip "T"  
 HU Imbuskulcs T-markolattal gömbfej  
 ES Llave Allen con el tipo de pelota "T"

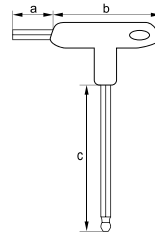
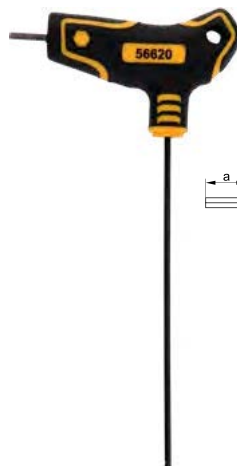

**VOREL**

No.	⊙ [mm]	a [mm]	b [mm]	c [mm]	📦
56622	3.0	13	59	100	24/240
56623	4.0	13	76	150	24/192
56624	5.0	14	76	150	24/192
56625	6.0	14	76	150	24/192

EN T-handle hex key set with ball  
 PL Zestaw kluczy sześciokątnych typu "T" z kulką  
 DE T-Griff Sechskant Stiftschlüsselsatz mit Kugel  
 RU Набор ключей Hex с T-образной рукояткой  
 CZ Sada imbusů s kulíčkou a "T" rukojetí  
 RO Set chei hexagonale cu bila Tip "T"  
 HU Imbuskulcs T-markolattal készlet  
 ES Juego de llaves Allen con mango en "T"

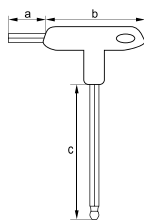

**VOREL**

No.	⊙ [mm]	a [mm]	b [mm]	c [mm]	pcs / szt.	📦
56629	2.5, 3, 4, 5, 6, 7, 8, 10	12, 13, 13, 14, 14, 16, 18, 20	59, 59, 76, 76, 76, 95, 95	100, 100, 150, 150, 150, 200, 200	8	12/24

EN T-handle Torx key  
 PL Klucz Torx typu "T"  
 DE T-Griff Torx-Schlüssel  
 RU Ключ Torx T-образный с рукояткой  
 CZ Torx klíč s T-rukojetí  
 RO Cheie Torx tip "T"  
 HU Torx kulcs T-markolattal  
 ES Torx llave en forma de "T" con un mango

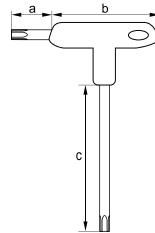
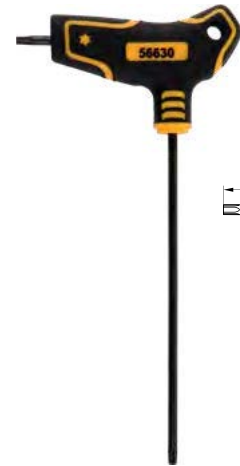

**VOREL**

No.	⊙	a [mm]	b [mm]	c [mm]	📦
56630	T10	10	59	100	24/240
56631	T15	12	59	100	24/240
56632	T20	13	59	100	24/192
56633	T25	13	76	150	24/192
56634	T27	14	76	150	24/192
56635	T30	14	76	150	24/192

EN T-handle Torx key set  
 PL Zestaw kluczy Torx typu "T"  
 DE T-Griff Torx-Schlüssel-Satz  
 RU Набор ключей Torx с T-образной рукояткой  
 CZ Klíče typ "T" Torx sada  
 RO Set chei Torx tip "T"  
 HU T-nyelű Torx kulcs készlet  
 ES T-tipo llave Torx set

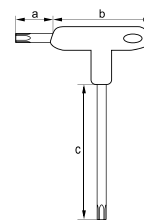

**VOREL**

No.	⊙	a [mm]	b [mm]	c [mm]	pcs / szt.	📦
56639	T10, T15, T20, T25, T27, T30, T40, T45, T50	10, 12, 13, 13, 14, 14, 16, 18, 20	59, 59, 59, 76, 76, 76, 95, 95	100, 100, 100, 150, 150, 150, 200, 200	9	12/24

- EN Hex key
- PL Klucz sześciokątny
- DE Sechskant-Stiftschlüssel
- RU Шестигранный
- CZ Imbusový klíč
- RO Cheie imbus
- HU Imbisz kulcs
- ES Llave hexagonal

3



No.	⌀ [mm]	
56040	4	1000/2000
56050	5	400/800
56060	6	400/800
56070	7	300/600
56080	8	200/400
56100	10	100/200
56120	12	50/100
56130	13	50/100
56140	14	50/100
56170	17	25/50

- EN Hex key set
- PL Zestaw kluczy imbusowych
- DE Sechskant-Stiftschlüsselsatz
- RU Набор шестигранных
- CZ Imbusové klíče
- RO Cheie imbus
- HU Imbisz kulcs
- ES Juego de llaves Hex



No.	⌀ [mm]	pcs / szt.	
56380	2, 2.5, 3, 4, 5, 6, 8, 10	8	20/100
56390	1.5, 2, 2.5, 3, 4, 5, 6, 7, 8, 10	10	20/100

- EN Hex key set
- PL Zestaw kluczy imbusowych
- DE Sechskant-Stiftschlüsselsatz
- RU Набор шестигранных
- CZ Imbusové klíče
- RO Cheie imbus
- HU Imbisz kulcs
- ES Juego de llaves Hex



**VOREL**

No.	⌀ [mm]	pcs / szt.	
56391	1.5, 2, 2.5, 3, 3.5, 4, 5, 6, 8, 10	10	20/100
56392	2, 2.5, 3, 4, 5, 6, 8, 10	8	20/100

- EN Hex key set
- PL Zestaw kluczy imbusowych
- DE Sechskant-Stiftschlüsselsatz
- RU Набор шестигранных
- CZ Imbusové klíče
- RO Cheie imbus
- HU Imbisz kulcs
- ES Juego de llaves Hex



**VOREL**

No.	⌀ [mm]	pcs / szt.	
56393	1.5, 2, 2.5, 3, 4, 5, 5.5, 6, 8, 10	10	10/60

- EN Hex key set
- PL Zestaw kluczy imbusowych
- DE Sechskant-Stiftschlüsselsatz
- RU Набор шестигранных
- CZ Imbusové klíče
- RO Cheie imbus
- HU Imbisz kulcs
- ES Juego de llaves Hex



No.	⌀ [mm]	pcs / szt.	
56400	2, 2.5, 3, 4, 5, 6, 8, 10, 12, 14	10	20/40

- EN Hex key set
- PL Zestaw kluczy imbusowych
- DE Sechskant-Stiftschlüsselsatz
- RU Набор шестигранных
- CZ Imbusové klíče
- RO Cheie imbus
- HU Imbisz kulcs
- ES Juego de llaves Hex

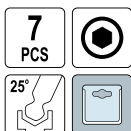

No.	⌀ [mm]	pcs / szt.	
56470	2.5, 3, 4, 5, 6, 8, 10	7	20/40

- EN Hex key set
- PL Zestaw kluczy imbusowych
- DE Sechskant-Stiftschlüsselsatz
- RU Набор шестигранных
- CZ Imbusové klíče
- RO Cheie imbus
- HU Imbisz kulcs
- ES Juego de llaves Hex



**VOREL**

No.	⌀ [mm]	pcs / szt.	
56473	1.5, 2, 2.5, 3, 4, 5, 6, 8	8	10/60

EN Hex key set  
 PL Zestaw kluczy imbusowych  
 DE Sechskant-Stiftschlüsselsatz  
 RU Набор шестигранников  
 CZ Imbusové klíče  
 RO Chei imbus  
 HU Imbisz kulcs  
 ES Juego de llaves Hex

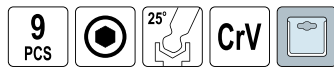

No.	⌀ [mm]	pcs / szt.	📦
56475	2.5, 3, 4, 5, 5.5, 6, 7, 8, 10	9	10/60

EN Hex key set  
 PL Zestaw kluczy imbusowych  
 DE Sechskant-Stiftschlüsselsatz  
 RU Набор шестигранников  
 CZ Imbusové klíče  
 RO Chei imbus  
 HU Imbisz kulcs  
 ES Juego de llaves Hex

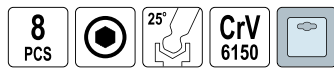

No.	⌀ [mm]	pcs / szt.	📦
56505	1.5, 2, 2.5, 3, 4, 5, 6, 8	8	25/100

EN Torx key set  
 PL Zestaw kluczy Torx  
 DE Torx Schlüsselsatz  
 RU Набор ключи Torx  
 CZ Souprava klíčů Torx  
 RO Set de chei Torx  
 HU Kulcskészlet Torx  
 ES Juego de llaves Torx



No.	⌀	pcs / szt.	📦
56478	T10, T15, T20, T25, T27, T30, T40, T45, T50	9	20/40

EN Torx key set  
 PL Zestaw kluczy Torx  
 DE Torx Schlüsselsatz  
 RU Набор ключи Torx  
 CZ Souprava klíčů Torx  
 RO Set de chei Torx  
 HU Kulcskészlet Torx  
 ES Juego de llaves Torx



No.	⌀	pcs / szt.	📦
56507	T9, T10, T15, T20, T25, T27, T30, T40	8	25/100

EN Hex key set  
 PL Zestaw kluczy imbusowych  
 DE Sechskant-Stiftschlüsselsatz  
 RU Набор шестигранников  
 CZ Imbusové klíče  
 RO Chei imbus  
 HU Imbisz kulcs  
 ES Juego de llaves Hex



No.	⌀ [mm]	pcs / szt.	📦
56477	2, 2.5, 3, 4, 5, 5.5, 6, 8, 10	9	10/60

EN Hex key set  
 PL Zestaw kluczy imbusowych  
 DE Sechskant-Stiftschlüsselsatz  
 RU Набор шестигранников  
 CZ Imbusové klíče  
 RO Chei imbus  
 HU Imbisz kulcs  
 ES Juego de llaves Hex



No.	⌀ [mm]	pcs / szt.	📦
56506	1.5, 2, 2.5, 3, 4, 5, 6, 8	8	25/100

EN Torx key set  
 PL Zestaw kluczy Torx  
 DE Torx Schlüsselsatz  
 RU Набор ключи Torx  
 CZ Souprava klíčů Torx  
 RO Set de chei Torx  
 HU Kulcskészlet Torx  
 ES Juego de llaves Torx



No.	⌀	pcs / szt.	📦
56600	T10, T15, T20, T25, T27, T30, T40	8	50/100





4

Pliers  
Szczypce

CURRENT  
PRĄD max 160 A

VORTEX

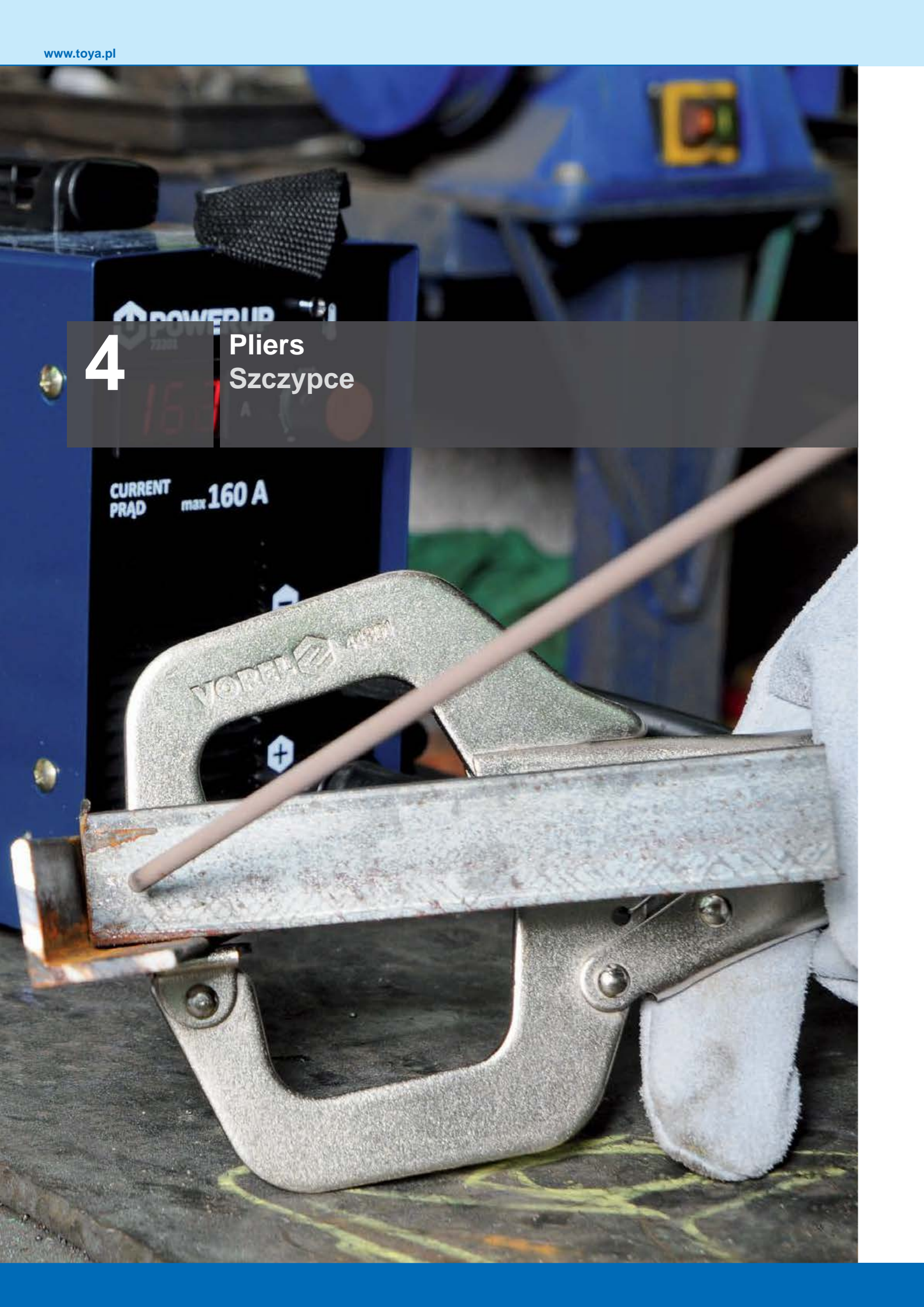

### Pliers, heavy duty blue handle Szczypce, uchwyty niebieski



44

#### Combination pliers

Szczypce uniwersalne..... 44

#### Side cutting pliers

Szczypce tnące, boczne..... 44

#### Long nose pliers

Szczypce wydłużone, proste..... 44

#### Bent nose pliers

Szczypce wydłużone, wygięte..... 44

### Pliers, 2 colour handle Szczypce, dwukolorowa rączka



44-45

#### Combination pliers

Szczypce uniwersalne..... 44

#### Side cutting pliers

Szczypce tnące, boczne..... 44

#### Long nose pliers

Szczypce wydłużone, proste..... 44

#### Bent nose pliers

Szczypce wydłużone, wygięte..... 44

#### Round nose pliers

Szczypce okrągłe..... 45

#### Wire stripping pliers

Szczypce do ściągania izolacji..... 45

#### End cutting pliers

Szczypce tnące, czołowe..... 45

#### Water pump pliers

Szczypce nastawne..... 45

### Chrome plated pliers Szczypce chromowane



45

#### Water pump pliers

Szczypce nastawne..... 45

### Pincers & pliers Szczypce i obcęgi



45

#### End cutting pliers

Szczypce tnące, czołowe..... 45

#### Carpenter's pincers

Obcęgi..... 45

#### Tower pincers

Szczypce tynkarskie..... 45

### Pliers „Juco” Szczypce „Juco”

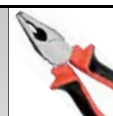

46

#### Combination pliers

Szczypce uniwersalne..... 46

#### Side cutting pliers

Szczypce tnące, boczne..... 46

### Mini pliers Szczypce „Mini”



46-47

#### Combination pliers

Szczypce uniwersalne..... 46

#### Side cutting pliers

Szczypce tnące, boczne..... 46

#### Long nose pliers

Szczypce wydłużone, proste..... 46

#### Bent nose pliers

Szczypce wydłużone, wygięte..... 46

#### Flat nose pliers

Szczypce płaskie..... 46

#### Round nose pliers

Szczypce okrągłe..... 47

#### End cutting pliers

Szczypce tnące, czołowe..... 47

#### Mini pliers sets

Zestawy szczypiec „Mini”..... 47

### Circlip pliers Szczypce Segera

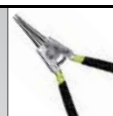

47-48

### Lock grip pliers & sets Szczypce zaciskowe i zestawy



48-49

EN Combination pliers  
 PL Szczypce uniwersalne  
 DE Kombinationszange  
 RU Плоскогубцы универсальные  
 CZ Univerzální kleště  
 RO Patent universal  
 HU Kombináltfogó  
 ES Alicates universal



**VOREL**

No.	L [mm]	
40010	160	6/60
40011	180	6/60
40012	200	6/60

EN Long nose pliers  
 PL Szczypce wydłużone proste  
 DE Radiozange  
 RU Тонкогубцы  
 CZ Prodloužené kleště rovné  
 RO Patent drept alungit  
 HU Rádiófogó, egyenes  
 ES Alicates de punta



**VOREL**

No.	L [mm]	
40013	160	6/120
40014	200	6/60

EN Combination pliers  
 PL Szczypce uniwersalne  
 DE Kombinationszange  
 RU Плоскогубцы универсальные  
 CZ Univerzální kleště  
 RO Patent universal  
 HU Kombináltfogó  
 ES Alicates universal



**VOREL**

No.	L [mm]	
40041	160	6/60
40042	180	6/60
40043	200	6/60

EN Long nose pliers  
 PL Szczypce wydłużone proste  
 DE Radiozange  
 RU Тонкогубцы  
 CZ Prodloužené kleště rovné  
 RO Patent drept alungit  
 HU Rádiófogó, egyenes  
 ES Alicates de punta



**VOREL**

No.	L [mm]	
40044	160	6/120
40045	180	6/60

EN Diagonal side cutting pliers  
 PL Szczypce tnące boczne  
 DE Seitenschneider  
 RU Бокорезы  
 CZ Řezací kleště boční  
 RO Patent de tăiat lateral  
 HU Oldal csípőfogó  
 ES Alicates corte lateral



**VOREL**

No.	L [mm]	
40017	160	6/60
40018	180	6/60

EN Bent nose pliers  
 PL Szczypce wydłużone wygięte  
 DE Telefonzange  
 RU Тонкогубцы изогнутые  
 CZ Prodloužené kleště ohnuté  
 RO Patent curbă alungit  
 HU Rádió- és telefonfogó, hajlított  
 ES Alicates curvos



**VOREL**

No.	L [mm]	
40015	160	6/120
40016	200	6/60

EN Diagonal side cutting pliers  
 PL Szczypce tnące boczne  
 DE Seitenschneider  
 RU Бокорезы  
 CZ Řezací kleště boční  
 RO Patent de tăiat lateral  
 HU Oldal csípőfogó  
 ES Alicates corte lateral



**VOREL**

No.	L [mm]	
40047	160	6/120
40048	180	6/60

EN Bent nose pliers  
 PL Szczypce wydłużone wygięte  
 DE Telefonzange  
 RU Тонкогубцы изогнутые  
 CZ Prodloužené kleště ohnuté  
 RO Patent curbă alungit  
 HU Rádió- és telefonfogó, hajlított  
 ES Alicates curvos



**VOREL**

No.	L [mm]	
40050	160	6/120
40051	180	6/60



EN Round nose pliers  
 PL Szczypce okrągłe  
 DE Rundzange  
 RU Крунгоубы  
 CZ Kruhové kleště  
 RO Patent rotund  
 HU Kerekcsőrű fogó  
 ES Alicates redondos

160 mm



VOREL

No.	L [mm]	
40054	160	6/120

EN End cutting pliers  
 PL Szczypce tnące czołowe  
 DE Vornsneider  
 RU Кусачки торцевые  
 CZ Kleště štípačí čelní  
 RO Cleste retezat  
 HU Homlokcsípő fogó  
 ES Cortacables frontales

160 mm



VOREL

No.	L [mm]	
40055	160	6/60

EN Water pump pliers  
 PL Szczypce nastawne  
 DE Wasserpumpenzange  
 RU Клещи переставные  
 CZ Nastavitelné kleště  
 RO Cleste papagal  
 HU Állítható fogó  
 ES Tenaza ajustable

250 mm



No.	L [mm]	
41500	250	6/60

EN Carpenter's pincers  
 PL Obcegi  
 DE Kneifzange  
 RU Клещи строительные  
 CZ Kleště  
 RO Cleste cuie  
 HU Harapófogó  
 ES Tenazas

X



VOREL

No.	L [mm]	
41151	180	6/60
41152	200	6/60

EN Wire stripping pliers  
 PL Szczypce do ściągania izolacji  
 DE Abisolierzange  
 RU Клещи для снятия изоляции  
 CZ Kleště na sundávání izolace  
 RO Patent pt. decablat  
 HU Szigeteleléstávolító fogó  
 ES Pinzas pelacables

160 mm



VOREL

No.	L [mm]	
40056	160	6/60

EN Water pump pliers  
 PL Szczypce nastawne  
 DE Wasserpumpenzange  
 RU Клещи переставные  
 CZ Nastavitelné kleště  
 RO Cleste papagal  
 HU Állítható fogó  
 ES Tenaza ajustable

250 mm



VOREL

No.	L [mm]	
40057	250	6/60

EN End cutting pliers  
 PL Szczypce tnące czołowe  
 DE Vornsneider  
 RU Кусачки торцевые  
 CZ Kleště štípačí čelní  
 RO Cleste retezat  
 HU Homlokcsípő fogó  
 ES Cortacables frontales

180 mm



VOREL

No.	L [mm]	
41121	180	6/60

EN Tower pincers  
 PL Obcegi tynkarskie  
 DE Beisszange  
 RU Клещи штукатурные  
 CZ Kleště štípačí čelní  
 RO Cleste pt. cuie  
 HU Rablitzfogó  
 ES Tenazas de enlucido

250 mm



VOREL

No.	L [mm]	
41381	250	6/60

EN Combination pliers  
 PL Szczypce uniwersalne  
 DE Kombinationszange  
 RU Плоскогубцы универсальные  
 CZ Univerzální kleště  
 RO Patent universal  
 HU Kombináltfogó  
 ES Alicates universal

1000 V



JUKO

No.	L [mm]	Voltage / Napięcie [V]	
40160	160	1000	10/50
40180	180	1000	10/50
40200	200	1000	10/50

EN Combination pliers  
 PL Szczypce uniwersalne  
 DE Kombinationszange  
 RU Плоскогубцы универсальные  
 CZ Univerzální kleště  
 RO Patent universal  
 HU Kombináltfogó  
 ES Alicates universal

120 mm



VOREL

No.	L [mm]	
42300	120	12/120

EN Long nose pliers  
 PL Szczypce wydłużone proste  
 DE Radiozange  
 RU Тонкогубцы  
 CZ Prodloužené kleště rovné  
 RO Patent drept alungit  
 HU Rádiófogó, egyenes  
 ES Alicates de punta

125 mm



VOREL

No.	L [mm]	
42303	125	12/120

EN Bent nose pliers  
 PL Szczypce wydłużone wygięte  
 DE Telefonzange  
 RU Тонкогубцы изогнутые  
 CZ Prodloužené kleště ohnuté  
 RO Patent curbat alungit  
 HU Rádió- és telefonfogó hajlított  
 ES Alicates curvos

125 mm



VOREL

No.	L [mm]	
42304	125	12/120

EN Diagonal side cutting pliers  
 PL Szczypce tnące boczne  
 DE Seitenschneider  
 RU Бокорезы  
 CZ Řezací kleště boční  
 RO Patent de tăiat lateral  
 HU Oldal csípőfogó  
 ES Alicates corte lateral

160 mm 1000 V



JUKO

No.	L [mm]	Voltage / Napięcie [V]	
40700	160	1000	10/10

EN Diagonal side cutting pliers  
 PL Szczypce tnące boczne  
 DE Seitenschneider  
 RU Бокорезы  
 CZ Řezací kleště boční  
 RO Patent de tăiat lateral  
 HU Oldal csípőfogó  
 ES Alicates corte lateral

110 mm



VOREL

No.	L [mm]	
42301	110	12/120

EN Long nose pliers  
 PL Szczypce wydłużone proste  
 DE Radiozange  
 RU Тонкогубцы  
 CZ Prodloužené kleště rovné  
 RO Patent drept alungit  
 HU Rádiófogó, egyenes  
 ES Alicates de punta

150 mm



VOREL

No.	L [mm]	
42305	150	12/120

EN Flat nose pliers  
 PL Szczypce płaskie  
 DE Flachzange  
 RU Плоскогубцы удлиненные  
 CZ Kleště ploché  
 RO Clește cu vârf ascuțit  
 HU Rádiófogó, egyenes  
 ES Alicates de bocas planas

120 mm



VOREL

No.	L [mm]	
42306	120	12/120

EN Round nose pliers  
 PL Szczypce okrągłe  
 DE Rundzange  
 RU Круглогубцы  
 CZ Kruhové kleště  
 RO Patent rotund  
 HU Kerekcsőrű fogó  
 ES Alicates redondos

125 mm 



No.	L [mm]	
42307	125	12/120

EN Mini pliers set  
 PL Zestaw miniszczypiec  
 DE Mini-Zangensatz  
 RU Пассатижи в наборе  
 CZ Elektronické kleště  
 RO Set mini patenti  
 HU Elektronikai fogó  
 ES Alicates electronicas

4 PCS 



No.	pcs / szt.	
42308	4	25/150

EN Circlip pliers, external straight  
 PL Szczypce Segera zewnętrzne proste  
 DE Seegeringzange aussen gerade  
 RU Съёмник стопорных колец (разжим)

CZ Kleště Segera vnější rovné  
 RO Clește Seger exterior drept  
 HU Segerfogó külső, egyenes  
 ES Alicates Seger exteriores de punta



No.	L [mm]	
43050	160	6/60
43055	180	6/60
43060	200	6/60

EN Circlip pliers, internal straight  
 PL Szczypce Segera wewnętrzne proste  
 DE Seegeringzange innen gerade  
 RU Съёмник стопорных колец (сжим)

CZ Kleště Segera vnitřní rovné  
 RO Clește Seger interior drept  
 HU Segerfogó belső, egyenes  
 ES Alicates Seger interiores de punta



No.	L [mm]	
43052	160	6/60
43057	180	6/60
43062	200	6/60

EN End cutting pliers  
 PL Szczypce tnące czolowe  
 DE Vornscheider  
 RU Кусачки торцевые  
 CZ Kleště štípači čelní  
 RO Clește retezat  
 HU Homlokcsípő fogó  
 ES Cortacables frontales

110 mm 



No.	L [mm]	
42302	110	12/120

EN Mini pliers set  
 PL Zestaw miniszczypiec  
 DE Mini-Zangensatz  
 RU Пассатижи в наборе  
 CZ Elektronické kleště  
 RO Set mini patenti  
 HU Elektronikai fogó  
 ES Alicates electronicas

6 PCS 



No.	pcs / szt.	
42309	6	4/40

EN Circlip pliers, external bent  
 PL Szczypce Segera zewnętrzne wygięte  
 DE Seegeringzange aussen gebogen  
 RU Съёмник стопорных колец (разжим)

CZ Kleště Segera vnější ohnuté  
 RO Clește Seger exterior curbat  
 HU Segerfogó külső, hajlított  
 ES Alicates Seger exteriores curvos



No.	L [mm]	
43051	160	6/60
43056	180	6/60
43061	200	6/60

EN Circlip pliers, internal bent  
 PL Szczypce Segera wewnętrzne wygięte  
 DE Seegeringzange innen gebogen  
 RU Съёмник стопорных колец (сжим)

CZ Kleště Segera vnitřní ohnuté  
 RO Patent Seger interior curbat  
 HU Segerfogó belső, hajlított  
 ES Alicates Seger interiores curvos



No.	L [mm]	
43053	160	6/60
43058	180	6/60
43063	200	6/60



- EN Circlip pliers
- PL Szczypce Segera
- DE Seegering-Zange
- RU Съёмник стопорных колец
- CZ Kleště na pojistné kroužky
- RO Clește Seger
- HU Seegerfogó
- ES Alicates Seger

5 PCS 150 mm 



No.	L [mm]	pcs / szt.	
43510	150	5	12/60

- EN Lock grip pliers
- PL Szczypce Morse'a
- DE Gripzange
- RU Зажим ручной
- CZ Kleště Morse'a
- RO Clește Morse
- HU Morse fogó
- ES Alicates Morse

250 mm 



No.	L [mm]	
44102	250	6/60

- EN Lock grip pliers
- PL Szczypce spawalnicze
- DE Schweisserzange
- RU Клещи зажимные сварочные
- CZ Svářečské kleště
- RO Clește autoblocant pt. sudura
- HU Hegesztő fogó
- ES Alicates de soldar

0-70 mm 275 mm  
C TYPE 



No.	L [mm]	Type / Typ	
44300	275	C	6/36

- EN Welding locking pliers „C” type
- PL Szczypce zaciskowe klamrowe typu „C”
- DE Klemm- und Klammerzange vom Typ „C”
- RU Клещи зажимные сварочные
- CZ Kleště samosvorné upínací typu „C”
- RO Clește de strângere cu clemă tip „C”
- HU „C” fogó
- ES Pinzas de tornillo (de apriete) de grapa tipo „C”



**VOREL**

No.	L [mm]	Type / Typ	
44301	280	C	5/30



- EN Lock grip pliers
- PL Szczypce Morse'a
- DE Gripzange
- RU Зажим ручной
- CZ Kleště Morse'a
- RO Clește Morse
- HU Morse fogó
- ES Alicates Morse

250 mm 





No.	L [mm]	
44100	250	6/60

- EN Locking pliers set
- PL Zestaw szczypiec Morse'a
- DE Gripzangen-Set
- RU Набор клещей Морса
- CZ Sada kleští siko
- RO Set clești autoblocanti
- HU Morse fogókészlet
- ES Juego de pinzas morsa

4 PCS HRC 45-48 



 L=140, 165, 225 mm;  
 L=180 mm



No.	L [mm]	pcs / szt.	
44110	140, 165, 185, 225	4	5/20

0-70 mm 280 mm  
C TYPE 

EN Lock grip pliers  
 PL Szczypce spawalnicze  
 DE Schweisserzange  
 RU Клещи зажимные сварочные  
 CZ Svářecské kleště  
 RO Cleste autoblocant pt. sudura  
 HU Hegesztő fogó  
 ES Alicates de soldar



No.	L [mm]	Type / Typ	
44400	225	U	6/36

EN Lock grip pliers  
 PL Szczypce spawalnicze  
 DE Schweisserzange  
 RU Клещи зажимные сварочные  
 CZ Svářecské kleště  
 RO Cleste autoblocant pt. sudura  
 HU Hegesztő fogó  
 ES Alicates de soldar

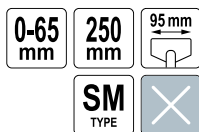

No.	L [mm]	Type / Typ	
44500	250	SM	6/36

EN Mini locking pliers set  
 PL Zestaw szczypiec spawalniczych mini  
 DE Mini-Schweißzangen-Satz  
 RU Набор сварочных мини-клещей  
 CZ Sada svařovacích kleští mini  
 RO Set mini clești autoblocanti  
 HU Mini testcsipesz készlet  
 ES Juego de mini pinzas para soldar

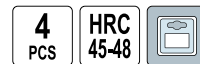

L=110 mm; L=125 mm; L=130 mm (2 PCS)



No.	L [mm]	pcs / szt.	
44330	110, 125, 130, 130	4	6/24

Memo

# 5

## Electrician tools Narzędzia dla elektryków

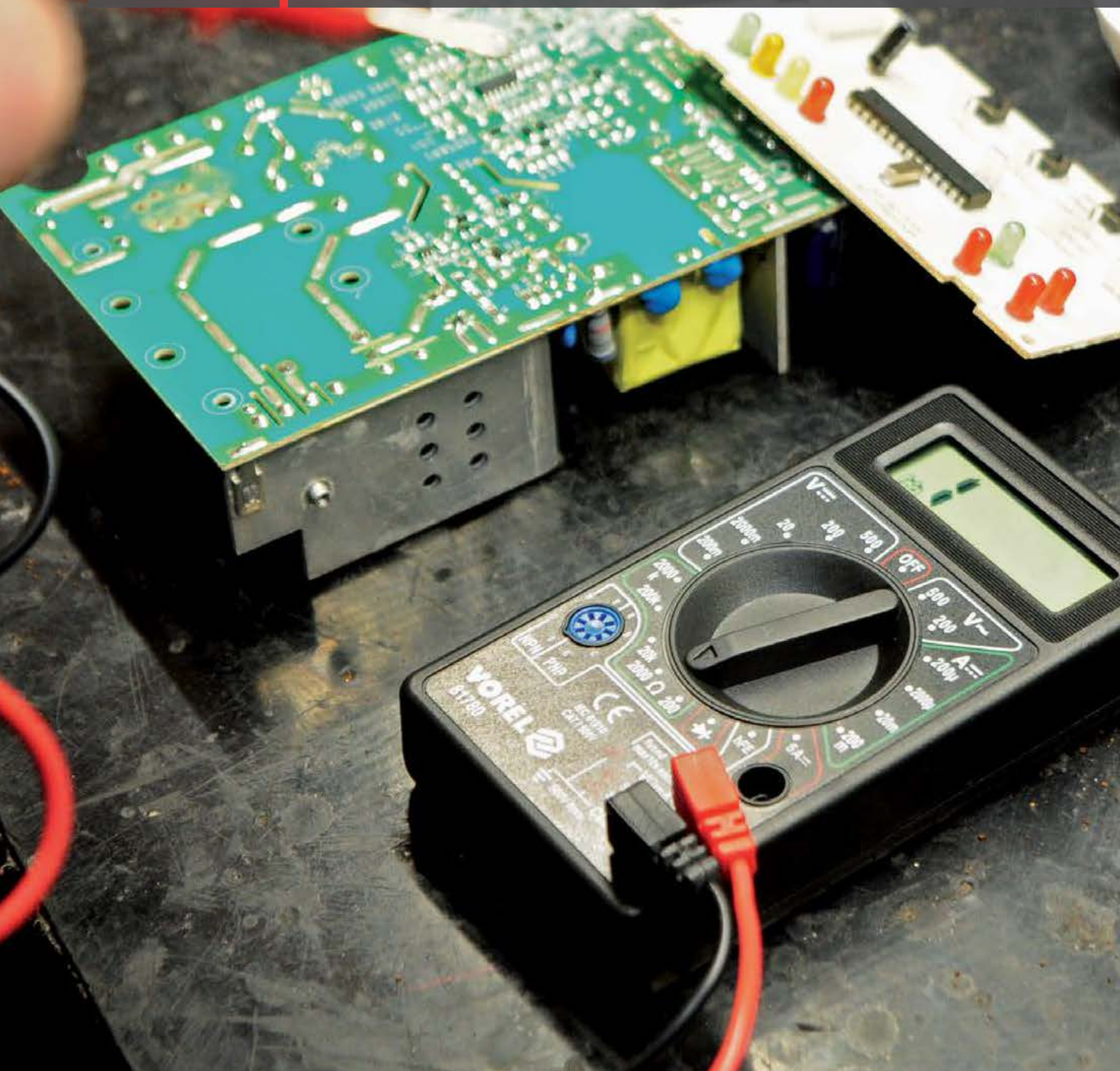



**Crimping pliers**  
 Szczypce do zaciskania  
 konektorów

52



**Wire strippers**  
 Ściągacze izolacji

53



**Electrical cutters**  
 Obcinaki elektryczne

53-54



**Voltage testers**  
 Próbniki napięcia

54



**Digital universal meters**  
 Cyfrowe mierniki uniwersalne

54-55



- EN Ratchet crimping pliers
- PL Szczypce do zaciskania konektorów
- DE Kabelschuhzange
- RU Клещи для опрессовки наконечников
- CZ Kleště pro svěření zaciskania konektorů
- RO Clește sertizat conectori
- HU Krimpelő fogó
- ES Pinzas de apretar de conectores

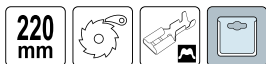

No.	mm <sup>2</sup>	AWG	
45500	0.5-2.5	20-14	12/36

- EN Ratchet crimping pliers
- PL Szczypce do zaciskania konektorów
- DE Kabelschuhzange
- RU Клещи для опрессовки наконечников
- CZ Kleště pro svěření zaciskania konektorů
- RO Clește sertizat conectori
- HU Krimpelő fogó
- ES Pinzas de apretar de conectores

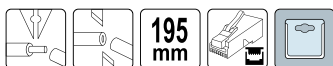

No.	RJ	
45504	RJ45, RJ10, RJ11, 8P, 4P	10/50

- EN Multifunctional pliers with connectors
- PL Szczypce wielofunkcyjne z konektorami
- DE Multifunktionszange mit Kabelschuhe
- RU Клещи многофункциональные для снятия изоляции с наконечниками
- CZ Multifunkční kleště s konektory
- RO Clește multifunctional pt. sertizat cu conectori
- HU Multifunkciós fogó csatlakozókkal
- ES Alicates multifuncionales con conectores

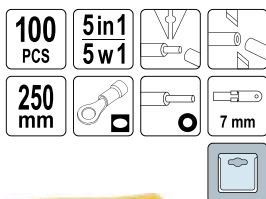

No.	mm <sup>2</sup>	AWG	mm <sup>2</sup>	AWG	pcs / szt.	
45050	1.5-6.0	22-10	1.5-6.0	22-10	100	25/50

- EN Ratchet crimping pliers
- PL Szczypce do zaciskania konektorów
- DE Kabelschuhzange
- RU Клещи для опрессовки наконечников
- CZ Kleště pro svěření zaciskania konektorů
- RO Clește sertizat conectori
- HU Krimpelő fogó
- ES Pinzas de apretar de conectores

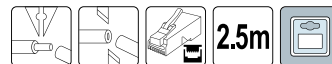

No.	RJ	
45503	RJ45, RJ11	10/40

- EN Multifunctional pliers
- PL Szczypce wielofunkcyjne
- DE Multifunktionszange
- RU Клещи многофункциональные для снятия изоляции
- CZ Multifunkční kleště
- RO Clește multifunctional pt. sertizat
- HU Multifunkciós fogó
- ES Alicates multifuncionales

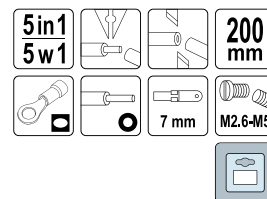

No.	mm <sup>2</sup>	AWG	mm <sup>2</sup>	AWG	
45000	1.5-6.0	22-10	0.75-6.0	22-10	12/120

- EN Multifunctional pliers
- PL Szczypce wielofunkcyjne
- DE Multifunktionszange
- RU Клещи многофункциональные для снятия изоляции
- CZ Multifunkční kleště
- RO Clește multifunctional pt. sertizat
- HU Multifunkciós fogó
- ES Alicates multifuncionales

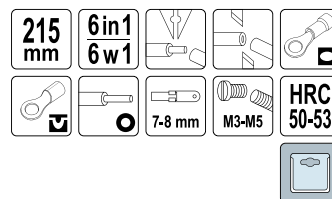

No.	mm <sup>2</sup>	AWG	mm <sup>2</sup>	AWG	mm <sup>2</sup>	AWG	
45012	0.64-2.6	26-10	0.8-2.6	22-10	0.64-2.6	26-10	12/72

EN Wire stripper  
 PL Ściągacz izolacji  
 DE Abisolierzange  
 RU Съёмник изоляции  
 CZ Odizolovací klejte  
 RO Decablator  
 HU Blankolo fogo  
 ES Extractor de aislado

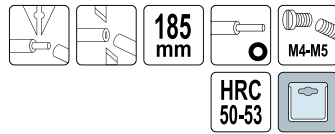

No.	mm <sup>2</sup>	AWG	
45010	0.8-2.6	20-10	12/120

EN Wire stripper / crimper  
 PL Automacyjny ściągacz izolacji  
 DE Automatische Abisolierzange  
 RU Клещи для удаления изоляции  
 CZ Automatický stahovač izolace  
 RO Clește automat desizolat  
 HU Automatikus szigeteléselhúzó  
 ES Pelacables automatico



No.	mm <sup>2</sup>	AWG	
45151	1.0-3.2	17-12	10/40

EN Automatic wire stripper with cutter  
 PL Automacyjny ściągacz z obcinakiem  
 DE Automatische Abisolierzange + Schneider  
 RU Клещи-автомат для снятия изоляции  
 CZ Automatický stahovač izolace  
 RO Decablator automat  
 HU Automatikus szigeteléselhúzó  
 ES Pelacables automatico

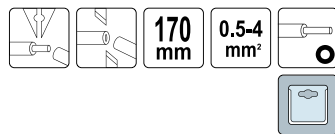

No.	mm <sup>2</sup>	AWG	
45201	0.5-4.0	20-13	10/50

EN Wire stripper / crimper  
 PL Automacyjny ściągacz izolacji  
 DE Automatische Abisolierzange  
 RU Клещи для удаления изоляции  
 CZ Automatický stahovač izolace  
 RO Clește automat desizolat  
 HU Automatikus szigeteléselhúzó  
 ES Pelacables automatico



No.	mm <sup>2</sup>	AWG	
45100	0.5-6.0	20-10	20/100

EN Universal wire stripper  
 PL Uniwersalny ściągacz izolacji  
 DE Universal Abisolierzange  
 RU Универсальный съёмник изоляции  
 CZ Univerzální odizolovací kleště  
 RO Decablator universal  
 HU Blankolo fogo  
 ES Extractor de aislado universal

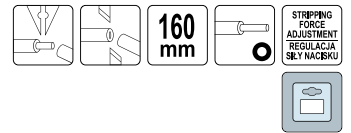

No.	mm <sup>2</sup>	AWG	
45160	0.25	30	10/40

EN Electrical cutter  
 PL Obcinak elektryczny  
 DE Seitenschneider  
 RU Щипцы для резы проводов  
 CZ Elektrické prichovky ze stahovadlem  
 RO Clește tăietor electrician  
 HU Kábelvágó  
 ES Cortacables eléctricos



No.	L [mm]	
45020	135	12/120

5



EN Electrician scissors  
 PL Nożyczki dla elektryków  
 DE Elektrische Schere  
 RU Ножницы универсальные  
 CZ Elektrické nůžky  
 RO Foarfece - electrician  
 HU Univerzális olló  
 ES Tijeras eléctricos

140 mm SS2Cr13 PP



No.	L [mm]	
76320	140	12/120

EN Voltage tester  
 PL Próbnik napięcia  
 DE Spannungsprüfer  
 RU Отвёртка индикаторная  
 CZ Zkoušeč napětí  
 RO Creion de tensiune  
 HU Fáziskereső  
 ES Comprobador de corriente

190 mm 125-250 V~



No.	L [mm]	
65235	190	12/600

EN Digital universal multimeter  
 PL Cyfrowy miernik uniwersalny  
 DE Digital-Multimeter  
 RU Универсальный цифровой измеритель  
 CZ Digitální multimetr univerzální  
 RO Multimetru digital universal  
 HU Digitális multiméter  
 ES Manómetro digital universal

LCD 1999 0-500V A.C. 0-500V D.C. 0-5 A D.C. 0-2 MΩ h<sub>FE</sub> PNP NPN 9 V 6F22



No.	Digit height / Wysokość cyfr [mm]	
81780	12/72	

EN Voltage tester  
 PL Próbnik napięcia  
 DE Spannungsprüfer  
 RU Отвёртка индикаторная  
 CZ Zkoušeč napětí  
 RO Creion de tensiune  
 HU Fáziskereső  
 ES Comprobador de corriente

140 mm 125-250 V~



No.	L [mm]	
65233	140	12/1200

EN Digital universal multimeter  
 PL Cyfrowy miernik uniwersalny  
 DE Digital-Multimeter  
 RU Универсальный цифровой измеритель  
 CZ Digitální multimetr univerzální  
 RO Multimetru digital universal  
 HU Digitális multiméter  
 ES Manómetro digital universal

TRUE RMS LCD 5999 0-600V A.C. 0-600V D.C. 0-10 A A.C. 0-10 A D.C. 0-60 MΩ NCV AUTO RANGE AUTO ZAKRES DATA HOLD LED BACKLIGHT POŚWIETLENIE AUTO POWER OFF AUTOMATYCZNE WYŁĄCZANIE 2x AAA



No.		
81772		100

EN Digital universal multimeter  
 PL Cyfrowy miernik uniwersalny  
 DE Digital-Multimeter  
 RU Универсальный цифровой измеритель  
 CZ Digitální multimetr univerzální  
 RO Multimetru digital universal  
 HU Digitális multiméter  
 ES Manómetro digital universal

LCD 1999 0-600V A.C. 0-600V D.C. 0-10 A A.C. 0-10 A D.C. 0-200 MΩ 0-20 μF 0-20 kHz h<sub>FE</sub> PNP NPN DATA HOLD AUTO POWER OFF AUTOMATYCZNE WYŁĄCZANIE 9 V 6F22



No.	Digit height / Wysokość cyfr [mm]	
81783	25	20

EN Digital universal multimeter  
 PL Cyfrowy miernik uniwersalny  
 DE Digital-Multimeter  
 RU Универсальный цифровой измеритель  
 CZ Digitální multimetr univerzální  
 RO Multimetru digital universal  
 HU Digitális multiméter  
 ES Manómetro digital universal



LCD 1999	0-600V A.C.	0-600V D.C.
0-10 A A.C.	0-10 A D.C.	0-200 MΩ
0-20 μF	0-20 kHz	°C 40 + 400
h <sub>FE</sub> PNP NPN	⚡	⦿
AUTO POWER OFF AUTOMATYCZNE WYŁĄCZANIE	9 V 6F22!	📦



No.	Digit height / Wysokość cyfr [mm]	📦
81784	25	20

EN Digital universal multimeter  
 PL Cyfrowy miernik uniwersalny  
 DE Digital-Multimeter  
 RU Универсальный цифровой измеритель  
 CZ Digitální multimetr univerzální  
 RO Multimetru digital universal  
 HU Digitális multiméter  
 ES Manómetro digital universal



LCD 1999	0-750V A.C.	0-1000V D.C.
0-20 A A.C.	0-20 A D.C.	0-200 MΩ
0-200 μF	h <sub>FE</sub> PNP NPN	⚡
⦿	DATA HOLD	ADJUSTABLE DISPLAY REGULOWANY WYSWIETLACZ
AUTO POWER OFF AUTOMATYCZNE WYŁĄCZANIE	9 V 6F22!	📦



No.	📦
81775	40

EN Digital universal multimeter  
 PL Cyfrowy miernik uniwersalny  
 DE Digital-Multimeter  
 RU Универсальный цифровой измеритель  
 CZ Digitální multimetr univerzální  
 RO Multimetru digital universal  
 HU Digitális multiméter  
 ES Manómetro digital universal



LCD 1999	0-600V A.C.	0-600V D.C.
0-10 A D.C.	0-2 MΩ	h <sub>FE</sub> PNP NPN
⚡	⦿	DATA HOLD
LED BACKLIGHT POŚWIETLANIE	9 V 6F22!	📦



No.	📦
81773	50

EN Clamp universal multimeter  
 PL Cęgowy miernik uniwersalny  
 DE Universal Zangenamperemeter  
 RU Универсальный цифровой измеритель  
 CZ Digitální multimetr univerzální  
 RO Multimetru digital universal  
 HU Digitális multiméter  
 ES Manómetro digital universal



LCD 1999	0-450V A.C.
0-600V D.C.	0-400A A.C.
0-200 KΩ	⚡
⦿	DATA HOLD
2x AAA	📦



No.	📦
81801	5/60

Memo



# 6

## Hammers, chisels, punches & axes Młotki, dłuta, przecinaki i siekiery





## Machinist hammers Młotki ślusarskie



58-59

### Machinist hammers with wooden handle

Młotki ślusarskie z rączką drewnianą ..... 58

### Machinist hammers with fibreglass handle

Młotki ślusarskie z rączką z włókna szklanego ..... 58

### Machinist hammers „Juco”

Młotki ślusarskie „Juco” ..... 58

### Brick hammers „Juco”

Młotki murarskie „Juco” ..... 59

### Welder's hammers „Juco”

Młotki spawalnicze „Juco” ..... 59

## Stoning hammers Młotki kamieniarskie



59

### Stoning hammers „Juco”

Młotki kamieniarskie „Juco” ..... 59

## Hammers with tubular steel handle Młotki z trzonkiem rurowym



59-60

### Claw hammers

Młotki szewskie ..... 59

### Roofing hammers

Młotki ciesielskie ..... 60

### Mason's hammers

Młotki murarskie ..... 60

## Hammers with fibreglass handle Młotki z rączką z włókna szklanego



60

### Claw hammers

Młotki szewskie ..... 60

### Roofing hammers

Młotki ciesielskie ..... 60

## Rubber mallets Młotki gumowe



60-61

### Rubber mallets with wooden handle

Młotki gumowe z rączką drewnianą ..... 60

### Rubber mallets with tubular steel handle

Młotki gumowe z rączką stalową ..... 60

### Rubber mallets with fibreglass handle

Młotki gumowe z rączką z włókna szklanego ..... 61

### Soft faced mallets

Młotki blacharskie gumowo-plastykowe ..... 61

## Wooden mallets Młotki drewniane



61

## Chisels, cold chisels, punches & wrecking bars

### Dłuta, przecinaki, przebijaki i łomy



61-63

### Wood chisels with wooden handle

Dłuta stolarskie z rączką drewnianą ..... 61

### Wood chisels with plastic handle

Dłuta stolarskie z rączką z tworzywa ..... 61

### Curving chisels

Dłuta snycerskie ..... 62

### Cold chisels

Przecinaki ..... 62

### Cold chisels „Juco”

Przecinaki „Juco” ..... 62

### Punches

Przebijaki ..... 62

### Wrecking bars

Łomy ..... 63

### Wrecking bars „Juco”

Łomy „Juco” ..... 63

## Axes Siekiery



64-65

### Axes with wooden handle

Siekiery z trzonkiem drewnianym ..... 64

### Axes with fibreglass handle

Siekiery z trzonkiem z włókna szklanego ..... 64

### Axes „Juco”

Siekiery „Juco” ..... 64

### Hammer and axe wedges

Zestawy klinujące do młotków i siekier ..... 65

## Picaxes Kilofy



66

### Pickaxes

Kilofy ..... 66

### Wood splitters „Juco”

Kliny do rozłupywania drewna „Juco” ..... 66

EN Machinist hammer  
 PL Młotek ślusarski  
 DE Schlosserhammer  
 RU Молоток слесарный

CZ Zámečnické kladivo  
 RO Ciocan de lăcătușerie  
 HU Lakatos kalapács  
 ES Martillo de cerrajero



No.	m [g]	
30010	100	12/120
30020	200	12/72
30030	300	12/60
30040	400	6/48
30050	500	6/36
30060	600	6/36
30080	800	6/24
30100	1000	6/24
30150	1500	6/12
30200	2000	6/12

EN Machinist hammer  
 PL Młotek ślusarski  
 DE Schlosserhammer  
 RU Молоток слесарный

CZ Zámečnické kladivo  
 RO Ciocan de lăcătușerie  
 HU Lakatos kalapács  
 ES Martillo de cerrajero

DIN 1042



No.	m [kg]	
30531	3	1
30532	4	1
30533	5	1
30534	6	1
30535	8	1
30536	10	1

EN Machinist hammer monoblock  
 PL Młotek ślusarski monoblock  
 DE Schlosserhammer Monoblock  
 RU Молоток слесарный моноблок  
 CZ Zámečnické kladivo monoblock  
 RO Ciocan de lăcătușerie monobloc  
 HU Lakatos kalapács monoblock  
 ES Martillo de cerrajero monoblock



JUCO

No.	m [g]	
30220	300	5
30222	500	5
30224	800	5

EN Machinist hammer  
 PL Młotek ślusarski  
 DE Schlosserhammer  
 RU Молоток слесарный

CZ Zámečnické kladivo  
 RO Ciocan de lăcătușerie  
 HU Lakatos kalapács  
 ES Martillo de cerrajero



VOREL

No.	m [g]	
30410	100	6/120
30420	200	6/60
30430	300	6/60
30440	400	6/48
30450	500	6/36
30460	600	6/36
30480	800	6/24
30500	1000	6/24
30510	1500	6/12
30520	2000	6/12

EN Machinist hammer  
 PL Młotek ślusarski  
 DE Schlosserhammer  
 RU Молоток слесарный

CZ Zámečnické kladivo  
 RO Ciocan de lăcătușerie  
 HU Lakatos kalapács  
 ES Martillo de cerrajero



VOREL

No.	m [g]	
30310	100	6/120
30320	200	6/36
30330	300	6/36
30340	400	6/36
30350	500	6/36
30360	600	6/36
30380	800	6/24
30390	1000	6/24
30395	1500	6/12
30400	2000	6/12

EN Machinist hammer  
 PL Młotek ślusarski  
 DE Schlosserhammer  
 RU Молоток слесарный

CZ Zámečnické kladivo  
 RO Ciocan de lăcătușerie  
 HU Lakatos kalapács  
 ES Martillo de cerrajero

DIN 1041



JUCO

No.	m [g]	
31030	300	10
31050	500	10
31070	700	10
31100	1000	10
31150	1500	6
31200	2000	6

EN Machinist hammer  
PL Młotek ślusarski  
DE Schlosserhammer  
RU Молоток слесарный

CZ Zámečnické kladivo  
RO Ciocan de lăcătușerie  
HU Lakatos kalapács  
ES Martillo de cerrajero



**JUCO**

No.	m [g]	
31300	3000	1
31400	4000	1
31500	5000	1
31600	6000	1
31800	8000	1
32000	10000	1

EN Brick hammer  
PL Młotek murarski  
DE Maurerhammer  
RU Молоток каменщика  
CZ Kladivo zednické  
RO Ciocan de zidărie  
HU Kőműves kalapács  
ES Martillo de albañil



**JUCO**

No.	m [g]	
32720	700	5

EN Safety stoning hammer  
PL Młotek kamieniarski  
DE Fäustel  
RU Кувалда двухбубовая

CZ Palička kovová  
RO Ciocan pt. zidarie  
HU Kőtörő kalapács  
ES Martillo



**JUCO**

No.	m [g]	
32201	1500	6
32202	2000	6
32203	3000	1
32204	4000	1
32205	5000	1
32206	6000	1
32207	8000	1
32208	10000	1

EN Machinist hammer  
PL Młotek ślusarski  
DE Schlosserhammer  
RU Молоток слесарный

CZ Zámečnické kladivo  
RO Ciocan de lăcătușerie  
HU Lakatos kalapács  
ES Martillo de cerrajero



**JUCO**

No.	m [g]	
29992	300	5
29993	500	5
29994	700	5
29995	1000	5
29996	1500	5
29997	2000	5

EN Welder's hammer  
PL Młotek spawalniczy  
DE Schweisserhammer  
RU Молоток сварщика

CZ Svářečské kladívko  
RO Ciocan de sudură  
HU Hegesztő kalapács  
ES Martillo para soldar



**JUCO**

No.	m [g]	
32110	350	5

EN Claw hammer  
PL Młotek szewski  
DE Schusterhammer  
RU Молоток-гвоздодер  
CZ Kladivo obuvnické  
RO Ciocan pt. cizmărie  
HU Cipész kalapács  
ES Martillo carpintero



**VOREL**

No.	m [g]	
32625	600	6/24



EN Roofing hammer  
 PL Młotek ciesielski  
 DE Lattenhammer  
 RU Молоток кровельщика

CZ Tesařské kladivo  
 RO Ciocan de dulgherie  
 HU Ácskalapács  
 ES Martillo de carpintero



**VOREL**

No.	m [g]	
32685	600	6/24

EN Masonry hammer, type B  
 PL Młotek murarski berliński  
 DE Maurerhammer, Berliner Form  
 RU Молоток каменщика берлинский

CZ Kladivo zednické berlínské  
 RO Ciocan de zidărie tip Berlin  
 HU Kőműves kalapács Berliáni típusú  
 ES Martillo de albañil de Berlín



**VOREL**

No.	m [g]	
32705	600	6/24

EN Masonry hammer, type R  
 PL Młotek murarski reński  
 DE Maurerhammer, Rheinische Form  
 RU Молоток каменщика рейнский

CZ Kladivo zednické rýnské  
 RO Ciocan de zidărie tip Rin  
 HU Kőműves kalapács Rajnai típusú  
 ES Martillo de albañil de Rin



**VOREL**

No.	m [g]	
32715	600	6/24

EN Claw hammer  
 PL Młotek szewski  
 DE Schusterhammer  
 RU Молоток-гвоздодер  
 CZ Kladivo obuvnické  
 RO Ciocan pt. cizmărie  
 HU Cipész kalapács  
 ES Martillo carpintero



**VOREL**

No.	m [g]	
32627	600	6/24

EN Roofing hammer  
 PL Młotek ciesielski  
 DE Lattenhammer  
 RU Молоток кровельщика

CZ Tesařské kladivo  
 RO Ciocan de dulgherie  
 HU Ácskalapács  
 ES Martillo de carpintero



**VOREL**

No.	m [g]	
32687	600	6/24

EN Rubber mallet  
 PL Młotek gumowy  
 DE Gummihammer  
 RU Киянка резиновая

CZ Pryžové kladivo  
 RO Ciocan de cauciuc  
 HU Gumikalapács  
 ES Mazo de goma



No.	Head diameter / Šrednica obucha [mm]	
33550	45	36/72
33650	55	12/60
33900	70	12/24

EN Rubber mallet  
 PL Młotek gumowy  
 DE Gummihammer  
 RU Киянка резиновая

CZ Pryžové kladivo  
 RO Ciocan de cauciuc  
 HU Gumikalapács  
 ES Mazo de goma



**VOREL**

No.	Head diameter / Šrednica obucha [mm]	
33557	50	12/60
33657	56	12/48
33907	66	6/24

EN Rubber mallet  
 PL Młotek gumowy  
 DE Gummihammer  
 RU Киянка резиновая

CZ Pryžové kladivo  
 RO Ciocan de cauciuc  
 HU Gumikalapács  
 ES Mazo de goma



No.	Head diameter / Šířka obucha [mm]	
33535	45	12/48
33555	50	12/48
33655	56	6/30
33905	66	6/24
33925	76	6/18

EN Carpenter's wooden mallet  
 PL Młotek drewniany stolarski  
 DE Tischlerhammer aus Holz  
 RU Молоток деревянный столярный

CZ Palice dřevěná stolařská  
 RO Ciocan din lemn de tâmplar  
 HU Asztalos fakalapács  
 ES Martillo de madera de carpintero



No.	L [mm]	
33530	320	20

EN Wood chisel  
 PL Dłuto stolarskie  
 DE Stechbeitel  
 RU Стамеска по дереву  
 CZ Dláto tesářské  
 RO Daltă de tâmplărie  
 HU Asztalos véső  
 ES Cíncel para madera

65Mn



No.	Size / Rozmiar [mm]	
25510	6	5/60
25511	8	5/60
25512	10	5/60
25513	12	5/60
25514	14	5/60
25515	15	5/60
25516	18	5/60
25517	20	5/60
25518	22	5/60
25519	25	5/60
25520	32	5/60
25521	38	5/60

EN Soft face hammer  
 PL Młotek blacharski  
 DE Schonhammer  
 RU Молоток рихтовочный

CZ Palička klempířská  
 RO Ciocan pt. tabla  
 HU Bádógos kalapács  
 ES Martillo chapista

35 mm



No.	Head diameter / Šířka obucha [mm]	
33950	35	30/60

EN Wooden mallet  
 PL Młotek drewniany blacharski  
 DE Holzhammer für Bleche  
 RU Молоток жестящика, деревянный

CZ Palice dřevěná klempířská  
 RO Ciocan din lemn de tinichigiu  
 HU Bádógos fakalapács  
 ES Martillo de madera de hojalatero



No.	L [mm]	
33532	285	20

EN Wood chisel set  
 PL Zestaw dłut stolarskich  
 DE Stechbeitelsatz  
 RU Набор стамесок по дереву

CZ Sada tesářských dlát  
 RO Set dălji de tâmplărie  
 HU Asztalos véső készlet  
 ES Juego de cinceles para madera

4 PCS



No.	pcs / szt.	
25500	4	10/40

EN Wood chisel set  
 PL Zestaw dłut stolarskich  
 DE Stechbeitelsatz  
 RU Набор стамесок по дереву

CZ Sada tesářských dlát  
 RO Set dălji de tâmplărie  
 HU Asztalos véső készlet  
 ES Juego de cinceles para madera

4 PCS



No.	Size / Rozmiar [mm]	pcs / szt.	
25530	6, 12, 18, 24	4	10/40

- EN Wood carving chisel set
- PL Zestaw dłut snyoerskich
- DE Schnitzmeißel-Set
- RU Набор фигурных стамесок
- CZ Sada řezbářských dlát
- RO Set dălți pt. sculptură în lemn
- HU Falfaragó véső készlet
- ES Juego de cinceles para tallado de madera



6 PCS

6

No.	pcs / szt.	
25700	6	15/60

- EN Cold chisel with protection
- PL Przecinak z osłoną
- DE Schlitzmeißel mit Handschut
- RU Зубило с протектором
- CZ Ploché sekáč (z krytem)
- RO Daltă - tăietor plată (cu apărătoare)
- HU Hidegvágó, lapos (védőfejjel)
- ES Cincel plano (con protector)



**VOREL**

No.	W [mm]	L [mm]	
35351	25	300	12/36
35352	25	350	10/30
35353	25	400	12/24
35355	25	500	5/20

- EN Forged cold chisel
- PL Przecinak ślusarski
- DE Flachmeißel
- RU Зубило слесарное
- CZ Zámečnický sekáč
- RO Dalta forjată pt. metal
- HU Lakatos hidegvágó
- ES Cincel de cerrajería



**JUCO**

No.	Thickness / Grubość [mm]	W [mm]	L [mm]	m [kg]	
35372	10	20	200	0.25	10
35373	12	23	250	0.46	10
35374	12	23	300	0.53	10
35376	10	30	400	0.90	10

- EN Forged cold chisel with protection
- PL Przecinak murarski z osłoną
- DE Meißel mit Handschutz
- RU Зубило с протектором
- CZ Zámečnický sekáč (z krytem)
- RO Dalta forjată cu protecție
- HU Fém hidegvágó, kézvédővel
- ES Cincel de cerrajería mm con protector

**JUCO**

No.	Thickness / Grubość [mm]	L [mm]	m [kg]	
35359	17	250	0.56	5
35360	17	300	0.65	5
35362	17	350	0.76	5
35364	19	400	1.00	5

- EN Cold chisel with protection
- PL Przecinak z osłoną
- DE Schlitzmeißel mit Handschut
- RU Зубило с протектором
- CZ Ploché sekáč (z krytem)
- RO Daltă - tăietor plată (cu apărătoare)
- HU Hidegvágó, lapos (védőfejjel)
- ES Cincel plano (con protector)



No.	W [mm]	L [mm]	
35250	20	250	12/72
35300	25	300	12/48

- EN Cold chisel with protection
- PL Przecinak z osłoną
- DE Schlitzmeißel mit Handschut
- RU Зубило с протектором
- CZ Ploché sekáč (z krytem)
- RO Daltă - tăietor plată (cu apărătoare)
- HU Hidegvágó, lapos (védőfejjel)
- ES Cincel plano (con protector)



**VOREL**

No.	Thickness / Grubość [mm]	W [mm]	L [mm]	
35450	18	50	215	6/36
35451	19	75	215	6/36
35452	25	100	215	6/36

- EN Octagonal point chisel with protection
- PL Przebijak murarski z osłoną
- DE Spitzmeißel mit Handschutz
- RU Керн с протектором
- CZ Sekáč zednický s ochranným
- RO Dorn cu protecție pt. construcții
- HU Falvéső kézvédővel
- ES Cincel de cerrajería con protector

300 mm



No.	L [mm]	
35430	300	12/48





EN Wrecking bar CZ Páčidlo  
 PL Łom RO Ranga  
 DE Nageleisen HU Szögkihúzó  
 RU Лом ES Palanca



**VOREL**

No.	W [mm]	L [mm]	
34243	18	500	5/10
34245	18	700	10
34247	18	1000	10

EN Square type wrecking bar  
 PL Łom kwadratowy, hartowane końcówki  
 DE Nageleisen gehärtete Spitze  
 RU Лом квадратный с закаленными концами  
 CZ Páčidlo hranaté, kalené konce  
 RO Ranga patrata  
 HU Négyzet keresztmetszetű feszítővas, edzett véggel  
 ES Palanca



**VOREL**

No.	Thickness / Grubość [mm]	W [mm]	L [mm]	
34254	12	22	400	12/24
34256	16	30	600	6/12

EN Wrecking bar CZ Páčidlo  
 PL Łom RO Ranga pt. scos cuie  
 DE Nageleisen HU Szögkihúzó  
 RU Лом-гвоздодёр ES Palanca



No.	L [mm]	
34600	600	24
34750	750	24
34900	900	24

EN Wrecking bar CZ Stavební páčidlo  
 PL Łom budowlany RO Ranga  
 DE Baubrechstange HU Szögkihúzó  
 RU Лом круглый ES Palanca



**JUCO**

No.	Ø [mm]	L [mm]	m [kg]	
34220	27	1000	3.6	1
34222	27	1200	4.8	1
34225	27	1500	5.7	1

EN Flat wrecking bar CZ Páčidlo ploché kalené  
 PL Łom płaski hartowany RO Ranga plata  
 DE Nageleisen gehärtete Spitze HU Lapos feszítővas  
 RU Лом плоский закаленный ES Palanca plana



**VOREL**

No.	Thickness / Grubość [mm]	W [mm]	L [mm]	
34251	6	35	450	6/24

EN Wrecking bar CZ Páčidlo  
 PL Łom RO Ranga pt. scos cuie  
 DE Nageleisen HU Szögkihúzó  
 RU Лом-гвоздодёр ES Palanca



No.	L [mm]	
34300	300	60

EN Wrecking bar CZ Šestiúhlé páčidlo  
 PL Łom sześciokątny RO Ranga pt. scos cuie  
 DE Brechstange HU Hatszögű feszítővas  
 RU Лом-гвоздодёр шестигранный ES Palanca hexagonal



**JUCO**

No.	Thickness / Grubość [mm]	L [mm]	m [kg]	
34204	17	400	0.82	5
34205	17	500	1.1	5
34206	17	600	1.2	5
34207	17	700	1.4	5
34208	17	800	1.6	5
34210	19	1000	2.5	5
34212	19	1200	3	5

6

EN Axe  
PL Siekiera  
DE Axt  
RU Tonop

CZ Sekera  
RO Topor  
HU Fejsze  
ES Hacha



No.	m [g]	
33080	800	12/24

EN Axe  
PL Siekiera  
DE Axt  
RU Tonop

CZ Sekera  
RO Topor  
HU Fejsze  
ES Hacha



No.	m [g]	
33067	600	24
33087	800	20
33107	1000	12
33127	1250	12
33147	1400	12
33177	1600	12

EN Axe  
PL Siekiera  
DE Axt  
RU Tonop

CZ Sekera  
RO Topor  
HU Fejsze  
ES Hacha

DIN  
5131  
7294



No.	m [g]	DIN	
33024	400	5131	5
33026	600	5131	5
33028	800	5131	5
33030	1000	5131	5
33032	1250	7294	5
33035	1500	7294	5
33038	1800	7294	5
33039	2000	7294	5
33040	2500	7294	5

EN Splitting axe  
PL Siekiera rozłupująca  
DE Spaltaxt  
RU Топор-колун

CZ Štípací sekera  
RO Topor pt. despical lemne  
HU Hasítófejsze  
ES Hacha de corte

1  
kg



No.	m [g]	
32930	1000	10

EN Axe  
PL Siekiera  
DE Axt  
RU Tonop

CZ Sekera  
RO Topor  
HU Fejsze  
ES Hacha



No.	m [g]	
33065	600	20
33085	800	20
33105	1000	12
33125	1250	6

EN Axe  
PL Siekiera  
DE Axt  
RU Tonop

CZ Sekera  
RO Topor  
HU Fejsze  
ES Hacha

DIN  
5131  
7294



No.	m [g]	DIN	
33000	400	5131	5
33001	600	5131	5
33002	800	5131	5
33003	1000	5131	5
33004	1250	7294	5
33005	1500	7294	5
33006	1800	7294	5
33007	2000	7294	5
33008	2500	7294	5

EN Axe set  
PL Zestaw siekier tradycyjnych  
DE Satz traditioneller Äxte  
RU Набор традиционных топоров

CZ Sada klasických seker  
RO Set topoare  
HU Hagymányos balta készlet  
ES Set de hechas tradicionales



**JUKO**

No.	m [kg]	
32999	0.4, 1.5	5

EN Hammer-axe for wood splitting  
PL Siekiero-młot  
DE Spaltaxt  
RU Топор-колун

CZ Sekera-kládivo  
RO Secure-ciocan  
HU Szekerce-kalapács  
ES Hacha martillo para partir madera



**JUKO**

No.	m [g]	
32927	2100	1
32928	3200	1

EN Canadian axe  
PL Siekiera kanadyjska  
DE Handbeil „Kanadische Form“  
RU Топор канадского типа

CZ Sekera kanadská  
RO Topor canadian  
HU Hosszú nyelű, hasító fejsze  
ES Hacha canada

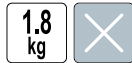

**JUKO**

No.	m [g]	
33022	1800	5

EN Hammer wedges  
PL Zestaw klinujący  
DE Keilesatz  
RU Набор клинов  
CZ Sada klínků  
RO Set cultivator  
HU Ékelő készlet  
ES Juego de sujeción



**JUKO**

No.	For hammer / Do mlotka [kg]	For axe / Do siekiery	
99460	0.1-0.5	-	50
99461	0.7-2.0	-	50
99462	3.0-4.0	0.4	50

EN Splitting axe  
PL Siekiera rozłupująca  
DE Spaltaxt  
RU Топор-колун

CZ Štípací seker  
RO Topor pt. despicat lemne  
HU Hasítófejsze  
ES Hacha de corte



**JUKO**

No.	m [g]	
32924	2000	5

EN Hammer-axe for wood splitting  
PL Siekiero-młot  
DE Spaltaxt  
RU Топор-колун

CZ Sekera-kládivo  
RO Secure-ciocan  
HU Szekerce-kalapács  
ES Hacha martillo para partir madera



**JUKO**

No.	m [g]	
32925	2500	1
32926	4000	1

EN Hammer wedges  
PL Zestaw klinujący  
DE Keilesatz  
RU Набор клинов

CZ Sada klínků  
RO Set cultivator  
HU Ékelő készlet  
ES Juego de sujeción

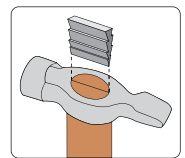

**VOREL**

No.	pcs / szt.	
99472	10	6/72

EN Hammer wedges  
PL Zestaw klinujący  
DE Keilesatz  
RU Набор клинов  
CZ Sada klínků  
RO Set cultivator  
HU Ékelő készlet  
ES Juego de sujeción



**JUKO**

No.	For hammer / Do mlotka [kg]	For axe / Do siekiery [kg]	
99463	5-6	0.6-1.0	50
99464	8-10	1.2-2.5	50

EN Pick axe  
 PL Kilof bez trzonka  
 DE Spitzhacke ohne Stiel  
 RU Кирка двухсторонняя без черенка

CZ Násada na krumpáč  
 RO Coadă tarnacop  
 HU Csákánynyél  
 ES Palo para pico



**VOREL**

No.	m [kg]	
32901	2.5	8

EN Pick axe  
 PL Kilof oprawiony  
 DE Spitzhacke  
 RU Кирка двухсторонняя с черенком

CZ Krumpáč osazený  
 RO Târnacop cu coadă  
 HU Ékelt csákány  
 ES Piqueta



**VOREL**

No.	m [kg]	
32900	2.5	6

EN Wooden handle for pick axe  
 PL Trzonek do kilofa  
 DE Stiel für Spitzhacke  
 RU Черенок для кирки

CZ Násada na krumpáč  
 RO Coadă tarnacop  
 HU Csákánynyél  
 ES Palo para pico



No.	L [cm]	For / Dla	
32902	90	32901	10

EN Wood splitter  
 PL Klin do rozłupywania drewna  
 DE Spaltkeil  
 RU Клин для раскалывания бревен

CZ Klín na štípání polen  
 RO Pana pt. lemn  
 HU Fahasító ék  
 ES Cuña para partir madera



**JUCO**

No.	m [kg]	
32922	2	1
32923	3	1

Memo



Memo

# 7

## Clamps & vices Ściski i imadła

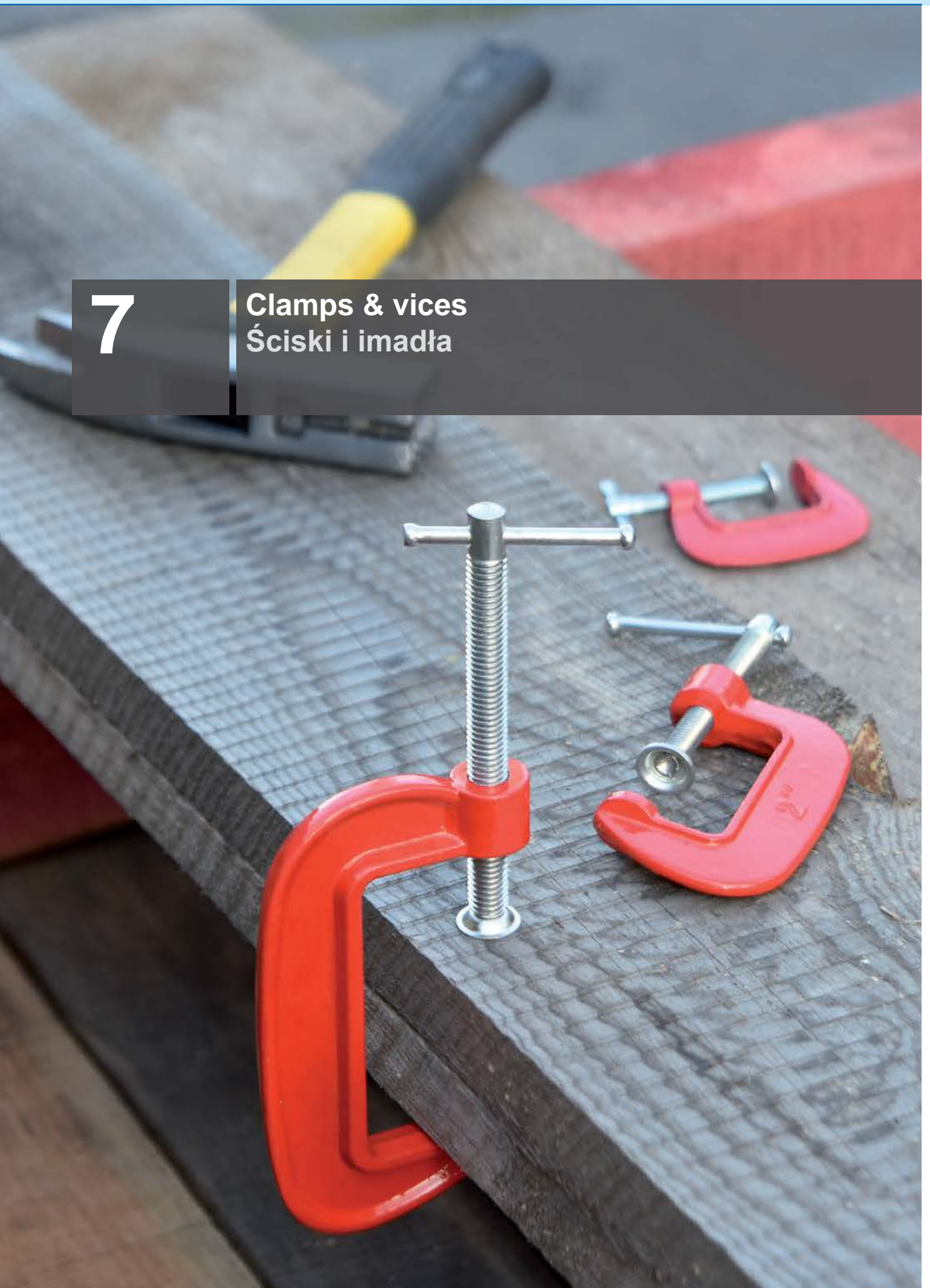

## Clamps Ściski



70-72

### F-clamps & sets

Ściski stolarskie i zestawy..... 70

### Quick release clamps

Ściski szybkozaciskowe..... 70

### Battenboard clamps

Ściski do klejenia płyt stolarskich..... 71

### Spring clamps

Ściski sprężynowe..... 71

### Corner clamps

Ściski kątowe..... 71

### Frame clamps

Ściski taśmowe..... 71

### C-clamps

Ściski typu „C”..... 72

### Ratchet floor clamps

Pasy ściągające do paneli podłogowych..... 72

## Vices Imadła



72-73

### Baby vices

Imadła stołowe..... 72

### Bench vices

Imadła ślusarskie..... 73

EN F-clamp  
 PL Ścisk stolarski  
 DE Schraubzwinge  
 RU Струбцина  
 CZ Truhlářské upínadlo  
 RO Presa lemn  
 HU Asztalos szorító  
 ES Tornillo de apriete



7 **VOREL**

No.	Size / Rozmiar [mm]	
37100	50x100	12/60
37101	50x150	12/60
37102	50x200	12/60
37103	50x250	12/60
37104	50x300	12/60
37106	80x200	10/30
37107	80x250	10/30
37108	80x300	10/20
37109	80x500	10/20
37110	120x300	10/20
37111	120x500	10
37112	120x800	10
37113	120x1000	6
37114	120x1200	6
37115	120x1500	6

EN F-clamp  
 PL Ścisk stolarski  
 DE Schraubzwinge  
 RU Струбцина  
 CZ Truhlářské upínadlo  
 RO Presa lemn  
 HU Asztalos szorító  
 ES Tornillo de apriete



No.	Size / Rozmiar [mm]	pcs / szt.	
38150	50x150	2	10/30
38200	50x200	2	10/30

EN F-clamp  
 PL Ścisk stolarski  
 DE Schraubzwinge  
 RU Струбцина  
 CZ Truhlářské upínadlo  
 RO Presa lemn  
 HU Asztalos szorító  
 ES Tornillo de apriete

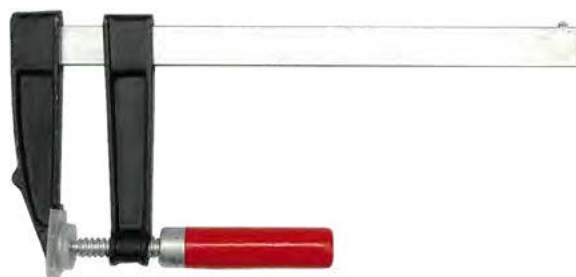

No.	Size / Rozmiar [mm]	
37150	50x150	12/60
37200	50x200	12/60
37250	50x250	12/60
37300	50x300	12/60
37380	80x300	15/30
37400	80x500	15/30
37430	120x300	10/20
37500	120x500	10/20
37800	120x800	10
37900	120x1000	10

EN Quick release clamp  
 PL Ścisk szybkozaciskowy  
 DE Schnellklemme  
 RU Быстрозажимная струбцина  
 CZ Svěrká rychloupínací  
 RO Clemă cu prindere rapidă  
 HU Gyors asztalos szorító  
 ES Apretador rápido



**VOREL**

No.	L [mm]	Max. expand range / Maks. zasięg rozpięcia [mm]	Max. clamping range / Maks. zasięg ściskania [mm]	Max. jaws depth / Maks. głębokość szczęk [mm]	
38401	150	141-312	0-152	63	12/36
38402	200	141-355	0-203	63	6/36
38403	250	141-405	0-254	63	6/30
38404	300	141-464	0-304	63	6/30
38406	350	141-555	0-355	63	6/24
38407	450	141-617	0-457	63	6/24
38408	600	141-769	0-609	63	6/18
38409	750	141-922	0-762	63	6/12



EN Squeezing clamp  
 PL Ścisk z prowadnicą aluminiową do klejenia płyt  
 DE Aluminium-Fugzwinge  
 RU Струбцина-вайма  
 CZ Dverový upínač  
 RO Menghina pt. tamplarie  
 HU Táblásító szorító  
 ES Prensa sargento de aluminio



**VOREL**

No.	L [mm]	
38642	900	10
38641	1500	10
38643	2400	3/10

EN Pipe clamps  
 PL Ścisk do klejenia płyt mocowanie na rurę  
 DE Holz kleben Rohrschelle  
 RU Струбцина трубная  
 CZ Trubková zvierka  
 RO Menghina tamplarie pt. tevi  
 HU Végtelelen csavaros fém szorító  
 ES Prensa sargento para carpintería

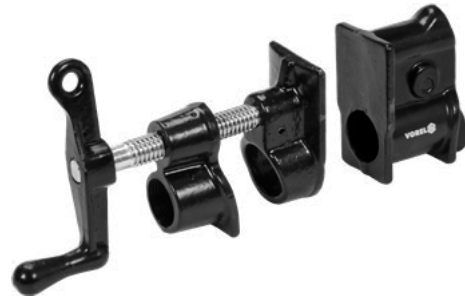
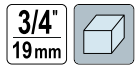

**VOREL**

No.	
38620	12

EN Spring clamp  
 PL Ścisk sprężynowy  
 DE Federklemme  
 RU Струбцина пружинная  
 CZ Pružinová svěrka  
 RO Clește presă  
 HU Rugós szorító  
 ES Pinza de resorte



No.	L [mm]	
38500	100	24/240
38515	150	12/120
38525	200	10/100

EN Corner clamp  
 PL Ścisk stolarski kątowy  
 DE Gehrungszwinge  
 RU Струбцина угловая  
 CZ Truhlářské upínadlo úhlové  
 RO Clește presa colt  
 HU Asztalos szorító, sarok  
 ES Abrazadera de ángulo



No.	Size / Rozmiar [mm]	
38750	75	10/100

EN Corner clamp  
 PL Ścisk stolarski kątowy  
 DE Gehrungszwinge  
 RU Струбцина угловая  
 CZ Truhlářské upínadlo úhlové  
 RO Clește presa colt  
 HU Asztalos szorító, sarok  
 ES Abrazadera de ángulo



**VOREL**

No.	Size / Rozmiar [mm]	
38751	65x70	6/12

EN Frame clamp  
 PL Ścisk taśmowy  
 DE Bandzwinge  
 RU Ленточный зажим  
 CZ Pásová svorka  
 RO Clema pt. cadru  
 HU Szalagos szorító  
 ES Tensor de cinta



**VOREL**

No.	Tape length / Długość taśmy [m]	
38531	4	20

- EN "C" clamp  
 PL Ścisk typu „C”  
 DE C-Schraubzwinge  
 RU Струбцина тип „С”
- CZ Sverka tvaru „C”  
 RO Menghina tip „C”  
 HU Pillanatszorító  
 ES Tornillo tipo „C”



No.	Jaws range / Rozstaw szczęk [mm]	Force pressure / Siła nacisku [kg]	
38430	50	140	50
38431	75	190	50
38432	100	270	30
38433	125	320	20
38434	150	360	18
38435	200	390	10
38436	250	420	6

- EN Ratchet floor clamp  
 PL Pas ściągający do paneli podłogowych  
 DE Spanngurt für Laminatpannele  
 RU Ремень для стяжки напольных панелей  
 CZ Stahovací pás na podlahní panele  
 RO Curea elastică strâns plăci parchet  
 HU Padlópanelhez rögzítő pánt  
 ES Cinta tirante para placas de suelo



No.	Tape length / Długość taśmy [m]	
82355	5	10/20

- EN Baby vice - swivel base  
 PL Imadło stolowe obrotowe  
 DE Bankschraubstock drehbar  
 RU Тиски настольные поворотные  
 CZ Stolní svěrák otáčivý  
 RO Menghină rotativă de masă  
 HU Satu, asztali, forgó  
 ES Tornillo de apriete giratorio



No.	Jaws width / Szerokość szczęk [mm]	
36014	40	12/24
36015	50	10/20
36016	60	9/18
36018	75	6/12

- EN C-clamp set  
 PL Ściski modelarskie  
 DE Mini-Schraubzwingensatz  
 RU Набор струбцин С-типа
- CZ Modelářské upínadlo  
 RO Presa lemni tip „C” set  
 HU Modellező szorítók  
 ES Tornillos tipo „C”



No.	Jaws range / Rozstaw szczęk [mm]	
38830	25, 50, 75	12/48

- EN Baby vice - fixed base  
 PL Imadło stolowe  
 DE Bankschraubstock  
 RU Тиски настольные неповоротные  
 CZ Stolní svěrák  
 RO Menghină de masă  
 HU Satu, asztali  
 ES Tornillo de apriete



No.	Jaws width / Szerokość szczęk [mm]	
36000	25	15/60
36004	40	12/48
36005	50	18/36
36006	60	12/24
36008	70	10/20

- EN Baby vice - fixed base  
 PL Imadło stolowe  
 DE Bankschraubstock  
 RU Тиски настольные поворотные  
 CZ Stolní svěrák  
 RO Menghină de masă  
 HU Satu, asztali  
 ES Tornillo de apriete



No.	Jaws width / Szerokość szczęk [mm]	
36650	65	10

EN Bench vice - fixed base  
 PL Imadlo ślusarskie  
 DE Schlosserschraubstock  
 RU Тиски слесарные с наковальней

CZ Zámečnický svěrák  
 RO Menghină de lăcătușerie  
 HU Satu, lakatos  
 ES Tornillo de apriete



**VOREL**

No.	Jaws width / Szerokość szczęk [mm]	
36032	100	1
36033	125	1
36034	150	1/1

EN Bench vice - swivel base  
 PL Imadlo ślusarskie obrotowe  
 DE Schlosserschraubstock drehbar  
 RU Тиски слесарные поворотные

CZ Zámečnický svěrák otáčivé  
 RO Menghină de lăcătușerie rotativă  
 HU Satu, lakatos forgó  
 ES Tornillo de apriete giratorio



**VOREL**

No.	Jaws width / Szerokość szczęk [mm]	
36037	100	1
36038	125	1
36039	150	1

7

Memo



# 8

## Cutting tools Narzędzia tnące





## Drill bits Wiertła

77-85



### Twist drill bits HSS & sets

Wiertła do metalu HSS i zestawy..... 77

### Twist drill bits HSS-G & sets

Wiertła do metalu HSS-G i zestawy..... 78

### Step drills & sets

Wiertła stopniowe i zestawy..... 78

### Universal drills & sets

Wiertła uniwersalne i zestawy..... 79

### Masonry drill bits & sets

Wiertła do betonu i zestawy..... 80

### Wood drill bits

Wiertła do drewna..... 80

### SDS Masonry drill bits & sets

Wiertła do betonu SDS i zestawy..... 81

### SDS Chisels

Przecinaki i dłuta SDS..... 82

### Hollow drill sets

Wiertła koronowe do betonu..... 83

### Hole saw kits

Zestawy otwornic..... 84

### Tungsten carbide hole saws

Otwornice z węglikiem wolframu..... 85

### Drills for glass, ceramic tiles & sets

Wiertła do szkła, ceramiki, gresu i zestawy..... 85

### Jigs & patterns

Wzorniki i szablony..... 85

## Tools for dowel joints

### Narzędzia do połączeń kołkowych

86



## Taps & dies

### Narzędzia do gwintowania

86-88



### Hand taps CZ TOOLS

Gwintowniki CZ TOOLS..... 86

### Machine taps CZ TOOLS

Gwintowniki maszynowe CZ TOOLS..... 87

### Circular dies CZ TOOLS

Narzynki CZ TOOLS..... 87

### Tap & die sets CZ TOOLS

Zestawy gwintowników i narzynek CZ TOOLS..... 87

### Tap wrenches & die holders

Pokręta do gwintowników i narzynek..... 87

### Tap & die sets

Zestawy gwintowników i narzynek..... 88

### Screw extractor sets

Wykrętaki do zerwanych śrub..... 88

## Router bits, rotary rasps & sets

### Frezy do drewna, metalu i zestawy

88



## Diamond tools

### Narzędzia diamentowe

89-90



### Diamond blades for cutting construction materials

Tarcze diamentowe do cięcia materiałów budowlanych..... 89

### Diamond rod saws

Brzeszczoty diamentowe..... 90

## Tungsten carbide tipped tools

### Narzędzia z ostrzem z węglika wolframu

90



### Tungsten carbide saws for wood

Tarcze z węglikiem do drewna..... 90

### Tungsten carbide saws for aluminium

Tarcze z węglikiem do aluminium..... 90

## Cutting & grinding discs

### Tarcze do cięcia i szlifowania

90-91



### Metal cutting discs

Tarcze do cięcia metalu..... 90

### Metal grinding discs

Tarcze do szlifowania metalu..... 91

### Stone cutting discs

Tarcze do cięcia kamienia..... 91

### Stone grinding discs

Tarcze do szlifowania kamienia..... 91

## Flap discs

### Ściernice listkowe talerzowe

91



## Grinding discs

### Tarcze do szlifierek stołowych

91-92



## Shears

### Nożyce

92-93



### Tin snips

Nożyce do blachy..... 92

### Bolt cutters

Nożyce do prętów..... 93

## Saws & blades

### Piły i brzeszczoty

94-101



### Hand saws

Piły do drewna..... 94

### Bow saws

Piły kabłąkowe..... 95

### Bow saw blades

Brzeszczoty do pił kabłąkowych..... 95

### Compass saws

Piły otwornice..... 95

### Saws for gas concrete

Piły do gazobetonu..... 95

### Hacksaw frames

Piły do metalu..... 95

### Cross cut saws

Piły poprzeczne..... 97

<b>Miter saws</b> Piły kątowe.....	97
<b>Miter boxes</b> Skrzynki uciosowe.....	98
<b>Blades</b> Brzeszczoty.....	98
<b>Jig saw blades</b> Brzeszczoty do wyrzynarek.....	101

## Brushes, knives & files

### Szczotki, noże i pilniki

101-114



<b>Wire brushes</b> Szczotki druciane.....	101
<b>Cup brushes</b> Szczotki tarczowe.....	102
<b>Rubber discs</b> Tarcze gumowe do elektronarzędzi.....	103
<b>8 Pocket knives</b> Noże składane.....	105
<b>Window scrapers</b> Skrobaki do szyb.....	108
<b>Glass cutters</b> Nożyki do cięcia szkła.....	108
<b>Marking out tools</b> Narzędzia traserskie.....	108
<b>Scrapers</b> Cykliny.....	109
<b>Wood carving knife sets</b> Zestawy nożyków precyzyjnych.....	109
<b>Scissors</b> Nożyczki.....	109
<b>Leatherwork accessories</b> Akcesoria kaletnicze.....	109
<b>Wood planes</b> Strugi.....	110
<b>Steel files</b> Pilniki do metalu.....	111
<b>Diamond whetstones &amp; sets</b> Oselki diamentowe i zestawy.....	112
<b>Rasps</b> Tarniki do drewna.....	112
<b>Rasps for plaster</b> Tarniki do gipsu.....	113

## Abrasive products

### Artykuły ściernie

114-117

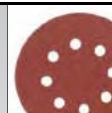

<b>Sharpening stones</b> Oselki.....	114
<b>Waterproof sand papers</b> Papiery ściernie wodoodporne.....	114
<b>Abrasive clothes</b> Piłótna ściernie.....	115
<b>Abrasive meshes</b> Siatki ściernie.....	115
<b>No end abrasive bands</b> Taśmy ściernie bezkońcowe.....	115
<b>Abrasive sponges</b> Kostki ściernie.....	115
<b>Abrasive sheets and discs</b> Arkusze i krążki ściernie.....	116
<b>Sanding blocks</b> Błoki ściernie.....	116
<b>Polishing sets</b> Zestawy polerskie.....	117

EN Twist drill bit  
 PL Wiertło do metalu  
 DE Metallspiralbohrer  
 RU Сверло по металлу  
 CZ Vrták na kov  
 RO Burghiu pt. metal  
 HU Fúrószárkészlet fémhez  
 ES Broca para metal



**STHOR**

No.	Ø [mm]	pcs / szt.	
20100	1.0	10	200/10000
20150	1.5	10	200/8000
20200	2.0	10	200/8000
20250	2.5	10	200/4000
20280	2.8	10	200/4000
20300	3.0	10	200/4000
20320	3.2	10	100/4000
20350	3.5	10	100/4000
20400	4.0	10	100/4000
20420	4.2	10	100/2500
20450	4.5	10	100/2500
20500	5.0	10	100/2500
20550	5.5	10	100/2000
20600	6.0	10	50/1200
20650	6.5	10	50/1200
20700	7.0	10	50/1200
20800	8.0	5	50/600
20850	8.5	5	50/600
20900	9.0	5	50/600
21000	10.0	5	50/250
21100	11.0	5	50/250
21200	12.0	5	50/250
21250	12.5	5	50/250
21300	13.0	5	50/250
21400	14.0	5	50/200
21600	16.0	5	10/100

EN Twist drill set  
 PL Zestaw wiertel do metalu  
 DE Metallspiralbohrersatz  
 RU Набор сверл по металлу  
 CZ Souprava vrtáků na kov  
 RO Set de burghie pt. metal  
 HU Fúrószárkészlet fémhez  
 ES Juego de brocas para metal



**STHOR**

No.	Ø [mm]	pcs / szt.	
22330	1, 1.5, 2, 2.5, 3, 3.5, 4, 4.5, 5, 5.5, 6, 6.5, 7, 7.5, 8, 8.5, 9, 9.5, 10	19	30
22340	1, 1.5, 2.0, 2.5, 3.0, 3.5, 4.0, 4.5, 5, 5.5, 6, 6.5, 7, 7.5, 8, 8.5, 9, 9.5, 10, 10.5, 11, 11.5, 12, 12.5, 13	25	20

EN Twist drill set  
 PL Zestaw wiertel do metalu  
 DE Metallspiralbohrersatz  
 RU Набор сверл по металлу  
 CZ Souprava vrtáků na kov  
 RO Set de burghie pt. metal  
 HU Fúrószárkészlet fémhez  
 ES Juego de brocas para metal



**STHOR**

No.	Ø [mm]	pcs / szt.	
22130	1.5, 2, 2.5, 3, 3.2, 3.5, 4, 4.5, 4.8, 5, 5.5, 6, 6.5	13	25/100
22180	2, 2.5, 3, 3.5, 4, 4.5, 5, 5.5, 6, 6.5, 7, 7.5, 8	13	25/50

EN Twist drill set  
 PL Zestaw wiertel do metalu  
 DE Metallspiralbohrersatz  
 RU Набор сверл по металлу  
 CZ Souprava vrtáků na kov  
 RO Set de burghie pt. metal  
 HU Fúrószárkészlet fémhez  
 ES Juego de brocas para metal

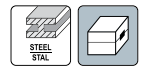

**STHOR**

No.	Ø [mm]	pcs / szt.	
22190	1, 1.5, 2, 2.5, 3, 3.5, 4, 4.5, 5, 5.5, 6, 6.5, 7, 7.5, 8, 8.5, 9, 9.5, 10	19	30
22250	1, 1.5, 2, 2.5, 3, 3.5, 4, 4.5, 5, 5.5, 6, 6.5, 7, 7.5, 8, 8.5, 9, 9.5, 10, 10.5, 11, 11.5, 12, 12.5, 13	25	20

EN Twist drill set  
 PL Zestaw wiertel do metalu  
 DE Metallspiralbohrersatz  
 RU Набор сверл по металлу  
 CZ Souprava vrtáků na kov  
 RO Set de burghie pt. metal  
 HU Fúrószárkészlet fémhez  
 ES Juego de brocas para metal



**STHOR**

No.	Ø [mm]	pcs / szt.	
22300	1.5, 2.0, 2.5, 3.0, 3.2, 3.5, 4.0, 4.5, 4.8, 5.0, 5.5, 6.0, 6.5	13	25/100
22310	2.0, 2.5, 3.0, 3.5, 4.0, 4.5, 5.0, 5.5, 6.0, 6.5, 7.0, 7.5, 8.0	13	25/50

- EN HSS twist drill bit
- PL Wiertło do metalu HSS
- DE Metallspiralbohrer HSS
- RU Сверло по металлу HSS
- CZ Vrták na kov HSS
- RO Burghiu pt. metal HSS
- HU Fúrószár fémhez HSS
- ES Broca para metal HSS

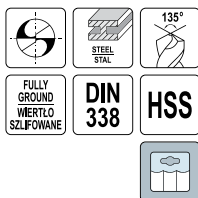

**STHOR**

No.	Ø [mm]	pcs / szt.	
21900	1.0	10	20/1000
21905	1.5	10	20/1000
21910	2.0	10	20/800
21915	2.5	10	20/800
21919	3.0	10	20/500
21921	3.2	10	20/400
21924	3.5	10	20/400
21927	4.0	10	10/400
21929	4.2	10	10/250
21932	4.5	10	10/250
21934	4.8	10	10/250
21936	5.0	10	10/250
21941	5.5	10	10/200
21944	6.0	10	10/120
21948	6.5	10	5/120
21950	7.0	5	10/120
21951	7.5	5	10/120
21952	8.0	5	10/120
21955	8.5	5	10/120
21956	9.0	5	10/120
21958	10.0	5	10/50
21961	11.0	5	10/50
21963	12.0	5	10/50
21966	13.0	3	16/48

- EN Step drill
- PL Wiertło stopniowe
- DE Stufenbohrer
- RU Сверло ступенчатое
- CZ Stupňovitý vrták
- RO Burghiu in trepte
- HU Lépcsős fúró
- ES Broca cónica escalonada

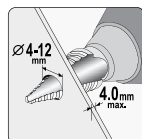
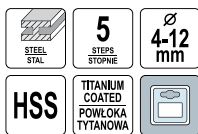

**STHOR**

No.	Ø [mm]	
22610	4, 6, 8, 10, 12	25/200

- EN Twist drill set
- PL Zestaw wiertel do metalu
- DE Metallspiralbohrersatz
- RU Набор сверл по металлу
- CZ Souprava vrtáků na kov
- RO Set de burghie pt. metal
- HU Fúrószárkészlet fémhez
- ES Juego de brocas para metal

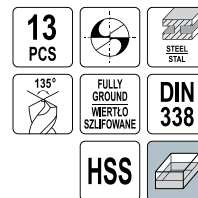

**STHOR**

No.	Ø [mm]	pcs / szt.	
21998	2, 2.5, 3, 3.5, 4, 4.5, 5, 5.5, 6, 6.5, 7, 7.5, 8	13	10/50

- EN Twist drill set
- PL Zestaw wiertel do metalu
- DE Metallspiralbohrersatz
- RU Набор сверл по металлу
- CZ Souprava vrtáků na kov
- RO Set de burghie pt. metal
- HU Fúrószárkészlet fémhez
- ES Juego de brocas para metal

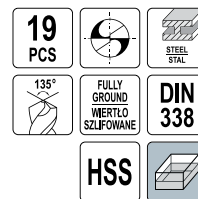

**STHOR**

No.	Ø [mm]	pcs / szt.	
21999	1, 1.5, 2, 2.5, 3, 3.5, 4, 4.5, 5, 5.5, 6, 6.5, 7, 7.5, 8, 8.5, 9, 9.5, 10	19	5/30

- EN Twist drill set
- PL Komplet wiertel do metalu
- DE Metallspiralbohrersatz
- RU Набор сверл по металлу
- CZ Souprava vrtáků na kov
- RO Set de burghie pt. metal
- HU Fúrószárkészlet fémhez
- ES Juego de brocas para metal

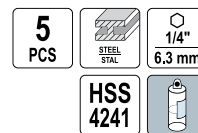

**STHOR**

No.	Ø [mm]	pcs / szt.	
21650	4, 5, 6, 8, 10	5	30/60

- EN Step drill
- PL Wiertło stopniowe
- DE Stufenbohrer
- RU Сверло ступенчатое
- CZ Stupňovitý vrták
- RO Burghiu in trepte
- HU Lépcsős fúró
- ES Broca cónica escalonada

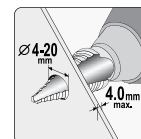

**STHOR**

No.	Ø [mm]	
22611	4, 6, 8, 10, 12, 14, 16, 18, 20	25/100



EN Step drill  
 PL Wiertło stopniowe  
 DE Stufenbohrer  
 RU Сверло ступенчатое  
 CZ Stupňovitý vrták  
 RO Burghiu în trepte  
 HU Lépcsős fúró  
 ES Broca cónica escalonada

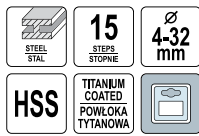

No.	Ø [mm]	
22612	4, 6, 8, 10, 12, 14, 16, 18, 20, 22, 24, 26, 28, 30, 32	10/80

EN Step drill set  
 PL Zestaw wiertel stopniowych  
 DE Stufenbohrer Set  
 RU Набор ступенчатых сверл  
 CZ Sada stupňovitých vrtáků  
 RO Set burghie în trepte  
 HU Lépcsős fúró készlet  
 ES Juego de brocas cónicas escalonadas

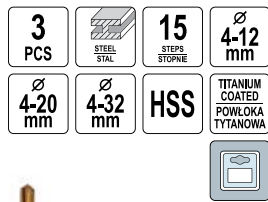

No.	Ø [mm]	
22616	4-12 (4, 6, 8, 10, 12 mm), 4-20 (4, 6, 8, 10, 12, 14, 16, 18, 20 mm), 4-32 (4, 6, 8, 10, 12, 14, 16, 18, 20, 22, 24, 26, 28, 30, 32 mm)	20

EN Universal drills  
 PL Komplet wiertel uniwersalnych  
 DE Universalbohrer-Set  
 RU Набор универсальных сверл  
 CZ Sada víceúčelových vrtáků  
 RO Set burghie universal  
 HU Keményfém többcélú fúró készlet  
 ES Sets de brocas multmaterial

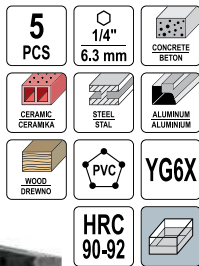

No.	Ø [mm]	pcs / szt.	
21695	4, 5, 6, 8, 10	5	25/100

EN Universal drill  
 PL Wiertło uniwersalne  
 DE Universalbohrer  
 RU Универсальное сверло

CZ Víceúčelový vrták  
 RO Burghiu universal  
 HU Közét és többcélú fúró  
 ES Broca multmaterial

No.	Ø [mm]	L [mm]	
21680	3	75	150/600
21682	4	80	150/600
21684	5	85	100/400
21686	6	110	100/400
21688	7	110	100/400
21690	8	120	100/400
21691	10	120	50/200
21692	12	150	50/200

EN Step drill  
 PL Wiertło stopniowe  
 DE Stufenbohrer  
 RU Сверло ступенчатое  
 CZ Stupňovitý vrták  
 RO Burghiu în trepte  
 HU Lépcsős fúró  
 ES Broca cónica escalonada



No.	Ø [mm]	
22613	4, 6, 9, 12, 15, 18, 21, 24, 27, 30, 33, 36, 39	10/40

EN Step drill set  
 PL Zestaw wiertel stopniowych  
 DE Stufenbohrer Set  
 RU Набор ступенчатых сверл  
 CZ Sada stupňovitých vrtáků  
 RO Set burghie în trepte  
 HU Lépcsős fúró készlet  
 ES Juego de brocas cónicas escalonadas



No.	Ø [mm]	
22617	4-12 (4, 6, 8, 10, 12 mm), 4-20 (4, 6, 8, 10, 12, 14, 16, 18, 20, 22, 24, 26, 28, 30, 32 mm), 4-39 (4, 6, 9, 12, 15, 18, 21, 24, 27, 30, 33, 36, 39 mm)	20

EN Universal drills  
 PL Komplet wiertel uniwersalnych  
 DE Universalbohrer-Set  
 RU Набор универсальных сверл  
 CZ Sada víceúčelových vrtáků  
 RO Set burghie cu coada hexagonala  
 HU Keményfém többcélú fúró készlet  
 ES Sets de brocas multmaterial



No.	pcs / szt.	
22640	4	25/100

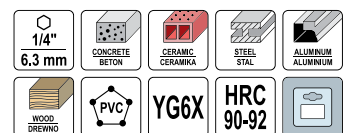

- EN Masonry drill set
- PL Wiertła do betonu
- DE Betonspiralbohrersatz
- RU Сверла по бетону в наборе
- CZ Souprava vrtáků do betonu
- RO Set de burghie pt. beton
- HU Fúrószárkészlet betonhoz
- ES Brocas para hormigon

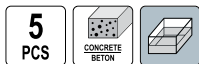

**STHOR**

No.	Ø [mm]	pcs / szt.	
23331	4, 5, 6, 8, 10	5	50/100

8

- EN Wood drill set
- PL Wiertła do drewna
- DE Holzbohrersatz
- RU Набор сверел по дереву
- CZ Vrtáky do dřeva
- RO Burghie pt. lemn
- HU Fafúrószár készlet
- ES Brocas para madera



No.	Ø [mm]	pcs / szt.	
22350	4, 5, 6, 8, 10	5	25/200

- EN Wood drill set
- PL Wiertła do drewna
- DE Holzbohrersatz
- RU Набор сверел по дереву
- CZ Vrtáky do dřeva
- RO Burghie pt. lemn
- HU Fafúrószár készlet
- ES Brocas para madera



**STHOR**

No.	Ø [mm]	pcs / szt.	
22381	3, 4, 5, 6, 7, 8, 9, 10	8	10/80

- EN Masonry drill bit
- PL Wiertło do betonu
- DE Betonbohrer
- RU Сверло по бетону
- CZ Vrták na beton
- RO Burghiu pt. beton
- HU Fúrószár betonhoz
- ES Broca para hormigon

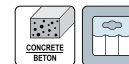

**STHOR**

No.	Ø [mm]	L [mm]	
23311	4	75	200/1600
23312	5	85	200/1600
23313	6	100	200/1000
23315	8	120	100/500
23325	8	400	50/200
23316	10	120	100/500
23326	10	400	50/100
23317	12	150	50/250
23327	12	400	50/100
23318	14	150	50/150

- EN Wood drill set
- PL Wiertła do drewna
- DE Holzbohrersatz
- RU Набор сверел по дереву
- CZ Vrtáky do dřeva
- RO Burghie pt. lemn
- HU Fafúrószár készlet
- ES Brocas para madera



**STHOR**

No.	Ø [mm]	pcs / szt.	
22380	3, 4, 5, 6, 7, 8, 9, 10	8	20/100

- EN Wood drill set
- PL Wiertła do drewna
- DE Holzbohrersatz
- RU Набор сверел по дереву
- CZ Vrtáky do dřeva
- RO Burghie pt. lemn
- HU Fafúrószár készlet
- ES Brocas para madera

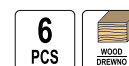

**STHOR**

No.	Ø [mm]	L [mm]	pcs / szt.	
22460	6, 8, 10, 12, 13, 14	300	6	25

EN Wood drill set  
 PL Wiertła do drewna  
 DE Holzbohrersatz  
 RU Набор сверел по дереву  
 CZ Vrtáky do dřeva  
 RO Burghie pt. lemn  
 HU Fafűrőszár készlet  
 ES Brocas para madera



**STHOR**

No.	Ø [mm]	L [mm]	pcs / szt.	
22465	10, 12, 14, 16, 18, 20	230	6	10

EN Flat wood bits  
 PL Wiertła do drewna, topatkowe  
 DE Holz-Flachfräsbohrersatz  
 RU Набор сверел по дереву  
 CZ Vrtáky do dřeva  
 RO Burghie pt. lemn  
 HU Fafűrőszár készlet  
 ES Brocas para madera

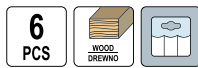

No.	Ø [mm]	pcs / szt.	
22500	10, 12, 16, 18, 20, 25	6	10/100

EN Wood splitting drill bit  
 PL Wiertło do rozłupywania drewna  
 DE Holzspaltbohrer  
 RU Сверло для раскалывания дров  
 CZ Vrták na štípání dřeva  
 RO Burghiu pt. despicat lemn  
 HU Fahasító kúp  
 ES Broca para cortar leña



**STHOR**

No.	Ø [mm]	pcs / szt.	
22590	32	3	5/50
22591	45	3	4/20

EN Hand gimlet set  
 PL Zestaw świderków ręcznych  
 DE Handbohrer  
 RU Буров по дереву  
 CZ Nebožez kovový  
 RO Burghiu de palma  
 HU Kézi fűrő  
 ES Broca manual



**VOREL**

No.	Ø [mm]	pcs / szt.	
22431	2, 3, 4, 5	4	20/200

EN Wood drill set  
 PL Wiertła do drewna  
 DE Holzbohrersatz  
 RU Набор сверел по дереву  
 CZ Vrtáky do dřeva  
 RO Burghie pt. lemn  
 HU Fafűrőszár készlet  
 ES Brocas para madera

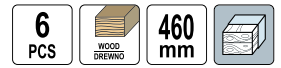

**STHOR**

No.	Ø [mm]	L [mm]	pcs / szt.	
22466	10, 12, 14, 16, 18, 20	460	6	10

EN Masonry drill bit  
 PL Wiertło do betonu  
 DE Betonbohrer  
 RU Бур по бетону  
 CZ Vrták na beton  
 RO Burghiu pt. beton  
 HU Fűrőszár betonhoz  
 ES Broca para hormigon



**STHOR**

No.	Ø [mm]	L [mm]	
23620	5	110	10/500
23640	6	110	10/500
23650	6	160	10/500
23660	6	210	10/300
23670	8	110	10/500
23680	8	160	10/400
23690	8	210	10/250
23692	8	300	10/200
23693	8	460	10/100
23694	8	600	10/100
23710	10	160	10/300
23720	10	210	10/250
23722	10	300	10/150
23723	10	460	10/100
23724	10	600	10/100
23730	12	160	10/300
23740	12	460	10/100
23750	12	266	10/150
23752	12	600	10/60
23800	14	166	10/200
23820	14	460	10/80
23830	14	266	10/150
23832	14	600	10/50
23840	16	200	10/160
23850	16	300	8/96
23860	16	460	8/48
23862	16	600	8/48
23880	18	300	8/72
23882	18	460	6/48
23883	18	600	6/48
23920	20	300	5/50
23930	20	460	5/50
23932	20	600	5/30
23960	22	460	5/25
23962	22	600	5/25
23980	25	300	5/50
23982	25	600	5/15
23990	25	460	5/25
23992	28	600	2/10
23999	30	600	5/10

EN Masonry drill bit  
 PL Wiertło do betonu  
 DE Betonspiralschneider  
 RU Сверло по бетону

CZ Vrták na beton  
 RO Burghiu pt. beton  
 HU Fúrószár betonhoz  
 ES Broca para hormigón



**STHOR**

No.	Ø [mm]	L [mm]	
23371	16	300	10/50
23390	16	600	5/30
23411	16	900	4/20
23372	18	300	10/50
23391	18	600	5/30
23412	18	900	4/20
23373	20	300	8/40
23392	20	600	4/20
23413	20	900	2/10
23374	22	300	6/30
23393	22	600	4/20
23414	22	900	2/10
23375	24	300	6/30
23394	24	600	4/20
23415	24	900	2/10
23376	25	300	6/30
23395	25	600	4/20
23416	25	900	2/10
23377	26	300	6/30
23396	26	600	2/10
23417	26	900	2/10
23397	28	600	2/10
23418	28	900	5
23379	30	300	4/20
23398	30	600	2/10
23419	30	900	5
23380	32	300	4/20
23399	32	600	2/10
23420	32	900	5
23381	35	300	4/20
23400	35	600	2/10
23421	35	900	5
23422	37	900	5
23402	38	600	1/5
23423	38	900	5
23403	40	600	5
23424	40	900	5

EN Flat chisel  
 PL Dłuto wąskie  
 DE Flachmeißel  
 RU Зубило узкое

CZ Sekáč  
 RO Daltă spatulată  
 HU Lapos véső  
 ES Cincel plano



**STHOR**

No.	Ø [mm]	Working width / Szerokość robocza [mm]	L [mm]	
23591	14	20	250	25/50

EN Masonry drill set  
 PL Komplet wiertel do betonu  
 DE Betonbohrersatz  
 RU Набор буров по бетону  
 CZ Souprava vrtáků do betonu  
 RO Set de burghie pt. beton  
 HU Fúrószárkészlet betonhoz  
 ES Juego de brocas



**STHOR**

No.	Ø [mm]	pcs / szt.	
23988	5, 6, 8, 10, 12	5	15/60

EN Point chisel  
 PL Szpiczak  
 DE Spitzmeißel  
 RU Зубило пиковое

CZ Špičák  
 RO Dorn  
 HU Hegyes véső  
 ES Cincel punta



**STHOR**

No.	Ø [mm]	Working width / Szerokość robocza [mm]	L [mm]	
23590	14	1.5	250	25/50

EN Point chisel  
 PL Szpiczak  
 DE Spitzmeißel  
 RU Зубило пиковое

CZ Špičák  
 RO Dorn  
 HU Hegyes véső  
 ES Cincel punta



**STHOR**

No.	Ø [mm]	Working width / Szerokość robocza [mm]	L [mm]	
23601	18	1.5	280	20/40
23602	18	1.5	400	10/20

EN Flat chisel  
 PL Dłuto wąskie  
 DE Flachmeißel  
 RU Зубило узкое

CZ Sekáč  
 RO Daltă spatulată  
 HU Lapos véső  
 ES Cincel plano



**STHOR**

No.	Ø [mm]	Working width / Szerokość robocza [mm]	L [mm]	
23603	18	25	280	20/40
23604	18	25	400	10/20



EN Spade chisel  
 PL Dłuto szerokie  
 DE Spatmeißel  
 RU Зубило плоское широкое  
 CZ Sekáč plochý  
 RO Dalta  
 HU Széles véső  
 ES Cincel pala



**STHOR**

No.	Ø [mm]	Working width / Szerokość robocza [mm]	L [mm]	
23592	14	40	250	25/50

EN Spade chisel  
 PL Dłuto szerokie  
 DE Spatmeißel  
 RU Зубило плоское широкое  
 CZ Sekáč plochý  
 RO Dalta  
 HU Széles véső  
 ES Cincel pala



**STHOR**

No.	Ø [mm]	Working width / Szerokość robocza [mm]	L [mm]	
23605	18	40	280	20/40
23606	18	50	400	10/20

EN Groove chisel  
 PL Bruzdownik  
 DE Nutenmeißel  
 RU Зубило-штробер  
 CZ Sekáč drážkovač  
 RO Dalta canal  
 HU Horonyvéső  
 ES Cincel acanalado



**STHOR**

No.	Ø [mm]	Working width / Szerokość robocza [mm]	L [mm]	
23608	18	25	400	20/20

EN Hollow drill set  
 PL Wiertło koronowe do muru  
 DE Bohrkronen  
 RU Коронка по бетону  
 CZ Korunový vrták na zed  
 RO Burghiu cu coroană pt. beton  
 HU Koronafúró falhoz  
 ES Broca vidia para muro

**VOREL**

No.	Ø [mm]	
03240	65	24
03241	80	20

EN Flat chisel  
 PL Dłuto płaskie  
 DE Spatmeißel  
 RU Долово плоское  
 CZ Sekáč plochý  
 RO Punctator tip dalta  
 HU Széles lapos véső  
 ES Cincel plano



**STHOR**

No.	Ø [mm]	Working width / Szerokość robocza [mm]	L [mm]	
23594	14	60	250	25/50

EN Groove chisel  
 PL Bruzdownik  
 DE Nutenmeißel  
 RU Зубило-штробер  
 CZ Sekáč drážkovač  
 RO Dalta canal  
 HU Horonyvéső  
 ES Cincel acanalado



**STHOR**

No.	Ø [mm]	Working width / Szerokość robocza [mm]	L [mm]	
23593	14	22	250	25/50

EN Adapter  
 PL Adapter  
 DE Adapter  
 RU Адаптер  
 CZ Adaptér  
 RO Adaptor  
 HU Adapter  
 ES Adaptador



**STHOR**

No.	L [mm]	
23460	60	100/200

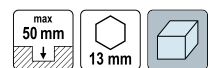

- EN Hollow drill set
- PL Wiertło koronowe do muru
- DE Bohrkronen
- RU Коронка по бетону
- CZ Korunový vrták na zeď
- RO Burghiu cu coroană pt. beton
- HU Koronafúró falhoz
- ES Broca widia para muro



No.	Ø [mm]	
03245	65	24
03246	80	20

- EN Drywall circle cutter
- PL Wycinarka do płyt gipsowych
- DE Schnitzzirkel für Gipsplatten
- RU Резак круговой по гипсокартону
- CZ Vystřihovačka pro sádrové desky
- RO Tăietor pt. plăci de ghips
- HU Gipszalkívógó
- ES Compas cortador para planchas de escayola



No.	Ø [mm]	
03990	30-400	12/48

- EN Hole saw set
- PL Zestaw wycinarek do otworów w drewnie
- DE Lochsägensatz
- RU Пилы кольцевые по дереву в наборе
- CZ Sada děrovek do dřeva
- RO Set carote pt. lemn
- HU Kőrkívógó készlet
- ES Juego de sierras de corona para madera

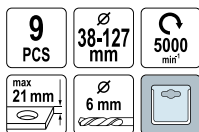

No.	Ø [mm]	pcs / szt.	
22572	38, 51, 57, 67, 76, 89, 102, 127	9	6/24

- EN Hole saw set
- PL Zestaw wycinarek do otworów w drewnie
- DE Lochsägensatz
- RU Пилы кольцевые по дереву в наборе
- CZ Sada děrovek do dřeva
- RO Set carote pt. lemn
- HU Kőrkívógó készlet
- ES Juego de sierras de corona para madera

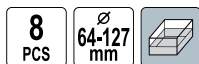

No.	Ø [mm]	pcs / szt.	
22571	64, 76, 87, 102, 127	8	6/24

- EN Hole saw set
- PL Wycinarka otworów do drewna
- DE Lochsägensatz
- RU Пилы кольцевые по дереву в наборе
- CZ Vytřinač otvorů
- RO Tăietor (ferăstrău rotund) pt. orificii
- HU Lyukasztó
- ES Sierra de corona para madera

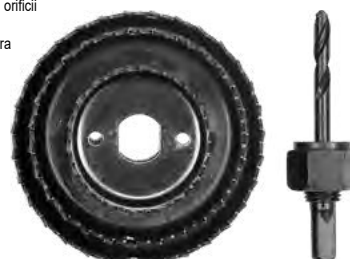
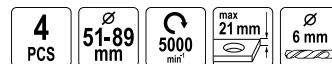

No.	Ø [mm]	pcs / szt.	
22565	51, 76, 89	4	12/48

- EN Hole saw set
- PL Zestaw wycinarek do otworów w drewnie
- DE Lochsägensatz
- RU Пилы кольцевые по дереву в наборе
- CZ Sada děrovek do dřeva
- RO Set carote pt. lemn
- HU Kőrkívógó készlet
- ES Juego de sierras de corona para madera

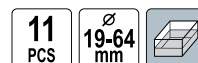

No.	Ø [mm]	pcs / szt.	
22570	19, 21, 28, 31, 37, 43, 51, 64	11	12/36

- EN Hole saw for wood with hardened teeth
- PL Wyrzynarka do drewna, hartowane zęby
- DE Lochsägensatz
- RU Пилы кольцевые по дереву закалённые зубья
- CZ Vyřezávací pila kalená
- RO Set freze circulare cu dinti caliti
- HU Szűrőfűrész edzett
- ES Sierra de corona curtido

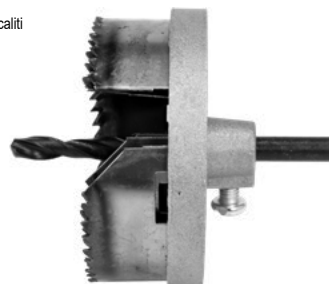
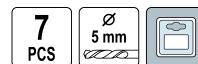

No.	Ø [mm]	Max. drilling depth / Maks. głębokość wiercenia [mm]	
28680	26, 32, 38, 45, 50, 56, 63	17	10/100
28690	26, 32, 38, 45, 50, 56, 63	43	10/80

EN Hole saw for wood  
 PL Wyrzynarka do drewna  
 DE Lochsägensatz  
 RU Пилы кольцевые по дереву  
 CZ Vyrézavací pila  
 RO Set freze decupat lemn  
 HU Szűrőfűrész  
 ES Sierra de corona

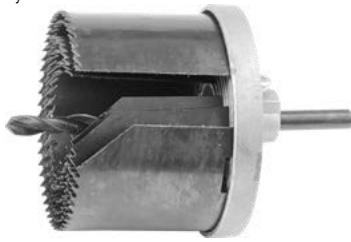
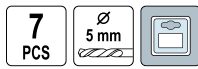

No.	Ø [mm]	Max. drilling depth / Maks. głębokość wiercenia [mm]	
28710	26, 32, 38, 45, 50, 56, 63	20	10/100
28720	26, 32, 38, 45, 50, 56, 63	43	10/80

EN Tungsten carbide coated hole saw set  
 PL Zestaw wycinarek wolframowych  
 DE Lochbohrersatz  
 RU Коронки вольфрамовые

CZ Sada děrovacích vrtáků pro keramiku  
 RO Set freze + maner  
 HU Kőrkívógó készlet wolfram borítással  
 ES Juego de punzones de wolframio



No.	Ø [mm]	
03300	33, 53, 67, 73	20
03301	33, 53, 67, 83	20

EN Drill for glass  
 PL Wiertło do szkła i ceramiki  
 DE Bohrer für Glas  
 RU Сверло по стеклу

CZ Vrták do skla  
 RO Burghiu pt. sticlă  
 HU Üvegfúró  
 ES Broca para vidrio

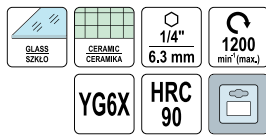

No.	Ø [mm]	L [mm]	
21700	3	60	125/500
21701	4	60	125/500
21702	5	70	125/500
21703	6	75	125/500
21704	8	80	125/500
21705	10	100	125/500
21706	12	100	100/400

EN Tool drill guide  
 PL Szablon do wyznaczania otworów  
 DE Schablone zur Markierung von Löchern  
 RU Шаблон для разметки отверстий  
 CZ Šablona pro značení otvorů  
 RO Instrument ghidare pt. gaurire  
 HU Nyílászablon  
 ES Plantilla para determinar perforaciones

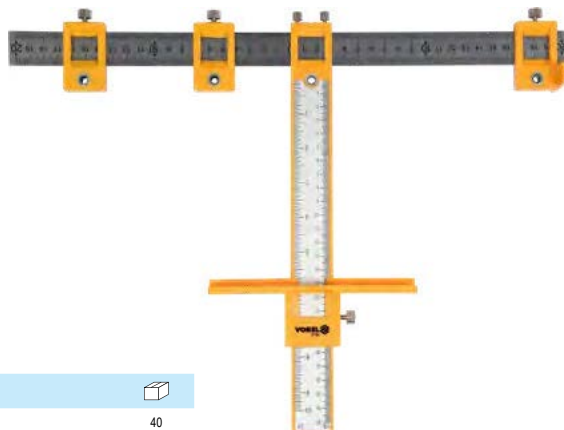

No.	L [mm]	
18180	200 (ramię poziome), 250 (listwa pionowa)	40

EN Hole saw set  
 PL Zestaw wycinarek do otworów  
 DE Lochsägensatz  
 RU Пилы кольцевые по дереву  
 CZ Vytlačáči otvorů  
 RO Set freze  
 HU Lyukasztó  
 ES Cortador de agujeros



No.	Ø [mm]	pcs / szt.	
28725	60, 67, 74, 81, 95	8	6/24

EN Tile and glass drill  
 PL Wiertło do szkła i glazury  
 DE Glas- und Fliesenbohrer  
 RU Сверло по плитке и стеклу

CZ Vrták do skla a glazury  
 RO Burghiu pt. sticlă și glazură  
 HU Üveg- és csempéfúró  
 ES Broca para cristal y azulejos



No.	Ø [mm]	L [mm]	
05540	4	80	50/100
05560	6	90	50/100
05580	8	95	50/100
05600	10	100	50/100

EN Glass and tile drills  
 PL Zestaw wiertel do szkła i ceramiki  
 DE Glas- und Fliesenbohrer  
 RU Набор сверл по стеклу и керамике  
 CZ Vrtáky do skla a keramiky  
 RO Set burghie pt. sticla si ceramica  
 HU Üveg és kerámi fúrók  
 ES Juego de brocas, ceramica



No.	Ø [mm]	pcs / szt.	
21709	4, 5, 6, 8, 10	5	25/100

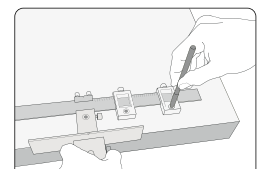

EN Depth collars for drills  
 PL Ograniczniki głębokości wiercenia  
 DE Bohrtiefenbegrenzersatz  
 RU Ограничители глубины сверления  
 CZ Omezovače hloubky vrtání  
 RO Limitator adancime pt. burghiu  
 HU Mélységűtközők  
 ES Topes de profundidad para brocas



No.	Ø [mm]	pcs / szt.	
24070	3, 4, 5, 6, 8, 10, 12, 16	8	20/120

EN Dowel set  
 PL Zestaw do połączeń kolkowych  
 DE Holzdübeln-Werkzeugsatz  
 RU Набор для соединения на шкантах  
 CZ Kolkovací sada  
 RO Set pt. imbinari cu dibluri lemni  
 HU Facsapozó készlet  
 ES Juego para ensamblaje de madera



**INCLUDED:**  
 - 30 pcs of wood dowel pins: 6 x 30 mm, 8 x 40 mm, 10 x 40 mm  
 - 6 pcs of dowelling centre points: 6, 8, 10 mm  
 - 3 pcs of drill stops: 6, 8, 10 mm  
 - 3 pcs of brad point drill bits: 6, 8, 10 mm  
 - Hex key

**W ZESTAWIE:**  
 - 30 kółków drewnianych rowkowanych: 6 x 30 mm, 8 x 40 mm, 10 x 40 mm  
 - 6 znaczników: 6, 8, 10 mm  
 - 3 ograniczniki głębokości wiercenia: 6, 8, 10 mm  
 - 3 wiertła do drewna: 6, 8, 10 mm  
 - Klucz imbusowy



No.	Ø [mm]	pcs / szt.	
24080	6, 8, 10	43	6/24

EN Woodworking doweling jig  
 PL Szablon do połączeń kolkowych  
 DE Dübel Bohrschablone  
 RU Кондуктор для сверления отверстий  
 CZ Kolkovací přípravek  
 RO Sablon pt. dibluri lemni  
 HU Típliző fúrósablon  
 ES Guía de perforación



No.	Ø [mm]	
24090	6, 8, 10	50

EN Hand taps  
 PL Gwintowniki  
 DE Handgewindebohrer  
 RU Метчик

CZ Závítníky  
 RO Tarozi  
 HU Menetfúró  
 ES Machos de roscar

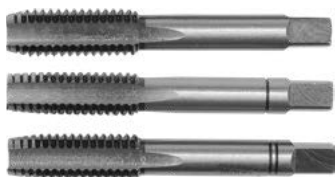

EN Dowelling centre points  
 PL Znaczniki do wyznaczania otworów  
 DE Holzdübel-Markierspitzen  
 RU Набор кернов для мебельных шкантов  
 CZ Značící hroty pro kolkování  
 RO Cep pt. centrare  
 HU Típlijelölő  
 ES Centradores

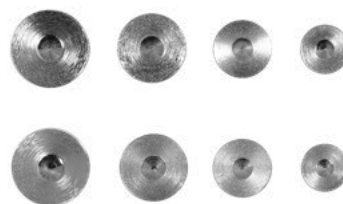

No.	Ø [mm]	pcs / szt.	
24060	6 x2, 8 x2, 10 x2, 12 x2	8	20/120

EN Pocket hole cutter set  
 PL Zestaw do połączeń kieszeniowych  
 DE Taschenbohrlehre Satz  
 RU Комплект для карманного соединения  
 CZ Šikmý otvor lokátor  
 RO Set pt. cepuri lemni  
 HU Zsebfurat-szűrő készlet  
 ES Juego para agujeros de bolsillo



Ø9.5x3.5 mm; 115x25x25 mm; 9.5 mm;



No.	
24091	10/40

EN Pocket hole plugs  
 PL Zasklepki do otworów kieszeniowych  
 DE Stöpsel zum Verschließen von Taschenlochbohrungen  
 RU Заглушки для карманных отверстий  
 CZ Zátky do šikmých otvorů  
 RO Cepuri lemni  
 HU Zsebfurat kitöltő  
 ES Tapones para agujeros de bolsillo

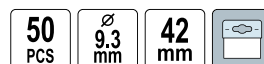

No.	Ø [mm]	L [mm]	pcs / szt.	
24095	9.3	42	50	100



sztool

No.	Size / Rozmiar	pcs / szt.	
24300	M3	3	25/100
24310	M4	3	25/100
24320	M5	3	25/100
24330	M6	3	25/100
24340	M7	3	25/100
24350	M8	3	25/100

No.	Size / Rozmiar	pcs / szt.	
24370	M10	3	25/100
24390	M12	3	25/100
24410	M14	3	20
24430	M16	3	20
24450	M18	3	20
24470	M20	3	20





EN Machine tap  
 PL Gwintownik maszynowy  
 DE Maschinengewindebohrer  
 RU Метчик машинный

CZ Strojní závitník  
 RO Tarod de mașină  
 HU Gépi menetfúró  
 ES Macho mecanico



No.	Size / Rozmiar	
24960	M3	25/100
24961	M4	25/100
24962	M5	25/100
24963	M6	25/100
24964	M8	25/100
24965	M10	25/100
24966	M12	25/100

EN Hand tap set  
 PL Komplet gwintowników  
 DE Innengewindebohrersatz  
 RU Набор метчиков  
 CZ Souprava závitníků  
 RO Set de tarozi  
 HU Menetfúró készlet  
 ES Juego de machos de roscar



No.	Size / Rozmiar	pcs / szt.	
24940	M3, M4, M5, M6, M7, M8, M10, M12	25	30

EN Ratchet tap wrench  
 PL Grzechotka do gwintownika  
 DE Gewindebohrerratsche  
 RU Вороток для метчиков с трещоткой  
 CZ Rečtačka na závitník  
 RO Cheie cu clichet pt. tarod  
 HU Racsnis hajtószer menetfúróhoz  
 ES Carraca para macho de roscar



No.	Size / Rozmiar	
24700	M3-M8	25/100
24710	M5-M12	25/100

EN Circular die  
 PL Narzynka  
 DE Schneideisen  
 RU Плашка  
 CZ Kruhová závitová čelist  
 RO Filieră  
 HU Menetvágó  
 ES Cojnete de roscar



cztool

No.	Size / Rozmiar	
24500	M3	25/100
24510	M4	25/100
24520	M5	25/100
24530	M6	25/100
24550	M8	25/100
24570	M10	25/100
24590	M12	25/100
24610	M14	25/100
24630	M16	15/60
24650	M18	30/60
24670	M20	15/60

EN Tap and die set  
 PL Komplet gwintowników i narzynek  
 DE Gewindeschneidwerkzeugsatz  
 RU Набор плашек и метчиков  
 CZ Souprava závitníků a kruhových závitových čelistí  
 RO Set de tarozi și filiere  
 HU Menetfúró és menetvágó készlet  
 ES Juego de machos de roscar y cojnetes



No.	Size / Rozmiar	pcs / szt.	
24900	M3, M4, M5, M6, M8, M10, M12	32	10

EN Tap wrench  
 PL Pokrętło do gwintownika  
 DE Windeisen  
 RU Вороток для метчиков  
 CZ Ovládací kolečko na závitník  
 RO Cheie (măner) pt. tarod  
 HU Hajtószer menetfúróhoz  
 ES Llave giramachos



No.	Size / Rozmiar	
24730	M4-M8	30
24740	M9-M12	25
24750	M13-M18	20

- EN Die holder
- PL Oprawka do narzynek
- DE Schneisenhalter
- RU Плашкодержатель
- CZ Závrtová objímka
- RO Portfiliere
- HU Menetvágó tartó
- ES Portacojinele



No.	Size / Rozmiar	
24800	M3-M6	30
24810	M7-M9	25
24813	M10-M11	25
24820	M12-M14	30
24823	M15-M16	20

- EN Screw extractor set
- PL Wykrętki do zerwaných šrub
- DE Schraubenausreihersatz
- RU Набор для извлечения обломанных болтов
- CZ Vrtáky do přetržených šroubu
- RO Capele pt. deșurubat șuruburi rupte
- HU Törtcsavar kiszedő készlet
- ES Destornillador para tornillos arrancados



No.	Size / Rozmiar	pcs / szt.	
24000	1/8" (3.2 mm) - 1/4" (6.3 mm), 1/4" (6.3 mm) - 5/16" (7.9 mm), 5/16" (7.9 mm) - 7/16" (11.1 mm), 7/16" (11.1 mm) - 9/16" (14.3 mm), 9/16" (14.3 mm) - 3/4" (19.0 mm)	5	12/120

- EN Router bit set
- PL Zestaw frezów do drewna
- DE Oberfräsersatz
- RU Набор фрез по дереву
- CZ Souprava frézů do dřeva
- RO Set de freze pt. lemn
- HU Medőjo frezj komplextas
- ES Juego de frezas para madera



No.	Toolholder size / Rozmiar uchwytu narzędziowego [mm]	pcs / szt.	
22550	8	12	5/20

- EN Router bit set
- PL Zestaw frezów do drewna
- DE Oberfräsersatz
- RU Набор фрез по дереву
- CZ Souprava frézů do dřeva
- RO Set de freze pt. lemn
- HU Medőjo frezj komplextas
- ES Juego de frezas para madera

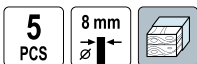

No.	Ø [mm]	Toolholder size / Rozmiar uchwytu narzędziowego [mm]	pcs / szt.	
22551	15, 20, 25, 30, 35	8	5	5/20

- EN Tap and die set
- PL Komplet gwintowników i narzynek
- DE Gewindefräsenwerkzeugsatz
- RU Набор плашек и метчиков
- CZ Souprava závitníků a kruhových závitových čelistí
- RO Set de tarozi și filiere
- HU Menetfűró és menetvágó készlet
- ES Juego de machos de rosar y cojinetes



No.	Size / Rozmiar	
24295	M3, M4, M5, M6, M8, M10, M12, M3-M12, M3-M12	10/20

- EN Router bit set
- PL Zestaw frezów do drewna
- DE Oberfräsersatz
- RU Набор фрез по дереву
- CZ Souprava frézů do dřeva
- RO Set de freze pt. lemn
- HU Medőjo frezj komplextas
- ES Juego de frezas para madera



No.	Ø [mm]	Toolholder size / Rozmiar uchwytu narzędziowego [mm]	pcs / szt.	
22552	6, 12, 12.7, 16, 22, 25.4, 28.0, 32	6	12	20

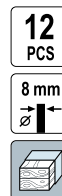

- EN Rotary file set
- PL Tamiki trzpieniowe
- DE Profil-Fräser Satz
- RU Набор фрез
- CZ Hrotové rašple
- RO Rașpeluri cu coadă
- HU Fareszelőkészlet, csapszárás
- ES Rotatorio archivos



No.	pcs / szt.	
25405	6	50/300

EN Diamond blade segmented  
 PL Tarcza diamentowa "segment"  
 DE Diamanttrennscheibe  
 RU Диск алмазный сегментированный

CZ Diamantový kotouč segmentový  
 RO Disc diamantat segmentat  
 HU Szegmens gyémántkorong  
 ES Disco de diamante de segmentos

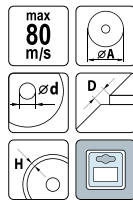

No.	ØA [mm]	Ød [mm]	max C [min <sup>-1</sup> ]	D [mm]	H [mm]	
08711	115	22.2	12000	2.0	8	20/200
08712	125	22.2	11000	2.1	8	20/160
08714	180	22.2	8000	2.2	8	15/60
08715	230	22.2	6500	2.4	8	10/40

EN Diamond blade continuous rim  
 PL Tarcza diamentowa pełna  
 DE Diamanttrennscheibe  
 RU Диск алмазный сплошной

CZ Diamantový kotouč plný  
 RO Disc diamantat margine continua  
 HU Gyémántkorong (teljes)  
 ES Disco de diamante

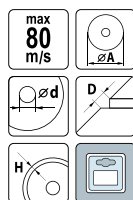

No.	ØA [mm]	Ød [mm]	max C [min <sup>-1</sup> ]	D [mm]	H [mm]	
08731	115	22.2	12000	1.6	5	20/200
08732	125	22.2	11000	1.6	5	20/160
08734	180	22.2	8000	1.8	5	15/60
08735	230	22.2	6500	2.4	5	10/40

EN Diamond blade turbo  
 PL Tarcza diamentowa turbo  
 DE Diamanttrennscheibe Turbo  
 RU Отрезной алмазный диск турбо

CZ Diamantový kotouč turbo  
 RO Disc diamantat turbo  
 HU Gyémántkorong turbo  
 ES Disco de diamante turbo

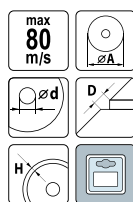

No.	ØA [mm]	Ød [mm]	max C [min <sup>-1</sup> ]	D [mm]	H [mm]	
08751	115	22.2	12000	2.0	8	20/200
08752	125	22.2	11000	2.0	8	20/160
08754	180	22.2	8000	2.2	8	15/60
08755	230	22.2	6500	2.4	8	10/40

EN Diamond blade segmented  
 PL Tarcza diamentowa "segment"  
 DE Diamanttrennscheibe  
 RU Диск алмазный сегментированный

CZ Diamantový kotouč segmentový  
 RO Disc diamantat segmentat  
 HU Szegmens gyémántkorong  
 ES Disco de diamante de segmentos

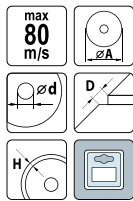

No.	ØA [mm]	Ød [mm]	max C [min <sup>-1</sup> ]	D [mm]	H [mm]	
08780	115	22.2	13200	1.9	7	20/120
08781	125	22.2	12000	2.0	7	20/120
08782	180	22.2	8400	2.3	7	15/45
08783	230	22.2	6600	2.4	7	10/30

EN Diamond blade continuous rim  
 PL Tarcza diamentowa pełna  
 DE Diamanttrennscheibe  
 RU Диск алмазный сплошной

CZ Diamantový kotouč plný  
 RO Disc diamantat margine continua  
 HU Gyémántkorong teljes  
 ES Disco de diamante

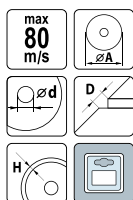

No.	ØA [mm]	Ød [mm]	max C [min <sup>-1</sup> ]	D [mm]	H [mm]	
08785	115	22.2	13200	1.9	5	20/120
08786	125	22.2	12000	2.0	5	20/120
08788	230	22.2	6600	2.4	5	10/30

EN Diamond blade turbo  
 PL Tarcza diamentowa turbo  
 DE Diamanttrennscheibe Turbo  
 RU Отрезной алмазный диск турбо

CZ Diamantový kotouč turbo  
 RO Disc diamantat turbo  
 HU Gyémántkorong turbo  
 ES Disco de diamante turbo

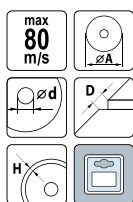

No.	ØA [mm]	Ød [mm]	max C [min <sup>-1</sup> ]	D [mm]	H [mm]	
08790	115	22.2	13200	2.0	7.0	20/120
08791	125	22.2	12000	2.1	7.0	20/120
08792	180	22.2	8400	2.4	7.5	15/45
08793	230	22.2	6600	2.6	7.5	10/30

- EN Diamond rod saw
- PL Brzeszczot diamentowy
- DE Diamantsägekordel
- RU Полотно алмазное
- CZ Lanko pivoie diamantowe
- RO Panze diamantate
- HU Fűrészlap-pálca, gyémántbevonatú
- ES Hoja de sierra de diamante



No.	L [mm]	
27575	300	20/100

- EN TCT circular saw blade for aluminium
- PL Pila tarczowa do aluminium z węglikiem wolframu
- DE Hartmetallbestückt Kreissägeblatt für Aluminium
- RU Диск пильный по алюминию
- CZ Kotoučová pila na hliník s karbidem wolframu
- RO Disc circular pt. aluminiu
- HU Wolframkarbidos körfűrészlap, alumíniumhoz
- ES Disco de sierra con carbono



No.	Ø [mm]	Ød [mm]	max C [min <sup>-1</sup> ]	D [mm]	s [mm]	T	
08853	210	30	6500	2.2	1.6	72	10/20
08854	250	30	5400	3.0	1.8	100	10/20
08855	300	30	4500	3.2	2.0	100	10

- EN Metal cutting disc
- PL Tarcza do cięcia metalu
- DE Trennscheibe für Metall
- RU Диск отрезной по металлу
- CZ Kotouč pro řezání kovu
- RO Disc debitat metale
- HU Vágókorong fémhez
- ES Disco cortador para metal

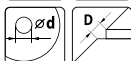
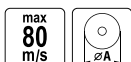

No.	ØA [mm]	Ød [mm]	max C [min <sup>-1</sup> ]	D [mm]	
08630	115	22	12000	1.0	25/200
08633	115	22	13300	2.5	25/200
08631	125	22	11000	1.0	25/200
08635	125	22	12200	2.5	25/200
08639	230	22	6600	1.6	25/50
08640	230	22	6600	3.2	25/50
08641	230	22	6600	2.5	25/50
08642	300	32	5100	3.2	10/20
08644	350	32	4400	3.5	10/20
08646	400	32	3800	4.0	10/20

- EN TCT circular saw blade for wood
- PL Pila tarczowa do drewna z węglikiem wolframu
- DE Kreissägeblatt HM-Bestückt
- RU Диск пильный с карбидом вольфрама
- CZ Kotoučová pila na dřevo z karbidem wolframu
- RO Ferăstrău circular cu dinți din wolfram pt. lemn
- HU Wolframkarbidos körfűrész fához
- ES Disco de sierra con carbono de tungsteno

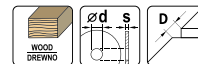

No.	Ø [mm]	Ød [mm]	max C [min <sup>-1</sup> ]	D [mm]	s [mm]	T	
08811	140	20	9600	2.0	1.3	16	25/50
08819	160	20	8300	2.0	1.4	18	25/50
08820	160	30	8300	2.0	1.4	24	25/50
08821	160	30	8300	2.0	1.4	36	25/50
08822	160	20	8300	2.0	1.4	48	25/50
08825	184	30	7400	2.2	1.4	24	10/20
08827	184	30	7400	2.2	1.4	40	10/20
08828	185	20	7400	2.2	1.4	18	10/20
08829	200	30	6500	2.2	1.6	24	10/20
08831	210	30	6500	2.2	1.6	40	10/20
08832	210	30	6500	2.2	1.6	60	10/20
08833	250	30	5400	3.0	1.8	24	10/20
08834	250	30	5400	3.0	1.8	40	10/20
08835	250	30	5400	3.0	1.8	60	10/20
08837	300	30	4500	3.2	2.0	40	10
08838	300	30	4500	3.2	2.0	60	10
08845	350	30	3800	3.2	2.2	40	10
08851	400	30	3300	3.2	2.2	60	10

- EN Metal cutting disc
- PL Tarcza do cięcia metalu
- DE Trennscheibe für Metall
- RU Диск отрезной по металлу
- CZ Kotouč pro řezání kovu
- RO Disc debitat metale
- HU Vágókorong fémhez
- ES Disco cortador para metal



No.	ØA [mm]	Ød [mm]	max C [min <sup>-1</sup> ]	D [mm]	
08170	115	22	13200	1.0	25/200
08174	115	22	13200	3.0	25/200
08171	125	22	12200	1.0	25/200
08175	125	22	12200	3.0	25/200



EN Metal grinding disc - depressed centre  
 PL Tarcza do szlifowania metalu wypukła  
 DE Metall-Schleifscheibe gewölbt  
 RU Диск шлифовальный по металлу

CZ Kotouč pro broušení kovu  
 RO Disc pt. șlefuit metal  
 HU Vágókorong fémhez  
 ES Disco de pulir de metalo

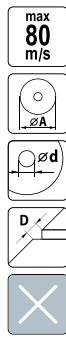

No.	ØA [mm]	Ød [mm]	max C [min <sup>-1</sup> ]	D [mm]	
08663	115	22	13300	6.0	25/100
08665	125	22	11000	6.8	25/100
08669	230	22	6600	6.8	25/50

EN Metal grinding disc - depressed centre  
 PL Tarcza do szlifowania metalu wypukła  
 DE Metall-Schleifscheibe gewölbt  
 RU Диск шлифовальный по металлу выпуклый  
 CZ Kotouč pro broušení kovu  
 RO Disc pt. șlefuit metal  
 HU Vágókorong fémhez  
 ES Disco de pulir de metalo



No.	ØA [mm]	Ød [mm]	max C [min <sup>-1</sup> ]	D [mm]	
08190	115	22	13200	6	25/100
08191	125	22	12200	6	25/100

EN Stone cutting disc  
 PL Tarcza do cięcia kamienia  
 DE Stein-Trennscheibe  
 RU Диск отрезной по камню  
 CZ Kotouč pro řezání kamene  
 RO Disc pt. tăiat piatră  
 HU Vágókorong kőhöz  
 ES Disco cortador de piedra



No.	ØA [mm]	Ød [mm]	max C [min <sup>-1</sup> ]	D [mm]	
08671	115	22	13200	3.2	25/200
08672	125	22	12200	3.2	25/200
08674	230	22	6600	3.2	25/50

EN Stone grinding disc - depressed centre  
 PL Tarcza do szlifowania kamienia wypukła  
 DE Stein-Schleifscheibe gewölbt  
 RU Диск шлифовальный по камню  
 CZ Kotouč pro broušení kamene  
 RO Disc pt. șlefuit piatră  
 HU Csiszolókorong kőhöz  
 ES Disco de pulir de piedra



No.	ØA [mm]	Ød [mm]	max C [min <sup>-1</sup> ]	D [mm]	
08683	125	22	11000	6.8	25/100

EN Abrasive disc  
 PL Ściernica listkowa talerzowa  
 DE Lameller  
 RU Диск лепестковый

CZ Kotouč brusný lamelový  
 RO Disc abraziv  
 HU Lamellás csiszoló  
 ES Disco abrasivo



No.	Grit / Ziamistość	Ø [mm]	max C [min <sup>-1</sup> ]	
07974	P40	115	13300	50/200
07984	P40	125	12300	50/200
07975	P60	115	13300	50/200
07985	P60	125	12300	50/200
07976	P80	115	13300	50/200
07986	P80	125	12300	50/200
07977	P100	115	13300	50/200
07987	P100	125	12300	50/200
07978	P120	115	13300	50/200
07988	P120	125	12300	50/200

EN Grinding disc  
 PL Tarcza do szlifierki stolowej  
 DE Schleifscheibe  
 RU Круг для настольного точильного станка  
 CZ Brusný kotouč  
 RO Discul abraziv  
 HU Kőszűrőkő  
 ES Disco abrasivo



No.	Ø [mm]	Mounting hole diameter / Średnica mocowania [mm]	Thickness / Grubość [mm]	max C [min <sup>-1</sup> ]	
08876	200	20	40	3850	5

- EN Grinding disc
- PL Tarcza do szlifierki stołowej
- DE Schleifscheibe
- RU Круг для настольного точильного станка
- CZ Brusný kotouč
- RO Discul abraziv
- HU Kőszőrűkő
- ES Disco abrasivo



No.	Ø [mm]	Mounting hole diameter / Średnica mocowania [mm]	Thickness / Grubość [mm]	max C [min <sup>-1</sup> ]	Grit / Ziarnistość	
08860	125	12.7	17	5850	gruboziański	10
08861	125	12.7	17	5850	drobnoziarnisty	10
08864	150	12.7	17	5350	gruboziański	10
08865	150	12.7	17	5350	drobnoziarnisty	10
08868	150	31.8	25	5350	gruboziański	10
08869	150	31.8	25	5350	drobnoziarnisty	10
08873	200	15.9	20	3850	drobnoziarnisty	10
08875	200	31.8	30	3850	drobnoziarnisty	10

- EN Figure tin snips
- PL Nożyce do blachy
- DE Blechscherer
- RU Ножницы по металлу
- CZ Nůžky na plech
- RO Foarfece pt. tablă
- HU Lemezvágó olló
- ES Tijeras para hojalata

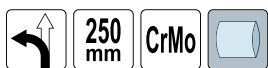

No.	L [mm]	Max. cutting capacity in cold-rolled steel / Maks. grubość cięcia w stali walcowanej na zimno [mm]	
48000	250	1.5	6/36

- EN Figure tin snips
- PL Nożyce do blachy
- DE Blechscherer
- RU Ножницы по металлу
- CZ Nůžky na plech
- RO Foarfece pt. tablă
- HU Lemezvágó olló
- ES Tijeras para hojalata



No.	L [mm]	Max. cutting capacity in cold-rolled steel / Maks. grubość cięcia w stali walcowanej na zimno [mm]	
48080	250	1	6/36

- EN Grinding wheel dresser
- PL Przyrząd do wyrównywania tarcz szlifierskich
- DE Schleifscheiben-Abrichter
- RU Шарошка для выравнивания абразивных дисков
- CZ Zařízení pro vyrovnávání brusných kotoučů
- RO Dresser cu roată de șlefuit
- HU Csiszolókorong szabályzó
- ES Rectificador de muelas abrasivas

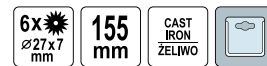

No.	L [mm]	
08900	155	12/48

- EN Figure tin snips
- PL Nożyce do blachy
- DE Blechscherer
- RU Ножницы по металлу
- CZ Nůžky na plech
- RO Foarfece pt. tablă
- HU Lemezvágó olló
- ES Tijeras para hojalata

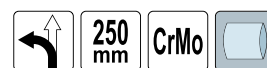

No.	L [mm]	Max. cutting capacity in cold-rolled steel / Maks. grubość cięcia w stali walcowanej na zimno [mm]	
48060	250	1.2	6/48

- EN Figure tin snips
- PL Nożyce do blachy
- DE Blechscherer
- RU Ножницы по металлу
- CZ Nůžky na plech
- RO Foarfece pt. tablă
- HU Lemezvágó olló
- ES Tijeras para hojalata



No.	L [mm]	
48100	250	6/60

EN Figure tin snips  
 PL Nożyce do blachy  
 DE Blechscherer  
 RU Ножницы по металлу  
 CZ Nůžky na plech  
 RO Foarfece pt. tablă  
 HU Lemezvágó olló  
 ES Tijeras para hojalata



**VOREL**

No.	L [mm]	Max. cutting capacity in cold-rolled steel / Maks. grubość cięcia w stali walcowanej na zimno [mm]	Box icon
48082	250	1	6/36

EN Figure tin snips  
 PL Nożyce do blachy  
 DE Blechscherer  
 RU Ножницы по металлу  
 CZ Nůžky na plech  
 RO Foarfece pt. tablă  
 HU Lemezvágó olló  
 ES Tijeras para hojalata

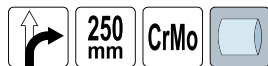

**VOREL**

No.	L [mm]	Max. cutting capacity in cold-rolled steel / Maks. grubość cięcia w stali walcowanej na zimno [mm]	Box icon
48050	250	1.5	6/36

EN Figure tin snips  
 PL Nożyce do blachy  
 DE Blechscherer  
 RU Ножницы по металлу  
 CZ Nůžky na plech  
 RO Foarfece pt. tablă  
 HU Lemezvágó olló  
 ES Tijeras para hojalata



**VOREL**

No.	L [mm]	Max. cutting capacity in cold-rolled steel / Maks. grubość cięcia w stali walcowanej na zimno [mm]	Box icon
48081	250	1	6/36

EN Figure tin snips  
 PL Nożyce do blachy  
 DE Blechscherer  
 RU Ножницы по металлу  
 CZ Nůžky na plech  
 RO Foarfece pt. tablă  
 HU Lemezvágó olló  
 ES Tijeras para hojalata



No.	L [mm]	pcs / szt.	Box icon
48330	250	3	5/20

EN Figure tin snips  
 PL Nożyce do blachy  
 DE Blechscherer  
 RU Ножницы по металлу  
 CZ Nůžky na plech  
 RO Foarfece pt. tablă  
 HU Lemezvágó olló  
 ES Tijeras para hojalata



No.	L [mm]	Box icon
48200	250	6/60

EN Figure tin snips  
 PL Nożyce do blachy  
 DE Blechscherer  
 RU Ножницы по металлу  
 CZ Nůžky na plech  
 RO Foarfece pt. tablă  
 HU Lemezvágó olló  
 ES Tijeras para hojalata

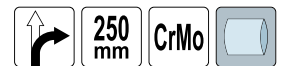

**VOREL**

No.	L [mm]	Max. cutting capacity in cold-rolled steel / Maks. grubość cięcia w stali walcowanej na zimno [mm]	Box icon
48070	250	1.2	6/48

EN Figure tin snips  
 PL Nożyce do blachy  
 DE Blechscherer  
 RU Ножницы по металлу

CZ Nůžky na plech  
 RO Foarfece pt. tablă  
 HU Lemezvágó olló  
 ES Tijeras para hojalata



No.	L [mm]	Box icon
48150	250	6/60

EN Bolt cutter  
 PL Nożyce do drutu  
 DE Drahtschere  
 RU Болторез

CZ Nůžky na drát  
 RO Cleste pt. buloane  
 HU Drótvágó olló  
 ES Tijeras para alambre



No.	L [mm]	Box icon
49200	200	15/60

EN Bolt cutter  
 PL Nożyce do prętów  
 DE Bolzenschneider  
 RU Болторезы

CZ Nůžky na tyče  
 RO Clește pt. buleoane  
 HU Drótvágó olló  
 ES Cortavarillas



No.	L [mm]	Icon
49450	450	20
49600	600	1/10

EN Miter shears  
 PL Nożyce wielofunkcyjne do węży, rurek, listew  
 DE Mitre Scheren  
 RU Ножницы угловые для пластмассовых и резиновых профилей  
 CZ Úhlové nůžky  
 RO Foarfeca de mana pt. taiat garnituri  
 HU Gérvágó olló  
 ES Tijeras multifuncionales para mangueras, tubos, molduras

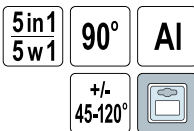

**VOREL**

No.	Hose diameter / Srednica węża [mm]	Icon
48350	17, 20, 27	6/24

EN Hand saw for wood  
 PL Pila płatnica do drewna  
 DE Handsäge für Holz  
 RU Ручная пила по дереву  
 CZ Ruční pila na dřevo  
 RO Fierastrău „coada de vulpe” pt. lemn  
 HU Rókafarkú fűrész  
 ES Serrucho para carpintero

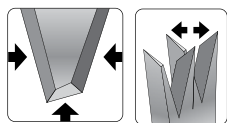
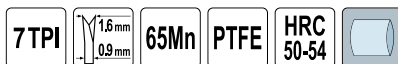

**VOREL**

No.	L [mm]	Icon
28385	400	12/48
28386	450	10/40
28387	500	10/40

EN Bolt cutter  
 PL Nożyce do prętów  
 DE Bolzenschneider  
 RU Болторезы

CZ Nůžky na tyče  
 RO Clește pt. buleoane  
 HU Drótvágó olló  
 ES Cortavarillas



No.	L [mm]	Max. cutting diameter / Maks. średnica cięcia [mm]	Icon
49770	350	6	1/24
49771	450	8	1/12
49772	600	10	1/12
49773	750	12	6
49774	900	14	4
49775	1050	16	2

EN Hand saw for wood  
 PL Pila płatnica do drewna  
 DE Handsäge für Holz  
 RU Ручная пила по дереву

CZ Ruční pila na dřevo  
 RO Fierastrău „coada de vulpe” pt. lemn  
 HU Rókafarkú fűrész  
 ES Serrucho para carpintero



No.	L [mm]	Icon
28380	400	10/40
28381	450	10/40
28382	500	10/40

EN Hand saw for wood  
 PL Pila płatnica do drewna  
 DE Handsäge für Holz  
 RU Ручная пила по дереву  
 CZ Ruční pila na dřevo  
 RO Fierastrău „coada de vulpe” pt. lemn  
 HU Rókafarkú fűrész  
 ES Serrucho para carpintero

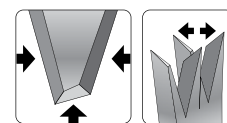
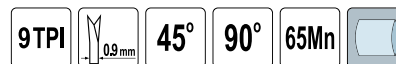

No.	L [mm]	Icon
28370	350	12/48
28371	400	12/48
28372	450	12/48
28373	500	12/48



EN Hand saw for wood  
 PL Pila platnica do drewna  
 DE Handsäge für Holz  
 RU Ручная пила по дереву

CZ Ruční pila na dřevo  
 RO Fierastrău „coada de vulpe” pt. lemn  
 HU Rókafarkú fűrész  
 ES Serrucho para carpintero



No.	L [mm]	
28394	400	12/60
28395	450	12/60

EN Bow saw  
 PL Pila kabląkowa  
 DE Bügelsäge  
 RU Лучковая пила по дереву  
 CZ Oblouková pila  
 RO Ferăstrău de curbură  
 HU Keretes fűrész  
 ES Arco de sierra



No.	L [mm]	
28745	530	12/24

EN Bow saw blade for wet wood  
 PL Brzeczczot do drewna mokrego  
 DE Bügelsägeblatt für frisches Holz  
 RU Полотно для лучковой пилы по влажному дереву  
 CZ Pilový list na mokré dřevo  
 RO Lamă pt. lemn verde  
 HU Keretes fűrészhez fűrészlap nedves fához  
 ES Hoja de sierra para madera húmeda

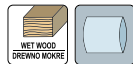

No.	L [mm]	W [mm]	
28771	530	20	60/240
28772	610	20	60/240
28773	760	20	60/240

EN Saw for gas concrete  
 PL Pila do gazobetonu  
 DE Gasbetonsäge  
 RU Пила по газобетону с твердосплавным зубом  
 CZ Pila na plynobeton  
 RO Fierastrău cu placute vidia pt. BCA  
 HU Fűrész gázbetonhoz  
 ES Sierra para gas hormigon



No.	L [mm]	T	
28011	600	15	6/12
28012	660	34	6/12

EN Bow saw  
 PL Pila kabląkowa  
 DE Bügelsäge  
 RU Лучковая пила по дереву

CZ Oblouková pila  
 RO Ferăstrău de curbură  
 HU Keretes fűrész  
 ES Arco de sierra

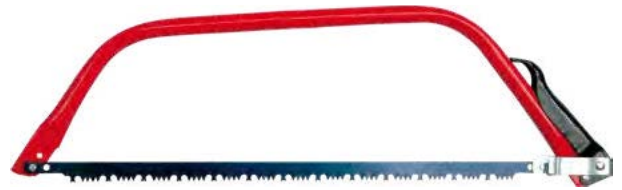

No.	L [mm]	
28740	525	24
28750	750	24

EN Bow saw  
 PL Pila kabląkowa  
 DE Bügelsäge  
 RU Лучковая пила по дереву

CZ Oblouková pila  
 RO Ferăstrău de curbură  
 HU Keretes fűrész  
 ES Arco de sierra



No.	L [mm]	
28746	610	12/24
28755	760	12/24

EN Compass saw  
 PL Pila otwornica  
 DE Astsäge  
 RU Пила выкружная

CZ Pila otvornice  
 RO Ferăstrău coadă de șoarece  
 HU Lyukfűrész  
 ES Sierra compas



No.	L [mm]	
28650	300	30/120

EN Hand saw with replaceable blades  
 PL Pila ręczna z wymiennymi brzeczczotami  
 DE Handsäge mit austauschbaren Sägeblättern  
 RU Ножовка со сменными полотнами  
 CZ Ruční pila s vyměnitelnými čepeliemi  
 RO Ferăstrău manual cu lame înlocuibile  
 HU Kézifűrész cserélhető lapokkal  
 ES Sierra de mano con hojas intercambiables



No.	
28401	12/48

EN Hacksaw frame  
 PL Pila do metalu  
 DE Metallsägebogen  
 RU Ножовка по металлу  
 CZ Pila na kov  
 RO Ferăstrău pt. metal  
 HU Fémfűrész  
 ES Sierra de metalo



No.	L [mm]	
27000	300	12/48

EN Hacksaw frame  
 PL Pila do metalu  
 DE Metallsägebogen  
 RU Ножовка по металлу  
 CZ Pila na kov  
 RO Ferăstrău pt. metal  
 HU Fémfűrész  
 ES Sierra de metalo

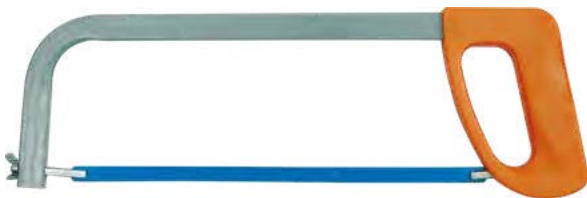

No.	L [mm]	
27200	300	20/60

EN Hacksaw frame  
 PL Pila do metalu  
 DE Metallsägebogen  
 RU Ножовка по металлу  
 CZ Pila na kov  
 RO Ferăstrău pt. metal  
 HU Fémfűrész  
 ES Sierra de metalo



JUKO

No.	L [mm]	
27495	300	5

EN Hack saw set  
 PL Zestaw pil do metalu  
 DE Metallsägen  
 RU Набор пил по металлу  
 CZ Sada pil na kov  
 RO Set bomfaiere  
 HU Fémfűrész készlet  
 ES Sierras de metal, juego

VOREL

No.	L [mm]	pcs / szt.	
27333	150, 300, 300	3	6/36



EN Hacksaw frame  
 PL Pila do metalu  
 DE Metallsägebogen  
 RU Ножовка по металлу  
 CZ Pila na kov  
 RO Ferăstrău pt. metal  
 HU Fémfűrész  
 ES Sierra de metalo



No.	L [mm]	
27100	250-300	12/60

EN Hacksaw frame  
 PL Pila do metalu  
 DE Metallsägebogen  
 RU Ножовка по металлу  
 CZ Pila na kov  
 RO Ferăstrău pt. metal  
 HU Fémfűrész  
 ES Sierra de metalo



No.	L [mm]	
27322	300	6/36

EN Hacksaw frame  
 PL Pila do metalu  
 DE Metallsägebogen  
 RU Ножовка по металлу  
 CZ Pila na kov  
 RO Ferăstrău pt. metal  
 HU Fémfűrész  
 ES Sierra de metalo



No.	L [mm]	
27600	150	30/150

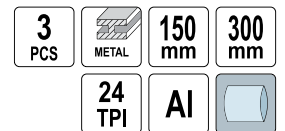

EN Multi-functional hand saw with multiple blades  
 PL Pila wielofunkcyjna z zestawem akcesoriów  
 DE Multifunktionale magische Säge  
 RU Многофункциональная волшебная пила

CZ Multifunkční ruční dřevěná pila  
 RO Fierastrău multifunctional cu lame de rezerva  
 HU Varázs fűrész  
 ES Sierra mágica multifuncional



- INCLUDED:**
- Multi-functional hand saw
  - 6 universal blades 150 mm for wood, metal and plastics
  - 2 diamond blades: round blade for glass and tiles, flat blade 6 mm
  - 2 tile cutters
  - Frame with round blade for cutting glass and with teeth for breaking glass or tiles
  - Wing bolt
  - Flat blade 175 x 20 mm for wood and plastics
- W ZESTAWIE:**
- Pila modelarska
  - 6 uniwersalnych brzeszczotów 150 mm do drewna, metalu i tworzyw
  - 2 brzeszczoty diamentowe: okrągły do ceramiki i szkła oraz płaski 6 mm
  - 2 rysiki do ceramiki
  - Rama z okrągłym nożem do cięcia szkła oraz wycięciami do łamania szkła lub ceramiki
  - Nakrętka skrzydełkowa
  - Brzeszczot płaski 175 x 20 mm do agresywnego cięcia drewna i tworzyw



No.	30
27610	

EN Handle for reciprocating saw blades with accessories  
 PL Uchwyt do brzeszczotów bagnetowych z akcesoriami  
 DE Handgriff für Säbelsägeblätter mit Zubehör  
 RU Рукоятка для сабельных пил с аксессуарами  
 CZ Rukojeť pro pilové plátky s příslušenstvím  
 RO Măner pt. pânze de ferăstrău cu accesorii  
 HU Fogantyú dugattyús fűrészlapokhoz kiegészítőkkel  
 ES Mango para hojas de sierra de sable con accesorios

18 PCS	WOOD DREWNO	METAL	150 mm
6 TPI	14 TPI	HCS 65Mn	M2 6150



- 1/4" (6.3 mm): 5, 6 mm (L=25 mm);
- ⊕ 1/4" (6.3 mm): PH1, PH2 (L=25 mm);
- ⊕ 1/4" (6.3 mm): PZ1, PZ2 (L=25 mm);
- ⊕ 1/4" (6.3 mm): T15, T20 (L=25 mm);
- 1/4" (6.3 mm): 5, 6 mm (L=25 mm);
- 1/4" (6.3 mm): S1, S2 (L=25 mm);
- 1/4" (6.3 mm);
- ~ 14 TPI, 65 Mn (L=150 mm) x3;
- ~ 6 TPI, 6150 M2 (L=150 mm) x2

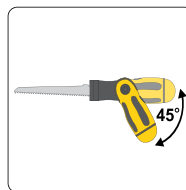

No.	L [mm]	TPI	pcs / szt.	Icon
27630	150	6, 14	18	5/20

EN Precision mitre saw  
 PL Pila kątowa  
 DE Präzisions-Gehrungssäge  
 RU Ступло наклонное с пилой  
 CZ Pokosová úhlová pila  
 RO Fierăstrău pt. tăiat la unghi  
 HU Kézi gérvágó fűrész  
 ES Sierra ingletadora manual

EN Cross - cut saw  
 PL Pila poprzeczna  
 DE Bauchsäge  
 RU Пила двуручная

CZ Pila břichatka  
 RO Joagar  
 HU Keresztvágó fűrész  
 ES Sierra para corte cruzado

100 cm	Icon
--------	------



No.	L [cm]	Type / Typ	Icon
28790	100	L-1000	10

EN Precision mitre saw  
 PL Pila kątowa  
 DE Präzisions-Gehrungssäge  
 RU Ступло поворотное с пилой  
 CZ Úhlová pila  
 RO Fierăstrău pt. tăiat la unghi  
 HU Kézi gérvágó fűrész  
 ES Sierra ingletadora manual

550 mm	Icon
--------	------



No.	Saw blade length / Długość brzeszczotu [mm]	Horizontal cutting angle / Kąt cięcia w płaszczyźnie poziomej [°]	Icon
29000	550	22.5, 30, 36, 45, 90	1

EN Precision mitre saw  
 PL Pila kątowa uchylna  
 DE Kippbare Präzisions-Gehrungssäge  
 RU Ступло наклонное с пилой  
 CZ Pokosová úhlová pila  
 RO Fierăstrău pt. tăiat la unghi  
 HU Kézi gérvágó fűrész  
 ES Sierra ingletadora manual

550 mm	±45°	Icon
--------	------	------



No.	Saw blade length / Długość brzeszczotu [mm]	Horizontal cutting angle / Kąt cięcia w płaszczyźnie poziomej [°]	Icon
29050	550	45, 55, 60, 72, 90	1

EN Miter box  
 PL Skrzynka uciowska  
 DE Schneidlade  
 RU Крыцо  
 CZ Pokosová krabička  
 RO Cutie pt. tăiat oblic  
 HU Gervágó doboz  
 ES Caja de ingletes

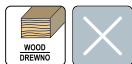

No.	Dimensions / Wymiary [mm]	
29210	300x80	10
29220	450x105	12

8

EN Miter box  
 PL Skrzynka uciowska  
 DE Schneidlade  
 RU Крыцо  
 CZ Pokosová krabička  
 RO Cutie pt. tăiat oblic  
 HU Gervágó doboz  
 ES Caja de ingletes



No.	External dimensions / Wymiary zewnętrzne [mm]	
29313	280x132x102	30

EN Miter box  
 PL Skrzynka uciowska  
 DE Schneidlade  
 RU Крыцо  
 CZ Pokosová krabička  
 RO Cutie pt. tăiat oblic  
 HU Gervágó doboz  
 ES Caja de ingletes



No.	Dimensions / Wymiary [mm]	
29323	326x122x78	18

EN Miter box  
 PL Skrzynka uciowska  
 DE Schneidlade  
 RU Крыцо  
 CZ Pokosová krabička  
 RO Cutie pt. tăiat oblic  
 HU Gervágó doboz  
 ES Caja de ingletes



No.	External dimensions / Wymiary zewnętrzne [mm]	
29311	250x75x55	70
29312	290x90x70	50

EN Miter box  
 PL Skrzynka uciowska  
 DE Schneidlade  
 RU Крыцо  
 CZ Pokosová krabička  
 RO Cutie pt. tăiat oblic  
 HU Gervágó doboz  
 ES Caja de ingletes



No.	Dimensions / Wymiary [mm]	
29317	233x53x56	50
29318	250x65x60	50
29319	295x80x70	30

EN Sabre saw blades  
 PL Brzeczczoty do pily szablastej  
 DE Säbelsägeblatt  
 RU Пильное полотно  
 CZ Pílový plátek do pily ocasky  
 RO Până de ferăstrău sabie  
 HU Szablyafűrészlap  
 ES Hoja de sierra sable

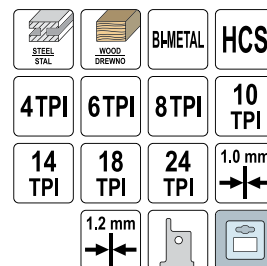

No.	pcs / szt.	
27850	7	10/100



EN Hacksaw spare blades  
 PL Brzeszczoty  
 DE Metallsägeblatt  
 RU Полотно двустороннее

CZ Čepele  
 RO Pânze  
 HU Fémfűrészlap  
 ES Hojas



No.	Type / Typ	L [mm]	W [mm]	pcs / szt.	
27500	RAMb	300	25	72	10

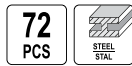

No.	Type / Typ	L [mm]	W [mm]	pcs / szt.	
27501	RAMc	300	12	144	10



No.	Type / Typ	L [mm]	W [mm]	pcs / szt.	
27502	RAMa	300	12	144	10



No.	Type / Typ	L [mm]	W [mm]	pcs / szt.	
27505	RAMe	300	20	72	10

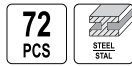

EN Hacksaw blade for metal  
 PL Brzeszczot do metalu  
 DE Metallsägeblatt  
 RU Полотно по металлу  
 CZ Pilový list na kov  
 RO Panza fierastrau pt. metal  
 HU Fémfűrészlap  
 ES Hoja de sierra para metal



No.	Type / Typ	L [mm]	W [mm]	
27530	RAMb	300	25	70/700

EN Hacksaw blade for wood and metal  
 PL Brzeszczot do drewna i metalu  
 DE Sägeblatt für Holz und Metall  
 RU Полотно по дереву и металлу  
 CZ Pilový list na dřevo a kov  
 RO Panza fierastrau pt. lemn si metal  
 HU Fűrészlap fához és fémhez  
 ES Hoja de sierra para madera y metal

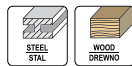

No.	Type / Typ	L [mm]	W [mm]	
27533	RAMf	300	20	70/700

EN Hacksaw spare blades  
 PL Brzeszczoty  
 DE Metallsägeblatt  
 RU Полотно двустороннее  
 CZ Čepele  
 RO Pânze  
 HU Fémfűrészlap  
 ES Hojas



No.	Type / Typ	L [mm]	W [mm]	pcs / szt.	
27506	RAMf	300	20	72	10



No.	Type / Typ	L [mm]	W [mm]	pcs / szt.	
27510	RAMd	300	25	72	10

EN Hacksaw blade for metal  
 PL Brzeszczot do metalu  
 DE Metallsägeblatt  
 RU Полотно по металлу  
 CZ Pilový list na kov  
 RO Panza fierastrau pt. metal  
 HU Fémfűrészlap  
 ES Hoja de sierra para metal

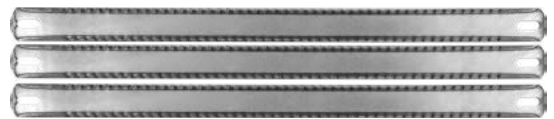
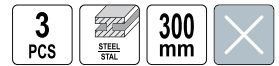

No.	Type / Typ	L [mm]	W [mm]	pcs / szt.	
27511	RAMb	300	25	3	50

EN Hacksaw blade for wood and metal  
 PL Brzeszczot do drewna i metalu  
 DE Sägeblatt für Holz und Metall  
 RU Полотно по дереву и металлу  
 CZ Pilový list na dřevo a kov  
 RO Panza fierastrau pt. lemn si metal  
 HU Fűrészlap fához és fémhez  
 ES Hoja de sierra para madera y metal

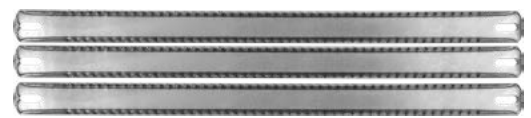

No.	Type / Typ	L [mm]	W [mm]	pcs / szt.	
27513	RAMd	300	25	3	50

EN Hacksaw blade for metal  
 PL Brzeszczot do metalu  
 DE Metallsägeblatt  
 RU Полотно по металлу  
 CZ Pilový list na kov  
 RO Panza fierastrau pt. metal  
 HU Fémfűrészlap  
 ES Hoja de sierra para metal



No.	L [mm]	pcs / szt.	
27520	300	12	20/120

EN Hacksaw blade for metal  
 PL Brzeszczot do metalu  
 DE Metallsägeblatt  
 RU Полотно по металлу  
 CZ Pílový list na kov  
 RO Panza fierastrau pt. metal  
 HU Fémfűrészlap  
 ES Hoja de sierra para metal

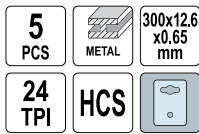

No.	L [mm]	W [mm]	TPI	pcs / szt.	
27535	300	12.6	24	5	10/200

EN Hacksaw blade for metal  
 PL Brzeszczot do metalu  
 DE Metallsägeblatt  
 RU Полотно по металлу  
 CZ Pílový list na kov  
 RO Panza fierastrau pt. metal  
 HU Fémfűrészlap  
 ES Hoja de sierra para metal



No.	L [mm]	W [mm]	TPI	pcs / szt.	
27542	300	12.6	24	2	10/200

EN Hacksaw blade for metal  
 PL Brzeszczot do metalu  
 DE Metallsägeblatt  
 RU Полотно по металлу  
 CZ Pílový list na kov  
 RO Panza fierastrau pt. metal  
 HU Fémfűrészlap  
 ES Hoja de sierra para metal

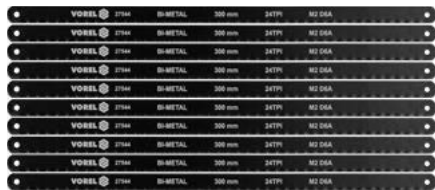
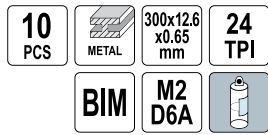

No.	L [mm]	W [mm]	TPI	pcs / szt.	
27544	300	12.6	24	10	5/50

EN Hacksaw blade for metal  
 PL Brzeszczot do metalu  
 DE Metallsägeblatt  
 RU Полотно по металлу  
 CZ Pílový list na kov  
 RO Panza fierastrau pt. metal  
 HU Fémfűrészlap  
 ES Hoja de sierra para metal



No.	L [mm]	pcs / szt.	
27800	150	10	8/120

EN Precision mitre saw blade for wood and PVC  
 PL Brzeszczot do drewna i PVC  
 DE Sägeblatt für Holz und PVC  
 RU Полотно по дереву и ПВХ  
 CZ Pílový list na dřevo a PVC  
 RO Panza fierastrau pt. lemn si PVC  
 HU Fűrészlap fához és PVC-hez  
 ES Hoja de sierra para madera y PVC



No.	L [mm]	W [mm]	Thickness / Grubość [mm]	TPI	
29090	550	45	0.7	18	50

EN Hacksaw blade for metal  
 PL Brzeszczot do metalu  
 DE Metallsägeblatt  
 RU Полотно по металлу  
 CZ Pílový list na kov  
 RO Panza fierastrau pt. metal  
 HU Fémfűrészlap  
 ES Hoja de sierra para metal

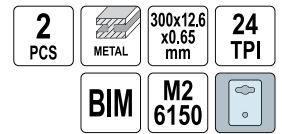

No.	L [mm]	W [mm]	TPI	pcs / szt.	
27541	300	12.6	24	2	10/200

EN Hacksaw blade for metal  
 PL Brzeszczot do metalu  
 DE Metallsägeblatt  
 RU Полотно по металлу  
 CZ Pílový list na kov  
 RO Panza fierastrau pt. metal  
 HU Fémfűrészlap  
 ES Hoja de sierra para metal



No.	L [mm]	W [mm]	TPI	pcs / szt.	
27543	300	12.6	24	2	10/200

EN Hacksaw blade for metal  
 PL Brzeszczot do metalu  
 DE Metallsägeblatt  
 RU Полотно по металлу  
 CZ Pílový list na kov  
 RO Panza fierastrau pt. metal  
 HU Fémfűrészlap  
 ES Hoja de sierra para metal

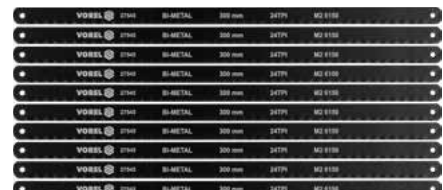
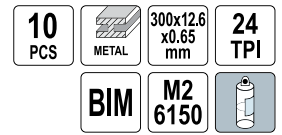

No.	L [mm]	W [mm]	TPI	pcs / szt.	
27545	300	12.6	24	10	5/50

EN Precision mitre saw blade for metal  
 PL Brzeszczot do metalu  
 DE Metallsägeblatt  
 RU Полотно по металлу  
 CZ Pílový list na kov  
 RO Panza fierastrau pt. metal  
 HU Fémfűrészlap  
 ES Hoja de sierra para metal



No.	L [mm]	W [mm]	Thickness / Grubość [mm]	TPI	
29100	550	45	0.7	32	50

EN Jig saw blades  
 PL Brzeszczoły do wyrzynarki elektrycznej  
 DE Stichsägeblätter  
 RU Полотно для электролобзика

CZ Pilový list do přímočaré pily  
 RO Panza fierastru circular  
 HU Dekopírlap  
 ES Recambio sierra de calar



**VOREL** **6TPI** **1.5 mm** **WOOD DREWNO** **PLYWOOD SKLEJKA** **PVC** **HCS 65Mn**

No.	L [mm]	Working length / Długość robocza [mm]	pcs / szt.	
27811	100	75	5	100/400

**VOREL** **6TPI** **1.2 mm** **WOOD DREWNO** **HCS 65Mn**

No.	L [mm]	Working length / Długość robocza [mm]	pcs / szt.	
27813	100	75	5	100/400

**VOREL** **10 TPI** **1.5 mm** **WOOD DREWNO** **CHIPBOARD PLYTA WIDORNA** **HCS 65Mn**

No.	L [mm]	Working length / Długość robocza [mm]	pcs / szt.	
27815	100	75	5	100/400

EN Jig saw blades  
 PL Brzeszczoły do wyrzynarki elektrycznej  
 DE Stichsägeblätter  
 RU Полотно для электролобзика

CZ Pilový list do přímočaré pily  
 RO Panza fierastru circular  
 HU Dekopírlap  
 ES Recambio sierra de calar



**VOREL** **6TPI** **1.2 mm** **WOOD DREWNO** **CHIPBOARD PLYTA WIDORNA** **HCS 65Mn**

No.	L [mm]	Working length / Długość robocza [mm]	pcs / szt.	
27830	100	75	5	100/400

**VOREL** **6TPI** **1.5 mm** **WOOD DREWNO** **PVC** **HCS 65Mn**

No.	L [mm]	Working length / Długość robocza [mm]	pcs / szt.	
27831	100	75	5	100/400

**VOREL** **10 TPI** **1.5 mm** **WOOD DREWNO** **PLYWOOD SKLEJKA** **HCS 65Mn**

No.	L [mm]	Working length / Długość robocza [mm]	pcs / szt.	
27833	100	75	5	100/400

**VOREL** **STEEL STAL** **WOOD DREWNO** **PLYWOOD SKLEJKA** **PVC**

No.	L [mm]	Working length / Długość robocza [mm]	pcs / szt.	
27834	100, 100, 76, 100, 70	75, 75, 50, 75, 45	5	100/400



**VOREL** **10 TPI** **1.5 mm** **WOOD DREWNO** **PLYWOOD SKLEJKA** **PVC** **HCS 65Mn**

No.	L [mm]	Working length / Długość robocza [mm]	pcs / szt.	
27810	100	75	5	100/400

**VOREL** **8TPI** **1.2 mm** **WOOD DREWNO** **CHIPBOARD PLYTA WIDORNA** **PVC** **HCS 65Mn**

No.	L [mm]	Working length / Długość robocza [mm]	pcs / szt.	
27812	100	75	5	100/400

**VOREL** **21 TPI** **1.0 mm** **STEEL STAL** **HSS M2**

No.	L [mm]	Working length / Długość robocza [mm]	pcs / szt.	
27814	76	50	5	100/400

**VOREL** **STEEL STAL** **CHIPBOARD PLYTA WIDORNA** **PLYWOOD SKLEJKA** **PVC**

No.	L [mm]	Working length / Długość robocza [mm]	pcs / szt.	
27820	100, 100, 100, 76, 100	75, 75, 75, 50, 75	5	100/400

EN Steel wire brush  
 PL Szczotka druciana  
 DE Stahldrahtbürste  
 RU Щетка стальная  
 CZ Drátěný kartáč  
 RO Perie de sârmă  
 HU Drótkefe  
 ES Cepillo de acero



**VOREL**

No.	Row quantity / Liczba rzędów	
06930	3	12/120
06940	4	12/120
06950	5	12/120
06960	6	12/120

EN Plastic handle wire brush set  
 PL Komplet szczotek drucianych  
 DE Bürstensatz  
 RU Набор стальных щеток  
 CZ Drátěný kartáče  
 RO Set perii de sarma  
 HU Kefekészlet  
 ES Juego de cepillos



**VOREL**

No.	L [mm]	
06963	170	24/240
06964	220	24/72

EN Brass wire brush  
 PL Szczotka druciana mosiężna  
 DE Messingdrahtbürste  
 RU Щетка проволочная латунная  
 CZ Drátěný kartáč mosazný  
 RO Perie de sărmă din alamă  
 HU Réz drótkéfe  
 ES Cepillo de latón



No.	Ø [mm]	max. C [min <sup>-1</sup> ]	Icon
06965			25/100

EN Circular brush - crimped wire  
 PL Szczotka tarczowa, drut karbowany  
 DE Stahldraht - Kegelmürste  
 RU Щетка-крацовка с гайкой

CZ Kotoučový kartáč, rýhovaný drát  
 RO Perie rotundă, sărmă ondulată  
 HU Tarcás drótkéfe, sodrott dróttal  
 ES Cepillo redondo de alambre ondulado



No.	Ø [mm]	max. C [min <sup>-1</sup> ]	Icon
06972	100	12500	12/72
06973	115	12500	12/72

EN Circular brush - twisted wire  
 PL Szczotka tarczowa z gwintem, drut splatany  
 DE Stahldraht - Zopf - Kegelmürste  
 RU Щетка-крацовка-усиленная

CZ Kotoučový kartáč, pletený drát  
 RO Perie rotativă, sărmă împletită  
 HU Tarcás drótkéfe, egyenes dróttal  
 ES Cepillo redondo de alambre conico



No.	Ø [mm]	max. C [min <sup>-1</sup> ]	Icon
06977	100	12500	12/48

EN Circular brush - twisted wire  
 PL Szczotka tarczowa, drut splatany  
 DE Stahldraht - Zopfscheibenbürste  
 RU Дисковая щетка витая

CZ Kotoučový kartáč  
 RO Perie rotativă  
 HU Tarcás drótkéfe  
 ES Cepillo redondo de alambre conico



No.	Ø [mm]	max. C [min <sup>-1</sup> ]	Icon
06981	100	11000	12/72
06982	115	11000	12/48
06983	150	9000	12/36

EN Cup brush - crimped wire  
 PL Szczotka czolowa z gwintem, drut karbowany  
 DE Stahldraht - Topfbürste  
 RU Щетка-крацовка чашка с гайкой

CZ Čelní kartáč, rýhovaný drát  
 RO Perie frontală, sărmă ondulată  
 HU Homlok drótkéfe, sodrott dróttal  
 ES Cepillo de copa de alambre ondulado



No.	Ø [mm]	max. C [min <sup>-1</sup> ]	Icon
06970	75	1200	12/72
06971	100	8500	6/24

EN Cup brush - twisted wire  
 PL Szczotka czolowa z gwintem, drut splatany  
 DE Stahldraht - Zopfporfbürste  
 RU Щетка - крацовка круговая крученая щетка крацовка (чашка)  
 CZ Čelní kartáč, pletený drát  
 RO Perie frontală, sărmă împletită  
 HU Homlok drótkéfe, sodrott dróttal  
 ES Cepillo de copa de alambre conico



No.	Ø [mm]	max. C [min <sup>-1</sup> ]	Icon
06974	65	12500	12/36
06975	80	8500	12/36
06976	100	8500	6/24

EN Circular brush - crimped wire  
 PL Szczotka tarczowa, drut karbowany  
 DE Stahldraht - Scheibenbürste  
 RU Щетка-крацовка латунированная сталь

CZ Kotoučový kartáč  
 RO Perie rotativă  
 HU Tarcás drótkéfe  
 ES Cepillo redondo de alambre ondulado



No.	Ø [mm]	max. C [min <sup>-1</sup> ]	Icon
06978	125	6000	12/72
06979	150	6000	12/36
06980	200	4500	12/24

EN Circular brush - crimped wire  
 PL Szczotka tarczowa z trzpieniem, drut karbowany  
 DE Stahldraht - Scheibenbürste  
 RU Щетка круговая со стержнем

CZ Okružní kartáč drátěný se stopkou  
 RO Perie rotunda pt. bormasina  
 HU Tarcás drótkéfe, nyéllal  
 ES Cepillo redondo



No.	Ø [mm]	max. C [min <sup>-1</sup> ]	Icon
06985	75	4500	10/120
06986	100	4500	12/120



EN Cup brush – crimped wire  
 PL Szczotka czolowa z trzpieniem, drut karbowany  
 DE Stahldraht - Topfbürste  
 RU Щетка-крацовка со стержнем чашка  
 CZ Čelní kartáč, z hrotem, rýhovaný drát  
 RO Perie frontală cu coadă, sârmă ondulată  
 HU Homlok drótkéfe, nyéllel, sodrott dróttal  
 ES Cepillo de copa con mandril, de alambre ondulado



**VOREL**

No.	Ø [mm]	max. $\omega$ [min <sup>-1</sup> ]	
06987	50	4500	10/180
06988	75	4500	12/96

EN Steel wire brush set  
 PL Szczotka druciana okrągła  
 DE Stahldraht - Bürstensatz  
 RU Набор щеток  
 CZ Drátěné kartáče kulaté  
 RO Perii de sârmă rotunde  
 HU Kerek drótkéfe  
 ES Cepillos de alambre redontos



**5**  
PCS

No.	max. $\omega$ [min <sup>-1</sup> ]	
06990	4500	20/120

EN Circular brush - twisted wire  
 PL Szczotka tarczowa z trzpieniem, drut splatany  
 DE Stahldraht - Scheibenbürste  
 RU Щетка круговая со стержнем  
 CZ Okružní kartáč drátěný se stopkou  
 RO Perie rotundă pt. bormasina  
 HU Tarcás drótkéfe, nyéllel  
 ES Cepillo redondo



$\varnothing$  75 mm  $\omega$  12500 min<sup>-1</sup>

**VOREL**

No.	Ø [mm]	max. $\omega$ [min <sup>-1</sup> ]	
06993	75	12500	30/180

EN Hook and loop rubber disc  
 PL Przystawka z rzepem  
 DE Klett-Haftstützteller mit Dorn  
 RU Шлифовальный диск с липучкой

CZ Přídavné zařízení ze zipem  
 RO Disc-Suport cu scai pt. hârtie abrazivă rotundă  
 HU Kistál tapadókoronggal  
 ES Disco de goma con velcro

$\varnothing$  125 mm

HOOK  
FASTENER  
RZEP



**VOREL**

No.	Ø [mm]	max. $\omega$ [min <sup>-1</sup> ]	
08312	125	2000	12/120

EN Wire brush set  
 PL Szczotki druciane z trzpieniem, drut karbowany  
 DE Stahldraht-Bürstensatz  
 RU Набор щеток-крацовок со стержнем  
 CZ Okružní kartáč drátěný se stopkou  
 RO Set perii sarma ondulata  
 HU Tarcás drótkéfe, nyéllel, sodrott dróttal  
 ES Cepillos de alambre con mandril



**3**  
PCS  $\omega$  4500 min<sup>-1</sup>

**VOREL**

No.	Ø [mm]	max. $\omega$ [min <sup>-1</sup> ]	
06989	25, 50, 50	4500	12/60

EN Cup brush – crimped wire  
 PL Szczotka czolowa z trzpieniem, drut karbowany  
 DE Stahldraht - Topfbürste  
 RU Щетка-крацовка „КИСТЬ” со стержнем  
 CZ Čelní kartáč, z hrotem, rýhovaný drát  
 RO Perie frontală cu coadă, sârmă ondulată  
 HU Homlok drótkéfe, nyéllel, sodrott dróttal  
 ES Cepillo de copa con mandril, de alambre ondulado



$\varnothing$  24 mm  $\omega$  4500 min<sup>-1</sup>

**VOREL**

No.	Ø [mm]	max. $\omega$ [min <sup>-1</sup> ]	
06992	24	4500	12/96

EN Cup brush - twisted wire  
 PL Szczotka czolowa z trzpieniem, drut splatany  
 DE Stahldraht - Zopfgrundbürste  
 RU Щетка-крацовка витая со стержнем  
 CZ Čelní kartáč, z hrotem, pletený drát  
 RO Perie frontală cu coadă, sârmă împletită  
 HU Homlok drótkéfe, nyéllel, egyenes dróttal  
 ES Cepillo de copa con mandril de alambre conico



**VOREL**

No.	Ø [mm]	max. $\omega$ [min <sup>-1</sup> ]	
06995	22	4500	24/192
06994	75	12500	12/96

EN Rubber disc with arbor  
 PL Przystawka-dysk z trzpieniem  
 DE Klett-Haftteller mit Dorn  
 RU Шлифовальный диск с хвостовиком

CZ Nástavec-kotouč s upínacím trnem  
 RO Disc cu știft, ajutaj  
 HU Csiszoló korong nyéllel  
 ES Disco de goma con mandril

$\varnothing$  125 mm



**VOREL**

No.	Ø [mm]	max. $\omega$ [min <sup>-1</sup> ]	
08314	125	3250	30/120

- EN Hook and loop rubber disc for angle grinder  
 PL Euro dysk do kątowniki z rzepem  
 DE Klett-Haftsteller mit Gewindeflansch  
 RU Насадка пластиковая жесткая под круг на липучке  
 CZ Euro disk do úhelníků ze zipem  
 RO Suport disc abraziv, fixare scai  
 HU Euro lemez élhez, tapadókoronggal  
 ES Disco de goma para angul con velcro



Ø 125 mm  
 12200 min<sup>2</sup> (max.)  
 M14  
 HOOK FASTENER RZEP



No.	Ø [mm]	max. n [min <sup>-1</sup> ]	
08315	125	12200	30/120

- EN Rubber disc for angle grinder and drill machine  
 PL Tarcza do szlifierek kątowych i wiertarek  
 DE Klett-Haftstützteller mit Gewindeflansch und Ersatzdorn  
 RU Насадка шлифовальная с липучкой + переход  
 CZ Kotoúč do úhelníků ze zipem  
 RO Suport disc abraziv, fixare scai  
 HU Euro lemez élhez, tapadókoronggal  
 ES Disco de goma para ancul con mandril

Ø 125 mm  
 12200 min<sup>2</sup> (max.)  
 M14  
 HOOK FASTENER RZEP



No.	Ø [mm]	max. n [min <sup>-1</sup> ]	
08316	125	12200	30/120

- EN Hook and loop multi rubber disc  
 PL Tarcza gumowa „multi-dysk” z rzepem  
 DE Gummihafstützteller  
 RU Насадка резиновая поворотная с липучкой  
 CZ Terč multi-dysk ze zipem  
 RO Suport disc abraziv, fixare scai  
 HU Multidisk tárcsa tapadókoronggal  
 ES Multi-disco con velcro

Ø 125 mm  
 HOOK FASTENER RZEP



No.	Ø [mm]	max. n [min <sup>-1</sup> ]	
08350	125	2000	20

- EN Hook and loop rubber disc for angle grinder  
 PL Euro dysk do kątowniki z rzepem  
 DE Klett-Haftstützteller mit Gewindeflansch  
 RU Шлифовальный диск под круг с липучкой  
 CZ Euro disk do úhelníků ze zipem  
 RO Euro disc cu scai pt. polizor unghiular  
 HU Euro lemez élhez, tapadókoronggal  
 ES Disco de goma para angul con velcro

HOOK FASTENER RZEP



No.	Ø [mm]	max. n [min <sup>-1</sup> ]	
08500	125	10000	20
08510	150	8500	20

- EN Hook and loop rubber disc for angle grinder  
 PL Tarcza do kątowniki z rzepem  
 DE Klett-Gummihafstützteller  
 RU Насадка шлифовальная под круг на липучке  
 CZ otouč do úhelníků ze zipem  
 RO Suport disc abraziv, fixare scai  
 HU Euro lemez élhez, tapadókoronggal  
 ES Disco para el pulidor angular con sujetador velcro

Ø 125 mm  
 12000 min<sup>2</sup> (max.)  
 M14  
 HOOK FASTENER RZEP



No.	Ø [mm]	max. n [min <sup>-1</sup> ]	
08318	125	12000	25/100

- EN Hook and loop rubber disc  
 PL Przystawka z rzepem  
 DE Klett-Haftstützteller mit Dorn  
 RU Насадка резиновая с липучкой  
 CZ Přídavné zařízení ze zipem  
 RO Suport disc abraziv, fixare scai  
 HU Kistál tapadókoronggal  
 ES Disco de goma con velcro

HOOK FASTENER RZEP



No.	Ø [mm]	max. n [min <sup>-1</sup> ]	
08400	125	2000	20

- EN Rubber disc for angle grinder  
 PL Euro dysk do kątowniki z trzpieniem  
 DE Klett-Haftstützteller mit Gewindeflansch und Ersatzdorn  
 RU Насадка шлифовальная с липучкой + переход  
 CZ Euro disk do úhelníků  
 RO Euro disc cu scai pt. polizor unghiular  
 HU Euro lemez élhez, tapadókoronggal  
 ES Disco de goma para ancul con mandril

Ø 125 mm  
 HOOK FASTENER RZEP



No.	Ø [mm]	max. n [min <sup>-1</sup> ]	
08501	125	10000	20

EN Hook and loop rubber disc for angle grinder  
 PL Tarcza do kątowniki z rzepem nr 2  
 DE Klett-Gumminhaftstützteller mit Gewindeflansch  
 RU Насадка шлифовальная под круг на липучке  
 CZ Kotouč do úhelníků ze zipem číslo 2  
 RO Disc de pásă la cu scai nr. 2 pt. polizor unghiular  
 HU Euro lemez élhez, tapadókoronggal, 2 sz.  
 ES Disco de goma para angul con velcro



**PRO  
FILE**

No.	Ø [mm]	max. C [min <sup>-1</sup> ]	
08511	125	10000	20

EN Polishing felt disc  
 PL Filc polerski na rzep  
 DE Filzpolierdisc  
 RU Полировальная насадка из фетра на липучке  
 CZ Leštící plstěnek na zip  
 RO Disc pasla de lustruit cu scai  
 HU Polirozó filc tapadókoronggal  
 ES Fieltro de pulir con velcro

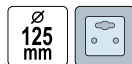

**PRO  
FILE**

No.	Ø [mm]	max. C [min <sup>-1</sup> ]	
08522	125	10000	100

EN Lock knife  
 PL Nóż składany sierpak  
 DE Klappmesser  
 RU Нож складной

CZ Dřevěný nůž srpek  
 RO Cutit secera maner lemn  
 HU Hajlított pengéjű kés, fanyelű  
 ES Cuchillo falciforme de madera

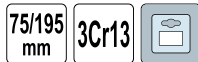

**VOREL**

No.	Blade length / Długość ostrza [mm]	
76621	75	10/100

EN Cable knife  
 PL Nóż monterski  
 DE Montagemesser  
 RU Нож электрика  
 CZ Montážní nůž  
 RO Cutit pt. decablat  
 HU Szerelőkés  
 ES Cuchillo de montaje



No.	
76640	50



EN Polishing felt disc  
 PL Rzep do tarczy gumowej (przylepiec)  
 DE Klettdisk für Gummistützteller  
 RU Круг с липучкой  
 CZ Zip do pryžového kotouče (suchý zip)  
 RO Disc pasla de lustruit cu scai  
 HU Tapadókorong gumitárcsához  
 ES Velcro para disco de goma

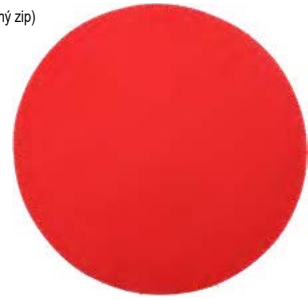

**VOREL**

No.	Ø [mm]	
08520	150	10/100
08521	125	10/100

EN Folding knife  
 PL Nóż składany  
 DE Klappmesser  
 RU Нож складной

CZ Kapesní nůž  
 RO Briceag  
 HU Zsebkés  
 ES Navaja



**VOREL**

No.	Blade size / Rozmiar ostrza [mm]	
76526	61x33x0.5	12/72

EN Electrician's knife  
 PL Nóż monterski składany  
 DE Montagemesser  
 RU Нож складной  
 CZ Montážní nůž  
 RO Cutit pt. decablat  
 HU Szerelőkés  
 ES Cuchillo de montaje



**VOREL**

No.	Blade length / Długość ostrza [mm]	
76622	85	10/100

EN Cable knife  
 PL Nóż monterski  
 DE Montagemesser  
 RU Нож электрика  
 CZ Montážní nůž  
 RO Cutit pt. decablat  
 HU Szerelőkés  
 ES Cuchillo de montaje



No.	
76650	50

EN Cable knife  
 PL Nóż sierpak  
 DE Klappmesser  
 RU Нож садовый

CZ Dřevěný nůž srpek  
 RO Cutit secera maner lemn  
 HU Hajlított pengéjű kés, fanyelű  
 ES Cuchillo falciforme de madera



No.	Blade size / Rozmiar ostrza [mm]	pcs / szt.
76660		50

EN Replacement blades for safety knife  
 PL Ostrza zapasowe do nożyka bezpiecznego  
 DE Ersatzklingen für Sicherheitsmesser  
 RU Сменные лезвия для безопасного ножа  
 CZ Náhradní čepeli pro bezpečnostní nůž  
 RO Lame pt. cuțit de siguranță  
 HU Tartalék penge biztonságos késhez  
 ES Cuchillas de recambio para cutter de seguridad

10 PCS 61x19 x0.6 mm

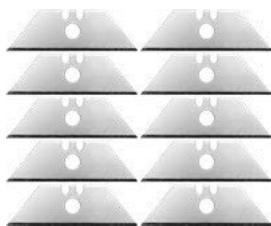

For 76035  
 Dla 76035

No.	Blade size / Rozmiar ostrza [mm]	pcs / szt.
76036	61x19x0.6	10 24/144

EN Spare blades for utility knife  
 PL Ostrza zapasowe do nożyka  
 DE Ersatz-Kurzklingen für Cuttermesser  
 RU Запасные лезвия для ножа

CZ Lomené ostří náhradní  
 RO Lame rezerva pt. cutter metallic  
 HU Törhető tartalékpenge  
 ES Filos de recambio para cuchillo

No.	Blade size / Rozmiar ostrza [mm]	For / Dla
76010	61x19	76000, 76011, 76015

EN Cutting knife with blade compartment  
 PL Nóż instalacyjny z magazynkiem  
 DE Universalmesser  
 RU Нож обрезиненный  
 CZ Univerzální nůž  
 RO Cutter cu maner metallic si compartiment pt. rezerva  
 HU Univerzális kés  
 ES Cutter con cargador



No.	Blade size / Rozmiar ostrza [mm]	pcs / szt.
76011	61x19	12/48

EN Metal utility knife  
 PL Nożyk z łamanym ostrzem  
 DE Abbrechklingen-Messer  
 RU Нож строительный  
 CZ Nůž ulamovací  
 RO Cuțit universal (cutter)  
 HU Univerzális kés  
 ES Cuchillo de papelería

9 mm SK2 ABS



No.	Blade width / Szerokość ostrza [mm]	pcs / szt.
76101	9	60/360

EN Safety knife  
 PL Nożyk bezpieczny  
 DE Sicherheitsmesser  
 RU Безопасный нож

CZ Bezpečnostní nůž  
 RO Cuțit de siguranță  
 HU Biztonsági kés  
 ES Cúter de seguridad



No.	Blade size / Rozmiar ostrza [mm]	pcs / szt.
76035	61x19	24/288

EN Utility knife  
 PL Nożyk z ostrzem trapezowym  
 DE Cuttermesser  
 RU Нож универсальный

CZ Univerzální nůž s lichoběžníkovou čepelí  
 RO Cuțit cu lamă trapezoidală retractabilă  
 HU Univerzális kés  
 ES Cuchillo con hoja trapezoidal



No.	Blade size / Rozmiar ostrza [mm]	pcs / szt.
76000	61x19	25/200

5 PCS



EN Utility knife  
 PL Nożyk z ostrzem trapezowym  
 DE Cuttermesser  
 RU Нож универсальный

CZ Univerzální nůž s lichoběžníkovou čepelí  
 RO Cuțit cu lamă trapezoidală retractabilă  
 HU Univerzális kés  
 ES Cuchillo con hoja trapezoidal



No.	Blade size / Rozmiar ostrza [mm]	pcs / szt.
76015	61x19	12/72

EN Metal utility knife  
 PL Nożyk z łamanym ostrzem  
 DE Abbrechklingen-Messer  
 RU Нож строительный  
 CZ Nůž ulamovací  
 RO Cuțit universal (cutter)  
 HU Univerzális kés  
 ES Cuchillo de papelería

9 mm



No.	Blade width / Szerokość ostrza [mm]	pcs / szt.
76160	9	24/288



EN Metal utility knife  
 PL Nożyk z lamany ostrzem  
 DE Abbrechklingen-Messer  
 RU Нож строительный  
 CZ Nůž ulamovací  
 RO Cuțit universal (cutter)  
 HU Univerzális kés  
 ES Cuchillo de papelería

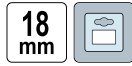

No.	Blade width / Szerokość ostrza [mm]	
76184	18	12/120

EN Metal utility knife  
 PL Nożyk z lamany ostrzem  
 DE Abbrechklingen-Messer  
 RU Нож строительный  
 CZ Nůž ulamovací  
 RO Cuțit universal (cutter)  
 HU Univerzális kés  
 ES Cuchillo de papelería

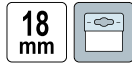

No.	Blade width / Szerokość ostrza [mm]	
76185	18	60/600

EN Metal utility knife  
 PL Nożyk z lamany ostrzem  
 DE Abbrechklingen-Messer  
 RU Нож строительный  
 CZ Nůž ulamovací  
 RO Cuțit universal (cutter)  
 HU Univerzális kés  
 ES Cuchillo de papelería



No.	Blade width / Szerokość ostrza [mm]	
76182	18	24/240

EN Metal utility knife  
 PL Nożyk z lamany ostrzem  
 DE Abbrechklingen-Messer  
 RU Нож строительный  
 CZ Nůž ulamovací  
 RO Cuțit universal (cutter)  
 HU Univerzális kés  
 ES Cuchillo de papelería

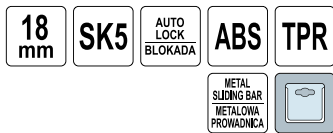

No.	Blade width / Szerokość ostrza [mm]	
76186	18	12/144

EN Metal utility knife  
 PL Nożyk z lamany ostrzem  
 DE Abbrechklingen-Messer  
 RU Нож строительный  
 CZ Nůž ulamovací  
 RO Cuțit universal (cutter)  
 HU Univerzális kés  
 ES Cuchillo de papelería

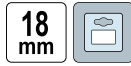

No.	Blade width / Szerokość ostrza [mm]	
76180	18	40/400

EN Metal utility knife  
 PL Nożyk z lamany ostrzem  
 DE Abbrechklingen-Messer  
 RU Нож строительный  
 CZ Nůž ulamovací  
 RO Cuțit universal (cutter)  
 HU Univerzális kés  
 ES Cuchillo de papelería

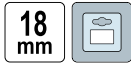

No.	Blade width / Szerokość ostrza [mm]	
76181	18	50/400

EN Metal utility knife  
 PL Nożyk z lamany ostrzem  
 DE Abbrechklingen-Messer  
 RU Нож строительный  
 CZ Nůž ulamovací  
 RO Cuțit universal (cutter)  
 HU Univerzális kés  
 ES Cuchillo de papelería



No.	Blade width / Szerokość ostrza [mm]	
76183	18	24/144

EN Metal utility knife  
 PL Nożyk z lamany ostrzem  
 DE Abbrechklingen-Messer  
 RU Нож строительный  
 CZ Nůž ulamovací  
 RO Cuțit universal (cutter)  
 HU Univerzális kés  
 ES Cuchillo de papelería



No.	Blade width / Szerokość ostrza [mm]	
76190	25	12/72

- EN Spare blades
- PL Ostrza zapasowe do nożyka
- DE Abbrechklingen
- RU Лезвия для универсальных ножей
- CZ Lomené ostří náhradní
- RO Lame de rezervă rupte
- HU Törhető tartalékpenge
- ES Filo partido de recambio



No.	Blade width / Szerokość ostrza [mm]	pcs / szt.	
76214	25	5	36/288

- EN Utility knife set
- PL Komplet nożyków
- DE Universal-Messersatz
- RU Набор ножей pistolетных
- CZ Sada ulamovacích nožů
- RO Set cuttere
- HU Univerzális kés készlet
- ES Cuchillos de papelería



No.	pcs / szt.	
76230	3	50/200

- EN Window scraper
- PL Skrobak do szyb
- DE Fensterabstreicher
- RU Скребок для стекла
- CZ Škrábák na skla
- RO Răzuitor pt. geamuri
- HU Kaparó üveghez
- ES Rascador de cristales



No.	Blade width / Szerokość ostrza [mm]	
06820	60	50/200

- EN Oil glass cutter
- PL Nóż olejowy do szkła
- DE Ölglasschneider
- RU Стеклорез масляный
- CZ Řezák na sklo
- RO Diamant pt. taiat sticla cu ulei
- HU Olajkés üveghez
- ES Cuchillo de aceite para cristales



No.	L [mm]	
05050	140	6/120

- EN Spare blades
- PL Ostrza zapasowe do nożyka
- DE Abbrechklingen
- RU Лезвия для универсальных ножей
- CZ Lomené ostří náhradní
- RO Lame de rezervă rupte
- HU Törhető tartalékpenge
- ES Filo partido de recambio



No.	Blade width / Szerokość ostrza [mm]	pcs / szt.	
76210	9	5	100/600
76220	18	5	100/600

- EN Utility knife set
- PL Komplet nożyków
- DE Universal-Messersatz
- RU Набор ножей pistolетных
- CZ Sada ulamovacích nožů
- RO Set cuttere
- HU Univerzális kés és műanyag kaparó készlet
- ES Cuchillos de papelería



No.	pcs / szt.	
76250	5	30/150

- EN Glass cutter
- PL Nóż do szkła
- DE Glasschneider
- RU Стеклоpez
- CZ Nůž do skla
- RO Diamant pt. sticla
- HU Kés üveghez
- ES Cuchillo para cristal



No.	
05100	12/240

- EN Scriber
- PL Rysik traserski
- DE Reißnadel
- RU Чертилка по металлу
- CZ Rysovací jehla
- RO Ac detrasat
- HU Karctu
- ES Trazador



No.	L [mm]	
35210	140	12/72

EN Automatic center punch  
 PL Punktak automatyczny  
 DE Automatischer Körner  
 RU Автоматический кернер  
 CZ Automatické důlčičkem  
 RO Punctator automat  
 HU Automatikus központ punci  
 ES Centro automático punch



No.	L [mm]	
35240	140	12/72

EN Wood carving knife set  
 PL Komplet nożyków precyzyjnych z ostrzami  
 DE Präzisionsmessersatz  
 RU Набор ножей для резьбы по дереву

CZ Sada přesných noží s bity  
 RO Set cutite prelucrare lemn  
 HU Modellező késkészlet pengékkel  
 ES Juego de cutters precisos con cuchillos



No.	pcs / szt.	
76305	16	25/100

EN Scissors  
 PL Nożyczki  
 DE Haushaltsschere  
 RU Ножницы  
 CZ Nůžky  
 RO Foarfece  
 HU Olló  
 ES Tijeras



No.	L [mm]	
76312	220	12/144

EN Leather hole punch  
 PL Dziurkacz nastawny  
 DE Einstellbarer Locher  
 RU Дырокол pistolный

CZ Děrovací kleště nastavitelné  
 RO Perforator ajustabil  
 HU Állítható lyukasztó  
 ES Pinza perforadora ajustable

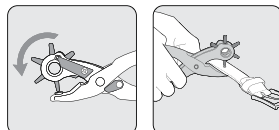

No.	L [mm]	
43600	220	6/36

EN Double edge scraper  
 PL Cyklina ręczna  
 DE Ziehklingschaber  
 RU Ручная цикля

CZ Ruční škrabka  
 RO Rascheta dubla  
 HU Kézi kaparó  
 ES Rasqueta manual



No.	Blade size / Rozmiar ostrza [mm]	
06840	40	10
06860	60	10

EN Scissors  
 PL Nożyczki  
 DE Haushaltsschere  
 RU Ножницы  
 CZ Nůžky  
 RO Foarfece  
 HU Olló  
 ES Tijeras



No.	L [mm]	
76311	170	12/144

EN Scissors set  
 PL Komplet nożyček  
 DE Haushaltsscherensatz  
 RU Ножницы бытовые в наборе  
 CZ Nůžky  
 RO Foarfece  
 HU Olló  
 ES Tijeras

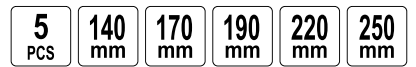

No.	L [mm]	pcs / szt.	
76314	140, 170, 190, 220, 250	5	12/24

EN Leather hole punch & grommet setting tool kit  
 PL Zestaw kaletrniczy  
 DE Taschner Satz  
 RU Набор для установки кнопок и люверсов  
 CZ Děrovačka na pásky  
 RO Set clesti prelucrare piele  
 HU Szegeccselő és lyukasztó készlet  
 ES Kit de cuero herramientas neumáticas de perforación y ojal

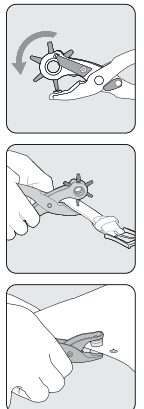
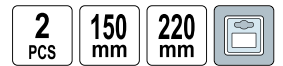

No.		
43603		5/20

- EN Pliers for plastic snaps
- PL Praska do zaciskania nap
- DE Zange für Plastic Moschettoni
- RU Клещи для пластиковых защелками
- CZ Pliers pro plastovou nezapadne
- RO Plastic pliers pt. sporturi
- HU Fogó műanyag pattan
- ES Alicates para la snaps de plástico



VOREL

No.	Hole diameter / Średnica otworu [mm]	
76710	10, 12, 14	30/60

- EN Punch set
- PL Komplet przebijaków do skóry
- DE Lederlochereset
- RU Набор пробойников для кожи
- CZ Sada průbojníků na kůži
- RO Set preducele
- HU Bőrlükasztó készlet
- ES Juego de perforar en piel

15 PCS



No.	Hole diameter / Średnica otworu [mm]	
76700	2, 2.5, 3.2, 4, 4.8, 5.5, 6.4, 8, 9.5, 11.1, 12.7, 14, 15.8, 19, 22	5/20

- EN Mini block plane
- PL Metalowy strug modelarski
- DE Metallhobel für Modellbau
- RU Металлический рубанок для моделирования
- CZ Kovový modelářský hoblík
- RO Mini rindea
- HU Mini fémgyalu
- ES Cepillo mini

90 mm 26 mm 65Mn HRC 50-55



VOREL

No.	Blade width / Szerokość ostrza [mm]	
25881	26	10/50

- EN Block plane
- PL Metalowy strug do drewna
- DE Metallhobel für Holz
- RU Металлический рубанок по дереву
- CZ Kovový hoblík do dřeva
- RO Rindea
- HU Fémgyalu
- ES Cepillo metálico para madera

200 mm 42 mm 65Mn HRC 50-55



VOREL

No.	Blade width / Szerokość ostrza [mm]	
25886	42	36

- EN Punch set
- PL Komplet przebijaków do skóry
- DE Lederlochereset
- RU Набор пробойников для кожи
- CZ Sada průbojníků na kůži
- RO Set preducele
- HU Bőrlükasztó készlet
- ES Juego de perforar en piel

9 PCS



No.	Hole diameter / Średnica otworu [mm]	
76705	2.5, 3, 4, 5, 6, 7, 8, 9, 10	10/80

- EN Rabbet plane
- PL Strug kątnik czolowy
- DE Simshobel
- RU Фальцебель двойной деревянный
- CZ Hoblík čelní drážkovník
- RO Rindea frontală unghiulară
- HU Párkánygyalu, homlok
- ES Cepillo de ranura

30 mm



No.	Blade width / Szerokość ostrza [mm]	L [mm]	
25830	30	245	20

- EN Block plane
- PL Metalowy strug do drewna
- DE Metallhobel für Holz
- RU Металлический рубанок по дереву
- CZ Kovový hoblík do dřeva
- RO Rindea
- HU Fémgyalu
- ES Cepillo metálico para madera

165 mm 42 mm 65Mn HRC 50-55



VOREL

No.	Blade width / Szerokość ostrza [mm]	
25885	42	50

- EN Block plane
- PL Metalowy strug do drewna
- DE Metallhobel für Holz
- RU Металлический рубанок по дереву
- CZ Kovový hoblík do dřeva
- RO Rindea
- HU Fémgyalu
- ES Cepillo metálico para madera

235 mm

44 mm

65Mn

HRC 50-55



VOREL

No.	Blade width / Szerokość ostrza [mm]	
25887	44	30



EN Edge planing machine for gypsum plate  
 PL Strug do krawędzi płyt gipsowo-kartonowych  
 DE Gipskarton-Kantenhobel  
 RU Рубанок кромочный для гипскартона  
 CZ Hoblík na hrany sádrokartonu  
 RO Dispozitiv tăiat gips carton  
 HU Gipszkartonos élglyalu  
 ES Cepillo biselador carton yeso



45° 90° 15 mm  
 18 mm  
 ABS



No.	
25971	50

EN Edge planing machine for gypsum plate  
 PL Strug do krawędzi płyt gipsowo-kartonowych  
 DE Gipskarton-Kantenhobel  
 RU Рубанок кромочный для гипскартона  
 CZ Hoblík na hrany sádrokartonu  
 RO Dispozitiv tăiat gips carton  
 HU Gipszkartonos élglyalu  
 ES Cepillo biselador carton yeso



90°  
 18 mm  
 ABS



No.	
25972	50

EN Steel file  
 PL Piłnik do metalu  
 DE Werkstatt-Feile  
 RU Напильник слесарный  
 CZ Pílník na kov  
 RO Pila de lăcătușerie  
 HU Lakatos reszelő  
 ES Lima para metal

200 mm T12



No.	L [mm]	
25160	200	25/100

EN Steel file  
 PL Piłnik do metalu  
 DE Werkstatt-Feile  
 RU Напильник слесарный  
 CZ Pílník na kov  
 RO Pila de lăcătușerie  
 HU Lakatos reszelő  
 ES Lima para metal

200 mm T12



No.	L [mm]	
25161	200	25/100

EN Steel file  
 PL Piłnik do metalu  
 DE Werkstatt-Feile  
 RU Напильник слесарный  
 CZ Pílník na kov  
 RO Pila de lăcătușerie  
 HU Lakatos reszelő  
 ES Lima para metal

200 mm T12



No.	L [mm]	
25162	200	25/100

EN Steel file  
 PL Piłnik do metalu  
 DE Werkstatt-Feile  
 RU Напильник слесарный  
 CZ Pílník na kov  
 RO Pila de lăcătușerie  
 HU Lakatos reszelő  
 ES Lima para metal

200 mm T12



No.	L [mm]	
25163	200	25/100

EN Steel file  
 PL Piłnik do metalu  
 DE Werkstatt-Feile  
 RU Напильник слесарный  
 CZ Pílník na kov  
 RO Pila de lăcătușerie  
 HU Lakatos reszelő  
 ES Lima para metal

200 mm T12



No.	L [mm]	
25164	200	25/100

EN Steel file set  
 PL Zestaw piłników do metalu  
 DE Feilensatz  
 RU Набор напильников  
 CZ Pílníky na kov  
 RO Pile de lăcătușerie  
 HU Lakatos reszelő készlet  
 ES Juego de limas para metal

3 PCS  
 200 mm T12



No.	L [mm]	pcs / szt.	
25165	200	3	10/20

EN Steel file set  
 PL Zestaw piłników do metalu  
 DE Feilensatz  
 RU Набор напильников  
 CZ Pílníky na kov  
 RO Pile de lăcătușerie  
 HU Lakatos reszelő készlet  
 ES Juego de limas para metal

5 PCS  
 200 mm



No.	L [mm]	pcs / szt.	
25166	200	5	10/20

- EN Needle file set  
 PL Zestaw pilników iglaków  
 DE Nadelfeilsatz  
 RU Набор напильников надфили
- CZ Sada jehlových pilníků  
 RO Set pile conice  
 HU Túreszelő készlet  
 ES Juego de limas de aguja



No.	L [mm]	Toolholder size / Rozmiar uchwyty narzędziowego [mm]	pcs / szt.	Package	
25370	150	4	5		20/200
25380	150	4	10		25/100
25390	150	4	12		25/100

- EN Needle file set  
 PL Zestaw pilników iglaków  
 DE Nadelfeilsatz  
 RU Набор напильников надфили  
 CZ Sada jehlových pilníků  
 RO Set pile conice  
 HU Túreszelő készlet  
 ES Juego de limas de aguja

6  
PCS



No.	L [mm]	pcs / szt.	
25351	140	6	20/160
25352	160	6	20/160
25353	180	6	20/120

- EN Diamond whetstone  
 PL Osełka diamentowa  
 DE Diamant Schleifstein  
 RU Алмазный брусок
- CZ Diamond brousek  
 RO Piatra abraziva diamantata  
 HU Kétoldalas gyémánt fenékö  
 ES Piedra de afilar diamantada

G400 150x50 mm

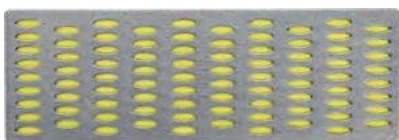

No.	Grit / Ziarnistość	W [mm]	L [mm]	
26131	G400	50	150	20/100

- EN Diamond whetstone set  
 PL Zestaw osekł diamentowych  
 DE Diamant Schleifstein  
 RU Алмазный брусок  
 CZ Diamond brousek  
 RO Piatra abraziva diamantata  
 HU Kétoldalas gyémánt fenékö  
 ES Piedra de afilar diamantada

3  
PCS

75x25  
mm

G180 G260

G360



No.	Grit / Ziarnistość	W [mm]	L [mm]	
26140	G180, G260, G360	25	75	25/100

- EN Needle file set  
 PL Zestaw pilników iglaków  
 DE Nadelfeilsatz  
 RU Набор напильников надфили  
 CZ Sada jehlových pilníků  
 RO Set pile conice  
 HU Túreszelő készlet  
 ES Juego de limas de aguja

6  
PCS



No.	pcs / szt.	
25360	6	20/200

- EN Diamond whetstone  
 PL Osełka diamentowa  
 DE Diamant Schleifstein  
 RU Алмазный брусок
- CZ Diamond brousek  
 RO Piatra abraziva diamantata  
 HU Kétoldalas gyémánt fenékö  
 ES Piedra de afilar diamantada

G600 150x50 mm

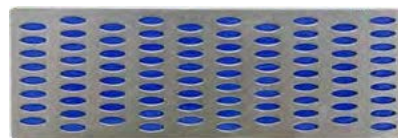

No.	Grit / Ziarnistość	W [mm]	L [mm]	
26130	G600	50	150	20/100

- EN Diamond whetstone  
 PL Osełka diamentowa  
 DE Diamant Schleifstein  
 RU Алмазный брусок
- CZ Diamond brousek  
 RO Piatra abraziva diamantata  
 HU Kétoldalas gyémánt fenékö  
 ES Piedra de afilar diamantada

G300 150x50 mm

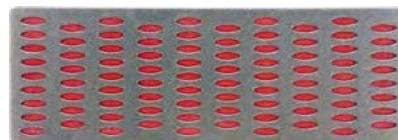

No.	Grit / Ziarnistość	W [mm]	L [mm]	
26132	G300	50	150	20/100

- EN Wood rasp  
 PL Tamnik do drewna  
 DE Holzraspel  
 RU Рашиль по дереву  
 CZ Rašple do dřeva  
 RO Raspe  
 HU Fareszelő  
 ES Escarpelo para madera

200 mm



No.	L [mm]	
25170	200	25/100

EN Wood rasp  
 PL Tarnik do drewna  
 DE Holzraspel  
 RU Рашиль по дереву  
 CZ Rašple do dřeva  
 RO Raspe  
 HU Fareszelő  
 ES Escarpelo para madera

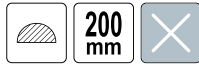

No.	L [mm]	
25171	200	25/100

EN Wood rasp set  
 PL Komplet tarników do drewna  
 DE Holzraspelsatz  
 RU Рашили для дерева

CZ Sada rašplí do dřeva  
 RO Set raspe  
 HU Fareszelő készlet  
 ES Juego de escarpelos para madera



No.	L [mm]	pcs / szt.	
25173	200	3	10/20

EN Rasp for plaster  
 PL Tarnik do gipsu  
 DE Gipskartonplatten Rasp  
 RU Рашиль для гипсокартона  
 CZ Rašple pro omítky  
 RO Rindea  
 HU Reszelt vakolat  
 ES Eliminador de yeso



No.	Working width / Szerokość robocza [mm]	L [mm]	
25300	40	60	10/60

EN Rasp for plaster  
 PL Tarnik do gipsu  
 DE Gipskartonplatten Rasp  
 RU Рашиль для гипсокартона  
 CZ Rašple pro omítky  
 RO Rindea  
 HU Reszelt vakolat  
 ES Eliminador de yeso



No.	Working width / Szerokość robocza [mm]	L [mm]	
25307	40	140	15/60

EN Wood rasp  
 PL Tarnik do drewna  
 DE Holzraspel  
 RU Рашиль по дереву  
 CZ Rašple do dřeva  
 RO Raspe  
 HU Fareszelő  
 ES Escarpelo para madera



No.	L [mm]	
25172	200	25/100

EN Wood rasp set  
 PL Komplet tarników do drewna  
 DE Holzraspelsatz  
 RU Рашили для дерева

CZ Sada rašplí do dřeva  
 RO Set raspe  
 HU Fareszelő készlet  
 ES Juego de escarpelos para madera



No.	L [mm]	pcs / szt.	
25230	200	3	15/60

EN Blade for rasp  
 PL Tarka zapasowa do tarnika  
 DE Sägeblatt raspel  
 RU Лезвие для рашиля по гипсокартону  
 CZ Šepel do škrabacích  
 RO Lama pt. rasp  
 HU Penge reszeltő  
 ES Hoja para raspar

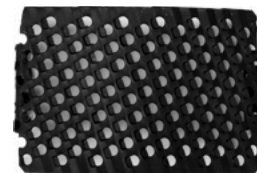

No.	Working width / Szerokość robocza [mm]	L [mm]	For / Dla	
25301	40	60	25300	10/120

EN Rasp for plaster  
 PL Tarnik do gipsu  
 DE Gipskartonplatten Rasp  
 RU Рашиль для гипсокартона  
 CZ Rašple pro omítky  
 RO Rindea  
 HU Reszelt vakolat  
 ES Eliminador de yeso

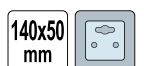

No.	Working width / Szerokość robocza [mm]	L [mm]	
07930	50	140	6/36

- EN Rasp for plaster
- PL Tarnik do gipsu
- DE Gipskartonplatten Rasp
- RU Рашиль для гипсокартона
- CZ Rašple pro omítky
- RO Rindea
- HU Reszelt vakolat
- ES Eliminador de yeso



No.	Working width / Szerokość robocza [mm]	L [mm]	
25310	40	250	15/60

- EN Sharpening stone
- PL Osełka owalna
- DE Abziehstein
- RU Брусок
- CZ Obtaňovací brousek
- RO Pila abrazivă pt. ascuțit
- HU Fenőkő
- ES Piedra de afilar

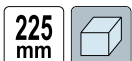

No.	L [mm]	
26210	225	50/100

- EN Rotary sharpener
- PL Ostrzarka do wiertarki
- DE Bohrschärfer-Bohrmaschinenaufsatz
- RU Точило для ножей и ножниц
- CZ Brousek na nože a nůžky
- RO Rezervă pt dispozitiv de ascuțit burghie
- HU Élezőkő fúrógéphe fogható
- ES Muela afilar cuchillos y tijeras



No.		
26225		80/240

- EN Waterproof sand paper
- PL Papier ścierny wodoodporny
- DE Schleifpapier wasserfest
- RU Водостойкая наждачная бумага
- CZ Smrkový papír-vodní
- RO Hârtie abrazivă rezistentă la apă
- HU Csiszolópapír vízes
- ES Papel de lija resistente al agua

No.	Grit / Ziarnistość	Size / Rozmiar [mm]	pcs / szt.	
07060	P60	230x280	50	1000
07080	P80	230x280	50	1000
07100	P100	230x280	50	1000
07120	P120	230x280	50	1000
07180	P180	230x280	50	1000
07240	P240	230x280	50	1000
07320	P320	230x280	50	1000
07400	P400	230x280	50	1000
07506	P600	230x280	50	1000
07508	P800	230x280	50	1000
07510	P1000	230x280	50	1000
07512	P1200	230x280	50	1000

- EN Sharpening stone
- PL Osełka
- DE Wetzstein
- RU Брусок точильный
- CZ Brusný kámen
- RO Piatra pt. ascuțit
- HU Fenőkő
- ES Piedra de afilar

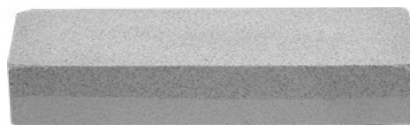

No.	L [mm]	
26150	150	25/50
26200	200	25/50

- EN Knife sharpener
- PL Ostrzarka do noży
- DE Messerschärfer
- RU Точилка для ножей
- CZ Brousek na nože
- RO Cuit ascuțitoare
- HU Késélező
- ES Afilador de cuchillos



No.		
26220		12/96

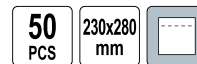
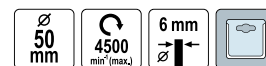



EN Abrasive cloth  
 PL Piótno ściernie  
 DE Schleifgewebe  
 RU Бумага наждачная на тканевой основе  
 CZ Brusné plátno  
 RO Pânză abrazivă  
 HU Csiszolóvászon  
 ES Paño abrasivo

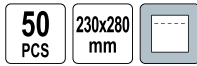

No.	Grit / Ziamistość	Size / Rozmiar [mm]	pcs / szt.	
07530	P36	230x280	50	500
07540	P46	230x280	50	500
07560	P60	230x280	50	500
07580	P80	230x280	50	500
07610	P100	230x280	50	500
07620	P120	230x280	50	500
07630	P150	230x280	50	500

EN No end abrasive band  
 PL Taśma ścierna bezkońcowa  
 DE Schleifband  
 RU Лента шлифовальная бесконечная  
 CZ Pás brusný nekonečný  
 RO Banda abrazivă  
 HU Végtelelenített csiszolószalag  
 ES Banda abrasiva sin extremos

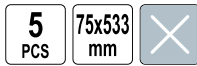

No.	Grit / Ziamistość	Size / Rozmiar [mm]	pcs / szt.	
07664	P40	75x533	5	20/60
07665	P60	75x533	5	20/60
07666	P80	75x533	5	20/60
07667	P100	75x533	5	20/60
07668	P120	75x533	5	20/60

EN Abrasive sponge  
 PL Gąbka ścierna  
 DE Schleifschwamm  
 RU Шлифовальная сетка  
 CZ Hubka brusná  
 RO Burete abraziv  
 HU Dörzsszivacs  
 ES Esponja abrasiva



No.	Grit / Ziamistość	Size / Rozmiar [mm]	
07910	P46	124x98x12	100
07911	P60	124x98x12	100
07912	P80	124x98x12	100
07913	P100	124x98x12	100
07914	P120	124x98x12	100
07915	P150	124x98x12	100
07916	P180	124x98x12	100

EN Abrasive mesh  
 PL Siatka ścierna  
 DE Schleifgitter  
 RU Шлифовальная сетка  
 CZ Brusné pletivo  
 RO Plasă abrazivă  
 HU Csiszolóháló  
 ES Red abrasiva nacional

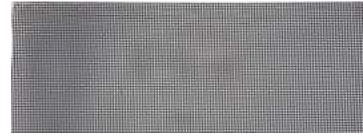

No.	Grit / Ziamistość	Size / Rozmiar [mm]	
07879	P40	105x280	50
07880	P60	105x280	50
07881	P80	105x280	50
07882	P100	105x280	50
07883	P120	105x280	50
07884	P150	105x280	50
07885	P180	105x280	50
07886	P220	105x280	50

EN Abrasive sponge  
 PL Kostka ścierna  
 DE Schleifschwamm  
 RU Губка для шлифования  
 CZ Hubka brusná  
 RO Burete abraziv  
 HU Dörzsszivacs  
 ES Esponja abrasiva



No.	Grit / Ziamistość	Size / Rozmiar [mm]	
08288	P60	68x100x25	100
08289	P80	68x100x25	100
08290	P100	68x100x25	100
08291	P120	68x100x25	100
08292	P150	68x100x25	100
08293	P180	68x100x25	100

EN Abrasive sponge  
 PL Kostka ścierna  
 DE Schleifschwamm  
 RU Губка для шлифования  
 CZ Hubka brusná  
 RO Burete abraziv  
 HU Dörzsszivacs  
 ES Esponja abrasiva



No.	Grit / Ziamistość	Size / Rozmiar [mm]	
08301	P60	125x90x65x25	100
08302	P80	125x90x65x25	100
08303	P100	125x90x65x25	100
08304	P120	125x90x65x25	100
08306	P150	125x90x65x25	100
08307	P180	125x90x65x25	100
08308	P220	125x90x65x25	100

EN Abrasive disc with velcro  
 PL Krążek ścierny z rzepem  
 DE Fiberschleifscheiben ungelocht  
 RU Круг шлифовальный на липучке  
 CZ Brusný kotouč na suchý zip  
 RO Disc abraziv (scai)  
 HU Csiszoló tárcsa (tapadókoronggal)  
 ES Juego de discos abrasivos (velcro)

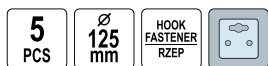

No.	Grit / Ziarnistość	Ø [mm]	pcs / szt.	
08553	P36	125	5	50/200
08554	P40	125	5	50/200
08556	P60	125	5	50/200
08558	P80	125	5	50/200
08560	P100	125	5	50/200
08562	P120	125	5	50/200
08565	P150	125	5	50/200

EN Abrasive sheets with holes  
 PL Arkusze ściernie z otworami  
 DE Schleifbogen gelocht  
 RU Шлифовальная бумага перфорированная  
 CZ Brusné listy s otvory  
 RO Hartie abraziva cu orificii  
 HU Csiszoló papír lyukakkal  
 ES Ojas abrasivas con agujas

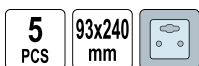

No.	Grit / Ziarnistość	Size / Rozmiar [mm]	pcs / szt.	
08534	P40	93x240	5	50/200
08536	P60	93x240	5	50/200
08538	P80	93x240	5	50/200
08540	P100	93x240	5	50/200
08542	P120	93x240	5	50/200
08545	P150	93x240	5	50/200

EN Sanding block  
 PL Blok ścierny  
 DE Handschleifer  
 RU Брусок для шлифования  
 CZ Brusný blok  
 RO Suport smirghel  
 HU Csiszoló blokk  
 ES Bloque abrasivo



No.	Size / Rozmiar [mm]	
07970	210x100	20/80

EN Abrasive disc with holes  
 PL Krążek ścierny z otworami  
 DE Schleifscheibe mit Löchern  
 RU Круг шлифовальный перфорированный  
 CZ Brusný kotouč s otvory  
 RO Disc abraziv cu orificii  
 HU Csiszolókorong nyílásokkal  
 ES Disco abrasivo con orificios

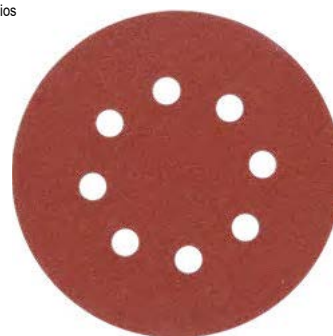

No.	Grit / Ziarnistość	Ø [mm]	pcs / szt.	
08573	P36	125	5	50/200
08574	P40	125	5	50/200
08576	P60	125	5	50/200
08578	P80	125	5	50/200
08580	P100	125	5	50/200
08582	P120	125	5	50/200
08585	P150	125	5	50/200

EN Sanding block  
 PL Blok ścierny  
 DE Handschleifer  
 RU Брусок для шлифования  
 CZ Brusný blok  
 RO Suport smirghel  
 HU Csiszoló blokk  
 ES Bloque abrasivo



No.	Size / Rozmiar [mm]	
07950	160x85	20/100

EN Hand grinding block  
 PL Blok ścierny z rzepem  
 DE Schleifblock mit Klett  
 RU Абразивный блок с липучкой  
 CZ Brusná kostka se suchým zipem  
 RO Suport de slefuire manual  
 HU Csiszoló blokk, tépőzáras  
 ES Bloque abrasivo con velcro



No.	Ø [mm]	
07955	125	10/60

EN Hand grinding block  
 PL Blok ścierny z rzepem  
 DE Schleifblock mit Klett  
 RU Абразивный блок с липучкой  
 CZ Brusná kostka se suchým zipem  
 RO Suport de slefuire manual  
 HU Csiszolóblokk, tépőzáras  
 ES Bloque abrasivo con velcro



No.	Ø [mm]	
07956	150	10/60

EN Sanding block  
 PL Blok ścierny skręcany  
 DE Handschleifer  
 RU Тёрка для шлифования  
 CZ Brusný blok  
 RO Suport smirghel  
 HU Csiszolóblokk  
 ES Bloque abrasivo

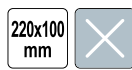

No.	Size / Rozmiar [mm]	
07960	220x100	30

EN Polishing set  
 PL Zestaw polerski  
 DE Polieret  
 RU Полировальный набор

CZ Čistící a leštící souprava  
 RO Set pt. lustruit  
 HU Tisztító és polírozó készlet  
 ES Conjunto de limpieza e polimento



No.	
25420	30/60

EN Hand grinding block  
 PL Blok ścierny z rzepem  
 DE Schleifblock mit Klett  
 RU Абразивный блок с липучкой  
 CZ Brusná kostka se suchým zipem  
 RO Suport de slefuire manual  
 HU Csiszolóblokk, tépőzáras  
 ES Bloque abrasivo con velcro



No.	Ø [mm]	
07957	150	10/120

EN Sanding block  
 PL Blok ścierny zatrzask  
 DE Handschleifer  
 RU Тёрка для шлифования  
 CZ Brusný blok  
 RO Suport smirghel  
 HU Csiszolóblokk  
 ES Bloque abrasivo



No.	Size / Rozmiar [mm]	
07962	210x100	30

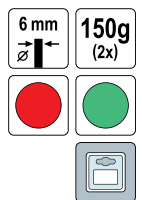
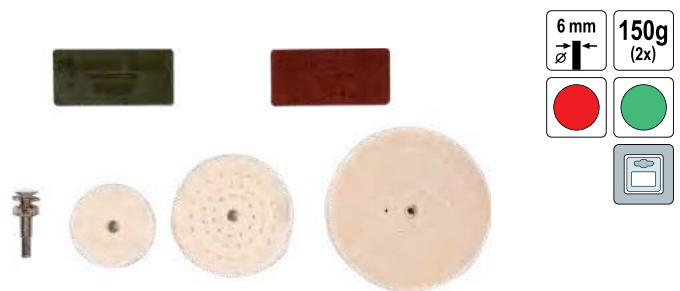

Memo



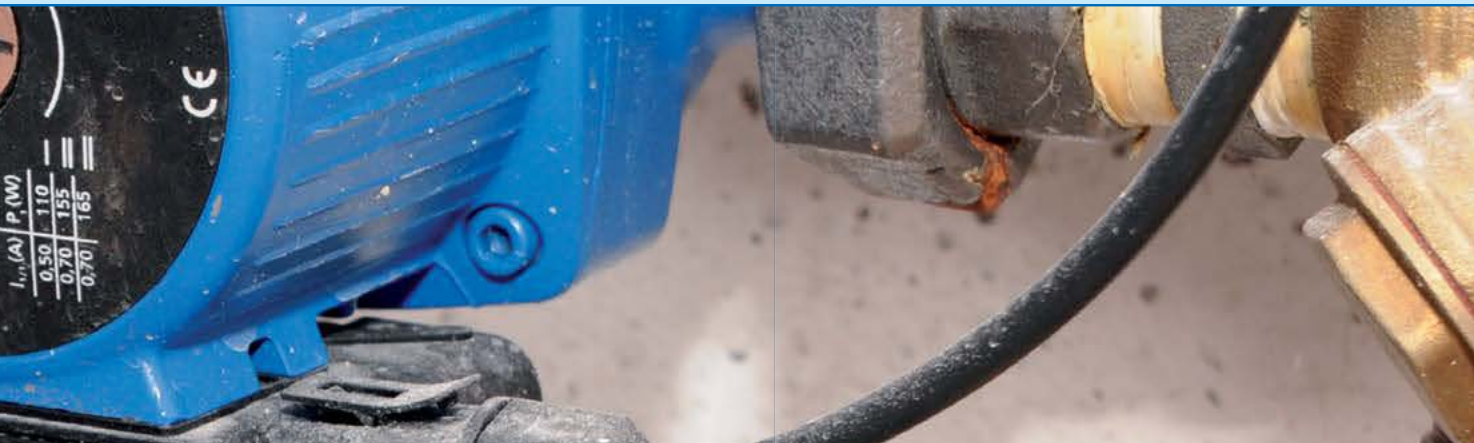

# 9

## Plumbing tools Narzędzia hydrauliczne





**Ratchet die stocks**  
Komplety gwintownic ręcznych

.....120 

**Hinged pipe vices**  
Imadła zaciskowe do rur

.....120 

**Water pump pliers**  
Szczypce nastawne

.....120 

**Pipe wrenches**  
Klucze do rur

.....120-121 

**Pipe wrenches Stillson type**  
Klucze do rur typu Stillson..... 120

**Adjustable pipe wrenches**  
Klucze do rur nastawne..... 121

**Adjustable wrenches**  
Klucze nastawne francuskie..... 121

**Chain pipe wrenches**  
Klucze do rur łańcuchowe

.....121 

**Plumbing assembly accessories**  
Montażowe akcesoria hydrauliczne

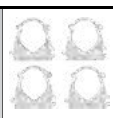
.....122-123 

**Pipe cutters**  
Obcinaki do rur

.....123 

**Calibrators**  
Kalibratory

.....124 

**Pipe welders**  
Zgrzewarki do rur

.....124-125 

**Hydraulic accessories**  
Akcesoria hydrauliczne

.....125-126 

EN Ratchet die stock  
 PL Zestaw gwintownic  
 DE Schneidkluppensatz  
 RU Набор резьбонарезной сантехнический  
 CZ Sada závitníků  
 RO Set de filiere  
 HU Menetfűrő készlet  
 ES Tarrajas para tubo

7 PCS	3/8" 9.5 mm	1/2" 12.7 mm	3/4" 19 mm	1" 25 mm
			5/4" 32 mm	



**VOREL**

No.	Size / Rozmiar	pcs / szt.	
55820	3/8" (10.0 mm), 1/2" (12.5 mm), 3/4" (19.0 mm), 1" (25.0 mm), 1-1/4" (32.0 mm)	7	4

EN Hinged pipe vice  
 PL Imadło zaciskowe do rur  
 DE Rohrschraubstock  
 RU Тиски для труб  
 CZ Upínací svěrák na trubky  
 RO Menghină pt. țevi  
 HU Satu, csőszorító  
 ES Tornillo de apriete para tubos



**VOREL**

No.	Mounting element diameter / Średnica mocowanego elementu [mm]	
36570	13-50	6

EN Pipe wrench  
 PL Klucz do rur  
 DE Rohrschlüssel  
 RU Ключ трубный  
 CZ Klíč součástí na trubky  
 RO Cheie reglabila pt. tevi  
 HU Csőkulcs  
 ES Llave para tubos



No.	L [mm]	
55250	250	6/48
55300	300	6/36
55350	350	6/24

EN Ratchet die stock  
 PL Zestaw gwintownic  
 DE Schneidkluppensatz  
 RU Набор резьбонарезной сантехнический  
 CZ Sada závitníků  
 RO Set de filiere  
 HU Menetfűrő készlet  
 ES Tarrajas para tubo

6 PCS	1.5" 38 mm	2" 50 mm	
----------	---------------	-------------	--



**VOREL**

No.	Size / Rozmiar	pcs / szt.	
55830	1-1/2" (38.0 mm), 2" (50.0 mm)	6	2

EN Water pump pliers  
 PL Szczypce nastawne  
 DE Wasserpumpenzange  
 RU Клещи переставные  
 CZ Nastavitelné kleště  
 RO Cieste papagal  
 HU Állítható fogó  
 ES Tenaza ajustable

250 mm	7 POSITIONS POZYCJE	
-----------	---------------------------	--



**VOREL**

No.	L [mm]	
41510	250	10/50

EN Pipe wrench  
 PL Klucz do rur  
 DE Rohrschlüssel  
 RU Ключ трубный

CZ Klíč součástí na trubky  
 RO Cheie reglabila pt. tevi  
 HU Csőkulcs  
 ES Llave para tubos



**VOREL**

No.	L [mm]	
55620	195	6/36
55625	245	6/30
55630	275	6/24
55635	310	6/18
55645	395	4/12
55660	490	2/6
55690	750	2/4

EN Adjustable pipe wrench  
 PL Klucz nastawny do rur  
 DE Rohrschlüssel  
 RU Ключ трубный переставной

CZ Nastavitelný klíč na trubky  
 RO Cheie reglabilă pt. țevi  
 HU Állítható csőkulcs  
 ES Llave para tubos



No.	Max. pipe diameter / Maks. średnica rury	L [mm]	
55100	1" (25 mm)	330	12/36
55150	1-1/2" (38 mm)	390	10/20
55200	2" (50 mm)	540	6/12

EN Adjustable pipe wrench  
 PL Klucz nastawny do rur  
 DE Rohrschlüssel  
 RU Ключ трубный переставной

CZ Nastavitelný klíč na trubky  
 RO Cheie reglabilă pt. țevi  
 HU Állítható csőkulcs  
 ES Llave para tubos



**VOREL**

No.	Max. pipe diameter / Maks. średnica rury	L [mm]	
55215	1" (25 mm)	310	24
55216	1-1/2" (38 mm)	420	1/16
55217	2" (50 mm)	560	1/8

EN Adjustable wrench  
 PL Klucz nastawny francuski  
 DE Stahlschraubenschlüssel (Franzose)  
 RU Ключ разводной

CZ Nastavitelný klíč francouz  
 RO Cheie reglabilă franceză  
 HU Állítható franciakulcs  
 ES Llave ajustable inglesa



**VOREL**

No.	Jaws opening capacity / Zakres rozwarcia szczęk [mm]	Jaws width / Szerokość szczęk [mm]	
54497	0-25	60	10
54498	0-35	70	10
54499	0-45	80	10
54500	0-55	90	5
54510	0-65	100	5

EN Adjustable pipe wrench  
 PL Klucz nastawny do rur  
 DE Rohrschlüssel  
 RU Ключ трубный переставной  
 CZ Nastavitelný klíč na trubky  
 RO Cheie reglabilă pt. țevi  
 HU Állítható csőkulcs  
 ES Llave para tubos



**VOREL**

No.	Max. pipe diameter / Maks. średnica rury	L [mm]	
55210	1" (25 mm)	320	1/24
55211	1-1/2" (38 mm)	425	1/16
55212	2" (50 mm)	560	1/8

EN Adjustable pipe wrench  
 PL Klucz nastawny do rur  
 DE Rohrschlüssel  
 RU Ключ трубный переставной

CZ Nastavitelný klíč na trubky  
 RO Cheie reglabilă pt. țevi  
 HU Állítható csőkulcs  
 ES Llave para tubos



**VOREL**

No.	Max. pipe diameter / Maks. średnica rury	L [mm]	
55220	1" (25 mm)	315	1/24
55221	1-1/2" (38 mm)	425	1/16
55222	2" (50 mm)	560	1/8

EN Chain pipe wrench  
 PL Klucz łańcuchowy do rur  
 DE Kettenrohrzange  
 RU Ключ цепной для труб  
 CZ Klíč řetězový na trubky  
 RO Cheie reglabilă pt. țevi cu lanț  
 HU Láncos csőfogó  
 ES Llave de cadena



**VOREL**

No.	Max. pipe diameter / Maks. średnica rury	L [mm]	
55792	4" (100.0 mm)	300	10/30

- EN Pipe clips
- PL Uchwyty do rur
- DE Rohrclips
- RU Держатели для труб (клипсы)
- CZ Přichytky trubkové
- RO Cleme pt. tevi
- HU Csőbillincsek
- ES Clips para tubos

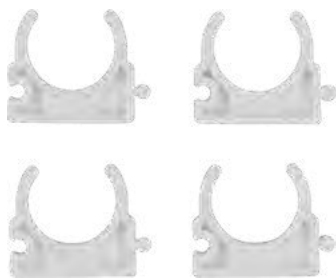

No.	Pipe diameter / Średnica rury [mm]	pcs / szt.	
54811	15-16	4	50
54812	18	4	50
54813	20	4	50
54814	22	4	50
54815	25	4	50
54816	28	4	50
54817	32	4	50

- EN Pipe clips Ring
- PL Uchwyty Ring do rur
- DE Rohrclips Ring
- RU Крепежные клипсы для труб
- CZ Přichytky trubkové Ring
- RO Cleme pt. tevi tip inel
- HU Ring típusú csőbillincsek
- ES Clips para tubos Ring

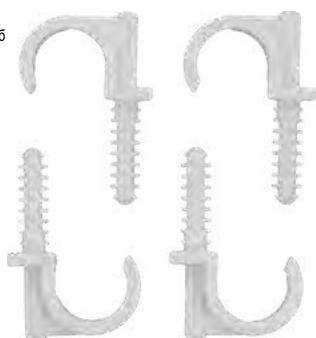

No.	Pipe diameter / Średnica rury [mm]	pcs / szt.	
54850	15-16	4	50
54851	18	4	50
54852	20	4	50
54853	22	4	50
54854	25	4	50
54855	28	4	50
54856	32	4	50

- EN Double pipe clips
- PL Haki do rur bis
- DE Doppelrohrhaken
- RU Держатели для труб и каналов двойные
- CZ Natloukací přichytky pro trubky dvojité
- RO Cleme duble pt. tevi
- HU Kettős kábelrögzítő bilincsek
- ES Abrazaderas para tubos dobles

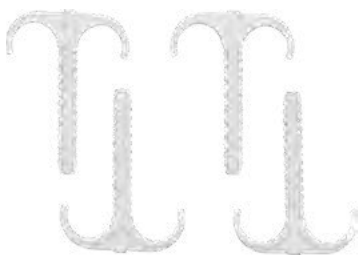

No.	Pipe diameter / Średnica rury [mm]	pcs / szt.	
54871	15-28	4	50

- EN Self locking pipe clips
- PL Uchwyty zamykane do rur
- DE Rohrschellen
- RU Держатели для труб (клипсы) с крышкой
- CZ Trubkové přichytky s klipem
- RO Cleme pt. tevi autoblocante
- HU Zárátható műanyag csőbillincsek
- ES Clips cerrados para tubos

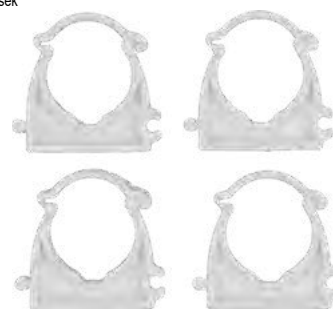

No.	Pipe diameter / Średnica rury [mm]	pcs / szt.	
54830	15-16	4	50
54831	18	4	50
54832	20	4	50
54833	22	4	50
54834	25	4	50
54835	28	4	50
54836	32	4	50
54837	40	4	50

- EN Pipe clips
- PL Haki do rur
- DE Rohrclips
- RU Держатели для труб и каналов одиночные
- CZ Natloukací přichytky pro trubky
- RO Cleme pt. tevi
- HU Kábelrögzítő bilincsek
- ES Abrazaderas para tubos

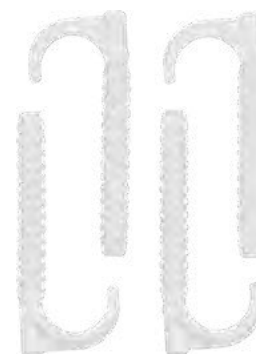
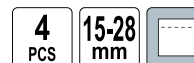

No.	Pipe diameter / Średnica rury [mm]	pcs / szt.	
54870	15-28	4	50

- EN Pipe clips with anchor
- PL Haki do rur z kolkiem
- DE Dübelschellen
- RU Держатели для труб с дюбелем
- CZ Přichytky pro trubky s hmoždinkou
- RO Cleme pt. tevi cu ancora
- HU kábelrögzítő bilincsek tipivel
- ES Abrazaderas para tubos con taco

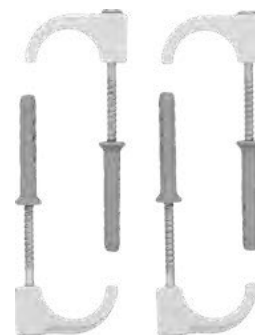
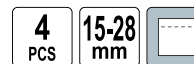

No.	Pipe diameter / Średnica rury [mm]	pcs / szt.	
54875	15-28	4	50



- EN Double pipe clips with anchor
- PL Haki do rur bis z kołkiem
- DE Doppeldübelhaken
- RU Держатели для труб двойные с дюбелем
- CZ Dvojité přichytky pro trubky s hmoždinkou
- RO Cleme duble pt. tevi cu ancora
- HU Kettős kábelrögzítő bilincsek tiplivel
- ES Abrazaderas para tubos dobles con taco

4 PCS 15-28 mm



No.	Pipe diameter / Średnica rury [mm]	pcs / szt.	
54876	15-28	4	50

- EN Sealing plug
- PL Korek hydrauliczny
- DE Stopfen für Dichtheitsprüfung
- RU Заглушка для проверки герметичности
- CZ Montážní zátká
- RO Dop de etanșare
- HU Záródugó
- ES Tapón para pruebas hidráulicas



No.	Thread size / Rozmiar gwintu	
54901	G1/2	20

- EN Sealing plug
- PL Korek hydrauliczny
- DE Stopfen für Dichtheitsprüfung
- RU Заглушка для проверки герметичности
- CZ Montážní zátká
- RO Dop de etanșare
- HU Záródugó
- ES Tapón para pruebas hidráulicas

10 PCS



No.	Thread size / Rozmiar gwintu	pcs / szt.	
54903	G1/2	10	20

- EN Sealing plug
- PL Korek hydrauliczny
- DE Stopfen für Dichtheitsprüfung
- RU Заглушка для проверки герметичности
- CZ Montážní zátká
- RO Dop de etanșare
- HU Záródugó
- ES Tapón para pruebas hidráulicas



No.	Thread size / Rozmiar gwintu	
54900	G1/2	20

- EN Sealing plug
- PL Korek hydrauliczny
- DE Stopfen für Dichtheitsprüfung
- RU Заглушка для проверки герметичности
- CZ Montážní zátká
- RO Dop de etanșare
- HU Záródugó
- ES Tapón para pruebas hidráulicas

10 PCS

9



No.	Thread size / Rozmiar gwintu	pcs / szt.	
54902	G1/2	10	20

- EN Pipe cutter
- PL Obcinak do rur
- DE Rohrabschneider
- RU Труборез для труб
- CZ Rezač trubek
- RO Dispozitiv pt. tăiat tevi
- HU Csővágó
- ES Cortatubos

1/10"-5/4" 3-32 mm PVC PP PU PE Al Cu BEARING STEEL STAL LOZYSKOWA DEBURRER GRATOWNIK SPARE CUTTING WHEEL ZAPASOWE KOLKO TNAČE



No.	Cutting diameter / Średnica cięcia	
78381	1/10" - 1-1/4" (3-32 mm)	60

- EN Deburrer
- PL Gratownik
- DE Entgrater
- RU Гратосниматель
- CZ Odhrotovač
- RO Debavurator
- HU Sorjázó
- ES Desbarbador

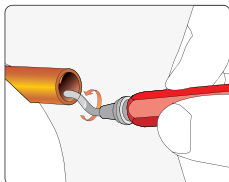
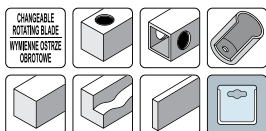

No.		
78388		50/150

9

- EN PVC pipe cutter
- PL Obcinak do rur PVC
- DE PVC Rohrschneider
- RU Труборез для ПВХ труб
- CZ Řezač PVC trubek
- RO Foarfecă pt. tăiat țevi din PVC
- HU Csővágó olló PVC csövekhez
- ES Tijera cortatubos para PVC



No.	Max. cutting diameter / Maks. średnica cięcia [mm]	
78341	42	12/48

- EN PVC plastic pipe welder
- PL Zgrzewarka do rur termoplastycznych
- DE Schweißgerät für thermoplastische Rohre
- RU Аппарат для сварки пластиковых труб
- CZ Svářečka na termoplastické trubky
- RO Masina de sudat țevi termoplastice
- HU Hegesztő berendezés termoplasztikus csövekhez
- ES Máquina de soldar las tubos termoplásticos



Ø 16, 20, 25, 32, 40, 50 mm



No.	Power / Moc [W]	
78911	800	5

- EN Pipe deburrer
- PL Gratownik do rur
- DE Rohrentgrater
- RU Гратосниматель для труб
- CZ Odhrotovač trubek
- RO Debavurator pt. tevi
- HU Sorjázó
- ES Desbarbador de tubos

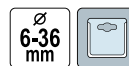

No.	Cutting diameter / Średnica cięcia [mm]	
78385	6-36	25/50

- EN Pipe calibration tool
- PL Kalibrator do rur
- DE Kalibrierer für Mehrschichtverbundrohr
- RU Калибратор пластиковый
- CZ Kalibrátor pro trubku
- RO Calibrator teava multistrat
- HU Csőkalibráló
- ES Calibrador para tubos multicapa

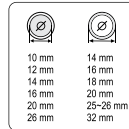
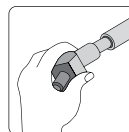

No.		
55740		300

- EN PVC plastic pipe welder
- PL Zgrzewarka do rur termoplastycznych
- DE Schweißgerät für thermoplastische Rohre
- RU Аппарат для сварки пластиковых труб
- CZ Svářečka na termoplastické trubky
- RO Masina de sudat țevi termoplastice
- HU Hegesztő berendezés termoplasztikus csövekhez
- ES Máquina de soldar las tubos termoplásticos



Ø 20, 25, 32, 40, 50, 63 mm



No.	Power / Moc [W]	
78912	750, 1500	4

- EN PVC plastic pipe welder
- PL Zgrzewarka do rur termoplastycznych
- DE Schweißgerät für thermoplastische Rohre
- RU Аппарат для сварки пластиковых труб
- CZ Svářečka na termoplastické trubky
- RO Masina de sudat țevi termoplastice
- HU Hegesztő berendezés termoplasztikus csövekhez
- ES Máquina de soldar los tubos termoplásticos



230V~ 50Hz	800 W	1500 W
0-300 °C	IP24	



Ø 16, 20, 25, 32, 40, 50, 63 mm



No.	Power / Moc [W]	
78910	800, 1500	5

- EN PTFE tape
- PL Taśma PTFE
- DE Teflonband
- RU Фумлента
- CZ Teflonová páska
- RO Bandă de teflon
- HU Teflon szalag
- ES Cinta de teflón



No.	W [mm]	Thickness / Grubość [mm]	L [m]	
75201	12	0.1	12	250/1000
75202	19	0.2	15	200

- EN Thread sealing paste
- PL Pasta uszczelniająca do gwintów
- DE Paste zum Abdichten der Gewinde
- RU Паста для герметизации резьбы
- CZ Těsnící pasta na závit
- RO Pastă etanșantă pt. filet
- HU Menettítő paszta
- ES Pasta selladora para roscas



No.	m [g]	
86750	65	48
86751	250	24

- EN Oakum
- PL Pakuły lniane
- DE Leinenwerg
- RU Лен сантехнический
- CZ Lněná koudel
- RO Căiți de in
- HU Len kóc
- ES Estopa de lino



No.	m [g]	
86760	100	50

- EN Thread sealing paste
- PL Pasta uszczelniająca do gwintów
- DE Paste zum Abdichten der Gewinde
- RU Паста для герметизации резьбы
- CZ Těsnící pasta na závit
- RO Pastă etanșantă pt. filet
- HU Menettítő paszta
- ES Pasta selladora para roscas



No.	m [g]	
86752	360	24

- EN Hydraulic repair kit
- PL Hydrauliczny zestaw naprawczy
- DE Hydraulischer Reparatursatz
- RU Комплект для уплотнения резьбы
- CZ Hydraulická opravárenská souprava
- RO Set de reparatii pt. instalatori
- HU Vízvezeték javító készlet
- ES Juego para reparaciones hidráulicas



No.	m [g]	
86761	100, 65	40

- EN Lubricant for PVC pipes
- PL Pasta poślizgowa do rur PCV
- DE Gleitpaste für PVC-Rohre
- RU Силиконовая смазка для ПВХ труб
- CZ Kluzná pasta na PVC trubky
- RO Pastă glisantă pt. țevi PVC
- HU Sikosító paszta PVC csövekhez
- ES Pasta de deslizamiento para tubos de PCV



No.	m [g]	
86770	250	18
86771	500	15

9

- EN Drain cleaner
- PL Pistolet do udrażniania rur
- DE Pistole zum Reinigen von Rohren
- RU Пневматический пистолет для прочистки труб
- CZ Pistole na čištění trubek
- RO Pistol pt. curățarea țevilor
- HU Csőtisztító pisztoly
- ES Pistola destapacaños



No.	Ø [mm]	Box
55500	63, 135	10

- EN Drain auger
- PL Spirala kanalizacyjna
- DE Hand-Rohrreinigungsspirale
- RU Трос для прочистки канализационных труб и каналов
- CZ Spirála na čištění trubek
- RO Dedeman cablu pt. desfundat canale
- HU Csőtisztító spirál
- ES Varilla para limpiar drenajes

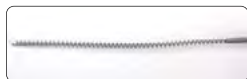

No.	Ø [mm]	L [m]	Box
55541	5	1.5	20/80
55542	6	3.0	18/36

- EN Hand pressure test pump
- PL Pompa ręczna do prób ciśnieniowych
- DE Handpumpe für Druckproben
- RU Ручной насос для опрессовки
- CZ Ruční čerpadlo pro tlakové testování
- RO Pompa manuala testat presiunea
- HU Kézi nyomáspróba szivattyú
- ES Bomba manual para pruebas de presión

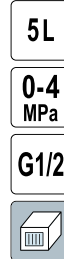

No.	Tank capacity / Pojemność zbiornika [l]	Box
55400	5	8

- EN Drain suction pump
- PL Pompa do udrażniania kanalizacji
- DE Rohrreinigungspumpe
- RU Пневматический вантуз для прочистки труб
- CZ Čerpadlo na čištění trubek
- RO Pompă pt. curățarea țevilor
- HU Lefolyótisztító pumpa
- ES Desatascador bomba de vacío

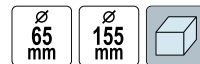

No.	Ø [mm]	Box
55505	65, 155	24

- EN Drain auger
- PL Spirala kanalizacyjna
- DE Hand-Rohrreinigungsspirale
- RU Трос для прочистки канализационных труб и каналов
- CZ Spirála na čištění trubek
- RO Dedeman cablu pt. desfundat canale
- HU Csőtisztító spirál
- ES Varilla para limpiar drenajes



No.	Ø [mm]	L [m]	Box
55544	9	5	5/10
55545	9	10	4/8





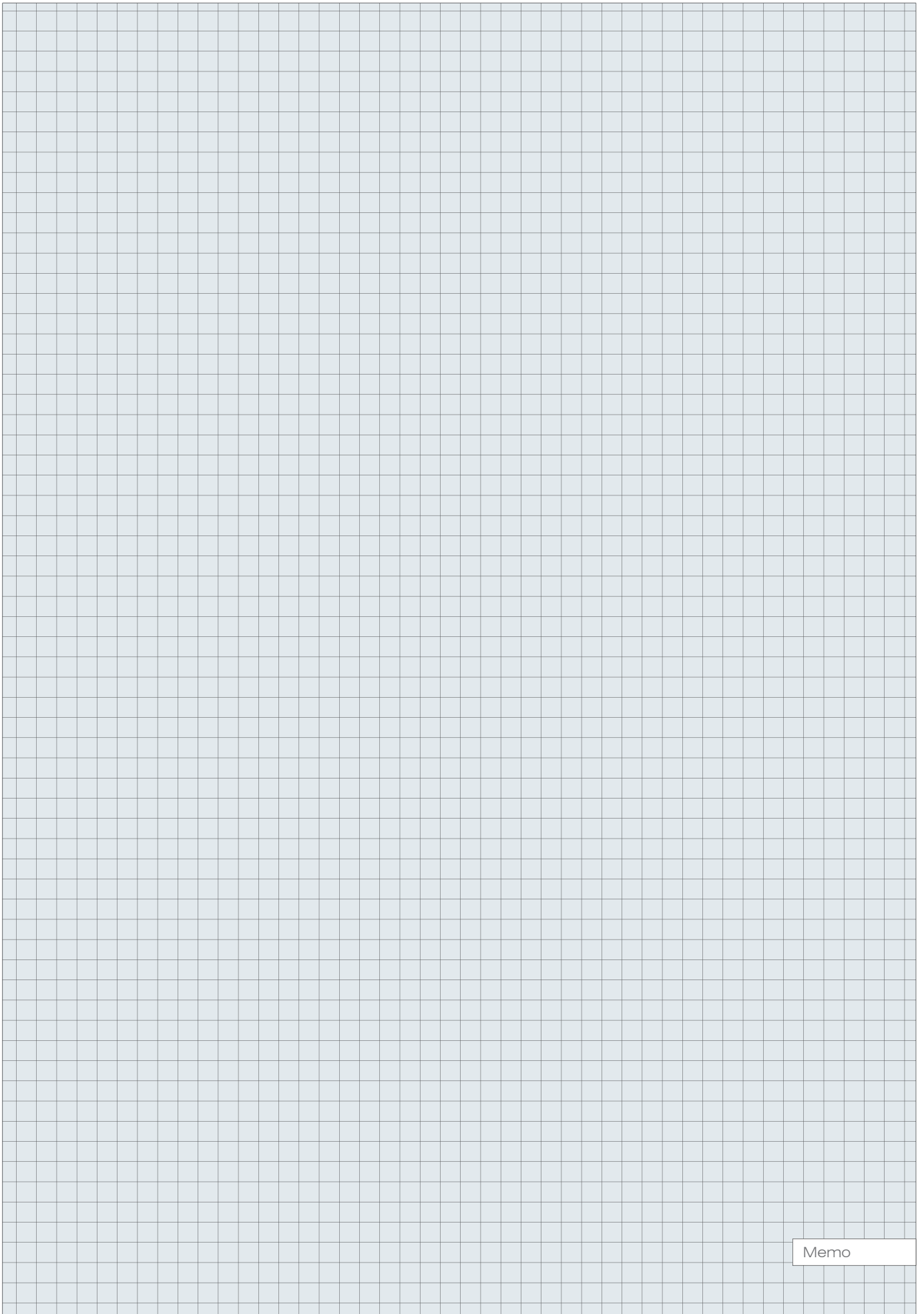

Memo

# 10

## Fastening tools Narzędzia do łączenia





<b>Hand riveters</b> Nitownice ręczne	
.....	130-131

<b>Hand riveters</b> Nitownice ręczne.....	130
<b>Hand riveting tool</b> Nitownice ręczne, dźwigniowe.....	131

<b>Rivets</b> Nity	
.....	131

<b>Aluminium blind rivets</b> Nity aluminiowe.....	131
---	-----

<b>Profile connection pliers</b> Szczypce do łączenia profili	
.....	132

<b>Staple guns, staples &amp; nails</b> Zszywacze, zszywki i gwoździe	
.....	132-134

<b>Staple guns</b> Zszywacze.....	132
--------------------------------------	-----

<b>Staple removers</b> Rozszywacze.....	133
--	-----

<b>Staples</b> Zszywki.....	133
--------------------------------	-----

<b>Brad nails</b> Szyfty.....	133
----------------------------------	-----

<b>Nails</b> Gwoździe.....	134
-------------------------------	-----

<b>Pliers for hollow expansion bolts</b> Zaciskarki do kołków typu molly	
.....	134

<b>Screw, plug &amp; hook sets</b> Zestawy wkrętów, kołków i haków	
.....	135

<b>Caulking guns</b> Wyciskacze do mas	
.....	135-136

<b>Foam guns</b> Pistolety do pianki montażowej	
.....	137-138

<b>Hose clips</b> Opaski ślimakowe	
.....	138-139

<b>Screw clamps</b> Obejmy śrubowe	
.....	139

<b>Cable ties</b> Opaski plastikowe	
.....	139

<b>Hook &amp; loop cable ties</b> Opaski z rzepem	
.....	140

<b>Glue sticks &amp; glue applicators</b> Wkłady klejowe i dozowniki do kleju	
.....	140

<b>Packing tape dispensers</b> Podajniki taśmy pakowej	
.....	140

<b>Tapes</b> Taśmy	
.....	140-142

<b>Ropes &amp; lines</b> Sznury i linki	
.....	142-143

EN Hand riveter  
 PL Nitownica ręczna  
 DE Hand-Nietzange  
 RU Ручной заклёпочник  
 CZ Ruční nýtovačka  
 RO Presă de nituit manuală  
 HU Kézi pöpszegecsűző  
 ES Remachadora de mano



No.	L [mm]	Ø [mm]	
70000	250	2,4, 3,2, 4, 4,8	12/24

EN Hand riveter  
 PL Nitownica ręczna  
 DE Hand-Nietzange  
 RU Ручной заклёпочник  
 CZ Ruční nýtovačka  
 RO Presă de nituit manuală  
 HU Kézi pöpszegecsűző  
 ES Remachadora de mano



No.	L [mm]	Ø [mm]	
70023	250	2,4, 3,2, 4, 4,8	12/24

EN Hand riveter  
 PL Nitownica ręczna  
 DE Hand-Nietzange  
 RU Ручной заклёпочник  
 CZ Ruční nýtovačka  
 RO Presă de nituit manuală  
 HU Kézi pöpszegecsűző  
 ES Remachadora de mano

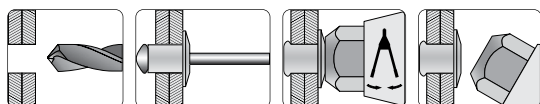
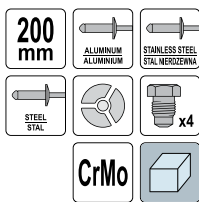

No.	L [mm]	Ø [mm]	
70035	200	2,4, 3,2, 4, 4,8	30

EN Hand riveter  
 PL Nitownica ręczna  
 DE Hand-Nietzange  
 RU Ручной заклёпочник  
 CZ Ruční nýtovačka  
 RO Presă de nituit manuală  
 HU Kézi pöpszegecsűző  
 ES Remachadora de mano



No.	L [mm]	Ø [mm]	
70020	240	2,4, 3,2, 4, 4,8	12/24

EN Hand riveter  
 PL Nitownica ręczna  
 DE Hand-Nietzange  
 RU Ручной заклёпочник  
 CZ Ruční nýtovačka  
 RO Presă de nituit manuală  
 HU Kézi pöpszegecsűző  
 ES Remachadora de mano



No.	L [mm]	Ø [mm]	
70030	230	2,4, 3,2, 4, 4,8	15/30

EN Hand riveter  
 PL Nitownica ręczna  
 DE Hand-Nietzange  
 RU Ручной заклёпочник  
 CZ Ruční nýtovačka  
 RO Presă de nituit manuală  
 HU Kézi pöpszegecsűző  
 ES Remachadora de mano

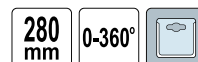

No.	L [mm]	Ø [mm]	
70100	280	2,4, 3,2, 4, 4,8	6/24



EN Hand riveter  
 PL Nitownica ręczna  
 DE Hand-Nietzange  
 RU Ручной заклепочник  
 CZ Ruční nýtovačka  
 RO Presă de nituit manuală  
 HU Kézi popszegecshúzó  
 ES Remachadora de mano



**VOREL**

No.	L [mm]	Ø [mm]	
70160	250	2,4, 3,2, 4, 4,8	12/24

EN Hand riveting tool  
 PL Nitownica dźwigniowa  
 DE Blindnietzange  
 RU Заклепочник рычажный  
 CZ Nýtovačka páková  
 RO Nituire pârghie  
 HU Popszegecshúzó  
 ES Remachadora de palanca

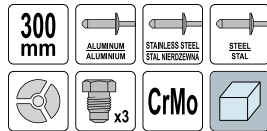

**VOREL**

No.	L [mm]	Ø [mm]	
70201	300	3,2, 4, 4,8	20

EN Hand riveting tool  
 PL Nity aluminiumowa  
 DE Aluminiumblindnietzange  
 RU Заклепочник рычажный  
 CZ Nýtovačka páková  
 RO Nituire pârghie  
 HU Popszegecshúzó  
 ES Remachadora de palanca



**VOREL**

No.	L [mm]	Ø [mm]	
70210	400	3,4, 4, 4,8	10/20

EN Hand nut tool  
 PL Nitownica ręczna do nitonakrętek  
 DE Nietmutterzange  
 RU Ручной заклепочник для резьбовых заклепок

CZ Nýtovací kleště na matici  
 RO Clește pt. piulițe nituibile  
 HU Emelyűs popszegecshúzó  
 ES Remachadora de tuercas

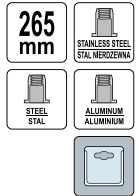

**VOREL**

No.	L [mm]	Nuts diameter / Średnica nitonakrętek	
70270	265	M3, M4, M5, M6	5/20

EN Hand riveter  
 PL Nitownica ręczna  
 DE Hand-Nietzange  
 RU Ручной заклепочник

CZ Ruční nýtovačka  
 RO Presă de nituit manuală  
 HU Kézi popszegecshúzó  
 ES Remachadora de mano

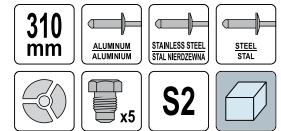

**VOREL**

No.	L [mm]	Ø [mm]	
70202	310	2,4, 3,2, 4, 4,8, 6,4	16

EN Aluminium blind rivets  
 PL Nity aluminiumowe  
 DE Aluminiumblindnieten  
 RU Заклёпки алюминиевые

CZ Hliníkové nýty  
 RO Nituri din aluminiu  
 HU Alu popszegecs  
 ES Remaches de aluminio



**VOREL**

No.	L [mm]	Ø [mm]	pcs / szt.	
70320	6.4	3.2	50	150/300
70330	9.6	3.2	50	150/300
70340	12.7	3.2	50	150/300
70400	6.4	4.0	50	100/200
70410	9.6	4.0	50	25/200
70420	12.7	4.0	50	100/200
70430	19.0	4.0	50	100/200
70480	6.4	4.8	50	100/200
70490	9.6	4.8	50	100/200
70500	12.7	4.8	50	100/200
70510	19.0	4.8	50	25/150

EN Profile connection pliers  
 PL Szczypce do łączenia profili  
 DE Profil Verbundzange  
 RU Клещи для соединения профилей  
 CZ Kleště do spojování profilů  
 RO Cesteșterizat profile rigips  
 HU Profilösszekető fogó  
 ES Alicates para unir perfiles



No.	L [mm]	
04300	280	6/36

EN Staple gun  
 PL Zszywacz tapicerski  
 DE Tacker  
 RU Стенлеп  
 CZ Čalounická sešivačka  
 RO Capsator tapiterie  
 HU Kárpitos tűzőgép  
 ES Grapadora de tapicero



No.	Staple length / Długość zszywki [mm]	
71000	4-8	10/60

EN Staple gun  
 PL Zszywacz tapicerski  
 DE Tacker  
 RU Стенлеп  
 CZ Čalounická sešivačka  
 RO Capsator tapiterie  
 HU Kárpitos tűzőgép  
 ES Grapadora de tapicero

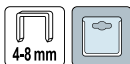

No.	Staple length / Długość zszywki [mm]	
71040	4-8	10/40

EN Staple gun  
 PL Zszywacz tapicerski  
 DE Tacker  
 RU Стенлеп  
 CZ Čalounická sešivačka  
 RO Capsator tapiterie  
 HU Kárpitos tűzőgép  
 ES Grapadora de tapicero



No.		
71060		6/24

EN Profile connection pliers  
 PL Szczypce do łączenia profili  
 DE Profil Verbundzange  
 RU Клещи для соединения профилей  
 CZ Kleště do spojování profilů  
 RO Cesteșterizat profile rigips  
 HU Profilösszekető fogó  
 ES Alicates para unir perfiles

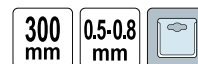

No.	L [mm]	
04301	300	6/24

EN Staple gun  
 PL Zszywacz tapicerski  
 DE Tacker  
 RU Стенлеп  
 CZ Čalounická sešivačka  
 RO Capsator tapiterie  
 HU Kárpitos tűzőgép  
 ES Grapadora de tapicero



No.	Staple length / Długość zszywki [mm]	
71050	4-14	10/40

EN Staple gun  
 PL Zszywacz tapicerski  
 DE Tacker  
 RU Стенлеп  
 CZ Čalounická sešivačka  
 RO Capsator tapiterie  
 HU Kárpitos tűzőgép  
 ES Grapadora de tapicero

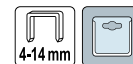

No.	Staple length / Długość zszywki [mm]	
71052	4-14	10/20

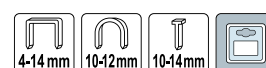

EN Hammer tacker  
 PL Zszywacz młotkowy  
 DE Hammer Tacker  
 RU Молотковый степлер  
 CZ Sponkovač kladivový  
 RO Capsator ciocan  
 HU Kalapács tűzőgép  
 ES Grapadora de martillo

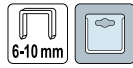

**VOREL**

No.	Staple length / Długość zszywki [mm]	
71080	6-10	6/24

EN Mesh pliers  
 PL Szczypce do mocowania siatki ogrodzeniowej  
 DE Zaunklammerzange  
 RU Степлер-сшиватель для металлической сетки и сетки-рабицы  
 CZ Kleště pro srovnání a montáž pletiv  
 RO Clește de capsat pt. fixarea gardurilor  
 HU Fogó kerítéskapocshoz  
 ES Hog anillo alicates



**VOREL**

No.		
49840		50

EN Staples  
 PL Zszywki  
 DE Heftklammern  
 RU Скобы  
 CZ Sponky  
 RO Capse tapiterie  
 HU Tűzőkapocs  
 ES Grapas

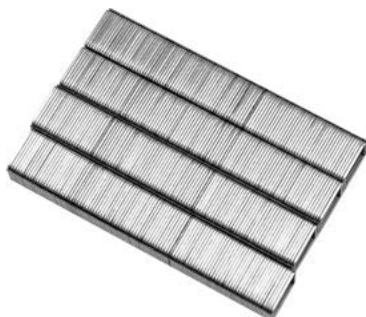

**VOREL**

No.	Staple length / Długość zszywki [mm]	Staple thickness / Grubość zszywki [mm]	Staple width / Szerokość zszywki [mm]	pcs / szt.	
72040	4	0.7	11.3	1000	60/480
72060	6	0.7	11.3	1000	60/360
72080	8	0.7	11.3	1000	60/300
72100	10	0.7	11.3	1000	60/240
72120	12	0.7	11.3	1000	50/200
72140	14	0.7	11.3	1000	40/160

EN Staple remover  
 PL Rozszywacz  
 DE Entkammerer  
 RU Расшиватель  
 CZ Rozešíváč  
 RO Extractor capse  
 HU Kapocskiszédo  
 ES Quitagrapas

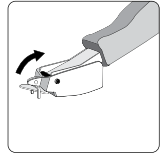

**VOREL**

No.		
71160		10/40

EN Staples type „E” for mesh pliers  
 PL Zszywki typu „E” do mocowania siatki  
 DE Zaunringe  
 RU Скобы для обжима сетки  
 CZ Svorcky pro montáž pletiva  
 RO Capse pt. făcut cuști  
 HU Kapcsok madárháló rögzítéséhez  
 ES Grapas omega



**VOREL**

No.	For / Dla	
49841	49840	10/60

EN Staples  
 PL Zszywki  
 DE Heftklammern  
 RU Скобы  
 CZ Sponky  
 RO Capse tapiterie  
 HU Tűzőkapocs  
 ES Grapas

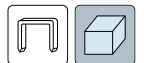

**VOREL**

No.	Staple length / Długość zszywki [mm]	Staple thickness / Grubość zszywki [mm]	Staple width / Szerokość zszywki [mm]	pcs / szt.	
71970	6	0.9	12.7	12000	10
71971	10	0.9	12.7	7500	10
71972	16	0.9	12.7	4500	10

EN Brad nails  
 PL Szyfty  
 DE Stauchkopfnägel  
 RU Шпилька для степлера  
 CZ Kolářské hřebíky  
 RO Cuie fara cap  
 HU Műanyag spakli  
 ES Palos

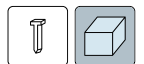

**VOREL**

No.	Staple length / Długość zszywki [mm]	Staple thickness / Grubość zszywki [mm]	Staple width / Szerokość zszywki [mm]	pcs / szt.	
71980	16	1.3	1.8	5000	27
71981	30	1.3	1.8	5000	18
71982	35	1.3	1.8	5000	15
71983	50	1.3	1.8	5000	15

EN Staples  
 PL Zszywki  
 DE Heftklammern  
 RU Скобы  
 CZ Sponky  
 RO Capse tapiterie  
 HU Tűzőkapocs  
 ES Grapas



**VOREL**

No.	Staple length / Długość zszywki [mm]	Staple thickness / Grubość zszywki [mm]	Staple width / Szerokość zszywki [mm]	pcs / szt.	
71975	16	1.2	5.5	2000	27
71976	21	1.2	5.5	2200	18
71977	25	1.2	5.5	2000	18

EN Coil nails  
 PL Gwoździe bębnowe  
 DE Spulennägel  
 RU Барабанные гвозди  
 CZ Hřebíky spojené drátem  
 RO Cuie in rola  
 HU Dobtáras szeg  
 ES Clavos de tambor

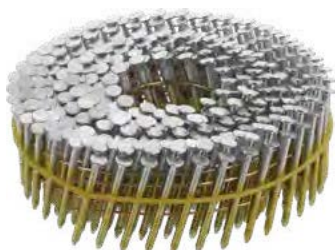

**VOREL**

No.	Nail length / Długość gwoździa [mm]	Nail diameter / Średnica gwoździa [mm]	pcs / szt.	
72015	32	2.1	7200	1
72016	38	2.1	7200	1
72017	50	2.1	5400	1
72018	64	2.5	3600	1
72019	70	2.5	3600	1
72020	75	2.5	3600	1
72021	80	2.8	3000	1
72022	90	2.8	3000	1

EN Nails on paper tape  
 PL Gwoździe taśmowe  
 DE Streifennägel  
 RU Гвозди отделочные для пневмопистолета  
 CZ Hřebík nastřelovací  
 RO Cuie  
 HU Siktáras szeg  
 ES Clavos de tira de papel



**VOREL**

No.	Nail length / Długość gwoździa [mm]	Nail diameter / Średnica gwoździa [mm]	pcs / szt.	
72010	50	2.8	3000	1
72011	65	2.8	3000	1
72012	75	2.8	3000	1
72013	90	3.1	2000	1

EN Coil nails  
 PL Gwoździe bębnowe  
 DE Coilnägel  
 RU Барабанные гвозди  
 CZ Hřebíky spojené drátem  
 RO Cuie in rola  
 HU Dobtáras szeg  
 ES Clavos de tambor



**VOREL**

No.	Nail length / Długość gwoździa [mm]	Nail diameter / Średnica gwoździa [mm]	pcs / szt.	
71990	32	2.1	7200	1
71991	38	2.1	7200	1
71992	50	2.1	5400	1
71993	64	2.5	3000	1
71994	70	2.5	3000	1
71995	75	2.5	3000	1
71996	80	2.8	3000	1
71997	90	2.8	3000	1

EN Coil nails  
 PL Gwoździe papowe bębnowe  
 DE Spulennägel  
 RU Гвозди барабанные для пневмопистолета  
 CZ Hřebíky spojené drátem  
 RO Cuie in rola  
 HU Dobtáras szeg  
 ES Clavos de tambor para filtros para tejados

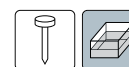

**VOREL**

No.	Nail length / Długość gwoździa [mm]	Nail diameter / Średnica gwoździa [mm]	pcs / szt.	
72000	19	3.1	4200	1
72001	22	3.1	4200	1

EN Pliers for hollow expansion bolts  
 PL Zaciskarka do kołków „Molly”  
 DE Maueranker-Einsetzwerkzeug  
 RU Клещи для дюбелей „Молли”  
 CZ Kleště kotvicí pro Molly hmoždinky  
 RO Cleste dibluri  
 HU Molly fogó üreges bővítőcsavarokhoz  
 ES Alicata para tacos „Molly”



**VOREL**

No.	
04320	10/40



EN Screw & plug set  
 PL Zestaw wkrętów i kołków rozporowych  
 DE Dübel- und Schrauben Sortiment  
 RU Набор крепежа шурупы и дюбеля  
 CZ Set šroubů a hmoždinek  
 RO Set dibluri + holsuruburi  
 HU Csavar és tiplí készlet  
 ES Juego de tornillos y pernos de expansión



3.5 x 30 mm (35 PCS), 4 x 40 mm (35 PCS), 4.5 x 50 mm (30 PCS); 2.8 x 30 mm (35 PCS), 3.0 x 40 mm (40 PCS), 3.8 x 50 mm (35 PCS); 5 x 30 mm (30 PCS), 6 x 35 mm (30 PCS), 8 x 50 mm (20 PCS)



No.	pcs / szt.	Icon
24112	290	5/20

EN Picture hook assortment  
 PL Zestaw haków na obrazy  
 DE Bilderhaken-Set  
 RU Набор крючков для картин  
 CZ Sada háčků na obrazy  
 RO Set cârlige rame  
 HU Résztes képakasztó készlet  
 ES Juego de ganchos para cuadros

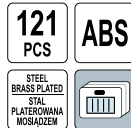

No.	pcs / szt.	Icon
24130	121	6/60

EN Caulking gun  
 PL Wyciskacz do mas  
 DE Kartuschenpistole  
 RU Пистолет для герметика  
 CZ Ruční výtlačná pistole  
 RO Pistol silicon  
 HU Extrudáló pisztoly  
 ES Pistola para masilla



No.	Tube length / Długość tuby [mm]	Icon
09100	230	20/40

EN Screw assortment  
 PL Zestaw wkrętów  
 DE Spanplattenschrauben Sortiment  
 RU Набор винтов  
 CZ Šrouby  
 RO Set holsuruburi  
 HU Csavar készlet  
 ES Juego de tornillos



4 x 20 mm (50 PCS), 5 x 30 mm (15 PCS); 3.5 x 19 mm (50 PCS), 4.2 x 25 mm (30 PCS); 1.5 x 25 mm (120 PCS), 2.0 x 40 mm (50 PCS), 3.0 x 60 mm (25 PCS); M4 x 20 mm (25 PCS), M5 x 25 (15 PCS); M4 (25 PCS), M5 (15 PCS); M4 (50 PCS), M5 (30 PCS); M4 (25 PCS), M5 (15 PCS)



No.	pcs / szt.	Icon
24122	580	6/24

EN Cable manager set  
 PL Zestaw do mocowań kabli  
 DE Kabelhalter-Set  
 RU Набор для крепления проводов  
 CZ Sada na uspořádání kabelů  
 RO Set organizare cabluri  
 HU Kábelkezelő készlet  
 ES Juego de elementos de fijación de cables

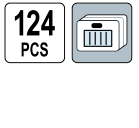

No.	pcs / szt.	Icon
24140	124	6/60

EN Caulking gun  
 PL Wyciskacz do mas  
 DE Kartuschenpistole  
 RU Пистолет для герметика  
 CZ Ruční výtlačná pistole  
 RO Pistol silicon  
 HU Extrudáló pisztoly  
 ES Pistola para masilla



No.	Tube length / Długość tuby [mm]	Icon
09130	230	10/20

EN Caulking gun  
 PL Wyciskacz do mas  
 DE Kartuschenpistole  
 RU Пистолет для герметика  
 CZ Ruční výtlačná pistole  
 RO Pistol silicon  
 HU Extrudáló pisztoly  
 ES Pistola para masilla

150 mm



No.	Tube length / Długość tuby [mm]	
09150	150	20/40

EN Caulking gun  
 PL Wyciskacz do mas  
 DE Kartuschenpistole  
 RU Пистолет для герметика

CZ Ruční výtlačná pistole  
 RO Pistol silicon  
 HU Extrudáló pisztoly  
 ES Pistola para masilla

230 mm



No.	Tube length / Długość tuby [mm]	
09160	230	6/12

EN Building and construction cement grouting gun  
 PL Aplikator do zapraw, mas szpachlowych i fugowania  
 DE Spritze für Mörtel-, Spachtel- und Fugenmaßen  
 RU Аппликатор для строительных растворов, шпатлевок и затирки  
 CZ Aplikátor malt, plniv a spojivování  
 RO Pompa injectat beton  
 HU Habarcs, spatulyázó massa és fuga kinyomó  
 ES Aplicador de mortero, masilla y para juntas

660 mm  
 10 mm  
 PP  
 ABS



No.	L [mm]	
04451	660	24

EN Caulking gun  
 PL Wyciskacz do mas  
 DE Kartuschenpistole  
 RU Пистолет для герметика

CZ Ruční výtlačná pistole  
 RO Pistol silicon  
 HU Extrudáló pisztoly  
 ES Pistola para masilla

245 mm



No.	Tube length / Długość tuby [mm]	
09120	245	24

EN Building and construction cement grouting gun  
 PL Aplikator do zapraw, mas szpachlowych i fugowania  
 DE Spritze für Mörtel-, Spachtel- und Fugenmaßen  
 RU Аппликатор для строительных растворов, шпатлевок и затирки  
 CZ Aplikátor malt, plniv a spojivování  
 RO Pompa injectat beton  
 HU Habarcs, spatulyázó massa és fuga kinyomó  
 ES Aplicador de mortero, masilla y para juntas

660 mm  
 80x20 mm  
 PP  
 ABS



No.	L [mm]	
04450	660	24

EN Building and construction cement grouting gun  
 PL Aplikator do zapraw, mas szpachlowych i fugowania  
 DE Spritze für Mörtel-, Spachtel- und Fugenmaßen  
 RU Аппликатор для строительных растворов, шпатлевок и затирки  
 CZ Aplikátor malt, plniv a spojivování  
 RO Pompa injectat beton  
 HU Habarcs, spatulyázó massa és fuga kinyomó  
 ES Aplicador de mortero, masilla y para juntas

660 mm  
 20 mm  
 PP  
 ABS



No.	L [mm]	
04452	660	24

EN Foam gun  
 PL Pistolet do pianki montażowej  
 DE Schaumpistole  
 RU Пистолет для монтажной пены  
 CZ Pistolet na montážní pěnu  
 RO Pistol pt. spumă  
 HU Szerelőhab kinyomó pisztoly  
 ES Pistola para espuma de poliuretano



**VOREL**

No.

09170



20

EN Foam gun  
 PL Pistolet do pianki montażowej  
 DE Schaumpistole  
 RU Пистолет для монтажной пены  
 CZ Pistolet na montážní pěnu  
 RO Pistol pt. spumă  
 HU Szerelőhab kinyomó pisztoly  
 ES Pistola para espuma de poliuretano



**VOREL**

No.

09172



20

EN Foam gun  
 PL Pistolet do pianki montażowej  
 DE Schaumpistole  
 RU Пистолет для монтажной пены  
 CZ Pistolet na montážní pěnu  
 RO Pistol pt. spumă  
 HU Szerelőhab kinyomó pisztoly  
 ES Pistola para espuma de poliuretano

330  
mm



**VOREL**

No.

09175



20

EN Foam gun  
 PL Pistolet do pianki montażowej  
 DE Schaumpistole  
 RU Пистолет для монтажной пены  
 CZ Pistolet na montážní pěnu  
 RO Pistol pt. spumă  
 HU Szerelőhab kinyomó pisztoly  
 ES Pistola para espuma de poliuretano

**VOREL**

No.

09173



20

EN Foam gun  
 PL Pistolet do pianki montażowej  
 DE Schaumpistole  
 RU Пистолет для монтажной пены  
 CZ Pistolet na montážní pěnu  
 RO Pistol pt. spumă  
 HU Szerelőhab kinyomó pisztoly  
 ES Pistola para espuma de poliuretano



**VOREL**

No.

09171



10/20

EN Foam gun  
 PL Pistolet do pianki montażowej  
 DE Schaumpistole  
 RU Пистолет для монтажной пены  
 CZ Pistolet na montážní pěnu  
 RO Pistol pt. spumă  
 HU Szerelőhab kinyomó pisztoly  
 ES Pistola para espuma de poliuretano



**VOREL**

No.

09174



20

EN Foam gun  
 PL Pistolet do pianki montażowej  
 DE Schaumpistole  
 RU Пистолет для монтажной пены  
 CZ Pistolet na montážní pěnu  
 RO Pistol pt. spumă  
 HU Szerelőhab kinyomó pisztoly  
 ES Pistola para espuma de poliuretano



**VOREL**

No.

09177



20



EN Foam gun  
 PL Pistolet do pianki montażowej  
 DE Schaumpistole  
 RU Пистолет для монтажной пены  
 CZ Pistole na montážní pěnu  
 RO Pistol pt. spumă  
 HU Szerelőhab kinyomó pisztoly  
 ES Pistola para espuma de poliuretano



No.	
09164	50/100

EN Spray can tool  
 PL Uchwyt pistoletowy do pojemników spray  
 DE Pistolengriff für Spraydosen  
 RU Пистолетная рукоятка для аэрозольей  
 CZ Pistolová rukojeť pro spreje  
 RO Pistol pt. spray-uri  
 HU Aeroszolos szórőpisztoly fogantyú  
 ES Empuñadura de pistola para aerosoles



No.	
09162	50/100

EN Hose clip  
 PL Opaska ślimakowa  
 DE Schlauchklemme  
 RU Хомут стальной  
 CZ Šneková páska  
 RO Colier metalic  
 HU Csigapánt  
 ES Abrazadera sin fin



No.	Ø [mm]	W [mm]	
73561	8-12	9	100
73562	10-16	9	100
73563	12-22	9	100
73565	16-27	9	100
73567	20-32	9	100
73568	25-40	9	100
73569	35-50	9	50
73570	40-60	9	50
73571	50-70	9	50
73572	60-80	9	25
73573	70-90	9	25
73574	80-100	9	25
73575	90-110	9	25

EN Foam gun  
 PL Pistolet do pianki montażowej  
 DE Schaumpistole  
 RU Пистолет для монтажной пены  
 CZ Pistole na montážní pěnu  
 RO Pistol pt. spumă  
 HU Szerelőhab kinyomó pisztoly  
 ES Pistola para espuma de poliuretano



No.	
09163	100

EN Foam gun  
 PL Pistolet do pianki montażowej  
 DE Schaumpistole  
 RU Пистолет для монтажной пены  
 CZ Pistole na montážní pěnu  
 RO Pistol pt. spumă  
 HU Szerelőhab kinyomó pisztoly  
 ES Pistola para espuma de poliuretano



No.	
09165	20

EN Hose clip set  
 PL Komplet opasek ślimakowych  
 DE Schlauchklemmensatz  
 RU Набор хомутов  
 CZ Sada šnekových pásek  
 RO Set coliere metalice  
 HU Csigapántkészlet  
 ES Juego de abrazaderas sin fin



No.	pcs / szt.	
73590	8	25

EN Hose clip set  
 PL Komplet opasek ślimakowych  
 DE Schlauchklemmensatz  
 RU Набор хомутов  
 CZ Sada šnekových pásek  
 RO Set coliere metalice  
 HU Csigapántkészlet  
 ES Juego de abrazaderas sin fin



No.	Ø [mm]	W [mm]	pcs / szt.	
73831	8-12	9	4	4/40
73833	12-22	9	4	40
73835	20-32	9	4	40



EN Hose clip set  
 PL Komplet serwisowy  
 DE Schlauchklemmensatz  
 RU Набор хомутов  
 CZ Dělnická sada  
 RO Set coliere metalice  
 HU Szervizkészlet  
 ES Juego de mantenimiento



No.	pcs / szt.	📦
73598	365	1

EN Screw clamp  
 PL Obejma śrubowa  
 DE Schraubklemme  
 RU Винтовой зажим  
 CZ Šroubová svorka  
 RO Colier metalic  
 HU Csavaros csőbilincs  
 ES Abrazadera de tornillo



No.	Ø [mm]	W [mm]	pcs / szt.	📦
73787	19-21	18	4	100
73788	21-23	18	4	75
73789	23-25	18	4	75
73790	25-27	18	4	75
73791	27-29	18	3	75
73792	29-31	20	3	75
73793	32-35	20	3	75
73794	35-38	20	2	100
73795	38-41	20	2	100
73796	40-43	20	1	100
73797	44-47	22	1	100
73798	48-51	22	1	100
73799	52-55	22	1	100
73800	56-59	22	1	100
73801	60-63	22	1	100
73802	64-67	22	1	100
73803	68-73	24	1	100
73804	74-79	24	1	100
73805	80-85	24	1	100
73806	86-91	24	1	100
73807	92-97	24	1	100
73808	98-103	24	1	100

EN Cable ties  
 PL Opaski plastikowe  
 DE Kabelbinder  
 RU Кабельные стяжки пластиковые  
 CZ Stahovací pásy plastové  
 RO Set coliere din plastic  
 HU Kábelkötégek  
 ES Bidas de plástico



No.	Size / Rozmiar [mm]	Max. tensile strength / Maks. odporność na zrywanie [kg]	Max. wire bundle diameter / Maks. średnica wiązki kabli [mm]	pcs / szt.	📦
73881	2.5x80	8	15	100	250/500
73882	2.5x100	8	20	100	250/500
73883	2.5x150	8	40	100	250/500
73884	2.5x200	8	50	100	125/250
73885	3.6x300	18	80	100	75/150

EN Screw clamp  
 PL Obejma śrubowa  
 DE Schraubklemme  
 RU Винтовой зажим  
 CZ Šroubová svorka  
 RO Colier metalic  
 HU Csavaros csőbilincs  
 ES Abrazadera de tornillo



No.	Ø [mm]	W [mm]	pcs / szt.	📦
73780	8-10	9	4	100
73781	10-12	9	4	100
73782	12-14	9	4	100
73783	14-16	9	4	100
73784	16-18	9	4	100
73785	18-20	9	4	100
73786	20-22	9	4	100

EN Cable ties  
 PL Opaski plastikowe  
 DE Kabelbinder  
 RU Кабельные стяжки пластиковые  
 CZ Stahovací pásy plastové  
 RO Set coliere din plastic  
 HU Kábelkötégek  
 ES Bidas de plástico

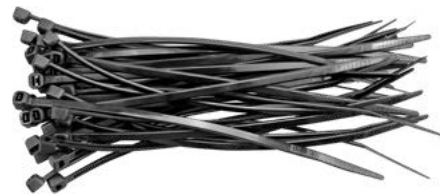

No.	Size / Rozmiar [mm]	Max. tensile strength / Maks. odporność na zrywanie [kg]	Max. wire bundle diameter / Maks. średnica wiązki kabli [mm]	pcs / szt.	📦
73892	2.5x100	8	20	100	250/500
73893	2.5x150	8	40	100	250/500
73894	2.5x200	8	50	100	125/250
73895	3.6x300	18	80	100	75/150
73929	4.8x280	22	80	100	50/100
73896	4.8x370	22	100	100	50/100
73897	4.8x430	22	120	100	35/70
73898	8.0x500	54	130	50	30/60



No.	Size / Rozmiar [mm]	Max. tensile strength / Maks. odporność na zrywanie [kg]	Max. wire bundle diameter / Maks. średnica wiązki kabli [mm]	pcs / szt.	📦
73906	4.8x200	22	50	100	75/150
73909	4.8x280	22	80	100	50/100
73886	4.8x370	22	100	100	50/100
73887	4.8x430	22	120	100	35/70
73888	8.0x500	54	130	50	30/60

EN Hook and loop cable ties  
 PL Opaska rzepowa  
 DE Klettlabelbinder  
 RU Хомут на липучке  
 CZ Opaska na suchý zip  
 RO Chinga cu bucla  
 HU Tépözárás szalag  
 ES Cinta con velcro



No.	Size / Rozmiar [mm]	pcs / szt.	
73840	150x25	10	50/100
73843	300x25	10	50/100
73845	450x25	10	50/100

EN Nylon cable tie gun  
 PL Zaciskacz do opasek kablowych  
 DE Kabelbinder Verschluss Werkzeug  
 RU Пистолет для кабельных стяжек  
 CZ Kliešte viazacie káblové  
 RO Cieste pt. strans coliere plastic  
 HU Kábelkötegelő fogó  
 ES Pistola de amarre de cables

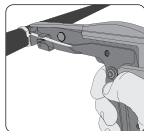

No.	
73875	10/40

EN Glue sticks  
 PL Wkłady klejowe  
 DE Heisskleberpatronen  
 RU Стержин для горячей склейки  
 CZ Lepicí vložky  
 RO Mine cu clei  
 HU Ragasztóbetét  
 ES Cartucho de cola



**APPLICATION:**  
 - Cardboard, wood, plastic, leather, fabrics  
**ZASTOSOWANIE:**  
 - Tekstura, drewno, plastik, skóra, tkaniny



No.	Ø [mm]	L [mm]	pcs / szt.	
73260	7	100	12	50/200
73270	11	100	6	20/120
73271	11	150	12	20/60

EN Packing tape dispenser  
 PL Podajnik taśmy pakowej  
 DE Verpackungsband-Abroller  
 RU Диспенсер для клейких лент  
 CZ Páskovačka  
 RO Pistol cu banda de impachetare  
 HU Csomagolászalag tépő  
 ES Alimentador de la cinta de embalaje

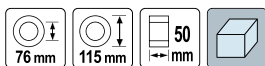

No.	W [mm]	
75295	50	12/24

EN Hook and loop cable ties  
 PL Opaska rzepowa  
 DE Klettlabelbinder  
 RU Хомут на липучке  
 CZ Opaska na suchý zip  
 RO Chinga cu bucla  
 HU Tépözárás szalag  
 ES Cinta con velcro



No.	Size / Rozmiar [mm]	pcs / szt.	
73850	150x25	10	50/100
73853	300x25	10	50/100
73855	450x25	10	50/100

EN Glue sticks  
 PL Wkłady klejowe  
 DE Heisskleberpatronen  
 RU Стержин для горячей склейки  
 CZ Lepicí vložky  
 RO Mine cu clei  
 HU Ragasztóbetét  
 ES Cartucho de cola



**APPLICATION:**  
 - Cardboard, wood, plastic, leather, fabrics  
**ZASTOSOWANIE:**  
 - Tekstura, drewno, plastik, skóra, tkaniny



No.	Ø [mm]	L [mm]	m [kg]	
73300	11	200	1	10

EN Glue applicator - bottle kit  
 PL Dozownik kleju  
 DE Applikator-Flasche für Flüssigklebstoffe  
 RU Аппликатор клея  
 CZ Aplikátor lepidla  
 RO Kit aplicator lipici  
 HU Lamellarasztó  
 ES Dispensador de pegamento



No.	
78027	50

EN Double-sided carpet tape  
 PL Taśma dwustronna do wykładzin  
 DE Doppelseitiges Klebeband für Auslegware  
 RU Двухсторонняя клейкая лента для укладки ковровых покрытий  
 CZ Obojstranná lepicí páska (na podlahové krytiny)  
 RO Bandă cu două părți adezive pt. mochetă  
 HU Kétoldalas szalag szőnyegpadlókhöz  
 ES Cinta de doble cara para revestimientos



No.	W [mm]	L [m]	
75260	50	5	48
75261	50	10	36
75262	50	25	24

EN Double-sided tape  
 PL Taśma dwustronna na folii  
 DE Doppelseitiges Band auf PP-Folie  
 RU Клейкая лента двухсторонняя на полипропиленовой основе  
 CZ Obojstranná páska na PP folii  
 RO Bandă cu două fețe pt. folii  
 HU Kétoldalas  
 ES Cinta de doble cara en film



**VOREL**

No.	W [mm]	L [m]	
75245	50	5	72
75246	50	10	72
75247	50	25	36

EN Warning tape  
 PL Taśma ostrzegawcza  
 DE Warnband, kleband  
 RU Лента сигнальная  
 CZ Lepicí páska výstražná  
 RO Bandă adezivă avertizare  
 HU Figyelmeztető ragasztó szalag  
 ES Cinta de advertencia



**VOREL**

No.	W [mm]	L [m]	
75231	48	33	24

EN Two-colour warning tape  
 PL Taśma ostrzegawcza dwukolorowa  
 DE Zweifarbiges Warnband  
 RU Лента сигнальная  
 CZ Páska výstražná dvojbarevná  
 RO Bandă de avertizare bicoloră  
 HU Kétszínű jelzőszalag  
 ES Cinta de advertencia bicolor



No.	W [mm]	L [m]	
75233	75	100	24

EN PVC Tape  
 PL Taśma PCV  
 DE PVC Band  
 RU Изолента ПВХ  
 CZ Páska PVC  
 RO Banda izolatoare PVC  
 HU PVC szalag  
 ES Cinta PVC



No.	W [mm]	Thickness / Grubość [mm]	L [m]	pcs / szt.	
75000	19	0.13	10	10	50
75050	50	0.13	10	1	25/100

EN Mounting tape  
 PL Taśma samoprzylepna dwustronna  
 DE Doppelseitiges montageband  
 RU Двухсторонняя монтажная лента  
 CZ Páska montážní dvouvrstvá  
 RO Scotch cu banda dubla  
 HU Kétoldalas ragasztószalag  
 ES Cinta adhesiva de doble cara



**VOREL**

No.	W [mm]	L [m]	
75100	19	2.25, 5	12/96

EN Warning tape  
 PL Taśma ostrzegawcza  
 DE Warnband, kleband  
 RU Лента сигнальная  
 CZ Lepicí páska výstražná  
 RO Bandă adezivă avertizare  
 HU Figyelmeztető ragasztó szalag  
 ES Cinta de advertencia



**VOREL**

No.	W [mm]	L [m]	
75230	48	33	24

EN Aluminium tape  
 PL Taśma aluminiowa  
 DE Aluminiumband  
 RU Алюминиевая клейкая лента  
 CZ Hliníková páska  
 RO Bandă aluminiu  
 HU Alumínium szalag  
 ES Cinta de aluminio



**VOREL**

No.	W [mm]	L [m]	
75140	48	10	36
75141	48	50	24

EN PVC Tape  
 PL Taśma PCV  
 DE PVC Band  
 RU Изолента ПВХ  
 CZ Páska PVC  
 RO Banda izolatoare PVC  
 HU PVC szalag  
 ES Cinta PVC



No.	W [mm]	Thickness / Grubość [mm]	L [mm]	pcs / szt.	
75060	19	0.13	3	6	10/100

EN PVC tape  
 PL Taśma PCV do użytku zewnętrznego  
 DE PVC Band  
 RU Лента ПВХ для внешних работ  
 CZ Páska PVC  
 RO Bandă PVC  
 HU Kétfoldalas PVC  
 ES Cinta de PVC para exteriores



No.	W [mm]	L [m]	
75031	48	33	50

10

EN String jute rope  
 PL Lina jutowa skręcana  
 DE Verdrillt Seil aus Jute  
 RU Канат джутовый

CZ Lano jutová kroucená  
 RO Cablu răsucit de lută  
 HU Juta sodrott kötél  
 ES Cable de yute torcido



No.	Ø [mm]	L [m]	
69572	10	10	20

EN Flax thread, twine  
 PL Nici lniane, dratwa  
 DE Leinenfaden, Pechfaden  
 RU Нить (дратва) льняная

CZ Níť lněná, dratev  
 RO Fire de in, fire  
 HU Len cérna, fonál  
 ES Hilo de lino, cabo de zapatero



No.	m [g]	
69635	100	28
69637	250	18

EN Polypropylene sennit line  
 PL Linka pleciona polipropylenowa  
 DE Geflochtenes Seil aus Polypropylen  
 RU Канат полипропиленовый плетеный

CZ Lano pletené polypropylenové  
 RO Coarda împletită din polipropilena  
 HU Polipropilén fonott kötél  
 ES Cuerda trenzada de polipropileno



No.	Ø [mm]	L [m]	
69502	4	400	1
69503	5	250	1
69504	6	250	1
69505	8	300	1
69506	10	200	1
69507	12	180	1
69508	14	110	1
69509	16	80	1
69510	18	70	1

EN Packing jute string  
 PL Sznurek pakowy, jutowy  
 DE Packschnur, aus Jute  
 RU Шнур джутовый

CZ Šňůra ucpávková jutová  
 RO Șnur de împachetat, de lută  
 HU Csomagkötöző spárga, juta  
 ES Cordel de yute para embalaje



No.	m [g]	
69630	50	112
69631	100	100

EN Needle rope  
 PL Lina igłowa  
 DE Nadelseil  
 RU Канат полипропиленовый, плетеный

CZ Lano s jádrem opletené  
 RO Cablu ac  
 HU Tűfonatos kötél  
 ES Cable acalabrotado



No.	Ø [mm]	L [m]	
69539	8	10	30
69540	8	20	20
69542	10	10	25
69543	10	20	15
69546	12	20	10



EN Elastic sennit line  
 PL Linka pleciona, elastyczna  
 DE Geflochtenes Seil, elastisch  
 RU Канат плетёный эластичный  
 CZ Lano pletené elastické  
 RO Coarda împletita, elastica  
 HU Fonott kötél, rugalmas  
 ES Cuerda trenzada elástica



**VOREL**

No.	Ø [mm]	L [m]	
69550	6	150	1
69551	8	100	1
69552	10	100	1

EN Spliced wire polypropylene string  
 PL Sznurek PP do podwiązania wełny izolacyjnej  
 DE Polypropylen Erntegar  
 RU Шнур полипропиленовый

CZ Provázek polypropylenový  
 RO Snur din polipropilena  
 HU Špagát polypropylénový  
 ES Cuerda



**VOREL**

No.	Ø [mm]	L [m]	
69608	2.5	200	100
69609	2.5	300	80
69610	2.5	450	50
69612	2.5	1000	24
69613	2.5	2000	12

Memo

# 11

## Plastering & bricklaying tools Narzędzia budowlane i malarskie



<b>Floor laminate cutters</b> Gilotyny do cięcia paneli podłogowych	
.....	146

<b>Tile cutters &amp; accessories</b> Przyrządy do cięcia glazury i akcesoria	
.....	146-155

<b>Tile cutters</b> Przyrządy do glazury	146
---	-----

<b>Tile cutting pliers</b> Szczypce do glazury	147
---	-----

<b>Grout removers &amp; finishers</b> Skrobaki i szpachelki do fug	147
---	-----

<b>Accessories for tiles</b> Akcesoria do glazury	148
--	-----

<b>Burners &amp; soldering tools</b> Palniki i lutownice	
.....	155-156

<b>Gas burners &amp; accessories</b> Palniki gazowe i akcesoria	
.....	156-158

<b>Ladders &amp; supports</b> Drabiny i podpory	
.....	158-160

<b>Masonry tools</b> Narzędzia budowlane	
.....	160-185

<b>Floats</b> Pace	160
-----------------------	-----

<b>Trowels</b> Kielnie	163
---------------------------	-----

<b>Plaster &amp; stucco spray guns</b> Tynkownice pneumatyczne	163
---	-----

<b>Tools for areated blocks</b> Narzędzia do betonu komórkowego	164
--	-----

<b>Tools for drywalls</b> Narzędzia do płyt gipsowo-kartonowych	165
--	-----

<b>Putty knives</b> Szpachelki	165
-----------------------------------	-----

<b>Scrapers</b> Skrobaki	169
-----------------------------	-----

<b>Mason's pans</b> Czerpaki murarskie	170
---	-----

<b>Building strainers</b> Sita budowlane	170
---	-----

<b>Paint mixers &amp; grout mixers</b> Mieszadła do farb i do zaprawy	170
--	-----

<b>Wallpapering tools</b> Narzędzia do tapetowania	172
---	-----

<b>Paint rollers &amp; accessories</b> Wałki do malowania i akcesoria	172
--	-----

<b>Paint brushes &amp; accessories</b> Pędzle malarskie i akcesoria	175
--	-----

<b>Painting sheets</b> Folie malarskie	177
---	-----

<b>Tapes</b> Taśmy	178
-----------------------	-----

<b>Plastic buckets &amp; tubs</b> Wiadra i kasty budowlane	179
---	-----

<b>Suction lifters</b> Uchwyty do szyb	180
---	-----

<b>Hooks „Juco”</b> Haki budowlane „Juco”	181
--	-----

<b>Pencils &amp; accessories</b> Ołówki i akcesoria	181
--	-----

<b>Benders</b> Giętarki	181
----------------------------	-----

<b>Paving tools</b> Narzędzia brukarskie	182
---	-----

EN Floor laminate cutter  
 PL Gilotyna do cięcia paneli podłogowych  
 DE Laminat-Schneider  
 RU Гильотина для ламината  
 CZ Nůžky na laminátové plošcovci podlahy  
 RO Aparat de tăiat parchet laminat  
 HU Laminált padló vágógép  
 ES Guillotina cortapaneles

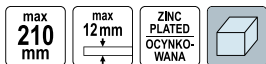

No.	Cutting length / Długość cięcia [mm]	Guide bar diameter / Średnica prowadnicy [mm]	Quantity
28880			2

EN Tile cutter  
 PL Przyrząd do cięcia glazury  
 DE Fliesenschneider  
 RU Плиткорез  
 CZ Příklad na řezání glazury  
 RO Mașină pt. tăiat faianța  
 HU Csempevágó  
 ES Cortadora de cerámica



No.	Cutting length / Długość cięcia [mm]	Guide bar diameter / Średnica prowadnicy [mm]	Quantity
00320	450	19	1

EN Tile cutter  
 PL Przyrząd do cięcia glazury  
 DE Fliesenschneider  
 RU Плиткорез  
 CZ Příklad na řezání glazury  
 RO Mașină pt. tăiat faianța  
 HU Csempevágó  
 ES Cortadora de cerámica



No.	Cutting length / Długość cięcia [mm]	Guide bar diameter / Średnica prowadnicy [mm]	Quantity
02300	280	16	6

EN Tile cutter  
 PL Przyrząd do cięcia glazury  
 DE Fliesenschneider  
 RU Плиткорез  
 CZ Příklad na řezání glazury  
 RO Mașină pt. tăiat faianța  
 HU Csempevágó  
 ES Cortadora de cerámica

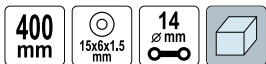

No.	Cutting length / Długość cięcia [mm]	Guide bar diameter / Średnica prowadnicy [mm]	Quantity
02400	400	14	6

EN Tile cutter  
 PL Przyrząd do cięcia glazury  
 DE Fliesenschneider  
 RU Плиткорез  
 CZ Příklad na řezání glazury  
 RO Mașină pt. tăiat faianța  
 HU Csempevágó  
 ES Cortadora de cerámica

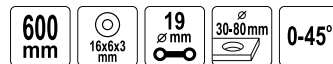

No.	Cutting length / Długość cięcia [mm]	Guide bar diameter / Średnica prowadnicy [mm]	Quantity
00300	600	19	1

EN Tile cutter  
 PL Przyrząd do cięcia glazury  
 DE Fliesenschneider  
 RU Плиткорез  
 CZ Příklad na řezání glazury  
 RO Mașină pt. tăiat faianța  
 HU Csempevágó  
 ES Cortadora de cerámica



No.	Cutting length / Długość cięcia [mm]	Guide bar diameter / Średnica prowadnicy [mm]	Quantity
00510	500	16	1
00610	590	16	1

EN Tile cutter  
 PL Przyrząd do cięcia glazury  
 DE Fliesenschneider  
 RU Плиткорез  
 CZ Příklad na řezání glazury  
 RO Mașină pt. tăiat faianța  
 HU Csempevágó  
 ES Cortadora de cerámica



No.	Cutting length / Długość cięcia [mm]	Guide bar diameter / Średnica prowadnicy [mm]	Quantity
01060	600	15	1

EN Tile cutting wheel  
 PL Kółko wymienne ze śrubą  
 DE Schneidrad mit Schraube  
 RU Запасной ролик для плиткореза

CZ Výmenné kolečko se šroubem  
 RO Cutit rola  
 HU Cseregörgő csavarral  
 ES Recambio de cuchillo redondo



No.	Dimensions / Wymiary [mm]	For / Dla	Quantity
03150	15x6x1.5	02300, 02400	50/200
03160	16x6x3	00300, 00320	50/200
03220	22x6x2	00510, 00600, 00610, 01060	50/200



EN Tile cutting wheel  
 PL Kółko tnące wymienne  
 DE Schneiderrad  
 RU Запасной ролик для плиткореза  
 CZ Výměnné kolečko  
 RO Cuițt rolă  
 HU Cserégörgő csavarral  
 ES Recambio de cuchillo redondo



No.	Dimensions / Wymiary [mm]	For / Dia	
03221	22x10.5x2	00703	50/200

EN Tile cutting pliers  
 PL Szczypce do glazury  
 DE Glasurzange  
 RU Кусачки для плитки

CZ Kleště do glazury  
 RO Clește rupt faianța  
 HU Csempefogó  
 ES Tenazas para azulejos



No.	L [mm]	
04000	200	10/60

EN Tile cutting pliers  
 PL Szczypce do łamania glazury  
 DE Glasurzange  
 RU Кусачки для плитки  
 CZ Kleště do glazury  
 RO Clește rupt faianța  
 HU Csempefogó  
 ES Tenazas para azulejos



No.	L [mm]	
04022	200	6/60

EN Tile cutting nipper  
 PL Oboęci do glazury wygięte  
 DE Glasurzange  
 RU Клещи для плитки твердосплавные  
 CZ Kleště do glazury ohnuté  
 RO Clește curbate pt. glazură  
 HU Hajlított csempe harapófogó  
 ES Tenazas para azulejos curvo



No.	L [mm]	
04210	200	12/60

EN Tile cutting wheel  
 PL Kółko tnące wymienne  
 DE Schneiderrad  
 RU Ролик для плиткореза  
 CZ Výměnné kolečko  
 RO Cuițt rolă  
 HU Cserégörgő csavarral  
 ES Recambio de cuchillo redondo



No.	Dimensions / Wymiary [mm]	
03225	22x6x6	500

EN Tile cutting pliers  
 PL Szczypce do cięcia glazury  
 DE Glasurzange  
 RU Кусачки для плитки  
 CZ Kleště do glazury  
 RO Clește rupt faianța  
 HU Csempefogó  
 ES Tenazas para azulejos



No.	L [mm]	
04020	200	6/36

EN Tile cutting nipper  
 PL Szczypce do glazury  
 DE Glasurzange  
 RU Кусачки для плитки  
 CZ Kleště do glazury  
 RO Clește rupt faianța  
 HU Csempefogó  
 ES Tenazas para azulejos



No.	L [mm]	
04200	200	12/60

EN Grout finisher  
 PL Szpachelka do fugi  
 DE Fugenreiniger  
 RU Шпатель для затирки межплиточных швов  
 CZ Šuves skrěpers  
 RO Răzuitoare pt. rosturi  
 HU Fugakinűző  
 ES Rascador para juntas



No.	
04410	450

- EN Grout bag  
 PL Worek do aplikacji fugi  
 DE Fugenfüller-beutel  
 RU Мешок для нанесения расшивки
- CZ Rukáv do spárování  
 RO Punga umplere rosturi  
 HU Fugázó zsák  
 ES Saco para la aplicación de juntas



No.		
04440		36/108

- EN Tile laser  
 PL Laser glazurnicy  
 DE Fliesenlaser  
 RU Лазерный уровень для плитин  
 CZ Laserová vodováha  
 RO Nivel laser pt. plăci  
 HU Csempélézer  
 ES Láser de baldosas

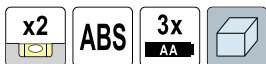

No.	Vials / Libelle	
16030	2	20

- EN Circular tile cutter  
 PL Wycinarka do otworów w glazurze  
 DE Fliesenlocher mit Handschutz  
 RU Резак по плитке „Балеринка” с защитной решеткой  
 CZ Výseč otvorů v glazuře  
 RO Cuit rotativ taiat faianta  
 HU Lyukkivágó csempéhez  
 ES Ruleta de corte para azulejos



No.	Cutting diameter / Średnica cięcia [mm]	
03940	20-94	24

- EN Tile drilling guide  
 PL Prowadnica do wiercenia w płytkach  
 DE Führungsschiene zum Bohren in Fliesen  
 RU Направляющая для сверления плитки  
 CZ Vodičko pro vrtání v dlaždicích  
 RO Ghidaj pt. gaurit gresie  
 HU Csempé fúró vezető  
 ES Guía de brocas para baldosas



No.	Cutting diameter / Średnica cięcia [mm]	
03963	4, 5, 6, 8, 10, 12	12/36

- EN Grout remover  
 PL Skrobak do fug  
 DE Fugenreiniger  
 RU Скребок для швов плитки  
 CZ Škrábák na spáry  
 RO Spaclu pt. rosturi  
 HU Fugakihúzó  
 ES Rascador para juntas



No.	Blade size / Rozmiar ostrza [mm]	
04405	50x2	12/60

- EN Circular tile cutter  
 PL Wycinarka do otworów w glazurze  
 DE Fliesenbohrzeug  
 RU Резак по плитке  
 CZ Výseč otvorů v glazuře  
 RO Cuit rotativ taiat faianta  
 HU Lyukkivágó csempéhez  
 ES Ruleta de corte para azulejos

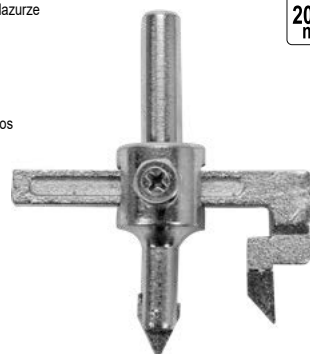

No.	Cutting diameter / Średnica cięcia [mm]	
03900	20-90	20/80

- EN Adjustable plastic drill guide  
 PL Prowadnica do wiercenia w płytkach ceramicznych  
 DE Führungsschiene zum Bohren in Keramikfliesen  
 RU Направляющая для сверления керамической плитки  
 CZ Vodičko pro vrtání keramických obkladaček  
 RO Ghidaj gaurire ajustabil  
 HU Fúrószár vezető kerámia-csempéhez  
 ES Guía para taladrar en azulejos cerámicos



No.	Cutting diameter / Średnica cięcia [mm]	
03960	4-24, 25-84	40

- EN Hand tile cutter and breaker  
 PL Rysik do cięcia glazury  
 DE Fliesengriffel  
 RU Резак для плитки  
 CZ Rýsovací jehla na řezání glazury  
 RO Cuit taiat / rupt faianta  
 HU Karctű csempévágáshoz  
 ES Cortador de azulejos



No.	L [mm]	
04050	130	50/400

EN TC tile cutter and breaker  
 PL Rysik do cięcia i lamania glazury  
 DE Fliesengriffel und Brecher  
 RU Плиткорез-карандаш с отламывателем

CZ Rýsovací jehla na řezání a lámání glazury  
 RO Cutit taiat / rupt faianta  
 HU Karctű csempevágáshoz és töréshez  
 ES Cortador y rompedor de azulejos



No.	L [mm]	
04100	200	5/100

EN Tile leveling set  
 PL Przyrząd do poziomowania płytek  
 DE Schlagschnurgerät  
 RU Уровень для укладки кафеля  
 CZ Přístroj pro regulaci úrovně dlaždiček  
 RO Fir pt. trasat  
 HU Padlólapszintező eszköz  
 ES Nivelador de cuerda para azulejos

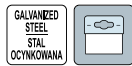

No.		
04500		60

EN Tile magnetic fittings  
 PL Uchwyty magnetyczne do płytek  
 DE Fliesen Magnete  
 RU Магнитные фитинги для плитки

CZ Magnety pod obklady  
 RO Balamale magnetice pt. imbinarea placilor  
 HU Csempevágnés  
 ES Trampilla magnética para la escotilla de inspección

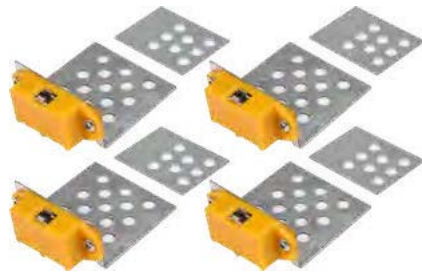

No.	pcs / szt.	
04490	4	50/100

EN Grouting sponge  
 PL Gąbka glazurnicza  
 DE Fliesenschwamm  
 RU Губка для затирки  
 CZ Houba na spárování obkladů  
 RO Burete pt. plăci ceramice  
 HU Csempéző szivacs  
 ES Esponja para azulejos



No.	Dimensions / Wymiary [mm]	
04540	165x100x60	74

EN Glass cutting tool  
 PL Nóż do płytek ceramicznych i szkła  
 DE Fliesen- und Glasschneider  
 RU Резак для керамической плитки и стекла  
 CZ Nůž na řezání keramických dlaždic a skla  
 RO Instrument de tăiat sticlă  
 HU Csempe- és üvegvágó kés  
 ES Cuchillo para cortar baldosas cerámicas y vidrio



No.	L [mm]	
04060	120	6/240

EN Magnetic lock  
 PL Maskownica uniwersalna  
 DE Universal verdeckung mit Magnet  
 RU Замок магнитный для кафеля  
 CZ Maskovací rám univerzální do glazury  
 RO Opritor magnetic  
 HU Univerzális maszkoló csempéhez  
 ES Cierre magnético universal



No.		
04510		40

EN Tile suction cup  
 PL Przyssawka do glazury  
 DE Saugnapf für Fliesen  
 RU Присоска для плитки  
 CZ Přisavka na obklady  
 RO Ventuze pt. plăci ceramice  
 HU Lapemelő tapadókörong  
 ES Ventosa para azulejos



No.	Ø [mm]	Max. lifting capacity / Maks. udźwig [kg]	
05290	80	20	200

EN Grouting sponge  
 PL Gąbka glazurnicza  
 DE Fliesenschwamm  
 RU Губка для затирки  
 CZ Houba na spárování obkladů  
 RO Burete pt. plăci ceramice  
 HU Csempéző szivacs  
 ES Esponja para azulejos



No.	Dimensions / Wymiary [mm]	
04542	170x110x60	56

- EN Grouting sponge
- PL Gąbka glazuryczna
- DE Fliesenschwamm
- RU Губка для затирки
- CZ Houba na spráování obkladů
- RO Burete pt. plăci ceramice
- HU Csempézó szivacs
- ES Esponja para azulejos

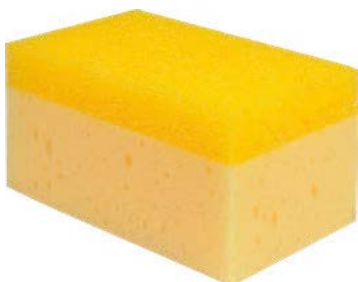

No.	Dimensions / Wymiary [mm]	
04544	165x100x80	18

- EN Glaze bucket
- PL Wiadro glazuryczna
- DE Fliesenwaschset Rolleneimer
- RU Ведро с роликом для затирки швов
- CZ Malířské vědro
- RO Galeata pt. zugravit
- HU Fugázó vödör
- ES Cubo de pintura



No.	Capacity / Pojemność [l]	
00250	10	2

- EN Tile leveling system (clips)
- PL System poziomowania płytek (klipsy)
- DE Fliesen Nivelliersystem (Clips)
- RU Система выравнивания плитки (зажимы)
- CZ Systém vyrovnávání dlaždic (spony)
- RO Sistem nivelare plăci (cleme)
- HU Csempeszintező rendszer (talpak)
- ES Sistema de nivelación de baldosas (clips)

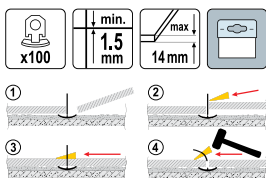

**FEATURES:**

- Useful when laying tiles on floors and walls
- Work great for large tiles
- Use with tiles of different thickness
- For use with 04718 wedges
- Save time and make work easy and efficient

**CECHY:**

- Ułatwia układanie płytek na ścianach i podłodze
- Szczególnie przydatny do płytek o większych rozmiarach
- Umożliwia poziomowanie płytek o różnych grubościach
- Do użytku z klinami 04718
- Ułatwia i przyspiesza prace



No.	pcs / szt.	
04690	100	15

30x30	33x33	40x40	45x45	50x50	60x60	80x80	60x30	100x50	120x60
42	36	20	28	24	10	10	22	16	10

NUMBER OF CLIPS FOR VARIOUS DIMENSIONS TILES PER 1 M<sup>3</sup>  
LICZBA KLIPSÓW NA M<sup>3</sup> W ZALEŻNOŚCI OD ROZMIARU PŁYTKI

- EN Grouting sponge
- PL Gąbka glazuryczna
- DE Fliesenschwamm
- RU Губка для затирки
- CZ Houba na spráování obkladů
- RO Burete pt. plăci ceramice
- HU Csempézó szivacs
- ES Esponja para azulejos



No.	Dimensions / Wymiary [mm]	
04546	150x100x50	10

- EN Tile leveling floor pliers
- PL Szczypce do poziomowania płytek
- DE Nivelliersystem Zange
- RU Щипцы до системы нивелировки
- CZ Kleště pro dlaždice vyrovnání
- RO Ceste de nivelat gresie reglabil
- HU Lapszintező speciális fogó
- ES Tenaza para sistema de nivelación



No.		
04699		5/30

- EN Tile leveling system (clips and wedges)
- PL System poziomowania płytek (klipsy i kliny)
- DE Fliesen Nivelliersystem (Clips und Keile)
- RU Система выравнивания плитки (зажимы и клинья)
- CZ Systém vyrovnávání dlaždic (spony a kliny)
- RO Sistem nivelare plăci (cleme si pene)
- HU Csempeszintező rendszer (talpak és ékek)
- ES Sistema de nivelación de baldosas (clips y cuñas)

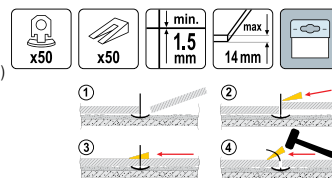

**FEATURES:**

- Useful when laying tiles on floors and walls
- Work great for large tiles
- Use with tiles of different thickness
- Wedges are reusable
- Save time and make work easy and efficient

**CECHY:**

- Ułatwia układanie płytek na ścianach i podłodze
- Szczególnie przydatny do płytek o większych rozmiarach
- Umożliwia poziomowanie płytek o różnych grubościach
- Kliny wielokrotnego użytku
- Ułatwia i przyspiesza prace



No.	pcs / szt.	
04691	50+50	15

30x30	33x33	40x40	45x45	50x50	60x60	80x80	60x30	100x50	120x60
42	36	20	28	24	10	10	22	16	10

NUMBER OF CLIPS FOR VARIOUS DIMENSIONS TILES PER 1 M<sup>3</sup>  
LICZBA KLIPSÓW NA M<sup>3</sup> W ZALEŻNOŚCI OD ROZMIARU PŁYTKI



EN Tile leveling system (clips and wedges)  
 PL System poziomowania płytek (klipsy i kliny)  
 DE Fliesen Nivelliersystem (Clips und Keile)  
 RU Система выравнивания плитки (зажимы и клинья)  
 CZ Systém vyrovnávání dlaždic (spony a kliny)  
 RO Sistem nivelare plăci (cleme și pene)  
 HU Csempezsintező rendszer (talpak és ékek)  
 ES Sistema de nivelación de baldosas (clips y cuñas)

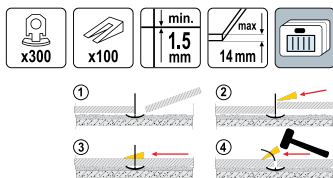

**FEATURES:**

- Useful when layed tiles on floors and walls
- Work great for large tiles
- Use with tiles of different thickness
- Wedges are reusable
- Save time and make work easy and efficient

**CECHY:**

- Ułatwia układanie płytek na ścianach i podłodze
- Szczególnie przydatny do płytek o większych rozmiarach
- Umożliwia poziomowanie płytek o różnych grubościach
- Kliny wielokrotnego użytku
- Ułatwia i przyspiesza prace



30x30	33x33	40x40	45x45	50x50	60x60	80x80	60x30	100x50	120x60
42	36	20	28	24	10	10	22	16	10

NUMBER OF CLIPS FOR VARIOUS DIMENSIONS TILES PER 1 M<sup>3</sup>  
 LICZBA KLIPSÓW NA M<sup>3</sup> W ZALEŻNOŚCI OD ROZMIARU PŁYTKI



No.	pcs / szt.	
04692	300+100	1

EN Tile leveling system (clips and wedges)  
 PL System poziomowania płytek (klipsy i kliny)  
 DE Fliesen Nivelliersystem (Clips und Keile)  
 RU Система выравнивания плитки (зажимы и клинья)  
 CZ Systém vyrovnávání dlaždic (spony a kliny)  
 RO Sistem nivelare plăci (cleme și pene)  
 HU Csempezsintező rendszer (talpak és ékek)  
 ES Sistema de nivelación de baldosas (clips y cuñas)

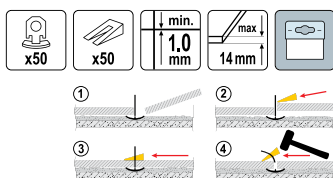

**FEATURES:**

- Useful when layed tiles on floors and walls
- Work great for large tiles
- Use with tiles of different thickness
- Wedges are reusable
- Save time and make work easy and efficient

**CECHY:**

- Ułatwia układanie płytek na ścianach i podłodze
- Szczególnie przydatny do płytek o większych rozmiarach
- Umożliwia poziomowanie płytek o różnych grubościach
- Kliny wielokrotnego użytku
- Ułatwia i przyspiesza prace



30x30	33x33	40x40	45x45	50x50	60x60	80x80	60x30	100x50	120x60
42	36	20	28	24	10	10	22	16	10

NUMBER OF CLIPS FOR VARIOUS DIMENSIONS TILES PER 1 M<sup>3</sup>  
 LICZBA KLIPSÓW NA M<sup>3</sup> W ZALEŻNOŚCI OD ROZMIARU PŁYTKI



No.	pcs / szt.	
04714	50+50	15

EN Tile leveling system (clips)  
 PL System poziomowania płytek (klipsy)  
 DE Fliesen Nivelliersystem (Clips)  
 RU Система выравнивания плитки (зажимы)  
 CZ Systém vyrovnávání dlaždic (spony)  
 RO Sistem nivelare plăci (cleme)  
 HU Csempezsintező rendszer (talpak)  
 ES Sistema de nivelación de baldosas (clips)

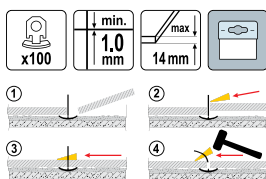

**FEATURES:**

- Useful when layed tiles on floors and walls
- Work great for large tiles
- Use with tiles of different thickness
- For use with 04718 wedges
- Save time and make work easy and efficient

**CECHY:**

- Ułatwia układanie płytek na ścianach i podłodze
- Szczególnie przydatny do płytek o większych rozmiarach
- Umożliwia poziomowanie płytek o różnych grubościach
- Do użytku z klinami 04718
- Ułatwia i przyspiesza prace



30x30	33x33	40x40	45x45	50x50	60x60	80x80	60x30	100x50	120x60
42	36	20	28	24	10	10	22	16	10

NUMBER OF CLIPS FOR VARIOUS DIMENSIONS TILES PER 1 M<sup>3</sup>  
 LICZBA KLIPSÓW NA M<sup>3</sup> W ZALEŻNOŚCI OD ROZMIARU PŁYTKI



No.	pcs / szt.	
04716	100	15

EN Tile leveling system (clips)  
 PL System poziomowania płytek (klipsy)  
 DE Fliesen Nivelliersystem (Clips)  
 RU Система выравнивания плитки (зажимы)  
 CZ Systém vyrovnávání dlaždic (spony)  
 RO Sistem nivelare plăci (cleme)  
 HU Csempezsintező rendszer (talpak)  
 ES Sistema de nivelación de baldosas (clips)

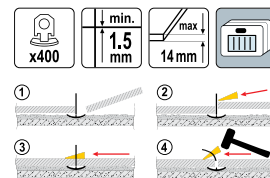

**FEATURES:**

- Useful when layed tiles on floors and walls
- Work great for large tiles
- Use with tiles of different thickness
- For use with 04718 wedges
- Save time and make work easy and efficient

**CECHY:**

- Ułatwia układanie płytek na ścianach i podłodze
- Szczególnie przydatny do płytek o większych rozmiarach
- Umożliwia poziomowanie płytek o różnych grubościach
- Do użytku z klinami 04718
- Ułatwia i przyspiesza prace



30x30	33x33	40x40	45x45	50x50	60x60	80x80	60x30	100x50	120x60
42	36	20	28	24	10	10	22	16	10

NUMBER OF CLIPS FOR VARIOUS DIMENSIONS TILES PER 1 M<sup>3</sup>  
 LICZBA KLIPSÓW NA M<sup>3</sup> W ZALEŻNOŚCI OD ROZMIARU PŁYTKI



No.	pcs / szt.	
04693	400	1

EN Tile leveling system (clips and wedges)  
 PL System poziomowania płytek (klipsy i kliny)  
 DE Fliesen Nivelliersystem (Clips und Keile)  
 RU Система выравнивания плитки (зажимы и клинья)  
 CZ Systém vyrovnávání dlaždic (spony a kliny)  
 RO Sistem nivelare plăci (cleme și pene)  
 HU Csempezsintező rendszer (talpak és ékek)  
 ES Sistema de nivelación de baldosas (clips y cuñas)

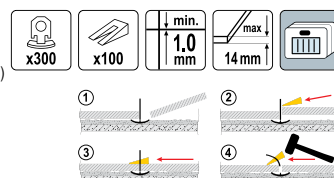

**FEATURES:**

- Useful when layed tiles on floors and walls
- Work great for large tiles
- Use with tiles of different thickness
- Wedges are reusable
- Save time and make work easy and efficient

**CECHY:**

- Ułatwia układanie płytek na ścianach i podłodze
- Szczególnie przydatny do płytek o większych rozmiarach
- Umożliwia poziomowanie płytek o różnych grubościach
- Kliny wielokrotnego użytku
- Ułatwia i przyspiesza prace



30x30	33x33	40x40	45x45	50x50	60x60	80x80	60x30	100x50	120x60
42	36	20	28	24	10	10	22	16	10

NUMBER OF CLIPS FOR VARIOUS DIMENSIONS TILES PER 1 M<sup>3</sup>  
 LICZBA KLIPSÓW NA M<sup>3</sup> W ZALEŻNOŚCI OD ROZMIARU PŁYTKI



No.	pcs / szt.	
04715	300+100	1

EN Tile leveling system (clips)  
 PL System poziomowania płytek (klipsy)  
 DE Fliesen Nivelliersystem (Clips)  
 RU Система выравнивания плитки (зажимы)  
 CZ Systém vyrovnávání dlaždic (spony)  
 RO Sistem nivelare plăci (cleme)  
 HU Csempezsintező rendszer (talpak)  
 ES Sistema de nivelación de baldosas (clips)

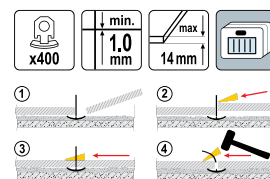

**FEATURES:**

- Useful when layed tiles on floors and walls
- Work great for large tiles
- Use with tiles of different thickness
- For use with 04718 wedges
- Save time and make work easy and efficient

**CECHY:**

- Ułatwia układanie płytek na ścianach i podłodze
- Szczególnie przydatny do płytek o większych rozmiarach
- Umożliwia poziomowanie płytek o różnych grubościach
- Do użytku z klinami 04718
- Ułatwia i przyspiesza prace



30x30	33x33	40x40	45x45	50x50	60x60	80x80	60x30	100x50	120x60
42	36	20	28	24	10	10	22	16	10

NUMBER OF CLIPS FOR VARIOUS DIMENSIONS TILES PER 1 M<sup>3</sup>  
 LICZBA KLIPSÓW NA M<sup>3</sup> W ZALEŻNOŚCI OD ROZMIARU PŁYTKI



No.	pcs / szt.	
04717	400	1

EN Tile leveling system (wedges)  
 PL System poziomowania płytek (kliny)  
 DE Fliesen Nivelliersystem (Keile)  
 RU Система выравнивания плитки (клинья)  
 CZ Systém vyrovnání dlaždic (kliny)  
 RO Sistem nivelare plăci (pene)  
 HU Csempezintéző rendszer (ékek)  
 ES Sistema de nivelación de baldosas (cuñas)

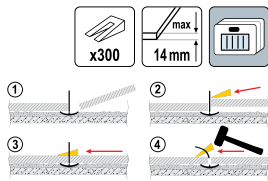

**FEATURES:**

- Useful when layed tiles on floors and walls
- Work great for large tiles
- Use with tiles of different thickness
- Wedges are reusable
- Save time and make work easy and efficient

**CECHY:**

- Ułatwia układanie płytek na ścianach i podłodze
- Szczególnie przydatny do płytek o większych rozmiarach
- Umożliwia poziomowanie płytek o różnych grubościach
- Kliny wielokrotnego użytku
- Ułatwia i przyspiesza prace



30x30	33x33	40x40	45x45	50x50	60x60	80x80	60x30	100x50	120x60
42	36	20	28	24	10	10	22	16	10

NUMBER OF CLIPS FOR VARIOUS DIMENSIONS TILES PER 1 M<sup>3</sup>  
 LICZBA KLIPSÓW NA M<sup>3</sup> W ZALEŻNOŚCI OD ROZMIARU PŁYTKI

No.	pcs / szt.	For / Dla	
04718	300	04690, 04693, 04716, 04717	1

11

EN Tile leveling system (clips and wedges)  
 PL System poziomowania płytek (klipsy i kliny)  
 DE Fliesen Nivelliersystem (Clips und Keile)  
 RU Система выравнивания плитки (зажимы и клинья)  
 CZ Systém vyrovnání dlaždic (spony a kliny)  
 RO Sistem nivelare plăci (cleme și pene)  
 HU Csempezintéző rendszer (talpak és ékek)  
 ES Sistema de nivelación de baldosas (clips y cuñas)

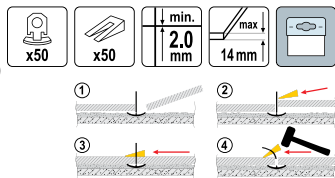

**FEATURES:**

- Useful when layed tiles on floors and walls
- Work great for large tiles
- Use with tiles of different thickness
- Wedges are reusable
- Save time and make work easy and efficient

**CECHY:**

- Ułatwia układanie płytek na ścianach i podłodze
- Szczególnie przydatny do płytek o większych rozmiarach
- Umożliwia poziomowanie płytek o różnych grubościach
- Kliny wielokrotnego użytku
- Ułatwia i przyspiesza prace



30x30	33x33	40x40	45x45	50x50	60x60	80x80	60x30	100x50	120x60
42	36	20	28	24	10	10	22	16	10

NUMBER OF CLIPS FOR VARIOUS DIMENSIONS TILES PER 1 M<sup>3</sup>  
 LICZBA KLIPSÓW NA M<sup>3</sup> W ZALEŻNOŚCI OD ROZMIARU PŁYTKI

No.	pcs / szt.	
04731	50+50	15

EN Tile leveling system (clips)  
 PL System poziomowania płytek (klipsy)  
 DE Fliesen Nivelliersystem (Clips)  
 RU Система выравнивания плитки (зажимы)  
 CZ Systém vyrovnání dlaždic (spony)  
 RO Sistem nivelare plăci (cleme)  
 HU Csempezintéző rendszer (talpak)  
 ES Sistema de nivelación de baldosas (clips)

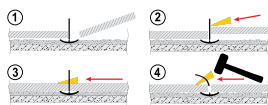

No.	pcs / szt.	
04734	400	1



30x30	33x33	40x40	45x45	50x50	60x60	80x80	60x30	100x50	120x60
42	36	20	28	24	10	10	22	16	10

NUMBER OF CLIPS FOR VARIOUS DIMENSIONS TILES PER 1 M<sup>3</sup>  
 LICZBA KLIPSÓW NA M<sup>3</sup> W ZALEŻNOŚCI OD ROZMIARU PŁYTKI

EN Tile leveling system (clips)  
 PL System poziomowania płytek (klipsy)  
 DE Fliesen Nivelliersystem (Clips)  
 RU Система выравнивания плитки (зажимы)  
 CZ Systém vyrovnání dlaždic (spony)  
 RO Sistem nivelare plăci (cleme)  
 HU Csempezintéző rendszer (talpak)  
 ES Sistema de nivelación de baldosas (clips)

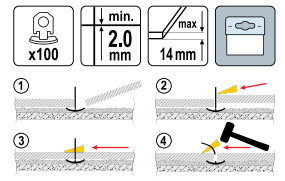

**FEATURES:**

- Useful when layed tiles on floors and walls
- Work great for large tiles
- Use with tiles of different thickness
- For use with 04718 wedges
- Save time and make work easy and efficient

**CECHY:**

- Ułatwia układanie płytek na ścianach i podłodze
- Szczególnie przydatny do płytek o większych rozmiarach
- Umożliwia poziomowanie płytek o różnych grubościach
- Do użytku z klinami 04718
- Ułatwia i przyspiesza prace



30x30	33x33	40x40	45x45	50x50	60x60	80x80	60x30	100x50	120x60
42	36	20	28	24	10	10	22	16	10

NUMBER OF CLIPS FOR VARIOUS DIMENSIONS TILES PER 1 M<sup>3</sup>  
 LICZBA KLIPSÓW NA M<sup>3</sup> W ZALEŻNOŚCI OD ROZMIARU PŁYTKI

No.	pcs / szt.	
04730	100	15

EN Tile leveling system (clips and wedges)  
 PL System poziomowania płytek (klipsy i kliny)  
 DE Fliesen Nivelliersystem (Clips und Keile)  
 RU Система выравнивания плитки (зажимы и клинья)  
 CZ Systém vyrovnání dlaždic (spony a kliny)  
 RO Sistem nivelare plăci (cleme și pene)  
 HU Csempezintéző rendszer (talpak és ékek)  
 ES Sistema de nivelación de baldosas (clips y cuñas)

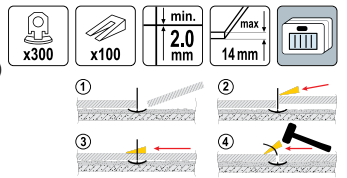

**FEATURES:**

- Useful when layed tiles on floors and walls
- Work great for large tiles
- Use with tiles of different thickness
- Wedges are reusable
- Save time and make work easy and efficient

**CECHY:**

- Ułatwia układanie płytek na ścianach i podłodze
- Szczególnie przydatny do płytek o większych rozmiarach
- Umożliwia poziomowanie płytek o różnych grubościach
- Kliny wielokrotnego użytku
- Ułatwia i przyspiesza prace



30x30	33x33	40x40	45x45	50x50	60x60	80x80	60x30	100x50	120x60
42	36	20	28	24	10	10	22	16	10

NUMBER OF CLIPS FOR VARIOUS DIMENSIONS TILES PER 1 M<sup>3</sup>  
 LICZBA KLIPSÓW NA M<sup>3</sup> W ZALEŻNOŚCI OD ROZMIARU PŁYTKI

No.	pcs / szt.	
04732	300+100	1



**FEATURES:**

- Useful when layed tiles on floors and walls
- Work great for large tiles
- Use with tiles of different thickness
- For use with 04718 wedges
- Save time and make work easy and efficient

**CECHY:**

- Ułatwia układanie płytek na ścianach i podłodze
- Szczególnie przydatny do płytek o większych rozmiarach
- Umożliwia poziomowanie płytek o różnych grubościach
- Do użytku z klinami 04718
- Ułatwia i przyspiesza prace

EN Tile leveling system (clips)  
 PL System poziomowania płytek (klipsy)  
 DE Fliesen Nivelliersystem (Clips)  
 RU Система выравнивания плитки (зажимы)  
 CZ Systém vyrovnávání dlaždic (spony)  
 RO Sistem nivelare plăci (cleme)  
 HU Csempezintező rendszer (talpak)  
 ES Sistema de nivelación de baldosas (clips)

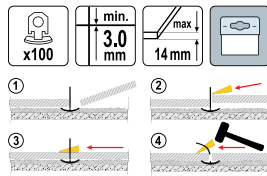

- FEATURES:**
- Useful when laying tiles on floors and walls
  - Work great for large tiles
  - Use with tiles of different thickness
  - For use with 04718 wedges
  - Save time and make work easy and efficient

- CECHY:**
- Ułatwia układanie płytek na ścianach i podłodze
  - Szczególnie przydatny do płytek o większych rozmiarach
  - Umożliwia poziomowanie płytek o różnych grubościach
  - Do użytku z klinami 04718
  - Ułatwia i przyspiesza pracę



30x30	33x33	40x40	45x45	50x50	60x60	80x80	60x30	100x50	120x60
42	36	20	28	24	10	10	22	16	10

NUMBER OF CLIPS FOR VARIOUS DIMENSIONS TILES PER 1 M<sup>2</sup>  
 LICZBA KLIPSÓW NA M<sup>2</sup> W ZALEŻNOŚCI OD ROZMIARU PŁYTKI

<b>No.</b>	pcs / szt.	
<b>04735</b>	100	15

EN Tile leveling system (clips and wedges)  
 PL System poziomowania płytek (klipsy i kliny)  
 DE Fliesen Nivelliersystem (Clips und Kelle)  
 RU Система выравнивания плитки (зажимы и клинья)  
 CZ Systém vyrovnávání dlaždic (spony a klíny)  
 RO Sistem nivelare plăci (cleme și pene)  
 HU Csempezintező rendszer (talpak és ékek)  
 ES Sistema de nivelación de baldosas (clips y cuñas)

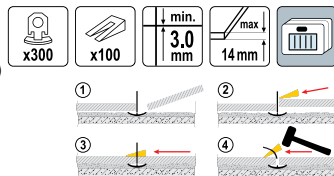

- FEATURES:**
- Useful when laying tiles on floors and walls
  - Work great for large tiles
  - Use with tiles of different thickness
  - Wedges are reusable
  - Save time and make work easy and efficient

- CECHY:**
- Ułatwia układanie płytek na ścianach i podłodze
  - Szczególnie przydatny do płytek o większych rozmiarach
  - Umożliwia poziomowanie płytek o różnych grubościach
  - Klíny wielokrotnego użytku
  - Ułatwia i przyspiesza pracę



30x30	33x33	40x40	45x45	50x50	60x60	80x80	60x30	100x50	120x60
42	36	20	28	24	10	10	22	16	10

NUMBER OF CLIPS FOR VARIOUS DIMENSIONS TILES PER 1 M<sup>2</sup>  
 LICZBA KLIPSÓW NA M<sup>2</sup> W ZALEŻNOŚCI OD ROZMIARU PŁYTKI

<b>No.</b>	pcs / szt.	
<b>04737</b>	300+100	1

EN Tile leveling system  
 PL Klipsy poziomujące płytki  
 DE Fliesen-Ausgleichssystem  
 RU Система выравнивания плитки-зажим СВП  
 CZ Dlaždice nivelační systém  
 RO Sistemul de nivelare plăci  
 HU Csempe szintező rendszer  
 ES Sistema de nivelación de azulejos



- FEATURES:**
- Useful when laying tiles on floors and walls
  - Work great for large tiles
  - Use with tiles of different thickness
  - Save time and make work easy and efficient

- CECHY:**
- Ułatwiają układanie płytek na ścianach i podłodze
  - Szczególnie przydatne do płytek o większych rozmiarach
  - Umożliwiają poziomowanie płytek o różnych grubościach
  - Ułatwiają i przyspieszają pracę

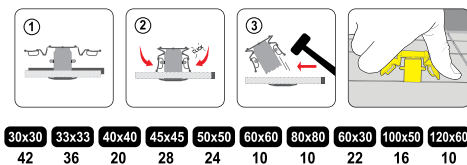

30x30	33x33	40x40	45x45	50x50	60x60	80x80	60x30	100x50	120x60
42	36	20	28	24	10	10	22	16	10

NUMBER OF CLIPS FOR VARIOUS DIMENSIONS TILES PER 1 M<sup>2</sup>  
 LICZBA KLIPSÓW NA M<sup>2</sup> W ZALEŻNOŚCI OD ROZMIARU PŁYTKI

<b>No.</b>	pcs / szt.	
<b>04677</b>	100	1

EN Tile leveling system (clips and wedges)  
 PL System poziomowania płytek (klipsy i kliny)  
 DE Fliesen Nivelliersystem (Clips und Kelle)  
 RU Система выравнивания плитки (зажимы и клинья)  
 CZ Systém vyrovnávání dlaždic (spony a klíny)  
 RO Sistem nivelare plăci (cleme și pene)  
 HU Csempezintező rendszer (talpak és ékek)  
 ES Sistema de nivelación de baldosas (clips y cuñas)

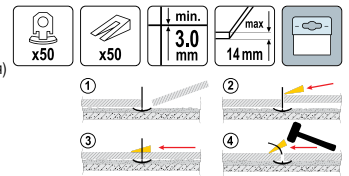

- FEATURES:**
- Useful when laying tiles on floors and walls
  - Work great for large tiles
  - Use with tiles of different thickness
  - Wedges are reusable
  - Save time and make work easy and efficient

- CECHY:**
- Ułatwia układanie płytek na ścianach i podłodze
  - Szczególnie przydatny do płytek o większych rozmiarach
  - Umożliwia poziomowanie płytek o różnych grubościach
  - Klíny wielokrotnego użytku
  - Ułatwia i przyspiesza pracę



30x30	33x33	40x40	45x45	50x50	60x60	80x80	60x30	100x50	120x60
42	36	20	28	24	10	10	22	16	10

NUMBER OF CLIPS FOR VARIOUS DIMENSIONS TILES PER 1 M<sup>2</sup>  
 LICZBA KLIPSÓW NA M<sup>2</sup> W ZALEŻNOŚCI OD ROZMIARU PŁYTKI

<b>No.</b>	pcs / szt.	
<b>04736</b>	50+50	15

EN Tile leveling system (clips)  
 PL System poziomowania płytek (klipsy)  
 DE Fliesen Nivelliersystem (Clips)  
 RU Система выравнивания плитки (зажимы)  
 CZ Systém vyrovnávání dlaždic (spony)  
 RO Sistem nivelare plăci (cleme)  
 HU Csempezintező rendszer (talpak)  
 ES Sistema de nivelación de baldosas (clips)

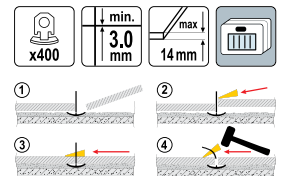

- FEATURES:**
- Useful when laying tiles on floors and walls
  - Work great for large tiles
  - Use with tiles of different thickness
  - For use with 04718 wedges
  - Save time and make work easy and efficient

- CECHY:**
- Ułatwia układanie płytek na ścianach i podłodze
  - Szczególnie przydatny do płytek o większych rozmiarach
  - Umożliwia poziomowanie płytek o różnych grubościach
  - Do użytku z klinami 04718
  - Ułatwia i przyspiesza pracę



30x30	33x33	40x40	45x45	50x50	60x60	80x80	60x30	100x50	120x60
42	36	20	28	24	10	10	22	16	10

NUMBER OF CLIPS FOR VARIOUS DIMENSIONS TILES PER 1 M<sup>2</sup>  
 LICZBA KLIPSÓW NA M<sup>2</sup> W ZALEŻNOŚCI OD ROZMIARU PŁYTKI

<b>No.</b>	pcs / szt.	
<b>04739</b>	400	1

EN Starter kit for levelling ceramic tiles  
 PL Zestaw startowy do poziomowania płytek  
 DE Startset für Nivellierung der Fliesen  
 RU Базовый комплект для выравнивания плитки  
 CZ Startovací sada pro vyrovnávání dlaždic  
 RO Kit pt. nivelat plăci ceramice  
 HU Csempezintező kezdőkészlet  
 ES Kit inicial de nivelación de azulejos



- FEATURES:**
- Useful when laying tiles on floors and walls
  - Work great for large tiles
  - Use with tiles of different thickness
  - Save time and make work easy and efficient

- CECHY:**
- Ułatwia układanie płytek na ścianach i podłodze
  - Szczególnie przydatny do płytek o większych rozmiarach
  - Umożliwiają poziomowanie płytek o różnych grubościach
  - Ułatwia i przyspiesza pracę



<b>No.</b>	pcs / szt.	
<b>04680</b>	201	6/12



- EN Additional tile levelling straps  
 PL Paski dodatkowe do zestawu do poziomowania płytek  
 DE Zusätzliche Stifte zum Set für Nivellierung der Fliesen  
 RU Дополнительные полоски для комплекта для выравнивания плитки  
 CZ Dodatkové pásky k sadě pro vyrovnání dlaždic  
 RO Benzii pt. nivelat placii  
 HU Plusz szjakk csempeszintező készlethez  
 ES Tiras auxiliares para el kit de nivelación de azulejos



No.	pcs / szt.	
04681	100	18

- EN Additional tile levelling cups and straps  
 PL Paski i kubki dodatkowe do zestawu do poziomowania płytek  
 DE Zusätzliche Stifte und Kappen zum Set für Nivellierung der Fliesen  
 RU Дополнительные полоски и колпачки для комплекта для выравнивания плитки  
 CZ Dodatkové pásky a pohárky k sadě pro vyrovnání dlaždic  
 RO Benzii si cupe pt. nivelat placii ceramice  
 HU Plusz szjakk és feltétek csempeszintező készlethez  
 ES Tiras y cuñas auxiliares para el kit de nivelación de azulejos



No.	pcs / szt.	
04683	100	24

- EN Cross shape tile spacers  
 PL Krzyżki dystansowe  
 DE Fliesenkreuze  
 RU Крестики для плитки  
 CZ Distanční křížky  
 RO Distanțiere in cruce  
 HU Hézagoló kereszt  
 ES Crucetas para juntas



No.	Thickness / Grubość [mm]	pcs / szt.	
04600	1.5	200	100
04610	2.0	200	100
04620	2.5	200	100
04630	3.0	150	100
04640	4.0	100	100
04650	5.0	100	100
04660	6.0	75	12/100
04668	8.0	30	100
04670	10.0	30	100

- EN Additional tile levelling cups  
 PL Kubki dodatkowe do zestawu do poziomowania płytek  
 DE Zusätzliche Kappen zum Set für Nivellierung der Fliesen  
 RU Дополнительные колпачки для комплекта для выравнивания плитки  
 CZ Dodatkové pohárky k sadě pro vyrovnání dlaždic  
 RO Cupe pt. nivelat placii ceramice  
 HU Plusz feltétek csempeszintező készlethez  
 ES Cuñas auxiliares para el kit de nivelación de azulejos



No.	pcs / szt.	
04682	100	30



- EN Levelling tongs for precision levelling straps  
 PL Szczypce do zaciągania pasków poziomujących  
 DE Spannzange für Nivellierstifte  
 RU Щипцы для затягивания выравнивающих полосок  
 CZ Kleště do utahování vyrovnávacích pásků  
 RO Dispozitiv pt. nivelare  
 HU Szintezőszij húzó fogó  
 ES Pinzas para tensar tiras de nivelación

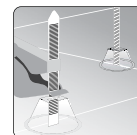

No.		
04684		12/48

- EN Wedges for wall and floor tiles  
 PL Klíny do glazury  
 DE Keile für Wand und Bodenfliesen  
 RU Клинья для плитки  
 CZ Klíny do glazury  
 RO Distanțiere faianță  
 HU Ék csempéhez  
 ES Cuñas para juntas de azulejos



No.	Thickness / Grubość [mm]	pcs / szt.	
04700	4	100	100
04710	7	50	100



- EN Cross shape tile spacers
- PL Krzyżyki dystansowe
- DE Fliesenkreuze
- RU Крестики для плитки
- CZ Distanční křížky
- RO Distanțiere în cruce
- HU Hézagoló kereszt
- ES Crucetas para juntas

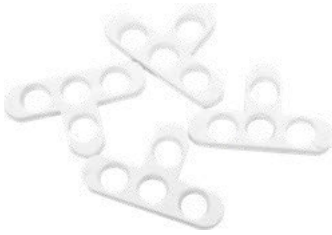

No.	Thickness / Grubość [mm]	pcs / szt.	
04591	5	50	100
04592	6	50	100
04593	8	30	100
04594	10	30	100

- EN Gas soldering lamp
- PL Gazowa lampa lutownicza
- DE Gaslötlampe
- RU Газовая паяльная лампа
- CZ Plynová pájecí lampka
- RO Lampă de lipit pe gaz
- HU Gázos forrasztólámpa
- ES Lampa de gas para soldar

1.7 kW max °C 1200 123 g/h BUTANE BUTAN  
 COMPOSITE BODY 190 g



No.	Power / Moc [kW]	
73400	1.7	12

- EN Gas soldering lamp
- PL Gazowa lampa lutownicza
- DE Gaslötlampe
- RU Газовая паяльная лампа
- CZ Plynová pájecí lampka
- RO Lampă de lipit pe gaz
- HU Gázos forrasztólámpa
- ES Lampa de gas para soldar

1.7 kW PIEZO max °C 850 123 g/h GAS GAZ BUTANE BUTAN METAL BODY METALOWY KORPUS 190 g

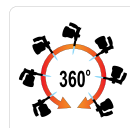

No.	Power / Moc [kW]	
73404	1.7	20

- EN Panel clamps
- PL Klamry do paneli ściennych
- DE Klammern für Paneele
- RU Крепёж для панелей
- CZ Přichytky do panelů
- RO Cleme lambriu
- HU Kapcsok c panelekhez
- ES Abrazaderas para paneles de paredes

100 PCS



No.	Type / Typ	pcs / szt.	
04720	C-3	100	50
04721	C-1	100	50

- EN Gas soldering lamp
- PL Gazowa lampa lutownicza
- DE Gaslötlampe
- RU Газовая паяльная лампа
- CZ Plynová pájecí lampka
- RO Lampă de lipit pe gaz
- HU Gázos forrasztólámpa
- ES Lampa de gas para soldar

1.7 kW PIEZO max °C 1200 123 g/h BUTANE BUTAN METAL BODY METALOWY KORPUS 190 g



No.	Power / Moc [kW]	
73403	1.7	12

- EN Gas torch
- PL Palnik gazowy
- DE Gasbrenner
- RU Газовая горелка
- CZ Plynový hořák
- RO Arzător de gaz
- HU Gázégő
- ES Soplete de gas

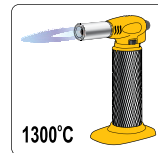

1300°C

0.22 kW PIEZO max °C 1300 GAS GAZ BUTANE BUTAN LIGHTER GAS GAZ DO ZAPALNIKZEK 10 g LOCK BLOKADA 30 min CHILDREN PROTECTION ZABEZPEČENIE PŘED DĚTMI 360°



No.	Power / Moc [kW]	
73420	0.22	10/60

EN Soldering tool 3 in 1  
 PL Lutownica gazowa 3 w 1  
 DE 3 in 1 Gaslötkolben  
 RU Газовый паяльник 3 в 1  
 CZ Plynová rajka 3 v 1  
 RO Ciocan de lipit cu gaz 3 in 1  
 HU Gaz-forrasztópaka 3 az 1  
 ES Soldador de gas 3 en 1

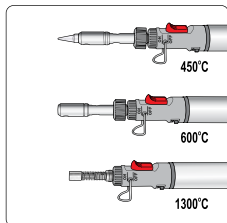

No.	Power / Moc [W]	
73410	25-80	12/48

EN Gas blow torch  
 PL Palnik gazowy  
 DE Lötbrenner  
 RU Газовая горелка  
 CZ Plynový hořák  
 RO Arzător de gaz  
 HU Gázégő  
 ES Soplete de gas



No.	Power / Moc [kW]	
73412	1.3	10/60

11



No.	Power / Moc [kW]	
73413	1.3	10/60

EN Point nozzle  
 PL Dysza do lutowania, płomień punktowy  
 DE Düse zum Löten, Punktflamme  
 RU Сопло паяльника  
 CZ Dýza na letování, bodový plamen  
 RO Duză pt. lipit, flacăra punct  
 HU Forrasztó égő, szűró láng  
 ES Tobera para soldadura, llama de punta

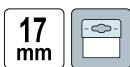

No.	Size / Rozmiar [mm]	
73330	17	50/250

EN Plumbers torch set with burners  
 PL Zestaw do lutowania z dyszami  
 DE Lötsatz  
 RU Набор для пайки  
 CZ Souprava k letování  
 RO Set pt. lipit  
 HU Forrasztó készlet  
 ES Juego para soldadura

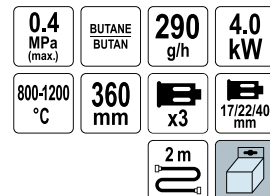

No.	Max. pressure / Maks. ciśnienie [MPa]	Power / Moc [kW]	L [mm]	
73325	0.4	4	360	20

EN Flat nozzle  
 PL Dysza do lutowania, płomień płaski  
 DE Düse zum Löten, flache Flamme  
 RU Сопло плоское  
 CZ Dýza na letování, plochý plamen  
 RO Duză pt. lipit, flacăra plată  
 HU Forrasztó égő, lapos láng  
 ES Tobera para soldadura, llama plana



No.	Size / Rozmiar [mm]	
73331	40	50/250

EN Roof heating torch with burners  
 PL Palnik dekarski z dyszami  
 DE Dachdeckerbrenner  
 RU Кровельная горелка  
 CZ Hořák pro pokrývče  
 RO Arzător pt. acoperiș  
 HU Bádógos forrasztó készülék  
 ES Soplete de techado



0.4 MPa (max.)	BUTANE BUTAN	930 g/h	13 kW	1500-1800 °C
360 mm	x3	25/35/50 mm	2 m	

**VOREL**

No.	Max. pressure / Maks. ciśnienie [MPa]	Power / Moc [kW]	L [mm]	
73340	0.4	13	360	10

EN Roof heating torch with burners  
 PL Palnik dekarski z dyszą i lancą  
 DE Dachdeckerbrenner  
 RU Кровельная горелка  
 CZ Hořák pro pokrývče  
 RO Arzător pt. acoperiș  
 HU Bádógos forrasztó készülék  
 ES Soplete de techado



0.4 MPa (max.)	BUTANE BUTAN	3420 g/h	47 kW	1500-1800 °C	745 mm
x1	50 mm	2 m			

**VOREL**

No.	Max. pressure / Maks. ciśnienie [MPa]	Power / Moc [kW]	L [mm]	
73341	0.4	47	745	20

EN Roof heating torch with burners  
 PL Palnik dekarski z dyszą i lancą  
 DE Dachdeckerbrenner  
 RU Кровельная горелка  
 CZ Hořák pro pokrývče  
 RO Arzător pt. acoperiș  
 HU Bádógos forrasztó készülék  
 ES Soplete de techado



0.25 MPa (max.)	BUTANE BUTAN	4465 g/h	62 kW	800-1200 °C	1315 mm
x1	60 mm	5 m			

**VOREL**

No.	Max. pressure / Maks. ciśnienie [MPa]	Power / Moc [kW]	L [mm]	
73342	0.25	62	1315	8

EN Roof heating torch with burners  
 PL Palnik dekarski z dyszami i lancą  
 DE Dachdeckerbrenner  
 RU Кровельная горелка  
 CZ Hořák pro pokrývče  
 RO Arzător pt. acoperiș  
 HU Bádógos forrasztó készülék  
 ES Soplete de techado



0.25 MPa (max.)	BUTANE BUTAN	5900 g/h	82 kW	1500-1800 °C	1385 mm
x2	60 mm	5 m			

**VOREL**

No.	Max. pressure / Maks. ciśnienie [MPa]	Power / Moc [kW]	L [mm]	
73343	0.25	82	1385	8

EN Weed burner  
 PL Palnik do wypalania chwastów  
 DE Unkrautbrenner  
 RU Горелка для выжигания сорняков  
 CZ Hořák na plevel  
 RO Arzător pt. buruieni  
 HU Gyomégető  
 ES Quemador de malezas



PIEZO	PROPANE BUTANE PROPAN BUTAN	226 g/h	3 kW	max °C 1300	7/16" 11 mm
850 mm	x1	25 mm			

**VOREL**

No.	Power / Moc [kW]	L [mm]	
73430	3	850	12



EN Nozzle  
 PL Dysza  
 DE Düse  
 RU Сопло  
 CZ Dýza  
 RO Duză  
 HU Fúvóka  
 ES Tobera



No.	Ø [mm]	
73350	25	50
73351	35	50
73352	50	50
73353	60	50

EN Aluminium telescopic ladder  
 PL Aluminiowa drabina teleskopowa  
 DE Teleskopleiter aus Aluminium  
 RU Многофункциональная стремянка  
 CZ Hliníkový teleskopický žebřík  
 RO Scară telesopică din aluminiu  
 HU Alumínium kihúzható létra  
 ES Escalera telescópica de aluminio

max 3.8 m  
 13 STEPS STOPNE  
 max 150 kg  
 AI NYLON

**FEATURES:**

- Safe folding system according to newpest EN 131-6 standard

- Safety lock

**CECHY:**

- Bezpieczny system składania zgodny z normą EN 131-6

- Blokada zabezpieczająca

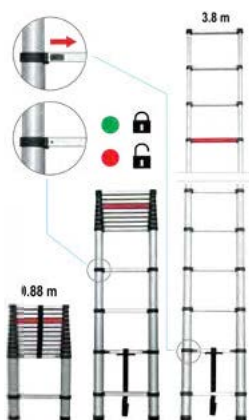

No.	Max. height / Maks. wysokość [m]	Rung quantity / Liczba stopni	
17701	3.8	13	1

EN Multifold ladder  
 PL Drabina wielofunkcyjna  
 DE Mehrzweckleiter  
 RU Лестница многофункциональная  
 CZ Multifunkční žebřík  
 RO Scară multifuncțională  
 HU Többcéllú létra  
 ES Escalera multipropósito

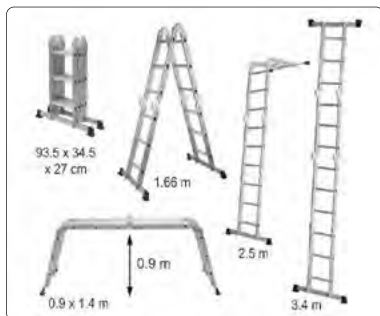

No.	Max. height / Maks. wysokość [m]	Rung quantity / Liczba stopni	
17704	3.4	4x3	1



max 3.4 m  
 4x3 STEPS STOPNE  
 16 kg  
 max 150 kg



EN Hose  
 PL Wąż przyłączeniowy do gazu  
 DE Anschluss Schlauch für Gas  
 RU Шланг газоподводящий

CZ Hadice k připojení plynu  
 RO Furtun de conectare pt. gaz  
 HU Csatlakozó gáztömlő  
 ES Manguera de conexión de gas



No.	L [m]	Ø [mm]	
73360	2	8	20
73362	5	8	10

EN Aluminium telescopic ladder  
 PL Aluminiowa drabina teleskopowa  
 DE Teleskopleiter aus Aluminium  
 RU Многофункциональная стремянка  
 CZ Hliníkový teleskopický žebřík  
 RO Scară telesopică din aluminiu  
 HU Alumínium kihúzható létra  
 ES Escalera telescópica de aluminio

max 3.8 m  
 13 STEPS STOPNE  
 max 150 kg  
 AI NYLON



No.	Max. height / Maks. wysokość [m]	Rung quantity / Liczba stopni	
17702	3.8	13	1



EN 2-step ladder  
 PL Drabina 2-stopniowa rozkładana  
 DE 2-Stufen-Leiter  
 RU 2-ступенчатая лестница  
 CZ Schůdky 2 stupně  
 RO Scări cu 2 trepte  
 HU 2 fokos lépcsők  
 ES 2 pasos escaleras



90x47,5 x49 cm	h 99 cm FOLDED ZŁOŻONA	2 STEPS STOPNIE
38x26 cm		max 150 kg
SOFT GRIP MIEKKI UCHWYT	PROTECTION RAIL WSPORNİK OCHRONNY	



No.	Height / Wysokość [m]	Rung quantity / Liczba stopni	
17730	0.9	2	4

EN Multifold ladder platform  
 PL Podest do drabiny wielofunkcyjnej  
 DE Podest für die Multifunktionale Leiter  
 RU Подставки для стремянки  
 CZ Plošina pro víceúčelový žebřík  
 RO Platformă pt. scară multifuncțională  
 HU Palló a multifunkciós létrához  
 ES Descansillos para la escala multifuncional

830x295 mm	560x295 mm	ZINC PLATED OCYNKO- WANA
ANTISLIP SURFACE POWIERZCHNIA ANTIPOŚLIZGOWA	max 150 kg	

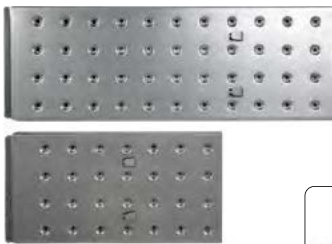

No.	For / Dla	
17705	17704	5

EN Saw horse  
 PL Podstawa robocza z metalu  
 DE Stahl-Arbeitsbock  
 RU Опорный штатив  
 CZ Opěrný kozlík  
 RO Capre de lucru  
 HU Munkabak  
 ES Caballete de apoyo

2 PCS	100x10 x75 cm	max 200 kg	NON SLIP WORKTOP BLAT ANTY- POŚLIZGOWY
GALVANIZED STEEL OCYNKOWANA	HOLDER FOR CARRYING UCHWYT DO PRZENOSZENIA		



No.	
29401	1

EN 3-step ladder  
 PL Drabina 3-stopniowa rozkładana  
 DE 3-Stufen-Leiter  
 RU 3-ступенчатая лестница  
 CZ Schůdky 3 stupně  
 RO Scări cu 3 trepte  
 HU 3 fokos lépcsők  
 ES 3 pasos escaleras



115x47,5 x65 cm	h 125 cm FOLDED ZŁOŻONA	3 STEPS STOPNIE
38x26 cm		max 150 kg
SOFT GRIP MIEKKI UCHWYT	PROTECTION RAIL WSPORNİK OCHRONNY	



No.	Height / Wysokość [m]	Rung quantity / Liczba stopni	
17733	1.15	3	2

EN Saw horse  
 PL Podstawa robocza z tworzywa  
 DE Stahl-Arbeitsbock  
 RU Опорный штатив  
 CZ Opěrný kozlík  
 RO Capre de lucru  
 HU Munkabak  
 ES Caballete de apoyo

2 PCS	PP	ABS	TPR	
----------	----	-----	-----	--



No.	
29400	3

EN Saw horse  
 PL Podstawa robocza z regulowaną wysokością  
 DE Stahl-Arbeitsbock  
 RU Опорный штатив  
 CZ Opěrný kozlík  
 RO Capre de lucru  
 HU Munkabak  
 ES Caballete de apoyo

130 79 mm	max 200 kg	GALVANIZED STEEL OCYNKOWANA	HOLDER FOR CARRYING UCHWYT DO PRZENOSZENIA	
-----------------	------------	-----------------------------------	---	--



No.	
29404	1

EN Adjustable roller stand  
 PL Podpora z rolką  
 DE Rollenbock  
 RU Поликовая опора  
 CZ Opěrný stojan  
 RO Stand cu role si suport  
 HU Felsőgörgős-bak  
 ES Caballete de apoyo con rodillo



105  
68 mm

60cm  
ROLLER  
ROLKA

max  
60 kg

GALVANIZED  
STEEL  
STAL  
OCYNKOWANA

CHROME  
ROLLER  
CHROMOWANA  
ROLKA



No.		
29410		1

EN Telescopic support bar  
 PL Podpora teleskopowa  
 DE Baustütze-Schnellspannstütze  
 RU Подъемник-распорка для гипсокартона  
 CZ Tyč teleskopická rozpěrná  
 RO Suport sustinere telescopic  
 HU Teleszkópos támasztórúd  
 ES Puntal expansion



115  
50 cm

max  
30 kg



No.		
29440		2/10

EN Telescopic support bar  
 PL Podpora teleskopowa  
 DE Baustütze-Schnellspannstütze  
 RU Подъемник-распорка для гипсокартона  
 CZ Tyč teleskopická rozpěrná  
 RO Suport sustinere telescopic  
 HU Teleszkópos támasztórúd  
 ES Puntal expansion



290  
115 cm

max  
30 kg



No.		
29444		2/10

EN Telescopic support bar  
 PL Podpora teleskopowa  
 DE Baustütze-Schnellspannstütze  
 RU Подъемник-распорка для гипсокартона  
 CZ Tyč teleskopická rozpěrná  
 RO Suport sustinere telescopic  
 HU Teleszkópos támasztórúd  
 ES Puntal expansion



290  
160 cm

max  
60 kg



No.		
29445		4/8

EN Trowel  
 PL Paca  
 DE Reibebrett  
 RU Терка  
 CZ Hladitko  
 RO Gletieră  
 HU Glettelő  
 ES Llana



No.	Size / Rozmiar [mm]	
06400	130x270	10
06410	140x500	10
06440	170x320	10

EN Trowel  
 PL Paca  
 DE Reibebrett  
 RU Терка  
 CZ Hladitko  
 RO Gletieră  
 HU Glettelő  
 ES Llana

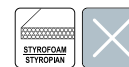

No.	Size / Rozmiar [mm]	
06420	140x700	10
06430	140x1000	10

EN Trowel  
 PL Paca  
 DE Reibebrett  
 RU Телка  
 CZ Hladitko  
 RO Gletieră  
 HU Glettelő  
 ES Llana

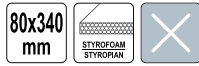

No.	Size / Rozmiar [mm]	
06401	80x340	10

EN Trowel  
 PL Paca  
 DE Reibebrett  
 RU Телка  
 CZ Hladitko  
 RO Gletieră  
 HU Glettelő  
 ES Llana

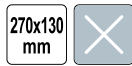

No.	Size / Rozmiar [mm]	
06500	270x130	24

EN Trowel  
 PL Paca  
 DE Reibebrett  
 RU Телка  
 CZ Hladitko  
 RO Gletieră  
 HU Glettelő  
 ES Llana



No.	Size / Rozmiar [mm]	Rubber thickness / Grubość gumy [mm]	
06520	270x130	4	30

EN Trowel  
 PL Paca  
 DE Reibebrett  
 RU Телка  
 CZ Hladitko  
 RO Gletieră  
 HU Glettelő  
 ES Llana



No.	Size / Rozmiar [mm]	Sponge thickness / Grubość gąbki [mm]	
06540	270x130	25	20

EN Rasp for polystyrene  
 PL Tarka do styropianu  
 DE Reibebrett für Styropor  
 RU Телка для пенопласта  
 CZ Rašple na polystyren  
 RO Gletieră pt. răzuit polistiren  
 HU Polisztirol reszelő  
 ES Escofina para poliestireno



No.	Size / Rozmiar [mm]	
06470	270x130	20
06472	400x180	10

EN Trowel  
 PL Paca  
 DE Reibebrett  
 RU Телка  
 CZ Hladitko  
 RO Gletieră  
 HU Glettelő  
 ES Llana



No.	Size / Rozmiar [mm]	
06510	270x130	20

EN Trowel  
 PL Paca  
 DE Reibebrett  
 RU Телка  
 CZ Hladitko  
 RO Gletieră  
 HU Glettelő  
 ES Llana



No.	Size / Rozmiar [mm]	Sponge thickness / Grubość gąbki [mm]	
06530	270x130	25	20



EN Trowel  
PL Paca  
DE Reibebrett  
RU Tepka  
CZ Hladitko  
RO Gletieră  
HU Glettelő  
ES Llana



No.	Size / Rozmiar [mm]	
06640	380x128	10
06660	480x128	10
06680	580x128	18

EN Trowel  
PL Paca  
DE Reibebrett  
RU Tepka  
CZ Hladitko  
RO Gletieră  
HU Glettelő  
ES Llana



No.	Size / Rozmiar [mm]	Teeth size / Rozmiar zębów [mm]	
06650	380x128	8x8	10
06670	480x128	8x8	10
06690	580x128	8x8	18

EN Trowel  
PL Paca  
DE Reibebrett  
RU Tepka  
CZ Hladitko  
RO Gletieră  
HU Glettelő  
ES Llana



No.	Size / Rozmiar [mm]	
06700	270x125	24

EN Trowel  
PL Paca  
DE Reibebrett  
RU Tepka  
CZ Hladitko  
RO Gletieră  
HU Glettelő  
ES Llana



No.	Size / Rozmiar [mm]	
06701	270x130	24

EN Trowel  
PL Paca  
DE Reibebrett  
RU Tepka  
CZ Hladitko  
RO Gletieră  
HU Glettelő  
ES Llana



No.	Size / Rozmiar [mm]	Teeth size / Rozmiar zębów [mm]	
06740	270x125	4x4	24
06760	270x125	6x6	24
06780	270x125	8x8	24
06781	270x125	10x10	24



EN Trowel  
PL Paca  
DE Reibebrett  
RU Tepka  
CZ Hladitko  
RO Gletieră  
HU Glettelő  
ES Llana



No.	Size / Rozmiar [mm]	
06512	260x95	12

EN Trowel  
PL Paca  
DE Reibebrett  
RU Tepka  
CZ Hladitko  
RO Gletieră  
HU Glettelő  
ES Llana



No.	Size / Rozmiar [mm]	Sponge thickness / Grubość gąbki [mm]	
06532	270x130	30	20



EN Trowel  
PL Paca  
DE Reibebrett  
RU Терка  
CZ Hladítko  
RO Gletieră  
HU Glettelő  
ES Llana



**VOREL**

No.	Size / Rozmiar [mm]	Rubber thickness / Grubość gumy [mm]	
06537	270x130	9	20
06538	270x130	18	20

EN Trowel  
PL Kielnia  
DE Kelle  
RU Кельма  
CZ Lžíce  
RO Mistrie  
HU Vakolókanál  
ES Paleta



**VOREL**

No.	Size / Rozmiar [mm]	
06341	180	50
06351	200	30

EN Trowel  
PL Kielnia  
DE Kelle  
RU Кельма

CZ Lžíce  
RO Mistrie  
HU Vakolókanál  
ES Paleta

**VOREL**

No.	Size / Rozmiar [mm]	
06109	40x110	50
06110	60x110	50
06120	80x120	50
06121	100x120	50

EN Plaster / stucco spray gun  
PL Tynkownica pneumatyczna do ścian  
DE Spritzpistole für Mörtel  
RU Пневмоковш для штукатурки стен  
CZ Stříkací pistole pro maltu  
RO Spray pistol pt. mortar  
HU Habarcs szórópisztoly  
ES Pistola pulverizadora para mortero

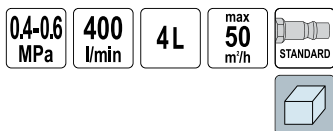

**VOREL**

$L_{pa} = 91,8 \pm 2,5$  dB;  $L_{ma} = 102,8 \pm 2,5$  dB;  $a_n = < 2,5$  m/s<sup>2</sup>

No.	Required air flow / Wymagany przepływ powietrza [l/min]	
09900	350-400	4

EN Trowel  
PL Kielnia  
DE Kelle  
RU Кельма  
CZ Lžíce  
RO Mistrie  
HU Vakolókanál  
ES Paleta



**VOREL**

No.	Size / Rozmiar [mm]	
06340	180	50
06350	200	50
06360	220	50

EN Trowel  
PL Kielnia  
DE Kelle  
RU Кельма  
CZ Lžíce  
RO Mistrie  
HU Vakolókanál  
ES Paleta



**VOREL**

No.	Size / Rozmiar [mm]	
06370	130	50
06380	180	30

EN Ceiling plaster / stucco spray gun  
PL Tynkownica pneumatyczna do sufitów  
DE Deckenplatte / Stucco Spritzpistole  
RU Пневмоковш для штукатурки потолков  
CZ Stříkací pistole pro maltu  
RO Spray pistol pt. mortar  
HU Habarcs szórópisztoly  
ES Pistola pulverizadora para mortero

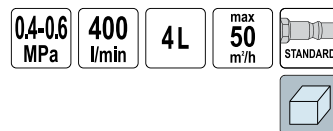

**VOREL**

$L_{pa} = 94,9 \pm 2,5$  dB;  $L_{ma} = 105,9 \pm 2,5$  dB;  $a_n = < 2,5$  m/s<sup>2</sup>

No.	Required air flow / Wymagany przepływ powietrza [l/min]	
09903	350-400	4

- EN Hand wall coating sprayer
- PL Narzutnica tynku
- DE Verputzmaschine
- RU Метатель штукатурки
- CZ Omítka
- RO Pulverizator manual pt. pereti
- HU Vakolatszóró
- ES Máquina de revestimiento de yeso

210x170  
mm



No.	Size / Rozmiar [mm]	
09910	210x170	12

- EN Aerated concrete drill
- PL Wiertło do gazobetonu
- DE Bohrer für Porenbeton
- RU Сверло по газобетону
- CZ Vrták do pórbetonu
- RO Burghiu pt. BCA
- HU Pórusbeton fúró
- ES Broca para hormigón celular

GALVANIZED  
STEEL  
STAL  
OCYNKOWANA



No.	Working width / Szerokość robocza [mm]	
05821	60	20
05822	80	20
05823	120	20

- EN Scraper
- PL Zdzierak
- DE Raspelhobel
- RU Рубанок
- CZ Škrabák
- RO Gletieră
- HU Vakolatgyalu
- ES Raspador

80x400  
mm



No.	Size / Rozmiar [mm]	
05831	80x400	10

- EN Aerated concrete trowel
- PL Kielnia do gazobetonu
- DE Kelle für Porenbeton
- RU Кельма для газобетона
- CZ Zednická lžice na pórbeton
- RO Mistrie pt. BCA
- HU Simító pórusbetonhoz
- ES Paleta para hormigón celular



No.	Size / Rozmiar [mm]	
05801	100	10
05802	115	10
05803	125	10
05804	200	10
05805	240	10

- EN Scraper
- PL Zdzierak
- DE Raspelhobel
- RU Рубанок
- CZ Škrabák
- RO Gletieră
- HU Vakolatgyalu
- ES Raspador

80x400  
mm



No.	Size / Rozmiar [mm]	
05830	80x400	10

- EN Guide for aircrete blocks
- PL Przymiar do gazobetonu
- DE Sägewinkel für Porenbeton
- RU Угольник для резки газобетона
- CZ Úhelník na pórbeton
- RO Suport pt. tăiere BCA
- HU Pórusbeton sablon
- ES Guía para hormigón celular



No.		
05840		4

- EN Groove scraper  
 PL Rylec  
 DE Nutenschaber  
 RU Штроборез
- CZ Drážkovač  
 RO Unealta canelat BCA  
 HU Horonyvágó  
 ES Acanalador

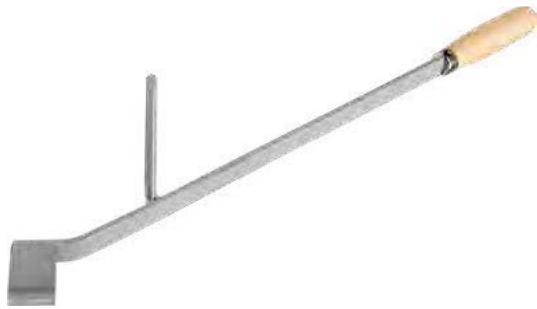

No.		
05850		10

- EN Panel carry  
 PL Nosidło do płyt gipsowo-kartonowych  
 DE Plattenträger mit Tragegriff  
 RU Приспособление для переноски плит  
 CZ Držák pro přenášení desek s rukojetí  
 RO Dispozitiv pt. transportat plac de gips-carton  
 HU Gipsz Karton hordó  
 ES Porta-paneles

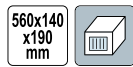

No.	Dimensions / Wymiary [mm]	
04756	560x140x190	10

- EN Scraper  
 PL Szpachelka  
 DE Malerspachtel  
 RU Шпатель  
 CZ Špachtle  
 RO Șpaclu  
 HU Spatula  
 ES Espatula



No.	Working width / Szerokość robocza [mm]	
06030	30	12/240
06040	40	12/240
06050	50	12/240
06060	60	12/240
06080	80	12/240
06100	100	12/240

- EN Drywall panel carrier  
 PL Uchwyt do przeniesienia płyt gipsowo-kartonowych  
 DE Plattenträger mit Tragegriff  
 RU Приспособление для переноски плит  
 CZ Držák pro přenášení desek s rukojetí  
 RO Dispozitiv pt. transportat plac de gips-carton  
 HU Jellemzők és előnyök  
 ES Empunadura porta-placas

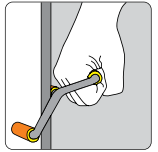

No.		
04755		6/12

- EN Drywall stripper  
 PL Obcinak dwustronny do płyt gipsowo-kartonowych  
 DE Streifenschneider  
 RU Рейсмус-резаk для гипсокартона  
 CZ Řezák na sádkarton  
 RO Dispozitiv reglabil de taiere a placilor de gips-carton  
 HU Gipsz Karton vágó  
 ES Cortador de tiras para tablaroca

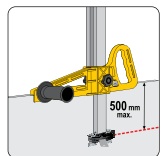
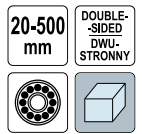

No.	Cutting width / Szerokość cięcia [mm]	
04770	20-500	10

- EN Scraper set  
 PL Zestaw szpachelek  
 DE Malerspachtelsatz  
 RU Набор шпателей  
 CZ Špachtle  
 RO Șpacluri  
 HU Spatula  
 ES Espatulas



No.	Working width / Szerokość robocza [mm]	pcs / szt.	
06130	30, 50, 80	3	25/100

- EN Corner trowel
- PL Szpachelka kątowa
- DE Necken-Kelle
- RU Кельма угловая
- CZ Úhlová špachtle
- RO Șpaclu colț
- HU Kanál sarok
- ES Paleta ángulo



No.	Dimensions / Wymiary [mm]	
06140	80x60x60	50

- EN Plastic japanese putty knives
- PL Szpachle japońskie plastikowe
- DE Kunststoff Japan-Spachtel-Set
- RU Пластиковые шпатели «японки»
- CZ Špachtle japonské plastové
- RO Set spaclu japoneze plastic
- HU Japán spakli készlet műanyag
- ES Juego de espátulas japonesas de plástico



No.	Working width / Szerokość robocza [mm]	pcs / szt.	
05950	50, 80, 100, 120	4	10

- EN Stainless steel putty knife
- PL Szpachla nierdzewna
- DE Edelstahl-Kleberspachtel
- RU Шпатель фасадный нержавеющей
- CZ Nerezová špachtle
- RO Spaclu inox pt. chituit
- HU Rozsdamentes spakli
- ES Espátula de acero inoxidable



No.	Working width / Szerokość robocza [mm]	
06294	40	100
06295	60	80
06296	80	60
06297	100	50
06298	150	80
06301	200	60
06304	250	50
06307	350	25
06308	450	25
06309	600	10

- EN Corner trowel
- PL Szpachelka kątowa
- DE Necken-Kelle
- RU Кельма угловая
- CZ Úhlová špachtle
- RO Șpaclu colț
- HU Kanál sarok
- ES Paleta ángulo



No.	Dimensions / Wymiary [mm]	
06150	80x60x60	50

- EN Stainless steel scraper set
- PL Szpachelki nierdzewne "japonki"
- DE Aufstreichspachtel
- RU Набор шпателей тип "Японский"
- CZ Špachtle japonky nerezavějící
- RO Șpaclu japoneze inoxidabile
- HU Spatula rozsdamentes
- ES Espátulas "japonesas" de acero

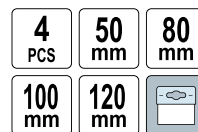

No.	Working width / Szerokość robocza [mm]	pcs / szt.	
06290	50, 80, 100, 120	4	12/120

- EN Stainless steel putty knife
- PL Szpachla nierdzewna
- DE Edelstahl-Kleberspachtel
- RU Шпатель фасадный нержавеющей
- CZ Nerezová špachtle
- RO Spaclu inox pt. chituit
- HU Rozsdamentes spakli
- ES Espátula de acero inoxidable



No.	Working width / Szerokość robocza [mm]	Teeth size / Rozmiar zębów [mm]	
06299	150	6x6	80
06300	150	8x8	80
06302	200	6x6	60
06303	200	8x8	60
06305	250	6x6	50
06306	250	8x8	50



EN Finishing spatula  
PL Szpachla wykończeniowa  
DE Flächenspachtel  
RU Финишный шпатель

CZ Špachtle fasádní  
RO Gletieră finisare  
HU Glett lehűző  
ES Espátula para alisado



**VOREL**

No.	Working width / Szerokość robocza [mm]	
06001	250	24
06002	400	12
06003	600	12
06004	800	12
06005	1000	8
06006	1200	8

EN Plastic putty knives for glue  
PL Pace plastikowe do kleju  
DE Kunststoffspachtel gezahnt  
RU Пластиковые шпатели для плиточного клея  
CZ Zubová stěrka plastová  
RO Spațula din plastic  
HU Műanyag spakli  
ES Espátula de plástico

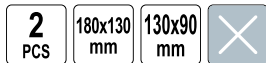

**VOREL**

No.	Dimensions / Wymiary [mm]	pcs / szt.	
05960	180x130, 130x90	2	10

EN Plastic putty knife  
PL Szpachla plastikowa  
DE Kunststoffspachtel  
RU Шпатель пластмассовый  
CZ Plastová špachtle  
RO Spațula din plastic  
HU Műanyag spakli  
ES Espátula de plástico



**VOREL**

No.	Working width / Szerokość robocza [mm]	Teeth size / Rozmiar zębów [mm]	
05972	225	6x6	50

EN Replaceable blade for finishing spatula  
PL Ostrze do szpachli wykończeniowej  
DE Ersatzblatt für Flächenspachtel  
RU Лезвие для финишного шпателя  
CZ Náhradní čepel do špachtle fasádní  
RO Lamă de înlocuit pt. gletieră finisare  
HU Cserélhető penge glett lehűzőhöz  
ES Cuchilla de recambio para espátula de alisado



**VOREL**

No.	W [mm]	For / Dla	
06010	250	06001	160
06011	400	06002	160
06012	600	06003	160
06013	800	06004	80
06014	1000	06005	80
06015	1200	06006	80

EN Plastic putty knife  
PL Szpachla plastikowa  
DE Kunststoffspachtel  
RU Шпатель пластмассовый  
CZ Plastová špachtle  
RO Spațula din plastic  
HU Műanyag spakli  
ES Espátula de plástico



**VOREL**

No.	Working width / Szerokość robocza [mm]	
05971	225	50

EN Plastic putty knife  
PL Szpachla plastikowa  
DE Kunststoffspachtel  
RU Шпатель пластмассовый  
CZ Plastová špachtle  
RO Spațula din plastic  
HU Műanyag spakli  
ES Espátula de plástico



**VOREL**

No.	Working width / Szerokość robocza [mm]	Teeth size / Rozmiar zębów [mm]	
05973	225	7	50

EN Plastic putty knife set  
 PL Szpachle plastikowe  
 DE Kunststoff-Spachtel-Set  
 RU Шпатели пластиковые  
 CZ Plastové špachtle  
 RO Set spaclu plastic  
 HU Spakli készlet műanyag  
 ES Espátulas de plástico

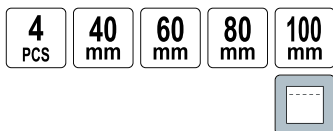

No.	Working width / Szerokość robocza [mm]	pcs / szt.	
05980	40, 60, 80, 100	4	30

EN Flexible silicone and sealant smother  
 PL Gładzik do silikonu  
 DE Silikonglätter  
 RU Шпатель для затирки силикона  
 CZ Hladítko do silikonu  
 RO Dispozitiv pt. silicon si mastic  
 HU Szilikon lehéző  
 ES Alisador de juntas de silicona



No.	L [mm]	
04360	150	24/240

EN Stainless steel scraper  
 PL Szpachelka nierdzewna  
 DE Rostfrei Spachtel  
 RU Шпатель нержавеющей  
 CZ Špachtle  
 RO Șpaclu  
 HU Spatula  
 ES Espatula de acero inox



No.	Working width / Szerokość robocza [mm]	
05911	30	6/72
05912	40	6/72
05913	50	6/72
05914	60	6/72
05915	80	6/72
05916	100	6/72

EN Rubber putty knife  
 PL Szpachla gumowa  
 DE Gummispachtel  
 RU Шпатель резиновый  
 CZ Gumová špachtle  
 RO Șpaclu cauciuc  
 HU Fugázó gumi  
 ES Espátula de goma



No.	Working width / Szerokość robocza [mm]	
06310	150	30
06320	200	30
06330	250	30
06331	300	30

EN Stainless steel scraper  
 PL Szpachelka nierdzewna  
 DE Rostfrei Spachtel  
 RU Шпатель нержавеющей

CZ Špachtle  
 RO Șpaclu  
 HU Spatula  
 ES Espatula de acero inox



No.	Working width / Szerokość robocza [mm]	
05901	30	6/72
05902	40	6/72
05903	50	6/72
05904	60	6/72
05905	80	6/72
05906	100	6/72

EN Stainless steel scraper  
 PL Szpachelka nierdzewna wygięta  
 DE Rostfrei Spachtel  
 RU Шпатель нержавеющей изогнутый  
 CZ Špachtle  
 RO Șpaclu  
 HU Spatula  
 ES Espatula de acero inox curvo



No.	Working width / Szerokość robocza [mm]	
05921	30	6/72
05922	40	6/72
05923	50	6/72
05924	60	6/72
05925	80	6/72
05926	100	6/72

- EN Painting scraper  
 PL Skrobak malarski  
 DE Malerabkratzer  
 RU Скребок для краски со сменным лезвием  
 CZ Škrabka malířská  
 RO Răzuitor pt. zugrăvi  
 HU Festékvakaró  
 ES Rascador de pintor



No.	Blade working width / Szerokość robocza ostrza [mm]	
06795	100	60

- EN Spare blades for painting scraper  
 PL Ostrze do skrobaka  
 DE Schneide für Malerabkratzer  
 RU Сменные лезвия для скребка  
 CZ Ostrří do škrabky  
 RO Taiș pt. răzuitor  
 HU Festékvakaró-pengék  
 ES Filo para rascador



No.	For / Dla	
06796	06795	10/100

- EN Scraper for concrete floor  
 PL Skrobak do betonu z trzonkiem  
 DE Betonschaber  
 RU Скребок напольный для бетона  
 CZ Škrabka  
 RO Răzuitor  
 HU Kaparó  
 ES Raspador obra suel



No.	Blade size / Rozmiar ostrza [mm]	L [mm]	
05750	75x200	1300	10
05751	75x300	1300	10
05752	75x400	1300	10

- EN Blade for scraper  
 PL Wymienne ostrze do skrobaka do betonu  
 DE Klinge für Betonschaber  
 RU Лезвие к скребку для бетонного пола  
 CZ Škrabka vyměnitelná čepel  
 RO Lamă de schimb  
 HU Kaparó cserélhető penge  
 ES Răzuitor lamă de schimb



No.	Blade size / Rozmiar ostrza [mm]	
05770	100x200	25/50
05771	100x300	25/50
05772	100x400	25/50

- EN Painting scraper  
 PL Skrobak malarski  
 DE Malerabkratzer  
 RU Скребок для краски  
 CZ Škrabka malířská  
 RO Răzuitor pt. zugrăvi  
 HU Festékvakaró  
 ES Rascador de pintor



No.	Working width / Szerokość robocza [mm]	
06797	115	50

- EN Telescopic scraper  
 PL Skrobak teleskopowy  
 DE Teleskop Schaber  
 RU Скребок телескопический  
 CZ Teleskopický stěrač  
 RO Răzuitor flexibil  
 HU Teleszkópos jégkaparó  
 ES Telescópico raspador



No.		
06799		16/96

- EN Scraper for concrete floor  
 PL Skrobak do betonu bez trzonka  
 DE Betonschaber  
 RU Скребок напольный для бетона  
 CZ Škrabka  
 RO Răzuitor  
 HU Kaparó  
 ES Raspador obra suel



No.	Blade size / Rozmiar ostrza [mm]	
05760	120x350	12/24
05761	120x250	12/24

- EN Blade for scraper  
 PL Wymienne ostrze do skrobaka do betonu  
 DE Klinge für Betonschaber  
 RU Лезвие к скребку для бетонного пола  
 CZ Škrabka vyměnitelná čepel  
 RO Lamă de schimb  
 HU Kaparó cserélhető penge  
 ES Răzuitor lamă de schimb



No.	Blade size / Rozmiar ostrza [mm]	
05773	150x250	25/50
05774	150x350	25/50

EN Mason's pan  
 PL Czerpak murarski  
 DE Gipspfänchen  
 RU Ковш штукатурный  
 CZ Zednický koresek  
 RO Cancloc  
 HU Kőműveskanál  
 ES Achicador de albanil



No.	Quantity
06335	50

EN Mixer  
 PL Mieszadło  
 DE Rührer  
 RU Мешалка

CZ Michadlo  
 RO Mixer  
 HU Keverő  
 ES Mezclador



No.	Ø [mm]	L [mm]	Quantity
09060	60	400	40/80
09080	85	400	40/80
09090	100	600	30

EN Mixer  
 PL Mieszadło  
 DE Rührer  
 RU Мешалка

CZ Michadlo  
 RO Mixer  
 HU Keverő  
 ES Mezclador



No.	Ø [mm]	L [mm]	Quantity
09010	90	510	40

EN Mixer  
 PL Mieszadło  
 DE Rührer  
 RU Мешалка

CZ Michadlo  
 RO Mixer  
 HU Keverő  
 ES Mezclador



No.	Ø [mm]	L [mm]	Type / Typ	Quantity
09025	75	370	C-75	20

EN Building strainer  
 PL Sito budowlane  
 DE Bau Sieb  
 RU Сито строительное  
 CZ Prohazovací sito stavební  
 RO Sita construcții  
 HU Építőipari rosta  
 ES Cedazo para construcción



No.	Dimensions / Wymiary [cm]	Eyelet size / Rozmiar oczka [mm]	Quantity
34944	60x100	4	30
34945	60x100	6	5/30
34946	60x100	8	5/30
34947	60x100	10	30

EN Mixer  
 PL Mieszadło  
 DE Rührer  
 RU Мешалка  
 CZ Michadlo  
 RO Mixer  
 HU Keverő  
 ES Mezclador



No.	Ø [mm]	L [mm]	Quantity
09005	65	410	40
09006	80	410	40

EN Mixer  
 PL Mieszadło  
 DE Rührer  
 RU Мешалка

CZ Michadlo  
 RO Mixer  
 HU Keverő  
 ES Mezclador



No.	Ø [mm]	L [mm]	Quantity
09015	85	400	40
09017	100	550	20

EN Mixer  
 PL Mieszadło  
 DE Rührer  
 RU Мешалка

CZ Michadlo  
 RO Mixer  
 HU Keverő  
 ES Mezclador



No.	Ø [mm]	L [mm]	Quantity
09031	75	300	10



EN Mixer  
 PL Mieszadło  
 DE Rührer  
 RU Мешалка  
 CZ Michadlo  
 RO Mixer  
 HU Keverő  
 ES Mezclador



No.	Ø [mm]	L [mm]	
09044	80	400	25
09046	100	600	25

EN Mixer  
 PL Mieszadło  
 DE Rührer  
 RU Мешалка  
 CZ Michadlo  
 RO Mixer  
 HU Keverő  
 ES Mezclador



No.	Ø [mm]	L [mm]	
09036	60	400	60
09038	80	400	35
09040	100	600	30

EN Mixer  
 PL Mieszadło  
 DE Rührer  
 RU Мешалка  
 CZ Michadlo  
 RO Mixer  
 HU Keverő  
 ES Mezclador



**VOREL**

No.	Ø [mm]	L [mm]	
09096	80	400	20
09097	100	500	20

EN Mixer  
 PL Mieszadło  
 DE Rührer  
 RU Мешалка  
 CZ Michadlo  
 RO Mixer  
 HU Keverő  
 ES Mezclador

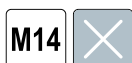

No.	Ø [mm]	L [mm]	
09063	115	580	10
09065	135	580	10

EN Mixer  
 PL Mieszadło  
 DE Rührer  
 RU Мешалка  
 CZ Michadlo  
 RO Mixer  
 HU Keverő  
 ES Mezclador



No.	Ø [mm]	L [mm]	Type / Typ	
09048	75	400	C-75	20
09049	85	450	C-85	20
09050	100	500	C-100	20
09051	110	550	C-110	20

EN Mixer  
 PL Mieszadło  
 DE Rührer  
 RU Мешалка  
 CZ Michadlo  
 RO Mixer  
 HU Keverő  
 ES Mezclador



No.	Ø [mm]	L [mm]	Type / Typ	
09094	120	600	C-120	10

EN Mixer  
 PL Mieszadło  
 DE Rührer  
 RU Мешалка  
 CZ Michadlo  
 RO Mixer  
 HU Keverő  
 ES Mezclador



**VOREL**

No.	Ø [mm]	L [mm]	
09077	80	500	10

EN Mixer  
 PL Mieszadło  
 DE Rührer  
 RU Мешалка  
 CZ Michadlo  
 RO Mixer  
 HU Keverő  
 ES Mezclador



**VOREL**

No.	Ø [mm]	L [mm]	
09062	100	500	20

- EN Wallpaper perforator
- PL Walek do perforacji tapet
- DE Tapetenperforierwalze
- RU Валик для перфорации обоев
- CZ Perforační váleček na tapety
- RO Perforator de tapet
- HU Tapétaperforáló henger
- ES Rodillo para perforación de papel de pared



No.	W [mm]	
06457	150	6/36

- EN Deaeration roller
- PL Walek do odpowietrzania
- DE Entlüftungsrolle
- RU Валик аэрационный
- CZ Váleček na odvodušňování
- RO Rola pt. modelare sapa
- HU Levegőkinyomó henger
- ES Rodillo para hacer el vacío



No.	Size / Rozmiar [mm]	
06450	75x230	15
06452	123x230	10

- EN Plaster roller
- PL Walek do gładzi gipsowych
- DE Rollspachtel-Walze
- RU Валик для шпаклевки
- CZ Váleček na sádrovou omítku
- RO Trafalet
- HU Glettelő henger
- ES Rodillo para masillar



No.	W [mm]	A [mm]	Ø [mm]	
09445	230	55	6	48

- EN Handy paint roller
- PL Walek malarski ze zbiornikiem na farbę
- DE Malerrolle mit Farbbehälter
- RU Малярный валик с емкостью для краски
- CZ Malářský váleček s nádobou na barvu
- RO Trafalet cu rezervor
- HU Festőhenger festékadagoló tartállyal
- ES Rodillo de pintura con depósito

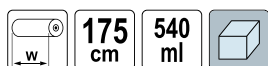

No.	W [mm]	L [mm]	
09397	230	1750	6

- EN Squeegee for wallpapers
- PL Rakiel do tapet
- DE Tapetenrakiel
- RU Ракель для обоев
- CZ Škrabka na tapety
- RO Racleta pt. tapet
- HU Tapétalenyomó
- ES Rasqueta para papel de pared



No.	Size / Rozmiar [mm]	
06460	280x165	12/120

- EN Deaeration roller
- PL Walek do odpowietrzania
- DE Entlüftungsrolle
- RU Валик аэрационный
- CZ Váleček na odvodušňování
- RO Rola pt. modelare sapa
- HU Levegőkinyomó henger
- ES Rodillo para hacer el vacío



No.	Size / Rozmiar [mm]	
06453	110x500	2

- EN Plaster roller replacement
- PL Zapasowy walek do gładzi gipsowych
- DE Rollspachtel-Ersatzwalze
- RU Запасной валик для шпаклевки
- CZ Náhradní váleček na sádrovou omítku
- RO Rezerva trafalet
- HU Glettelő henger fej
- ES Recambio rodillo para masillar

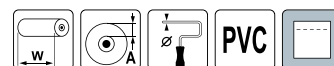

No.	W [mm]	A [mm]	Ø [mm]	For / Dla	
09446	230	55	6	09445	50

- EN Paint roller refill
- PL Zapas do walaka
- DE Ersatz Farbrolle
- RU Шубка для валика
- CZ Náhradní váleček
- RO Rezerva trafalet
- HU Pót festőhenger
- ES Recambio de rodillo

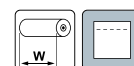

No.	W [mm]	For / Dla	
09398	230	09397	100

EN Paint roller  
 PL Walek malarski  
 DE Farbroller  
 RU Валик в сборе  
 CZ Malířský váleček  
 RO Trafalet cu tijă  
 HU Festőhenger  
 ES Rodillo de pintura

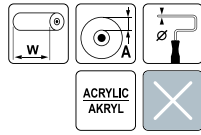

**VOREL**

No.	W [mm]	A [mm]	Ø [mm]	
09307	180	20	6	55
09308	250	20	6	50

EN Paint roller  
 PL Walek malarski  
 DE Farbroller  
 RU Валик в сборе  
 CZ Malířský váleček  
 RO Trafalet cu tijă  
 HU Festőhenger  
 ES Rodillo de pintura

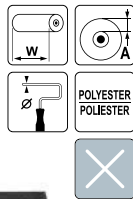

**VOREL**

No.	W [mm]	A [mm]	Ø [mm]	
09345	180	15	6	55
09346	250	15	6	50

EN Paint roller  
 PL Walek malarski  
 DE Farbroller  
 RU Валик в сборе  
 CZ Malířský váleček  
 RO Trafalet cu tijă  
 HU Festőhenger  
 ES Rodillo de pintura

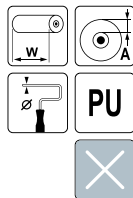

**VOREL**

No.	W [mm]	A [mm]	Ø [mm]	
09370	50	35	6	70

EN Paint roller refill  
 PL Zapas do walka  
 DE Ersatz Farbrolle  
 RU Шубка для валика  
 CZ Náhradní váleček  
 RO Rezerva trafalet  
 HU Pót festőhenger  
 ES Recambio de rodillo



**VOREL**

No.	W [mm]	A [mm]	Ø [mm]	
09302	180	15	6	40
09303	250	15	8	25

EN Paint roller  
 PL Walek malarski  
 DE Farbroller  
 RU Валик в сборе  
 CZ Malířský váleček  
 RO Trafalet cu tijă  
 HU Festőhenger  
 ES Rodillo de pintura

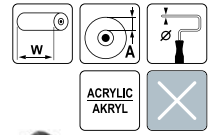

**VOREL**

No.	W [mm]	A [mm]	Ø [mm]	
09334	100	9	6	40
09336	180	18	6	60

EN Paint roller  
 PL Walek malarski  
 DE Farbroller  
 RU Валик в сборе  
 CZ Malířský váleček  
 RO Trafalet cu tijă  
 HU Festőhenger  
 ES Rodillo de pintura

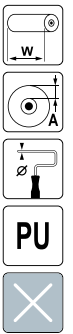

**VOREL**

No.	W [mm]	A [mm]	Ø [mm]	
09359	150	50	6	50

EN Paint roller  
 PL Walek malarski  
 DE Farbroller  
 RU Валик в сборе  
 CZ Malířský váleček  
 RO Trafalet cu tijă  
 HU Festőhenger  
 ES Rodillo de pintura



**VOREL**

No.	W [mm]	A [mm]	Ø [mm]	
09371	70	35	6	80
09372	100	35	6	70
09373	150	50	6	50

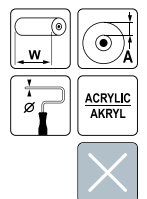

EN Paint roller refill  
 PL Zapas do walka  
 DE Ersatz Farbrolle  
 RU Шубка для валика

CZ Náhradní váleček  
 RO Rezerva trafalet  
 HU Pót festőhenger  
 ES Recambio de rodillo

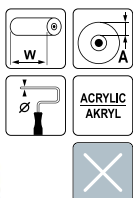

No.	W [mm]	A [mm]	Ø [mm]	
09310	180	20	6	10/40
09311	250	20	6	40

EN Paint roller refill  
 PL Zapas do walka  
 DE Ersatz Farbrolle  
 RU Шубка для валика

CZ Náhradní váleček  
 RO Rezerva trafalet  
 HU Pót festőhenger  
 ES Recambio de rodillo

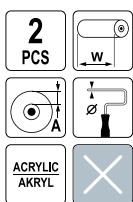

No.	W [mm]	A [mm]	Ø [mm]	
09338	100	9	6	150

EN Paint roller refill  
 PL Zapas do walka  
 DE Ersatz Farbrolle  
 RU Шубка для валика

CZ Náhradní váleček  
 RO Rezerva trafalet  
 HU Pót festőhenger  
 ES Recambio de rodillo

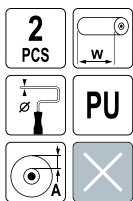

No.	W [mm]	A [mm]	Ø [mm]	
09375	50	35	6	200
09377	100	35	6	90
09378	150	50	6	45

EN Paint grid  
 PL Kratka malarska  
 DE Abstreifgitter  
 RU Решетка малярная  
 CZ Malířská mřížka  
 RO Grătar pt. trafalet  
 HU Festőrács  
 ES Rejilla de pintura



No.	[mm]	
09413	265x285	100

EN Paint roller refill  
 PL Zapas do walka  
 DE Ersatz Farbrolle  
 RU Шубка для валика

CZ Náhradní váleček  
 RO Rezerva trafalet  
 HU Pót festőhenger  
 ES Recambio de rodillo

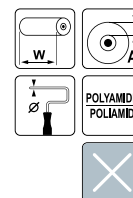

No.	W [mm]	A [mm]	Ø [mm]	
09331	180	6	6	10/50
09332	250	6	8	10/40

EN Paint roller refill  
 PL Zapas do walka  
 DE Ersatz Farbrolle  
 RU Шубка для валика

CZ Náhradní váleček  
 RO Rezerva trafalet  
 HU Pót festőhenger  
 ES Recambio de rodillo

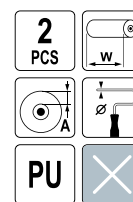

No.	W [mm]	A [mm]	Ø [mm]	
09363	50	35	6	75
09365	100	35	6	80

EN Paint tray  
 PL Kuweta malarska  
 DE Farbwanne  
 RU Ванночка малярная  
 CZ Malířská vanička  
 RO Tavă suport trafalet  
 HU Festéktálca  
 ES Cubeta para rodillo



No.	[mm]	
09406	150x245	75
09408	330x350	50

EN Paint roller with grid  
 PL Walek z kratką  
 DE Farbroller mit Abstreifgitter  
 RU Валик с решёткой  
 CZ Váleček s mřížkou  
 RO Trafalet cu grătar  
 HU Festőhenger ráccsal  
 ES Rodillo con rejilla

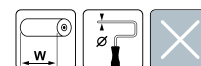

No.	W [mm]	Ø [mm]	
09385	180	6	25



EN Paint roller with tray  
 PL Walek z kuwetą  
 DE Farbroller mit Farbwanne  
 RU Валик с ванночкой  
 CZ Váleček s vaničkou  
 RO Trafalet cu tavă  
 HU Festőhenger és küvettával  
 ES Rodillo y cubeta

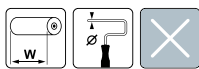

**VOREL**

No.	W [mm]	Ø [mm]	☐
09390	180	6	12

EN Roller frame  
 PL Uchwyt do wałka  
 DE Farbroller-Griff  
 RU Ручка для валика

CZ Držák válečku  
 RO Mâner trafalet  
 HU Festőhenger nyél  
 ES Mango de rodillo

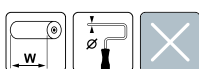

**VOREL**

No.	W [mm]	Ø [mm]	☐
09421	50/70	6	90
09422	100	6	90
09425	150	6	150
09427	180	6	110
09429	250	6	110
09430	250	8	80

EN Flat paint brush  
 PL Pędzel angielski profesjonalny  
 DE Professional Flachpinsel  
 RU Профессиональная кисть флейцевая тип Английский  
 CZ Anglický štětec profesionální  
 RO Pensulă englezască profesională  
 HU Profesionális laposecset  
 ES Brocha plana profesional

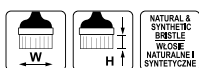

TOPS  
60



No.	W [mm]	H [mm]	☐
09531	25	51/46	50
09532	36	51/46	50
09533	50	57/52	50
09534	62	57/52	50
09535	75	57/52	50
09536	87	64/59	50
09537	102	64/59	50

EN Paint roller with tray  
 PL Walek z kuwetą  
 DE Farbroller mit Farbwanne  
 RU Валик с ванночкой  
 CZ Váleček s vaničkou  
 RO Trafalet cu tavă  
 HU Festőhenger és küvettával  
 ES Rodillo y cubeta

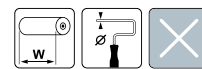

**VOREL**

No.	W [mm]	Ø [mm]	☐
09395	50	6	60

EN Flat paint brush  
 PL Pędzel angielski  
 DE Flachpinsel  
 RU Кисть флейцевая тип Английский  
 CZ Štětec anglický  
 RO Pensulă englezască  
 HU Laposecset  
 ES Brocha plana

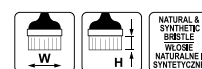

TOPS  
60



No.	W [mm]	H [mm]	☐
09521	25	44/39	50
09522	36	51/46	50
09523	50	51/46	50
09524	63	51/46	50
09525	76	51/46	50

EN Angled paint brush  
 PL Pędzel kaloryferowy  
 DE Heizkörperpinsel  
 RU Кисть радиаторная  
 CZ Štětec na topná tělesa  
 RO Pensulă pt. calorifere  
 HU Radiátorecset  
 ES Brocha angulada de radiadores



TOPS  
60



No.	W [mm]	H [mm]	☐
09560	25	44/39	50
09561	36	51/46	50
09562	50	51/46	50

- EN Round paint brush
- PL Pędzel okrągły
- DE Ringpinsel
- RU Кисть круглая
- CZ Kulatý štětec
- RO Pensula rotundă
- HU Marokécszet
- ES Brocha redonda



No.	W [mm]	H [mm]	
09581	20	44/39	50
09583	30	51/46	50
09585	40	51/46	50
09587	50	57/52	50
09589	60	57/52	50

- EN Paint brush
- PL Ławkowiec
- DE Malerbürste
- RU Кисть-макловица деревянная ручка
- CZ Natírací kartáč profesionální
- RO Bidinea profesională
- HU Profesionális kenőkefe
- ES Brocha prof.



No.	W [mm]	H [mm]	
09647	170x65	64/58	10
09648	180x75	70/64	10
09649	190x85	76/68	10

- EN Paint brushes
- PL Ławkowiec malarskie
- DE Pinselset
- RU Набор кистей
- CZ Sada malířských štětců
- RO Set pensule
- HU Festőecset készlet
- ES Brochas de pintar



No.	W [mm]	pcs / szt.	
09920	25, 36, 50	3	25/200
09930	36, 50, 63	3	40/160
09950	15, 25, 36, 50, 63	5	25/100

- EN Brush for wallpapers
- PL Pędzel do tapet
- DE Flächenstreicher
- RU Кисть-макловица деревянная ручка

- CZ Štětec na tapety dřevěný
- RO Bidinea profi pt. tapet
- HU Ecset fa tapétákhoz
- ES Brocha de empapelar madero

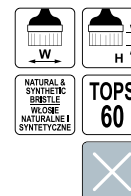

No.	W [mm]	H [mm]	
09636	110x30	51/46	30
09638	130x30	51/46	30
09640	140x40	57/52	30
09642	150x50	64/59	30

- EN Paint brush
- PL Chłapacz PCV
- DE Deckenbürste
- RU Кисть-макловица ПВХ
- CZ Smeták PVC
- RO Bidinea PVC
- HU PVC meszelő
- ES Brocha de PVC



No.	W [mm]	
09651	170x60	30

- EN Paint brush
- PL Ławkowiec PET
- DE Malerbürste
- RU Кисть-макловица PET
- CZ Natírací kartáč
- RO Bidinea
- HU Kenőkefe
- ES Brocha



**VOREL**

No.	W [mm]	
09655	150x70	12
09650	170x70	12
09656	180x80	10

- EN Brush for pitch CZ Kartáč asfaltérský  
 PL Smołowiec RO Perie pt. asfalt  
 DE Pechstein HU Kátránykenő kefe  
 RU Кисть для смолы ES Brocha para alquitrán



No.	W [mm]	
09653	170	30

- EN Sheet for construction works  
 PL Folia ochronna malarska  
 DE Abdeckplane  
 RU Плёнка защитная  
 CZ Stavební fólie  
 RO Folie pt. construcții  
 HU Építési fólia  
 ES Lona protectora

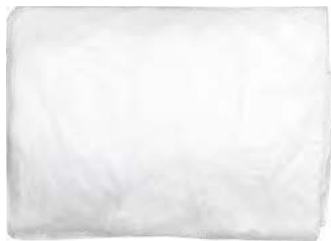

No.	[m]	Thickness / Grubość [µm]	Material / Material	
09462	4x5	5	HDPE	40
09463	4x5	15	LDPE	20

- EN Debris bags  
 PL Worki na gruz, mocne  
 DE Müllsäcke stabil  
 RU Мешки для строительного мусора  
 CZ Pytle na suť  
 RO Saci pt. demolari  
 HU Síttes zsák  
 ES Bolsas para escombros



No.	Capacity / Pojemność [l]	Thickness / Grubość [µm]	pcs / szt.	
09475	80	142	10	10
09476	80	142	3	10
09477	120	142	10	10
09478	120	142	3	10

- EN Waste bags for styrofoam CZ Pytle na polystyren  
 PL Worki na styropian RO Saci gunoi  
 DE Styropor Entsorgungssäcke HU Szemeteszsák  
 RU Пакеты для мусора строительные материалы ES Sacos de poliestireno

No.	Capacity / Pojemność [l]	Thickness / Grubość [µm]	pcs / szt.	
09472	240	40	10	10

- EN Magnetic paint brush holder  
 PL Uchwyt magnetyczny do pędzli  
 DE Magnethalter für Pinsel  
 RU Магнитный патрон для кистей  
 CZ Magnetický držák štětů  
 RO Suport magnetic pt. pensule zugravit  
 HU Mágneses ecsettartó  
 ES Soporte magnético para pinceles

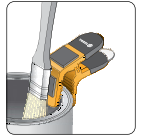
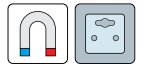

No.	L [mm]	
09590	90	24/96

- EN Sheet for construction works  
 PL Folia budowlana mocna  
 DE Abdeckplane  
 RU Плёнка защитная строительная повышенной прочности  
 CZ Stavební fólie  
 RO Folie pt. construcții  
 HU Építési fólia  
 ES Lona protectora



No.	[m]	Thickness / Grubość [µm]	
09457	4x5	20	15
09459	4x5	30	10

- EN Construction waste bags  
 PL Worki na odpady budowlane  
 DE Müllsäcke  
 RU Мешки для строительного мусора  
 CZ Pytle na stavební odpad  
 RO Saci gunoi pt. santier  
 HU Zsák építési törmelékhez  
 ES Bolsas para desperdicios de construcción



No.	Capacity / Pojemność [l]	Thickness / Grubość [µm]	pcs / szt.	
09470	80	40	10	30
09471	120	60	15	10



EN Self adhesive paper tape  
 PL Taśma papierowa samoprzylepna  
 DE Papierband selbstklebend  
 RU Лента малярная бумажная

CZ Páska papírová samolepící  
 RO Banda adezivă hartie  
 HU Őntapadó papírszalag  
 ES Cinta de papel autoadhesiva

25m 50m



No.	W [mm]	L [m]	<input type="checkbox"/>
75270	19	25	12/48
75271	25	25	9/36
75272	30	25	10/40
75273	38	25	6/24
75274	48	25	6/24
75285	25	50	9/36
75286	30	50	10/40
75287	38	50	6/24
75288	48	50	6/24

EN Plastering tape  
 PL Taśma tynkarska elewacyjna  
 DE Putzband  
 RU Штукатурные лента  
 CZ Fasádní omítková páska  
 RO Banda mascare pt. tencuieli  
 HU Homlokzati festő szalag  
 ES Cinta de enlucido de fachada

20m 50m



No.	W [mm]	L [m]	<input type="checkbox"/>
75130	38	20	24
75131	48	20	24
75132	38	50	28
75133	48	50	24

EN Packing tape, brown  
 PL Taśma pakowa brązowa  
 DE Verpackungsband aus PP, braun  
 RU Упаковочная клейкая лента  
 CZ Balící páska PP hnědá  
 RO Bandă ambalare PP maro  
 HU PP barna ragasztószalag  
 ES Cinta de embalaje marrón

OPP



No.	W [mm]	L [m]	<input type="checkbox"/>
75301	48	40	36
75302	48	66	36

EN Packing tape  
 PL Taśma pakowa  
 DE Band  
 RU Упаковочная клейкая лента  
 CZ Balící páska  
 RO Banda scotch  
 HU Csomagolószalag  
 ES Cinta de embalaje

No.	W [mm]	L [m]	<input type="checkbox"/>
75300	48	45	12/36

EN Blue masking tape  
 PL Taśma maskująca, niebieska  
 DE Malerei blau Tape  
 RU Малярна стрічка

CZ Maskovací páska  
 RO Bandă de mascare  
 HU Fedőszalag  
 ES Cinta adhesiva azul

25m 50m



No.	W [mm]	L [m]	<input type="checkbox"/>
75120	30	25	40
75121	38	25	24
75122	48	25	24
75123	30	50	40
75124	38	50	24
75125	48	50	24

EN „DUCT” tape  
 PL Taśma tekstylna „DUCT”  
 DE Textilband „DUCT”  
 RU Лента армированная на тканевой основе  
 CZ Textilní páska „DUCT”  
 RO Bandă textilă „DUCT”  
 HU „DUCT” textil szalag  
 ES Cinta textil „DUCT”

DUCT



No.	W [mm]	L [m]	<input type="checkbox"/>
75238	48	10	24
75239	38	50	28
75240	48	50	24

EN Packing tape, transparent  
 PL Taśma pakowa przezroczysta  
 DE Verpackungsband aus PP, durchsichtig  
 RU Упаковочная клейкая лента

CZ Balící páska PP průhledná  
 RO Bandă ambalare PP transparentă  
 HU Átlátszó ragasztószalag  
 ES Cinta de embalaje transparente

OPP



No.	W [mm]	L [m]	<input type="checkbox"/>
75303	48	40	36
75304	48	66	36





EN Bucket  
 PL Wiadro  
 DE Eimer  
 RU Ведро  
 CZ Vědro  
 RO Galeată  
 HU Vödör  
 ES Cubo



No.	Capacity / Pojemność [l]	
06388	10	900
06390	12	680
06383	13	800
06393	16	450
06392	20	390
06384	21	400

EN Painting bucket  
 PL Wiadro malarskie  
 DE Malereimer  
 RU Ведро малярное  
 CZ Vědro malářské  
 RO Galeată pt. vopsea  
 HU Festővödör  
 ES Cubo para pintar



No.	Capacity / Pojemność [l]	Dimensions / Wymiary [mm]	
09400	14	360x250x225	315

EN Tub for mass mixing  
 PL Kastrą budowlaną  
 DE Mörtelkasten  
 RU Кювета для перемешивания раствора

CZ Stavební vědro  
 RO Vas plastic constructii  
 HU Kőműves vödör  
 ES Caba de obra



No.	Capacity / Pojemność [l]	
06394	40	210
06395	60	210
06396	90	120

EN Bucket  
 PL Wiadro  
 DE Eimer  
 RU Ведро  
 CZ Vědro  
 RO Galeată  
 HU Vödör  
 ES Cubo



No.	Capacity / Pojemność [l]	
06391	12	720
06381	16	420
06382	20	500

EN Tub for mass mixing  
 PL Kastrą budowlaną  
 DE Mörtelkasten  
 RU Таз строительный круглый  
 CZ Stavební vědro  
 RO Vas plastic constructii  
 HU Kőműves vödör  
 ES Caba de obra



No.	Capacity / Pojemność [l]	
06397	40	110
06398	65	100
06399	90	160

EN Construction and garden bucket  
 PL Kubel budowlano-ogrodowy  
 DE Bau- und Gartenbehälter  
 RU Строительный и садовый контейнер  
 CZ Stavební a zahradní nádoba  
 RO Galeată pt. gradina si constructii  
 HU Építőipari és kerti vödör  
 ES Espuerta para obra y jardín



No.	Capacity / Pojemność [l]	
06338	40	150

EN Suction lifter  
 PL Uchwyt-przyssawka do szyb  
 DE Glas-Gummissauger  
 RU Держатель-присоска для стекол  
 CZ Podtlakový držák na sklo  
 RO Ventuza  
 HU Szélvédő kiemelő  
 ES Elevador tipo ventosa



No.	Ø [mm]	Max. lifting capacity / Maks. udźwig [kg]	
05300	115	40	48

EN Suction lifter  
 PL Uchwyt-przyssawka do szyb  
 DE Glas-Gummissauger  
 RU Держатель-присоска для стекол тройная  
 CZ Podtlakový držák na sklo  
 RO Ventuze  
 HU Szélvédő kiemelő  
 ES Elevador tipo ventosa



No.	Ø [mm]	Max. lifting capacity / Maks. udźwig [kg]	
05302	115	100	12

EN Suction lifter  
 PL Uchwyt-przyssawka do szyb  
 DE Glas-Gummissauger  
 RU Держатель-присоска для стекол двойная  
 CZ Podtlakový držák na sklo  
 RO Ventuza  
 HU Szélvédő kiemelő  
 ES Elevador tipo ventosa



No.	Ø [mm]	Max. lifting capacity / Maks. udźwig [kg]	
05312	115	70	10

EN Pump suction cup  
 PL Uchwyt-przyssawka  
 DE Saugheber  
 RU Держатель-присоска  
 CZ Vakuový držák  
 RO Ventuza cu pompa  
 HU Vákuumos tapadókorong  
 ES Ventosa bomba de vacío



No.	Ø [mm]	Max. lifting capacity / Maks. udźwig [kg]	
05325	204	100	10

EN Suction lifter  
 PL Uchwyt-przyssawka do szyb  
 DE Glas-Gummissauger  
 RU Держатель-присоска для стекол двойная  
 CZ Podtlakový držák na sklo  
 RO Ventuze  
 HU Szélvédő kiemelő  
 ES Elevador tipo ventosa

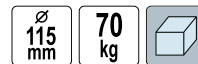

No.	Ø [mm]	Max. lifting capacity / Maks. udźwig [kg]	
05301	115	70	24

EN Suction lifter  
 PL Uchwyt-przyssawka do szyb  
 DE Glas-Gummissauger  
 RU Держатель-присоска для стекол  
 CZ Podtlakový držák na sklo  
 RO Ventuza  
 HU Szélvédő kiemelő  
 ES Elevador tipo ventosa

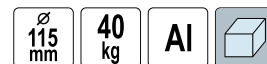

No.	Ø [mm]	Max. lifting capacity / Maks. udźwig [kg]	
05311	115	40	50

EN Pump suction cup  
 PL Uchwyt-przyssawka  
 DE Saugheber  
 RU Держатель-присоска  
 CZ Vakuový držák  
 RO Ventuza cu pompa  
 HU Vákuumos tapadókorong  
 ES Ventosa bomba de vacío

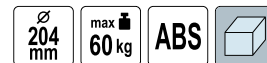

No.	Ø [mm]	Max. lifting capacity / Maks. udźwig [kg]	
05319	204	60	10



EN Hook  
 PL Hak budowlany  
 DE Mauerhaken  
 RU Крюк строительный  
 CZ Stavební hák  
 RO Cârlig de construcții  
 HU Építőipari horog  
 ES Gancho de obra



**JUCO**

No.		
34950		25

EN Deep hole pencil with leads  
 PL Ołówek do głębokich otworów z rysikami  
 DE Tieflochmarker mit Ersatzminen  
 RU Карандаш для глубоких отверстий со сменными стержнями  
 CZ Tužka do hlubokých otvorů s náhradními náplněmi  
 RO Marker pt. orificii adanci  
 HU Mélylyuk jelölő hegyekkel  
 ES Lápiz para orificios profundos con puntas de trazar

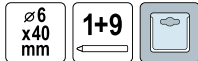

**VOREL**

No.		
09200		10/100

EN Wax refills for automatic pencil  
 PL Zestaw rysików woskowych do markera  
 DE Ersatzwachsmineinsatz für Marker  
 RU Набор восковых стержней для маркера  
 CZ Voskové náplně do automatické tužky  
 RO Rezervă de ceară pt. creion automat  
 HU Tartalék hegy szett automata ceruzához  
 ES Conjunto de rellenos de cera para marcador



**VOREL**

No.	For / Dla	pcs / szt.	
09207	09204	10	10/100

EN Wire tying twister hook  
 PL Klucz do wiązania drutu zbrojeniowego  
 DE Rödeldraht-Drillkurbel  
 RU Крючок для вязки арматуры  
 CZ Radlovačka  
 RO Dispozitiv pt. legat fier beton  
 HU Huzalsodró  
 ES Gancho para amarrar alambre



**VOREL**

No.	L [mm]	
49830	240	20

EN Carpenter's pencil  
 PL Ołówek stolarski  
 DE Zimmermannsbleistift  
 RU Карандаш столярный  
 CZ Tesařská tužka  
 RO Creion de tâmplărie  
 HU Asztalos ceruza  
 ES Lápiz de carpintero



No.	L [mm]	pcs / szt.	
09180	180	12	60/240

EN Automatic wax pencil  
 PL Marker woskowy automatyczny  
 DE Automatischer Wachsmarker  
 RU Маркер восковой автоматический  
 CZ Automatická vosková tužka  
 RO Creion automat cu ceară  
 HU Automata viasz ceruza  
 ES Marcador de cera automático

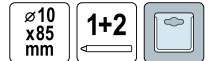

**VOREL**

No.		
09204		10/100

EN Carpenter's pencil sharpener  
 PL Temperówka do ołówek stolarskich  
 DE Zimmermann-Bleistift-Anspitzer  
 RU Точилка для столярных карандашей  
 CZ Ořezávkto na tesařskou tužku  
 RO Ascuzitoare pt. creioane de tamplarie  
 HU Ceruzahegyező  
 ES Sacapuntas para lápiz de carpintero



**VOREL**

No.		
09190		40/240

EN Sheet metal bending machine  
 PL Giętarka do blach  
 DE Blechbiegemaschine  
 RU Гибочный станок для листового металла  
 CZ Ohýbačka plechu  
 RO Mașină de îndoit tablă  
 HU Lemezhajlító gép  
 ES Plegadora de chapa

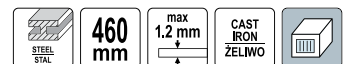

**VOREL**

No.	Working width / Szerokość robocza [mm]	
49900	460	1

- EN Rebar bender
- PL Klucz do gięcia prętów
- DE Betonstahl-Bieger
- RU Ручной ключ для гибки арматуры
- CZ Klíč pro ohýbání tyčí
- RO Dispozitiv indoit fier beton
- HU Kézi betonacél hajlító
- ES Dobladora manual de barras

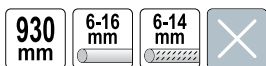

No.	L [mm]	
49810	930	4

- EN Rebar bender
- PL Giętarka do prętów
- DE Betonstahl-Bieger
- RU Станок для гибки арматуры
- CZ Ohýbačka tyčí
- RO Dispozitiv indoit sârmă
- HU Betonvas hajlító
- ES Dobladora de barras



No.	Ø [mm]	Dimensions / Wymiary [mm]	
49800	6-8	16x12x5	4
49801	10-12	25x16x6	4
49802	14-16	25x16x6	2

- EN Rod extractor
- PL Wyciągacz do prętów
- DE Stangenauszieher
- RU Ручной вытягиватель прутка
- CZ Vytahovač tyčí
- RO Extractor tije
- HU Rúdkihúzó
- ES Extractor de varillas



No.	Rod diameter / Średnica pręta [mm]	
35007	8-28	6

- EN Rebar bender
- PL Giętarka do prętów
- DE Betonstahl-Bieger
- RU Станок для гибки арматуры
- CZ Ohýbačka tyčí
- RO Dispozitiv indoit sârmă
- HU Betonvas hajlító
- ES Dobladora de barras

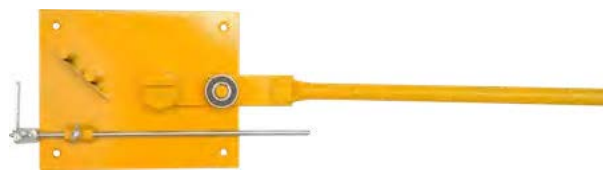

No.	Ø [mm]	Dimensions / Wymiary [mm]	Bearing / Łożysko [mm]	
49805	6-8	17x17x5	35x15	2
49806	10-14	25x20x5	45x20	2

- EN Hand tamper
- PL Ubijak brukarski
- DE Pflasterstampfer
- RU Ручная трамбовка для уплотнения грунта
- CZ Pěchovadlo na pokládku dlažby
- RO Tamper de mână
- HU Kézi döngölő
- ES Compactador manual de adoquines



No.	
35000	1

- EN Longitudinal clamp
- PL Chwytnak brukarski wzdlużny regulowany
- DE Bordstein-Verlegezange
- RU Захват-клещи для бордюра продольные
- CZ Kleště na obrubníky podélné
- RO Cleste pt. borduri
- HU Hosszírányúszegélykő emelő fogó
- ES Pinza de colocación de rebordes mecánica



No.	Grip range / Zakres chwytu [mm]	
35010	980-1170	2



EN Lateral clamp  
 PL Chwytek poprzeczny, podwójny  
 DE Bordsteinverlegezange  
 RU Захват-клевщи для бордюра поперечные

CZ Kleště na obrubníky příčné  
 RO Cleste pt. borduri  
 HU Keresztirányúszegélykő emelő fogó  
 ES Pavimentación pinza doble



**VOREL**

No.	Grip range / Zakres chwytu [mm]	
35012	90-360	2

EN Grapple for cobblestones  
 PL Chwytek zbiorczy do kostki brukowej  
 DE Pflastersteinträger  
 RU Захват ручной для переноса бордюрного камня и блоков

CZ Nosič na cihly  
 RO Cleste pt. borduri  
 HU Emelő fogó  
 ES Pinza para bordillos longitudinal

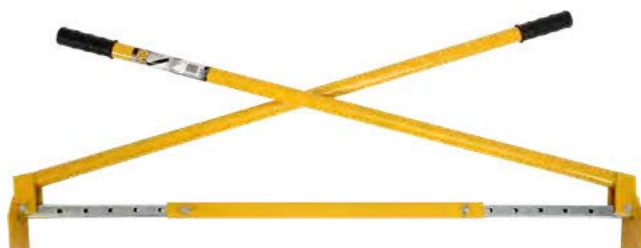

**VOREL**

No.	Grip range / Zakres chwytu [mm]	
35015	700-1100	4

EN Brick tongs  
 PL Chwytek do podnoszenia płyt lub cegieł  
 DE Greifer zum Heben von Platten oder Ziegeln  
 RU Захват для подъема плит или кирпича  
 CZ Nástroj pro přenášení desek a cihel  
 RO Cleste caramida  
 HU Csempe- és téglafogó  
 ES Pinzas para transportar placas o ladrillos

410-680  
mm



**VOREL**

No.	Grip range / Zakres chwytu [mm]	
35018	410-680	12

EN Rubber for lateral clamp  
 PL Zapasowe końcówki do chwyta  
 DE Ersatzgummi für Bordsteinverlegezange  
 RU Запасные наконечники  
 CZ Náhradní gumový úchyt  
 RO Mânere de cauciuc de rezervă  
 HU Gumi alkatrészek  
 ES Punta de repuesto

4  
PCS



**VOREL**

No.	For / Dla	pcs / szt.	
35013	35012	4	10

EN Paving slab lifter  
 PL Chwytek brukarski wysoki  
 DE Hoher Pflastergreifer  
 RU Захват для бордюра  
 CZ Držák na dlažební kostky  
 RO Dispozitiv pt. ridicat dale de pavaj  
 HU Magas térkökiemelő  
 ES Pinza para adoquines alta



**VOREL**

No.	Grip range / Zakres chwytu [mm]	
35014	220-500	5

EN Slabgrabber  
 PL Chwytek brukarski jednoręczny regulowany  
 DE Pflasterstein- und Klinker-Träger  
 RU Захваты для тротуарной плитки кирпича, блоков  
 CZ Kleště na dlažbu a cihly  
 RO Cleste pt. caramizi  
 HU Burkolólap fogó  
 ES Pinza de colocación de losas



**VOREL**

No.	Grip range / Zakres chwytu [mm]	
35017	255-400	4

EN Paver puller  
 PL Imak brukarski regulowany  
 DE Steinzieher-Steinheber  
 RU Захват для камня

CZ Kleště na vytahování dlažby  
 RO Ridicator de pavele  
 HU Tértőkíemelő szerszám  
 ES Extractor de adoquines



**VOREL**

No.	Grip range / Zakres chwytu [mm]	
35020	80-275	4

EN Blades for paver puller  
 PL Zapasowe ostrza do imaka  
 DE Ersatzklingen für Steinzieher-Steinheber  
 RU Запасные лезвия  
 CZ Náhradní čepele  
 RO Tartalék penge  
 HU Lame de rezerva  
 ES Cuchillas de repuesto



No.	For / Dla	pcs / szt.	
35021	35020	2	20

EN Blade for paver adjuster  
 PL Ostrze do łomu brukarskiego  
 DE Ersatzklingen für Richtleisen  
 RU Запасные лезвия  
 CZ Náhradní čepele  
 RO Lame de rezerva  
 HU Tartalék penge  
 ES Cuchillas de repuesto



No.	For / Dla	
35026	35025	20

11

EN Paver lifter  
 PL Zgarniacz brukarski do podsypki  
 DE Plan-Abzieher für Pflasterbau  
 RU Правило для выравнивания основания под тротуарную плитку  
 CZ Stahovací lišta  
 RO Sistem de nivelare manuala  
 HU Ágyazat lehűző rendszer  
 ES Sistema de enrasado manual

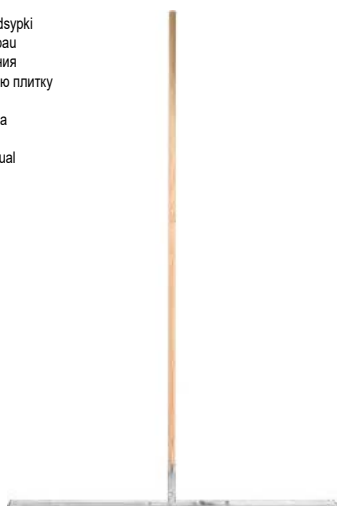

No.	L [cm]	
35033	75	1
35032	120	1

EN Garden paving stone mould  
 PL Forma do kostki brukowej  
 DE Pflasterform  
 RU Форма для брусчатки  
 CZ Forma pro dlažební kostky  
 RO Matrita pt. pavaje  
 HU Térkő-minta sablon  
 ES Plantilla para adoquines



No.	Dimensions / Wymiary [mm]	
35060	430x425x40	10

EN Paver adjuster  
 PL Łom wyważak brukarski  
 DE Richtleisen für Pflasterbau  
 RU Лом с упором для демонтажа тротуарной плитки  
 CZ Tyč pro opravu dlažby  
 RO Bara de aliniere pavaj  
 HU Térkő sorrendező  
 ES Barra alineadora de adoquines



No.	
35025	4

EN Paver lifter  
 PL Zgarniacz brukarski do podsypki  
 DE Plan-Abzieher für Pflasterbau  
 RU Правило для выравнивания основания под тротуарную плитку  
 CZ Stahovací lišta  
 RO Sistem de nivelare manuala  
 HU Ágyazat lehűző rendszer  
 ES Sistema de enrasado manual

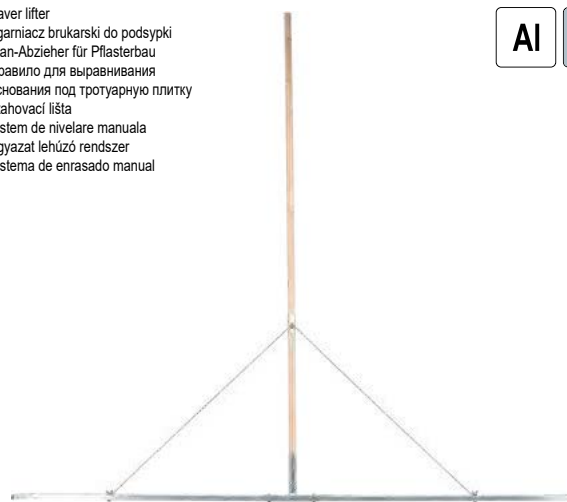

No.	L [cm]	
35031	150	1
35030	200	1

EN Garden paving stone mould  
 PL Forma do kostki brukowej  
 DE Pflasterform  
 RU Форма для брусчатки

CZ Forma pro dlažební kostky  
 RO Matrita pt. pavaje  
 HU Térkő-minta sablon  
 ES Plantilla para adoquines

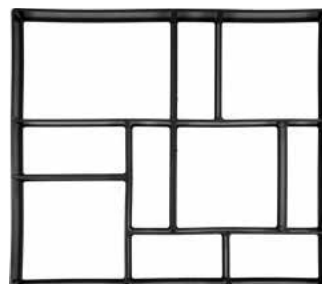
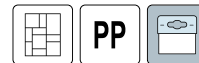

No.	Dimensions / Wymiary [mm]	
35061	450x400x40	10

EN Garden paving stone mould  
 PL Forma do kostki brukowej  
 DE Pflasterform  
 RU Форма для брусчатки  
 CZ Forma pro dlažební kostky  
 RO Matrita pt. pavaje  
 HU Térkő-minta sablon  
 ES Plantilla para adoquines

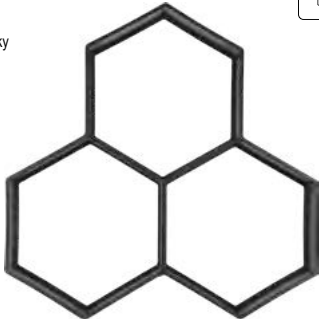

No.	Dimensions / Wymiary [mm]	
35062	360x360x40	10

EN Garden paving stone mould  
 PL Forma do kostki brukowej  
 DE Pflasterform  
 RU Форма для брусчатки  
 CZ Forma pro dlažební kostky  
 RO Matrita pt. pavaje  
 HU Térkő-minta sablon  
 ES Plantilla para adoquines



No.	Dimensions / Wymiary [mm]	
35064	400x400x40	10

EN Garden paving stone mould  
 PL Forma do kostki brukowej  
 DE Pflasterform  
 RU Форма для брусчатки  
 CZ Forma pro dlažební kostky  
 RO Matrita pt. pavaje  
 HU Térkő-minta sablon  
 ES Plantilla para adoquines

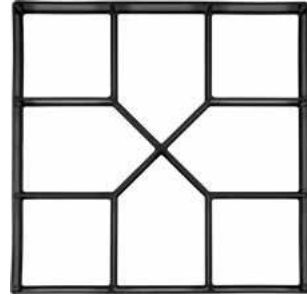

No.	Dimensions / Wymiary [mm]	
35063	400x400x40	10

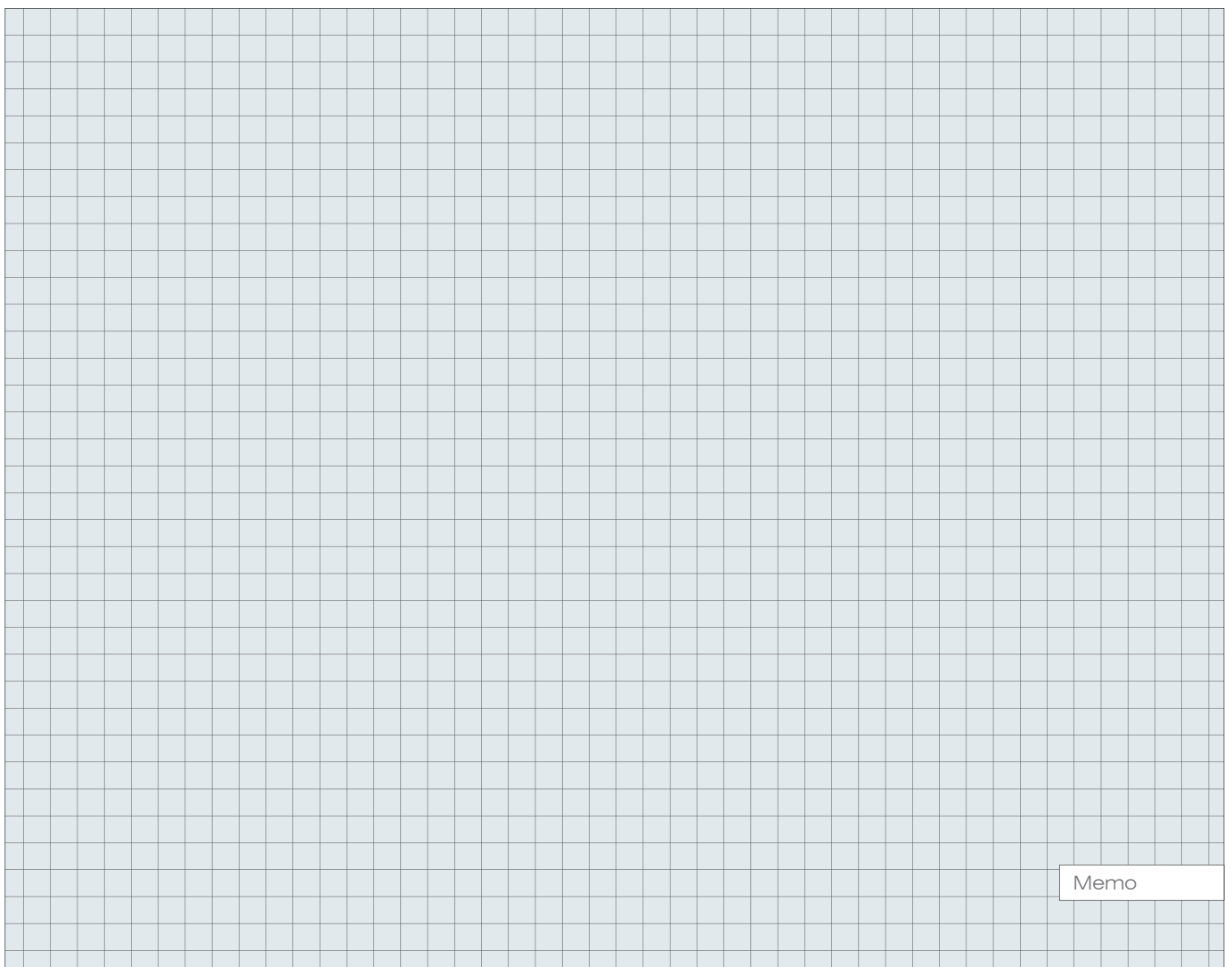
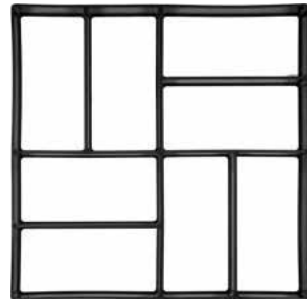

Memo

# 12

## Measuring tools Narzędzia miernicze





**Measuring tapes**  
 Miary zwijane

188-189

**Wooden folding rules**  
 Miary składane drewniane

189

**Plastic folding rules**  
 Miary składane z tworzywa

189

**Feeler gauges**  
 Szczelinomierze

189

**Vernier calipers**  
 Suwmiarki

189-190

**Chalk lines**  
 Sznury traserskie

190-191

**Ropes**  
 Sznury

191-192

**Plumb bobs**  
 Piony murarskie

192-193

**Try squares**  
 Kątowniki stolarskie

193-195

**Rulers**  
 Przymiary

196

**Electronic measuring tools**  
 Elektroniczne urządzenia pomiarowe

196-199

**Levels**  
 Poziomnice

199-200

**Scales**  
 Wagi

200-201

**Magnifiers**  
 Lupy

201



EN Measuring tape  
 PL Miara zwijana  
 DE Rollbandmass  
 RU Пынетка  
 CZ Měřicí pásmo  
 RO Rulete din  
 HU Mérőszalag  
 ES Flexometro



No.	L [m]	W [mm]	
10101	2.0	16	12/120
10104	3.0	16	12/120
10106	5.0	16	12/120
10109	7.5	19	6/60
10111	10.0	25	6/60

EN Measuring tape  
 PL Miara zwijana  
 DE Rollbandmass  
 RU Пынетка  
 CZ Měřicí pásmo  
 RO Rulete din  
 HU Mérőszalag  
 ES Flexometro



No.	L [m]	W [mm]	
10122	2.0	16	12/120
10123	3.0	16	12/120
10125	5.0	19	12/120
10128	7.5	25	6/60
10129	10.0	25	6/60

EN Steel measuring tape  
 PL Taśma miernicza stalowa  
 DE Rollbandmass  
 RU Мерная лента стальная  
 CZ Měřicí pásmo ocelové  
 RO Ruleta din oțel  
 HU Acél mérőszalag  
 ES Cinta de medir de acero



No.	L [m]	W [mm]	
12100	10	10	25/50
12200	20	10	25/50
12300	30	10	10/30
12500	50	10	10/30

EN Measuring tape  
 PL Miara zwijana  
 DE Rollbandmass  
 RU Пынетка  
 CZ Měřicí pásmo  
 RO Rulete din pinza  
 HU Mérőszalag  
 ES Flexometro



No.	L [m]	W [mm]	
10061	3.0	16	12/120
10062	5.0	19	12/120
10063	5.0	25	12/96
10064	7.5	25	6/72
10065	10.0	25	6/60

EN Measuring tape  
 PL Miara zwijana  
 DE Rollbandmass  
 RU Пынетка  
 CZ Měřicí pásmo  
 RO Rulete din  
 HU Mérőszalag  
 ES Flexometro



No.	L [m]	W [mm]	
10130	2.0	16	12/120
10133	3.0	16	12/120
10135	5.0	16	12/120
10138	8.0	25	6/60
10139	10.0	25	6/60

EN Steel measuring tape  
 PL Taśma miernicza stalowa, geodezyjna  
 DE Rollbandmass  
 RU Мерная лента стальная геодезическая

CZ Měřicí pásmo ocelové  
 RO Ruleta cu picior  
 HU Acél mérőszalag  
 ES Cinta de mednir de acero geodezico



No.	L [m]	
13200	20	10/20
13300	30	10/20
13500	50	10/20

- EN Fibreglass measuring tape  
 PL Taśma miernicza z włókna szklanego  
 DE Rollbandmass  
 RU Мерная лента фиброглассовая
- CZ Měřicí pásmo (skleněné vlákno)  
 RO Ruleta fibra sticla  
 HU Üvegszálás mérőszalag  
 ES Cinta de medir de fibra de vidrio



No.	L [m]	Package	
14100	10		20/100
14200	20		12/60
14300	30		12/60
14500	50		10/30

- EN Wooden folding rule  
 PL Miara drewniana, składana, okuta  
 DE Gliedermaßstab  
 RU Метр складной деревянный  
 CZ Měřicí pásmo dřevěné skladané (okované)  
 RO Metru tamplar lemn  
 HU Összehajtható fa mérőlécc  
 ES Metro de madera, plegable (articulado)



No.	L [m]	Series / Seria	
15004	1	PERFECT B-Z	20/200
15006	2	PERFECT B-Z	10/100

- EN Plastic folding rule  
 PL Miara plastikowa  
 DE Kunststoffgliedmaßstab  
 RU Метр складной пластмассовый  
 CZ Měřicí pásmo plastové skladané  
 RO Metru de plastic  
 HU Műanyag, összecsuksukható mérce  
 ES Metro de plástico, plegable



No.	L [m]	
15050	1	20/200
15070	2	12/120

- EN Plastic caliper  
 PL Suwmiarka plastikowa  
 DE Kunststoff-Bremssattel  
 RU Штангенциркуль пластиковый  
 CZ Plastové posuvné měřítko  
 RO Subler masurat sprancene  
 HU Műanyag tolomerő  
 ES Calibre vernier regla, plástico



- EN Wooden folding rule  
 PL Miara drewniana, składana, okuta  
 DE Gliedermaßstab  
 RU Метр складной деревянный
- CZ Měřicí pásmo dřevěné skladané (okované)  
 RO Metru tamplar lemn  
 HU Összehajtható fa mérőlécc  
 ES Metro de madera, plegable (articulado)



No.	L [m]	
15010	1	24/480
15020	2	12/240

- EN Wooden folding rule  
 PL Miara drewniana, składana, okuta  
 DE Gliedermaßstab  
 RU Метр складной деревянный  
 CZ Měřicí pásmo dřevěné skladané (okované)  
 RO Metru tamplar lemn  
 HU Összehajtható fa mérőlécc  
 ES Metro de madera, plegable (articulado)



No.	L [m]	Series / Seria	
15005	1	PERFECT B	20/200
15007	2	PERFECT B	10/100

- EN Feeler  
 PL Szczelinomierz  
 DE Fühlerlehre  
 RU Щупы  
 CZ Spároměr  
 RO Lere  
 HU Hézagmérő  
 ES Calibre de fisuras



No.	Gauge thickness / Grubość listka [mm]	Gauge quantity / Liczba listków	
15130	0.05, 0.10, 0.15, 0.20, 0.25, 0.30, 0.40, 0.50, 0.60, 0.70, 0.80, 0.90, 1.0	13	15/300
15200	0.05, 0.10, 0.15, 0.20, 0.25, 0.30, 0.35, 0.40, 0.45, 0.50, 0.55, 0.60, 0.65, 0.70, 0.75, 0.80, 0.85, 0.90, 0.95, 1.0	20	10/200



No.	Measuring range / Zakres pomiaru [mm]	Measurement accuracy / Dokładność pomiarowa [mm]	
15120	0-150	± 0.05	50/500

- EN Vernier caliper
- PL Suwmiarka
- DE Messschieber
- RU Штангенциркуль
- CZ Posuvné měřítko
- RO Șubler
- HU Tolómérő
- ES Calibre



0-150 mm    +/- 0.02 mm    mm inch   



No.	Measuring range / Zakres pomiaru [mm]	Measurement accuracy / Dokładność pomiarowa [mm]	
15115	0-150	± 0.02	10/100

- EN Vernier caliper
- PL Suwmiarka
- DE Messschieber
- RU Штангенциркуль
- CZ Posuvné měřítko
- RO Șubler
- HU Tolómérő
- ES Calibre

0-150 mm

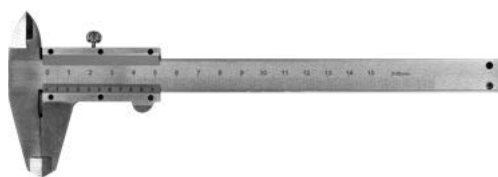

- EN Dial caliper
- PL Suwmiarka zegarowa
- DE Präzisions-Uhrmessschieber
- RU Штангенциркуль стрелочный
- CZ Posuvné měřítko hodinové
- RO Șubler cu cadran
- HU Órás tolómérő
- ES Calibre dial

0-150 mm    +/- 0.02 mm   



No.	Measuring range / Zakres pomiaru [mm]	Measurement accuracy / Dokładność pomiarowa [mm]	Package	
15110	0-150	± 0.02		10/100
15100	0-150	± 0.05		10/100

- EN Digital caliper
- PL Suwmiarka elektroniczna
- DE Digital Messschieber
- RU Электронный штангенциркуль
- CZ Posuvné měřítko elektronické
- RO Șubler electronic
- HU Elektronikus tolómérő
- ES Calibre electrónico

0-150 mm    +/- 0.03 mm   



No.	Measuring range / Zakres pomiaru [mm]	Measurement accuracy / Dokładność pomiarowa [mm]	
15220	0-150	± 0.02	10/50

- EN Carbon fibre vernier caliper
- PL Suwmiarka elektroniczna z włókna węglowego
- DE Elektronischer Messschieber aus Kohlefaser
- RU Электронный штангенциркуль из углеродного волокна
- CZ Elektronické posuvné měřidlo z uhlíkového vlákna
- RO Șubler din carbon
- HU Elektromos szénszálas tolómérő
- ES Calibre electrónico de fibra de carbono

0-150 mm    +/- 0.2 mm    mm inch

LCD    CARBON FIBER WŁOKNO WĘGLOWE    1x LR44



No.	Measuring range / Zakres pomiaru [mm]	Measurement accuracy / Dokładność pomiarowa [mm]	
15240	0-150	± 0.03	10/40

- EN Chalk line
- PL Sznur traserski
- DE Schnurlot
- RU Шнур-отвес малярный
- CZ Orýsovací šňůra
- RO Șnur de trasat
- HU Kicsapózsínor
- ES Cordel tizador

15m   



No.	Measuring range / Zakres pomiaru [mm]	Measurement accuracy / Dokładność pomiarowa [mm]	
15113	0-150	± 0.2	25/100

- EN Chalk line
- PL Sznur traserski
- DE Schnurlot
- RU Шнур-отвес малярный
- CZ Orýsovací šňůra
- RO Șnur de trasat
- HU Kicsapózsínor
- ES Cordel tizador

15m    Al   



Battery not included  
Baterii nie dołączono

No.	L [m]	
17500	15	10/100



No.	L [m]	
17501	15	10/100



EN Chalk line & blue chalk  
 PL Sznur traserski z kredą niebieską  
 DE Schlagschnur mit Kreide  
 RU Шнур-отвес малярный + краска  
 CZ Orýsovací šňůra  
 RO Fir trasare si praf de creta albastra  
 HU Kicsapozsínór  
 ES Cordel tizador con tiza azul

15m 115g



No.	L [m]	m [g]	
17505	15	115	10/60

EN Blue/red chalk  
 PL Kreda traserska  
 DE Kreide blau/rot  
 RU Краска для шнура  
 CZ Křída trasovací  
 RO Praf de creta pt. trasat  
 HU Jelölő krétapör  
 ES Tiza azul/rojo

115g



No.	m [g]	Color / Kolor	
17507	115	niebieski	20/80
17508	115	czerwony	20/80

EN Builders line  
 PL Sznurek murarski  
 DE Maurerschnur  
 RU Шнур - причалка  
 CZ Šňůra zednická  
 RO Sfoară pt. zidari  
 HU Kőműves zsinór  
 ES Cuerda de albañil

75m EASY ROLL-UP ŁATWE ZWIJANIE  
 PE



No.	L [m]	
17495	75	12/48

EN Builders line  
 PL Sznurek murarski  
 DE Maurerschnur  
 RU Шнур - причалка  
 CZ Šňůra zednická  
 RO Sfoară pt. zidari  
 HU Kőműves zsinór  
 ES Cuerda de albañil

EASY ROLL-UP ŁATWE ZWIJANIE  
 PP



No.	Ø [mm]	L [m]	
17498	1.2	200	12/48

EN Chalk line  
 PL Sznur traserski w pojemniku  
 DE Schlagschnurroller  
 RU Шнур для разметки в контейнере  
 CZ Značkovácí provázek v obalu  
 RO Fir trasat cu creta  
 HU Jelölőzsinór dobozban  
 ES Tiralineas para marcar

30m ABS  
 SPEEDY RETRACTING SZYBKE ZWIJANIE



No.	L [m]	
17506	30	12/48

EN Builders line  
 PL Sznurek murarski  
 DE Maurerschnur  
 RU Шнур - причалка  
 CZ Šňůra zednická  
 RO Sfoară pt. zidari  
 HU Kőműves zsinór  
 ES Cuerda de albañil

40m



No.	L [m]	
17490	40	80

EN Builders line  
 PL Sznurek murarski  
 DE Maurerschnur  
 RU Шнур - причалка  
 CZ Šňůra zednická  
 RO Sfoară pt. zidari  
 HU Kőműves zsinór  
 ES Cuerda de albañil

EASY ROLL-UP ŁATWE ZWIJANIE  
 PP



No.	Ø [mm]	L [m]	
17497	1.2	75	12/48

EN Builders line  
 PL Sznurek murarski  
 DE Maurerschnur  
 RU Шнур - причалка  
 CZ Šňůra zednická  
 RO Sfoară pt. zidari  
 HU Kőműves zsinór  
 ES Cuerda de albañil



No.	L [m]	Color / Kolor	
17488	50	żółty	60
17489	100	żółty	60

EN Polypropylene bricklayer's string  
 PL Sznurek murarski polipropylenowy  
 DE Maurerschnur aus Polypropylen  
 RU Шнур каменщика  
 CZ Šňůra zednická polypropylenová  
 RO Șnur de zidărie din polietilena  
 HU Kőműves zsinór polipropilén  
 ES Cordel de albañilería



No.	Ø [mm]	L [m]	
17470	1.7	50	60/240
17471	1.7	100	30/120
17473	2.0	50	60/240
17474	2.0	100	30/120

EN Line blocks with brick lines  
 PL Uchwyty kątowe do linki murarskiej  
 DE Maurerschnur Spannklotze mit Richtschnur  
 RU Строительные уголки для причального шнура  
 CZ Stavební rožky pro zednické provázky  
 RO Dispozitiv pt. aliniere caramizi  
 HU Építési rudak falazott húrokhoz  
 ES Pareja de angulares para cuerda de albañil acha

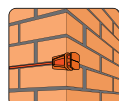

No.	L [m]	
17430	18	48/96

EN Plumb bob  
 PL Pion murarski  
 DE Senklot  
 RU Строительный отвес  
 CZ Zednická olovnice  
 RO Fir cu plumb  
 HU Kőműves függőőn  
 ES Plomada de albañil



No.	Size / Rozmiar [mm]	
17300	15x70	100

EN Plumb bob  
 PL Pion murarski  
 DE Senklot  
 RU Строительный отвес  
 CZ Zednická olovnice  
 RO Fir cu plumb  
 HU Kőműves függőőn  
 ES Plomada de albañil



No.	Size / Rozmiar [mm]	L [m]	
17302	19x88	4.5	25/100

EN Polyethylene bricklayer's string  
 PL Sznurek murarski polietylenowy  
 DE Maurerschnur aus Polyäthylen  
 RU Полиэтиленовый шнур каменщика  
 CZ Šňůra zednická polyetylenová  
 RO Șnur de zidărie din polietilena  
 HU Kőműves zsinór polietilén  
 ES Cordel de albañilería de polietileno



No.	Ø [mm]	L [m]	
17480	1.7	50	60/240
17481	1.7	100	30/120
17483	2.0	50	60/240
17484	2.0	100	30/120

EN Steel pins for fixing masonry lines / hd line pin  
 PL Szpilki murarskie stalowe  
 DE Maurerstifte aus Stahl  
 RU Стальные шпильки для кладки  
 CZ Zednické hřebíky ocelové  
 RO Cuie pt. fixare sfoara de trasat  
 HU Falazózsínör rögzítő szeg  
 ES Pasadores de acero para mampostería

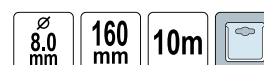

No.	Ø [mm]	L	
17435	8	160 mm (szpilki), 10 m (linka)	10/40

EN Plumb bob  
 PL Pion murarski  
 DE Senklot  
 RU Строительный отвес  
 CZ Zednická olovnice  
 RO Fir cu plumb  
 HU Kőműves függőőn  
 ES Plomada de albañil



No.	Size / Rozmiar [mm]	L [m]	
17301	12x62	5	10/150

EN Plumb bob  
 PL Pion murarski  
 DE Senklot  
 RU Строительный отвес  
 CZ Zednická olovnice  
 RO Fir cu plumb  
 HU Kőműves függőőn  
 ES Plomada de albañil



No.	Size / Rozmiar [mm]	L [m]	
17303	22x115	6	10/60

EN Plumb bob  
 PL Pion murarski  
 DE Senklot  
 RU Строительный отвес  
 CZ Zednická olovnice  
 RO Fir cu plumb  
 HU Kőműves függőón  
 ES Plomada de albañil

4.5m 300g



No.	Size / Rozmiar [mm]	L [m]	
17304	27x88	4.5	9/36

EN Try square  
 PL Kątownik stolarski  
 DE Zimmermannswinkel  
 RU Угольник столярный

CZ Truhlářský úhelník  
 RO Echer (unghi drept) de tâmplărie  
 HU Asztalos derékszög  
 ES Escuadra de metal



No.	L [mm]	
18250	250	12/120
18300	300	12/120
18350	350	12/120

EN Aluminium try square  
 PL Kątownik aluminiowy  
 DE Alu-Zimmermannswinkel  
 RU Угольник столярный алюминиевый

CZ Truhlářský úhelník  
 RO Echer (unghi drept) de tâmplărie  
 HU Asztalos derékszög  
 ES Escuadra



No.	L [mm]	
18360	250	10/60
18361	300	10/60
18362	350	10/60

EN Try square set  
 PL Zestaw kątowników metalowych ze stopką i libellą  
 DE Metall-Anschlagwinkel-Set mit Fuß und Libelle  
 RU Комплект металлических уголков с ножкой и пузырьком  
 CZ Sada kovových úhelníků s nohou a vodováhou  
 RO Set 3 echere  
 HU Fém asztalos derékszög készlet talppal és libellával  
 ES Juego de escuadras metálicas con pie y nivel



No.	L [mm]	
18390	150, 400, 700	25

EN Magnetic plumb bob  
 PL Pion murarski magnetyczny  
 DE Senklot mit Magnet  
 RU Магнитный строительный отвес  
 CZ Olovnice magnetická  
 RO Fir cu plumb magnetic  
 HU Fügőón mágneses  
 ES Plomada de albañil magnética

6m 400g

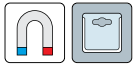

No.	L [m]	
17310	6	6/36

EN Try square  
 PL Kątownik stolarski  
 DE Zimmermannswinkel  
 RU Угольник столярный

CZ Truhlářský úhelník  
 RO Echer (unghi drept) de tâmplărie  
 HU Asztalos derékszög  
 ES Escuadra de metal



No.	Size / Rozmiar [mm]	
18201	200x300	24/48
18200	400x600	12/24

EN Try square  
 PL Kątownik metalowy ze stopką i libellą  
 DE Metall-Anschlagwinkel mit Fuß und Libelle  
 RU Металлический угольник с опорой и ампулой  
 CZ Kovový úhelník s nohou a vodováhou  
 RO Echer  
 HU Fém asztalos derékszög talppal és libellával  
 ES Escuadra metálica con pie y nivel



No.	L [mm]	
18380	150	10/60
18382	700	10/60



EN Angle bar with a support  
 PL Kątownik z podpórką  
 DE Winkel mit Stütze  
 RU Угольник столярный с откидным упором

CZ Úhelník s dorazem  
 RO Cornier cu stand  
 HU Támaszos derékszögelő  
 ES Escuadra con soporte



No.	L [mm]	
18501	350	30
18502	500	30
18503	750	20
18504	1000	10

EN Aluminium try square  
 PL Kątownik aluminiowy  
 DE Alu-Zimmermannswinkel  
 RU Угольник столярный алюминиевый  
 CZ Truhlářský úhelník  
 RO Echer (unghi drept) de tâmplărie  
 HU Asztalos derékszög  
 ES Escuadra de aluminio



No.	Size / Rozmiar [mm]	
18374	600x320	6/12
18375	1200x600	6/12

EN Bevel protractor  
 PL Kątomierz nastawny  
 DE Winkelmesser  
 RU Угломер регулируемый со шкалой  
 CZ Nastavitelný úhloměr  
 RO Echer reglabil  
 HU Állítható szögmérő  
 ES Calibrador de biselas



No.	L [mm]	
18797	350	10
18798	500	10
18799	750	10

EN Aluminium try square  
 PL Kątownik aluminiowy  
 DE Alu-Zimmermannswinkel  
 RU Угольник столярный алюминиевый  
 CZ Truhlářský úhelník  
 RO Echer (unghi drept) de tâmplărie  
 HU Asztalos derékszög  
 ES Escuadra de aluminio

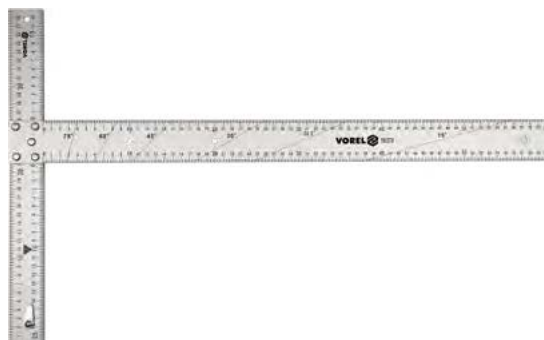

No.	Size / Rozmiar [mm]	
18370	600x390	2/10
18372	1200x390	2/10

EN Aluminium try square  
 PL Kątownik aluminiowy  
 DE Alu-Zimmermannswinkel  
 RU Угольник столярный алюминиевый  
 CZ Truhlářský úhelník  
 RO Echer de tâmplărie  
 HU Asztalos derékszög  
 ES Escuadra de aluminio



No.	Size / Rozmiar [mm]	
18355	400x210	100
18356	600x210	60
18357	1000x210	60

EN Protractor with level  
 PL Kątomierz z libellą i ruchomym ramieniem  
 DE Winkelmesser  
 RU Транспортир  
 CZ Protractor  
 RO Muşchi extensor  
 HU Szögmerő  
 ES Transportador

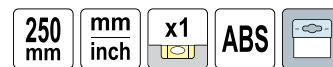

No.	L [mm]	Vials / Libelle	
18473	250	1	10/60



EN Protractor electronic with spirit level  
 PL Kątomierz elektroniczny z poziomnicą  
 DE Digital Winkelmesser mit Wasserwaage  
 RU Транспортёр электронный с уровнем  
 CZ Protractor electronic s urovní  
 RO Protractor electronic level cu  
 HU Szögmérő elektronikusak szint  
 ES Con el nivel electrónico transportador



No.	L [mm]	Vials / Libelle	Box
17570	400	2	20

EN Bevel protractor  
 PL Skośnica  
 DE Schmiege  
 RU Угольник  
 CZ Nastavitelný úhloměr  
 RO Echer  
 HU Szögmásoló  
 ES Falsa escuadra



No.	L [mm]	Box
18800	270	80
18810	400	60

EN Triangle ruler  
 PL Kątownik ciesielski do krokwi  
 DE Lineal Winkelmesser  
 RU Угольник для плотника и столяра  
 CZ Tesařský úhelník  
 RO Echer pt. dulgherie  
 HU Fém derékszög  
 ES Escuadra



No.	L [mm]	Box
18530	180	100

EN Multipurpose angle finder  
 PL Kątomierz budowlany  
 DE Bauwinkelmesser  
 RU Строительный угломер  
 CZ Stavební úhloměr  
 RO Raportor multifuncțional  
 HU Építési szögmérő  
 ES Escuadra de construcción

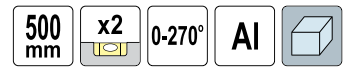

No.	L [mm]	Vials / Libelle	Box
18790	500	2	10

EN Adjustable ruler  
 PL Kątownik nastawny do przenoszenia wymiarów  
 DE Multifunktionales Messlineal  
 RU Разметочный инструмент линейка-шаблон

CZ Pokosník nastavitelný  
 RO Echer reglabil  
 HU Szögmértékek  
 ES Medición del ángulo



No.	Box
18470	20/60

EN Aluminium triangle ruler with foot  
 PL Kątownik aluminiowy ze stopką  
 DE Aluminiumwinkel mit Fuß  
 RU Алюминиевый угольник с основанием  
 CZ Hliníkový úhelník s patkou  
 RO Echer aluminiu cu talpa  
 HU Talpas alumínium derékszög  
 ES Escuadra de aluminio con pie



No.	Dimensions / Wymiary [mm]	Box
18377	180x180x250	12/120

- EN Carpenter's ruler  
 PL Przymiar do tapet  
 DE Zeichen-Masstab  
 RU Линейка стальная с деревянной ручкой
- CZ Měřidlo stavební  
 RO Rigla de tamplarie  
 HU Kőműves vonalzó  
 ES Regla de obra



No.	L [mm]	
19750	750	10/40

- EN Aluminium ruler, 2 vials  
 PL Przymiar aluminiowy, uchwyt, 2 libelki  
 DE Alu Zeichen-Masstab 2-lib  
 RU Линейка столярная алюминиевая 2 глазка с ручкой  
 CZ Měřidlo hliníkové  
 RO Rigla de aluminiu cu 2 bule  
 HU Alumínium vonalzó  
 ES Regla de aluminio, mango, division 2-burbujas

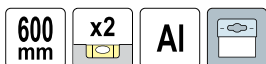

No.	L [mm]	Vials / Libelle	
19770	600	2	12/24

- EN Laser distance meter  
 PL Dalmierz laserowy  
 DE Laserentfernungsmesser  
 RU Лазерный дальномер  
 CZ Laserový měřič vzdálenosti  
 RO Telemetru cu laser  
 HU Lézeres távolságmérő  
 ES Medidores láser de distancias

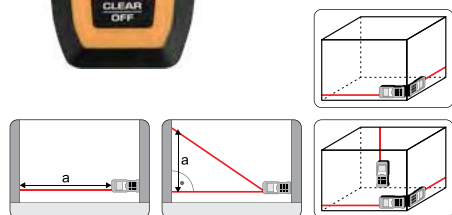
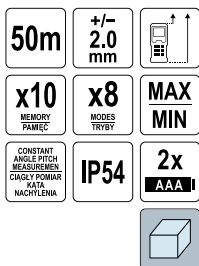

No.		
81791		10/50

- EN Aluminium ruler, 2 vials  
 PL Przymiar aluminiowy, uchwyt, 2 libelki  
 DE Alu Zeichen-Masstab 2-lib  
 RU Линейка столярная алюминиевая 2 глазка с ручкой  
 CZ Měřidlo hliníkové  
 RO Rigla de aluminiu cu 2 bule  
 HU Alumínium vonalzó  
 ES Regla de aluminio, mango, division 2-burbujas

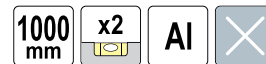

No.	L [mm]	Vials / Libelle	
19755	1000	2	24

- EN Aluminium ruler  
 PL Liniań aluminiowy  
 DE Aluminium-Gliedemaß  
 RU Алюминиевая линейка  
 CZ Hliníkové pravítko  
 RO Rigla aluminiu  
 HU Alumínium vonalzó  
 ES Regla de aluminio



No.	Dimensions / Wymiary [mm]	
19763	150x28x1.8	20/120
19765	300x28x1.8	20/120
19766	600x28x1.8	20/120
19767	1000x28x1.8	10/100

- EN Laser distance meter  
 PL Dalmierz laserowy  
 DE Laserentfernungsmesser  
 RU Лазерный дальномер  
 CZ Laserový měřič vzdálenosti  
 RO Telemetru cu laser  
 HU Lézeres távolságmérő  
 ES Medidores láser de distancias

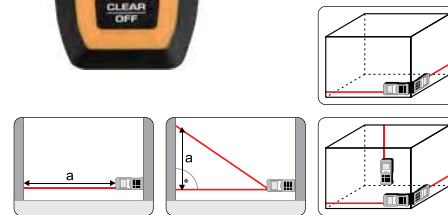

No.		
81794		10/50

EN Laser distance meter  
 PL Dalmierz laserowy  
 DE Laserentfernungsmesser  
 RU Лазерный дальномер  
 CZ Laserový měřič vzdálenosti  
 RO Telemetru cu laser  
 HU Lézeres távolságmérő  
 ES Medidores láser de distancias



100 m  
 +/- 2.0 mm  
 x10 MEMORY PAMIEC  
 x8 MODES TRYBY  
 MAX MIN  
 CONSTANT ANGLE PITCH MEASUREMENT CIEGŁY POMIAR KĄTA NACHYLENIA  
 IP54  
 2x AAA

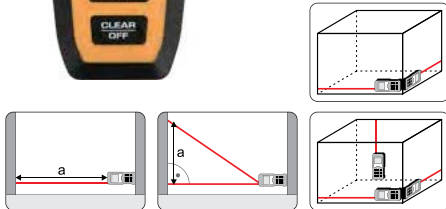

No.		
81795		10/50

EN Aluminium tripod  
 PL Statyw aluminiowy  
 DE Aluminium-Stativ  
 RU Алюминиевый штатив  
 CZ Hliníkový stativ  
 RO Trepied aluminiu  
 HU Alumínium állvány  
 ES Trípode de aluminio



250x500 mm  
 AI



No.	H [mm]	
18021	250-500	12

EN Laser mounting pole  
 PL Tyczka do montażu lasera  
 DE Laser Teleskopstange  
 RU Штанга для лазерного уровня  
 CZ Tyč pro montáž laseru  
 RO Stâlp de montare laser  
 HU Lézer teleszkópúrd  
 ES Barra para láser



max 360 cm  
 AI



No.	H [mm]	
18010	maks. 3600	6

EN Cross line green laser  
 PL Laser zielony krzyżowy  
 DE Laser mit grünem Kreuz  
 RU Лазерный уровень зеленый крест  
 CZ Laser zelený křížový  
 RO Nivelă cu laser transversală  
 HU Zöld keresztlézér  
 ES Láser en cruz verde



±3.0mm /10m LASER ACCURACY DOKŁADNOŚĆ LASERA  
 ±4° SELF-REGULATION SAMOREGULACJA  
 510-530 nm  
 1/4" (6.3 mm) TRIPOD THREAD GWINT STATYWU  
 8h  
 -10 +50 °C  
 ≤1 mW CLASS II LASER  
 IP54  
 3V 2x AAA



No.		
18002		30

EN Aluminium tripod  
 PL Statyw aluminiowy  
 DE Aluminium-Stativ  
 RU Алюминиевый штатив  
 CZ Hliníkový stativ  
 RO Trepied aluminiu  
 HU Alumínium állvány  
 ES Trípode de aluminio



500x1500 mm  
 AI



No.	H [mm]	
18020	500-1500	12

EN Metal and voltage detector  
 PL Wykrywacz metalu i przewodów  
 DE Ortungsgerät für Metal und Leitungen  
 RU Детектор металла и токоведущих проводов  
 CZ Detektor kovu a elektrických vodičů  
 RO Detector metale si electricitate  
 HU Fém- és feszültség detektor  
 ES Detector de metal y cables



2in1 2w1 METAL  
 LED LIGHT DIODE  
 6h  
 3x + LR44

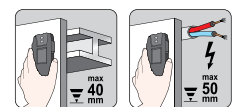

No.		
81786		10/80

- EN Metal and voltage detector
- PL Wykrywacz metalu i przewodów
- DE Ortungsgerät für Metal und Leitungen
- RU Детектор металла и токоведущих проводов
- CZ Detektor kovu a elektrických vodičů
- RO Detector metale si electricitate
- HU Fém- és feszültség detektor
- ES Detector de métało y cables



No.	4
81785	20

- EN Battery tester
- PL Tester baterii
- DE Batterietester
- RU Тестер заряда батареи
- CZ Tester baterii
- RO Tester baterii
- HU Elemteszter
- ES Comprobador de pilas



No.	4
81700	25/100

- EN Digital sound level meter
- PL Miernik natężenia dźwięku
- DE Schallpegelmesser
- RU Измеритель интенсивности звука
- CZ Měřič intenzity zvuku
- RO Sonometru digital
- HU Hangerősség mérő
- ES Sonómetro



No.	4
81711	10/60

- EN Hygrometer
- PL Higrometr
- DE Hygrometer
- RU Гигрометр
- CZ Hygrometr
- RO Higrometru
- HU Higrométer
- ES Higrometro

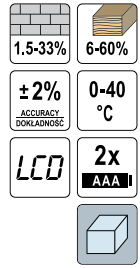

No.	4
81751	72

- EN Infrared thermometer
- PL Pirometr
- DE Pyrometer
- RU Пирометр
- CZ Pyrometr
- RO Termometru cu infrarosu
- HU Piróméter
- ES Pirómetro

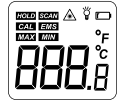
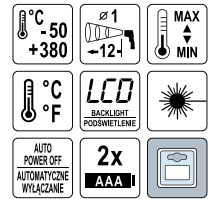

No.	4
84400	20/80

- EN Digital lux meter
- PL Miernik natężenia światła
- DE Lichtstärkemesser
- RU Измеритель интенсивности света
- CZ Měřič intenzity světla
- RO Luxmetru digital
- HU Fényerősség mérő
- ES Luxómetro

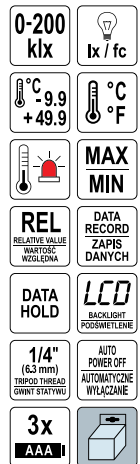

No.	4
81713	10/60



EN Humidity and temperature meter  
 PL Miernik wilgotności względnej i temperatury otoczenia  
 DE Messgerät für relative Luftfeuchtigkeit und Temperatur  
 RU Измеритель влажности и температуры  
 CZ Měřič relativní vlhkosti a teploty okolí  
 RO Termohigrometru  
 HU Levegő hőmérséklet és páratartalom mérő műszer  
 ES Termohigrómetro



- RH 0-100%
- °C -20 +70
- °C °F
- DEW POINT PUNKT ROSY
- MAX MIN
- DATA RECORD ZAPIS DANYCH
- DATA HOLD
- LCD BACKLIGHT PODSWIETLENIE
- 1/4" (6.3 mm) TRIPOD THREAD GWINT STARTYWI
- AUTO POWER OFF AUTOMATYCZNE WYŁĄCZANIE
- 3x AAA



No.		
81716		10/60

EN Trapezoidal spirit level  
 PL Poziomnica trapezowa  
 DE Trapezförmige Wasserwaage  
 RU Трапецидальный уровень

CZ Vodováha trapezová  
 RO Nivelă trapezoidală  
 HU Vízmerék trapéz  
 ES Trapezoides nivel

- 500 mm
- x2
- 0.027° = 0.5 mm/m ACCURACY DOKŁADNOŚĆ



No.	L [mm]	Vials / Libelle	
16280	500	2	50

EN Torpedo level  
 PL Poziomnica torpeda  
 DE Torpedo-Wasserwaage  
 RU Уровень торпедо

CZ Vodováha torpédo  
 RO Nivelă torpilă  
 HU Vízmerék torpédo  
 ES Nivel torpedo

- 230 mm
- x3
- 0.027° = 0.5 mm/m ACCURACY DOKŁADNOŚĆ



No.	L [mm]	Vials / Libelle	
16301	230	3	100

EN Digital anemometer  
 PL Miernik prędkości wiatru  
 DE Windgeschwindigkeitsmesser  
 RU Измеритель скорости ветра  
 CZ Měřič rychlosti větru  
 RO Anemometru digital  
 HU Szélsebesség mérő  
 ES Anemómetro



- 0-30 m/s
- 0-90 km/h
- 0-65 mph
- 0-5860 ft/min
- 0-55 knots
- °C -10 +45
- MAX AVG
- BEAUFORT SCALE SKALA BEAUFORTA
- DATA RECORD ZAPIS DANYCH
- DATA HOLD
- LCD BACKLIGHT PODSWIETLENIE
- 1/4" (6.3 mm) TRIPOD THREAD GWINT STARTYWI
- AUTO POWER OFF AUTOMATYCZNE WYŁĄCZANIE
- 3x AAA



No.		
81719		10/60

EN Torpedo level  
 PL Poziomnica torpeda  
 DE Torpedo-Wasserwaage  
 RU Уровень торпедо

CZ Vodováha torpédo  
 RO Nivelă torpilă  
 HU Vízmerék torpédo  
 ES Nivel torpedo

- 230 mm
- x3
- 0.027° = 0.5 mm/m ACCURACY DOKŁADNOŚĆ



No.	L [mm]	Vials / Libelle	
16300	230	3	100

EN Laser level mini  
 PL Poziomnica laserowa mini  
 DE Laser Wasserwaage mini  
 RU Уровень лазерный мини  
 CZ Úrovň laserové mini  
 RO Niveluri mini cu laser  
 HU Szintek lézer mini  
 ES Niveles láser mini

- 0.057° = 1 mm/m ACCURACY DOKŁADNOŚĆ
- 135-245mm
- 5-40 °C



No.		
17560		20

- EN Post level
- PL Poziomnica do słupków
- DE Pfostenwasserwaage
- RU Уровни на должности
- CZ Hladiny do míst
- RO Niveluri de către posturile
- HU Szintek üzenete
- ES Los niveles a los mensajes



No.	Vials / Libelle	
16012	3	25/100

- EN Aluminium level
- PL Poziomnica aluminiowa
- DE Alu-Wasserwaage
- RU Алюминиевый уровень
- CZ Hliníková vodováha
- RO Cumpana de nivel aluminiu
- HU Alumínium vízmérték
- ES Nivel de burbuja de aluminio



No.	L [mm]	Vials / Libelle	
16551	400	3	25/50
16552	600	3	25/50
16553	800	3	25/50
16554	1000	3	25/50
16555	1200	3	15/30
16556	1500	3	15/30
16557	2000	3	10/20

- EN Water level
- PL Poziomnica wodna z węzłem
- DE Schlauchwaage
- RU Гидроуровень
- CZ Vodná vodováha
- RO Furtun de nivel
- HU Vizes vízmérték
- ES Nivel de agua



No.	L [cm]	Ø [mm]	
16000	15	10	15
16001	20	10	15
16002	25	10	15

- EN Aluminium level
- PL Poziomnica aluminiowa
- DE Alu-Wasserwaage
- RU Алюминиевый уровень
- CZ Hliníková vodováha
- RO Cumpana de nivel aluminiu
- HU Alumínium vízmérték
- ES Nivel de burbuja de aluminio



No.	L [mm]	Vials / Libelle	
16340	400	3	20/60
16360	600	3	20/60
16380	800	3	20/60
16400	1000	3	20/60

- EN Aluminium level
- PL Poziomnica aluminiowa
- DE Alu-Wasserwaage
- RU Алюминиевый уровень
- CZ Hliníková vodováha
- RO Cumpana de nivel aluminiu
- HU Alumínium vízmérték
- ES Nivel de burbuja de aluminio



No.	L [mm]	Vials / Libelle	
17606	600	3	20/60
17608	800	3	20/60
17610	1000	3	20/60
17612	1200	3	15/30
17615	1500	3	15/30
17620	2000	3	10/20

- EN Spring weight measurer
- PL Waga sprężynowa
- DE Federwaage
- RU Ручные пружинные весы
- CZ Váha pérová
- RO Cântar cu arc și cârlig
- HU Akasztós mérleg
- ES Balanza de resorte



No.	Max. load capacity / Maks. obciążenie [kg]	
15291	25	72
15292	50	48

EN Spring weight measurer  
 PL Waga sprężynowa z miarką zwijaną  
 DE Federwaage  
 RU Ручные пружинные весы  
 CZ Váha péřová  
 RO Cântar cu arc și cârlig  
 HU Akasztós mérleg  
 ES Balanza de resorte



max 32 kg  
 1m  
 6mm



No.	Max. load capacity / Maks. obciążenie [kg]	
15301	32	36

EN Head magnifier  
 PL Lupa z opaską na głowę  
 DE Lupe mit Stirnband  
 RU Лупа биноклярная налобная  
 CZ Lupa s hlavou  
 RO Lupă cu cap  
 HU Fejpántos nagyító szett  
 ES Lupa con cabeza



No.	
73503	24

EN Magnifier  
 PL Szkló powiększające  
 DE Vergrößerungsglas  
 RU Увеличительное стекло  
 CZ Lupa  
 RO Lupă  
 HU Nagyító üveg  
 ES Lupa de mano



3x  
 ø 50 mm  
 6x  
 10x20 mm

No.	
73490	40/480

Memo																			
------	--	--	--	--	--	--	--	--	--	--	--	--	--	--	--	--	--	--	--

# 13

## Pneumatic tools Narzędzia pneumatyczne





## Air tools Narzędzia pneumatyczne

204-207



<b>Impact wrenches</b> Klucze udarowe.....	204
<b>Pneumatic grinders</b> Szlifierki pneumatyczne.....	204
<b>Pneumatic ratchets</b> Grzechotki pneumatyczne.....	205
<b>Pneumatic hammers</b> Młotki pneumatyczne.....	206
<b>Pneumatic cut-off tools</b> Przecinarki pneumatyczne.....	206
<b>Pneumatic shears</b> Nożyce pneumatyczne.....	206
<b>Pneumatic drills</b> Wiertarki pneumatyczne.....	207
<b>Multi-purpose air tools</b> Wielofunkcyjne narzędzia pneumatyczne.....	207

## Tire inflating guns & heads Pistolety do pompowania kół i głowice

207-208



## Pneumatic painting equipment Narzędzia do malowania

208-210



<b>Spray guns</b> Pistolety lakiernicze.....	208
<b>Blow guns</b> Pistolety do przedmuchiwania.....	209
<b>Washing guns</b> Pistolety do ropowania.....	210

## Pneumatic accessories Akcesoria instalacji pneumatycznej

210-212



<b>Air filters, regulators &amp; lubricators</b> Filtry, reduktory i smarownice.....	210
<b>Spiral hoses</b> Węże spiralne.....	211
<b>Reinforced hoses</b> Węże zbrojone.....	211
<b>Couplers</b> Złącza.....	211

## Pneumatic riveters Nitownice pneumatyczne

212



- EN Impact wrench
- PL Klucz pneumatyczny
- DE Druckluft-Schlagschrauber
- RU Ударный пневматический гайковерт
- CZ Klíč pneumatický
- RO Pistol pneumatic
- HU Pneumatikus ütvecsavarozó
- ES Llave neumática de percusión

1/2" 12.7mm
0.63 MPa
0-7000 min<sup>-1</sup>
226 l/min

340 Nm
STANDARD



$L_{pa} = 92,6 \text{ dB}$ ;  $L_{wa} = 103,6 \text{ dB}$ ;  $a_n = 2,8 \text{ m/s}^2$

No.	Ø	Required air flow / Wymagany przepływ powietrza [l/min]	Max. torque / Maks. moment obrotowy [Nm]	☐
81100	1/2" (12.7 mm)	226	340	10

- EN Air grinder
- PL Szlifierka pneumatyczna prosta
- DE Druckluftfeinhandschleifer
- RU Шлифмашинка пневматическая
- CZ Bruska přímá pneumatická
- RO Polizor pneumatic
- HU Pneumatikus egyenescsiszoló
- ES Lijadora neumática recta

0.63 MPa
25000 min<sup>-1</sup>
100 l/min

6 mm
STANDARD



$L_{pa} = 88,0 \pm 3,0 \text{ dB}$ ;  $L_{wa} = 99,0 \pm 3,0 \text{ dB}$ ;  $a_n = 2,9 \pm 1,5 \text{ m/s}^2$

No.	Toolholder size / Rozmiar uchwyty narzędziowego	Required air flow / Wymagany przepływ powietrza [l/min]	☐ [min <sup>-1</sup> ]	☐
81107	1/4" (6.3 mm)	100	25000	20

- EN Air angle grinder
- PL Szlifierka pneumatyczna kątowa
- DE Ruckluft-Winkelschleifer
- RU Пневматическая угловая шлифовальная машина
- CZ Pneumatické úhlovou brusku
- RO Polizor unghiular pneumatic
- HU Pneumatikus sarokcsiszoló
- ES Amoladora angular neumática

0.63 MPa
0-20000 min<sup>-1</sup>
100 l/min

6 mm
STANDARD



$L_{pa} = 90,1 \text{ dB}$ ;  $L_{wa} = 101,1 \text{ dB}$ ;  $a_n = 0,7 \text{ m/s}^2$

No.	Toolholder size / Rozmiar uchwyty narzędziowego	Required air flow / Wymagany przepływ powietrza [l/min]	☐ [min <sup>-1</sup> ]	☐
81110	1/4" (6.3 mm)	100	0-20000	16

- EN Air impact kit
- PL Klucz pneumatyczny z nasadkami
- DE Druckluft-Schlagschrauber mit Kräfteinsätzen
- RU Гайковерт пневматический с набором головок
- CZ Klíč pneumatický s nástavci
- RO Pistol pneumatic cu accesorii
- HU Pneumatikus ütvecsavarozó készlet
- ES Llave neumático de percusión

1/2" 12.7mm
0.63 MPa
0-7000 min<sup>-1</sup>
226 l/min

340 Nm
CrV

STANDARD

MINI OILER SMAROWNICA



$L_{pa} = 95,0 \pm 3,0 \text{ dB}$ ;  $L_{wa} = 106,0 \pm 3,0 \text{ dB}$ ;  $a_n = 9,1 \pm 1,5 \text{ m/s}^2$

No.	Ø	Required air flow / Wymagany przepływ powietrza [l/min]	Max. torque / Maks. moment obrotowy [Nm]	☐
81101	1/2" (12.7 mm)	226	340	5

- EN Air grinder
- PL Szlifierka pneumatyczna prosta
- DE Druckluftfeinhandschleifer
- RU Шлифмашинка пневматическая
- CZ Bruska přímá pneumatická
- RO Polizor pneumatic
- HU Pneumatikus egyenescsiszoló
- ES Lijadora neumática recta

0.63 MPa
0-22000 min<sup>-1</sup>
127 l/min

6 mm
STANDARD



$L_{pa} = 82,8 \text{ dB}$ ;  $L_{wa} = 93,8 \text{ dB}$ ;  $a_n = 0,9 \text{ m/s}^2$

No.	Toolholder size / Rozmiar uchwyty narzędziowego	Required air flow / Wymagany przepływ powietrza [l/min]	☐ [min <sup>-1</sup> ]	☐
81108	1/4" (6.3 mm)	127	0-22000	20

- EN Die grinder kit
- PL Szlifierka pneumatyczna prosta z akcesoriami
- DE Druckluft-Schrauber mit Schleifaufsätzen
- RU Прямая пневматическая шлифмашинка и принадлежности
- CZ Bruska přímá pneumatická s příslušenstvím
- RO Masina de polizat pneumatica
- HU Pneumatikus kőszőrű készlet
- ES Lijadora neumática recta

15 PCS
0.63 MPa
0-22000 min<sup>-1</sup>

127 l/min
3.6 mm
STANDARD



$L_{pa} = 88,0 \pm 3,0 \text{ dB}$ ;  $L_{wa} = 99,0 \pm 3,0 \text{ dB}$ ;  $a_n = 2,9 \pm 1,5 \text{ m/s}^2$

No.	Toolholder size / Rozmiar uchwyty narzędziowego	Required air flow / Wymagany przepływ powietrza [l/min]	☐ [min <sup>-1</sup> ]	☐
81109	3 mm, 1/4" (6.3 mm)	127	0-22000	8

- EN Air micro die grinder kit
- PL Zestaw pneumatyczny szlifierka mini
- DE Luft Sterben Schleifer Kit
- RU Пневмошлифмашина мини в наборе
- CZ Pneumatická bruska mini
- RO Biax pneumatic tip stilou
- HU Pneumatikus mini-csiszoló
- ES Amoladora biax recta neumatica

16 PCS 0.63 MPa 0-54000 min<sup>-1</sup> 3 mm

STANDARD MINI OILER SMAROWNICA OIL POT OLIVMARKA



$L_{PA} = 79,0 \pm 3,0$  dB;  $L_{WA} = 90,0 \pm 3,0$  dB;  $a_n = <2,5$  m/s<sup>2</sup>

No.	Toolholder size / Rozmiar uchwytu narzędziowego [mm]	$\Omega$ [min <sup>-1</sup> ]	
80970	3	0-54000	10

- EN Air sander
- PL Szlifierka pneumatyczna mimośrodowa
- DE Druckluft- Excenterschleifer
- RU Эксцентриковая шлифмашина
- CZ Bruska pneumatická
- RO Masina de slefuit pneumatica
- HU Pneumatikus sarokcsiszológép
- ES Lijadora neumatica excéntrica

0.63 MPa 0-10000 min<sup>-1</sup> 113 l/min 150 mm

STANDARD



$L_{PA} = 72,7$  dB;  $L_{WA} = 83,7$  dB;  $a_n = 1,44$  m/s<sup>2</sup>

No.	Disc diameter / Średnica tarczy [mm]	$\Omega$ [min <sup>-1</sup> ]	
81114	150	0-10000	10

- EN Ratchet air wrench
- PL Grzechotka pneumatyczna
- DE Druckluft-Ratschenschrauber
- RU Пневмотрещотка
- CZ Pneumatická ráčna
- RO Antrenor pneumatic
- HU Préslevegős behajtó szerszám
- ES Carraca neumatica

1/4" 6.3mm 0.65 MPa (max) 150 min<sup>-1</sup> 113 l/min

33 Nm STANDARD



$L_{PA} = 95,0 \pm 3,0$  dB;  $L_{WA} = 106,0 \pm 3,0$  dB;  $a_n = 9,2 \pm 1,5$  m/s<sup>2</sup>

No.	$\Omega$	Required air flow / Wymagany przepływ powietrza [l/min]	Max. torque / Maks. moment obrotowy [Nm]	
81137	1/4" (6.3 mm)	113	33	20

- EN Straight line air sander
- PL Szlifierka pneumatyczna liniowa
- DE Druckluft-Linearschleifer
- RU Пневматическая прямошлифовальная машина
- CZ Pneumatická bruska přímočará
- RO Slefuitor pneumatic
- HU Egyenes vonalú pneumatikus csiszoló
- ES Amoladora neumatica lineal

0.63 MPa (max.) 170 l/min 2500 min<sup>-1</sup>

70x395 mm STANDARD



$L_{PA} = 79,1 \pm 3,0$  dB;  $L_{WA} = 90,1 \pm 3,0$  dB;  $a_n = 4,721 \pm 1,5$  m/s<sup>2</sup>

No.	Required air flow / Wymagany przepływ powietrza [l/min]	Work speed without load / Predkość pracy bez obciążenia [min <sup>-1</sup> ]	
81150	170	2500	6

- EN Disc for air sander
- PL Tarcza polerska do szlifierki pneumatycznej
- DE Stützteller für Druckluftexcenterschleifer
- RU Диск для эксцентриковой шлифмашины
- CZ Disk pro pneumatickou brusku
- RO Masina disc pt. slefuit
- HU Csiszológörög pneumatikus gépekhez
- ES Recambio disco lijadora orbital neumatica

150 mm 0-10000 min<sup>-1</sup> M8



No.	$\Omega$ [mm]	$\Omega$ [min <sup>-1</sup> ]	
81115	150	0-10000	10/100

- EN Ratchet air wrench
- PL Grzechotka pneumatyczna
- DE Druckluft-Ratschenschrauber
- RU Пневмотрещотка
- CZ Pneumatická ráčna
- RO Antrenor pneumatic
- HU Préslevegős behajtó szerszám
- ES Carraca neumatica

1/2" 12.7mm 0.63 MPa 0-150 min<sup>-1</sup>

141 l/min 61 Nm STANDARD



$L_{PA} = 92,1$  dB;  $L_{WA} = 103,1$  dB;  $a_n = 0,8$  m/s<sup>2</sup>

No.	$\Omega$	Required air flow / Wymagany przepływ powietrza [l/min]	Max. torque / Maks. moment obrotowy [Nm]	
81117	1/2" (12.7 mm)	141	61	20

EN Ratchet air wrench  
 PL Grzechotka pneumatyczna  
 DE Druckluft-Ratschenschrauber  
 RU Пневмотрещотка  
 CZ Pneumatická ráčna  
 RO Antrenor pneumatic  
 HU Préslevegős behajtó szerszám  
 ES Carraca neumática

**1/2"**  
12.7mm

**0.63**  
MPa

**0-160**  
min<sup>-1</sup>

**141**  
l/min

**68**  
Nm

STANDARD



$L_{pA} = 91,0 \pm 3,0$  dB;  $L_{wA} = 102,0 \pm 3,0$  dB;  $a_n = 3,27 \pm 1,5$  m/s<sup>2</sup>

No.	Ø	Required air flow / Wymagany przepływ powietrza [l/min]	Max. torque / Maks. moment obrotowy [Nm]	Icon
81118	1/2" (12.7 mm)	141	68	10

EN Air hammer  
 PL Młotek pneumatyczny  
 DE Druckluft-Schlaghammer  
 RU Пневматический молоток  
 CZ Sekáč vzduchový  
 RO Pneumatikus vésőkészlet pisztolyal  
 HU Kládívo pneumatiké  
 ES Marteau burineur

**0.63**  
MPa

**113**  
l/min

**T**  
4500  
min<sup>-1</sup>

STANDARD



$L_{pA} = 85,0 \pm 3,0$  dB;  $L_{wA} = 96,0 \pm 3,0$  dB;  $a_n = 9,4 \pm 1,5$  m/s<sup>2</sup>

No.	Required air flow / Wymagany przepływ powietrza [l/min]	Icon
81133	113	8

EN Air nibbler  
 PL Nożyce pneumatyczne matrycowe  
 DE Pneumatische Schere  
 RU Вырубные ножницы пневматические  
 CZ Pneumatické nůžky na plech  
 RO Foarfeca pneumatică  
 HU Pneumatikus folyamatós lyukasztó  
 ES Roedora neumática

**0.62**  
MPa

**113**  
l/min

**3500**  
min<sup>-1</sup>

**5.5**  
mm

max  
**1.5**mm  
STEEL  
STYL

STANDARD



$L_{pA} = 77,0 \pm 3,0$  dB;  $L_{wA} = 88,0 \pm 3,0$  dB;  $a_n = 4,42 \pm 1,5$  m/s<sup>2</sup>

No.	Required air flow / Wymagany przepływ powietrza [l/min]	Cutting speed / Prędkość cięcia [min <sup>-1</sup> ]	Icon
81070	113	3500	20

EN Ratchet air wrench  
 PL Grzechotka pneumatyczna  
 DE Druckluft-Ratschenschrauber  
 RU Пневмотрещотка  
 CZ Pneumatická ráčna  
 RO Antrenor pneumatic  
 HU Préslevegős behajtó szerszám  
 ES Carraca neumática

**1/2"**  
12.7mm

**0.63**  
MPa

**160**  
min<sup>-1</sup>

**113**  
l/min

**69**  
Nm

STANDARD



$L_{pA} = 94,0 \pm 3,0$  dB;  $L_{wA} = 105,0 \pm 3,0$  dB;  $a_n = 9,0 \pm 1,5$  m/s<sup>2</sup>

No.	Ø	Required air flow / Wymagany przepływ powietrza [l/min]	Max. torque / Maks. moment obrotowy [Nm]	Icon
81119	1/2" (12.7 mm)	113	69	10

EN Air cut-off tool  
 PL Przecinarka pneumatyczna  
 DE Druckluft-Schneidmaschine  
 RU Резак пневматический  
 CZ Pfičná bruska pneumatická  
 RO Masina de taiat cu aer comprimat  
 HU Pneumatikus sarokcsiszoló  
 ES Cortadora neumática

**0.62**  
MPa

**113**  
l/min

**75x9.5**  
mm

**20000**  
min<sup>-1</sup>

STANDARD



$L_{pA} = 84,5 \pm 3,0$  dB;  $L_{wA} = 95,5 \pm 3,0$  dB;  $a_n = 2,45 \pm 1,5$  m/s<sup>2</sup>

No.	Required air flow / Wymagany przepływ powietrza [l/min]	Ø [min <sup>-1</sup> ]	Icon
81080	113	20000	20

EN Air shears pistol type  
 PL Nożyce pneumatyczne kątowe  
 DE Pneumatische Schere  
 RU Пневматические ножницы угловые  
 CZ Pneumatické nůžky na plech  
 RO Foarfeca pneumatică  
 HU Pneumatikus ollók  
 ES Tijera neumática

**0.62**  
MPa

**184**  
l/min

**3000**  
min<sup>-1</sup>

**5.5**  
mm

max  
**1.2**mm  
STEEL  
STYL

max  
**1.4**mm  
Al

STANDARD



$L_{pA} = 77,0 \pm 3,0$  dB;  $L_{wA} = 88,0 \pm 3,0$  dB;  $a_n = 4,42 \pm 1,5$  m/s<sup>2</sup>

No.	Required air flow / Wymagany przepływ powietrza [l/min]	Cutting speed / Prędkość cięcia [min <sup>-1</sup> ]	Icon
81072	184	3000	12



EN Air drill  
 PL Wiertarka pneumatyczna  
 DE Druckluft-Bohrmaschine  
 RU Пневматическая дрель  
 CZ Vrtáčka vzduchová  
 RO Mașină de găurit pneumatică  
 HU Pneumatikus fúró  
 ES Taladradora neumática

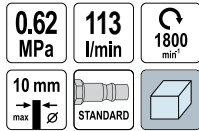

$L_{pa} = 94,2 \pm 3,0$  dB;  $L_{wa} = 105,2 \pm 3,0$  dB;  $a_v = 2,14 \pm 1,5$  m/s<sup>2</sup>

No.	Required air flow / Wymagany przepływ powietrza [l/min]	$\Omega$ [min <sup>-1</sup> ]	
81122	113	1800	10

EN Multi-purpose oscillating air tool  
 PL Wielofunkcyjne narzędzie oscylacyjne pneumatyczne  
 DE Druckluft-Multifunktionswerkzeuge  
 RU Пневматический многофункциональный инструмент  
 CZ Pneumatická oscilační multifunkční bruska  
 RO Multifuncțional oscilant pneumatic  
 HU Pneumatikus oszcilláló multifunkciós csiszoló  
 ES Estuche herramienta neumática multifunción

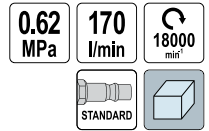

$L_{pa} = 87,5 \pm 3,0$  dB;  $L_{wa} = 98,5 \pm 3,0$  dB;  $a_v = 4,511 \pm 1,5$  m/s<sup>2</sup>

No.	Required air flow / Wymagany przepływ powietrza [l/min]	$\Omega$ [min <sup>-1</sup> ]	
81060	170	18000	10

EN Pneumatic tool set  
 PL Zestaw narzędzi pneumatycznych z akcesoriami  
 DE Druckluftwerkzeugsatz mit Zubehör  
 RU Пневматический ударный инструмент в наборе  
 CZ Sada pneumatického nářadí  
 RO Set pistol cu accesorii pneumatice  
 HU Légszerszámok készlet  
 ES Juego de herramientas neumáticas con accesorios

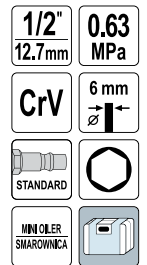

No.	$\varnothing$	Toolholder size / Rozmiar uchwytu narzędziowego	pcs / szt.	
81142	1/2" (12.7 mm)	1/4" (6.3 mm)	33	2

EN Inflating gun  
 PL Pistolet do pompowania  
 DE Inflatorpistole  
 RU Пистолет для накачивания  
 CZ Pistolet na čerpání z manometrem  
 RO Pistol cu manometru  
 HU Pumpáló pisztoly nyomásmérővel  
 ES Pistola de bombeo con manometro

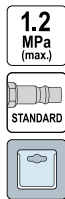

$L_{wa} = <70$  dB;  $a_v = <2,5$  m/s<sup>2</sup>

No.	
81650	10/40

EN Inflating gun  
 PL Pistolet do pompowania  
 DE Inflatorpistole  
 RU Пистолет для накачивания  
 CZ Pistolet na čerpání z manometrem  
 RO Pistol cu manometru  
 HU Pumpáló pisztoly nyomásmérővel  
 ES Pistola de bombeo con manometro

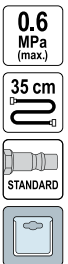

$L_{pa} = 88,0 \pm 3,0$  dB;  $L_{wa} = 99,0 \pm 3,0$  dB;  $a_v = <2,5$  m/s<sup>2</sup>

No.	
81651	30

EN Inflating head  
 PL Glowica do pompowania  
 DE Klemmnippel (universal)  
 RU Насадка на насос под шланг

CZ Hlava na čerpání  
 RO Cap pt. pompat  
 HU Pumpafej  
 ES Cabeza de bombeo



No.	Connector diameter / Średnica krócca [mm]	
81653	8	50/300
81661	6	50/300

EN Spray gun with fluid cup  
 PL Pistolet natryskowy  
 DE Lackierpistole mit Fließbecher  
 RU Пистолет-распылитель с бачком  
 CZ Pistole na lakování z nádrží  
 RO Pistol de vopsit cu rezervor  
 HU Festékszóró pisztoly  
 ES Pistola de barniz



$L_{pa} = 58,2 \text{ dB}$ ;  $L_{wa} = 69,2 \text{ dB}$



No.	Nozzle diameter / Średnica dyszy [mm]	
80902	1.4	10

EN Spray gun with fluid cup  
 PL Pistolet natryskowy  
 DE Lackierpistole mit Fließbecher  
 RU Краскораспылитель верхний бак  
 CZ Pistole na lakování z nádrží  
 RO Pistol de vopsit cu rezervor inferior  
 HU Festőpisztoly alsó tartállyal  
 ES Pistola de barniz



$L_{pa} < 70 \text{ dB}$ ;  $a_n < 2,5 \text{ m/s}^2$



No.	Nozzle diameter / Średnica dyszy [mm]	
81617	1.5	20

EN Spray gun with fluid cup  
 PL Pistolet natryskowy  
 DE Lackierpistole mit Fließbecher  
 RU Пистолет-распылитель с бачком  
 CZ Pistole na lakování z nádrží  
 RO Pistol de vopsit cu rezervor  
 HU Festékszóró pisztoly  
 ES Pistola de barniz

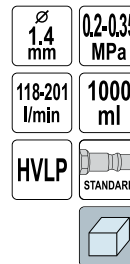

$L_{pa} = 61,2 \text{ dB}$ ;  $L_{wa} = 72,2 \text{ dB}$



No.	Nozzle diameter / Średnica dyszy [mm]	
80901	1.4	10

EN Spray gun with fluid cup  
 PL Pistolet natryskowy  
 DE Lackierpistole mit Fließbecher  
 RU Пистолет-распылитель с бачком  
 CZ Pistole na lakování z nádrží  
 RO Pistol de vopsit cu rezervor  
 HU Festékszóró pisztoly  
 ES Pistola de barniz

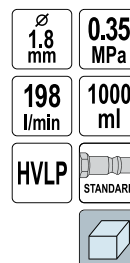

$L_{pa} = 85,0 \pm 2,5 \text{ dB}$ ;  $L_{wa} = 98,9 \pm 2,5 \text{ dB}$



No.	Nozzle diameter / Średnica dyszy [mm]	
80903	1.8	10

EN Spray gun with fluid cup  
 PL Pistolet natryskowy  
 DE Lackierpistole mit Fließbecher  
 RU Краскораспылитель верхний бак  
 CZ Pistole na lakování z nádrží  
 RO Pistol de vopsit cu rezervor inferior  
 HU Festőpisztoly alsó tartállyal  
 ES Pistola de barniz

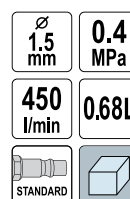

$L_{pa} < 70 \text{ dB}$ ;  $a_n < 2,5 \text{ m/s}^2$



No.	Nozzle diameter / Średnica dyszy [mm]	
81618	1.5	20

EN Spray gun kit  
 PL Zestaw lakierniczy  
 DE Lackierspritzsatz  
 RU Набор покрасочный пневматический  
 CZ Laková souprava  
 RO Set de lacuit  
 HU Részes fényezőkészlet  
 ES Juego de barniz



5  
PCS

STANDARD



No.	pcs / szt.	
81638	5	10

EN Blow gun  
 PL Pistolet do przedmuchiwania  
 DE Ausblaspistole  
 RU Пистолет для продувки короткий  
 CZ Pistolet na profukování kratká  
 RO Pistol scurt pt. suflat  
 HU Póvid előléfűvő pisztoly  
 ES Pistola de soplado

0.8  
MPa  
(max.)

STANDARD



$L_{pa} = 91,0 \pm 3,0$  dB;  $L_{wa} = 102,0 \pm 3,0$  dB;  $a_n < 2,5$  m/s<sup>2</sup>



No.	Nozzle pipe length / Długość dyszy [mm]	
81631	100	10/40

EN Blow gun  
 PL Pistolet do przedmuchiwania  
 DE Ausblaspistole  
 RU Пистолет для продувки короткий

CZ Pistolet na profukování kratká  
 RO Pistol scurt pt. suflat  
 HU Póvid előléfűvő pisztoly  
 ES Pistola de soplado

0.8  
MPa  
(max.)

STANDARD



$L_{pa} = 91,0 \pm 3,0$  dB;  $L_{wa} = 102,0 \pm 3,0$  dB;  $a_n < 2,5$  m/s<sup>2</sup>



No.	Nozzle pipe length / Długość dyszy [mm]	
81633	300	10/40

EN Blow gun  
 PL Pistolet do przedmuchiwania  
 DE Ausblaspistole  
 RU Пистолет для продувки короткий  
 CZ Pistolet na profukování kratká  
 RO Pistol scurt pt. suflat  
 HU Póvid előléfűvő pisztoly  
 ES Pistola de soplado

2.0  
mm

0.6  
MPa  
(max.)

STANDARD



$L_{wa} < 70$  dB;  $a_n < 2,5$  m/s<sup>2</sup>



No.	
81643	100

EN Blow gun  
 PL Pistolet do przedmuchiwania  
 DE Ausblaspistole  
 RU Пистолет для продувки короткий  
 CZ Pistolet na profukování kratká  
 RO Pistol scurt pt. suflat  
 HU Póvid előléfűvő pisztoly  
 ES Pistola de soplado

0.8  
MPa  
(max.)

STANDARD



$L_{pa} = 91,0 \pm 3,0$  dB;  $L_{wa} = 102,0 \pm 3,0$  dB;  $a_n < 2,5$  m/s<sup>2</sup>



No.	Nozzle pipe length / Długość dyszy [mm]	
81632	200	10/40

EN Blow gun  
 PL Pistolet do przedmuchiwania  
 DE Ausblaspistole  
 RU Пистолет для продувки короткий  
 CZ Pistolet na profukování kratká  
 RO Pistol scurt pt. suflat  
 HU Póvid előléfűvő pisztoly  
 ES Pistola de soplado

4.0  
mm

0.1-0.3  
MPa

STANDARD



$L_{wa} < 70$  dB;  $a_n < 2,5$  m/s<sup>2</sup>



No.	
81640	20/40

EN Blow gun with extension  
 PL Pistolet do przedmuchiwania z przedłużką  
 DE Gebläsepistole mit Verlängerung  
 RU Пистолет для продувки длинный

CZ Pistolet na profukování dlouhá  
 RO Pistol lung pt. suflat  
 HU Rövid előléfűvő pisztoly  
 ES Pistola de soplado

4.0  
mm

0.8  
MPa



$L_{wa} < 70$  dB;  $a_n < 2,5$  m/s<sup>2</sup>



No.	
81644	20/40

- EN Air blow gun kit
- PL Zestaw do przedmuchiwania
- DE Ausblaspistole Druckluft Set
- RU Набор для продувки
- CZ Pneumatická čistící pistole sada
- RO Pistol aer curatat praful cu furtun
- HU Fuvató pisztoly szett
- ES Kit pistola de aire aire bobina



**3**  
PCS

**PE**

$L_{pa} = 90,0 \text{ dB}$ ;  $L_{wa} = 101,0 \text{ dB}$ ;  $a_w = <2,5 \text{ m/s}^2$



No.		
81634		10/20

- EN Filter
- PL Filtr
- DE Filter
- RU Минифильтр
- CZ Filtr
- RO Minifiltru
- HU Szűrő
- ES Filtro

**G 1/4 BSPT**



No.	Thread size / Rozmiar gwintu	
81560	G1/4	10/50

- EN Pressure reducing valve with manometer
- PL Reduktor ciśnienia z manometrem
- DE Druckminderer mit Manometer
- RU Клапан уменьшения давления с манометром
- CZ Redukční ventil s manometrem
- RO Valva cu reducatiepresiune + manometru
- HU Nyomáscsökkentő szelep nyomásmérővel
- ES Reductor + manometro

**3/8"**  
**9,5mm**

**0-1,2**  
**MPa**



No.	Thread size / Rozmiar gwintu	
81562	G3/8	50

- EN Air filter regulator and lubricator
- PL Zespół filtrujący, reduktor + smarownica
- DE Druckfilter - Druckminderer + Entöler
- RU Фильтр-редуктор + смазочный прибор
- CZ Redukční ventil s odlučovačem oleje
- RO Filtru cu reduktor
- HU Levegőelőkészítő
- ES Juego de filtro, reductor + engrasador



No.	Thread size / Rozmiar gwintu	
81556	G1/2	20

- EN Washing gun
- PL Pistolet do ropowania
- DE Waschpistole
- RU Пистолет для нефтевания
- CZ Pistole na ropování
- RO Pistol (dozator) pt. motorină
- HU Olajzöpisztoly
- ES Pistola de petrolear



**0.8**  
**MPa**

**0.95L**

STANDARD

$L_{wa} = <70 \text{ dB}$ ;  $a_w = <2,5 \text{ m/s}^2$



No.		
81647		10/20

- EN In-line air tool oiler
- PL Naolejacz do narzędzi pneumatycznych
- DE Ölter für Druckluftwerkzeuge
- RU Масленка для пневматического инструмента
- CZ Olejníčka do pneumatických nářadí
- RO Gresor scule pneumatice
- HU Pneumatikus szerszám olajozó
- ES Lubricador para herramientas neumáticas

**G 1/4 BSPT**

**0.8**  
**MPa**  
(max.)

**5**  
**ml**



No.		
81570		20/100

- EN Filter - reductor
- PL Filtr - reduktor
- DE Druckfilter - Druckminderer
- RU Фильтр - редуктор
- CZ Filtr derukční ventil
- RO Filtru cu reductor
- HU Szűrő - nyomáscsökkentő
- ES Reductor - filtro

**1/2"**  
**12,7mm**

**0-0,1**  
**MPa**

**PC**

**°C -10**  
**+60**



No.	Thread size / Rozmiar gwintu	
81553	G1/2	20

**1/2"**  
**12,7mm**

**0-1**  
**MPa**

**PC**

**°C -10**  
**+60**





EN PE spiral tubes with rapid couplings  
 PL Wąż spiralny PE z szybkozłączami  
 DE Spiralschlauch mit Schnellkupplung  
 RU Шланг спиральный с быстроразъемным соединением  
 CZ Spirální hadice  
 RO Furtun în spirală  
 HU Spiráltömlő  
 ES Manguera espiral

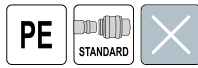

No.	Internal diameter / Średnica wewnętrzna [mm]	External diameter / Średnica zewnętrzna [mm]	L [m]	
81490	5	8	5	50
81491	5	8	10	25
81492	5	8	15	25

EN Armoured hose  
 PL Wąż zbrojony  
 DE Schlauch, verstärkt durch Bewehrung  
 RU Шланг армированный для подачи воздуха  
 CZ Hadice vyztužená  
 RO Furtun armat  
 HU Fémbetétes tömlő  
 ES Manguera armada

No.	Internal diameter / Średnica wewnętrzna [mm]	L [m]	Wall thickness / Grubość ścianki [mm]	ATM	
81519	6	50	2.5	10/40	1
81520	8	50	2.5	10/40	1
81521	10	50	2.5	10/40	1
81522	12	50	2.5	10/40	1
81523	14	50	3.0	10/40	1
81524	16	50	3.0	10/40	1
81525	19	50	3.5	10/40	1
81527	25	50	4.0	10/40	1

EN Quick coupler  
 PL Szybkozłącze  
 DE Schnellkupplung  
 RU Быстрое соединение  
 CZ Rychlospojka  
 RO Mufa rapidă pt. pistol pneumatic  
 HU Gyorscsatlakozó  
 ES Conexión de la entrada de aire

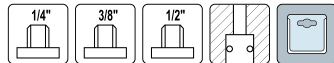

No.	Thread size / Rozmiar gwintu	
81370	G1/4	20/120
81371	G3/8	20/120
81372	G1/2	20/120

EN Quick coupler  
 PL Szybkozłącze  
 DE Schnellkupplung  
 RU Быстрое соединение  
 CZ Rychlospojka  
 RO Mufa rapidă pt. pistol pneumatic  
 HU Gyorscsatlakozó  
 ES Conexión de la entrada de aire

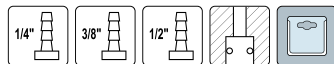

No.	Connector diameter / Średnica krócca [mm]	
81378	6	20/120
81379	8	20/120
81380	10	20/120

EN PU spiral tubes with rapid couplings  
 PL Wąż spiralny PU z szybkozłączami  
 DE Spiralschlauch mit Schnellkupplung  
 RU Шланг спиральный с быстроразъемным соединением  
 CZ Spirální hadice  
 RO Furtun în spirală  
 HU Spiráltömlő  
 ES Manguera espiral

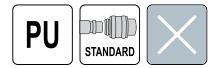

No.	Internal diameter / Średnica wewnętrzna [mm]	External diameter / Średnica zewnętrzna [mm]	L [m]	
81500	5	8	5	50
81501	5	8	10	25
81502	5	8	15	25

EN Armoured hose  
 PL Wąż zbrojony  
 DE Schlauch, verstärkt durch Bewehrung  
 RU Шланг армированный для подачи воздуха  
 CZ Hadice vyztužená  
 RO Furtun armat  
 HU Fémbetétes tömlő  
 ES Manguera armada



EN Quick coupler  
 PL Szybkozłącze  
 DE Schnellkupplung  
 RU Быстрое соединение  
 CZ Rychlospojka  
 RO Mufa rapidă pt. pistol pneumatic  
 HU Gyorscsatlakozó  
 ES Conexión de la entrada de aire



No.	Thread size / Rozmiar gwintu	
81373	G1/4	20/120
81374	G3/8	20/120

EN Quick coupler  
 PL Szybkozłącze  
 DE Schnellkupplung  
 RU Быстрое соединение  
 CZ Rychlospojka  
 RO Mufa rapidă pt. pistol pneumatic  
 HU Gyorscsatlakozó  
 ES Conexión de la entrada de aire

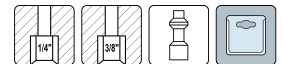

No.	Thread size / Rozmiar gwintu	
81390	G1/4	50/250
81391	G3/8	50/250

- EN Quick coupler
- PL Szybkozłącze
- DE Schnellkupplung
- RU Быстрое соединение
- CZ Rychlospojka
- RO Mufa rapida pt. pistol pneumatic
- HU Gyorscsatlakozó
- ES Conexión de la entrada de aire



No.	Thread size / Rozmiar gwintu	
81387	G1/4	50/250

- EN Pneumatic riveting machine
- PL Nitownica pneumatyczna
- DE Druckluft Nietzange
- RU Пневматический заклепочник
- CZ Pneumatická nýťovačka
- RO Presa pneumatica pt. nituit
- HU Pneumatikus popszegecszőző
- ES Máquina remachadora



$L_{pA} = 76,1 \pm 3$  dB;  $L_{wA} = 87,1 \pm 3$  dB;  $a_b = 0,85 \pm 0,59$  m/s<sup>2</sup>

No.	Ø [mm]	Max. piston stroke / Maks. skok tłoka siłownika [mm]	F [kg]	F [N]	
70280	2,4, 3,2, 4, 4,8	14	720	7060	10

- EN Quick coupler
- PL Szybkozłącze
- DE Schnellkupplung
- RU Быстрое соединение
- CZ Rychlospojka
- RO Mufa rapida pt. pistol pneumatic
- HU Gyorscsatlakozó
- ES Conexión de la entrada de aire

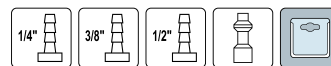

No.	Connector diameter / Średnica króćca [mm]	
81399	6	50/250
81400	8	50/250
81401	10	50/250



14 mm	85 l/min
0.63 MPa	720 kg / 7060 N
STANDARD	x4



Memo

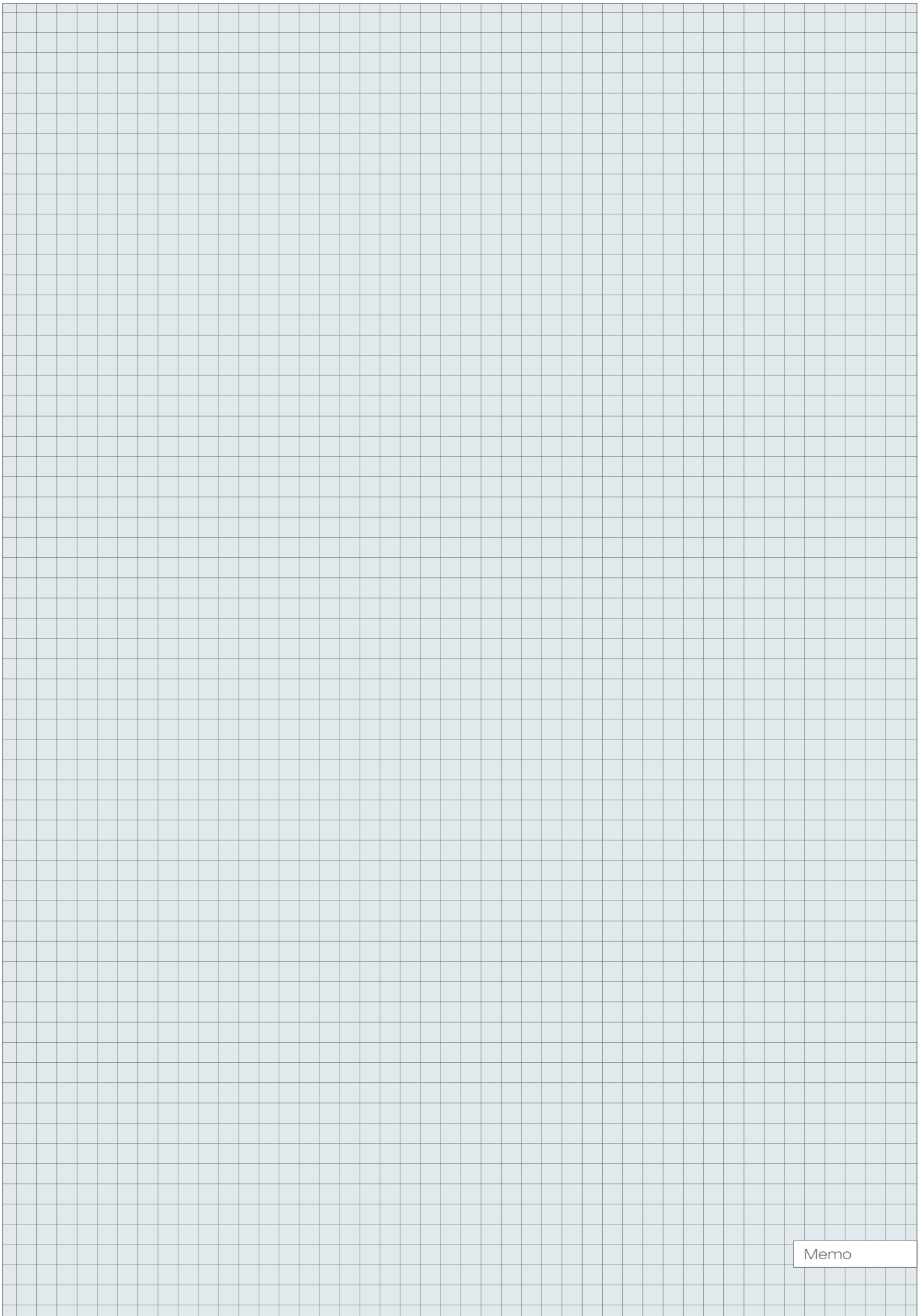

Memo

# 14

## Special automotive tools & equipment Narzędzia i wyposażenie warsztatu samochodowego





## Cabinets Szafki

216-220



### Roller cabinets with tools insert

Szafki serwisowe z narzędziami..... 216

### Tool cabinets

Szafki serwisowe..... 218

### Workbenches & workshop desks

Stoły i biurka warsztatowe..... 219

## Lubrication tools

### Narzędzia do smarowania

220-224



### Grease guns & oil transfer pumps

Smarownice ręczne i pompy transferowe do oleju..... 220

### Manual oil pumps

Pompy ręczne do oleju..... 222

### Oil cans

Oliwiarki..... 223

### Oil filter wrenches

Klucze do filtra oleju..... 223

## Pullers

### Ściągacze

225-226



### Gear pullers

Ściągacze do łożysk..... 225

### Spring pullers

Ściągacze do sprężyn..... 225

### Ball joint removers

Ściągacze do sworzni kulistych..... 226

## Workshop tools

### Narzędzia warsztatowe

226-233



### Wheel wrenches

Klucze do kół..... 226

### Piston ring compressors

Zaciskacze do pierścieni..... 227

### Spark plug sockets

Klucze do świec..... 227

### Vacuum pumps

Pompki podciśnieniowe..... 228

### Brake system tools

Narzędzia do obsługi układu hamulcowego..... 228

### Paint thickness & car voltage testers

Tester grubości lakieru i samochodowe próbniki napięcia..... 228

### Magnetic pick up tools

Chwytniki magnetyczne..... 229

### Workshop seats

Taborety warsztatowe..... 229

### Impact wrenches

Klucze udarowe..... 230

### Bottle & floor jacks

Dźwigniki słupkowe i podnośniki..... 230

### Scissors jacks

Podnośniki mechaniczne..... 230

### Accessories for jacks

Akcesoria do podnośników..... 231

### Jack stands

Podstawki pod samochód..... 231

### Porta power kits

Rozpieraki hydrauliczne..... 231

### Pull-back rams

Ściągacze blacharskie hydrauliczne..... 232

### Battery chargers

Prostowniki..... 232

### Battery testers

Testery akumulatorów..... 233

### Tire pressure gauges

Mierniki ciśnienia..... 233

### Chain blocks

Wciągarki łańcuchowe..... 233

## Car accessories

### Akcesoria samochodowe

234-243



### Air compressors

Kompresory..... 234

### Air wedges

Poduszki montażowe..... 234

### Tow ropes

Linki holownicze..... 234

### Battery clamp cleaners

Szczotki do czyszczenia klem..... 236

### Battery hydrometers

Próbniki akumulatorowe..... 236

### Booster cables

Wiązki przewodów awaryjnych..... 236

### Scrapers & brushes

Skrobaczki i szczotki..... 236

### Flexible funnels

Lejki..... 236

### Car vacuum cleaners

Odkurzacze samochodowe..... 238

### First aid kits

Apteczki..... 239

### Safety triangles

Trójkąty ostrzegawcze..... 239

### Ratchet tie downs

Taśmy do bagażu..... 239

EN Service tool cabinet with tools  
 PL Szafka serwisowa z narzędziami  
 DE Werkstattwagen mit Werkzeugen  
 RU Сервисный шкаф с инструментами  
 CZ Vozík servisní s náradím  
 RO Dulap echipat cu scule  
 HU Szerszámokcsiszerszámokkal  
 ES Carro taller con herramientas

177 PCS    901x770 x458 mm    6x    DRAWERS LOCKING BLOKADA SZUFLAD    CENTRAL LOCK BLOKADA CENTRALNA    2xT    ∅125mm    2x BRAKE HAMULEC    BALL BEARINGS ŁOŻYSKA KULKOWE    NON SLIP WORKTOP BLAT ANTY-POŚLĘGOWY    UNIVERSAL PERFORATION UNIWERSALNA PERFORACJA

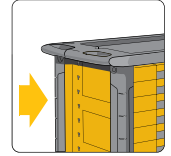

14

12 interchangeable trays with tools  
 12 wymiennych modułów z narzędziami



No.	Drawer quantity / Liczba szuflad	
58540	6	1

**Drawer 1 / Szuflada 1**

- 1/2" (12.7 mm): 10, 11, 12, 13, 14, 15, 16, 17, 18, 19, 20, 21, 22, 23, 24, 27, 30, 32 mm; CrV 50BV30;
- 1/2" (12.7 mm); (127 mm); CrV 50BV30;
- 1/2" (12.7 mm); CrV 50BV30;
- 1/2" (12.7 mm); (255 mm); 72T; CrV 6140;
- 1/2" (12.7 mm); (255 mm); CrV 50BV30;
- 1/2" (12.7 mm); 16, 21 mm; CrV 50BV30;
- 3/8" (9.5 mm): 6, 7, 8, 9, 10, 11, 12, 13, 14, 15, 16, 17, 18, 19, 20, 21, 22 mm; CrV 50BV30;
- 3/8" (9.5 mm); (76, 152.4 mm); CrV 50BV30;
- 3/8" (9.5 mm); CrV 50BV30;
- 3/8" (9.5 mm); (200 mm); 72T; CrV 6140;
- 3/8" (9.5 mm); (198 mm); CrV 50BV30;
- 1/4" (6.3 mm): 3.5, 4, 4.5, 5, 5.5, 6, 7, 8, 9, 10, 11, 12, 13, 14 mm; CrV 50BV30;
- 1/4" (6.3 mm): 8, 10, 11, 12, 13 mm; CrV 50BV30;
- 1/4" (6.3 mm); (50.8, 101.6 mm); CrV 6140;
- 1/4" (6.3 mm); CrV 50BV30;
- 1/4" (6.3 mm); (155 mm); 72T; CrV 6140;
- 1/4" (6.3 mm); (150 mm); CrV 50BV30;
- 1/4" (6.3 mm); (152.4 mm); CrV 50BV30

**Drawer 2 / Szuflada 2**

- 3x75 mm, 5x100 mm, 5x150 mm, 6x38 mm, 6x100 mm, 6x150 mm, 8x150 mm; CrV;
- PH0x100 mm, PH1x75 mm, PH1x100 mm, PH2x38 mm, PH2x100 mm, PH2x150 mm, PH3x150 mm; CrV;
- 180 mm;
- 160 mm;
- 160 mm;
- 160 mm; bent / wygięte

**Drawer 3 / Szuflada 3**

- 6x7, 8x9, 10x11, 12x13, 14x15, 16x17, 18x19 mm;
- 22, 24, 27, 28, 30, 32 mm;
- 6, 7, 8, 9, 10, 11, 12, 13, 14, 15, 16, 17, 18, 19, 20, 21 mm

**Drawer 4 / Szuflada 4**

- 1/2" (12.7 mm): 8, 9, 10, 11, 12, 13, 14, 15, 16, 17, 18, 19, 20, 21 mm (L=76 mm); CrV 50BV30;
- 1/2" (12.7 mm), 3/8" (9.5 mm);
- 4, 5, 6, 7, 8, 10, 12 mm (L=30 mm); 4, 5, 6, 7, 8, 10, 12 mm (L=75 mm); CrV;
- M5, M6, M7, M10, M12 (L=30 mm); M5, M6, M7, M10, M12 (L=75 mm); CrV;
- T20, T25, T30, T40, T45, T50, T55 (L=30 mm); T20, T25, T30, T40, T45, T50, T55 (L=75 mm); CrV;
- 300 g (L=300 mm);
- 40 mm (L=300 mm);
- 10x8x142 mm, 12x10x152 mm, 16x13x170 mm

EN Service tool cabinet with tools  
 PL Szafka serwisowa z narzędziami  
 DE Werkstattwagen mit Werkzeug  
 RU Сервисный шкаф с инструментами  
 CZ Vozík servisní s nářadím  
 RO Dulap echipat cu scule  
 HU Szerszámokosí szerszámokkal  
 ES Carro taller con herramientas

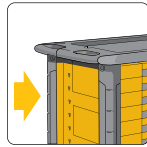

302 PCS 901x770 x458 mm 6x DRAWERS LOCKING BLOKADA SZUFLAD 2x125mm 2x BRAKE HAMULEC DOUBLE WALLS PODWÓJNE ŚCIANY BALL BEARINGS ŁOŻYSKA KULKOWE NON SLIP WORKTOP BLAT ANTY-POŚLIZGOWY UNIVERSAL PERFORATION UNIWERSALNA PERFORACJA



**Drawer 1 / Szuflada 1**

- 1/2" (12.7 mm): 10, 11, 12, 13, 14, 15, 16, 17, 18, 19, 20, 21, 22, 23, 24, 27, 30, 32 mm; CrV;
- 1/2" (12.7 mm): 45T; CrV;
- 1/2" (12.7 mm); CrV;
- 1/2" (12.7 mm); CrV;
- 1/2" (12.7 mm): 16, 21 mm; CrV;
- 3/8" (9.5 mm): 6, 7, 8, 9, 10, 11, 12, 13, 14, 15, 16, 17, 18, 19, 20, 21, 22 mm; CrV;
- 3/8" (9.5 mm); 2 PCS; CrV;
- 3/8" (9.5 mm); CrV;
- 3/8" (9.5 mm): 45T; CrV;
- 3/8" (9.5 mm); CrV;
- 1/4" (6.3 mm): 3.5, 4, 4.5, 5, 5.5, 6, 7, 8, 9, 10, 11, 12, 13, 14 mm; CrV;
- 1/4" (6.3 mm): E4, E5, E6, E7, E8; CrV;
- 1/4" (6.3 mm); CrV;
- 1/4" (6.3 mm); 2 PCS; CrV;
- 1/4" (6.3 mm); CrV;
- 1/4" (6.3 mm); CrV;
- 1/4" (6.3 mm); 45T; CrV;
- 1/4" (6.3 mm) x 1/4" (6.3 mm); CrV 50BV30;
- 1/4" (6.3 mm): 3, 4, 5.5, 6.5, 7, 8, 9 mm;
- 1/4" (6.3 mm); PH0, PH1, PH2, PH3;
- 1/4" (6.3 mm); P20, P21, P22, P23;
- 1/4" (6.3 mm): T8, T9, T10, T15, T20, T25, T27, T30;
- 1/4" (6.3 mm): T8, T9, T10, T15, T20, T25, T27, T30;
- 1/4" (6.3 mm): 3, 4, 5, 6, 7, 8 mm;
- 1/4" (6.3 mm): S0, S1, S2;
- 1/4" (6.3 mm): 4, 5.5, 6.5 mm; CrV;
- 1/4" (6.3 mm): PH1, PH2, PH3; CrV;
- 1/4" (6.3 mm): PZ1, PZ2, PZ3; CrV;
- 1/4" (6.3 mm): T8, T10, T15, T20, T25, T27, T30; CrV;
- 1/4" (6.3 mm): 5, 6, 7, 8 mm; CrV

**Drawer 2 / Szuflada 2**

- 3/8" (9.5 mm): 4, 5, 6, 7, 8, 10, 12 mm (L=30 mm); 4, 5, 6, 7, 8, 10, 12 mm (L=75 mm); AISI S2;
- 3/8" (9.5 mm): M5, M6, M8, M10, M12 (L=30 mm); M5, M6, M8, M10, M12 (L=75 mm); AISI S2;
- 3/8" (9.5 mm): T20, T25, T30, T40, T45, T50, T55 (L=30 mm); T20, T25, T30, T40, T45, T50, T55 (L=75 mm); AISI S2;
- 1/2" (12.7 mm) x 3/8" (9.5 mm), 3/8" (9.5 mm) x 3/8" (9.5 mm); CrV 6150;
- 1/2" (12.7 mm): 14, 15, 17, 19, 22 mm; CrV;
- 1/2" (12.7 mm): E18, E20, E24; CrV;
- 3/8" (9.5 mm): E10, E11, E12, E14, E16; CrV;
- 1/2" (12.7 mm); CrV;
- 1/2" (12.7 mm); CrV;
- 6, 7, 8, 9, 10, 11, 12, 13, 14, 15, 16, 17, 18, 19, 20, 21 mm

**Drawer 3 / Szuflada 3**

- 5/32" (4 mm); CrV 6150;
- 5/32" (4 mm): 1.0, 1.5, 2.0, 2.5, 3.0, 3.5 mm; CrV 6150;
- 5/32" (4 mm): PH000, PH00, PH0, PH1; CrV 6150;
- 5/32" (4 mm): PZ0, PZ1; CrV 6150;
- 5/32" (4 mm): T4, T5, T6, T7, T8, T9, T10, T15, T20; CrV 6150;
- 5/32" (4 mm): 0.7, 0.9, 1.3, 2.0, 2.5, 3.0, 4.0 mm; CrV 6150;
- 5/32" (4 mm): 2.5, 3.0, 3.5, 4.0, 4.5, 5.0, 5.5 mm; CrV;
- 2.0, 2.5, 3.0, 4.0, 5.0, 5.5, 6.0, 8.0, 10.0, 12 mm; CrV;
- T10, T15, T20, T25, T27, T30, T40, T45, T50; CrV;
- external straight / proste zewnętrzne;
- internal straight / proste wewnętrzne;
- external bent / wygięte zewnętrzne;
- internal bent / wygięte wewnętrzne;

**Drawer 4 / Szuflada 4**

- 30 Og;
- Ø28 mm;
- 12x150 mm, 16x170 mm;
- 1.5x150 mm, 3x150 mm, 5x150 mm, 8x150 mm;
- 6x100 mm, 2x140 mm;
- 3x75 mm, 5x100 mm, 6x100 mm, 8x150 mm; CrV;
- PH0x75 mm, PH1x100 mm, PH2x100 mm, PH3x150 mm; CrV;
- 300 mm;
- 300 mm;
- 300 mm;
- 300 mm;
- 300 mm;

12 interchangeable trays with tools

12 wymiennych modułów z narzędziami



No.	Drawer quantity / Liczba szuflad	
58550	6	1



- EN Roller cabinet
- PL Szafka serwisowa
- DE Werkstattrollwagen
- RU Инструментальный кабинет
- CZ Dilenská skříňka
- RO Dulap de scule
- HU Szerszámok kocsí
- ES Armario en ruedas

901x770 x458 mm	6x		DRAWERS LOCKING BLOKADA SZUFLAD	CENTRAL LOCK BLOKADA CENTRALNA
2x	∅125mm	2x	BALL BEARINGS ŁOŻYSKA KULKOWE	NON SLIP WORKTOP BLAT ANTY- POŚLIZGOWY
			UNIVERSAL PERFORATION UNIVERSALNA PERFORACJA	

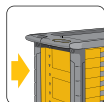

No.	Drawer quantity / Liczba szuflad	
58539	6	1

- EN Workshop trolley
- PL Wózek warsztatowy
- DE Werkstatt-Servicewagen
- RU Инструментальная тележка
- CZ Dilenský policový vozík
- RO Carucior pt. atelier
- HU Műhelykocsi
- ES Carro para taller

775x760 x355 mm	3 TRAYS TACE	max 120 kg	∅75mm	
-----------------------	--------------------	---------------	-------	--



No.	Tray quantity / Liczba pólek	
81860	3	1

- EN Roller cabinet
- PL Szafka serwisowa
- DE Werkstattrollwagen
- RU Инструментальный кабинет
- CZ Dilenská skříňka
- RO Dulap de scule
- HU Szerszámok kocsí
- ES Armario en ruedas

745x620 x335 mm	
-----------------------	--



No.	Drawer quantity / Liczba szuflad	
81830	6	1

- EN Shutter cabinet
- PL Szafka wisząca
- DE Hängeschrank
- RU Подвесной шкаф
- CZ Závěsná skříňka
- RO Dulap cu 2 usi
- HU Fügőgő szekrény
- ES Armario de pared

1125x265 x630 mm	
------------------------	--



No.	Dimensions / Wymiary [mm]	
58440	1125x265x630	1



EN Shutter cabinet  
 PL Szafka wisząca  
 DE Hängeschrank  
 RU Подвесной шкаф.  
 CZ Závěsná skříňka  
 RO Dulap cu 2 usi  
 HU Fügő szekrény  
 ES Armario de pared



No.	Dimensions / Wymiary [mm]	Icon
58441	1580x265x630	1

EN Workshop desk  
 PL Biurko warsztatowe  
 DE Schreibtisch für Werkstatt  
 RU Письменный стол для мастерской  
 CZ Pracovní stůlek  
 RO Masa de lucru  
 HU Munkasztal  
 ES Escritorio de trabajo



No.	Dimensions / Wymiary [mm]	Icon
58450	1160x600x830	1

EN Magnetic tool holder  
 PL Zestaw listew magnetycznych  
 DE Magnet Werkzeughalter  
 RU Магнитная рейка  
 CZ Magnetický držák nářadí  
 RO Suport magnetic  
 HU Mágneses tartó  
 ES Bandeja de accesorios magnética



No.	pcs / szt.	Icon
57830	3	6/12

EN Service utility key  
 PL Klucz do szafek serwisowych  
 DE Schaltschrank-Schlüssel für Gängige Schränke  
 RU Ключ для сервисных шкафов  
 CZ Klíč na rozvodné skříně  
 RO Cheie universală pt. panoul de comandă  
 HU Kapsolőszekrény kulcs  
 ES Llaves para armarios de control



No.	Icon
78477	12/72

EN Workbench  
 PL Stół warsztatowy  
 DE Werkstatttisch  
 RU Бесстак  
 CZ Pracovní stůl  
 RO Banc de lucru  
 HU Munkasztal  
 ES Mesa de trabajo

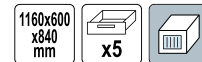

No.	Drawer quantity / Liczba szuflad	Dimensions / Wymiary [mm]	Icon
58455	5	1160x600x840	1

EN Workbench  
 PL Stół warsztatowy  
 DE Werkstatttisch  
 RU Бесстак  
 CZ Pracovní stůl  
 RO Banc de lucru  
 HU Munkaasztal  
 ES Mesa de trabajo

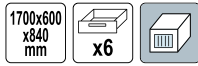

No.	Drawer quantity / Liczba szuflad	Dimensions / Wymiary [mm]	
58456	6	1700x600x840	1

EN Grease gun  
 PL Smarownica ręczna  
 DE Handhebel-Fettpresse  
 RU Шприц для смазки ручной  
 CZ Maznice páková  
 RO Pistol de gresat  
 HU Karos zsírzó  
 ES Pistola de engrase manual



No.	Tank capacity / Pojemność zbiornika [cm³]	
78040	400	10

EN Grease gun  
 PL Smarownica ręczna  
 DE Handhebel-Fettpresse  
 RU Шприц для смазки ручной  
 CZ Maznice páková  
 RO Pistol de gresat  
 HU Karos zsírzó  
 ES Pistola de engrase manual

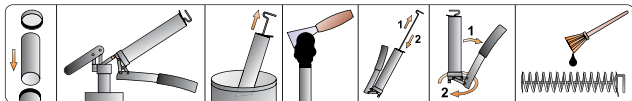
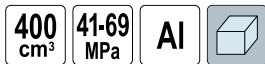

No.	Tank capacity / Pojemność zbiornika [cm³]	
78041	400	5/10

EN Work bench  
 PL Stolik monterski  
 DE Montagetisch  
 RU Монтажный столик  
 CZ Montérský stůl  
 RO Banc de lucru  
 HU Szerelőasztal  
 ES Mesa para bricolaje



No.	
29420	1

EN Grease gun  
 PL Smarownica ręczna  
 DE Handhebel-Fettpresse  
 RU Шприц для смазки ручной  
 CZ Maznice páková  
 RO Pistol de gresat  
 HU Karos zsírzó  
 ES Pistola de engrase manual



No.	Tank capacity / Pojemność zbiornika [cm³]	
78046	400	10

EN Grease gun  
 PL Smarownica ręczna  
 DE Handhebel-Fettpresse  
 RU Шприц для смазки ручной  
 CZ Maznice páková  
 RO Pistol de gresat  
 HU Karos zsírzó  
 ES Pistola de engrase manual

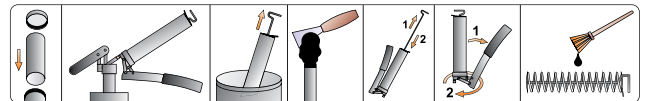
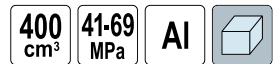

No.	Tank capacity / Pojemność zbiornika [cm³]	
78042	400	5/10

EN Grease gun  
 PL Smarownica ręczna  
 DE Handhebel-Fettpresse  
 RU Шприц для смазки ручной  
 CZ Maznice páková  
 RO Pistol de gresat  
 HU Karos zsírító  
 ES Pistola de engrase manual

500 cm<sup>3</sup> 



No.	Tank capacity / Pojemność zbiornika [cm <sup>3</sup> ]	
78047	500	10

EN Grease gun  
 PL Smarownica ręczna  
 DE Handhebel-Fettpresse  
 RU Шприц для смазки ручной  
 CZ Maznice páková  
 RO Pistol de gresat  
 HU Karos zsírító  
 ES Pistola de engrase manual

600 cm<sup>3</sup> 41-69 MPa AI 

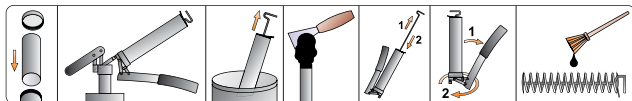

No.	Tank capacity / Pojemność zbiornika [cm <sup>3</sup> ]	
78043	600	6/12

EN Grease gun  
 PL Smarownica ręczna  
 DE Handhebel-Fettpresse  
 RU Шприц для смазки ручной  
 CZ Maznice páková  
 RO Pistol de gresat  
 HU Karos zsírító  
 ES Pistola de engrase manual

120 g AI 



No.	Tank capacity / Pojemność zbiornika [g]	
78039	120	30

EN Heavy duty jaw couplers  
 PL Zestaw końcówek czteroczęściowych do smarownic  
 DE Mundstücksatz für Handhebel-Fettpressen  
 RU Соединительные патроны для масляного пистолета  
 CZ Sada koncovek k mazacímu lisu  
 RO Doza de legatura  
 HU Tömítő csatlakozó karos zsírítóhoz  
 ES Juego de boquillas para engrasadores

4 PCS  $\varnothing$  15 mm 6-7 mm G 1/8-28 



No.	$\varnothing$ [mm]	pcs / szt.	
78061	15	4	20/80

EN Push type grease gun  
 PL Smarownica wyciskowa  
 DE Press-Fettspritze  
 RU Шприц смазочный нажимной  
 CZ Rázový mazací lis  
 RO Gresor  
 HU Kézi olajozó  
 ES Engrasador

80 g 



No.	Tank capacity / Pojemność zbiornika [g]	
78037	80	40

EN Flexible tube for grease gun  
 PL Wążek do townitnicy  
 DE Schlauch für Fettpresse  
 RU Шприц для перекачки масел  
 CZ Hadička na maznice na šmír  
 RO Furtun flexibil pt. pistol de gresat  
 HU Tömítő a zsírítóhoz  
 ES Manguera para engrasador

240 mm 



No.	L [mm]	
78045	240	50/250

EN Flexible hose for grease gun  
 PL Wążek giętki do smarownic  
 DE Schlauch für Fettpresse  
 RU Гибкий шланг для тоwnитницы  
 CZ Hadička na maznice na šmír  
 RO Furtun flexibil pt. pistol de gresat  
 HU Tömítő a zsírítóhoz  
 ES Manguera para engrasador

6-7 mm G 1/8-28 31 MPa 





No.	L [mm]	Max. pressure / Maks. ciśnienie [MPa]	
78067	300	31	50/250
78068	500	31	50/250

EN Manual oil pump  
 PL Pompa ręczna do oleju  
 DE Öl-Umfüllpumpe  
 RU Ручной насос для перекачки масел  
 CZ Pumpa ruční na olej  
 RO Pompa manuala apa ulei  
 HU Kézi olajszivattyú  
 ES Bomba manual para aceite

**19**  
l/min

FOR OIL  
DO  
OLEJU



No.	Max. capacity / Maks. wydajność [l/min]	
78000	19	5

EN Manual oil pump  
 PL Pompa ręczna do oleju  
 DE Öl-Umfüllpumpe  
 RU Ручной насос для перекачки масел  
 CZ Pumpa ruční na olej  
 RO Pompa manuala apa ulei  
 HU Kézi olajszivattyú  
 ES Bomba manual para aceite

**20**  
l/min

x3  
PIPE  
RURRA

FOR OIL  
DO  
OLEJU

**AI**



No.	Max. capacity / Maks. wydajność [l/min]	
78002	20	10

EN Manual oil pump  
 PL Mini pompa ręczna do oleju  
 DE Öl-Umfüllpumpe  
 RU Ручной насос для перекачки масел  
 CZ Pumpa ruční na olej  
 RO Pompa manuala apa ulei  
 HU Kézi olajszivattyú  
 ES Bomba manual para aceite

**15**  
l/min

FOR OIL  
DO  
OLEJU

**MINI**

**AI**



No.	Max. capacity / Maks. wydajność [l/min]	
78003	15	20

14

EN Self-priming fuel pump  
 PL Samozasysający wąż do paliwa  
 DE Selbstansaugender Kraftstoffschlauch  
 RU Шланг с обратным клапаном для перекачки топлива  
 CZ Přečerpávací hadice se samonasávacím ventilem  
 RO Furtun pt. transfer lichide  
 HU Üzemanyag légtelenítő kézi pumpa  
 ES Manguera aspiración manual

13  
mm

**180**  
cm

SELF-  
PRIMING  
SAMO-  
ZASYSAJĄCY

PVC





No.	
83009	6/24

EN Electric engine oil extractor pump  
 PL Elektryczna pompa do odsysania oleju silnikowego  
 DE Elektrische Ölabsaugpumpe  
 RU Электрический насос для перекачки масла  
 CZ Elektrické čerpadlo na odsávání oleje  
 RO Pompă electrică de scos ulei  
 HU Elektromos olaj szivattyú  
 ES Bomba eléctrica extractora de aceite de motor

**80**  
W

**12V**

**3**  
l/min



No.	Power / Moc [W]	
78007	80	10

EN Oil drainer  
 PL Odsysarka ręczna do oleju  
 DE Öl-Absaugpumpe  
 RU Ручной шприц для откачки масла  
 CZ Ruční odsávačka oleje  
 RO Pompa de ulei  
 HU Kézi olajszivattyú  
 ES Bomba manual de trasvase

**200**  
cm<sup>3</sup>





No.	Tank capacity / Pojemność zbiornika [cm <sup>3</sup> ]	
78030	200	10

EN Oil drainer  
 PL Odsysarka ręczna do oleju  
 DE Öl-Absaugpumpe  
 RU Ручной шприц для откачки масла  
 CZ Ruční odsávačka oleje  
 RO Pompa de ulei  
 HU Kézi olajszivattyú  
 ES Bomba manual de trasvase

**400**  
cm<sup>3</sup>



No.	Tank capacity / Pojemność zbiornika [cm <sup>3</sup> ]	
78031	400	10



EN Oil drainer  
 PL Odsysarka ręczna do oleju  
 DE Öl-Absaugpumpe  
 RU Ручной шприц для откачки масла  
 CZ Ruční odsávačka oleje  
 RO Pompa de ulei  
 HU Kézi olajszivattyú  
 ES Bomba manual de trasvase

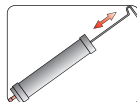

No.	Tank capacity / Pojemność zbiornika [cm³]	Box
78044	500	10/20

EN Manual car oil pump  
 PL Odsysarka ręczna do oleju  
 DE Manuelle Öl-Absaugpumpe  
 RU Ручной насос для откачки масла  
 CZ Ruční vakuová odsávačka oleje a kapalin  
 RO Pompă de aspirație pt. aspirația uleiului  
 HU Kézi pumpás olajleszívó  
 ES Bomba de vacío para aspiración de aceite



No.	Tank capacity / Pojemność zbiornika [l]	Box
78032	6	4

EN Oil can with flexible hose  
 PL Oliwiarka z wężykiem  
 DE Ölkanne mit flexiblem Aufsatz  
 RU Масленка с гибким шлангом  
 CZ Olejova mазnice  
 RO Cana ulei cu furtun flexibil  
 HU Olajozó kanna, hajlékony tömlővel  
 ES Aceitera



No.	Capacity / Pojemność [ml]	Box
78306	200	10/60

EN Oil can with rigid spout  
 PL Oliwiarka z końcówką sztywną  
 DE Ölkanne mit starrem Aufsatz  
 RU Масленка с твердым наконечником  
 CZ Olejová mазnice  
 RO Cana ulei cu furtun rigid  
 HU Olajozó kanna, merev szárral  
 ES Aceitera



No.	Capacity / Pojemność [ml]	Box
78303	300	10/60

EN Manual oil pump  
 PL Pompa ręczna do oleju  
 DE Öl-Umfüllpumpe  
 RU Ручной насос для перекачки масел

CZ Pumpa ruční na olej  
 RO Pompa manuala apa ulei  
 HU Kézi olajszivattyú  
 ES Bomba manual para aceite



No.	Tank capacity / Pojemność zbiornika [cm³]	Box
78035	500	10

EN Oil can  
 PL Oliwiarka  
 DE Ölkanne  
 RU Масленка  
 CZ Mазnička  
 RO Pompiță de ulei  
 HU Olajozó  
 ES Aceitera



No.	Capacity / Pojemność [ml]	Box
78300	300	15/60

EN Oiler  
 PL Oliwiarka  
 DE Ölkanne  
 RU Масленка  
 CZ Olejníčka  
 RO Gresor  
 HU Olajozó  
 ES Aceitera



No.	Capacity / Pojemność [ml]	Box
78301	250	6/72

EN Oil filter wrench  
 PL Klucz do filtra oleju  
 DE Ölfilterschlüssel  
 RU Съёмник масляного фильтра  
 CZ Klíč na olejový filtr  
 RO Cheie pt. filtru de ulei  
 HU Olajszűrő leszedő  
 ES Llave para filtro de aceite



No.	Ø	Ø [mm]	Box
57600	1/2" (12.7 mm), 3/8" (9.5 mm)	65-110	6/36

EN Oil filter wrench  
 PL Klucz do filtra oleju zaciskowy  
 DE Ölfilterschlüssel  
 RU Съёмник масляных фильтров зажимной

CZ Klíč na filtr oleju svěrácí  
 RO Cheie cu strângere pt. filtru de ulei  
 HU Olajszűrő kulcs, pattintos  
 ES Llave de filtro de aceite

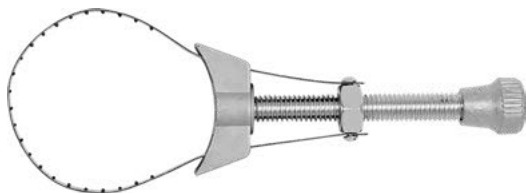
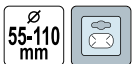

No.	Ø [mm]	Icon
57610	55-110	10/50

EN Oil filter wrench  
 PL Klucz do filtra oleju  
 DE Ölfilterschlüssel  
 RU Съёмник масляного фильтра

CZ Klíč na olejový filtr  
 RO Cheie pt. filtru de ulei  
 HU Olajszűrő leszedő  
 ES Llave para filtro de aceite



No.	Icon
57630	10/40

EN Oil filter wrench  
 PL Klucz do filtra oleju  
 DE Ölfilterschlüssel  
 RU Съёмник масляного фильтра  
 CZ Klíč na olejový filtr  
 RO Cheie pt. filtru de ulei  
 HU Olajszűrő leszedő  
 ES Llave para filtro de aceite



No.	Ø	Ø [mm]	Icon
57660	3/8" (9.5 mm)	64-80	6/36

EN Oil filter wrench  
 PL Klucz do filtra oleju  
 DE Ölfilterschlüssel  
 RU Съёмник масляного фильтра

CZ Klíč na olejový filtr  
 RO Cheie pt. filtru de ulei  
 HU Olajszűrő leszedő  
 ES Llave para filtro de aceite



No.	Ø [mm]	Icon
57612	73-85	12/48
57613	83-95	12/48
57614	93-111	12/48

EN Oil filter wrench  
 PL Klucz do filtra oleju  
 DE Ölfilterschlüssel  
 RU Съёмник масляного фильтра  
 CZ Klíč na olejový filtr  
 RO Cheie pt. filtru de ulei  
 HU Olajszűrő leszedő  
 ES Llave para filtro de aceite



No.	Icon
57620	10/100

EN Oil filter wrench  
 PL Klucz do filtra oleju  
 DE Ölfilterschlüssel  
 RU Съёмник масляного фильтра

CZ Klíč na olejový filtr  
 RO Cheie pt. filtru de ulei  
 HU Olajszűrő leszedő  
 ES Llave para filtro de aceite



No.	Icon
57640	25/100



EN Strap wrench set  
 PL Zestaw kluczy taśmowych do filtrów oleju  
 DE Ölfilter-Bandschlüssel-Set  
 RU Набор ленточных ключей для масляных фильтров  
 CZ Sada řemenových klíčů na olejové filtry  
 RO Set chei cu banda  
 HU Olajszűrő leszedő készlet  
 ES Juego de llaves de correa para filtros de aceite

CZ Klíč na olejový filtr  
 RO Cheie pt. filtru de ulei  
 HU Olajszűrő leszedő  
 ES Llave para filtro de aceite

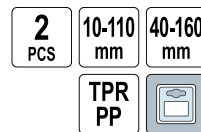

No.	Ø [mm]	pcs / szt.	Icon
57616	10-110, 40-160	2	6/24

EN Gear puller  
 PL Ściągacz do łożysk  
 DE Dreiarmliger Abzieher  
 RU Съёмник подшипников 3-х лапчатый  
 CZ Stahovák na ložiska  
 RO Clește cu 3 brațe pt. extras rulmenți  
 HU Hidraulikus csapágyelhúzó  
 ES Extractor de cojinetes



No.	Size / Rozmiar	Jaws range / Rozstaw szczęk [mm]	Arm quantity / Liczba ramion	
80500	3"	75	3	4/40
80510	4"	100	3	5/30
80520	6"	150	3	2/20
80530	8"	200	3	2/12

EN Coil spring compressor  
 PL Ściągacz do sprężyn  
 DE Federspanner  
 RU Съёмник пружин  
 CZ Stahovák pružin  
 RO Presă pt. arcuiri  
 HU Rugóösszehúzó  
 ES Desmontador para los resortes

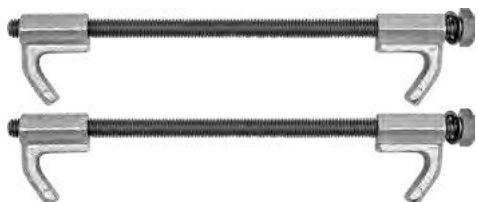

No.	pcs / szt.	
80600	2	6/12

EN Coil spring compressor  
 PL Ściągacz do sprężyn  
 DE Federspanner  
 RU Съёмник пружин  
 CZ Stahovák pružin  
 RO Presă pt. arcuiri  
 HU Rugóösszehúzó  
 ES Desmontador para los resortes

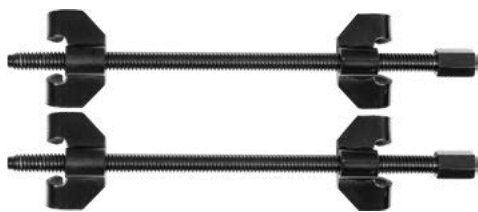
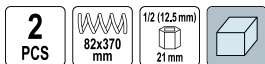

No.	Ø [mm]	L [mm]	pcs / szt.	
80602	82	370	2	12

EN Removal tool set  
 PL Zestaw łomów  
 DE Brechslangensatz  
 RU Набор ломов  
 CZ Sada páčidel  
 RO Set leviere  
 HU Feszítővas készlet  
 ES Juego de palancas



No.	Size / Rozmiar [mm]	pcs / szt.	
34182	16x305, 21x450	2	6/24

EN Gear puller  
 PL Ściągacz do łożysk  
 DE Abzieher-2-armig  
 RU Съёмник для подшипников  
 CZ Stahovák  
 RO Extractor rulmenți  
 HU Csapágyelhúzó  
 ES Extractor



No.	Size / Rozmiar	Jaws range / Rozstaw szczęk [mm]	Wrench size / Rozmiar klucza [mm]	Arm quantity / Liczba ramion	
80470	3"	75	14	2	30
80471	4"	100	17	2	24
80472	5"	125	17	2	20
80473	6"	150	19	2	12
80474	8"	200	22	2	6

EN Coil spring compressor  
 PL Ściągacz do sprężyn  
 DE Federspanner  
 RU Съёмник пружин  
 CZ Stahovák pružin  
 RO Presă pt. arcuiri  
 HU Rugóösszehúzó  
 ES Desmontador para los resortes

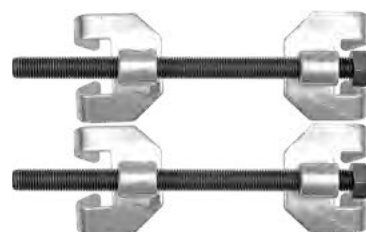

No.	pcs / szt.	
80601	2	10

EN Precision screwdriver and hook set  
 PL Zestaw precyzyjnych wkręteków i haczyków  
 DE Präzisions-Schraubendreher- und Haken-Satz  
 RU Набор точных отверток и крючков  
 CZ Sada přesných šroubováků a háčků  
 RO Set surubelnite de precizie  
 HU Precíziós csavarhúzó és kampó készlet  
 ES Set de destornilladores precisos y ganchos

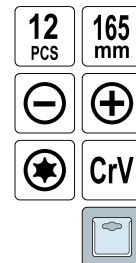

2.5, 3.5 mm;  
 PH00, PH0;  
 T6, T7, T8, T10;  
 45°, 90°, 135°, 180°



No.	pcs / szt.	
64555	12	10/40

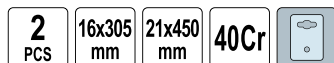

EN Removal tool set  
 PL Zestaw łomów  
 DE Brechstangensatz  
 RU Набор ломов  
 CZ Sada páčidel  
 RO Set leviere  
 HU Feszítővas készlet  
 ES Juego de palancas

4 PCS  
 11x195 mm  
 16x305 mm  
 21x445 mm  
 21x600 mm  
 40Cr



No.	Size / Rozmiar [mm]	pcs / szt.	
34184	11x195, 16x305, 21x445, 21x600	4	2/12

EN Tie rod end lifter  
 PL Ściągacz do sworzni kulistych  
 DE Universal-Kugelgelenk-Abzieher  
 RU Съёмник шаровых опор  
 CZ Stahovák kulových čepů řízení  
 RO Extractor pt. articulatii sferice  
 HU Gömbfej kinyomó  
 ES Extractor de pernos esféricos

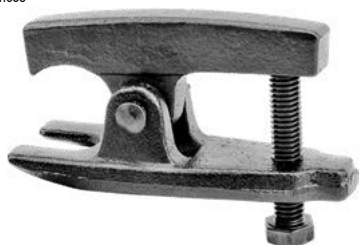

No.	pcs / szt.
80640	25

14

EN Cross rim wrench  
 PL Krzyżakowy klucz do kół  
 DE Kreuzschlüssel  
 RU Ключ-крест балонный  
 CZ Klíč na kola křížový  
 RO Cheie în cruce pt. roți  
 HU Kereszt kerékkulcs  
 ES Llave cruz para ruedas



No.	Size / Rozmiar	
57000	17x19x22x13/16" (20.6 mm)	20

EN Cross rim wrench  
 PL Krzyżakowy klucz do kół  
 DE Kreuzschlüssel  
 RU Ключ-крест балонный  
 CZ Klíč na kola křížový  
 RO Cheie în cruce pt. roți  
 HU Kereszt kerékkulcs  
 ES Llave cruz para ruedas



No.	Size / Rozmiar	
57020	17x19x21x12" (12.7 mm)	10

EN Tie rod end lifter  
 PL Ściągacz do sworzni kulistych  
 DE Universal-Kugelgelenk-Abzieher  
 RU Съёмник шаровых опор  
 CZ Stahovák kulových čepů řízení  
 RO Extractor pt. articulatii sferice  
 HU Gömbfej kinyomó  
 ES Extractor de pernos esféricos



No.	
80620	25/50

EN Tire lever set  
 PL Zestaw łyzek do opon  
 DE Reifenlöfl-Satz  
 RU Набор шинных ложек  
 CZ Sada lžic na pneumatiky  
 RO Set leviere  
 HU Abroncs leszedő szerszámkészlet  
 ES Juego de palancas para neumáticos

4 PCS  
 12" 300 mm  
 16" 395 mm  
 20" 495 mm  
 24" 595 mm  
 HARDENED STEEL  
 STAL  
 HARTOWANA

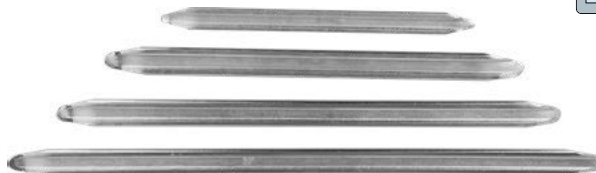

No.	pcs / szt.	
56980	4	10

EN Cross rim wrench  
 PL Krzyżakowy klucz do kół  
 DE Kreuzschlüssel  
 RU Ключ-крест балонный  
 CZ Klíč na kola křížový  
 RO Cheie în cruce pt. roți  
 HU Kereszt kerékkulcs  
 ES Llave cruz para ruedas



No.	Size / Rozmiar [mm]	
57010	17x19x21x23	20





EN Cross rim wrench  
 PL Krzyżakowy klucz do kół  
 DE Kreuzschlüssel  
 RU Ключ-крест балонный  
 CZ Klíč na kola křížový  
 RO Cheie în cruce pt. roți  
 HU Kereszt kerékkulcs  
 ES Llave cruz para ruedas



No.	Size / Rozmiar [mm]	Icon
57030	17x19x22x23	20

EN L-type wheel wrench  
 PL Klucz do kół rozsuwany  
 DE Teleskop-Radmutternschlüssel  
 RU Ключ баллонный телескопический  
 CZ Teleskopický klíč na kola  
 RO Cheie pt. roți extensibilă  
 HU Kihúzható kerékkulcs  
 ES Llave para ruedas extensible

360-510 mm 17 mm 19 mm 1/2" 12,7 mm



1/2" (12.7 mm): 17 x 19 mm



No.	Size / Rozmiar [mm]	L [mm]	Ø	Icon
57100	17x19	360-510	1/2" (12.7 mm)	10/20

EN Spark plug wrench  
 PL Klucz do świecec  
 DE Zündkerzenschlüssel  
 RU Ключ свечной  
 CZ Svíčkový klíč  
 RO Cheie pt. buji  
 HU Gyertyakulcs  
 ES Llave para bujias



No.	Size / Rozmiar [mm]	L [mm]	Icon
57160	16	150	25/50
57210	21	150	25/50

EN Spark plug wrench  
 PL Klucz do świecec  
 DE Zündkerzenschlüssel  
 RU Ключ свечной  
 CZ Svíčkový klíč  
 RO Cheie pt. buji  
 HU Gyertyakulcs  
 ES Llave para bujias



No.	Size / Rozmiar [mm]	L [mm]	Icon
57220	16	260	50
57221	21	260	20/40

EN Cross rim wrench  
 PL Krzyżakowy klucz do kół  
 DE Kreuzschlüssel  
 RU Ключ-крест балонный  
 CZ Klíč na kola křížový  
 RO Cheie în cruce pt. roți  
 HU Kereszt kerékkulcs  
 ES Llave cruz para ruedas



No.	Size / Rozmiar	Icon
57050	24x27x32x31/4" (19.0 mm)	5

EN Piston ring compressor  
 PL Zaciskacz do pierścieni  
 DE Kolbenring-Spannband  
 RU Зажим колец  
 CZ Svěčka na kroužky  
 RO Clește pt. strâns inele  
 HU Gyűrűbepattintó  
 ES Pinza para anillos

AISI 304 65Mn



No.	Ø [mm]	H [mm]	Icon
80660	50-125	75	36
80661	75-175	100	36

EN Spark plug wrench  
 PL Klucz do świecec  
 DE Zündkerzenschlüssel  
 RU Ключ свечной  
 CZ Svíčkový klíč  
 RO Cheie pt. buji  
 HU Gyertyakulcs  
 ES Llave para bujias

16/21 mm 150 mm



14



No.	Size / Rozmiar [mm]	L [mm]	Icon
57260	16/21	150	25/50

ERGONOMIC HANDLE ERGONOMIČNÝ UCHVŤ



- EN Hand-held vacuum pump
- PL Pompka podciśnieniowa z akcesoriami
- DE Unterdruckpumpe mit Zubehör
- RU Насос вакуумметрического давления с принадлежностями
- CZ Podtlaková pumpa s příslušenstvím
- RO Pompa de vidare cu accesorii
- HU Vákuum- és ac-pumpa mérő, tartozékokkal
- ES Bomba de subpresión con accesorios

**16**  
PCS

**-0.1**  
MPa



No.	pcs
81690	10

- EN Brake piston wind back
- PL Separator do zacisków hamulcowych
- DE Separator für Bremssattel
- RU Сепаратор для тормозных суппортов
- CZ Oddělovač brzdových třmenů
- RO Extractor disc de frana
- HU Féknyereg dugattyú
- ES Separador para pinzas de freno

**5**  
PCS



Audi, VW, Ford, Honda, Jaguar, Mazda, Mitsubishi, Nissan, Rover, Saab, Subaru, Skoda, Toyota, Volvo



No.	pcs
57730	10/20

- EN Paint thickness tester
- PL Tester grubości lakieru
- DE Lackdickenmessgerät
- RU Толщиномер лакокрасочного покрытия
- CZ Tester tloušťky laku
- RO Tester de buzunar grosime vopsea
- HU Rétegvastagság mérő
- ES Medidor de espesor de recubrimiento

**0-2.0**  
mm

**±2%**  
ACCURACY  
BOKLAGNÖSSE

**ALUMINIUM**  
ALUMINIUM

**STEEL**  
STEEL



No.	pcs
81731	40/80

- EN Automotive circuit tester
- PL Wskaźnik elektryczny samochodowy
- DE KFZ-Spannungsprüfer
- RU Пробник автомобильный
- CZ Automobilová zkoušečka napětí
- RO Tester pt. circuite auto
- HU Autós fázisceruza
- ES Comprobador de voltaje para auto

No.	Measuring range / Zakres pomiaru [V d.c.]	pcs
65270	6-24	20/200

- EN Flare nut wrenches
- PL Klucze do przewodów hamulcowych
- DE Bremsleitungsschlüsselsatz
- RU Набор ключей разрезных
- CZ Klíče na vedení brzd
- RO Cheie pt. conducte de frână
- HU Fékcsőkulcs
- ES Llaves para tubería de frenado

**3**  
PCS



No.	pcs / szt.	pcs
57700	3	12/60

- EN Disc brake piston tool
- PL Uniwersalny klucz do wkręcania zacisków hamulcowych
- DE Bremskolbenrücksteller universal
- RU Ключ для тормозного поршня
- CZ Univerzální klíč k montáži brzdových třmenů
- RO Dispozitiv pt. împins etrier
- HU Féknyereg összenyomó
- ES Llave para comprimir pistones del freno de disco

**3/8"**  
**9.5 mm**

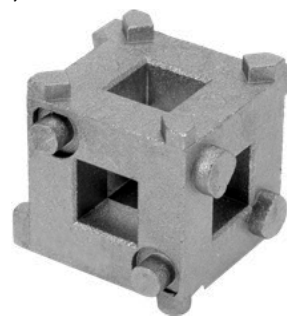

No.	pcs
57740	3/8" (9.5 mm) 6/72

- EN Automotive circuit tester
- PL Wskaźnik elektryczny samochodowy
- DE KFZ-Spannungsprüfer
- RU Пробник автомобильный
- CZ Automobilová zkoušečka napětí
- RO Tester pt. circuite auto
- HU Autós fázisceruza
- ES Comprobador de voltaje para auto



No.	Measuring range / Zakres pomiaru [V d.c.]	pcs
65260	6-24	20/200



EN Pick-up tool  
 PL Łapka do podnoszenia  
 DE Starer Greifer  
 RU Гибкий захват „Pick-up”  
 CZ Patka pro zdvihání  
 RO Surubelnita flexibila  
 HU Emelőlapka  
 ES Grifo para recoger pick up



No.	L [mm]	Box icon
78400	600	50/150

EN Flexible pick-up handle, magnetic  
 PL Łapka magnetyczna, giętka  
 DE Magnetisch flexiber Greifer  
 RU Гибкий магнитный захват  
 CZ Vytahovák magnetický ohebný  
 RO Surubelnita flexibila magnetica  
 HU Mágneses felszedő eszköz, hajlékony nyél  
 ES Grifo magnético flexible



No.	L [mm]	Box icon
78401	600	50/100

EN LED magnetic pick up tool  
 PL Chwytnak teleskopowy LED  
 DE LED Magnet Heber  
 RU Захват магнитный телескопический с подсветкой  
 CZ Patka magnetická teleskopická LED  
 RO Telescop magnetic cu LED  
 HU LED felszedő mágnes teleszkópos nyéllel  
 ES Herramienta para levantar, telescopica, con LED

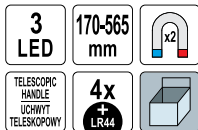

No.	Light source / Źródło światła [LED]	Battery type / Rodzaj baterii	Box icon
78405	3	4x LR44	12/48

EN Pneumatic car seat  
 PL Taboret warsztatowy teleskopowy  
 DE Werkstattthocker, teleskopisch  
 RU Табурет рабочий подъемный  
 CZ Dílenský taburet teleskopický  
 RO Scaun atelier telescopic  
 HU Teleszkópos műhely zsámoly  
 ES Taburete de taller telescópico

No.	Max. load capacity / Maks. obciążenie [kg]	Box icon
81825	135	4

EN Telescopic pick up and mirror set  
 PL Zestaw inspekcyjny: lusterko + chwytak  
 DE Inspektionsatz: Spiegel + Greifer  
 RU Проверочный набор - держатель и зеркальце  
 CZ Inspekční souprava: zrcadlo + držák  
 RO Garnitură de control: oglindă + benă  
 HU Teleszkópos ellenőrző készlet: tükör + felvevő  
 ES Juego de inspección: espejo + cuchara de mordazas

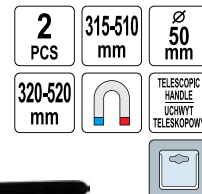

No.	pcs / szt.	Box icon
78410	2	25/100

EN Magnetic wristband  
 PL Opaska magnetyczna  
 DE Haftmagnet  
 RU Браслет магнитный  
 CZ Magnetický pás  
 RO Bratara magnetica  
 HU Mágneses szalag  
 ES Banda magnética



No.	L [mm]	Box icon
78756	320	12/96

EN Workshop seat with drawer  
 PL Taboret warsztatowy z szufladą  
 DE Werkstattthocker mit Schublade  
 RU Табурет рабочий с ящиком  
 CZ Dílenský taburet se zásuvkou  
 RO Taburet atelier cu sertar  
 HU Műhely zsámoly fiókkal  
 ES Taburete de taller con cajón



No.	Max. load capacity / Maks. obciążenie [kg]	Box icon
81824	90	4



EN Electric impact wrench  
 PL Elektryczny klucz udarowy  
 DE Elektro-Schlagschrauber  
 RU Электрический гайковерт  
 CZ Elektrický rázový uťahovák  
 RO Pistol de impact electric  
 HU Elektromos ütvecsavarozó  
 ES llave de impacto eléctrica

230V~50Hz 800 W 2200 min<sup>-1</sup> 325 Nm 1/2" 12.7mm



$L_{pA} = 87,5 \pm 3,0$  dB;  $L_{wA} = 98,5 \pm 3,0$  dB;  $a_n = 9,93 \pm 1,5$  m/s<sup>2</sup>

No.	Power / Moc [W]	∅ [min <sup>-1</sup> ]	
57091	800	2200	5

EN Electric impact wrench  
 PL Elektryczny klucz udarowy  
 DE Elektro-Schlagschrauber  
 RU Электрический гайковерт  
 CZ Elektrický rázový uťahovák  
 RO Pistol de impact electric  
 HU Elektromos ütvecsavarozó  
 ES llave de impacto eléctrica

230-240V~50Hz 1100 W 2200 min<sup>-1</sup> 450 Nm 1/2" 12.7mm



$L_{pA} = 89,0 \pm 3,0$  dB;  $L_{wA} = 100,0 \pm 3,0$  dB;  $a_n = 10,04 \pm 1,5$  m/s<sup>2</sup>

No.	Power / Moc [W]	∅ [min <sup>-1</sup> ]	
57092	1100	2200	2

EN Electric impact wrench  
 PL Elektryczny klucz udarowy  
 DE Elektro-Schlagschrauber  
 RU Электрический гайковерт  
 CZ Elektrický rázový uťahovák  
 RO Pistol de impact electric  
 HU Elektromos ütvecsavarozó  
 ES llave de impacto eléctrica



230-240V~50Hz 1100 W 2200 min<sup>-1</sup> 800 Nm 3/4" 19mm 24mm 30mm 32mm 36mm 4m

$L_{pA} = 89,0 \pm 3,0$  dB;  $L_{wA} = 100,0 \pm 3,0$  dB;  $a_n = 10,04 \pm 1,5$  m/s<sup>2</sup>

No.	Power / Moc [W]	∅ [min <sup>-1</sup> ]	
57097	1100	2200	2

EN Hydraulic bottle jack  
 PL Podnośnik hydrauliczny słupkowy  
 DE Hydraulischer Stempelwagenheber  
 RU Домкрат гидравлический

CZ Pístový zvedák hydraulický  
 RO Cric hidraulic  
 HU Hidraulikus emelő  
 ES Gato hidráulico de botella



No.	Max. lifting capacity / Maks. udźwign [t]	Lifting range / Zakres podnoszenia [mm]	
80012	2	140-260	6
80022	3	168-326	6
80032	5	185-355	4
80042	8	190-365	4
80052	10	195-375	4
80062	12	200-380	3
80072	15	205-390	2
80082	20	217-402	2

EN Hydraulic floor jack  
 PL Podnośnik hydrauliczny  
 DE Hydraulischer Rangierwagenheber  
 RU Домкрат гидравлический  
 CZ Pístový zvedák hydraulický  
 RO Cric tip crocodil  
 HU Krokodil emelő  
 ES Gato hidráulico

2t 340 135mm



No.	Max. lifting capacity / Maks. udźwign [t]	Lifting range / Zakres podnoszenia [mm]	
80111	2	135-340	1



EN Scissors jack  
 PL Podnośnik mechaniczny trapezowy  
 DE Trapezwagenheber  
 RU Домкрат механический ромбовый  
 CZ Lichoběžníkový zvedák  
 RO Cric mecanic  
 HU Trapézemelő  
 ES Gato mecanico-trapezoidal



No.	Max. lifting capacity / Maks. udźwig [t]	Lifting range / Zakres podnoszenia [mm]	
80252	1.5	95-390	5

EN Rubber pad for jacks  
 PL Podkładka gumowa do podnośnika  
 DE Gumminterlage für Wagenheber  
 RU Резиновая шайба для домкрата  
 CZ Gumová podložka zvedáku  
 RO Talpa de cauciuc pentru cricuri  
 HU Gumipogácsa krokodilemelőhöz  
 ES Almohadilla de caucho para gatos



No.	Ø [mm]	
80107	97	200

EN Jack stand  
 PL Podstawka pod samochód  
 DE Unterstellbock  
 RU Подставка автомобильная  
 CZ Podstavec pod auto  
 RO Capra auto  
 HU Gépkocsi alátét  
 ES Caballete para auto



No.	Max. load capacity / Maks. obciążenie [t]	Lifting range / Zakres podnoszenia [mm]	pcs / szt.	
80307	2	265-390	2	4
80308	3	275-415	2	4
80309	6	360-585	2	2

EN Porta power repair kit  
 PL Rozpierałk hydrauliczny  
 DE Hydraulischer Richt und Ausbeulsatz  
 RU Гидравлическая распорная стойка в наборе

CZ Hydraulický rozpěrák  
 RO Trusa pompa hidraulica + accesorii  
 HU Hidraulikus bontó  
 ES Gato carrocerro hidráulico



No.	Max. load capacity / Maks. obciążenie [t]	
80402	4	1

EN Scissors jack  
 PL Podnośnik mechaniczny trapezowy  
 DE Trapezwagenheber  
 RU Домкрат механический ромбовый  
 CZ Lichoběžníkový zvedák  
 RO Cric mecanic  
 HU Trapézemelő  
 ES Gato mecanico-trapezoidal



No.	Max. lifting capacity / Maks. udźwig [t]	Lifting range / Zakres podnoszenia [mm]	
80271	1.2	100-350	4

EN Jack stand  
 PL Podstawka pod samochód  
 DE Unterstellbock  
 RU Подставка автомобильная  
 CZ Podstavec pod auto  
 RO Capra auto  
 HU Gépkocsi alátét  
 ES Caballete para auto



No.	Max. load capacity / Maks. obciążenie [t]	Lifting range / Zakres podnoszenia [mm]	
80300	2	250-380	5

EN Jack stand  
 PL Podstawka pod samochód  
 DE Unterstellbock  
 RU Подставка автомобильная  
 CZ Podstavec pod auto  
 RO Capra auto  
 HU Gépkocsi alátét  
 ES Caballete para auto

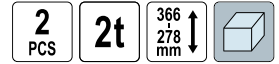

No.	Max. load capacity / Maks. obciążenie [t]	Lifting range / Zakres podnoszenia [mm]	pcs / szt.	
80312	2	278-366	2	5



- EN Porta power repair kit  
 PL Rozpieraek hydrauliczny  
 DE Hydraulischer Richt und Ausbeulsatz  
 RU Гидравлическая распорная стойка в наборе
- CZ Hydraulický rozpěrák  
 RO Trusa pompa hidraulica + accesorii  
 HU Hidraulikus bontó  
 ES Gato carroceros hidráulico

10t



No.	Max. load capacity / Maks. obciążenie [t]	
80412	10	1

- EN Pull-back ram  
 PL Ściągacz blacharski hydrauliczny  
 DE Hydraulische Zugzylinderheit  
 RU Гидравлическая стяжка-крюк  
 CZ Klemprifské stahovadlo hydraulické  
 RO Carlig hidraulic tractare  
 HU Hidraulikus lemezkihúzó  
 ES Extractor de latonería de fontanero

10t 55 MPa 660 mm



14



No.	Max. load capacity / Maks. obciążenie [t]	Operating pressure / Ciśnienie robocze [MPa]	
80450	10	55	4

- EN Electronic battery charger  
 PL Prostownik elektroniczny  
 DE Elektronisches Ladegerät  
 RU Электронное зарядное устройство  
 CZ Elektronická nabíječka  
 RO Redresor electric  
 HU Elektronikus akkumulátortöltő  
 ES Cargador de batería para coche

max 4A CHARGING CURRENT PRĄD ŁADUNKOWY  
 230V~50Hz  
 12V 2.8 A  
 8-60 Ah WET MOKRY  
 LED DISPLAY WYŚWIETLACZ



No.	Charging voltage / Napięcie ładowania [V d.c.]	Charging current / Prąd ładowania [A]	Charging battery capacity / Pojemność ładowanego akumulatora [Ah]	
82541	12	2.8	8-60	10

- EN Accessories for porta power  
 PL Pompa do rozpieraeka hydraulicznego  
 DE Druckeinheit für hydraulischer Spreizer  
 RU Ручной насос для гидравлической распорной стойки  
 CZ Pumpa na hydraulický rozpěrák  
 RO Pompa hidraulica  
 HU Szivattyú hidraulikus bontóhoz  
 ES Bomba hidraulica para gato carroceros



No.	Max. load capacity / Maks. obciążenie [t]	
80320	4	2
80330	10	2

- EN Accessories for porta power  
 PL Siłownik do rozpieraeka hydraulicznego  
 DE Kraftzylinder für hydraulischer Spreizer  
 RU Сервомотор для гидравлической распорной стойки  
 CZ Servomotor na hydraulický rozpěrák  
 RO Accesorii pompa hidraulica  
 HU Erőátvitel a hidraulikus bontóhoz  
 ES Cilindro para gato carroceros



No.	Max. load capacity / Maks. obciążenie [t]	
80340	4	4
80350	10	4

- EN Electronic battery charger  
 PL Prostownik elektroniczny  
 DE Elektronisches Ladegerät  
 RU Электронное зарядное устройство  
 CZ Elektronická nabíječka  
 RO Redresor electric  
 HU Elektronikus akkumulátortöltő  
 ES Cargador de batería para coche

max 6A CHARGING CURRENT PRĄD ŁADUNKOWY  
 230V~50Hz  
 12V 4.2 A  
 12-90 Ah WET MOKRY  
 LED DISPLAY WYŚWIETLACZ



No.	Charging voltage / Napięcie ładowania [V d.c.]	Charging current / Prąd ładowania [A]	Charging battery capacity / Pojemność ładowanego akumulatora [Ah]	
82542	12	4.2	12-90	10

EN Electronic battery charger  
 PL Prostownik elektroniczny  
 DE Elektronisches Ladegerät  
 RU Электронное зарядное устройство  
 CZ Elektronická nabíječka  
 RO Redresor electric  
 HU Elektronikus akkumulátortöltő  
 ES Cargador de batería para coche



max 8A CHARGING CURRENT PRĄD ŁADOWANIA  
 230V~ 50Hz  
 6V 12V  
 5.8 A 12-120 Ah  
 WET MOKRY LED DISPLAY WYŚWIETLACZ

No.	Charging voltage / Napięcie ładowania [V d.c.]	Charging current / Prąd ładowania [A]	Charging battery capacity / Pojemność ładowanego akumulatora [Ah]	
82543	6/12	5.8	12-120	5

EN Electronic battery charger  
 PL Prostownik elektroniczny  
 DE Elektronisches Ladegerät  
 RU Электронное зарядное устройство  
 CZ Elektronická nabíječka  
 RO Redresor electric  
 HU Elektronikus akkumulátortöltő  
 ES Cargador de batería para coche



max 12A CHARGING CURRENT PRĄD ŁADOWANIA  
 230V~ 50Hz  
 6V 12V  
 10.3 A 26-210 Ah  
 WET MOKRY LED DISPLAY WYŚWIETLACZ

No.	Charging voltage / Napięcie ładowania [V d.c.]	Charging current / Prąd ładowania [A]	Charging battery capacity / Pojemność ładowanego akumulatora [Ah]	
82544	6/12	10.3	26-210	5

EN Battery tester  
 PL Tester akumulatorów  
 DE Batterieprüfgerät  
 RU Тестер аккумуляторов  
 CZ Tester akumulátorů  
 RO Tester acumulatori  
 HU Akkuteszter  
 ES Tester para acumuladores



12V BATTERY TEST TEST AKUMULATORA ALTERNATOR TEST TEST ALTERNATORA

No.	
81741	24/48

EN Pressure gauge  
 PL Wskaźnik ciśnienia  
 DE Druckanzeige  
 RU Манометр  
 CZ Tlakomer  
 RO Indicator de presiune  
 HU Nyomásmérő  
 ES Manómetro



0.05-0.75 MPa

No.	Measuring range / Zakres pomiaru [MPa/bar]	
82610	0.05-0.75 / 0.5-7.5	25/150

EN Pressure gauge  
 PL Wskaźnik ciśnienia  
 DE Druckanzeige  
 RU Манометр  
 CZ Tlakomer  
 RO Indicator de presiune  
 HU Nyomásmérő  
 ES Manómetro



0.05-0.3 MPa

No.	Measuring range / Zakres pomiaru [MPa/bar]	
82611	0.05-0.3 / 0.5-3	10

EN Pressure gauge  
 PL Wskaźnik ciśnienia  
 DE Druckanzeige  
 RU Манометр  
 CZ Tlakomer  
 RO Indicator de presiune  
 HU Nyomásmérő  
 ES Manómetro



0.05-0.75 MPa

No.	Measuring range / Zakres pomiaru [MPa/bar]	
82650	0.05-0.75 / 0.5-7.5	10/100

EN Chain block  
 PL Wyciągarka łańcuchowa  
 DE Kettenzug Flaschenzug  
 RU Таль цепная  
 CZ Zvedák řetězový  
 RO Scripte cu lant  
 HU Láncos csigasor emelő  
 ES Cabria de cadena



No.	Max. load capacity / Maks. obciążenie [kg]	Chain length / Długość łańcucha [m]	
80751	1000	3	1
80752	2000	3	1
80753	3000	3	1

- EN Car air compressor
- PL Kompresor samochodowy
- DE Auto-Kompressor
- RU Автомобильный компрессор
- CZ Automobilový kompresor
- RO Compresor auto
- HU Autókompresszor
- ES Compresor de coche

12V 10A 1.7 MPa (max.) 



No.	Voltage / Napięcie [V d.c.]	
82100	12	12

- EN Car air compressor
- PL Kompresor samochodowy
- DE Auto-Kompressor
- RU Автомобильный компрессор
- CZ Automobilový kompresor
- RO Compresor auto
- HU Autókompresszor
- ES Compresor de coche

120 W 12V 35 l/min  
1.0 MPa 1 m 3 m 



No.	Voltage / Napięcie [V d.c.]	Power / Moc [W]	
82107	12	120	8

- EN Air pump wedge set
- PL Zestaw poduszek montażowych
- DE Montagekissen-Set
- RU Набор монтажных подушек
- CZ Rozpínací polštářky
- RO Set perne de aer
- HU Szerelőpárna készlet
- ES Juego de bolsas de cuña de aire

2 PCS 50 mm max 135 kg  
TPU 



No.	Size / Rozmiar [mm]	pcs / szt.	
39005	190x115, 130x270	2	60

- EN Rechargeable air compressor
- PL Kompresor bezprzewodowy
- DE Kabelloser Kompressor
- RU Беспроводной компрессор
- CZ Bezdrátový kompresor
- RO Compresor de aer reincărcabil
- HU Vezeték nélküli kompresszor
- ES Compresor inalámbrico

0.69 MPa 25 l/min 7.4 V 2000mAh Li-Ion  
4-6h 40 cm USB CHARGING LADOWANIE 



No.	Battery voltage / Napięcie akumulatora [V d.c.]	
82120	7.4	20

- EN Air wedge
- PL Poduszka montażowa
- DE Luft Keil
- RU Монтажная подушка
- CZ Rozpínací montážní polštář
- RO Perna de aer
- HU Emelőpárna
- ES Cojines elevadores

50 mm max 135 kg  
TPU 



No.	Size / Rozmiar [mm]	
39000	160x160	120
39001	190x115	120
39002	130x270	60

- EN Tow rope
- PL Linka holownicza
- DE Abschleppseil
- RU Трос автомобильный буксировочный
- CZ Těžký provázek
- RO Șufă pt. remorcare
- HU Vonatökötél
- ES Cable de remolque

max 1500 kg 



No.	Gross vehicle mass GVM / Dopuszczalna masa całkowita pojazdu [kg]	
82201	1500	20



EN Tow rope  
 PL Linka holownicza  
 DE Abschleppseil  
 RU Трос автомобильный буксировочный  
 CZ Tážný provázek  
 RO Șufă pt. remorcare  
 HU Vonatókötél  
 ES Cable de remolque



No.	Gross vehicle mass GVM / Dopuszczalna masa całkowita pojazdu DMC [kg]	
82205	2500	10

EN Tow rope  
 PL Linka holownicza  
 DE Abschleppseil  
 RU Трос автомобильный буксировочный  
 CZ Tážný provázek  
 RO Șufă pt. remorcare  
 HU Vonatókötél  
 ES Cable de remolque



No.	Gross vehicle mass GVM / Dopuszczalna masa całkowita pojazdu DMC [kg]	
82200	3500	12

EN Tow rope  
 PL Linka holownicza  
 DE Abschleppseil  
 RU Трос автомобильный буксировочный  
 CZ Tážný provázek  
 RO Șufă pt. remorcare  
 HU Vonatókötél  
 ES Cable de remolque



No.	Gross vehicle mass GVM / Dopuszczalna masa całkowita pojazdu DMC [kg]	
82227	3500	20

EN Tow rope  
 PL Linka holownicza z szeklą  
 DE Abschleppseil  
 RU Трос автомобильный буксировочный  
 CZ Tážný provázek  
 RO Șufă pt. remorcare  
 HU Vonatókötél  
 ES Cable de remolque



No.	Gross vehicle mass GVM / Dopuszczalna masa całkowita pojazdu DMC [kg]	
82234	3500	12

EN Tow rope  
 PL Linka holownicza  
 DE Abschleppseil  
 RU Трос автомобильный буксировочный  
 CZ Tážný provázek  
 RO Șufă pt. remorcare  
 HU Vonatókötél  
 ES Cable de remolque



No.	Gross vehicle mass GVM / Dopuszczalna masa całkowita pojazdu DMC [kg]	
82209	2500	8

EN Tow rope  
 PL Linka holownicza  
 DE Abschleppseil  
 RU Трос автомобильный буксировочный  
 CZ Tážný provázek  
 RO Șufă pt. remorcare  
 HU Vonatókötél  
 ES Cable de remolque



No.	Gross vehicle mass GVM / Dopuszczalna masa całkowita pojazdu DMC [kg]	
82206	3500	12

EN Tow rope  
 PL Linka holownicza z szeklą  
 DE Abschleppseil  
 RU Трос автомобильный буксировочный  
 CZ Tážný provázek  
 RO Șufă pt. remorcare  
 HU Vonatókötél  
 ES Cable de remolque



No.	Gross vehicle mass GVM / Dopuszczalna masa całkowita pojazdu DMC [kg]	
82232	2500	16

EN Tow rope  
 PL Linka holownicza z hakiem  
 DE Abschleppseil  
 RU Трос автомобильный буксировочный  
 CZ Tážný provázek  
 RO Șufă pt. remorcare  
 HU Vonatókötél  
 ES Cable de remolque



No.	Gross vehicle mass GVM / Dopuszczalna masa całkowita pojazdu DMC [kg]	
82231	1500	20

- EN Tow rope
- PL Linka holownicza z hakiem
- DE Abschleppseil
- RU Трос автомобильный буксировочный
- CZ Táhací provázek
- RO Șulă pt. remorcare
- HU Vonatókötél
- ES Cable de remolque



No.	Gross vehicle mass GVM / Dopuszczalna masa całkowita pojazdu DMC [kg]	
82233	2500	16

- EN Battery clamps cleaner
- PL Szczotka do czyszczenia klem
- DE Klemmbürste
- RU Щетка для зачистки клемм
- CZ Kartáč pro čištění svorek
- RO Perie curatat borne auto
- HU Akkumulátorsaru tisztító kefe
- ES Cepillo para limpiar bornes



No.		
82445		10/100

- EN Battery hydrometer
- PL Próbnik akumulatorowy
- DE Batteriesäureprüfer
- RU Ареометр аккумуляторный
- CZ Akumulátorový zkoušeč
- RO Instrument de verificare acumulator
- HU Akkumulátorpróbaló
- ES Probador de acumulador



No.		
82520		10/100

- EN Window squeegee
- PL Guma do szyb z drewnianą rączką
- DE Scheibenreiniger-Holzstiel
- RU Стеклоочиститель с резинкой
- CZ Guma do skel z dřevěnou rukojetí
- RO Lamă-ștergător cu miner de lemn pt. geamuri
- HU Vízelhúzó gumi fa nyéllel
- ES Goma para cristales con mango de madera



No.		
82920		50

- EN Battery clamps cleaner
- PL Szczotka do czyszczenia klem
- DE Klemmbürste
- RU Щетка для зачистки клемм
- CZ Kartáč pro čištění svorek
- RO Perie curatat borne auto
- HU Akkumulátorsaru tisztító kefe
- ES Cepillo para limpiar bornes



No.		
82440		10/160

- EN Battery clamps
- PL Komplet klem do akumulatora
- DE Aku-Polklemmen
- RU Клеммы аккумуляторные
- CZ Sada svorek na akumulátor
- RO Set de cleme pt. acumulator
- HU Akkumulátorsaru készlet
- ES Juego de bornes para acumulador



No.	pcs / szt.	
82431	2	12/120

- EN Boosters cables
- PL Wiązka przewodów awaryjnych
- DE Starthilfekabel
- RU Старт-кабель
- CZ Spouštěcí kabele
- RO Cabluri de alimentare
- HU Indítókábel
- ES Pinzas de arranque



No.	Rated load / Obciążenie nominalne [A]	
82502	200	6
82504	400	6
82506	600	6

- EN Flexible funnel
- PL Lejek
- DE Trichter
- RU Воронка гибкая
- CZ Nálievka
- RO Pálnie
- HU Kétrészes tölcser
- ES Embudo



No.		
83000		30

EN Flexible funnel  
 PL Lejek  
 DE Trichter  
 RU Воронка гибкая  
 CZ Nálevka  
 RO Pálnie  
 HU Kétrészes tölcser  
 ES Embudo



No.		
83001		30

EN Flexible funnel  
 PL Lejek  
 DE Trichter  
 RU Воронка гибкая  
 CZ Nálevka  
 RO Pálnie  
 HU Kétrészes tölcser  
 ES Embudo



No.		
83002		30

EN Agricultural funnel  
 PL Lejek rolniczy  
 DE Trichter  
 RU Воронка гибкая  
 CZ Nálevka  
 RO Pálnie  
 HU Kétrészes tölcser  
 ES Embudo



No.	Ø [mm]	
83003	210	25

EN Agricultural funnel  
 PL Lejek rolniczy  
 DE Trichter  
 RU Воронка гибкая  
 CZ Nálevka  
 RO Pálnie  
 HU Kétrészes tölcser  
 ES Embudo



No.	Ø [mm]	
83004	210	25

EN Angled funnel with strainer  
 PL Lejek skośny z sitkiem  
 DE Schräger Trichter mit Sieb  
 RU Наклонная воронка с фильтром  
 CZ Třuchtýř šikmý se sítkem  
 RO Pálnie înclinată cu sită  
 HU Ferde tölcser szűrővel  
 ES Embudo oblicuo con filtro



No.	Ø [mm]	
83016	130	70

EN Angled funnel with strainer  
 PL Lejek skośny z sitkiem  
 DE Schräger Trichter mit Sieb  
 RU Наклонная воронка с фильтром  
 CZ Třuchtýř šikmý se sítkem  
 RO Pálnie înclinată cu sită  
 HU Ferde tölcser szűrővel  
 ES Embudo oblicuo con filtro



No.	Ø [mm]	
83017	130	70

EN Angled funnel with strainer  
 PL Lejek skośny z sitkiem  
 DE Schräger Trichter mit Sieb  
 RU Наклонная воронка с фильтром  
 CZ Třuchtýř šikmý se sítkem  
 RO Pálnie înclinată cu sită  
 HU Ferde tölcser szűrővel  
 ES Embudo oblicuo con filtro



No.	Ø [mm]	
83018	130	70

EN Funnel  
 PL Lejek  
 DE Trichter  
 RU Воронка гибкая

CZ Nálevka  
 RO Pálnie  
 HU Kétrészes tölcser  
 ES Embudo



No.	Ø [mm]	H [mm]	pcs / szt.	
83005	52, 76, 100, 120	75, 110, 125, 152	4	30

EN Car vacuum cleaner  
 PL Odkurzacz samochodowy  
 DE Handsauger  
 RU Ручной пылесос для автомобиля  
 CZ Vysavač do auta  
 RO Aspirator de masina  
 HU Autó porszívó  
 ES Aspirador para coche

60 W 7.4 V 2000mAh Li-Ion 4-6h 18-20 min USB CHARGING ŁADOWANIE HEPA



**LUND**

No.	Battery voltage / Napięcie akumulatora [V d.c.]	Power / Moc [W]	
82955	7.4	60	30

EN Car vacuum cleaner  
 PL Odkurzacz samochodowy  
 DE Handsauger  
 RU Ручной пылесос для автомобиля  
 CZ Vysavač do auta  
 RO Aspirator de masina  
 HU Autó porszívó  
 ES Aspirador para coche

100 W 12V CYCLONIC CYKLONOWY BAGLESS BEZ-WORKOWY

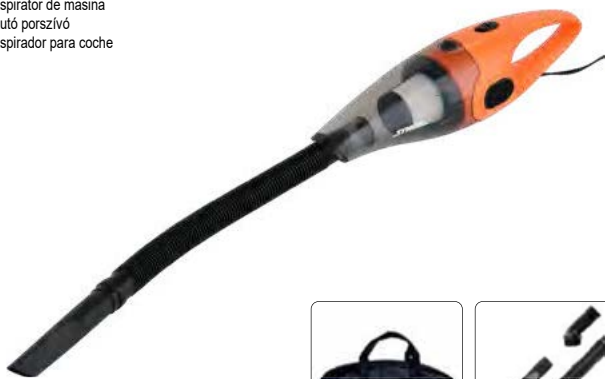

**STHOR**

No.	Voltage / Napięcie [V d.c.]	Power / Moc [W]	
82952	12	100	20

EN Car vacuum cleaner  
 PL Odkurzacz samochodowy  
 DE Handsauger  
 RU Ручной пылесос для автомобиля  
 CZ Vysavač do auta  
 RO Aspirator de masina  
 HU Autó porszívó  
 ES Aspirador para coche

100 W 12V CYCLONIC CYKLONOWY BAGLESS BEZ-WORKOWY 3m



**STHOR**

No.	Voltage / Napięcie [V d.c.]	Power / Moc [W]	
82967	12	100	9

EN Car vacuum cleaner  
 PL Odkurzacz samochodowy  
 DE Handsauger  
 RU Ручной пылесос для автомобиля  
 CZ Vysavač do auta  
 RO Aspirator de masina  
 HU Autó porszívó  
 ES Aspirador para coche

100 W 12V CYCLONIC CYKLONOWY WET AND DRY SUCHO I MOKRO BAGLESS BEZ-WORKOWY



**STHOR**

No.	Voltage / Napięcie [V d.c.]	Power / Moc [W]	
82951	12	100	8

EN Car vacuum cleaner  
 PL Odkurzacz samochodowy  
 DE Handsauger  
 RU Ручной пылесос для автомобиля  
 CZ Vysavač do auta  
 RO Aspirator de masina  
 HU Autó porszívó  
 ES Aspirador para coche

80W VACUUM CLEANER ODKURZACZ 120W COMPRESSOR KOMPRESOR 12V 20 l/min 1.0 MPa CYCLONIC CYKLONOWY BAGLESS BEZ-WORKOWY



**STHOR**

No.	Voltage / Napięcie [V d.c.]	Vacuum cleaner power / Moc odkurzacza [W]	Compressor power / Moc kompresora [W]	
82953	12	80	120	12

EN Car vacuum cleaner  
 PL Odkurzacz samochodowy  
 DE Handsauger  
 RU Ручной пылесос для автомобиля  
 CZ Vysavač do auta  
 RO Aspirator de masina  
 HU Autó porszívó  
 ES Aspirador para coche

80 W 7.4 V 2000mAh Li-Ion 4h 20min CYCLONIC CYKLONOWY BAGLESS BEZ-WORKOWY



**STHOR**

No.	Voltage / Napięcie [V d.c.]	Power / Moc [W]	
82954	7.4	80	20



EN Rechargeable car vacuum cleaner  
 PL Odkurzacz samochodowy bezprzewodowy  
 DE Kabelloser Auto-Staubsauger  
 RU Беспроводной пылесос автомобиля  
 CZ Bezdrátový automobilový vysavač  
 RO Aspirator de mașină fără fir  
 HU Vezeték nélküli autós porszívó  
 ES Aspirador de coche inalámbrico



100 W	2600 mAh Li-Ion
5-6h	15-18 min
USB BATTERY CHARGER LADOWARKA	CYCLONIC CYKLONOWY
BAGLESS BEZ- WORKOWY	



No.	Voltage / Napięcie [V d.c.]	Power / Moc [W]	
82970	5	100	9

EN First aid kit  
 PL Apteczka samochodowa  
 DE Verbandkasten  
 RU Аптечка автомобильная

CZ Příruční lékárnička první pomoci  
 RO Trusă medicală de prim-ajutor  
 HU Elsősegély doboz  
 ES Botiquin



No.	Type / Typ	
83260	E-01	10

EN First aid kit  
 PL Apteczka samochodowa  
 DE Verbandkasten  
 RU Аптечка автомобильная  
 CZ Příruční lékárnička první pomoci  
 RO Trusă medicală de prim-ajutor  
 HU Elsősegély doboz  
 ES Botiquin



No.	Type / Typ	
83262	E-03	5

EN Elastic tie down  
 PL Spinacz bagażu  
 DE Gepäckspinnensatz  
 RU Стяжка для багажа  
 CZ Elastické spínatka  
 RO Cordelina elastica  
 HU Csomagrögzítő pök  
 ES Pulpo 8-ramion

No.	L [cm]	Ø [mm]	Arm quantity / Liczba ramion	
82300	80	8	8	25/50

EN Rechargeable car vacuum cleaner  
 PL Odkurzacz samochodowy bezprzewodowy  
 DE Kabelloser Auto-Staubsauger  
 RU Беспроводной пылесос автомобиля  
 CZ Bezdrátový automobilový vysavač  
 RO Aspirator de mașină fără fir  
 HU Vezeték nélküli autós porszívó  
 ES Aspirador de coche inalámbrico



100 W	2600 mAh Li-Ion
5-6h	15-18 min
USB BATTERY CHARGER LADOWARKA	CYCLONIC CYKLONOWY
BAGLESS BEZ- WORKOWY	



No.	Voltage / Napięcie [V d.c.]	Power / Moc [W]	
82971	5	100	9

EN First aid kit  
 PL Apteczka samochodowa  
 DE Verbandkasten  
 RU Аптечка автомобильная

CZ Příruční lékárnička první pomoci  
 RO Trusă medicală de prim-ajutor  
 HU Elsősegély doboz  
 ES Botiquin



No.	Type / Typ	
83261	E-04	5

EN Vehicle safety triangle  
 PL Trójkąt ostrzegawczy  
 DE Warndreieck  
 RU Предупреждающий треугольник  
 CZ Výstražný trojúhelník  
 RO Triunghi de avertizare  
 HU Elakadásjelző háromszög  
 ES Triángulo de emergencia



No.	
83280	40

Ø 8.0 mm	80 cm	x8 HOOKS HAKAI	
----------	-------	----------------	--



EN Elastic straps  
 PL Ściągacze elastyczne  
 DE Gummispannseil  
 RU Стяжка для багажа

CZ Elastické spinátka  
 RO Cordelina elastica  
 HU Rugalmas feszítő  
 ES Pulpos

2  
PCS



No.	L [cm]	Ø [mm]	pcs / szt.	
82308	80	8	2	20/80
82310	100	8	2	20/80
82315	150	8	2	25/50
82320	200	8	2	25/50



EN Elastic tie down  
 PL Spinacz bagażu  
 DE Gepäckspinnensatz  
 RU Стяжка для багажа  
 CZ Elastické spinátka  
 RO Cordelina elastica  
 HU Csomaggrögzítő pók  
 ES Pulpo 8-ramion

8.0  
mm

80  
cm

x8  
HOOKS  
HARK



No.	L [cm]	Ø [mm]	Arm quantity / Liczba ramion	
82301	80	8	8	25/50

EN Elastic straps  
 PL Płaskie ściągacze elastyczne  
 DE Gummispannseil  
 RU Стяжка для багажа  
 CZ Elastické spinátka  
 RO Cordelina elastica  
 HU Rugalmas feszítő  
 ES Pulpos

2  
PCS



No.	L [cm]	pcs / szt.	
82360	80	2	25/50
82370	100	2	20/80

EN Ratchet tie down  
 PL Taśma do bagażu ze sprzączką  
 DE Spanngurt  
 RU Ремни для крепления груза с зажимом фиксатором  
 CZ Pás na zavazadla  
 RO Cordelina pt. bagaje cu clichet  
 HU Csomaggrögzítő pánt  
 ES Cintas para equipaje

5m  
25mm

125  
daN



No.	L [m]	W [mm]	
82341	5	25	12/48

EN Elastic straps  
 PL Ściągacze elastyczne  
 DE Gummispannseil  
 RU Стяжка для багажа  
 CZ Elastické spinátka  
 RO Cordelina elastica  
 HU Rugalmas feszítő  
 ES Pulpos

2  
PCS

12  
mm

120  
cm



No.	L [cm]	Ø [mm]	pcs / szt.	
82305	120	12	2	12/24

EN Ratchet tie down  
 PL Taśma do bagażu ze sprzączką  
 DE Spanngurt  
 RU Ремни для крепления груза с зажимом фиксатором  
 CZ Pás na zavazadla  
 RO Cordelina pt. bagaje cu clichet  
 HU Csomaggrögzítő pánt  
 ES Cintas para equipaje

2  
PCS

2.5m  
25mm

100  
daN



No.	L [m]	W [mm]	pcs / szt.	
82331	2.5	25	2	10/80

EN Ratchet tie down  
 PL Taśma do bagażu  
 DE Spanngurt  
 RU Ремень для крепления багажа с трещоткой  
 CZ Pás na zavazadla z napínáním  
 RO Cordelina pt. bagaje cu clichet  
 HU Csomaggrögzítő pánt feszítővel  
 ES Cinta para equipaje con carraca

2  
PCS



No.	L [m]	W [mm]	Lashing capacity / Zdolność mocowania [daN]	
82377	2	35	1000	10
82378	4	35	1000	10
82379	6	35	1000	10
82380	8	35	1000	10

EN Ratchet tie down  
 PL Taśma do bagażu  
 DE Spanngurt  
 RU Ремень для крепления багажа с трещоткой

CZ Pás na zavazadla z napínáním  
 RO Cordelina pt. bagaje cu clichet  
 HU Csomagrögzítő pánt feszítővel  
 ES Cinta para equipaje con carraca

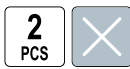

No.	L [m]	W [mm]	Lashing capacity / Zdolność mocowania [daN]	
82372	4	50	1600	8
82373	6	50	1600	7
82374	8	50	1600	6
82375	10	50	1600	5
82384	6	50	2000	6
82386	8	50	2000	6
82388	10	50	2000	5
82390	12	50	2000	5

EN Ratchet tie down  
 PL Taśma do bagażu  
 DE Spanngurt  
 RU Ремень для крепления багажа с трещоткой  
 CZ Pás na zavazadla z napínáním  
 RO Cordelina pt. bagaje cu clichet  
 HU Csomagrögzítő pánt feszítővel  
 ES Cinta para equipaje con carraca



No.	L [m]	W [mm]	Lashing capacity / Zdolność mocowania [daN]	
82401	2	38	1000	12
82402	4	38	1000	12
82403	6	38	1000	12
82404	8	38	1000	12
82405	4	50	1500	6
82406	6	50	1500	6
82407	8	50	1500	6
82408	10	50	1500	6

EN Ratchet tie down  
 PL Taśma do bagażu  
 DE Spanngurt  
 RU Ремень для крепления багажа с трещоткой  
 CZ Pás na zavazadla z napínáním  
 RO Cordelina pt. bagaje cu clichet  
 HU Csomagrögzítő pánt feszítővel  
 ES Cinta para equipaje con carraca



No.	L [m]	W [mm]	
82351	5	25	12/48

EN Ratchet tie down  
 PL Taśma do bagażu  
 DE Spanngurt  
 RU Ремень для крепления багажа с трещоткой

CZ Pás na zavazadla z napínáním  
 RO Cordelina pt. bagaje cu clichet  
 HU Csomagrögzítő pánt feszítővel  
 ES Cinta para equipaje con carraca



No.	L [m]	W [mm]	Lashing capacity / Zdolność mocowania [daN]	
82392	6	50	2500	6
82393	8	50	2500	6
82395	12	50	2500	5



No.	L [m]	W [mm]	Lashing capacity / Zdolność mocowania [daN]	
82409	6	50	2000	6
82410	8	50	2000	6
82411	10	50	2000	6
82412	12	50	2000	6
82413	6	50	2500	6
82414	8	50	2500	6
82415	10	50	2500	6

EN Ratchet tie down  
 PL Taśma do bagażu  
 DE Spanngurt  
 RU Ремень для крепления багажа с трещоткой  
 CZ Pás na zavazadla z napínáním  
 RO Cordelina pt. bagaje cu clichet  
 HU Csomagrögzítő pánt feszítővel  
 ES Cinta para equipaje con carraca

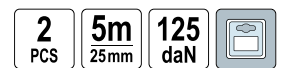

No.	L [m]	W [mm]	pcs / szt.	
82400	5	25	2	8/16

- EN Ratchet tie down
- PL Taśma do bagażu
- DE Spanngurt
- RU Ремень для крепления багажа с трещоткой
- CZ Pás na zavazadla z napínáním
- RO Cordelina pt. bagaje cu clichet
- HU Csomagrögzítő pánt feszítővel
- ES Cinta para equipaje con carraca



No.	L [m]	W [mm]	Lashing capacity / Zdolność mocowania [daN]	
82343	4	25	1000	20

- EN Webbing sling
- PL Zawiesie pasowe
- DE Flachgewebtes Hebeband
- RU Строп текстильный ленточный
- CZ Zvedací pás
- RO Sling de ridicare
- HU Emelő heveder
- ES Eslinga plana



No.	L [m]	
82265	1 (± 3%)	100
82266	2 (± 3%)	60
82267	3 (± 3%)	50

- EN Webbing sling
- PL Zawiesie pasowe
- DE Flachgewebtes Hebeband
- RU Строп текстильный ленточный
- CZ Zvedací pás
- RO Sling de ridicare
- HU Emelő heveder
- ES Eslinga plana

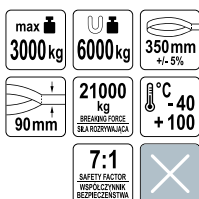

No.	L [m]	
82280	3 (± 3%)	15
82281	4 (± 3%)	12
82282	6 (± 3%)	9

- EN Ratchet tie down
- PL Taśma do bagażu
- DE Spanngurt
- RU Ремень для крепления багажа с трещоткой
- CZ Pás na zavazadla z napínáním
- RO Cordelina pt. bagaje cu clichet
- HU Csomagrögzítő pánt feszítővel
- ES Cinta para equipaje con carraca

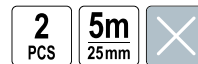

No.	L [m]	W [mm]	Lashing capacity / Zdolność mocowania [daN]	
82397	5	25	500	20

- EN Webbing sling
- PL Zawiesie pasowe
- DE Flachgewebtes Hebeband
- RU Строп текстильный ленточный
- CZ Zvedací pás
- RO Sling de ridicare
- HU Emelő heveder
- ES Eslinga plana

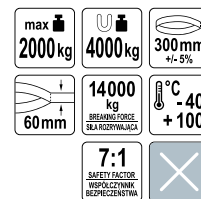

No.	L [m]	
82270	1 (± 3%)	50
82271	2 (± 3%)	30
82272	3 (± 3%)	25
82273	4 (± 3%)	20
82274	5 (± 3%)	15
82275	6 (± 3%)	15

- EN Customs securing rope
- PL Linka celna stalowa
- DE Zollschnur aus Stahl
- RU Стальная таможенный трос
- CZ Ocelové celní lanko
- RO Cablu de ancorare
- HU Acél árubiztosító kötél
- ES Cable de acero de seguridad



No.	Ø [mm]	L [m]	
85000	6	15	12
85001	6	16	12
85002	6	18	12
85003	6	34	12
85004	6	36	12
85005	6	42	10



EN Luggage net  
 PL Siatka organizer z hakami do bagażnika  
 DE Organizer Gepäcknetz mit Haken für Kofferraum  
 RU Сетка-органайзер с крючками для багажника  
 CZ Sítka organizér zavazadlového prostoru s háčky  
 RO Plasa pt. bagaje  
 HU Rendszerező csomagtartó hálókampókkal  
 ES Red organizador con ganchos para maletero

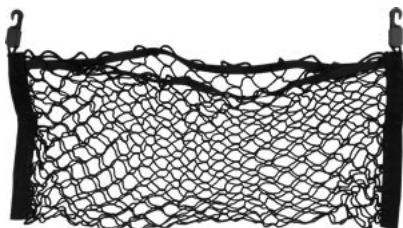

No.	Size / Rozmiar [mm]	
82260	70x300	24

EN Luggage net  
 PL Siatka organizer do bagażnika z hakami  
 DE Organizer Gepäcknetz mit Haken für Kofferraum  
 RU Сетка-органайзер для багажника с крючками  
 CZ Sítka organizér zavazadlového prostoru s háčky  
 RO Plasa pt. bagaje  
 HU Rendszerező csomagtartó hálókampókkal  
 ES Red organizador para maletero, con ganchos

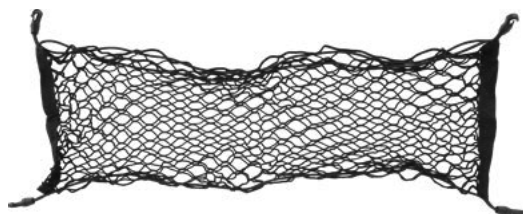

No.	Size / Rozmiar [mm]	
82262	90x300	50

EN Luggage net  
 PL Siatka do bagażnika z hakami  
 DE Gepäcknetz mit Haken für Kofferraum  
 RU Сетка с крючками для багажника  
 CZ Sítka do zavazadlového prostoru s háčky  
 RO Plasa pt. bagaje  
 HU Csomagtartó hálókampókkal  
 ES Red con ganchos para maletero

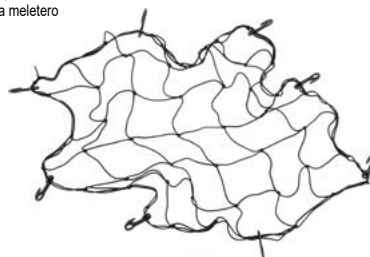

No.	Size / Rozmiar [mm]	
82261	90x900	50

EN Elastic tie down  
 PL Ściągacze elastyczne z karabińczykiem  
 DE Elastische Abzieher mit Karabinerhaken  
 RU Эластичные шнуры для затягивания с карабином  
 CZ Elastické stahováky s karabinkou  
 RO Cordelina elastica pt. bagaje  
 HU Rugalmas kötél karabinerekkel  
 ES Elásticos con mosquetón

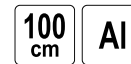

No.	Ø [mm]	L [mm]	pcs / szt.	
82322	8	1000	2	30

Memo

15

Power tools & accessories  
Elektronarzędzia i akcesoria



**Power tools STHOR**  
**Elektronarzędzia STHOR**

248-256

<b>Impact drills</b>	
Wiertarki udarowe.....	248
<b>Rotary hammers</b>	
Młoty udarowe.....	248
<b>Cordless tools</b>	
Urządzenia akumulatorowe.....	249
<b>Orbital sanders</b>	
Szlifiarki mimośrodowe.....	254
<b>Finishing sanders</b>	
Szlifiarki oscylacyjne.....	254
<b>Circular saws</b>	
Pilarki tarczowe.....	254
<b>Planers</b>	
Strugi.....	254
<b>Hot air guns</b>	
Opalarki.....	255
<b>Glue guns</b>	
Pistolety do klejenia.....	255
<b>Soldering guns</b>	
Lutownice.....	256
<b>Paint &amp; mortar mixers</b>	
Mieszarki do zapraw i farb.....	256
<b>Water pumps</b>	
Pompy wodne.....	256

**Power tools LUND**  
**Elektronarzędzia LUND**

258-259

<b>Knives for polystyrene foam</b>	
Noże do styropianu.....	258
<b>Car polishers</b>	
Polerki samochodowe.....	258
<b>Hot air guns</b>	
Opalarki.....	258
<b>Glue guns</b>	
Pistolety do klejenia.....	258
<b>Soldering guns</b>	
Lutownice.....	259

**Power tools FLO  
Elektronarzędzia FLO**

.....260-262



**Water pumps**

Pompy wodne..... 260

**Hedge shears**

Nożyce do żywopłotu..... 261

**Chainsaws**

Piłarki łańcuchowe..... 261

**Soil millers**

Glebogryzarki..... 262

**Scarifiers**

Wertykulatory..... 262

**Power tools  
Elektronarzędzia**

.....264



**Soldering guns**

Lutownice..... 264



## Accessories Akcesoria



264-273

<b>Accessories chainsaws</b> Akcesoria do pił łańcuchowych.....	264
<b>Accessories gasoline</b> Akcesoria do narzędzi spalinowych.....	264
<b>Grass trimmer lines</b> Żyłki tnące do podkaszarek.....	264
<b>Drill chucks</b> Uchwyty wiertarskie.....	268
<b>Adapters</b> Adaptory.....	268
<b>Drill bit sharpeners</b> Ostrzałki do wiertel.....	269
<b>Stands for power tools</b> Statywy do elektronarzędzi.....	269
<b>Spare blades, brushes, etc. for power tools</b> Zapassowe ostrza, szczotki, końcówki do elektronarzędzi.....	269
<b>Soldering iron accessories</b> Akcesoria do lutownic.....	270
<b>Gasoline water pump accessories</b> Akcesoria do pomp spalinowych.....	273

EN Impact drill  
 PL Wiertarka udarowa  
 DE Schlagbohrmaschine  
 RU Ударная дрель  
 CZ Příkladová vrtačka  
 RO Bormașină cu percutește  
 HU Útvefűró  
 ES Taladro de percusión

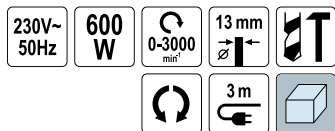

$L_{pA} = 90,0 \pm 3,0$  dB;  $L_{wA} = 101,0 \pm 3,0$  dB;  $a_n = 2,39 \pm 1,5 / 7,67 \pm 1,5$  m/s<sup>2</sup>

No.	Power / Moc [W]	$\Omega$ [min <sup>-1</sup> ]	
78992	600	0-3000	10

EN Cordless stapler  
 PL Zszywacz akumulatorowy  
 DE Akku-Heftgerät  
 RU Степлер аккумуляторный  
 CZ Akumulátorová sponkovačka  
 RO Capsator cu acumulator  
 HU Akkumulátoros tűzőgép  
 ES Grapadora a batería

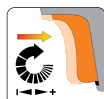

$L_{pA} = 98,06 \pm 3,0$  dB;  $L_{wA} = 109,06 \pm 3,0$  dB;  $a_n = 5,726 \pm 1,5 / 17,116 \pm 1,5$  m/s<sup>2</sup>

No.	Voltage / Napiecie [V d.c.]	
78158	20	6

EN Rotary hammer  
 PL Młotowiertarka  
 DE Bohrhämmer  
 RU Перфоратор  
 CZ Vrtací kladivo  
 RO Ciocan rotopercutor  
 HU Fűrókalapács  
 ES Martillo perforador



$L_{pA} = 92,0 \pm 3,0$  dB;  $L_{wA} = 103,0 \pm 3,0$  dB;  $a_n = 11,376 \pm 1,5 / 9,657 \pm 1,5$  m/s<sup>2</sup>

No.	Power / Moc [W]	$\Omega$ [min <sup>-1</sup> ]	
79054	620	0-870	5

EN Impact drill  
 PL Wiertarka udarowa  
 DE Schlagbohrmaschine  
 RU Ударная дрель  
 CZ Příkladová vrtačka  
 RO Bormașină cu percutește  
 HU Útvefűró  
 ES Taladro de percusión

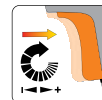
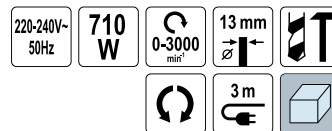

$L_{pA} = 98,06 \pm 3,0$  dB;  $L_{wA} = 109,06 \pm 3,0$  dB;  $a_n = 5,726 \pm 1,5 / 17,116 \pm 1,5$  m/s<sup>2</sup>

No.	Power / Moc [W]	$\Omega$ [min <sup>-1</sup> ]	
78995	710	0-3000	10

EN Rotary hammer  
 PL Młotowiertarka  
 DE Bohrhämmer  
 RU Перфоратор  
 CZ Vrtací kladivo  
 RO Ciocan rotopercutor  
 HU Fűrókalapács  
 ES Martillo perforador



$L_{pA} = 92,3 \pm 3,0$  dB;  $L_{wA} = 103,3 \pm 3,0$  dB;  $a_n = 11,376 \pm 1,5 / 9,657 \pm 1,5$  m/s<sup>2</sup>

No.	Power / Moc [W]	$\Omega$ [min <sup>-1</sup> ]	
79049	500	0-850	5



EN Cordless drill/driver  
 PL Akumulatorowa wiertarko-wkrętarka  
 DE Akku-Bohrschrauber  
 RU Аккумуляторная дрель-шуруповерт  
 CZ Akumulátorový vrtací šroubovák  
 RO Mașină de găurit și înșurubat cu acumulator  
 HU Akkus fúró-csavarozó  
 ES Taladro atornillador a batería



$L_{pa} = 70,3 \pm 5,0$  dB;  $L_{wa} = 81,3 \pm 5,0$  dB;  $a_n = 2,368 \pm 1,5$  m/s<sup>2</sup>

No.	Voltage / Napięcie [V d.c.]	$\omega$ [min <sup>-1</sup> ]	Toolholder size / Rozmiar uchwyty narzędziowego [mm]	Battery capacity / Pojemność akumulatora [mAh]	⌚ [h]	Battery quantity / Liczba akumulatorów w zestawie	Package
78082	20	0-350 / 0-1300	0.8-10	2000	1	2	4
78081	20	0-350 / 0-1300	0.8-10	2000	1	1	4
78080	20	0-350 / 0-1300	0.8-10	-	-	brak	8

EN Cordless angle grinder  
 PL Akumulatorowa szlifierka kątowa  
 DE Akku-Winkelschleifer  
 RU Аккумуляторная угловая шлифмашина  
 CZ Akumulátorový úhlový bruska  
 RO Polizor unghiular cu acumulator  
 HU Akkus sarkocsiszóló  
 ES Amoladora angular a batería



$L_{pa} = 85,5 \pm 3,0$  dB;  $L_{wa} = 96,5 \pm 3,0$  dB;  $a_n = 6,173 \pm 1,5 / 5,741 \pm 1,5$  m/s<sup>2</sup>

No.	Voltage / Napięcie [V d.c.]	$\omega$ [min <sup>-1</sup> ]	Battery capacity / Pojemność akumulatora [mAh]	⌚ [h]	Battery quantity / Liczba akumulatorów w zestawie	Package
78091	20	8000	2000	1	1	4
78090	20	8000	-	-	brak	6

EN Cordless impact screwdriver  
 PL Akumulatorowa zakrętarka udarowa  
 DE Akku-Schlagschrauber  
 RU Аккумуляторный ударный винтоверт  
 CZ Akumulátorový rázový utahovák  
 RO Șurubelniță cu impact cu acumulator  
 HU Akkus ütvecsavarozó  
 ES Atornillador de impacto a batería

$L_{pa} = 75,8 \pm 3,0$  dB;  $L_{wa} = 86,8 \pm 3,0$  dB;  $a_n = 0,414 \pm 1,5$  m/s<sup>2</sup>

No.	Voltage / Napięcie [V d.c.]	$\omega$ [min <sup>-1</sup> ]	Package
78113	20	0-2500	4

EN Brushless cordless drill/driver  
 PL Bezsztetkowa wiertarko-wkrętarka akumulatorowa  
 DE Bürstenloser Akku-Bohrschrauber  
 RU Бесщеточный аккумуляторный дрель-шуруповерт  
 CZ Bezkartáčový akumulátorový vrtací šroubovák s příklepem  
 RO Mașină de găurit și înșurubat cu acumulator fără perii  
 HU Akkus fúró-csavarozó szénkefe nélkül  
 ES Taladro atornillador a batería sin escobillas



$L_{pa} = 75,3 \pm 5,0$  dB;  $L_{wa} = 86,3 \pm 5,0$  dB;  $a_n = 2,041 \pm 1,5$  m/s<sup>2</sup>

No.	Voltage / Napięcie [V d.c.]	$\omega$ [min <sup>-1</sup> ]	Toolholder size / Rozmiar uchwyty narzędziowego [mm]	Battery capacity / Pojemność akumulatora [mAh]	⌚ [h]	Battery quantity / Liczba akumulatorów w zestawie	Package
78085	20	0-450 / 0-1600	0.8-10	2000	1	1	4
78084	20	0-450 / 0-1600	0.8-10	-	-	brak	8

EN Cordless rotary hammer  
 PL Akumulatorowa młotowiertarka  
 DE Akku-Bohrhammer  
 RU Аккумуляторный перфоратор  
 CZ Akumulátorové vrtací kladivo  
 RO Ciocan rotorecutor cu acumulator  
 HU Akkus fúrókalapács  
 ES Martillo perforador a batería

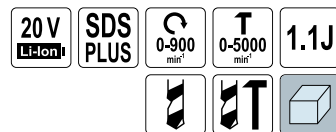

Battery not included  
 Ohne Akku / Bez akumulatora  
 Bez baterii / Bez aku  
 Akumulator neobsahuje  
 Fără baterie / Sans batterie  
 Senza batteria / Sin batería  
 没有电池

$L_{pa} = 88,0 \pm 3,0$  dB;  $L_{wa} = 99,0 \pm 3,0$  dB;  $a_n = 8,9 \pm 1,5$  m/s<sup>2</sup>

No.	Voltage / Napięcie [V d.c.]	$\omega$ [min <sup>-1</sup> ]	Package
78107	20	0-900	6

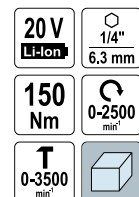

Battery not included  
 Ohne Akku / Bez akumulatora  
 Bez baterii / Bez aku  
 Akumulator neobsahuje  
 Fără baterie / Sans batterie  
 Senza batteria / Sin batería  
 没有电池

EN Cordless circular saw  
 PL Akumulatorowa piłarka tarczowa  
 DE Akku-Handkreissäge  
 RU Аккумуляторная циркулярная пила  
 CZ Akumulátorová okružní pila  
 RO Ferăstrău circular cu acumulator  
 HU Akkus körfűrész  
 ES Sierra circular a batería



**STIHL**  $L_{PA} = 85,9 \pm 3,0$  dB;  $L_{WA} = 96,9 \pm 3,0$  dB;  $a_n = 0,905 \pm 1,5$  m/s<sup>2</sup>

No.	Voltage / Napięcie [V d.c.]	∅ [min <sup>-1</sup> ]	Battery capacity / Pojemność akumulatora [mAh]	⏻ [h]	Battery quantity / Liczba akumulatorów w zestawie	📦
78133	20	4000	2000	1	1	4
78132	20	4000	-	-	brak	4

EN Cordless sabre saw  
 PL Akumulatorowa piła szablasta  
 DE Akku-Säbelsäge  
 RU Аккумуляторная сабельная пила  
 CZ Akumulátorová píla ocaska  
 RO Ferăstrău sabie cu acumulator  
 HU Akkus szablyafűrész  
 ES Sierra sable de batería



**STIHL**  $L_{PA} = 83,4 \pm 3,0$  dB;  $L_{WA} = 94,4 \pm 3,0$  dB;  $a_n = 10,847 \pm 1,5 / 9,852 \pm 1,5$  m/s<sup>2</sup>

No.	Voltage / Napięcie [V d.c.]	∅ [min <sup>-1</sup> ]	Battery capacity / Pojemność akumulatora [mAh]	⏻ [h]	Battery quantity / Liczba akumulatorów w zestawie	📦
78139	20	0-3000	2000	1	1	5
78138	20	0-3000	-	-	brak	5

EN Cordless multi-purpose oscillating tool  
 PL Akumulatorowe wielofunkcyjne narzędzie oscylacyjne  
 DE Akku-Multifunktionswerkzeug  
 RU Аккумуляторный многофункциональный инструмент  
 CZ Akumulátorová multifunkční pila  
 RO Mașină multifuncțională cu acumulator  
 HU Akkus multifunkcionális vágószerszám  
 ES Multiherramienta a batería

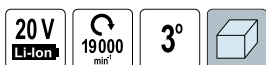

**Battery not included**  
 Ohne Akku / Bez akumulatora  
 Bez baterii / Bez aku  
 Akkumulátor nélkül  
 Fără baterie / Senza batteria  
 Senza batteria / Sin batería  
 没有电池

**STIHL**  $L_{PA} = 84,6 \pm 3,0$  dB;  $L_{WA} = 95,6 \pm 3,0$  dB;  $a_n = 16,22 \pm 1,5$  m/s<sup>2</sup>

No.	Voltage / Napięcie [V d.c.]	∅ [min <sup>-1</sup> ]	📦
78151	20	19000	6

EN Cordless jig saw  
 PL Akumulatorowa wyrzynarka  
 DE Akku-Stichsäge  
 RU Аккумуляторная лобиковая пила  
 CZ Akumulátorová přímochařá pila  
 RO Ferăstrău vertical cu acumulator  
 HU Akkus szűrőfűrész  
 ES Sierra de calar a batería



**STIHL**  $L_{PA} = 87,8 \pm 3,0$  dB;  $L_{WA} = 98,8 \pm 3,0$  dB;  $a_n = 4,372 \pm 1,5 / 6,627 \pm 1,5$  m/s<sup>2</sup>

No.	Voltage / Napięcie [V d.c.]	∅ [min <sup>-1</sup> ]	Battery capacity / Pojemność akumulatora [mAh]	⏻ [h]	Battery quantity / Liczba akumulatorów w zestawie	📦
78137	20	0-2300	2000	1	1	4
78136	20	0-2300	-	-	brak	6

EN Cordless random orbital sander  
 PL Szlifierka oscylacyjna akumulatorowa  
 DE Akku-Schwingschleifer  
 RU Аккумуляторная шлифовальная машина  
 CZ Akumulátorová bruska  
 RO Șlefuitor cu acumulator  
 HU Akkumulátoros csiszoló  
 ES Lijadora orbital inalámbrica



**Battery not included**  
 Ohne Akku / Bez akumulatora  
 Bez baterii / Bez aku  
 Akkumulátor nélkül  
 Fără baterie / Senza batteria  
 Senza batteria / Sin batería  
 没有电池

**STIHL**  $L_{PA} = 77,1 \pm 3,0$  dB;  $L_{WA} = 88,1 \pm 3,0$  dB;  $a_n = 7,511 \pm 1,5$  m/s<sup>2</sup>

No.	Voltage / Napięcie [V d.c.]	∅ [min <sup>-1</sup> ]	📦
78143	20	5000-10000	6

EN Cordless glue gun  
 PL Akumulatorowy pistolet do klejenia  
 DE Akku-Heißklebepistole  
 RU Аккумуляторный клеевой пистолет  
 CZ Akumulátorová lepicí pistole  
 RO Pistol pt. lipit cu acumulator  
 HU Akkus ragasztópisztoly  
 ES Pistola de cola a batería



**Battery not included**  
 Ohne Akku / Bez akumulatora  
 Bez baterii / Bez aku  
 Akkumulátor nélkül  
 Fără baterie / Senza batteria  
 Senza batteria / Sin batería  
 没有电池

**STIHL**

No.	Voltage / Napięcie [V d.c.]	📦
78155	20	10



EN Cordless stapler  
 PL Zszywacz akumulatorowy  
 DE Akku-Heftgerät  
 RU Степлер аккумуляторный  
 CZ Akumulátorová sponkovačka  
 RO Capsator cu acumulator  
 HU Akkumulátoros tűzőgép  
 ES Grapadora a batería



$L_{pA} = 89,6 \pm 3,0$  dB;  $L_{wA} = 100,6 \pm 3,0$  dB;  $a_n = 8,501 \pm 1,5$  m/s<sup>2</sup>

No.	Voltage / Napiecie [V d.c.]	Icon
78158	20	6

EN Cordless hedge trimmer  
 PL Akumulatorowe nożyce do żywoplotu  
 DE Akku-Heckenschere  
 RU Аккумуляторный кусторез  
 CZ Akumulátorové nůžky na živý plot  
 RO Foarfeca de tăiat gaird viu cu acumulator  
 HU Akkus sövényvágó  
 ES Cortasetos inalámbrico



$L_{pA} = 81,3 \pm 3,0$  dB;  $L_{wA} = 92,9 \pm 3,0$  dB;  $a_n = 2,459 \pm 1,5 / 1,754 \pm 1,5$  m/s<sup>2</sup>

No.	Voltage / Napiecie [V d.c.]	Cutting speed / Prędkość cięcia [min <sup>-1</sup> ]	Battery capacity / Pojemność akumulatora [mAh]	Icon	Battery quantity / Liczba akumulatorów w zestawie
78187	20	1200	2000	1	1
78186	20	1200	-	-	brak

EN Cordless tool kit  
 PL Zestaw narzędzi akumulatorowych  
 DE Akku-Werkzeug-Set  
 RU Набор аккумуляторных инструментов  
 CZ Sada akumulátorového nářadí  
 RO Trusă de scule cu acumulator  
 HU Akkumulátoros szerszámkészlet  
 ES Conjunto de herramientas a batería



No.	Voltage / Napiecie [V d.c.]	Icon	Toolholder size / Rozmiar uchwyty narzędziowego [mm]
78097	20	0-350 / 0-1300 (wiertarko-wkrętarka), 8000 (szlifierka kątowna)	0.8-10

EN Cordless grass trimmer  
 PL Akumulatorowa podkaszarka do trawy  
 DE Akku-Rasentrimmer  
 RU Аккумуляторный триммер  
 CZ Akumulátorová strunová sekačka  
 RO Trimmer de gazon cu acumulator  
 HU Akkus szegélynyíró  
 ES Desbrozadora a batería



$L_{pA} = 72,3 \pm 3,0$  dB;  $L_{wA} = 90,0 \pm 1,96$  dB;  $a_n = 3,293 \pm 1,5 / 3,117 \pm 1,5$  m/s<sup>2</sup>

No.	Voltage / Napiecie [V d.c.]	Icon	Battery capacity / Pojemność akumulatora [mAh]	Icon	Battery quantity / Liczba akumulatorów w zestawie
78181	20	8000	2000	1	1
78180	20	8000	-	-	brak

EN Cordless blower  
 PL Dmuchawa akumulatorowa  
 DE Akku-Gebläse  
 RU Воздуходувка аккумуляторная  
 CZ Akumulátorový zahradní fukar  
 RO Suflantă cu acumulator  
 HU Akkus légfúvó  
 ES Soplador a batería



$L_{pA} = 76,3 \pm 3,0$  dB;  $L_{wA} = 84,7 \pm 3,0$  dB;  $a_n = 1,37 \pm 1,5$  m/s<sup>2</sup>

No.	Voltage / Napiecie [V d.c.]	Icon
78190	20	13000

Battery not included  
 Ohne Akku / Bez akumulatora  
 Bez Oermapetu / Bez aku  
 Akkumulátor nélkül  
 Fără baterie / Sans batterie  
 Senzsa bateriá / Sin bateriá  
 沒有電池

- EN Starter kit (batteries and charger)
- PL Zestaw startowy (akumulatory i ładowarka)
- DE Starter-Kit (Akkus und Ladegerät)
- RU Стартовый набор (аккумуляторы и зарядное устройство)
- CZ Startovací sada (baterie a nabíječka)
- RO Kit de pornire (baterii și încărcător)
- HU Kezdőkészlet (akkumulátorok és töltő)
- ES Conjunto de arranque (baterías y cargador)

220-240V-50/60Hz	20 V Li-Ion	2.0 Ah
1h	4.0 Ah	2h
	2A	



**STHOR**

No.	Operating voltage / Napięcie robocze [V d.c.]	
78262	20	6

- EN Battery
- PL Akumulator
- DE Akkumulator
- RU Аккумулятор
- CZ Akumulátor
- RO Acumulatorul
- HU Akkumulátor
- ES Batería

20 V Li-Ion	4.0 Ah	2h	
----------------	--------	----	--



**STHOR**

No.	Voltage / Napięcie [V d.c.]	Battery capacity / Pojemność akumulatora [mAh]	Charging time / Czas ładowania [h]	
78252	20	4000	2	12

- EN Battery charger
- PL Ładowarka
- DE Ladegerät
- RU Зарядное устройство
- CZ Nabíječka
- RO Încărcător
- HU Töltő
- ES Cargador

100-240V-50/60Hz	20 V Li-Ion	4A	
------------------	----------------	----	--



**STHOR**

No.	Operating voltage / Napięcie robocze [V d.c.]	
78261	20	12

- EN Battery
- PL Akumulator
- DE Akkumulator
- RU Аккумулятор
- CZ Akumulátor
- RO Acumulatorul
- HU Akkumulátor
- ES Batería

20 V Li-Ion	2.0 Ah	1h	
----------------	--------	----	--



**STHOR**

No.	Voltage / Napięcie [V d.c.]	Battery capacity / Pojemność akumulatora [mAh]	Charging time / Czas ładowania [h]	
78250	20	2000	1	24

- EN Battery charger
- PL Ładowarka
- DE Ladegerät
- RU Зарядное устройство
- CZ Nabíječka
- RO Încărcător
- HU Töltő
- ES Cargador

220-240V-50/60Hz	20 V Li-Ion	2A	
------------------	----------------	----	--



**STHOR**

No.	Operating voltage / Napięcie robocze [V d.c.]	
78260	20	12

- EN Cordless drill/driver
- PL Akumulatorowa wiertarko-wkrętarka
- DE Akku-Bohrschrauber
- RU Аккумуляторная дрель-шуруповерт
- CZ Akumulátorový vrtací šroubovák
- RO Mașină de găurit și înșurubat cu acumulator
- HU Akkus fúró-csavarozó
- ES Taladro atornillador a batería

10.8V 1300mAh Li-Ion	0-700 min <sup>1</sup>	0.8-10mm
----------------------------	---------------------------	----------

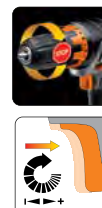

$L_{pA} = 89,0 \pm 3,0$  dB;  $L_{wA} = 100,0 \pm 3,0$  dB;  $a_h = 0,854 \pm 1,5 / 2,069 \pm 1,5$  m/s<sup>2</sup>

**STHOR**

No.	Voltage / Napięcie [V d.c.]	⊖ [min <sup>1</sup> ]	Toolholder size / Rozmiar uchwyty narzędziowego [mm]	
78981	10.8	0-700	0.8-10	5

EN Cordless drill/driver  
 PL Akumulatorowa wiertarko-wkrętarka  
 DE Akku-Bohrschrauber  
 RU Аккумуляторная дрель-шурупверт  
 CZ Akumulátorový vrtací šroubovák  
 RO Mașină de găurit și înșurubat cu acumulator  
 HU Akkus fúró-csavarozó  
 ES Taladro atornillador a batería



$L_{pA} = 87,0 \pm 3,0$  dB;  $L_{wA} = 98,0 \pm 3,0$  dB;  $a_n = 1,292 \pm 1,5 / 2,312 \pm 1,5$  m/s<sup>2</sup>

No.	Voltage / Napiecie [V d.c.]	∅ [min <sup>-1</sup> ]	Toolholder size / Rozmiar uchwytu narzędziowego [mm]	📦
78982	14.4	0-700	0.8-10	5

EN Battery  
 PL Akumulator  
 DE Akkumulator  
 RU Аккумулятор  
 CZ Akumulátor  
 RO Acumulatorul  
 HU Akkumulátor  
 ES Batería



No.	Voltage / Napiecie [V d.c.]	For / Dia	📦
78985	10.8	78118, 78981	50
78986	14.4	78982	50
78987	18	78972, 78974, 78961, 78983	50

EN Cordless drill/driver  
 PL Akumulatorowa wiertarko-wkrętarka  
 DE Akku-Bohrschrauber  
 RU Аккумуляторная дрель-шурупверт  
 CZ Akumulátorový vrtací šroubovák  
 RO Mașină de găurit și înșurubat cu acumulator  
 HU Akkus fúró-csavarozó  
 ES Taladro atornillador a batería

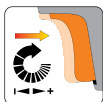

$L_{pA} = 89,0 \pm 3,0$  dB;  $L_{wA} = 100,0 \pm 3,0$  dB;  $a_n = 1,001 \pm 1,5 / 2,629 \pm 1,5$  m/s<sup>2</sup>

No.	Voltage / Napiecie [V d.c.]	∅ [min <sup>-1</sup> ]	Toolholder size / Rozmiar uchwytu narzędziowego [mm]	📦
78972	18	0-350 / 0-1300	0.8-10	5

EN Cordless drill/driver  
 PL Akumulatorowa wiertarko-wkrętarka  
 DE Akku-Bohrschrauber  
 RU Аккумуляторная дрель-шурупверт  
 CZ Akumulátorový vrtací šroubovák  
 RO Mașină de găurit și înșurubat cu acumulator  
 HU Akkus fúró-csavarozó  
 ES Taladro atornillador a batería

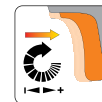
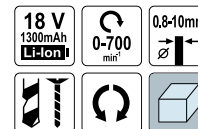

$L_{pA} = 89,0 \pm 3,0$  dB;  $L_{wA} = 100,0 \pm 3,0$  dB;  $a_n = 1,001 \pm 1,5 / 2,629 \pm 1,5$  m/s<sup>2</sup>

No.	Voltage / Napiecie [V d.c.]	∅ [min <sup>-1</sup> ]	Toolholder size / Rozmiar uchwytu narzędziowego [mm]	📦
78983	18	0-700	0.8-10	5

EN Battery charger  
 PL Ładowarka  
 DE Ladegerät  
 RU Зарядное устройство

CZ Nabíječka  
 RO Încărcător  
 HU Töltő  
 ES Cargador



No.	Output voltage / Napiecie wyjściowe [V d.c.]	Output current / Prąd wyjściowy [mA]	For / Dia	📦
79087	15	400	79084	30
79088	18	400	79085	30
79089	24	400	79086	20

EN Cordless impact drill/driver  
 PL Akumulatorowa wiertarko-wkrętarka udarowa  
 DE Akku-Schlagbohrschrauber  
 RU Аккумуляторный ударный дрель-шурупверт  
 CZ Akumulátorový nárazový šroubovák s přiklepem  
 RO Mașină de găurit și înșurubat cu percucie cu acumulator  
 HU Akkus ütvefúró-csavarozó  
 ES Taladro atornillador con percusión a batería

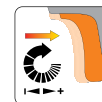
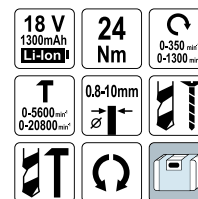

$L_{pA} = 89,0 \pm 3,0$  dB;  $L_{wA} = 100,0 \pm 3,0$  dB;  $a_n = 15,25 \pm 1,5$  m/s<sup>2</sup>

No.	Voltage / Napiecie [V d.c.]	∅ [min <sup>-1</sup> ]	Toolholder size / Rozmiar uchwytu narzędziowego [mm]	📦
78974	18	0-350 / 0-1300	0.8-10	5

- EN Cordless glue gun
- PL Akumulatorowy pistolet do klejenia
- DE Heissklebepistole
- RU Пистолет для клея
- CZ Pistole na lepení
- RO Pistol pt. lipit
- HU Ragasztópisztoly
- ES Pistola de cola

7.2 V 1300mAh Li-Ion	25 W	3x Ø7.2 mm	15 s
45 min			



**STHOR**

No.	Voltage / Napiecie [V d.c.]	
78154	7.2	10

- EN Finishing sander
- PL Szlifierka oscylacyjna
- DE Schwingschleifer
- RU Виброшлифмашина
- CZ Oscilační bruska
- RO Polizor oscilant
- HU Vibrációs csiszológép
- ES Lijadora de oscilación

230V~ 50Hz	135 W	10000 min <sup>-1</sup>	90x187 mm
---------------	-------	----------------------------	--------------



$L_{pA} = 84,0 \pm 3,0$  dB;  $L_{wA} = 95,0 \pm 3,0$  dB;  $a_n = 3,7 \pm 1,5$  m/s<sup>2</sup>

**STHOR**

No.	Power / Moc [W]	$\Omega$ [min <sup>-1</sup> ]
79491	135	10000

- EN Circular saw
- PL Pilarka ręczna
- DE Handkreissäge
- RU Дисковая пила
- CZ Pila kotoučová
- RO Fierastrau circular
- HU Kézi körfűrészgép
- ES Sierra de disco

230-240V~ 50Hz	1400 W	4800 min <sup>-1</sup>	65 mm	185x20 x2.4 mm
24T	0-45°	90°-65 mm 45°-44 mm		



$L_{pA} = 94,0 \pm 3,0$  dB;  $L_{wA} = 105,0 \pm 3,0$  dB;  $a_n = 6,84 \pm 1,5$  m/s<sup>2</sup>

**STHOR**

No.	Power / Moc [W]	$\Omega$ [min <sup>-1</sup> ]
79257	1400	4800

- EN Orbital sander
- PL Szlifierka mimośrodowa
- DE Exzentrische Schleifmaschine
- RU Эксцентриковая шлифовальная машина
- CZ Excentrická bruska
- RO Polizor cu excentric
- HU Excenter csiszoló
- ES Pulidor excentrico

230V~ 50Hz	430 W	6000-13000 min <sup>-1</sup>	125 mm
---------------	-------	---------------------------------	-----------



$L_{pA} = 81,0 \pm 3,0$  dB;  $L_{wA} = 92,0 \pm 3,0$  dB;  $a_n = 10,8 \pm 1,5$  m/s<sup>2</sup>

**STHOR**

No.	Power / Moc [W]	$\Omega$ [min <sup>-1</sup> ]
79309	430	6000-13000

- EN Circular saw
- PL Pilarka ręczna
- DE Handkreissäge
- RU Дисковая пила
- CZ Pila kotoučová
- RO Fierastrau circular
- HU Kézi körfűrészgép
- ES Sierra de disco

230-240V~ 50Hz	1200 W	4800 min <sup>-1</sup>	52 mm	160x20 x2,2 mm
18T	0-45°	90°-52 mm 45°-37 mm		



$L_{pA} = 94,0 \pm 3,0$  dB;  $L_{wA} = 105,0 \pm 3,0$  dB;  $a_n = 6,84 \pm 1,5$  m/s<sup>2</sup>

**STHOR**

No.	Power / Moc [W]	$\Omega$ [min <sup>-1</sup> ]
79254	1200	4800

- EN Electric planer
- PL Strug elektryczny
- DE Elektrohobel
- RU Электрорубанок
- CZ Elektrický hoblík
- RO Rindea electrica
- HU Elektromos gyalu
- ES Garlopa eléctrica

230V~ 50Hz	600 W	16000 min <sup>-1</sup>	9-2 mm	82 mm
---------------	-------	----------------------------	-----------	-------



$L_{pA} = 83,0 \pm 3,0$  dB;  $L_{wA} = 94,0 \pm 3,0$  dB;  $a_n = 6,84 \pm 1,5$  m/s<sup>2</sup>

**STHOR**

No.	Power / Moc [W]	$\Omega$ [min <sup>-1</sup> ]
79416	600	16000



EN Hot air gun  
 PL Opalarka  
 DE Heissluftpistole  
 RU Строительный фен  
 CZ Opalovací stroj  
 RO Fion pt. ars vopseaua  
 HU Hőlégfúvó  
 ES Secadora

230V~50Hz I-1000W II-2000W I-350°C II-550°C



No.	Power / Moc [W]	Blast temperature / Temperatura nadmuchu [°C]	
79320	1000 (I) / 2000 (II)	350 (I) / 550 (II)	10

EN Hot air gun with accessories  
 PL Opalarka z akcesoriami  
 DE Heissluftpistole  
 RU Строительный фен в наборе  
 CZ Opalovací stroj s příslušenstvím  
 RO Fion cu accesorii pt. ars vopseaua  
 HU Hőlégfúvó tartozékokkal  
 ES Secadora con accesorios

230V~50Hz I-1000W II-1500W I-300°C II-500°C



No.	Power / Moc [W]	Blast temperature / Temperatura nadmuchu [°C]	
79328	1000 (I) / 1500 (II)	300 (I) / 500 (II)	5

EN Electric glue gun  
 PL Pistolet do klejenia  
 DE Heissklebepistole  
 RU Пистолет для клея  
 CZ Pistole na lepení  
 RO Pistol pt. lipit  
 HU Ragasztópisztoly  
 ES Pistola de cola

230V~50Hz 15(100)W 180-200°C 3-6 min 15 g/min 2x ø 11mm



No.	Power / Moc [W]	Glue stick diameter / Średnica wkładu klejowego [mm]	Capacity / Wydajność [g/min]	
73052	15 (100)	11	15	12/48

EN Hot air gun  
 PL Opalarka  
 DE Heissluftpistole  
 RU Строительный фен  
 CZ Opalovací stroj  
 RO Fion pt. ars vopseaua  
 HU Hőlégfúvó  
 ES Secadora

230V~50Hz I-1000W II-1500W I-300°C II-500°C



No.	Power / Moc [W]	Blast temperature / Temperatura nadmuchu [°C]	
79327	1000 (I) / 1500 (II)	300 (I) / 500 (II)	10

EN Electric glue gun  
 PL Pistolet do klejenia  
 DE Heissklebepistole  
 RU Пистолет для клея  
 CZ Pistole na lepení  
 RO Pistol pt. lipit  
 HU Ragasztópisztoly  
 ES Pistola de cola

230V~50Hz 15(40)W 200°C 3-5 min 8-12 g/min 2x ø 11mm



No.	Power / Moc [W]	Glue stick diameter / Średnica wkładu klejowego [mm]	Capacity / Wydajność [g/min]	
73056	15 (40)	11	8-12	6/48

EN Electric glue gun  
 PL Pistolet do klejenia  
 DE Heissklebepistole  
 RU Пистолет для клея  
 CZ Pistole na lepení  
 RO Pistol pt. lipit  
 HU Ragasztópisztoly  
 ES Pistola de cola

230V~50Hz 23(80)W 200°C 3-5 min 14-16 g/min 2x ø 11mm



No.	Power / Moc [W]	Glue stick diameter / Średnica wkładu klejowego [mm]	Capacity / Wydajność [g/min]	
73057	23 (80)	11	14-16	6/48

EN Soldering iron  
 PL Lutownica oporowa  
 DE LötKolben  
 RU Электропаяльник  
 CZ Pájka odporová  
 RO Ciocan de lipit  
 HU Forrasztópáka  
 ES Soldador de resistencia



**STKOR**

No.	Power / Moc [W]	
79365	30	25/50
79366	40	25/50
79367	60	25/50
79368	80	25/50

EN Electric paddle mixer  
 PL Mieszarka do zapraw  
 DE Mörtelmischgerät  
 RU Электрическая мешалка для минералов  
 CZ Míchadlo na maltu  
 RO Malaxor pt. mortar  
 HU Habarcskeverő  
 ES Mezcladora de mortero

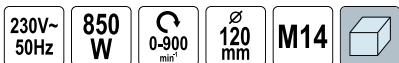

$L_{pa} = 87,0 \pm 3,0$  dB;  $L_{wa} = 98,0 \pm 3,0$  dB;  $a_n = 5,45 \pm 1,5$  m/s<sup>2</sup>

**STKOR**

No.	Power / Moc [W]	$\omega$ [min <sup>-1</sup> ]	
78855	850	0-900	4

EN Dirty water submersible pump  
 PL Pompa zatapialna do wody brudnej  
 DE Tauchpumpe für Schmutzwasser  
 RU Погружной насос для грязной воды  
 CZ Ponorné čerpadlo pro špinavú vodu  
 RO Pompă submersibilă pt. apă murdara  
 HU Bűvárszivattyú  
 ES Bomba sumergible para agua sucia

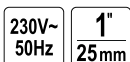

**STKOR**

No.	Power / Moc [W]	Max. capacity / Maks. wydajność [l/h]	Max. head / Maks. wysokość tłoczenia [m]	
79781	400	8000	5.5	4
79782	500	10000	6.5	4
79783	600	11500	7.0	4

EN Transformer soldering gun  
 PL Lutownica transformatorowa  
 DE Lötpistole  
 RU Электрический паяльник  
 CZ Transformátorová páječka  
 RO Pistol de lipit  
 HU Forrasztópáka  
 ES Soldador transformador



**STKOR**

No.	Power / Moc [W]	
79354	100	10

EN Dirty water submersible pump  
 PL Pompa zatapialna do wody brudnej  
 DE Tauchpumpe für Schmutzwasser  
 RU Погружной насос для грязной воды  
 CZ Ponorné čerpadlo pro špinavú vodu  
 RO Pompă submersibilă pt. apă murdara  
 HU Bűvárszivattyú  
 ES Bomba sumergible para agua sucia

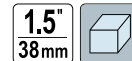
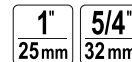
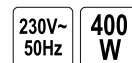

**STKOR**

No.	Power / Moc [W]	Max. capacity / Maks. wydajność [l/h]	Max. head / Maks. wysokość tłoczenia [m]	
79909	400	6000	6	6

EN Membrane deep well water pump  
 PL Pompa membranowa zatapialna  
 DE Tauch-Membranpumpe  
 RU Насос погружной мембранный  
 CZ Ponorné membránové čerpadlo  
 RO Pompă submersibilă cu membrană  
 HU Membrános bűvárszivattyú  
 ES Bomba sumergible para agua limpia

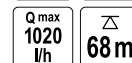
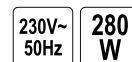

**STKOR**

No.	Power / Moc [W]	Max. capacity / Maks. wydajność [l/h]	Max. head / Maks. wysokość tłoczenia [m]	
79943	280	1020	68	4

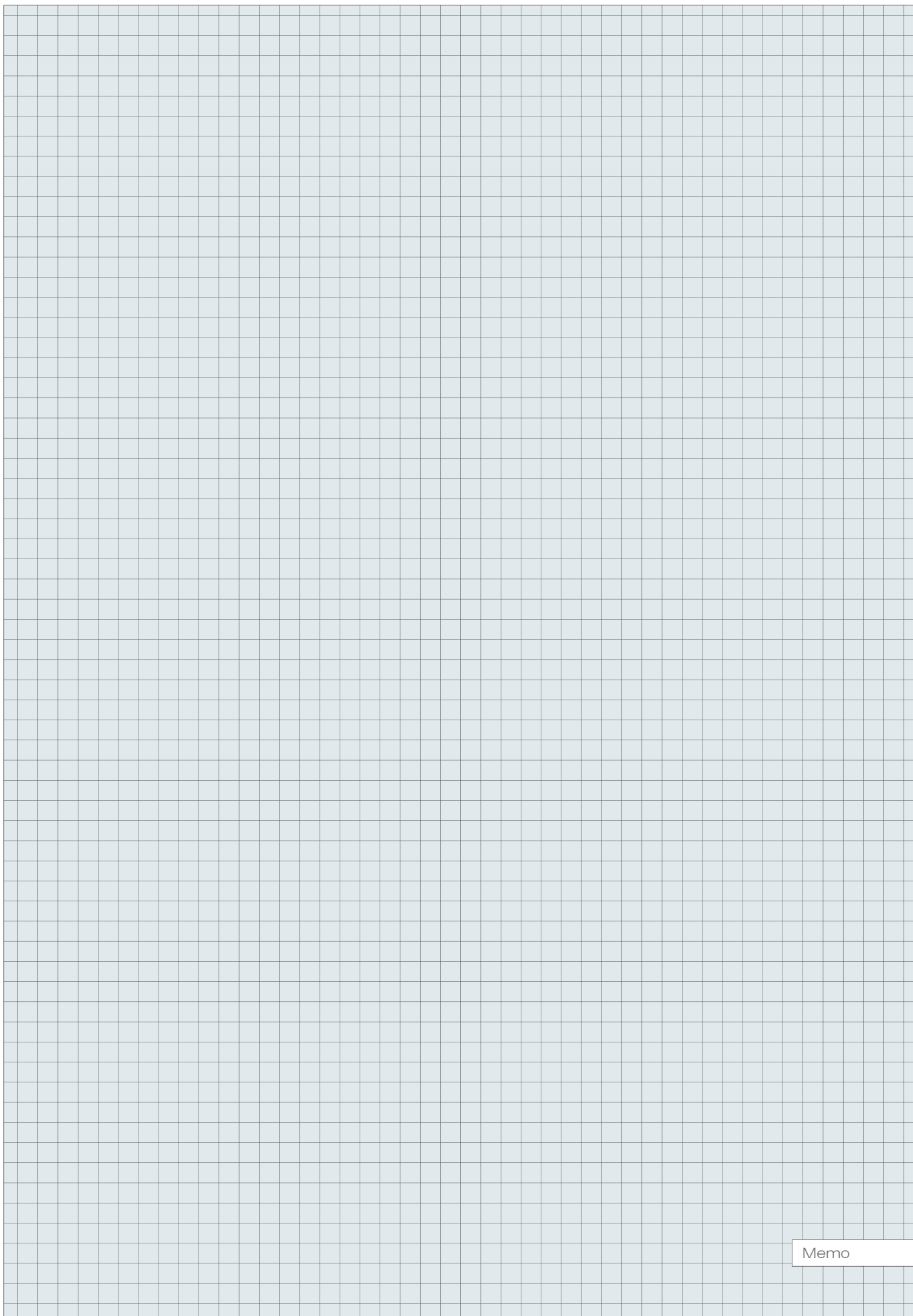

Memo

EN Hot knife for polystyrene foam  
 PL Nóż termiczny do styropianu  
 DE Thermomesser für Styropor  
 RU Термомож для пенопласта  
 CZ Termický nůž na polystyrén  
 RO Cuiț termic pt. polistiren  
 HU Polisztirolvágó hőkés  
 ES Cuchillo térmico para poliestireno



**INCLUDED:**  
 - 3 interchangeable tips: wire 17 cm, hot knife 12 cm, engraving tool 3.5 cm  
 - Base  
 - Additional cutting wire (1 pcs)

**W ZESTAWIE:**  
 - 3 wymienne końcówki: drut 17 cm, nóż do cięcia na gorąco 12 cm, nasadka do grawerowania 3.5 cm  
 - Podstawa  
 - Zapasowy drut tnący (1 szt.)



**LUND**

No.	Power / Moc [W]	Icon
78894	9	20

EN Car polisher  
 PL Polerka samochodowa  
 DE Autopoliermaschine  
 RU Полировальная машинка  
 CZ Leštička na automobily  
 RO Masina de lustruit automobile  
 HU Gépkocsi polírozógép  
 ES Máquina para pulir coches



15

**LUND**

$L_{pA} = 55,0 \pm 3,0$  dB;  $L_{wA} = 66,0 \pm 3,0$  dB;  $a_s = 14,8 \pm 1,5$  m/s<sup>2</sup>

No.	Power / Moc [W]	$\Omega$ [min <sup>-1</sup> ]	Icon
82942	120	3200	6

EN Hot air gun with accessories  
 PL Opalarka z akcesoriami  
 DE Heissluftpistole  
 RU Строительный фен в наборе  
 CZ Opalovací stroj s příslušenstvím  
 RO Fion cu accesorii pt. ars vopseaua  
 HU Hőlégfúvó tartozékokkal  
 ES Secadora con accesorios

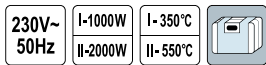

**LUND**

No.	Power / Moc [W]	Blast temperature / Temperatura nadmuchu [°C]	Icon
79325	1000 (I) / 2000 (II)	350 (I) / 550 (II)	10

EN Mini grinder  
 PL Uniwersalna szlifierka wielofunkcyjna  
 DE Universal-Mehrweckschleifmaschine  
 RU Универсальная шлифовальная машина  
 CZ Všeúčelová univerzální bruska  
 RO Mașina de șlefuit universală multifuncțională  
 HU Univerzális daugjafunkcis šlifvoklis  
 ES Lijadora multifunción

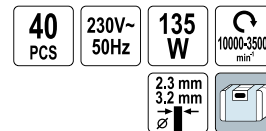

**LUND**

$L_{pA} = 72,0 \pm 3,0$  dB;  $L_{wA} = 83,0 \pm 3,0$  dB;  $a_s = 2,6 \pm 1,5$  m/s<sup>2</sup>

No.	Power / Moc [W]	$\Omega$ [min <sup>-1</sup> ]	Icon
79314	135	10 000 (I) / 15 000 (II) / 20 000 (III) / 25 000 (IV) / 30 000 (V) / 33 000 (VI) / 35 000 (max)	10

EN Hot air gun  
 PL Opalarka  
 DE Heissluftpistole  
 RU Строительный фен  
 CZ Opalovací stroj  
 RO Fion pt. ars vopseaua  
 HU Hőlégfúvó  
 ES Secadora



**LUND**

No.	Power / Moc [W]	Blast temperature / Temperatura nadmuchu [°C]	Icon
79324	750 (I) / 1500 (II)	300 (I) / 500 (II)	10

EN Electric glue gun  
 PL Pistolet do klejenia  
 DE Heissklebepistole  
 RU Пистолет для клея  
 CZ Pistolet na lepení  
 RO Pistol pt. lipit  
 HU Ragasztópisztoly  
 ES Pistola de cola

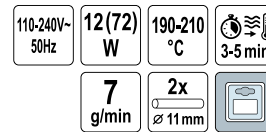

**LUND**

No.	Power / Moc [W]	Glue stick diameter / Średnica wkładu klejowego [mm]	Capacity / Wydajność [g/min]	Icon
73051	12 (72)	11	7	12/48



EN Electric glue gun  
 PL Pistolet do klejenia  
 DE Heissklebepistole  
 RU Пистолет для клея  
 CZ Pistolet na lepení  
 RO Pistol pt. lipit  
 HU Ragasztópisztoly  
 ES Pistola de cola

230V~ 50Hz	16 W	200 °C	11 g/min
3-5 min	11 mm		



**LUND**

No.	Power / Moc [W]	Glue stick diameter / Średnica wkładu klejowego [mm]	Capacity / Wydajność [g/min]	
73060	16	11	11	10

EN Wood burning kit  
 PL Lutownica i pirograf do drewna  
 DE Holzofen Kit  
 RU Пирографии набор  
 CZ Souprava pro spařování dřeva  
 RO Set pirogravură  
 HU Pirográf készülék  
 ES Pirograbado de madera kit

230V~ 50Hz	30 W	400 °C	
---------------	---------	-----------	---



**LUND**

No.	Power / Moc [W]	
78890	30	15

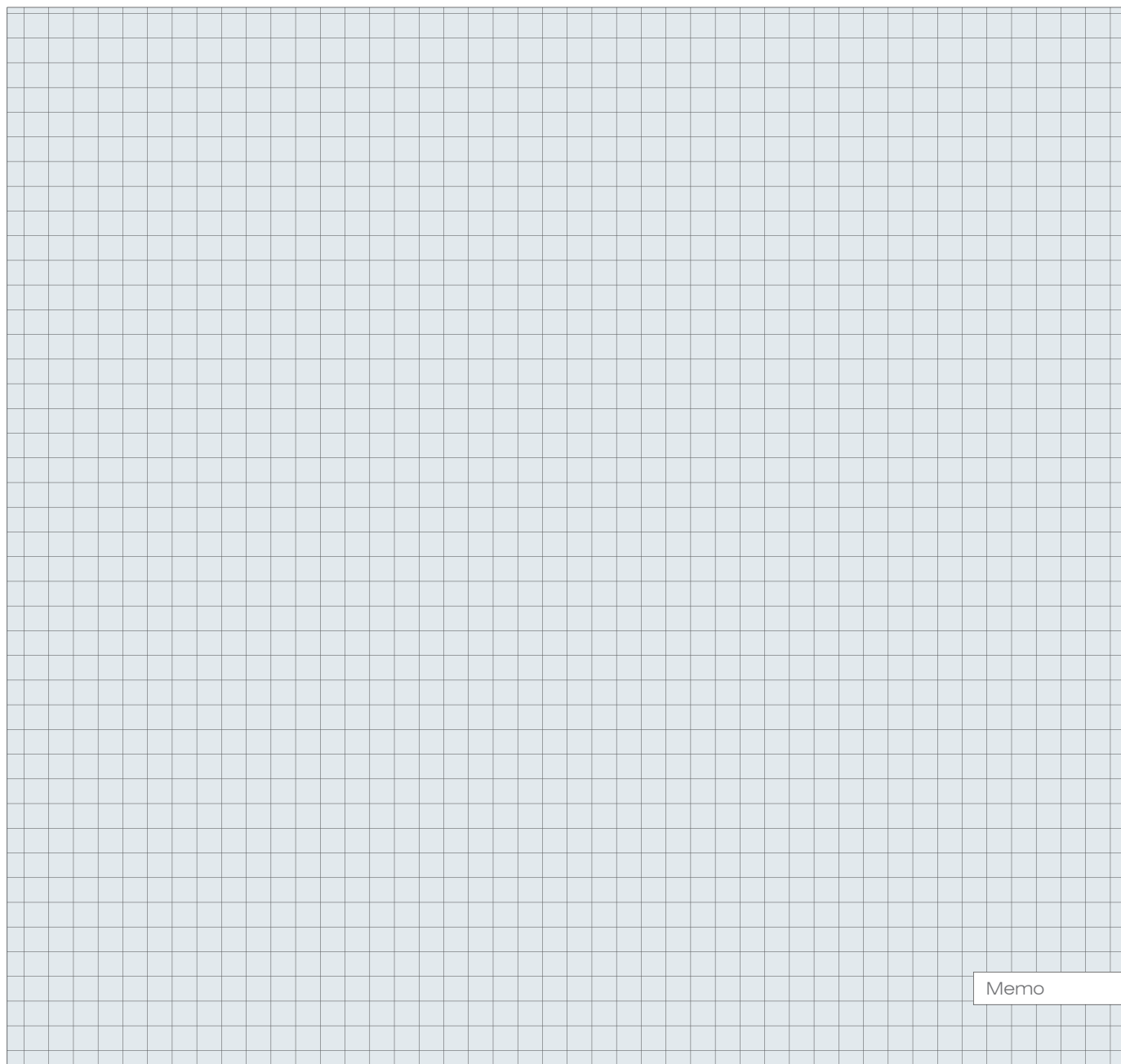

EN Dirty water submersible pump  
 PL Pompa zatapialna do wody brudnej  
 DE Tauchpumpe für Schmutzwasser  
 RU Погружной насос для грязной воды  
 CZ Ponorné čerpadlo pro špinavú vodu  
 RO Pompă submersibilă pt. apă murdara  
 HU Bűvárszivattyú  
 ES Bomba sumergible para agua sucia

230V~50Hz 1" 25mm  
 5/4" 32mm 1.5" 38mm



No.	Power / Moc [W]	Max. capacity / Maks. wydajność [l/h]	Max. head / Maks. wysokość tłoczenia [m]	
79771	400	10000	6.5	4
79772	550	11500	7.0	4
79773	750	14000	7.5	4
79774	900	16000	8.5	4
79775	1100	16000	8.5	4

EN Membrane deep well water pump  
 PL Pompa membranowa zatapialna  
 DE Tauch-Membranpumpe  
 RU Насос погружной мембранный  
 CZ Ponorné membránové čerpadlo  
 RO Pompă submersibilă cu membrană  
 HU Membrános bűvárszivattyú  
 ES Bomba sumergible para agua limpia

220-230V-50Hz 350 W  
 Q max 1200 l/h 70 m



No.	Power / Moc [W]	Max. capacity / Maks. wydajność [l/h]	Max. head / Maks. wysokość tłoczenia [m]	
79944	350	1200	70	4

EN Jet pump  
 PL Pompa ogrodowa  
 DE Gartenpumpe  
 RU Насос садовый  
 CZ Zahradní čerpadlo  
 RO Pompă apă  
 HU Kerti szivattyúhoz  
 ES Bomba de jardín con cabeza

230V~50Hz



L<sub>WA</sub> = 95,0 ± 3,0 dB

No.	Power / Moc [W]	Max. capacity / Maks. wydajność [l/h]	Max. lifting height / Maks. wysokość podnoszenia [m]	Max. pumping pressure / Maks. ciśnienie tłoczenia [bar]	
79810	600	2800	35	3.5	1
79811	800	3600	40	4.0	1
79812	1000	3800	44	4.4	1



EN Dirty water submersible pump  
 PL Pompa zatapialna do wody brudnej  
 DE Tauchpumpe für Schmutzwasser  
 RU Погружной насос для грязной воды  
 CZ Ponorné čerpadlo pro špinavú vodu  
 RO Pompă submersibilă pt. apă murdara  
 HU Bűvárszivattyú  
 ES Bomba sumergible para agua sucia

230V~50Hz 1" 25mm  
 5/4" 32mm 1.5" 38mm  
 INOX



No.	Power / Moc [W]	Max. capacity / Maks. wydajność [l/h]	Max. head / Maks. wysokość tłoczenia [m]	
79790	750	14000	7.5	2
79791	900	16000	8.5	2
79792	1100	20000	9.0	2

EN Submersible pump for dirty water and wastewater  
 PL Pompa zatapialna do wody brudnej i ścieków  
 DE Tauchpumpe für Schmutzwasser  
 RU Погружной насос для грязной воды  
 CZ Ponorné čerpadlo pro odpadní vodu  
 RO Pompă submersibilă pt. apă uzată  
 HU Bűvárszivattyú szennyvíz  
 ES Bomba sumergible para aguas residuales

230V~50Hz 450 W Q max 16000 l/h



No.	Power / Moc [W]	Max. capacity / Maks. wydajność [l/h]	Max. head / Maks. wysokość tłoczenia [m]	
79880	450	16000	9	1

EN Fountain pump  
 PL Pompa fontannaowa  
 DE Springbrunnenpumpe  
 RU Фонтанный насос  
 CZ Fontánová pumpa  
 RO Pompa pt. fantana arteziana  
 HU Pumpa szökkóúthoz  
 ES Bomba para las fuentes



230V~  
50Hz

3  
NOZZLES  
DYŠZE

IPX8



No.	Power / Moc [W]	Max. capacity / Maks. wydajność [l/h]	Max. head / Maks. wysokość tłoczenia [m]	
79926	8	600	1.0	12
79927	16	800	1.3	12
79928	22	1000	1.6	12

EN Fountain pump  
 PL Pompa fontannaowa  
 DE Springbrunnenpumpe  
 RU Фонтанный насос  
 CZ Fontánová pumpa  
 RO Pompa pt. fantana arteziana  
 HU Pumpa szökkóúthoz  
 ES Bomba para las fuentes



230V~  
50Hz

5  
NOZZLES  
DYŠZE

IP68

10 m



No.	Power / Moc [W]	Max. capacity / Maks. wydajność [l/h]	Max. head / Maks. wysokość tłoczenia [m]	
79931	55	2000	2.5	8
79932	85	3000	3.5	8
79933	100	4500	4.5	6

EN Cordless grass and shrub shears  
 PL Akumulatorowe nożyce do trawy i krzewów  
 DE Akku Gras- und Strauchschere  
 RU Аккумуляторные ножницы для травы и кустов  
 CZ Akumulátorové nůžky na trávu a keře  
 RO Trimmer cu acumulator pt. iarba si gard viu  
 HU Akkumulátoros fű- és bokornyíró  
 ES Tijeras a batería para hierba y arbustos

2in1 3.6 V 1500mAh Li-Ion

1h



$L_{pA} = 55,5 \pm 3,0$  dB;  $L_{wA} = 75,5 \pm 3,0$  dB;  $a_n = 0,912 \pm 1,5$  m/s<sup>2</sup>

No.	Voltage / Napięcie [V d.c.]	Cutting speed / Prędkość cięcia [min <sup>-1</sup> ]	
79503	3.6	1100	6

EN Fountain pump  
 PL Pompa fontannaowa  
 DE Springbrunnenpumpe  
 RU Фонтанный насос  
 CZ Fontánová pumpa  
 RO Pompa pt. fantana arteziana  
 HU Pumpa szökkóúthoz  
 ES Bomba para las fuentes



230V~  
50Hz

5  
NOZZLES  
DYŠZE

IPX8



No.	Power / Moc [W]	Max. capacity / Maks. wydajność [l/h]	Max. head / Maks. wysokość tłoczenia [m]	
79929	28	1400	2.0	8
79930	40	1800	2.5	8

EN Cordless grass and shrub shears  
 PL Akumulatorowe nożyce do trawy i krzewów  
 DE Akku Gras- und Strauchschere  
 RU Аккумуляторные ножницы для травы и кустов  
 CZ Akumulátorové nůžky na trávu a keře  
 RO Trimmer cu acumulator pt. iarba si gard viu  
 HU Akkumulátoros fű- és bokornyíró  
 ES Tijeras a batería para hierba y arbustos

2in1 3.6 V 1500mAh Li-Ion

1h



$L_{pA} = 55,5 \pm 3,0$  dB;  $L_{wA} = 75,5 \pm 3,0$  dB;  $a_n = 0,912 \pm 1,5$  m/s<sup>2</sup>

No.	Voltage / Napięcie [V d.c.]	Cutting speed / Prędkość cięcia [min <sup>-1</sup> ]	
79502	3.6	1100	10

EN Electric hedge trimmer  
 PL Elektryczne nożyce do żywoplotu  
 DE Elektrische Heckenschere  
 RU Электрический кусторез  
 CZ Elektrické nůžky na živý plot  
 RO Foarfeca electrică pt. gard viu  
 HU Elektromos sövényvágó olló  
 ES Cortasetos eléctrico

230V~  
50Hz

550 W



$L_{pA} = 88,0 \pm 3,0$  dB;  $L_{wA} = 99,0 \pm 3,0$  dB;  $a_n = 1,982 \pm 1,5 / 1,778 \pm 1,5$  m/s<sup>2</sup>

No.	Power / Moc [W]	Cutting speed / Prędkość cięcia [min <sup>-1</sup> ]	Cutting length / Długość cięcia [mm]	
79448	550	1700	510	4

EN Electric chainsaw  
 PL Elektryczna pilarka łańcuchowa  
 DE Elektrische Kettensäge  
 RU Электрическая цепная пила  
 CZ Elektrická řetězová pila  
 RO Ferăstrau electric cu lanț  
 HU Elektromos láncfűrész  
 ES Sierra de cadena eléctrica

230-240V-50Hz	1600 W	7000 min <sup>-1</sup>	14" / 35.5 cm
38 / 9.52 mm	0.05 / 1.3 mm	13 m/s	0.11 L



$L_{pA} = 90,2 \pm 3,0$  dB;  $L_{wA} = 103,2 \pm 3,0$  dB;  $a_h = 8,393 \pm 1,5 / 6,002 \pm 1,5$  m/s<sup>2</sup>

No.	Power / Moc [W]	
79675	1600	2

EN Electric scarifier  
 PL Wertykulator elektryczny  
 DE Elektrischer Vertikutierer  
 RU Электрический скарификатор  
 CZ Elektrický vertikutátor  
 RO Scarificator electric  
 HU Elektromos gypszelőztető  
 ES Escarificador eléctrico

EN Electric soil tiller  
 PL Glebogryzarka elektryczna  
 DE Elektro-Bodenhacke  
 RU Электрический культиватор  
 CZ Elektrický kultivátor  
 RO Motosapă electrică  
 HU Elektromos kapálógép  
 ES Motoazada eléctrica

230-240V-50Hz	750 W
220 mm	320 mm
Ø 205 mm	



$L_{pA} = 79,0 \pm 3,0$  dB;  $L_{wA} = 91,87 \pm 0,48$  dB;  $a_h = 1,153 \pm 1,5 / 1,158 \pm 1,5$  m/s<sup>2</sup>

No.	Power / Moc [W]	
79725	750	1



$L_{pA} = 84,5 \pm 3,0$  dB;  $L_{wA} = 97,3 \pm 1,05$  dB;  $a_h = 4,265 \pm 1,5$  m/s<sup>2</sup>

No.	Power / Moc [W]	
79734	1500	1

230-240V-50Hz	1500 W
3000 min <sup>-1</sup>	max 12mm
320 mm	30 L
INTERCHANGEABLE ROLLERS / WYMIENNE WALKI	
✦ x16	✦ x20

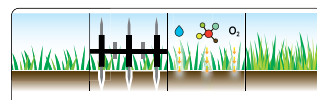

15

Memo



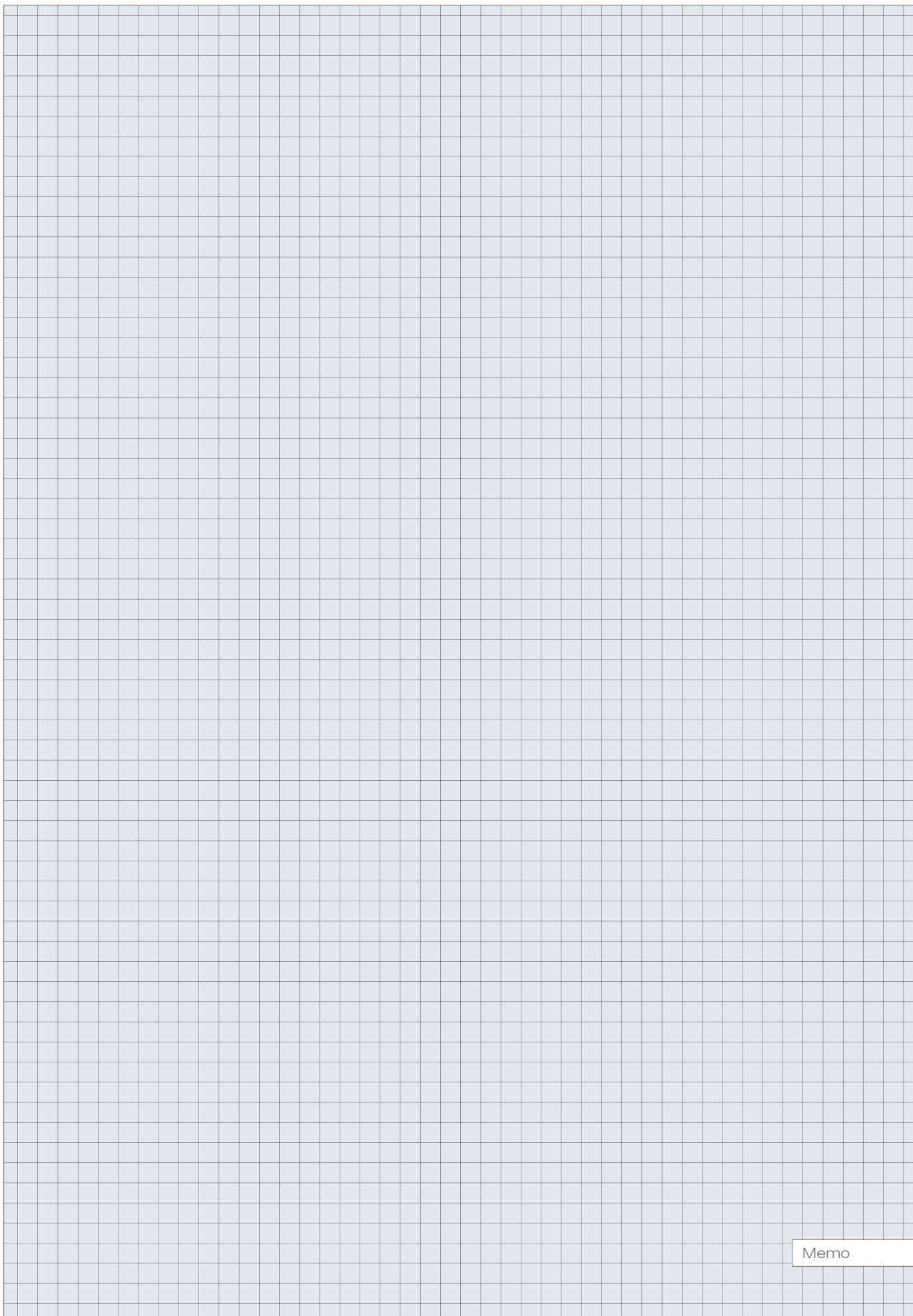

Memo

EN Soldering iron  
 PL Lutownica pistoletowa  
 DE DelötKolben  
 RU Электропаяльник

CZ Pájka odporová  
 RO Ciocan de lipit  
 HU Huforrasztópáka  
 ES Soldador de resistencia

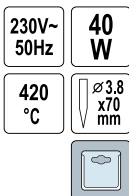

No.	Power / Moc [W]	
79358	40	25/50

EN Chain saw file  
 PL Pilnik okrągły do łańcuchów  
 DE Runde Kettenfeile  
 RU Цилиндрический напильник для цепей  
 CZ Kulatý pilník na řetězy  
 RO Pilă rotundă pt. lanțuri  
 HU Láncvágó körfűrész  
 ES Lima redonda para cadenas



No.	L [mm]	Chain pitch / Podziałka łańcucha	Ø [mm]	pcs / szt.	
79861	200	3/8 picco	4.0	3	4/200
79862	200	microlite	4.5	3	4/200
79863	200	.325	4.8	3	4/200

EN Universal wrench for gasoline machines  
 PL Klucz uniwersalny do narzędzi spalinowych  
 DE Universalschlüssel für Benzin Maschinen  
 RU Универсальный ключ для бензинового инструмента

CZ Univerzální klíč pro benzínové stroje  
 RO Cheie universală pt. masini pe benzina  
 HU Kulccsal benzin eszköz  
 ES Llave universal para máquinas de gasolina



No.	
79869	10/100

EN Line head  
 PL Głowica żyłkowa  
 DE Trimmerkopf  
 RU Головка с леской  
 CZ Strunová hlava  
 RO Cap cu cablu  
 HU Damil fej  
 ES Cabezal de hilo



No.	Ø [mm]	
79550	2.0-2.4	10/40

EN Transformer soldering gun  
 PL Lutownica transformatorowa  
 DE Lötpistole  
 RU Электрический паяльник

CZ Transformátorová páječka  
 RO Pistol de lipit  
 HU Forrasztópáka  
 ES Soldador transformador

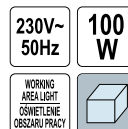

No.	Power / Moc [W]	
79350	100	24

EN Guide for chain saw file  
 PL Prowadnik do pilnika do łańcuchów  
 DE Führung für die Kettenfeile  
 RU Направляющая для напильника для цепей  
 CZ Vedení pro pilník na řetězy  
 RO Ghidaj pt. pila pt. lanțuri  
 HU Megvezető a láncfűrészhez  
 ES Guía de lima para cadenas



No.	Chain pitch / Podziałka łańcucha	Ø [mm]	
79865	3/8 picco	4.0	50/150
79866	microlite	4.5	50/150
79867	.325	4.8	50/150



EN Line head  
 PL Głowica żyłkowa  
 DE Trimmerkopf  
 RU Головка с леской  
 CZ Strunová hlava  
 RO Cap cu cablu  
 HU Damil fej  
 ES Cabezal de hilo

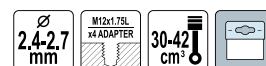

No.	Ø [mm]	
79551	2.4-2.7	10/40

EN Line head  
 PL Głowica żyłkowa  
 DE Trimmerkopf  
 RU Головка с леской  
 CZ Strunová hlava  
 RO Cap cu cablu  
 HU Damil fej  
 ES Cabezal de hilo



No.	Ø [mm]	
79552	2.4-2.7	10/40

EN 2-tooth brushcutter blade  
 PL Tarcza tnąca dwuzębna  
 DE 2-Zahn Dickichtmesser  
 RU Нож для мотокосы двулопастной  
 CZ Žací nůž 2-zubý  
 RO Lama de cosit cu 2 dinti  
 HU 2-ágú bozótvágo kés  
 ES Cuchilla de 2 puntas para desbrozadora



No.		
79560		25/50

EN Brushcutter chisel-tooth blade  
 PL Tarcza tnąca z zębami przecinakowymi  
 DE Meißelzahn-Sägeblatt für Motorsensen  
 RU Нож для мотокосы  
 CZ Rezací nůž s dlátovými zuby  
 RO Lama cu dinte tip dalta pt. cosit  
 HU Fűrészkorong vágótárcsa  
 ES Disco de corte para desbrozadora

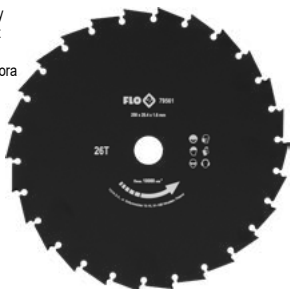

No.		
79561		15/30

EN 3-tooth brushcutter blade  
 PL Tarcza tnąca trójzębna  
 DE 3-Zahn Dickichtmesser  
 RU Нож трехлопастной  
 CZ Žací nůž 3-zubý  
 RO Lama taiere cu 3 dinti pt. motocoase  
 HU 3 fogú vágókés  
 ES Cuchilla de 3 puntas para desbrozadora



No.		
79564		25/50

EN Line head  
 PL Głowica żyłkowa  
 DE Trimmerkopf  
 RU Головка с леской  
 CZ Strunová hlava  
 RO Cap cu cablu  
 HU Damil fej  
 ES Cabezal de hilo



No.	Ø [mm]	For / Dia	
79468	1.2	79467	20/100

EN Brushcutter shredder blade  
 PL Nóż rozdrabniający  
 DE Mulchmesser  
 RU Нож для мотокосы  
 CZ Žací nůž mulčovací  
 RO Lama tocator pt. motocoasa  
 HU Bozótvágo penge  
 ES Cuchilla de triturar

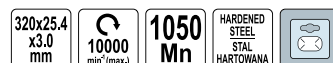

No.		
79563		20/40

EN 8-tooth brushcutter blade  
 PL Tarcza tnąca ośmiozębna  
 DE 8-Zahn Dickichtmesser  
 RU Диск для мотокосы  
 CZ Žací nůž 8-zubý  
 RO Lama de cosit cu 8 dinti  
 HU 8 fogú bozótvágo tárcsa  
 ES Disco de 8 dientes para desbrozadora

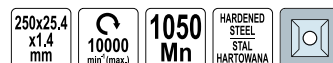

No.		
79562		20/40

EN 3-tooth brushcutter blade  
 PL Tarcza tnąca trójzębna  
 DE 3-Zahn Dickichtmesser  
 RU Нож трехлопастной  
 CZ Žací nůž 3-zubý  
 RO Lama taiere cu 3 dinti pt. motocoase  
 HU 3 fogú vágókés  
 ES Cuchilla de 3 puntas para desbrozadora



No.		
79565		25/50

EN Brushcutter saw blade  
 PL Tarcza tnąca z zębami ukośnymi  
 DE Spitzzahn-Sägeblatt für Motorsensen  
 RU Диск для мотокоосы  
 CZ Pilový kotouč se špičatými zuby  
 RO Lama pt. motocoasa  
 HU Fűkasza vágótárcsa  
 ES Disco cortahierbas con dientes en pico



No.	25/50
79566	

EN Grass trimmer line  
 PL Żyłka tnąca  
 DE Mähfaden  
 RU Леска для триммера

CZ Struna do strunové sekačky  
 RO Furtun gradina  
 HU Damil szegélynyíró géphez  
 ES Hilo de cortar



No.	Ø [mm]	L [m]	Cutting line profile / Przekrój żyłki	20/240
89401	1.3	10	○	20/240
89402	1.6	10	○	20/240
89403	2.0	10	○	20/240
89404	2.4	10	○	12/144
89405	2.6	10	○	12/144
89406	3.0	10	○	12/144

EN Grass trimmer line  
 PL Żyłka tnąca  
 DE Mähfaden  
 RU Леска для триммера

CZ Struna do strunové sekačky  
 RO Furtun gradina  
 HU Damil szegélynyíró géphez  
 ES Hilo de cortar



No.	Ø [mm]	L [m]	Cutting line profile / Przekrój żyłki	20/240
89411	1.3	10	□	20/240
89412	1.6	10	□	20/240
89413	2.0	10	□	20/240
89414	2.4	10	□	12/144
89415	2.6	10	□	12/144
89416	3.0	10	□	12/144

EN 4-tooth brushcutter blade  
 PL Tarcza tnąca czterozębna  
 DE 4-Zahn Dickichtmesser  
 RU Диск для мотокоосы  
 CZ Žací nůž 4-zubý  
 RO Lama de cosit cu 4 dinti  
 HU 4-ágú bozótívágó kés  
 ES Disco de 4 puntas para desbrozadora

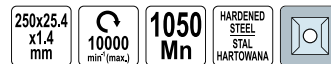

No.	25/50
79567	

EN Grass trimmer line  
 PL Żyłka tnąca  
 DE Mähfaden  
 RU Леска для триммера

CZ Struna do strunové sekačky  
 RO Furtun gradina  
 HU Damil szegélynyíró géphez  
 ES Hilo de cortar



No.	Ø [mm]	L [m]	Cutting line profile / Przekrój żyłki	27
89441	2.0	120	○	27
89442	2.4	90	○	27
89443	2.6	70	○	27
89444	3.0	56	○	27

EN Grass trimmer line  
 PL Żyłka tnąca  
 DE Mähfaden  
 RU Леска для триммера

CZ Struna do strunové sekačky  
 RO Furtun gradina  
 HU Damil szegélynyíró géphez  
 ES Hilo de cortar



No.	Ø [mm]	L [m]	Cutting line profile / Przekrój żyłki	16
89452	2.4	90	□	16
89453	2.6	70	□	16
89454	3.0	56	□	16



EN Grass trimmer line  
 PL Żyłka tnąca  
 DE Mähfaden  
 RU Леска для триммера

CZ Struna do strunové sekačky  
 RO Furtun gradina  
 HU Damil szegélynyíró géphez  
 ES Hilo de cortar

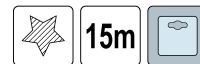

**FLO**

No.	Ø [mm]	L [m]	Cutting line profile / Przekrój żyłki	
89421	1.3	15	☆	24/288
89422	1.6	15	☆	20/240
89423	2.0	15	☆	16/192
89424	2.4	15	☆	12/144
89425	2.6	15	☆	12/144
89426	3.0	15	☆	10/120

EN Grass trimmer line  
 PL Żyłka tnąca  
 DE Mähfaden  
 RU Леска для триммера  
 CZ Struna do strunové sekačky  
 RO Furtun gradina  
 HU Damil szegélynyíró géphez  
 ES Hilo de cortar



**FLO**

No.	Ø [mm]	L [m]	Cutting line profile / Przekrój żyłki	
89456	2.0	90	☆	9/27
89457	2.4	90	☆	9/27
89458	2.6	90	☆	9/27
89459	3.0	60	☆	9/27

EN Grass trimmer line  
 PL Żyłka tnąca  
 DE Mähfaden  
 RU Леска для триммера  
 CZ Struna do strunové sekačky  
 RO Furtun gradina  
 HU Damil szegélynyíró géphez  
 ES Hilo de cortar

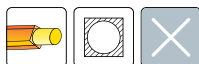

**FLO**

No.	Ø [mm]	L [m]	Cutting line profile / Przekrój żyłki	
89465	2.4	90		10/20
89466	2.7	70		10/20
89467	3.0	60		10/20

EN Grass trimmer line  
 PL Żyłka tnąca  
 DE Mähfaden  
 RU Леска для триммера  
 CZ Struna do strunové sekačky  
 RO Furtun gradina  
 HU Damil szegélynyíró géphez  
 ES Hilo de cortar



**FLO**

No.	Ø [mm]	L [m]	Cutting line profile / Przekrój żyłki	
89473	2.4	90		10/20
89474	2.7	70		10/20
89475	3.0	60		10/20

EN Grass trimmer line  
 PL Żyłka tnąca  
 DE Mähfaden  
 RU Леска для триммера  
 CZ Struna do strunové sekačky  
 RO Furtun gradina  
 HU Damil szegélynyíró géphez  
 ES Hilo de cortar

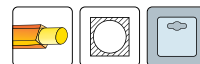

**FLO**

No.	Ø [mm]	L [m]	Cutting line profile / Przekrój żyłki	
89462	2.4	15		10/120
89463	2.7	15		10/120
89464	3.0	12		10/120

EN Grass trimmer line  
 PL Żyłka tnąca  
 DE Mähfaden  
 RU Леска для триммера  
 CZ Struna do strunové sekačky  
 RO Furtun gradina  
 HU Damil szegélynyíró géphez  
 ES Hilo de cortar



**FLO**

No.	Ø [mm]	L [m]	Cutting line profile / Przekrój żyłki	
89470	2.4	15		10/120
89471	2.7	15		10/120
89472	3.0	12		10/120

EN Grass trimmer line  
 PL Żyłka tnąca  
 DE Mähfaden  
 RU Леска для триммера

CZ Struna do strunové sekačky  
 RO Furtun gradina  
 HU Damil szegélynyíró géphez  
 ES Hilo de cortar

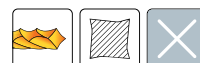

**FLO**

No.	Ø [mm]	L [m]	Cutting line profile / Przekrój żyłki	
89483	2.0	90		10/20
89484	2.4	90		10/20
89485	2.7	70		10/20
89486	3.0	60		10/20

- EN Grass trimmer line
- PL Żyłka tnąca
- DE Mähfaden
- RU Леска для триммера
- CZ Struna do strunové sekačky
- RO Furtun gradina
- HU Damil szegélynyíró géphez
- ES Hilo de cortar



No.	Ø [mm]	L [m]	Cutting line profile / Przekrój żyłki	
89478	1.6	15		20/240
89479	2.0	15		10/120
89480	2.4	15		10/120
89481	2.7	15		10/120
89482	3.0	12		10/120

- EN Brass straight connection
- PL Króciec mosiężny do pomp
- DE Messingstutzen für Pumpen
- RU Латунный патрубок для насосов
- CZ Mosazná přípojka pro čerpadla
- RO Conector alama
- HU Sárgaréz csatlakozó szivattyúkhöz
- ES Conector de latón para bombas



No.	Hose diameter / Średnica węży	
79924	1" (25 mm)	10/80

- EN Drill chuck
- PL Głowica do wiertarki samozaciskowej
- DE Schnellspanbohrfutter
- RU Патрон сверлильный быстрозажимной
- CZ Hlava na vrtáčku samosvorná
- RO Mandrină cu autostrângere pt. bormașină
- HU Az önbeszorulós fúrógéptokmányfej
- ES Cabeza para taladradora autoapriete

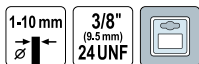

No.	Toolholder size / Rozmiar uchwyty narzędziowego [mm]	Thread size / Rozmiar gwintu	
79570	1-10	G3/8	10/40

- EN Drill chuck
- PL Głowica do wiertarki na klucz
- DE Schnellspanbohrfutter
- RU Патрон сверлильный ключевой
- CZ Hlava na vrtáčku na klíč
- RO Mandrină cu cheie pt. bormașină
- HU Az önbeszorulós fúrógéptokmányfej
- ES Cabeza para taladradora de llave



No.	Toolholder size / Rozmiar uchwyty narzędziowego [mm]	Thread size / Rozmiar gwintu	
79630	1.5-13	G1/2	5/40

- EN Hose connection
- PL Przyłącze do węży do pomp zatapialnych
- DE Druckleitung-Anschlussstülze
- RU Соединитель для шланга
- CZ Koleno k hadici
- RO Ștuf de fixare furtun
- HU Tömlő csatlakozó
- ES Tubuladura para manguera para bombas de inmersiyn

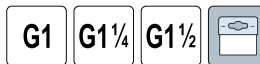

No.	
79919	100



- EN Drill chuck
- PL Głowica do wiertarki samozaciskowej
- DE Schnellspanbohrfutter
- RU Патрон сверлильный быстрозажимной
- CZ Hlava na vrtáčku samosvorná
- RO Mandrină cu autostrângere pt. bormașină
- HU Az önbeszorulós fúrógéptokmányfej
- ES Cabeza para taladradora autoapriete

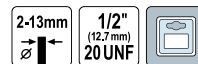

No.	Toolholder size / Rozmiar uchwyty narzędziowego [mm]	Thread size / Rozmiar gwintu	
79580	2-13	G1/2	5/40

- EN Adapter SDS-plus - UNF 1/2"
- PL Adapter SDS-plus - UNF 1/2"
- DE Adapter SDS-plus - UNF 1/2"
- RU Переходник SDS-plus - UNF 1/2"
- CZ Přenoska SDS-plus - UNF 1/2"
- RO Adaptor SDS-plus - UNF 1/2"
- HU Adaptor SDS-plus - UNF 1/2"
- ES Adaptor SDS-plus - UNF 1/2"



No.	Thread size / Rozmiar gwintu	
79800	G1/2	12/144

EN Multipurpose drill bit sharpener  
 PL Wielofunkcyjna ostrzałka do wiertel  
 DE Vielzweck Bohrererschleifgerät  
 RU Машина для заточки сверл  
 CZ Ostrůvka pro ostření vrtáků  
 RO Mașină de ascuțit burghie  
 HU Fúróélező  
 ES Afiladora de brocas



$L_{PA} = 61,0 \pm 3,0$  dB;  $L_{WA} = 74,0 \pm 3,0$  dB

No.	Power / Moc [W]	Box icon
73470	70	6

EN Angle grinder stand  
 PL Statyw do szlifierki kątowej  
 DE Winkelschleif-Trennstander  
 RU Стойка для угловой шлифовальной машины  
 CZ Stojan pro úhlovou brusku  
 RO Suport pt. polizor unghiular  
 HU Állvány sarokcsiszolóhoz  
 ES Soporte para lijadora de ángulo



No.	Box icon
79641	4

EN Drill stand  
 PL Statyw do wiertarki  
 DE Bohrmaschinen-Ständer  
 RU Стойка для дрели  
 CZ Stativ do vrtačky  
 RO Suport mașină de gaurit  
 HU Fúróállvány  
 ES Soporte para taladro



No.	H [mm]	Box icon
79639	400	8

EN Multi-function sharpener  
 PL Ostrzałka wielofunkcyjna  
 DE Multifunktionales Schärfergerät  
 RU Многофункциональный заточной станок  
 CZ Víceúčelová bruska  
 RO Mașină de ascuțit multifuncțională  
 HU Multifunkciós élezőgép  
 ES Afilador multifuncional



$L_{PA} = 80,0 \pm 3,0$  dB;  $L_{WA} = 93,0 \pm 3,0$  dB



No.	Power / Moc [W]	Box icon
73473	150	2

EN Drill stand  
 PL Statyw do wiertarki  
 DE Bohrmaschinen-Ständer  
 RU Стойка для дрели  
 CZ Stativ do vrtačky  
 RO Suport mașină de gaurit  
 HU Fúróállvány  
 ES Soporte para taladro



No.	H [mm]	Box icon
79640	400	10

EN Spare cutting knife for electric planer  
 PL Zapasowe ostrza do struga elektrycznego  
 DE Hobelmesser für Elektroholer  
 RU Лезвия для электрорубанка  
 CZ Náhradní nůž pro elektr. hoblíku  
 RO Lamă de rezervă pt. rindea electrică  
 HU Tartalék gyalukés elektromos gyalugéphez  
 ES Filos de repuesto para cepillo eléctrico



No.	pcs / szt.	Box icon
79346	2	30/360

EN Mounted stone set  
 PL Kamienie szlifierskie trzpieniowe  
 DE Schleifsteinaufsätze  
 RU Набор абразивных наконечников  
 CZ Brusné kámeny hrotové  
 RO Set pietre abrazive cu tija  
 HU Csiszolókő készlet, csapszárú  
 ES Discos de esmeril



No.	Chuck diameter / Średnica trzpienia [mm]	pcs / szt.	
25400	6	5	25/200

EN Mini grinder accessories set  
 PL Zestaw końcówek do szlifierki  
 DE Schleifaufsätze  
 RU Набор шлифовальных и полировочных насадок  
 CZ Soustava koncovek na brusku  
 RO Set pietre abrazive si pasla pt. slefuit  
 HU Fejkészlet csiszológéphez  
 ES Juego de puntas de pulir



VOREL

No.	pcs / szt.	
25410	13	10/50

EN Mini grinder accessories set  
 PL Zestaw końcówek do szlifierki  
 DE Schleifaufsätze  
 RU Набор шлифовальных и полировочных насадок  
 CZ Soustava koncovek na brusku  
 RO Set pietre abrazive si pasla pt. slefuit  
 HU Fejkészlet csiszológéphez  
 ES Juego de puntas de pulir



VOREL

No.	pcs / szt.	
25412	22	10/50

EN Helping hand with magnifying glass  
 PL Zestaw „trzecia ręka” z lupą  
 DE Dritte Hand mit Lupe  
 RU Комплект „третья ручка” с лупой  
 CZ Držák třetí ruka s lupou  
 RO Suport cu lupa pt. ciocan lipit  
 HU Paneltartó állvány „harmadik kéz”  
 ES Tercera mano con lupa

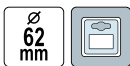

No.	Lenses diameter / Średnica soczewek [mm]	
73500	62	10/40

EN Rotary file set  
 PL Tarniki trzpieniowe  
 DE Profil-Fräser Satz  
 RU Набор фрез  
 CZ Hrotové rašple  
 RO Raspeluri cu coadă  
 HU Fareszelőkészlet, csapszárú  
 ES Rotatorio archivos



No.	Chuck diameter / Średnica trzpienia [mm]	pcs / szt.	
25450	6	5	25/200

EN Mini grinder accessories set  
 PL Zestaw końcówek do szlifierki  
 DE Schleifaufsätze  
 RU Набор шлифовальных и полировочных насадок  
 CZ Soustava koncovek na brusku  
 RO Set pietre abrazive si pasla pt. slefuit  
 HU Fejkészlet csiszológéphez  
 ES Juego de puntas de pulir



VOREL

No.	pcs / szt.	
25411	17	10/50

EN Polishing covers  
 PL Nakładki polerujące  
 DE Polierscheibe  
 RU Полировочные накладки  
 CZ Leštící kotouč  
 RO Polizor captusit  
 HU Polírozó korong  
 ES Fundas

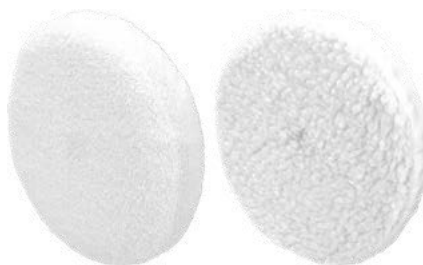

VOREL

No.	Ø [mm]	For / Dla	pcs / szt.	
82941	245	82940	2	10/100

EN Soldering iron stand  
 PL Stojak do lutownicy  
 DE LötKolbenständer  
 RU Подставка для паяльника  
 CZ Stojan na pájku  
 RO Suport pt. ciocan lipit  
 HU Forrasztópáka tartó  
 ES Caballete de soldador



VOREL

No.		
79386		50/100



EN Soldering accessories  
 PL Zestaw narzędzi lutowniczych  
 DE Lötzubehör  
 RU Принадлежности для пайки  
 CZ Pájecí příslušenství  
 RO Accesorii de lipit  
 HU Forrasztó tartozékok  
 ES Jooteseadmed tarvikud

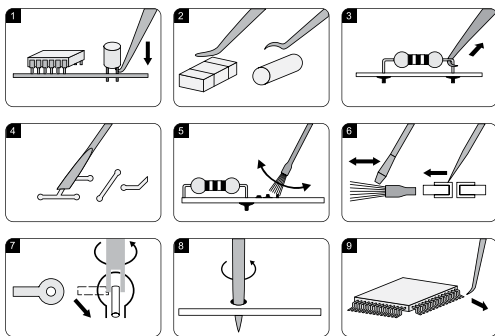
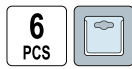

No.	pcs / szt.	Box
79398	6	25/100

EN Solder  
 PL Spoiwo lutownicze  
 DE Lötzin  
 RU Припой  
 CZ Pájka  
 RO Sarna de sudura  
 HU Forrasztó ón  
 ES Estaño plata

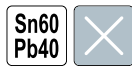

No.	Ø [mm]	m [g]	Box
76830	1	16	25/250

EN Solder stick  
 PL Cyna w lasce  
 DE Stangenlötzin  
 RU Припой  
 CZ Pájka v tyčkách  
 RO Baghete de sudura  
 HU Forrasztó rúd  
 ES Barra estaño plomo



No.	Dimensions / Wymiary [mm]	m [kg]	Box
76832	7x7x322	5	1

EN Solder  
 PL Spoiwo lutownicze  
 DE Lötzin  
 RU Припой  
 CZ Pájka  
 RO Sarna de sudura  
 HU Forrasztó ón  
 ES Estaño plata



No.	Ø [mm]	m [g]	Box
76800	0.5	100	30
76806	0.7	100	30
76807	0.7	250	20
76810	1.0	100	30
76811	1.0	250	20
76814	1.5	100	30
76815	1.5	250	20
76818	2.0	100	30
76819	2.0	250	20
76822	2.5	100	30
76823	2.5	250	20
76826	3.0	100	30

EN Lead free solder  
 PL Spoiwo lutownicze bezolowiowe  
 DE Bleifreier Löttraht  
 RU Бессвинцовый припой  
 CZ Bezolovnaté pájkové pojiwo  
 RO Rola fluidor fara plumb  
 HU Ólommentes forrasztóón  
 ES Estaño para soldar sin plomo



No.	Ø [mm]	m [g]	Box
76850	0.5	100	30
76851	0.7	100	30
76852	1.0	100	30
76853	1.0	250	20
76854	1.5	100	30
76855	1.5	250	20
76856	2.0	100	30
76857	2.0	250	20
76858	2.5	100	30
76859	3.0	100	30

- EN Lead free solder in a phial
- PL Spoiwo lutownicze bezolowiowe fiołka
- DE Bleifreier Lötdraht im Spenderröhrchen
- RU Бессвинцовый припой флакон
- CZ Bezolovnaté pájkové rojivo lahvička
- RO Fludor fara plumb, in tub
- HU Ólommentes forrasztóón fiola
- ES Estaño para soldar sin plomo, en ampolla



No.	Ø [mm]	m [g]	
76870	1.0	14	250

- EN Solder rods without flux
- PL Pręty lutownicze bez topnika
- DE Lötstangen ohne Flussmittel
- RU Паяльные стержни без флюса
- CZ Pájecí tyče bez tavidla
- RO Tije de lipit fără flux
- HU Forrasztórúd gyanta nélkül
- ES Barras de soldadura sin fundente

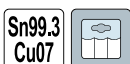

No.	Ø [mm]	m [g]	
76877	0.4	200	30

- EN Solder paste
- PL Pasta lutownicza
- DE Lotpaste
- RU Паяльная паста
- CZ Pájecí pasty
- RO Pasta decapante sudura
- HU Forrasztó paszta
- ES Pasta de soldar



No.	m [g]	
76835	40	50

- EN Desoldering pump
- PL Odsysacz do cyny
- DE Entlötsaugpumpe
- RU Шприц для удаления припоя
- CZ Odrájecí sací pumpy
- RO Pompa fludor
- HU Ónszippantó
- ES Bomba desoldadora



No.	
79390	100/400

- EN Soft solder
- PL Spoiwo do instalacji miedzianych
- DE Lötdraht für Kupferinstallationen
- RU Припой для медных установок
- CZ Rojivo pro měděné instalace
- RO Fludor moale
- HU Forrasztóón rézhéz
- ES Aglutinante para instalaciones de cobre

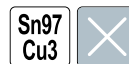

No.	Ø [mm]	m [g]	
76880	1.5	100	60
76881	2.0	100	60
76882	2.0	250	50
76883	2.5	100	60
76884	2.5	250	50

- EN Rosin
- PL Kalafonia lutownicza
- DE Kolophonium
- RU Канифоль
- CZ Kalafuna
- RO Colofoniu
- HU Forrasztó gyanta
- ES Colofonia



No.	m [g]	
76836	45	50

- EN Desoldering pump
- PL Odsysacz do cyny
- DE Entlötsaugpumpe
- RU Шприц для удаления припоя
- CZ Odrájecí sací pumpy
- RO Pompa fludor
- HU Ónszippantó
- ES Bomba desoldadora



No.	
79391	70/140

EN Pumping hose for motor pumps with terminals  
 PL Wąż tłoczny do motopomp z końcówkami  
 DE Druckschlauch für Motorpumpen mit Anschlussstücken  
 RU Напорный рукав для моторопп с наконечниками  
 CZ Výtlačná hadice s koncovkami pro motorová čerpadla  
 RO Furtun pt. motorpompe cu capete  
 HU Szivattyú nyomótömlő kapcsokkal szerelve  
 ES Manguera para bombear para motobombas con terminales



No.	L [m]	Ø	Max. operating pressure / Maks. ciśnienie robocze [bar]	Bursting pressure / Ciśnienie rozrywające [bar]	
79977	20	2" (50.0 mm)	6	24	1
79978	20	3" (75.0 mm)	6	24	1
79979	20	4" (100.0 mm)	6	24	1

EN Suction hose  
 PL Wąż ssawny do pomp  
 DE Saugschlauch für Pumpen  
 RU Всасывающий шланг для насосов  
 CZ Sací hadice do čerpadel  
 RO Furtun aspiratie  
 HU Szivattyútömlő  
 ES Manguera de succión para bomba



No.	L [m]	Water outlet diameter / Średnica przyłącza wody	
79823	5	1" (25.0 mm)	6
79824	7	1" (25.0 mm)	4

EN Pumping hose for motor pumps  
 PL Wąż tłoczny do motopomp  
 DE Druckschlauch für Motorpumpen  
 RU Напорный рукав для моторопп  
 CZ Výtlačná hadice pro motorová čerpadla  
 RO Furtun pt. motorpompe  
 HU Szivattyú nyomótömlő  
 ES Manguera para bombear para motobombas



No.	L [m]	Ø	Max. operating pressure / Maks. ciśnienie robocze [bar]	Bursting pressure / Ciśnienie rozrywające [bar]	
79982	50	1" (25.0 mm)	2	6	1
79983	50	2" (50.0 mm)	2	6	1
79984	50	3" (75.0 mm)	2	6	1

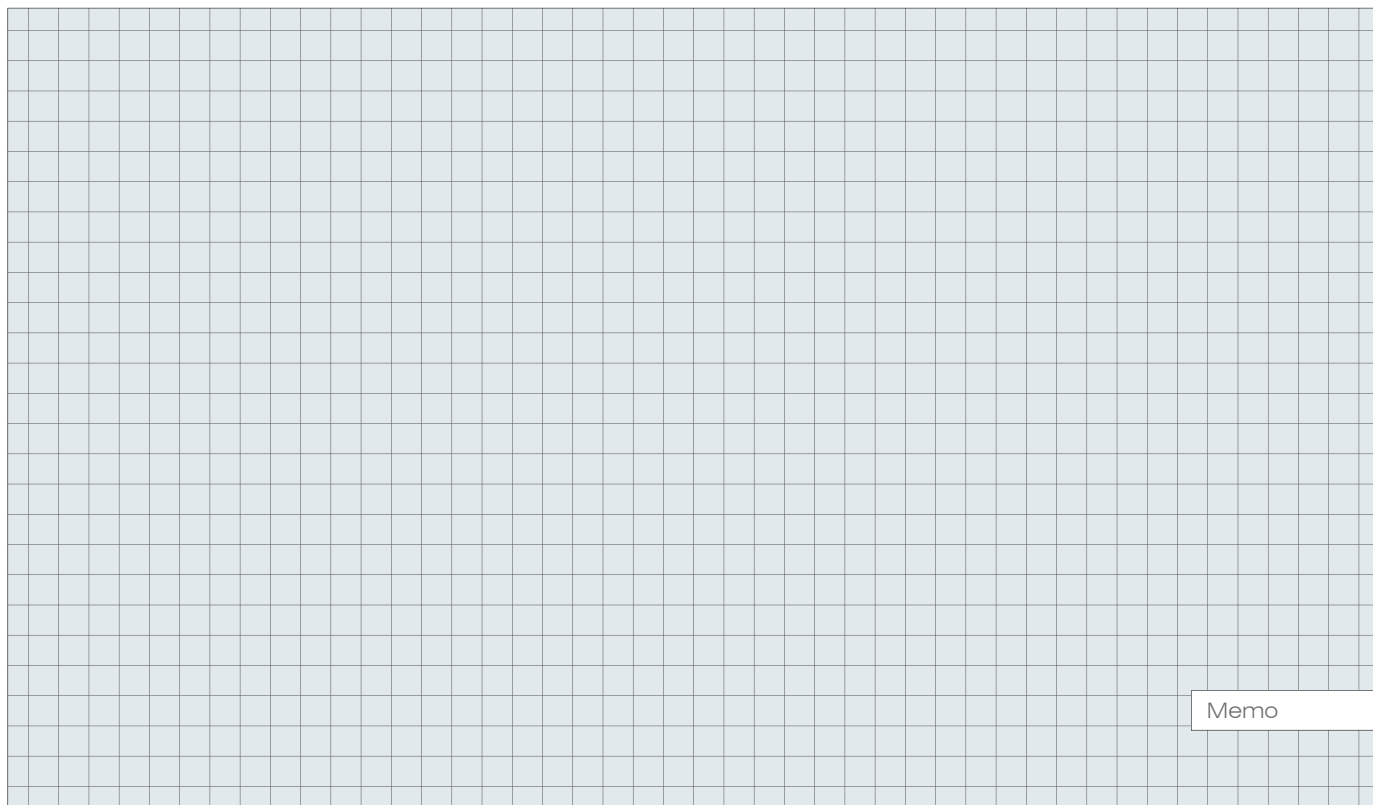



# 16

## Welding equipment Sprzęt spawalniczy





**Welding accessories**  
**Akcesoria spawalnicze**

.....276-278

**Clamps**

Zaciski spawalnicze..... 276

**Welding goggles & masks**

Okulary i maski spawalnicze..... 276

- EN Clamp
- PL Zacisk spawalniczy biegunowo-kleszczowy
- DE Schweisseklemme
- RU Клещи для сварки
- CZ Kleště svářečské zemníci
- RO Cleste pt. sudura
- HU Testkábel-csatlakozó
- ES Cocodrilo para soldar



No.	Max. welding current / Maks. prąd spawania [A]	Earthing cable diameter / Średnica przewodu masowego [mm]	Max. jaws range / Maks. rozwarcie szczęk [mm]	m [kg]	Type / Typ	
74420	160	35	50	0.21	ZBK-35	25
74421	315	70	60	0.25	ZBK-70	25
74422	520	95	70	0.29	ZBK-95	25

- EN Welding goggles
- PL Okulary spawalnicze
- DE Schweisserbrille
- RU Очки газосварщика
- CZ Brýle svářečské
- RO Ochelari pt. sudura
- HU Hegesztőszeműveg
- ES Gafas para soldar



16

No.	
74410	5/100

- EN Welding mask
- PL Maska spawalnicza
- DE Schweissermaske
- RU Щиток сварщика
- CZ Svářečská maska
- RO Mască de sudură
- HU Hegesztőpajzs
- ES Mascara de soldador



No.	Type / Typ	
74440	TSM-3	30

- EN Electrode holder
- PL Uchwyt spawalniczy elektrodowy
- DE Schweisselektrodenriff
- RU Клещи для сварки (электродные)
- CZ Držák elektrod
- RO Cleste pt. sudura cu electrod
- HU Elektrodafogó
- ES Abrazadera para soldar, de electrodos



No.	Max. welding current / Maks. prąd spawania [A]	Welding electrode clamping range / Zakres zaciskanych elektrod [mm]	Welding cable cross section / Przekrój przewodu spawalniczego [mm <sup>2</sup> ]	m [kg]	Type / Typ	
74430	200 (X=60%) / 315 (X=35%)	2-5	35-50	0.32	UE-200	25
74431	315 (X=60%) / 400 (X=35%)	2.5-6.3	50-70	0.42	UE-300	25
74432	430 (X=60%) / 530 (X=35%)	3.5-6.3	70-95	0.5	UE-400	25

- EN Welding goggles
- PL Okulary spawalnicze
- DE Schweisserbrille
- RU Очки газосварщика
- CZ Brýle svářečské
- RO Ochelari pt. sudura
- HU Hegesztőszeműveg
- ES Gafas para soldar



No.	
74411	10/100

- EN Welding mask
- PL Maska spawalnicza
- DE Schweissermaske
- RU Щиток сварщика
- CZ Svářečská maska
- RO Mască de sudură
- HU Hegesztőpajzs
- ES Mascara de soldador



No.	Type / Typ	
74442	TSM	30

EN Welding mask  
 PL Przyłbica spawalnicza z podglądem  
 DE Schweissermaske  
 RU Щиток сварщика с подсмотром  
 CZ Svářečská přilba s nakoukáváním  
 RO Mască de sudură cu geam  
 HU Hegesztősisak kitekintővel  
 ES Mascara de soldador con mirador



No.	Type / Typ	
74443	TSPM	20

EN Welding mask  
 PL Przyłbica spawalnicza z podglądem  
 DE Schweissermaske  
 RU Щиток сварщика с подсмотром  
 CZ Svářečská přilba s nakoukáváním  
 RO Mască de sudură cu geam  
 HU Hegesztősisak kitekintővel  
 ES Mascara de soldador con mirador

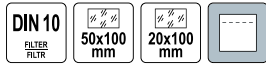

No.	Type / Typ	
74447	PSMP	20

EN Welding mask  
 PL Przyłbica spawalnicza  
 DE Schweissermaske  
 RU Щиток сварщика  
 CZ Svářečská přilba  
 RO Mască de sudură  
 HU Hegesztőpajzs  
 ES Mascara de soldador



**VOREL**

No.	
74457	20

EN Welding mask  
 PL Maska spawalnicza  
 DE Schweissermaske  
 RU Щиток сварщика  
 CZ Svářečská maska  
 RO Mască de sudură  
 HU Hegesztőpajzs  
 ES Mascara de soldador



No.	Type / Typ	
74450	TSD-3	18

EN Welding mask  
 PL Maska spawalnicza  
 DE Schweissermaske  
 RU Щиток сварщика  
 CZ Svářečská maska  
 RO Mască de sudură  
 HU Hegesztőpajzs  
 ES Mascara de soldador



**VOREL**

No.	
74441	20

EN Auto-darkening welding helmet  
 PL Przyłbica spawalnicza samościemniająca  
 DE Schweissmaske, selbstverdunkelnd  
 RU Маска сварщика с автотемнением  
 CZ Svářečská kukla samostmívací  
 RO Mască de sudură auto-întunecare  
 HU Őnmagától sötétedő hegesztőpajzs  
 ES Casco auto-oscurecedor para soldadura

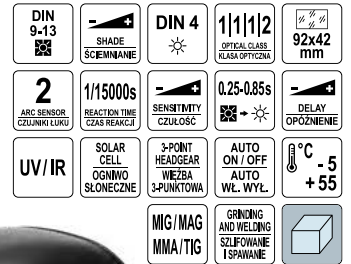

**STHOR**

No.	
74480	6

EN Auto-darkening welding helmet  
 PL Przyłbica spawalnicza samościemniająca  
 DE Schweissmaske, selbstverdunkelnd  
 RU Маска сварщика с автозатемнением  
 CZ Svářečská kukla samostmívací  
 RO Mască de sudură auto-întunecare  
 HU Őnmagától sötétedő hegesztőpajzs  
 ES Casco auto-oscurecedor para soldadura

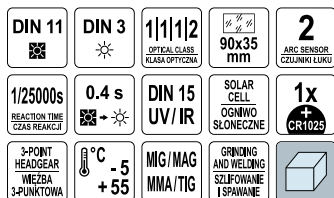

**STHOR**

No.		
74483		6

EN Filter shield  
 PL Oslona filtra  
 DE Filterabdeckung  
 RU Кожух фильтра  
 CZ Ochrana filtru  
 RO Aparatoare de filtru  
 HU Szűrőfedél  
 ES Protección de filtro



No.	Filter size / Rozmiar filtra [mm]	Dark state / Stan ciemny [DIN]	
74451	50x100	0	100

EN Self-dimming helmet filter protection  
 PL Oslona filtra przyłbicy samościemniającej  
 DE Filtereinsatz eines selbstabdunkelnden Schutzhelms  
 RU Кожух фильтра самозатемняющегося шлица  
 CZ Ochranná folie filtru samostmívací kukly  
 RO Carcasă filtru vizieră heliomată  
 HU Hegesztőpajzs szűrő, őnsötétedő  
 ES Protección del filtro de visera autooscurecedora



No.	Filter size / Rozmiar filtra [mm]	pcs / szt.	
74439	90x110	5	20

EN Auto-darkening welding helmet  
 PL Przyłbica spawalnicza samościemniająca  
 DE Schweissmaske, selbstverdunkelnd  
 RU Маска сварщика с автозатемнением  
 CZ Svářečská kukla samostmívací  
 RO Mască de sudură auto-întunecare  
 HU Őnmagától sötétedő hegesztőpajzs  
 ES Casco auto-oscurecedor para soldadura

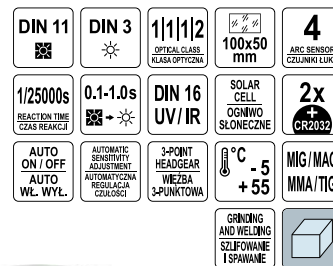

**STHOR**

No.		
74484		6

EN Welding filter  
 PL Filtr spawalniczy  
 DE Vorsatzglas  
 RU Фильтр для сварки  
 CZ Filtr svářečský  
 RO Filtru pt. sudări  
 HU Hegesztőszűrő  
 ES Pantalla de filtro de soldador



No.	Filter size / Rozmiar filtra [mm]	Dark state / Stan ciemny [DIN]	
74452	50x100	8	100
74453	50x100	9	100
74454	50x100	10	100
74455	50x100	11	100





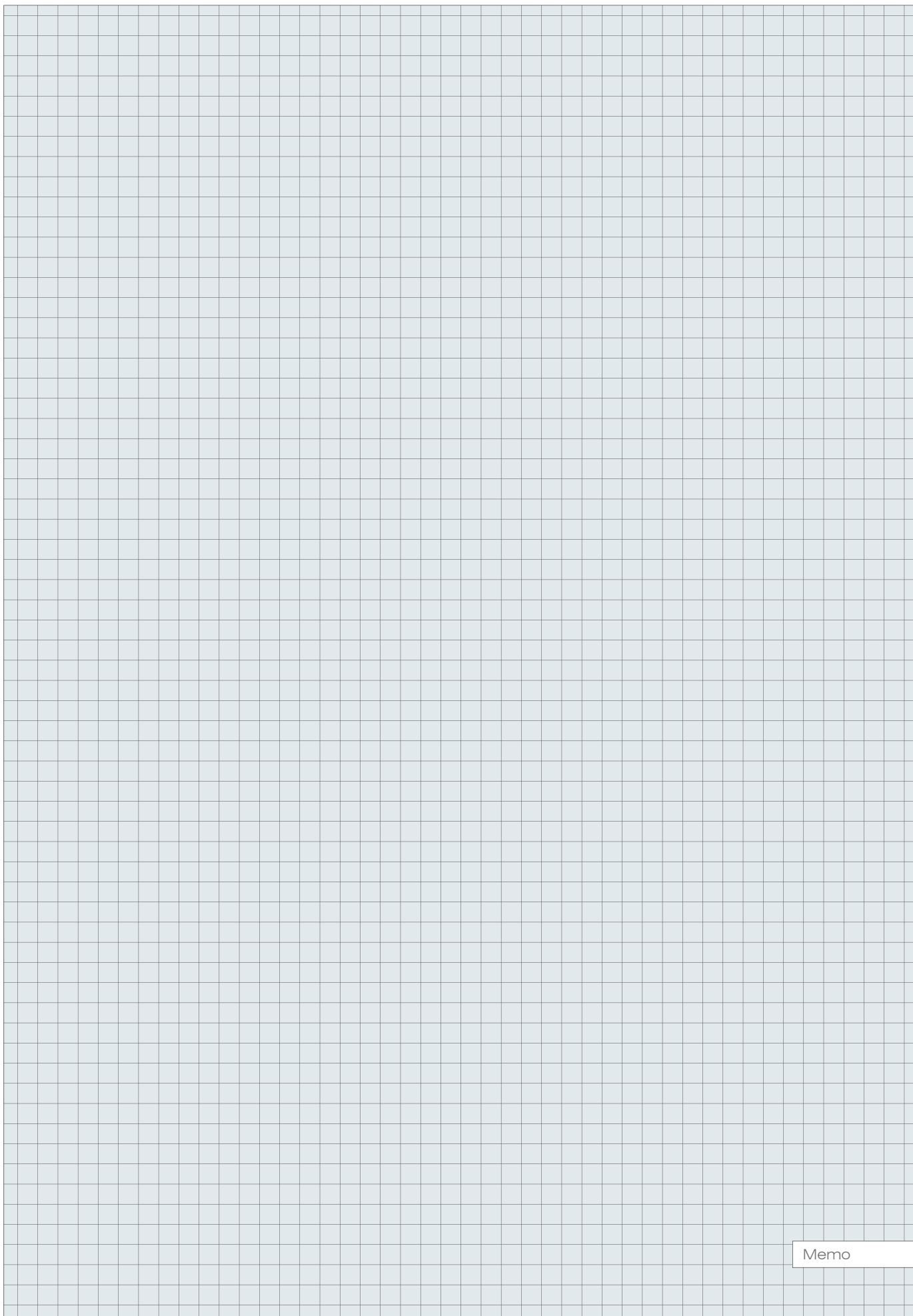

Memo

# 17

## Safes, padlocks & locks Sejfy, klódki i zamki



**Safes**  
Sejfy

.....282

**Key boxes**  
Skrzynki na klucze

.....282

**Cash boxes**  
Kasetki na pieniądze

.....282-283

**Padlocks**  
Kłódki

.....283-285

**Cast iron padlocks**

Kłódki żeliwne

.....283

**Brass padlocks**

Kłódki mosiężne

.....284

**Steel padlocks**

Kłódki stalowe

.....284

**Lock cylinders & bodies**  
Wkładki do zamków i zamki

.....285-286

**Brass lock cylinders**

Wkładki mosiężne

.....285

**Safety chains**

Łańcuchy do drzwi

.....286

EN Safe with digital lock  
 PL Sejf z zamkiem cyfrowym  
 DE Seif mit Digitalschloss  
 RU Сейф с электронным замком

CZ Pancéřová pokladna z digitálním zámkem  
 RO Seif cu broasca cu cifru  
 HU Számszáras széf  
 ES Caja de seguridad con cerradura digital

350x250  
x250  
mm

4x  
AA



No.	Dimensions / Wymiary [mm]	
78641	350x250x250	1

EN Key box  
 PL Skrzynka na klucze  
 DE Schlüsselkasten  
 RU Ящик для ключей  
 CZ Skříňka na klíče  
 RO Cutie pt. chei  
 HU Kulcstartó doboz  
 ES Caja para llaves

200x160  
x78  
mm

2x

x15  
HOOKS  
HAKI



No.	Dimensions / Wymiary [mm]	
78432	200x160x78	20

EN Key box  
 PL Skrzynka na klucze  
 DE Schlüsselkasten  
 RU Ящик для ключей  
 CZ Skříňka na klíče  
 RO Cutie pt. chei  
 HU Kulcstartó doboz  
 ES Caja para llaves

450x380  
x80  
mm

2x

x80  
HOOKS  
HAKI



No.	Dimensions / Wymiary [mm]	
78436	450x380x80	5

EN Cash box  
 PL Kasetka na pieniądze  
 DE Geldkassette  
 RU Ящик для денег  
 CZ Kазeta na peníze  
 RO Casetă (cutie) pt. bani  
 HU Pénzes kasszeta  
 ES Caja para efectivo

200x160  
x90  
mm

2x



No.	Dimensions / Wymiary [mm]	Color / Kolor	
78622	200x160x90	czarny	10

EN Safe with digital lock  
 PL Sejf z zamkiem cyfrowym  
 DE Seif mit Digitalschloss  
 RU Сейф с электронным замком

CZ Pancéřová pokladna z digitálním zámkem  
 RO Seif cu broasca cu cifru  
 HU Számszáras széf  
 ES Caja de seguridad con cerradura digital

310x200  
x200  
mm

4x  
AA



No.	Dimensions / Wymiary [mm]	
78642	310x200x200	1

EN Key box  
 PL Skrzynka na klucze  
 DE Schlüsselkasten  
 RU Ящик для ключей  
 CZ Skříňka na klíče  
 RO Cutie pt. chei  
 HU Kulcstartó doboz  
 ES Caja para llaves

250x180  
x80  
mm

2x

x48  
HOOKS  
HAKI



No.	Dimensions / Wymiary [mm]	
78434	250x180x80	10

EN Cash box  
 PL Kasetka na pieniądze  
 DE Geldkassette  
 RU Ящик для денег  
 CZ Kазeta na peníze  
 RO Casetă (cutie) pt. bani  
 HU Pénzes kasszeta  
 ES Caja para efectivo

150x120  
x80  
mm

2x



No.	Dimensions / Wymiary [mm]	Color / Kolor	
78620	150x120x80	czarny	20

EN Cash box  
 PL Kasetka na pieniądze  
 DE Geldkassette  
 RU Ящик для денег  
 CZ Kазeta na peníze  
 RO Casetă (cutie) pt. bani  
 HU Pénzes kasszeta  
 ES Caja para efectivo

200x160  
x90  
mm

CODE  
SZYFR



No.	Dimensions / Wymiary [mm]	Color / Kolor	
78624	200x160x90	czarny	10



EN Cash box  
 PL Kasetka na pieniądze  
 DE Geldkassette  
 RU Ящик для денег  
 CZ Kasetka na peníze  
 RO Casetă (cutie) pt. bani  
 HU Pénzes kasszeta  
 ES Caja para efectivo

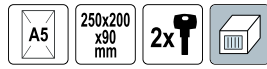

No.	Dimensions / Wymiary [mm]	Color / Kolor	
78626	250x200x90	czarny	10

EN Cash box  
 PL Kasetka na pieniądze  
 DE Geldkassette  
 RU Ящик для денег  
 CZ Kasetka na peníze  
 RO Casetă (cutie) pt. bani  
 HU Pénzes kasszeta  
 ES Caja para efectivo

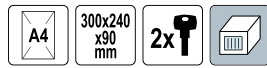

No.	Dimensions / Wymiary [mm]	Color / Kolor	
78630	300x240x90	czarny	10

EN Iron padlock  
 PL Kłódka żelwna  
 DE Vorhängeschloss  
 RU Замок навесной  
 CZ Stavební visací zámek  
 RO Lacăt pt. construcții  
 HU Óriás lakat  
 ES Candado de hierro fundido



No.	Size / Rozmiar [mm]	
77061	32	12/120
77062	38	12/120
77063	50	6/60
77064	63	6/36

EN Cash box  
 PL Kasetka na pieniądze  
 DE Geldkassette  
 RU Ящик для денег  
 CZ Kasetka na peníze  
 RO Casetă (cutie) pt. bani  
 HU Pénzes kasszeta  
 ES Caja para efectivo

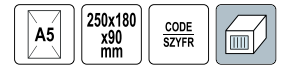

No.	Dimensions / Wymiary [mm]	Color / Kolor	
78628	250x180x90	czarny	10

EN Cash box  
 PL Kasetka na pieniądze  
 DE Geldkassette  
 RU Ящик для денег  
 CZ Kasetka na peníze  
 RO Casetă (cutie) pt. bani  
 HU Pénzes kasszeta  
 ES Caja para efectivo

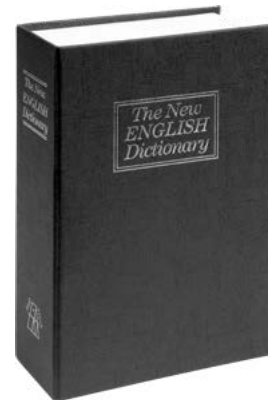

No.	Dimensions / Wymiary [mm]	Color / Kolor	
78632	180x115x55	czarny	24
78633	240x155x55	czarny	20

EN Alloy covered iron padlock  
 PL Kłódka żelwna powlekana  
 DE Vorhängeschloss  
 RU Замок навесной  
 CZ Stavební visací zámek  
 RO Lacăt pt. construcții  
 HU Óriás lakat  
 ES Candado de hierro fundido



No.	Size / Rozmiar [mm]	
77004	40	12/96
77005	50	12/72
77006	60	12/48

- EN Rectangular brass padlock
- PL Klódka trzpieniowa
- DE Messigvorhängeschloss
- RU Стержневой навесной замок латунный
- CZ Visací zámek setržený
- RO Lacăt din alamă cu belciug drept
- HU Réz hengerzáras u lakat
- ES Candado de latón de mandril



No.	Size / Rozmiar [mm]	
77210	50	6/120
77211	65	6/96
77212	75	6/60
77213	90	6/36

- EN Combination padlock
- PL Klódka szyfrowa
- DE Vorhängezahlschloss
- RU Замок навесной кодовый
- CZ Visací zámek s číselným kódem
- RO Lacăt alama cu cifru
- HU Számszáras lakat
- ES Candado combinación

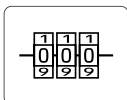

No.	Size / Rozmiar [mm]	
77606	25	12/120

17

- EN Combination padlock
- PL Klódka szyfrowa
- DE Vorhängezahlschloss
- RU Замок навесной кодовый
- CZ Visací zámek s číselným kódem
- RO Lacăt alama cu cifru
- HU Számszáras lakat
- ES Candado combinación

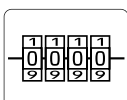

No.	Size / Rozmiar [mm]	
77608	40	12/120

- EN Plated brass padlock
- PL Klódka mosiężna
- DE Vorhängeschloss
- RU Замок навесной латунный
- CZ Zámek visací mosazný
- RO Lacăt alama
- HU Lakat sárgaréz
- ES Candado de latón



No.	Size / Rozmiar [mm]	
77250	25	12/600
77300	30	12/480
77350	35	12/300
77400	40	12/240
77500	50	12/144
77600	60	12/144

- EN Combination padlock
- PL Klódka szyfrowa
- DE Vorhängezahlschloss
- RU Замок навесной кодовый
- CZ Visací zámek s číselným kódem
- RO Lacăt alama cu cifru
- HU Számszáras lakat
- ES Candado combinación

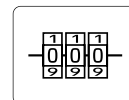

No.	
77607	12/120

- EN Combination padlock
- PL Klódka szyfrowa
- DE Vorhängezahlschloss
- RU Замок навесной кодовый
- CZ Visací zámek s číselným kódem
- RO Lacăt alama cu cifru
- HU Számszáras lakat
- ES Candado combinación

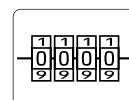

No.	Size / Rozmiar [mm]	
77609	50	6/48

EN Combination padlock  
 PL Kłódka szyfrowa  
 DE Vorhängeschloss  
 RU Замок навесной кодовый  
 CZ Visací zámek s číselným kódem  
 RO Lacat alama cu cifru  
 HU Számszáras lakat  
 ES Candado combinación

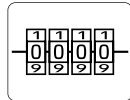

**VOREL**

No.	Size / Rozmiar [mm]	
77612	50	6/48

EN Plated brass padlock  
 PL Kłódka mosiężna  
 DE Vorhängeschloss  
 RU Замок навесной латунный  
 CZ Zámek visací mosazný  
 RO Lacat alama  
 HU Lakat sárgaréz  
 ES Candado de latón



No.	Size / Rozmiar [mm]	
77700	40x105	12/240

EN Wire safety padlock with nylon isolation  
 PL Kłódka powlekana nylonem z linką  
 DE Vorhängeschloss nylonbeschichtet mit Seil  
 RU Навесной замок с нейлоновым покрытием и тросиком  
 CZ Visací zámek potažený nylonem s lanem  
 RO Lacat de siguranță cu fir cu izolație din nailon  
 HU Nylon burkolatú huzalos lakat  
 ES Candado revestido con nailon y cable



**VOREL**

No.		
77100		10/100

EN Aluminium safety lock out hasp  
 PL Aluminiowa blokada klamrowa  
 DE Multi-Schließklammer aus Aluminium  
 RU Алюминиевый замок-скоба  
 CZ Sponková blokáda hliníková  
 RO Siguranta blocare, Al  
 HU Alumínium lakatható csatos zár  
 ES Aldaba de seguridad de aluminio

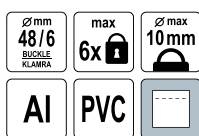

**VOREL**

No.		
77704		10/200

EN Combination padlock  
 PL Kłódka szyfrowa  
 DE Vorhängeschloss  
 RU Замок навесной кодовый  
 CZ Visací zámek s číselným kódem  
 RO Lacat alama cu cifru  
 HU Számszáras lakat  
 ES Candado combinación

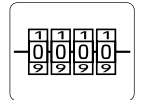

**VOREL**

No.	Size / Rozmiar [mm]	
77618	50	6/48

EN Safety padlock with nylon isolated body  
 PL Kłódka specjalna z korpusem zabezpieczonym tworzywem  
 DE Spezielles Vorhängeschloss, Körper mit Kunststoff gesichert  
 RU Специальный навесной замок с пластиковой защитой  
 CZ Speciální visací zámek, tělo zajištěno plastem  
 RO Lacat de siguranță cu corp izolat din nailon  
 HU Speciális lakat műanyaggal védett ház  
 ES Candado especial cuerpo, protegido con plástico



**VOREL**

No.		
77100		10/100

EN Steel safety lock out hasp  
 PL Stalowa blokada klamrowa  
 DE Multi-Schließklammer aus Stahl  
 RU Стальной замок-скоба  
 CZ Svrková blokáda ocelová  
 RO Siguranta blocare, oțel  
 HU Acél lakatható csatos zár  
 ES Aldaba de seguridad de acero



**VOREL**

No.		
77705		10/200

EN Lock cylinder  
 PL Wkładka do zamka  
 DE Schliesszylinder  
 RU Личинка замка латунная

CZ Vložka na zámek  
 RO Yalá pt. broască  
 HU Zárbetét  
 ES Inserción cromada



**VOREL**

No.	L [mm]	Size / Rozmiar [mm]	Key quantity / Liczba kluczy	
77200	62	31/31	3	12/72
77203	72	31/41	3	12/72
77204	67	31/36	3	12/72
77205	87	36/51	3	12/72

EN Lock cylinder  
 PL Wkładka do zamka chromowana  
 DE Schliesszylinder  
 RU Личинка замка  
 CZ Vložka na zámek  
 RO Yalá pt. broască  
 HU Zárbetét  
 ES Inserción cromado



No.	L [mm]	Size / Rozmiar [mm]	Key quantity / Liczba kluczy	
77170	62	31/31	3	12/72

EN Lock cylinder  
 PL Wkładka do zamka chromowana  
 DE Schliesszylinder  
 RU Личинка замка  
 CZ Vložka na zámek  
 RO Yalá pt. broască  
 HU Zárbetét  
 ES Inserción cromado



No.	L [mm]	Size / Rozmiar [mm]	Key quantity / Liczba kluczy	
77180	62	31/31	6	12/72

EN Safety chain  
 PL Łańcuch do drzwi  
 DE Türsicherungskette  
 RU Замок-цепь для двери

CZ Řetěz na dveře  
 RO Lanț pt. ușă  
 HU Ajtólánc  
 ES Cadena para puerta



No.		
77910		12/120

EN Lock cylinder  
 PL Wkładka do zamka  
 DE Schliesszylinder  
 RU Личинка замка латунная  
 CZ Vložka na zámek  
 RO Yalá pt. broască  
 HU Zárbetét  
 ES Inserción cromado



No.	L [mm]	Size / Rozmiar [mm]	Key quantity / Liczba kluczy	
77190	62	31/31	6	12/72
77191	67	31/36	6	12/72
77192	72	31/41	6	12/72
77193	87	36/51	6	12/72

EN Safety chain  
 PL Łańcuch do drzwi  
 DE Türsicherungskette  
 RU Замок-цепь для двери

CZ Řetěz na dveře  
 RO Lanț pt. ușă  
 HU Ajtólánc  
 ES Cadena para puerta



No.	
77900	12/120

EN Key holders  
 PL Zawieszki plastikowe do kluczy  
 DE Schlüsselanhänger  
 RU Брелок для ключей  
 CZ Přívěšek na klíče  
 RO Breloc  
 HU Kulcstartó  
 ES Llaveros de plástico



No.	pcs / szt.	
77930	12	12/120

Memo



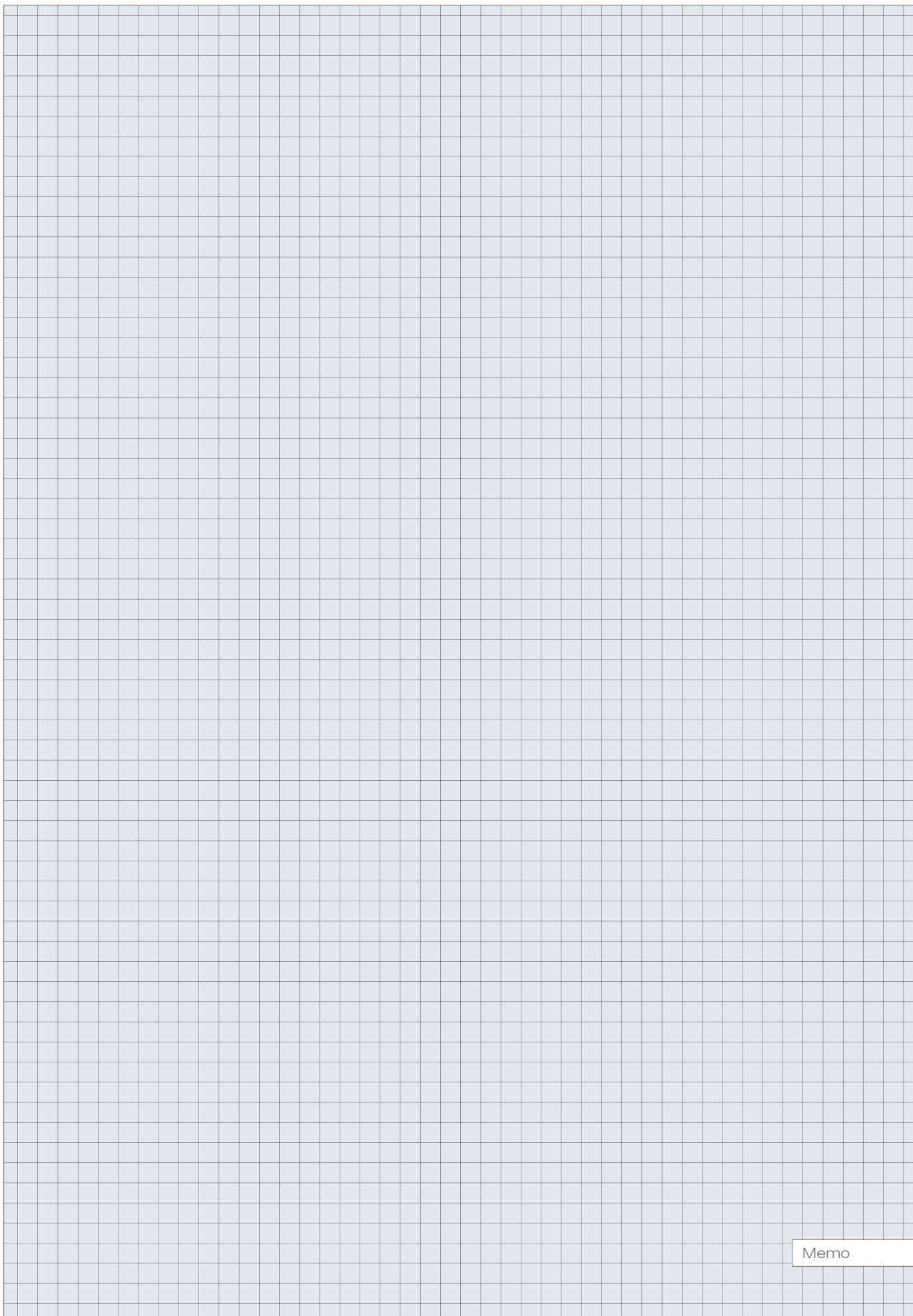





Memo



# 18

## Accessories Akcesoria

<b>Tool belts</b> Pasy na narzędzia	
.....290	
<b>Tool bags</b> Torby narzędziowe	
.....290	
<b>Trolley tool boxes</b> Wózki narzędziowe	
.....290-291	
<b>Tool boxes</b> Skrzynki narzędziowe	
.....291-293	

EN Tool belt with fixed bags  
 PL Pas narzędziowy z naszytymi torbami  
 DE Werkzeuggürtel mit Taschen  
 RU Пояс для инструментов с карманами  
 CZ Opasek na nářadí s taškami  
 RO Centura de scule cu pungii fixe  
 HU Szerszám öv táská  
 ES Cinturón para herramientas con bolsas



No.		
78751		24

EN Tool belt  
 PL Pas narzędziowy  
 DE Werkzeuggürtel  
 RU Инструмент пояса  
 CZ Opasek s nářadím  
 RO Centura scule  
 HU Szerszám öv  
 ES Cinturón para herramientas

No.		
78750		50

EN Tool bag  
 PL Torba narzędziowa  
 DE Werkzeugtasche  
 RU Сумка для инструмента  
 CZ Taška montéřská  
 RO Geanta pt. scule  
 HU Szerszámás táská  
 ES Bolso de herramientas



No.	Dimensions / Wymiary [mm]	
78720	430x285x170	2

EN Tool bag  
 PL Torba narzędziowa  
 DE Werkzeugtasche  
 RU Сумка для инструмента  
 CZ Taška montéřská  
 RO Geanta pt. scule  
 HU Szerszámás táská  
 ES Bolso de herramientas



No.	Dimensions / Wymiary [mm]	
78730	400x260x140	2

EN Tool belt with sliding bags  
 PL Pas narzędziowy stolarski z przesuwanymi torbami  
 DE Werkzeuggürtel mit Taschen  
 RU Пояс для инструментов со сменными карманами  
 CZ Opasek na nářadí s taškami  
 RO Centura de scule cu pungii glisante  
 HU Szerszám öv táská  
 ES Cinturón para herramientas con bolsas



No.		
78752		24



EN Trolley toolbox, 2 segments  
 PL Wózek narzędziowy 2-segmentowy  
 DE Werkzeugtrolley 2-Teilig  
 RU Мешок для инструментов 2 секции  
 CZ Vozík na nářadí 2 segmenty  
 RO Troler pt. scule 2 segmente  
 HU Kerekes szerszámosláda 2 részés  
 ES Carro de herramientas 2 compartimentos



No.		
78731		1



EN Trolley toolbox, 2 segments  
 PL Wózek narzędziowy z wyjmowanym organizerem  
 DE Werkzeugtrolley mit abnehmbarem Organisaufsatz  
 RU Мешок для инструментов с вынимаемым органайзером  
 CZ Vozík na nářadí s odnímatelným organizérem  
 RO Troler pt. scule 2 segmente  
 HU Kerekesszerszámosláda kivehető szervezővel  
 ES Carro de herramientas con organizador extraíble



No.	78734	1
-----	-------	---

EN Trolley toolbox, 3 segments  
 PL Wózek narzędziowy 3-segmentowy  
 DE Werkzeugtrolley 3-Teilig  
 RU Мешок для инструментов 3 секции  
 CZ Vozík na nářadí 3 segmenty  
 RO Troler pt. scule 3 segmente  
 HU Kerekesszerszámosláda 3 részes  
 ES Carro de herramientas 3 compartimentos



No.	78738	1
-----	-------	---

EN Trolley toolbox, 3 segments  
 PL Wózek narzędziowy 3-segmentowy  
 DE Werkzeugtrolley 3-Teilig  
 RU Мешок для инструментов 3 секции  
 CZ Vozík na nářadí 3 segmenty  
 RO Troler pt. scule 3 segmente  
 HU Kerekesszerszámosláda 3 részes  
 ES Carro de herramientas 3 compartimentos



No.	78736	1
-----	-------	---

EN Toolbox  
 PL Skrzynka narzędziowa  
 DE Werkzeugkoffer  
 RU Ящик для инструментов

CZ Skříňka na nářadí  
 RO Cutie pt. scule  
 HU Szerszámosláda  
 ES Caja de herramientas



No.	Size / Rozmiar	Dimensions / Wymiary [mm]	1
78801	12" (300 mm)	312x167x130	1
78800	16" (400 mm)	415x226x200	1

EN Toolbox  
 PL Skrzynka narzędziowa  
 DE Werkzeugkoffer  
 RU Ящик для инструментов  
 CZ Skříňka na nářadí  
 RO Cutie pt. scule  
 HU Szerszámosláda  
 ES Caja de herramientas



**VOREL**

No.	Size / Rozmiar	Dimensions / Wymiary [mm]	
78802	20" (500 mm)	525x256x246	1

EN Toolbox  
 PL Skrzynka narzędziowa  
 DE Werkzeugkoffer  
 RU Ящик для инструментов  
 CZ Skříňka na nářadí  
 RO Cutie pt. scule  
 HU Szerszámosláda  
 ES Caja de herramientas



**VOREL**

No.	Size / Rozmiar	Dimensions / Wymiary [mm]	Load capacity / Nośność [kg]	
78814	20" (500 mm)	525x256x325	25+3	1

18

EN Storage bin cabinet  
 PL Organizer modułowy  
 DE Werkstatt-Schubladenwandregal  
 RU Модульный органайзер  
 CZ Box na nářadí s přihrádkami  
 RO Dulap cu organizatoare pt. scule  
 HU Moduláris szervező  
 ES Organizador modular



**VOREL**

No.	Dimensions / Wymiary [mm]	Compartment quantity / Liczba przegródek	
78780	475x380x160	39 (9x duża, 30x mała)	4

EN Toolbox  
 PL Skrzynka narzędziowa  
 DE Werkzeugkoffer  
 RU Ящик для инструментов  
 CZ Skříňka na nářadí  
 RO Cutie pt. scule  
 HU Szerszámosláda  
 ES Caja de herramientas



**VOREL**

No.	Size / Rozmiar	Dimensions / Wymiary [mm]	
78811	12" (300 mm)	312x167x130	1
78812	16" (400 mm)	415x226x200	1
78813	20" (500 mm)	525x256x246	1
78815	26" (650 mm)	595x337x316	1

EN Tool organiser with storage case  
 PL Tablica narzędziowa z pojemnikami  
 DE Werkzeugtafel mit Behältern  
 RU Таблица для инструментов с контейнерами  
 CZ Organizér na nářadí s krabičkami  
 RO Organizator + cutie depozitare scule  
 HU Szerszámtartó fal tartályokkal  
 ES Tablero de herramientas con recipientes



**VOREL**

No.	Compartment dimensions / Wymiary modulu [mm]	pcs / szt.	
78771	475x272x15	48	1

EN Organizer set  
 PL Zestaw organizerów  
 DE Organizer-Set  
 RU Набор органайзеров  
 CZ Organizéry na nářadí  
 RO Organizator scule  
 HU Szerszámtartó láda készlet  
 ES Juego de organizadores

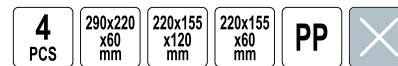

**VOREL**

No.	Dimensions / Wymiary [mm]	pcs / szt.	
78788	290x220x60, 220x155x120, 220x155x60	4	8

EN Workshop drawers  
 PL Szufiadki warsztatowe  
 DE Werkstattd Schubfächer  
 RU Шкафы для инструментов  
 CZ Skříňka se zásobníky  
 RO Sertare atelier  
 HU Műhely zsámoly fiókkal  
 ES Cajones para taller



225x155  
x100  
mm



No.	Dimensions / Wymiary [mm]	Compartment quantity / Liczba przegródek	
78785	225x155x100	10	20

EN Organizer  
 PL Organizer  
 DE Werkzeugkaste  
 RU Органайзер  
 CZ Organízér  
 RO Cutie tip organizator  
 HU Csavartartó doboz  
 ES Caja



300x220  
x55  
mm



No.	Dimensions / Wymiary [mm]	Compartment quantity / Liczba przegródek	
78791	300x220x55	10	10

EN Organizer  
 PL Organizer  
 DE Werkzeugkaste  
 RU Органайзер  
 CZ Organízér  
 RO Cutie tip organizator  
 HU Csavartartó doboz  
 ES Caja



460x320  
mm



No.	Dimensions / Wymiary [mm]	
78819	460x320	5

EN Storage case  
 PL Pojemnik magazynowy  
 DE Lagersichtbox  
 RU Ящик для склада

CZ Box skladovací  
 RO Cutie scule diverse  
 HU Tárolók  
 ES Contenedeor de almacén



No.	Dimensions / Wymiary [mm]	Type / Typ	
78830	116x112x75	XS	270
78831	116x161x75	S	190
78833	170x240x126	M	44
78834	204x340x155	L	27
78835	333x500x187	XL	7

EN Organizer  
 PL Organizer  
 DE Werkzeugkaste  
 RU Органайзер

CZ Organízér  
 RO Cutie tip organizator  
 HU Csavartartó doboz  
 ES Caja



200x145  
x35  
mm



No.	Dimensions / Wymiary [mm]	Compartment quantity / Liczba przegródek	
78790	200x145x35	7	10

EN Organizer  
 PL Organizer  
 DE Werkzeugkaste  
 RU Органайзер  
 CZ Organízér  
 RO Cutie tip organizator  
 HU Csavartartó doboz  
 ES Caja



360x270  
mm



No.	Dimensions / Wymiary [mm]	
78794	360x270	5

EN Storage case  
 PL Pojemnik magazynowy  
 DE Lagersichtbox  
 RU Ящик для склада

CZ Box skladovací  
 RO Cutie scule diverse  
 HU Tárolók  
 ES Contenedeor de almacén



No.	Dimensions / Wymiary [mm]	Type / Typ	
78821	108x110x75	P-1	40
78822	160x115x75	P-2	40
78824	235x173x125	P-4	20
78825	340x200x150	P-5	9
78826	440x315x180	P-6	6

18

EN Storage case  
 PL Pojemnik magazynowy  
 DE Lagersichtbox  
 RU Ящик для склада

CZ Box skladovací  
 RO Cutie scule diverse  
 HU Tárolók  
 ES Contenedeor de almacén



No.	Dimensions / Wymiary [mm]	Type / Typ	
78830	116x112x75	XS	270
78831	116x161x75	S	190
78833	170x240x126	M	44
78834	204x340x155	L	27
78835	333x500x187	XL	7







# 19

## Bicycle accessories Akcesoria rowerowe





<b>Bicycle &amp; motorcycle locks</b> Zamknięcia do rowerów i motocykli	
.....296-297	
<b>Bicycle pumps</b> Pompki rowerowe	
.....297-298	
<b>Bicycle tools</b> Narzędzia rowerowe	
.....299	

EN Bicycle lock  
 PL Linka rowerowa  
 DE Fahrradschloss  
 RU Замок велосипедный  
 CZ Zámek jízdního kola  
 RO Antifurt pt. bicicleta  
 HU Kerékpárzár  
 ES Cable antirrobo para bicicletas



No.	L [cm]	Ø [mm]	Color / Kolor	
77830	65	8	czarny, niebieski, czerwony	12/120

EN Bicycle lock  
 PL Linka rowerowa  
 DE Fahrradschloss  
 RU Замок велосипедный  
 CZ Zámek jízdního kola  
 RO Antifurt pt. bicicleta  
 HU Kerékpárzár  
 ES Cable antirrobo para bicicletas



No.	L [cm]	Ø [mm]	Color / Kolor	
77833	120	8	czarny, niebieski, czerwony	10/60
77834	120	10	czarny, niebieski, czerwony	10/60
77835	180	10	czarny, niebieski, czerwony	10/60

EN Bicycle lock  
 PL Linka rowerowa  
 DE Fahrradschloss  
 RU Замок велосипедный  
 CZ Zámek jízdního kola  
 RO Antifurt pt. bicicleta  
 HU Kerékpárzár  
 ES Cable antirrobo para bicicletas

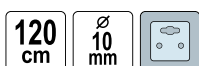

No.	L [cm]	Ø [mm]	Color / Kolor	
77845	120	10	czarny, niebieski, czerwony	20/40

EN Bicycle lock  
 PL Linka rowerowa  
 DE Fahrradschloss  
 RU Замок велосипедный  
 CZ Zámek jízdního kola  
 RO Antifurt pt. bicicleta  
 HU Kerékpárzár  
 ES Cable antirrobo para bicicletas



No.	L [cm]	Ø [mm]	Color / Kolor	
77831	65	8	czarny, niebieski, czerwony	12/120

EN Bicycle lock  
 PL Linka rowerowa  
 DE Fahrradschloss  
 RU Замок велосипедный  
 CZ Zámek jízdního kola  
 RO Antifurt pt. bicicleta  
 HU Kerékpárzár  
 ES Cable antirrobo para bicicletas



No.	L [cm]	Ø [mm]	Color / Kolor	
77837	120	8	czarny, niebieski, czerwony	10/60
77838	150	10	czarny, niebieski, czerwony	10/60

EN Bicycle lock  
 PL Linka rowerowa  
 DE Fahrradschloss  
 RU Замок велосипедный  
 CZ Zámek jízdního kola  
 RO Antifurt pt. bicicleta  
 HU Kerékpárzár  
 ES Cable antirrobo para bicicletas



No.	L [cm]	Ø [mm]	Color / Kolor	
77840	180	12	czarny, niebieski, czerwony	10/40

EN Security cable and lock  
 PL Linka stalowa z kłódką  
 DE Stahlseil, mit Vorhängeschloss  
 RU Канат стальной с замком  
 CZ Ocelové lanko s visacím zámkem  
 RO Sârmă de oțel cu lacăt  
 HU Drótkötél, lakattal  
 ES Cuerda de acero con candado

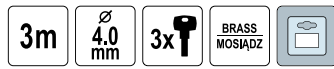

No.	L [cm]	Ø [mm]	
77815	3	4	12/48

EN Motorcycle lock  
 PL Zapięcie motocyklowe  
 DE Stahlgliederschloss  
 RU Замок до мотоцикла  
 CZ Zámek na kolo  
 RO Anti-furt motocicletă  
 HU Láncaklat motorbiciklizhez  
 ES Candado para Moto



No.	L [cm]	Ø [mm]	
77861	150	25	6/12

EN Double cylinder aluminium hand pump  
 PL Teleskopowa pompka aluminiumowa  
 DE Aluminium Handpumpe Doppelzylinder  
 RU Насос телескопический алюминиевый  
 CZ Pumpa ruční double-pístové hliníkové  
 RO Pompa aluminium duo telescope  
 HU Pumpa alumínium dupla dugattyús  
 ES Bomba de mano de doble cilindro de aluminio



No.	
82031	60

EN Foot pump with gauge  
 PL Pompka nożna z manometrem  
 DE Fusspumpe  
 RU Насос ножный с манометром

CZ Nožní pumpa s manometrem  
 RO Pompă de picior cu manometru  
 HU Lábpumpa nyomásmérővel  
 ES Bomba de pierna con manometro



No.	
82000	20

EN Bicycle lock  
 PL Zapięcie rowerowe  
 DE Fahrradschloss  
 RU Замок велосипедный  
 CZ Zámek jízdního kola  
 RO Antifurt pt. bicicleta  
 HU Kerékpárzár  
 ES Cable antirrobo para bicicletas

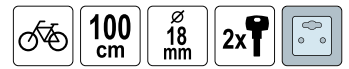

No.	L [cm]	Ø [mm]	
77850	100	18	12/24

EN Chain lock  
 PL Zapięcie łańcuchowe z zamkiem  
 DE Kettenverschluss mit Schloss  
 RU Цепь с замком  
 CZ Bezpečnostní řetěz se zámekem  
 RO Încuietoare lanț cu lacăt  
 HU Kerékpár lakat  
 ES Candado de cadena con cerradura

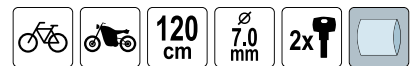

No.	L [cm]	Ø [mm]	
77881	120	7	12

EN Bike hand pump  
 PL Pompka rowerowa  
 DE Fahrradpumpe  
 RU Велосипед ручной насос  
 CZ Pumpička na kolo  
 RO Pompă de bicicletă  
 HU Kerékpár pumpa  
 ES Bomba de bicicleta

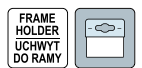

No.	
82032	60

EN Foot pump with gauge  
 PL Pompka nożna z manometrem  
 DE Fusspumpe  
 RU Насос ножный с манометром

CZ Nožní pumpa s manometrem  
 RO Pompă de picior cu manometru  
 HU Lábpumpa nyomásmérővel  
 ES Bomba de pierna con manometro



No.	Measuring range / Zakres pomiaru [MPa]	
82005	0-0.7	5

- EN Foot pump with gauge  
 PL Pompka nożna z manometrem  
 DE Fusspumpe  
 RU Насос ножный с манометром
- CZ Nožní pumpa s manometrem  
 RO Pompă de picior cu manometru  
 HU Lábpumpa nyomásmérővel  
 ES Bomba de pierna con manometro

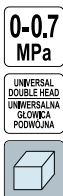

No.	Measuring range / Zakres pomiaru [MPa]	
82001	0-0.7	12

- EN Hand pump  
 PL Pompka słupkowa ręczna  
 DE Hand-Luftpumpe  
 RU Насос ручной  
 CZ Hustilka ruční  
 RO Pompa de mana  
 HU Kézi pumpa  
 ES Bomba de barrote de mano

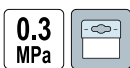

No.	Measuring range / Zakres pomiaru [MPa]	
82020	0-0.3	20

- EN Hand pump with manometer  
 PL Pompka słupkowa z manometrem  
 DE Hand-Luftpumpe mit Manometer  
 RU Насос ручной с манометром  
 CZ Pumpa s manometrem  
 RO Pompa de mana cu manometru  
 HU Kézi pumpa manométerrel  
 ES Bomba de barrote con manometro



No.	Measuring range / Zakres pomiaru [MPa]	
82022	0-1.1	10

- EN Foot pump with gauge  
 PL Pompka nożna z manometrem  
 DE Fusspumpe  
 RU Насос ножный с манометром  
 CZ Nožní pumpa s manometrem  
 RO Pompă de picior cu manometru  
 HU Lábpumpa nyomásmérővel  
 ES Bomba de pierna con manometro



No.	Measuring range / Zakres pomiaru [MPa]	
82015	0-0.7	6

- EN Hand pump with manometer  
 PL Pompka słupkowa z manometrem  
 DE Hand-Luftpumpe mit Manometer  
 RU Насос ручной с манометром  
 CZ Pumpa s manometrem  
 RO Pompa de mana cu manometru  
 HU Kézi pumpa manométerrel  
 ES Bomba de barrote con manometro



No.	Measuring range / Zakres pomiaru [MPa]	
82021	0-1	10

- EN Hand pump with manometer  
 PL Pompka słupkowa z manometrem  
 DE Hand-Luftpumpe mit Manometer  
 RU Насос ручной с манометром  
 CZ Pumpa s manometrem  
 RO Pompa de mana cu manometru  
 HU Kézi pumpa manométerrel  
 ES Bomba de barrote con manometro



No.	Measuring range / Zakres pomiaru [MPa]	
82023	0-1.1	10



EN Bike repair stand  
 PL Stojak do obsługi rowerów  
 DE Fahrrad Montageständer  
 RU Стенд для ремонта велосипедов  
 CZ Montážní stojan  
 RO Stand pt. repararea bicicletelor  
 HU Kerékpár szerelő  
 ES Soporte de reparación

105-145  
cm

360°

max  
30 kgmax Ø  
25-90  
mm

No.

77715



2

Memo

20

Kitchen & home appliance  
Sprzęt AGD



**Kitchen appliance**  
Sprzęt AGD do kuchni



.....302-321

**Home appliance**  
Sprzęt AGD do domu



.....321-328

EN Multifunctional kitchen robot  
 PL Robot kuchenny  
 DE Küchenmaschine  
 RU Кухонный робот  
 CZ Kuchyňský robot  
 RO Robotul de bucatarie  
 HU Robotgép  
 ES Robot de cocina

220-240V~50/60Hz 150 W 3in1 3w1 180 min

**FUNCTIONS:**

- Thin slicing
- Thick slicing
- Thin shredding
- Thick shredding
- Puree blade

**FUNKCJE:**

- Krojenie cienkich plasterów
- Krojenie grubych plasterów
- Tarcie drobne
- Tarcie grube
- Tarcie placzków



**LUND**

No.	Power / Moc [W]	
67961	150	6

EN Stand mixer  
 PL Mikser planetarny  
 DE Küchenmaschine  
 RU Кухонный комбайн  
 CZ Kuchyňský robot  
 RO Robotul multifunctional  
 HU Komplex konyhai robotgép  
 ES Robot de cocina

220-240V~50/60Hz

max 1500 W

1000 W

1.5 L

4.5 L

x6

TURBO



**LUND**

No.	Power / Moc [W]	
67811	1000	2

EN Stand mixer  
 PL Mikser planetarny  
 DE Küchenmaschine  
 RU Кухонный комбайн  
 CZ Kuchyňský robot  
 RO Robotul multifunctional  
 HU Komplex konyhai robotgép  
 ES Robot de cocina

220-240V~50Hz max 1400 W 800 W 5.5 L x6

TURBO SS STAINLESS STEEL STAL WIERZCZENA



**LUND**

No.	Power / Moc [W]	
67805	800	2

EN Hand mixer  
 PL Mikser ręczny  
 DE Handmixer  
 RU Ручной миксер  
 CZ Ruční mixér  
 RO Mixer  
 HU Kézi turmixgép  
 ES Batidora de mano

220-240V~50-60Hz

150 W

x5

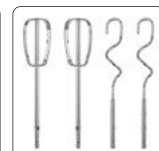

**LUND**

No.	Power / Moc [W]	
67780	150	10



EN Hand mixer  
 PL Mikser ręczny  
 DE Handmixer  
 RU Ручной миксер  
 CZ Ruční mixér  
 RO Mixer  
 HU Kézi turmixgép  
 ES Batidora de mano

220-240V~50-60Hz  
**200 W**  
 x5  
 TURBO  
 SS  
 STAINLESS STEEL  
 STAL NIERDZEWNA



**LUND**

No.	Power / Moc [W]	Icon
67781	200	8

EN Hand blender  
 PL Blender ręczny  
 DE Stabmixer  
 RU Ручной блендер  
 CZ Ruční mixér  
 RO Blender de mana  
 HU Botmixer  
 ES Batidora de mano

220-240V~50/60Hz  
**700 W**  
 TURBO  
 SPEED  
 REGULÁTOR  
 REGULACIJA  
 PREDKOSCI  
 SS  
 STAINLESS STEEL  
 STAL NIERDZEWNA

- INCLUDED:**
- Blender 700 W
  - Stainless steel blade
  - Cup 0.5 l
  - Stainless steel whisk
  - Chopper 0.5 l with stainless steel blade
  - BPA free tritan bottle 0.6 l with blade and cap
  - Holder for blade and whisk

- W ZESTAWIE:**
- Blender 700 W
  - Ostrze ze stali nierdzewnej
  - Pojemnik 0.5 l
  - Trzepaczka ze stali nierdzewnej
  - Malakser 0.5 l z ostrzem ze stali nierdzewnej
  - Butelka 0.6 l wolna od BPA, wykonana z tritanu, z ostrzem i zakrętką
  - Podstawa na ostrze i trzepaczkę



**LUND**

No.	Power / Moc [W]	Icon
67700	700	6

EN Hand mixer with bowl  
 PL Mikser ręczny z misą  
 DE Handmixer mit Schale  
 RU Ручной миксер с чашей  
 CZ Ruční mixér s mísou  
 RO Mixer cu bol  
 HU Kézi turmixgép tállal  
 ES Batidora de mano con bol

220-240V~50-60Hz  
**200 W**  
 3.0 L  
 x3  
 TURBO  
 AUTOMATIC  
 ROTATING BOWL  
 AUTOMATYCZNA  
 ROTACJA MISY  
 SS  
 STAINLESS STEEL  
 STAL NIERDZEWNA



**LUND**

No.	Power / Moc [W]	Icon
67790	200	6

EN Food chopper  
 PL Rozdrabniacz do żywności  
 DE Zerkleinerer für Lebensmittel  
 RU Дробилка для сухой пищи  
 CZ Drtič potravin  
 RO Tocator alimente  
 HU Ételaprító  
 ES Picadora de alimentos

220-240V~50-60Hz  
**500 W**  
 3 in 1  
 3 w 1  
 2 L  
 x2  
 ANTI-SUP  
 SURFACE  
 POWERSZCZONA  
 ANTYPOSLIZGOWA  
 SS  
 STAINLESS STEEL  
 STAL NIERDZEWNA

- INCLUDED:**
- Glass bowl 2 l
  - Steel blades
  - Part for peeling garlic
  - Part for whisking
  - Scraper

- W ZESTAWIE:**
- Szklana misa 2 l
  - Ostrze ze stali nierdzewnej
  - Część do obierania czosnku
  - Część do ubijania
  - Skrobak

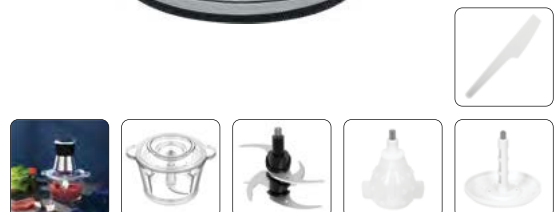

**LUND**

No.	Power / Moc [W]	Icon
67920	500	6

EN Smoothie blender  
 PL Blender kielichowy do smoothie  
 DE Standmixer  
 RU Блендер

CZ Smoothie mixér  
 RO Smoothie blender  
 HU Smoothie turmixgép  
 ES Batidora smoothie

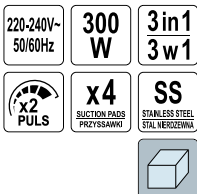

- INCLUDED:**
- Blender 300 W
  - Stainless steel blade
  - Jar 1 l
  - Bottle 0.57 l
  - Bottle 0.4 l

- W ZESTAWIE:**
- Blender 300 W
  - Ostrze ze stali nierdzewnej
  - Kielich 1 l
  - Butelka 0.57 l
  - Butelka 0.4 l



**LUND**

No.	Power / Moc [W]	Icon
67702	300	6

EN Bottle  
 PL Butelka  
 DE Flasche  
 RU Бутылка  
 CZ Láhev  
 RO Slicia  
 HU Üveg  
 ES Botella



**LUND**

No.	Capacity / Pojemność [l]	For / Dla	Icon
67709	0.57	67702, 67703, 67707	12

EN Smoothie blender  
 PL Blender kielichowy do smoothie  
 DE Standmixer  
 RU Блендер

CZ Smoothie mixér  
 RO Smoothie blender  
 HU Smoothie turmixgép  
 ES Batidora smoothie

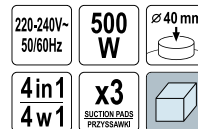

- INCLUDED:**
- Blender 500 W
  - Stainless steel blade
  - Glass jar 0.6 l
  - Bottle 0.57 l
  - Bottle 0.4 l
  - Grinder

- W ZESTAWIE:**
- Blender 500 W
  - Ostrze ze stali nierdzewnej
  - Szklany kielich 0.6 l
  - Butelka 0.57 l
  - Butelka 0.4 l
  - Młynek



**LUND**

No.	Power / Moc [W]	Icon
67703	500	4

EN Stand blender  
 PL Blender kielichowy  
 DE Standmixer  
 RU Блендер  
 CZ Stolní mixér  
 RO Blender  
 HU Turmixgép  
 ES Batidora de vaso



- INCLUDED:**
- Blender 600 W
  - Stainless steel blade
  - Jar 1.5 l

- W ZESTAWIE:**
- Blender 600 W
  - Ostrze ze stali nierdzewnej
  - Kielich 1.5 l



**LUND**

No.	Power / Moc [W]	Icon
67705	600	4

EN Stand blender  
 PL Blender kielichowy  
 DE Standmixer  
 RU Блендер  
 CZ Stolní mixér  
 RO Blender  
 HU Turmixgép  
 ES Batidora de vaso



**INCLUDED:**

- Glass jar 1.5 l
- Stainless steel grinder 500 g
- Tritan bottle 0.6 l

**W ZESTAWIE:**

- Szklany kielich 1.5 l
- Młynek ze stali nierdzewnej 500 g
- Butelka z trytanu 0.6 l



**LUND**

No.	Power / Moc [W]	
67707	1200	4

EN Juicer  
 PL Sokowirówka  
 DE Entsafter  
 RU Соковыжималка  
 CZ Odšťavňovač  
 RO Storcător  
 HU Gyümölcscentrifuga  
 ES Licuadora



**INCLUDED:**

- Pulp container 1.5 l
- Juicer cup 0.45 l
- Stainless steel grater
- Anti-drip tap

**W ZESTAWIE:**

- Pojemnik na pulpę 1.5 l
- Pojemnik na sok 0.45 l
- Tarcza ze stali nierdzewnej
- Kranik zapobiegający kapaniu



**LUND**

No.	Power / Moc [W]	
67851	600	6

EN Portable blender USB  
 PL Blender przenośny USB  
 DE Mobiler USB-Stabmixer  
 RU Портативный USB-блендер  
 CZ Přenosný USB mixér  
 RO Blender portabil USB  
 HU Hordozható USB turmix  
 ES Licuadora portátil USB

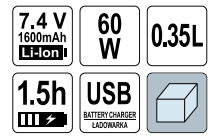

- Working time: 10-15 cycles
- 1 cycle = 40 sec
- Czas pracy: 10-15 cyklów
- Cykl = 40 sek.



**LUND**

No.	Power / Moc [W]	
67710	60	10

EN Slow juicer  
 PL Wyciskarka wolnoobrotowa do soków  
 DE Langsam laufende Saftpresse  
 RU Соковыжималка шнековая  
 CZ Nízkootáčkový odšťavňovač  
 RO Storcător de fructe  
 HU Gyümölcscentrifuga  
 ES Saca jugo



**FEATURES:**

- Prepares fruit and vegetable juices, mousses, ice creams, dairy cocktails
- Keep more nutrition and original taste than traditional juicers
- Reverse gear
- Dishwasher safe for a quick and easy clean up
- Anti-drip cap
- Anti-slip feet
- Comfortable handle
- Low noise <60 db

**CECHY:**

- Możliwość przygotowania soków owocowych i warzywnych, przecierów, lodów i koktajli mlecznych
- Zachowuje więcej witamin i smaku niż tradycyjna sokowirówka
- Bieg wsteczny
- Szybkie i łatwe czyszczenie, możliwość mycia w zmywarce
- Korek niekapek
- Nóżki antypoślizgowe
- Wygodny uchwyt do przenoszenia
- Cicha praca <60 db



**LUND**

No.	Power / Moc [W]	
67840	150	2

EN Slow juicer  
 PL Wyciskarka wolnoobrotowa do soków  
 DE Langsam laufende Saftpresse  
 RU Соковыжималка шнековая  
 CZ Nízkootáčkový odšťavňovač  
 RO Storcator de fructe  
 HU Gyümölcscentrifuga  
 ES Saca jugo

**FEATURES:**

- Prepares fruit and vegetable juices, mousses, ice creams, dairy cocktails
- Keep more nutrition and original taste than traditional juicers
- Reverse gear
- Dishwasher safe for a quick and easy clean up
- Anti-drip cap
- Anti-slip feet
- Comfortable handle
- Low noise <60 db

**CECHY:**

- Możliwość przygotowania soków owocowych i warzywnych, przecierów, lodów i koktajli mlecznych
- Zachowuje więcej witamin i smaku niż tradycyjna sokowirówka
- Bieg wsteczny
- Szybkie i łatwe czyszczenie, możliwość mycia w zmywarce
- Korek niekapek
- Nóżki antypoślizgowe
- Wygodny uchwyt do przenoszenia
- Cicha praca <60 db



220-240V-50/60Hz	150 W
65 min <sup>-1</sup>	∅ 75 mm
3 FILTERS FILTERY	SS STAINLESS STEEL STAL NIERDZEWNA

**LUND**

No.	Power / Moc [W]	
67841	150	2

EN Meat mincer  
 PL Maszynka do mielenia mięsa  
 DE Fleischwolf  
 RU Мясорубка  
 CZ Mlýnek na maso  
 RO Masina de tocat  
 HU Húsdaráló  
 ES Picadora de carne



220-240V-50Hz	550 W	5 in 1 5 w 1	1.5 kg / min
REVERSE GEAR BIEG WSTECZNY	SS STAINLESS STEEL STAL NIERDZEWNA		

**LUND**

No.	Power / Moc [W]	
67900	550	4

EN Meat mincer  
 PL Maszynka do mielenia mięsa  
 DE Fleischwolf  
 RU Мясорубка  
 CZ Mlýnek na maso  
 RO Masina de tocat  
 HU Húsdaráló  
 ES Picadora de carne

220-240V-50/60Hz	1200 W	4 in 1 4 w 1
2 kg / min	x2	REVERSE GEAR BIEG WSTECZNY
SS STAINLESS STEEL STAL NIERDZEWNA		



**LUND**

No.	Power / Moc [W]	
67901	1200	1

EN Electric kettle  
 PL Czajnik elektryczny  
 DE Wasserkocher  
 RU Электрический чайник  
 CZ Rychlovarná konvice  
 RO Fierbator electric  
 HU Elektromos vízforraló  
 ES Hervidor eléctrico

220-240V-50/60Hz	2200 W
360°	1.8 L
SS STAINLESS STEEL STAL NIERDZEWNA	

**FEATURES:**

- Automatic switch off
- Boil-dry protection
- Removable and washable filter
- Cable storage
- Cable length: 80 cm
- Stainless steel housing

**CECHY:**

- Automatyczne wyłączenie po zagotowaniu wody
- Ochrona przed przegrzaniem
- Filtr z możliwością wyjęcia i umycia
- Możliwość zwinięcia kabla pod podstawką
- Długość kabla: 80 cm
- Obudowa ze stali nierdzewnej



**LUND**

No.	Power / Moc [W]	
68172	1850-2200	8



EN Electric kettle  
 PL Czajnik elektryczny  
 DE Wasserkocher  
 RU Электрический чайник  
 CZ Rychlovarná konvice  
 RO Fierbator electric  
 HU Elektromos vízforraló  
 ES Hervidor eléctrico

**FEATURES:**

- Automatic switch off
- Boil-dry protection
- Cable storage
- Cable length: 80 cm
- Stainless steel housing
- Temperature control: 40-100° (40°-50°-60°-70°-80°-90°-100°)
- Keep warm

**CECHY:**

- Automatyczne wyłączenie po zagotowaniu wody
- Ochrona przed przegrzaniem
- Możliwość zwinięcia kabla pod podstawką
- Długość kabla: 80 cm
- Obudowa ze stali nierdzewnej
- Regulacja temperatury: 40-100° (40°-50°-60°-70°-80°-90°-100°)
- Funkcja utrzymywania temperatury

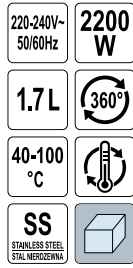

**LUND**

No.	Power / Moc [W]	Icon
68173	1850-2200	8

EN Electric kettle  
 PL Czajnik elektryczny  
 DE Wasserkocher  
 RU Электрический чайник  
 CZ Rychlovarná konvice  
 RO Fierbator electric  
 HU Elektromos vízforraló  
 ES Hervidor eléctrico

**FEATURES:**

- Automatic switch off
- Boil-dry protection
- Removable and washable filter
- Cable storage
- Cable length: 70 cm
- Water gauge
- Stainless steel 304 heating plate and body
- Temperature control (40-45-50-...-95-100)
- Keep warm

**CECHY:**

- Automatyczne wyłączenie po zagotowaniu wody
- Ochrona przed przegrzaniem
- Filtr z możliwością wyjęcia i umycia
- Możliwość zwinięcia kabla pod podstawką
- Długość kabla: 70 cm
- Wskaźnik poziomu wody
- Płyta grzewcza oraz obudowa ze stali nierdzewnej 304
- Regulacja temperatury (40-45-50-...-95-100)
- Funkcja utrzymywania temperatury

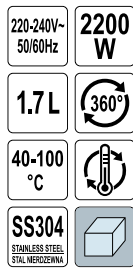

**LUND**

No.	Power / Moc [W]	Icon
68194	1850-2200	8

EN Electric kettle  
 PL Czajnik elektryczny  
 DE Wasserkocher  
 RU Электрический чайник  
 CZ Rychlovarná konvice  
 RO Fierbator electric  
 HU Elektromos vízforraló  
 ES Hervidor eléctrico

**FEATURES:**

- Automatic switch off
- Boil-dry protection
- Removable and washable filter
- Cable length: 75 cm
- Stainless steel housing
- Temperature control: 20-100° (20°-25°-30°-...-95°-100°)
- Keep warm

**CECHY:**

- Automatyczne wyłączenie po zagotowaniu wody
- Ochrona przed przegrzaniem
- Filtr z możliwością wyjęcia i umycia
- Długość kabla: 75 cm
- Obudowa ze stali nierdzewnej
- Regulacja temperatury: 20-100° (20°-25°-30°-...-95°-100°)
- Funkcja utrzymywania temperatury

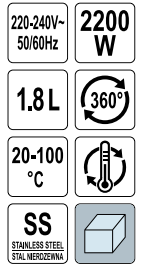

**LUND**

No.	Power / Moc [W]	Icon
68174	1850-2200	6

EN Rechargeable milk frother  
 PL Bezprzewodowy spieniacz do mleka  
 DE Kabelloser Milchaufschäumer  
 RU Беспроводной вспениватель молока  
 CZ Ruční šlehač mléka  
 RO Mixer pt. spuma lapte reincarcabil  
 HU Vezeték nélküli tejhabosító  
 ES Espumador de leche inalámbrico

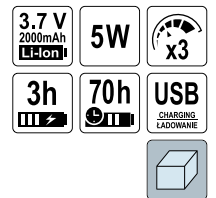

**LUND**

No.	Power / Moc [W]	Icon
68477	5	42

EN Milk frother  
 PL Spieniacz do mleka  
 DE Milchaufschäumer  
 RU Вспениватель молока  
 CZ Nářepňovač mléka  
 RO Aparat pt. spuma de lapte  
 HU Tejhabosító  
 ES Espumador de leche



**FEATURES:**  
 - Hot and cold froth function

**CECHY:**  
 - Funkcja spieniania na zimno i ciepło



**LUND**

No.	Power / Moc [W]	
68470	500	12

EN Air fryer  
 PL Frytkownica beztłuszczowa  
 DE Heissluftfritteuse  
 RU Фритюрница  
 CZ Horkovzdušná fritéza  
 RO Friteuză  
 HU Olajsütő olaj nélküli  
 ES Freidora sin aceite



**FUNCTIONS:**  
 - Defrost  
 - Reheat  
 - Bake  
 - Fry  
 - Grill

**FUNKCJE:**  
 - Rozmraża  
 - Podgrzewa  
 - Piecze  
 - Smazy  
 - Grilluje

**FEATURES:**  
 - Up to 80% less oil than in conventional fryer  
 - Easy to use, timer and temperature control  
 - Dishwasher safe for a quick and easy clean up  
 - Faster heating up than in traditional oven  
 - Preparation: fries, meat, fish, vegetables, cakes and more

**CECHY:**  
 - Nawet 80% mniej oleju niż w standardowej frytkownicy  
 - Łatwa, intuicyjna obsługa dzięki regulacji temperatury i czasu  
 - Szybkie i łatwe czyszczenie, możliwość mycia w zmywarce  
 - Szybsze nagrzewanie niż w tradycyjnym piekarniku  
 - Przygotowanie m.in. frytek, mięsa, ryb, warzyw, ciastek

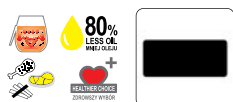

**LUND**

No.	Power / Moc [W]	
67573	1800	1

EN Air fryer  
 PL Frytkownica beztłuszczowa  
 DE Heissluftfritteuse  
 RU Фритюрница  
 CZ Horkovzdušná fritéza  
 RO Friteuză  
 HU Olajsütő olaj nélküli  
 ES Freidora sin aceite



**FEATURES:**  
 - Up to 80% less oil than in conventional fryer  
 - Easy to use, timer and temperature control  
 - Dishwasher safe for a quick and easy clean up  
 - Faster heating up than in traditional oven  
 - Preparation: fries, meat, fish, vegetables, cakes and more

**CECHY:**  
 - Nawet 80% mniej oleju niż w standardowej frytkownicy  
 - Łatwa, intuicyjna obsługa dzięki regulacji temperatury i czasu  
 - Szybkie i łatwe czyszczenie, możliwość mycia w zmywarce  
 - Szybsze nagrzewanie niż w tradycyjnym piekarniku  
 - Przygotowanie m.in. frytek, mięsa, ryb, warzyw, ciastek



**FUNCTIONS:**  
 - Defrost  
 - Reheat  
 - Bake  
 - Fry  
 - Grill

**FUNKCJE:**  
 - Rozmraża  
 - Podgrzewa  
 - Piecze  
 - Smazy  
 - Grilluje



**LUND**

No.	Power / Moc [W]	
67572	1400	1

EN Air fryer  
 PL Frytkownica beztłuszczowa  
 DE Heissluftfritteuse  
 RU Фритюрница

CZ Horkovzdušná fritéza  
 RO Friteuză  
 HU Olajsütő olaj nélküli  
 ES Freidora sin aceite

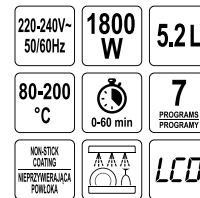

**FEATURES:**  
 - Up to 80% less oil than in conventional fryer  
 - Easy to use, timer and temperature control  
 - Dishwasher safe for a quick and easy clean up  
 - Faster heating up than in traditional oven  
 - Preparation: fries, meat, fish, vegetables, cakes and more

**CECHY:**  
 - Nawet 80% mniej oleju niż w standardowej frytkownicy  
 - Łatwa, intuicyjna obsługa dzięki regulacji temperatury i czasu  
 - Szybkie i łatwe czyszczenie, możliwość mycia w zmywarce  
 - Szybsze nagrzewanie niż w tradycyjnym piekarniku  
 - Przygotowanie m.in. frytek, mięsa, ryb, warzyw, ciastek



**FUNCTIONS:**  
 - Defrost  
 - Reheat  
 - Bake  
 - Fry  
 - Grill

**FUNKCJE:**  
 - Rozmraża  
 - Podgrzewa  
 - Piecze  
 - Smazy  
 - Grilluje



**LUND**

No.	Power / Moc [W]	
67574	1800	1

EN Air fryer  
 PL Frytkownica beztłuszczowa  
 DE Heißluftfritteuse  
 RU Фритюрница  
 CZ Horkovzdušná fritéza  
 RO Friteuză  
 HU Olajsütő olaj nélküli  
 ES Freidora sin aceite

220-240V~50/60Hz  
 1400 W  
 3.7 L  
 30-200 °C  
 LCD  
 10 PROGRAMS PROGRAMY  
 NON-STICK COATING NIEPRZYWIERAJĄCA POWŁOKA  
 DASH WASHABLE  
 THERMALLY STABLE  
 THERMALLY STABLE

**FEATURES:**

- Up to 80% less oil than in conventional fryer
- Easy to use, timer and temperature control
- Dishwasher safe for a quick and easy clean up
- Faster heating up than in traditional oven
- Preparation: fries, meat, fish, vegetables, cakes and more

**CECHY:**

- Nawet 80% mniej oleju niż w standardowej frytkownicy
- Łatwa, intuicyjna obsługa dzięki regulacji temperatury i czasu
- Szybkie i łatwe czyszczenie, możliwość mycia w zmywarce
- Szybsze nagrzewanie niż w tradycyjnym piekarniku
- Przygotowanie m.in. frytek, mięsa, ryb, warzyw, ciastek



**FUNCTIONS:**

- Defrost
- Reheat
- Bake
- Fry
- Grill
- Dry
- Pickle

**FUNKCJE:**

- Rozmraża
- Podgrzewa
- Piecze
- Smaży
- Grilluje
- Suszy
- Kisi



**LUND**

No.	Power / Moc [W]	
67575	1400	1

EN Air fryer  
 PL Frytkownica beztłuszczowa  
 DE Heißluftfritteuse  
 RU Фритюрница  
 CZ Horkovzdušná fritéza  
 RO Friteuză  
 HU Olajsütő olaj nélküli  
 ES Freidora sin aceite

220-230V~50/60Hz  
 1800 W  
 5.7 L  
 30-200 °C  
 LCD  
 10 PROGRAMS PROGRAMY  
 NON-STICK COATING NIEPRZYWIERAJĄCA POWŁOKA  
 DASH WASHABLE  
 THERMALLY STABLE  
 THERMALLY STABLE

**FEATURES:**

- Up to 80% less oil than in conventional fryer
- Easy to use, timer and temperature control
- Dishwasher safe for a quick and easy clean up
- Faster heating up than in traditional oven
- Preparation: fries, meat, fish, vegetables, cakes and more

**CECHY:**

- Nawet 80% mniej oleju niż w standardowej frytkownicy
- Łatwa, intuicyjna obsługa dzięki regulacji temperatury i czasu
- Szybkie i łatwe czyszczenie, możliwość mycia w zmywarce
- Szybsze nagrzewanie niż w tradycyjnym piekarniku
- Przygotowanie m.in. frytek, mięsa, ryb, warzyw, ciastek



**FUNCTIONS:**

- Defrost
- Reheat
- Bake
- Fry
- Grill
- Dry
- Pickle

**FUNKCJE:**

- Rozmraża
- Podgrzewa
- Piecze
- Smaży
- Grilluje
- Suszy
- Kisi



**LUND**

No.	Power / Moc [W]	
67576	1800	1

EN Air fryer  
 PL Frytkownica beztłuszczowa  
 DE Heißluftfritteuse  
 RU Фритюрница  
 CZ Horkovzdušná fritéza  
 RO Friteuză  
 HU Olajsütő olaj nélküli  
 ES Freidora sin aceite

**FUNCTIONS:**

- Defrost
- Reheat
- Bake
- Fry
- Grill
- Dry

**FUNKCJE:**

- Rozmraża
- Podgrzewa
- Piecze
- Smaży
- Grilluje
- Suszy

220-240V~50/60Hz  
 1800 W  
 12 L  
 30-200 °C  
 LCD  
 10 PROGRAMS PROGRAMY  
 NON-STICK COATING NIEPRZYWIERAJĄCA POWŁOKA  
 DASH WASHABLE  
 THERMALLY STABLE  
 THERMALLY STABLE

**FEATURES:**

- Up to 80% less oil than in conventional fryer
- Easy to use, timer and temperature control
- Dishwasher safe for a quick and easy clean up
- Faster heating up than in traditional oven
- Preparation: fries, meat, fish, vegetables, cakes and more

**CECHY:**

- Nawet 80% mniej oleju niż w standardowej frytkownicy
- Łatwa, intuicyjna obsługa dzięki regulacji temperatury i czasu
- Szybkie i łatwe czyszczenie, możliwość mycia w zmywarce
- Szybsze nagrzewanie niż w tradycyjnym piekarniku
- Przygotowanie m.in. frytek, mięsa, ryb, warzyw, ciastek



**LUND**

No.	Power / Moc [W]	
67590	1800	1

EN Pan for air fryers  
 PL Patelnia do frytek beztłuszczowych  
 DE Pizzapfanne für Heißluftfritteuse  
 RU Сковорода для аэрофритюрницы  
 CZ Nízká pánev do horkovzdušné fritézy  
 RO Tigăie pt. friteuza cu aer  
 HU Serpenyő zsímentes fritőzhöz  
 ES Sartén para freidoras sin aceite

ø18 x3 cm  
 NON-STICK COATING NIEPRZYWIERAJĄCA POWŁOKA



**LUND**

No.	For / Dla	
67585	67572, 67573, 67574, 67575, 67576	16

- EN Baking pan for air fryers
- PL Forma do pieczenia do frytkownicy beztluszczowych
- DE Backblech für Heiluftfritteuse
- RU Форма для выпекания для аэрофритюрниц
- CZ Forma na peen do horkovzdun fritzy
- RO Tava de copt pt. friteuza cu aer
- HU Stforma zsrmentes fritzhz
- ES Molde para freidoras sin aceite



**LUND**

No.	For / Dla	Box
67586	67572, 67573, 67574, 67575, 67576	8

- EN Halogen oven
- PL Kombiwar halogenowy
- DE Halogenofen
- RU Галогеновая печь
- CZ Halogenov trouba
- RO Halogen cuptor
- HU Halogn st
- ES Horno halogeno



- ACCESSORIES: AKCESORIA:**
- Tongs
  - Bread rack
  - Szczypce
  - Stojak na chleb

**FEATURES:**

- Cooking time is 3 to 5 times faster than in conventional ovens
- Cooking without fats or oil
- Safe tempered glass body
- Low usage of electricity
- Excellent turbo wash function for self-cleaning
- Easy to use, timer and temperature control
- Evenly cooked foods (convection)

**CECHY:**

- Od 3 do 5 razy szybsze gotowanie w porwnaniu z tradycyjnymi piekarnikami
- Beztuszczowe gotowanie bez oleju
- Bezpieczne, hartowane szklo
- Niskie zuycie energii elektrycznej
- Skuteczna funkcja autoczyszczenia misy
- Ltwa, intuicyjna obsluga dziki regulacji temperatury i czasu
- Rwnomierne gotowanie potraw (termoobieg)

**FUNCTIONS:**

- Thaw
- Reheat
- Bake
- Grill
- Broil
- Cook
- Steam

**FUNKCJE:**

- Odmraa
- Podgrzewa
- Piecze
- Grilluje
- Opieka
- Gotuje
- Gotuje na parze

- EN Grate for air fryers
- PL Ruszt do frytkownicy beztluszczowych
- DE Gitterrost fr Heiluftfritteuse
- RU Решетка для аэрофритюрниц
- CZ Grilovaci mka do horkovzdun fritzy
- RO Gratar pt. friteuza cu aer
- HU Rcs zsrmentes fritzhz
- ES Rejilla para freidoras sin aceite

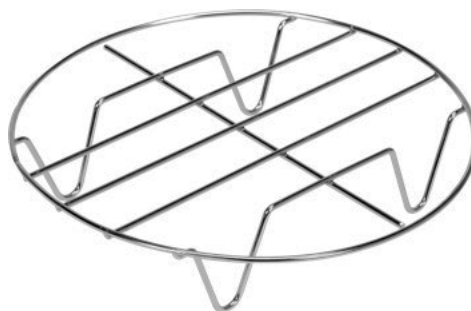

**LUND**

No.	For / Dla	Box
67587	67572, 67573, 67574, 67575, 67576	16

- EN Halogen oven
- PL Kombiwar halogenowy
- DE Halogenofen
- RU Галогеновая печь
- CZ Halogenov trouba
- RO Halogen cuptor
- HU Halogn st
- ES Horno halogeno

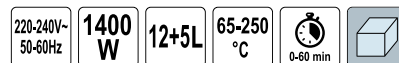

- ACCESSORIES: AKCESORIA:**
- Tongs
  - Bread rack
  - Szczypce
  - Stojak na chleb

**FEATURES:**

- Cooking time is 3 to 5 times faster than in conventional ovens
- Cooking without fats or oil
- Safe tempered glass body
- Low usage of electricity
- Excellent turbo wash function for self-cleaning
- Easy to use, timer and temperature control
- Evenly cooked foods (convection)

**CECHY:**

- Od 3 do 5 razy szybsze gotowanie w porwnaniu z tradycyjnymi piekarnikami
- Beztuszczowe gotowanie bez oleju
- Bezpieczne, hartowane szklo
- Niskie zuycie energii elektrycznej
- Skuteczna funkcja autoczyszczenia misy
- Ltwa, intuicyjna obsluga dziki regulacji temperatury i czasu
- Rwnomierne gotowanie potraw (termoobieg)

**FUNCTIONS:**

- Thaw
- Reheat
- Bake
- Grill
- Broil
- Cook
- Steam

**FUNKCJE:**

- Odmraa
- Podgrzewa
- Piecze
- Grilluje
- Opieka
- Gotuje
- Gotuje na parze



**LUND**

No.	Power / Moc [W]	Box
67640	1200-1400	1



**LUND**

No.	Power / Moc [W]	Box
67641	1200-1400	1



EN Halogen oven  
 PL Kombiwar halogenowy  
 DE Halogenofen  
 RU Галогеновая печь  
 CZ Halogenová trouba  
 RO Halogen cuptor  
 HU Halogén sütő  
 ES Horno halogeno

220-240V~50/60Hz 1400 W 12+5L 65-250 °C 0-60 min

**FUNCTIONS:**

- Thaw
- Reheat
- Bake
- Grill
- Broil
- Cook
- Steam

**FUNKCJE:**

- Odmraża
- Podgrzewa
- Piecze
- Grilluje
- Opieka
- Gotuje
- Gotuje na parze

**FEATURES:**

- Cooking time is 3 to 5 times faster than in conventional ovens
- Cooking without fats or oil
- Safe tempered glass body
- Low usage of electricity
- Excellent turbo wash function for self-cleaning
- Easy to use, timer and temperature control
- Evenly cooked foods (convection)

**CECHY:**

- Od 3 do 5 razy szybsze gotowanie w porównaniu z tradycyjnymi piekarnikami
- Bez tłuszczowe gotowanie bez oleju
- Bezpieczne, hartowane szkło
- Niskie zużycie energii elektrycznej
- Skuteczna funkcja autoczyszczenia misy
- Łatwa, intuicyjna obsługa dzięki regulacji temperatury i czasu
- Równomierne gotowanie potraw (termoobiegi)



**LUND**

No.	Power / Moc [W]	
67642	1200-1400	1

EN Bread maker  
 PL Wypiekacz do chleba  
 DE Brotbackmaschine  
 RU Хлебобечка  
 CZ Domáci pekárna chleba  
 RO Masina de facut paine  
 HU Kenyérüstő  
 ES Panificadora

220-240V~50/60Hz 710 W 19 PROGRAMS 1-99 h DELAY TIME OPOŹNIONY START

**FEATURES:**

- Automatic dispenser
- Loaf size selection: 500 g, 750 g, 1000 g
- Adjustable crust control: light, middle, dark

**CECHY:**

- Automatyyczny dozownik
- Wybór rozmiaru chleba: 500 g, 750 g, 1000 g
- Regulacja przyrumienienia skórki: jasna, średnia, ciemna

**PROGRAMS:**

- Bread: soft, multigrain, whole wheat, sweet, milk, natural sourdough, French, quick, sugar free, gluten free
- Cake
- Raw dough
- Leavened dough
- Jam
- Bake
- Yogurt
- Sticky rice
- Stir-fry
- Ferment

**PROGRAMY:**

- Chleb: pszenny, wieloziarnisty, pełnoziarnisty, słodki, mleczny, naturalny zakwasowy, francuski, szybki, bez cukru, bez glutenu
- Ciasto na słodko
- Ciasto surowe
- Zaczyn
- Dżem
- Dopiekanie
- Jogurt
- Kleisty ryż
- Prażenie
- Fermentacja



**LUND**

No.	Power / Moc [W]	
68033	710	2

EN Bread maker  
 PL Wypiekacz do chleba  
 DE Brotbackmaschine  
 RU Хлебобечка  
 CZ Domáci pekárna chleba  
 RO Masina de facut paine  
 HU Kenyérüstő  
 ES Panificadora

**FEATURES:**

- Loaf size selection: 500 g, 750 g, 1000 g
- Adjustable crust control: light, middle, dark

**CECHY:**

- Wybór rozmiaru chleba: 500 g, 750 g, 1000 g
- Regulacja przyrumienienia skórki: jasna, średnia, ciemna

220-240V~50/60Hz 650 W 15 PROGRAMS DELAY TIME OPOŹNIONY START NON-STICK COATING NIEPRZYWIERAJĄCA POWŁOKA SS STAINLESS STEEL STAL NIERDZWIŻNA

**PROGRAMS:**

- Bread: soft, multigrain, whole wheat, sweet, milk, natural sourdough, French, quick, sugar free, gluten free
- Cake
- Raw dough
- Leavened dough
- Bake
- Yogurt

**PROGRAMY:**

- Chleb: pszenny, wieloziarnisty, pełnoziarnisty, słodki, mleczny, naturalny zakwasowy, francuski, szybki, bez cukru, bez glutenu
- Ciasto na stodo
- Ciasto surowe
- Zaczyn
- Dopiekanie
- Jogurt



**LUND**

No.	Power / Moc [W]	
68032	650	2

EN Food dehydrator  
 PL Suszarka spożywcza  
 DE Lebensmittelrockner  
 RU Сушилка для пищевых продуктов  
 CZ Sušička potravin  
 RO Deshidrator alimente  
 HU Ételszáritó  
 ES Secador de alimentos

220-240V~50/60Hz 300 W 25.7x17 cm TRAY TÁCA 30-80 °C 1-99 h 5 TRAYS TÁCA

**DRIES:**

- Fruit, vegetables, flowers, mushrooms, herbs, meat and much more

**SUSZY:**

- Owoce, warzywa, kwiaty, grzyby, zioła, mięso i wiele innych



**LUND**

No.	Power / Moc [W]	
68280	300-340	2

EN Food dehydrator  
 PL Suszarka spożywcza  
 DE Lebensmittelrockner  
 RU Сушилка для пищевых продуктов  
 CZ Sušička potravin  
 RO Deshidrator alimente  
 HU Ételszáritó  
 ES Secador de alimentos

**DRIES:**  
 - Fruit, vegetables, flowers, mushrooms, herbs, meat and much more

**SUSZY:**  
 - Owoce, warzywa, kwiaty, grzyby, zioła, mięso i wiele innych

220-240V-50-60Hz **500 W**  
 31x29.5 cm TRAY TACA **35-70 °C**  
**5** TRAYS TACE 



**LUND**



No.	Power / Moc [W]	
68270	420-500	4

EN Food dehydrator  
 PL Suszarka spożywcza  
 DE Lebensmittelrockner  
 RU Сушилка для пищевых продуктов

CZ Sušička potravin  
 RO Deshidrator alimente  
 HU Ételszáritó  
 ES Secador de alimentos

**DRIES:**  
 - Fruit, vegetables, flowers, mushrooms, herbs, meat and much more

**SUSZY:**  
 - Owoce, warzywa, kwiaty, grzyby, zioła, mięso i wiele innych

220-240V-50-60Hz **500 W**  
 31x29.5 cm TRAY TACA **35-70 °C**  
 0.5-19.5 h **5** TRAYS TACE 



**LUND**



No.	Power / Moc [W]	
68271	420-500	4

EN Food dehydrator  
 PL Suszarka spożywcza  
 DE Lebensmittelrockner  
 RU Сушилка для пищевых продуктов

CZ Sušička potravin  
 RO Deshidrator alimente  
 HU Ételszáritó  
 ES Secador de alimentos

**DRIES:**  
 - Fruit, vegetables, flowers, mushrooms, herbs, meat and much more

**SUSZY:**  
 - Owoce, warzywa, kwiaty, grzyby, zioła, mięso i wiele innych

220-240V-50-60Hz **500 W**  
 32.5x30 cm TRAY TACA **35-70 °C**  
 0.5-19.5 h **6** TRAYS TACE 

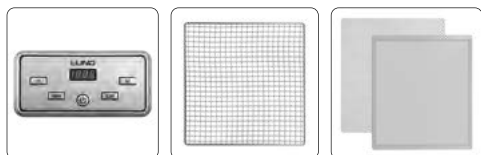

**LUND**



No.	Power / Moc [W]	
68272	420-500	2

EN Food dehydrator  
 PL Suszarka spożywcza  
 DE Lebensmittelrockner  
 RU Сушилка для пищевых продуктов

CZ Sušička potravin  
 RO Deshidrator alimente  
 HU Ételszáritó  
 ES Secador de alimentos

**DRIES:**  
 - Fruit, vegetables, flowers, mushrooms, herbs, meat and much more

**SUSZY:**  
 - Owoce, warzywa, kwiaty, grzyby, zioła, mięso i wiele innych

220-240V-50-60Hz **700 W**  
 32.5x30 cm TRAY TACA **35-70 °C**  
 0.5-19.5 h **9** TRAYS TACE 

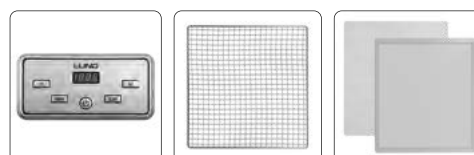

**LUND**

No.	Power / Moc [W]	
68273	600-700	1

EN Tray for food dehydrator  
 PL Tacka do suszarki spożywczej  
 DE Tablett für Dörngerät  
 RU Лоток для пищевой сушилки  
 CZ Táč do sušičky potravin  
 RO Tava pt. deshidratarea alimentelor  
 HU Tálcá ételszáritóhoz  
 ES Bandeja para secador de alimentos

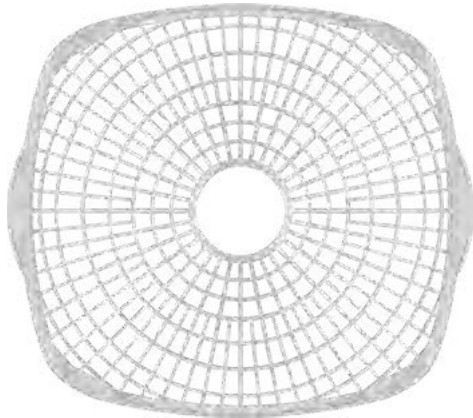

**LUND**

No.	Size / Rozmiar [mm]	For / Dla	
68269	310x295	68270, 68271	6

EN Slow cooker  
 PL Wolnowar  
 DE Schongarer  
 RU Медленноварка  
 CZ Pomalý hmeč  
 RO Oala gătit cu abur  
 HU Lassúfőző edény  
 ES Olla de cocción lenta

**FUNCTIONS:**  
 - Low temperature  
 - High temperature  
 - Keep warm

**FUNKCJE:**  
 - Niska temperatura  
 - Wysoka temperatura  
 - Podtrzymywanie ciepła

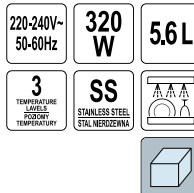

**LUND**

No.	Power / Moc [W]	
67661	320	2

EN Slow cooker  
 PL Wolnowar  
 DE Schongarer  
 RU Медленноварка

**FUNCTIONS:**  
 - Low temperature  
 - High temperature  
 - Keep warm

CZ Pomalý hmeč  
 RO Oala gătit cu abur  
 HU Lassúfőző edény  
 ES Olla de cocción lenta

**FUNKCJE:**  
 - Niska temperatura  
 - Wysoka temperatura  
 - Podtrzymywanie ciepła

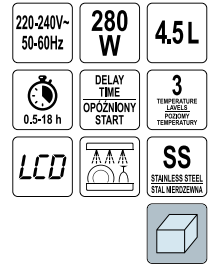

**LUND**

No.	Power / Moc [W]	
67660	280	2

EN Toaster  
 PL Toaster  
 DE Toaster  
 RU Тостер  
 CZ Opékač topinek  
 RO Aparat de prajit paine  
 HU Kenyérpirító  
 ES Tostadora

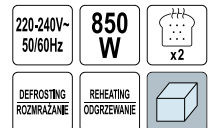

**LUND**

No.	Power / Moc [W]	
67500	700-850	6

EN Toaster CZ Opékač topinek  
 PL Toster RO Aparat de prajit paine  
 DE Toaster HU Kenyérpirító  
 RU Тостер ES Tostadora

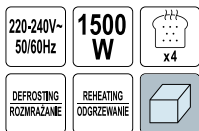

**LUND**

No.	Power / Moc [W]	
67501	1300-1500	4

EN Sandwich maker  
 PL Opiekacz  
 DE Sandwichmaker  
 RU Сэндвичница  
 CZ Sendvičovač  
 RO Aparat pt. sandwich  
 HU Szendvicssütő  
 ES Sandwichera

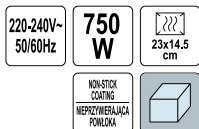

**LUND**

No.	Power / Moc [W]	
67526	750	6

EN Sandwich maker  
 PL Opiekacz  
 DE Sandwichmaker  
 RU Сэндвичница  
 CZ Sendvičovač  
 RO Aparat pt. sandwich  
 HU Szendvicssütő  
 ES Sandwichera



**LUND**

No.	Power / Moc [W]	
67528	750	6

EN Sandwich maker  
 PL Opiekacz  
 DE Sandwichmaker  
 RU Сэндвичница  
 CZ Sendvičovač  
 RO Aparat pt. sandwich  
 HU Szendvicssütő  
 ES Sandwichera

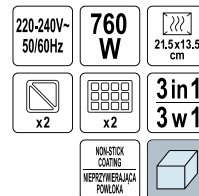

**LUND**

No.	Power / Moc [W]	
67525	640-760	6



EN Sandwich maker  
 PL Opiekacz  
 DE Sandwichmaker  
 RU Сэндвичница  
 CZ Sendvičovač  
 RO Aparat pt. sandwich  
 HU Szendvicssütő  
 ES Sandwichera

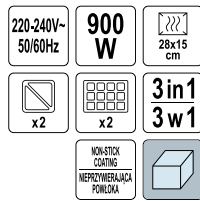

**LUND**

No.	Power / Moc [W]	
67530	900	3

EN Cookie maker  
 PL Opiekacz do ciastek  
 DE Plätzchen-Toaster  
 RU Вафельница для печенья  
 CZ Orékač na cookies  
 RO Aparat pt. fursecuri  
 HU Sütemény készítő gép  
 ES Tostadora de galletas



**LUND**

No.	Power / Moc [W]	
67527	1400	6

EN Sandwich maker  
 PL Opiekacz  
 DE Sandwichmaker  
 RU Сэндвичница

CZ Sendvičovač  
 RO Aparat pt. sandwich  
 HU Szendvicssütő  
 ES Sandwichera

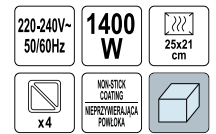

**LUND**

No.	Power / Moc [W]	
67520	1400	4

EN Contact grill  
 PL Grill elektryczny  
 DE Kontaktgrill  
 RU Контактный гриль

CZ Kontaktní gril  
 RO Grătar electric  
 HU Elektromos grillsütő  
 ES Parrilla de contacto

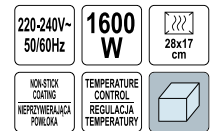

**LUND**

No.	Power / Moc [W]	
67458	1600	3

EN Contact grill  
 PL Grill elektryczny  
 DE Kontaktgrill  
 RU Контактный гриль  
 CZ Kontaktní gril  
 RO Grătar electric  
 HU Elektromos grill sütő  
 ES Parrilla de contacto



**LUND**

No.	Power / Moc [W]	Warranty
67451	2200	3

EN Contact grill  
 PL Grill elektryczny  
 DE Kontaktgrill  
 RU Контактный гриль  
 CZ Kontaktní gril  
 RO Grătar electric  
 HU Elektromos grill sütő  
 ES Parrilla de contacto

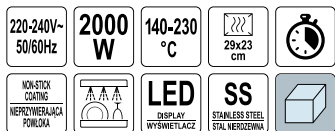

- FEATURES:**
- 3 levels of preparation: rare, medium, well done
  - 5 functions: steak, chicken, fish, sandwich, hamburger
- CECHY:**
- 3 poziomy przygotowania: słabo wysmażony, średnio wysmażony, dobrze wysmażony
  - 5 funkcji: stek, kurczak, ryba, kanapka (tost), hamburger



**LUND**

No.	Power / Moc [W]	Warranty
67450	2000	3

EN Contact grill  
 PL Grill elektryczny  
 DE Kontaktgrill  
 RU Контактный гриль  
 CZ Kontaktní gril  
 RO Grătar electric  
 HU Elektromos grill sütő  
 ES Parrilla de contacto

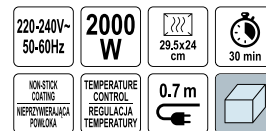

**LUND**

No.	Power / Moc [W]	Warranty
67457	2000	3

EN Electric table grill  
 PL Grill stołowy elektryczny  
 DE Elektro-Tischgrill  
 RU Настольный электрический гриль  
 CZ Elektrický stolní gril  
 RO Grătar electric de masă  
 HU Elektromos asztali grill  
 ES Plancha de asar eléctrica

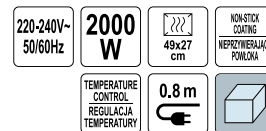

**LUND**

No.	Power / Moc [W]	Warranty
67453	2000	4

EN Electric table grill  
 PL Grill stołowy elektryczny  
 DE Elektro-Tischgrill  
 RU Настольный электрический гриль  
 CZ Elektrický stolní gril  
 RO Grătar electric de masă  
 HU Elektromos asztali grill  
 ES Plancha de asar eléctrica

220-240V~50Hz  
**2000 W**  
 40.5x25 cm  
 NON-STICK COATING  
 NIEPRZYMIERALICA POWŁOKA  
 TEMPERATURE CONTROL  
 REGULACJA TEMPERATURY  
 0.8 m



**LUND**

No.	Power / Moc [W]	
67455	2000	2

EN Waffle maker  
 PL Gofrownica  
 DE Waffeleisen  
 RU Вафельница  
 CZ Vaflovač  
 RO Aparat de preparat waffle  
 HU Gofrisütő  
 ES Gofrera

220-240V~50/60Hz  
**850 W**  
 ∅ 20cm  
 x4  
 NON-STICK COATING  
 NIEPRZYMIERALICA POWŁOKA  
 TEMPERATURE CONTROL  
 REGULACJA TEMPERATURY



**LUND**

No.	Power / Moc [W]	
68011	850	4

EN Electric grill  
 PL Grill elektryczny  
 DE Elektrogrill  
 RU Электрический гриль  
 CZ Elektrický gril  
 RO Gratar electric  
 HU Elektromos grill  
 ES Barbacoa eléctrica

220-240V~50/60Hz  
**2400 W**  
 47x34 cm  
 82 cm  
 TEMPERATURE CONTROL  
 REGULACJA TEMPERATURY  
 NON-STICK COATING  
 NIEPRZYMIERALICA POWŁOKA  
 2.8 m



**LUND**

No.	Power / Moc [W]	
67420	2000-2200	1

EN Waffle maker  
 PL Gofrownica  
 DE Waffeleisen  
 RU Вафельница  
 CZ Vaflovač  
 RO Aparat de preparat waffle  
 HU Gofrisütő  
 ES Gofrera



220-240V~50/60Hz  
**1100 W**  
 24x24 cm  
 x4  
 NON-STICK COATING  
 NIEPRZYMIERALICA POWŁOKA  
 TEMPERATURE CONTROL  
 REGULACJA TEMPERATURY



**LUND**

No.	Power / Moc [W]	
68012	1100	4

- EN Crepe maker
- PL Naleśnikarka
- DE Kreppmacher
- RU Плита для блинов
- CZ Plošna na palačinky
- RO Aparat pt. clătită
- HU Palacsintasütő
- ES Crepera eléct

220-240V~ 50/60Hz	<b>1000 W</b>	 $\approx 30$ cm	NONSTICK COATING NIEPRZYMIERALICA POWLOKA
TEMPERATURE CONTROL REGULACJA TEMPERATURY		 0.8 m	



**LUND**

No.	Power / Moc [W]	
67470	1000	6

- EN Pizza oven stone
- PL Kamień do pieca na pizzę
- DE Pizzaofen-Steinplatte
- RU Камень для печи для пиццы
- CZ Kámen do pece na pizzu
- RO Tava piatră pt. pizza
- HU Pizzakő kemencébe
- ES Piedra de horno para pizza

 $\approx 32$ cm	CORDIERITE KORDIERYT	
--	-------------------------	--



**LUND**

No.	Ø [mm]	For / Dla	
67481	320	67480	5



- EN Vacuum sealer
- PL Pakowarka próżniowa
- DE Vakuuierer
- RU Вакуумный упаковщик
- CZ Vakuová balíčka
- RO Aparat de ambalare in vid
- HU Vákuum csomagolóhoz
- ES Envasadora al vacío



**LUND**

No.	Power / Moc [W]	
67880	140	12

- EN Pizza maker
- PL Piec do pizzy
- DE Pizzaofen
- RU Печь для пиццы
- CZ Pec na pizzu
- RO Aparat preparat pizza
- HU Pizzasütő kemence
- ES Horno para pizza

220-240V~ 50/60Hz	<b>1200 W</b>	max °C <b>400</b>
 $\approx 32$ cm	 0-15 min	TEMPERATURE CONTROL REGULACJA TEMPERATURY
		



**LUND**

No.	Power / Moc [W]	
67480	1200	1

- EN Vacuum sealer
- PL Pakowarka próżniowa
- DE Vakuuierer
- RU Вакуумный упаковщик
- CZ Vakuová balíčka
- RO Aparat de ambalare in vid
- HU Vákuum csomagolóhoz
- ES Envasadora al vacío

220-240V~ 50-60Hz	<b>130 W</b>	-70 kPa	max 30 cm
		<b>8-10 l/min</b>	



**LUND**

No.	Power / Moc [W]	
67877	130	6

20

- EN Vacuum sealer
- PL Pakowarka próżniowa
- DE Vakuuierer
- RU Вакуумный упаковщик
- CZ Vakuová balíčka
- RO Aparat de ambalare in vid
- HU Vákuum csomagolóhoz
- ES Envasadora al vacío

230V~ 50Hz	<b>140 W</b>	-60 kPa	max 22 cm
		<b>11 l/min</b>	

Bags not included  
Produkt nie zawiera worków w zestawie

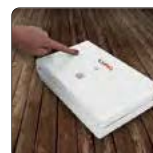



EN Vacuum sealer  
 PL Pakowarka próżniowa  
 DE Vakuumierer  
 RU Вакуумный упаковщик  
 CZ Vakuová balíčka  
 RO Aparat de ambalare in vid  
 HU Vákuum csomagolóhoz  
 ES Envasadora al vacío

220-240V~  
50-60Hz

165 W

-90 kPa

max 32 cm

18 l/min

DOUBLE SEAL  
PODWÓJNY ZGRZEW



**LUND**

No.	Power / Moc [W]	
67881	165	6

EN Vacuum bags  
 PL Worki moletowane  
 DE Goffrierte Vakuumbeutel  
 RU Пакеты с накаткой для вакуумной упаковки  
 CZ Vroubkované vakuové sáčky  
 RO Pungi pt. vidat gofrate  
 HU Légszatornás vákuumtasakok  
 ES Bolsas gofradas para envasar al vacío

50 PCS

90 µm

PA PE



**LUND**

No.	Size / Rozmiar [cm]	Thickness / Grubość [µm]	For / Dla	pcs / szt.	
67887	20x30	90	67880	50	24
67888	25x35	90	67880, 67882	50	14
67889	30x40	90	67881, 67877	50	12

EN Vacuum food container  
 PL Pojemnik próżniowy na żywność  
 DE Vakuumbehälter  
 RU Вакуумный контейнер  
 CZ Vakuová dóza na potraviny  
 RO Cutie alimente cu sistem vacuum  
 HU Vákuumos doboz  
 ES Tarros de vacío

**FEATURES:**

- Help to keep freshness and taste
- Possibility to set a date on the lid

**CECHY:**

- Pomaga zachować świeżość i smak
- Możliwość zaznaczenia daty na pokrywie





2 PCS

0.75L

1.5L

DATE SETTING  
USTAWIENIE  
DATY

**LUND**

No.	Capacity / Pojemność [l]	
67890	0.75, 1.5	12

EN Vacuum sealer  
 PL Pakowarka próżniowa  
 DE Vakuumierer  
 RU Вакуумный упаковщик  
 CZ Vakuová balíčka  
 RO Aparat de ambalare in vid  
 HU Vákuum csomagolóhoz  
 ES Envasadora al vacío

230V~  
50Hz

175 W

-80 kPa

max 28 cm

16 l/min

ADJUSTABLE VACUUM RATE  
REGULACJA SIŁY SSANA



Bags not included  
 Produkt nie zawiera worków w zestawie



**LUND**

No.	Power / Moc [W]	
67882	175	6

EN Vacuum sealer roll  
 PL Folia moletowana w rolce  
 DE Goffrierte Vakuumrolle  
 RU Фольга с накаткой в рулоне  
 CZ Vakuovací vroubkovaná fólie na roli  
 RO Rola folie gofrata pt. vidat  
 HU Vákuumfólia tekercs  
 ES Rollo gofrado para envasar al vacío

105 µm

PA PE



**LUND**

No.	Size / Rozmiar [cm]	Thickness / Grubość [µm]	For / Dla	
67883	25x600	105	67881, 67882, 67877	42
67884	28x600	105	67881, 67877	38
67885	30x600	105	67881	34



EN Kitchen scale  
 PL Waga kuchenna  
 DE Küchenwaage  
 RU Кухонные весы  
 CZ Kuchyňská váha  
 RO Cantar bucatarie  
 HU Konyhamérleg  
 ES Báscula de cocina

**FEATURES:**

- Weight units: oz, g, kg, lb

**CECHY:**

- Jednostki wagi: oz, g, kg, lb



**LUND**

No.	Max. load capacity / Maks. obciążenie [g]	
68360	3000	12

EN Kitchen scale  
 PL Waga kuchenna  
 DE Küchenwaage  
 RU Кухонные весы  
 CZ Kuchyňská váha  
 RO Cantar bucatarie  
 HU Konyhamérleg  
 ES Báscula de cocina

**FEATURES:**

- Weight units: oz, g, kg, lb

- Scale area: 15 x 17.5 cm

**CECHY:**

- Jednostki wagi: oz, g, kg, lb

- Powierzchnia wazenia: 15 x 17.5 cm



**LUND**

No.	Max. load capacity / Maks. obciążenie [g]	
68362	5000	12

EN Kitchen scale  
 PL Waga kuchenna  
 DE Küchenwaage  
 RU Кухонные весы  
 CZ Kuchyňská váha  
 RO Cantar bucatarie  
 HU Konyhamérleg  
 ES Báscula de cocina

**FEATURES:**

- Weight units: g, oz

- Water and milk units: ml, fl oz

- Removeable jug

**CECHY:**

- Jednostki wagi: g, oz

- Jednostki pomiaru wody, mleka: ml, fl oz

- Możliwość wyjęcia pojemnika



**LUND**

No.	Max. load capacity / Maks. obciążenie [g]	
68364	2000	12

EN Kitchen scale  
 PL Waga kuchenna  
 DE Küchenwaage  
 RU Кухонные весы  
 CZ Kuchyňská váha  
 RO Cantar bucatarie  
 HU Konyhamérleg  
 ES Báscula de cocina

**FEATURES:**

- Weight units: oz, g, kg, lb

- Removeable bowl

**CECHY:**

- Jednostki wagi: oz, g, kg, lb

- Możliwość wyjęcia miski



**LUND**

No.	Max. load capacity / Maks. obciążenie [g]	
68361	5000	12

EN Kitchen scale  
 PL Waga kuchenna  
 DE Küchenwaage  
 RU Кухонные весы  
 CZ Kuchyňská váha  
 RO Cantar bucatarie  
 HU Konyhamérleg  
 ES Báscula de cocina

**FEATURES:**

- Weight units: g, kg, ml

- Scale area: 27 x 22.5 cm

**CECHY:**

- Jednostki wagi: g, kg, ml

- Powierzchnia wazenia: 27 x 22.5 cm



**LUND**

No.	Max. load capacity / Maks. obciążenie [g]	
68363	5000	12

EN Kitchen scale  
 PL Waga kuchenna  
 DE Küchenwaage  
 RU Кухонные весы  
 CZ Kuchyňská váha  
 RO Cantar bucatarie  
 HU Konyhamérleg  
 ES Báscula de cocina

**FEATURES:**

- Weight units: g, oz

- Hold function

- Summary function: max 3000 g

**CECHY:**

- Jednostki wagi: g, oz

- Funkcja utrzymania cyfry na wyświetlaczu

- Funkcja sumowania: maks. 3000 g



**LUND**

No.	Max. load capacity / Maks. obciążenie [g]	
68365	300	50

EN Cotton candy maker  
 PL Urządzenie do waty cukrowej  
 DE Zuckerwattemaschine  
 RU Сахарная вата кэнди мэйкер  
 CZ Výrobek cukrové vaty  
 RO Aparat de facut vata de zahar  
 HU Vattacukor-készítő  
 ES Máquina de algodón de azúcar

220-240V~50/60Hz **450 W**  $\varnothing$  295 mm **x2** SUCTION PADS PRZYSSAWKI

**INCLUDED:**  
 - 10 sticks  
 - Measuring spoon

**W ZESTAWIE:**  
 - 10 patyczków  
 - Miarka



**LUND**

No.	Power / Moc [W]	
68250	450	4

EN Popcorn maker  
 PL Urządzenie do popcornu  
 DE Popcorngerät  
 RU Аппарат для попкорна  
 CZ Zařízení k výrobě popcornu  
 RO Aparat de facut popcorn  
 HU Popcorn gép  
 ES Máquina de palomitas de maíz

220-240V~50/60Hz **1200 W** ANTI-SLIP FEET NOŻKI ANTY-POŚLIZGOWE

**FEATURES:**  
 - Capacity: 50-60 g corn  
 - Without oil  
 - Ready in 3 min.

**CECHY:**  
 - Pojemność: 50-60 g ziaren na cykl  
 - Bez użycia oleju  
 - Gotowe w 3 min



**LUND**

No.	Power / Moc [W]	
68260	1200	6

EN Cyclonic vacuum cleaner  
 PL Odkurzacz cyklonowy  
 DE Zyklonischer Staubsauger  
 RU Циклонный пылесос  
 CZ Cyklonový vysavač  
 RO Aspirator ciclonic  
 HU Cyclone porszívó  
 ES Aspiradora ciclónica



**LUND**

No.	Power / Moc [W]	
67091	700	1

EN Cotton candy maker  
 PL Urządzenie do waty cukrowej  
 DE Zuckerwattemaschine  
 RU Сахарная вата кэнди мэйкер  
 CZ Výrobek cukrové vaty  
 RO Aparat de facut vata de zahar  
 HU Vattacukor-készítő  
 ES Máquina de algodón de azúcar

220-240V~50/60Hz **450 W**  $\varnothing$  275 mm **x3** SUCTION PADS PRZYSSAWKI

**INCLUDED:**  
 - 10 sticks  
 - Measuring spoon

**W ZESTAWIE:**  
 - 10 patyczków  
 - Miarka



**LUND**

No.	Power / Moc [W]	
68251	450	8

EN Cyclonic vacuum cleaner  
 PL Odkurzacz cyklonowy  
 DE Zyklonischer Staubsauger  
 RU Циклонный пылесос  
 CZ Cyklonový vysavač  
 RO Aspirator ciclonic  
 HU Cyclone porszívó  
 ES Aspiradora ciclónica

220-240V~50/60Hz **700 W** **1.5L** AUTO-RECORD AUTOMATYCZNE ZAPISYwanie CYCLONIC CYKLONOWY

**HEPA H13** **BAGLESS BEZ-WORKOWY** **5 m**



**LUND**

No.	Power / Moc [W]	
67090	700	1

220-240V~50/60Hz **700 W** **1.5L** AUTO-RECORD AUTOMATYCZNE ZAPISYwanie CYCLONIC CYKLONOWY

**HEPA H13** **BAGLESS BEZ-WORKOWY** **5 m**



- EN Vacuum cleaner filter
- PL Filtr do odkurzacza
- DE Staubsaugerfilter
- RU Фильтр для пылесоса
- CZ Filtr pro vysavače
- RO Filtru aspirator
- HU Porszívó szűrő
- ES Filtro para aspirador



**LUND**

No.	For / Dla	
67093	67090	250

- EN Vacuum cleaner filter
- PL Filtr do odkurzacza
- DE Staubsaugerfilter
- RU Фильтр для пылесоса
- CZ Filtr pro vysavače
- RO Filtru aspirator
- HU Porszívó szűrő
- ES Filtro para aspirador



**LUND**

No.	For / Dla	
67094	67091, 67092	250

- EN Cyclonic vacuum cleaner
- PL Odkurzacz cyklonowy
- DE Zyklonischer Staubsauger
- RU Циклонный пылесос
- CZ Cyklonový vysavač
- RO Aspirator ciclonic
- HU Cyclone porszívó
- ES Aspiradora ciclónica

220-240V-50/60Hz	800 W	1L
	BAGLESS BEZ-WORKOWY	HEPA H13
4.8 m		



**LUND**

No.	Power / Moc [W]	
67110	800	4

- EN Vacuum cleaner filter
- PL Filtr do odkurzacza
- DE Staubsaugerfilter
- RU Фильтр для пылесоса
- CZ Filtr pro vysavače
- RO Filtru aspirator
- HU Porszívó szűrő
- ES Filtro para aspirador

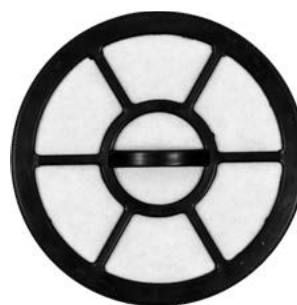

**LUND**

No.	For / Dla	
67095	67090, 67091, 67092	400

- EN Cyclonic vacuum cleaner
- PL Pionowy odkurzacz cyklonowy
- DE Zyklonischer Staubsauger
- RU Циклонный пылесос
- CZ Cyklonový vysavač
- RO Aspirator ciclonic
- HU Cyclone porszívó
- ES Aspiradora ciclónica

220-240V-50Hz	800 W	1.5L	
BAGLESS BEZ-WORKOWY	HEPA H13	4.8 m	



**LUND**

No.	Power / Moc [W]	
67112	800	4



EN Rechargeable vacuum cleaner  
 PL Bezprzewodowy odkurzacz pionowy  
 DE Akku-hand Bodenbürstsauger  
 RU Перезаряжаемый пылесос  
 CZ Akumulátorový vysavač  
 RO Aspirator reincărcabil  
 HU Újratölthető porszívó  
 ES Aspiradora recargable



22.2V 2200mAh Li-Ion	120 W	1L
4-5h	25-35 min	CYCLONIC CYKLONOWY
HEPA H13	BAGLESS BEZ- WORKOWY	

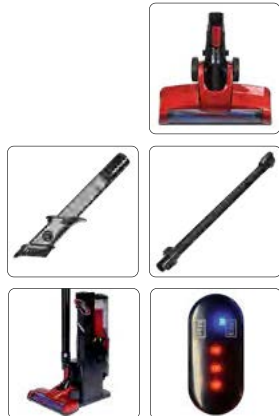

**LUND**

No.	Power / Moc [W]	
67120	120	4

EN Vacuum cleaner filter  
 PL Filtr do odkurzacza  
 DE Staubsaugerfilter  
 RU Фильтр для пылесоса  
 CZ Filtr pro vysavače  
 RO Filtru aspirator  
 HU Porszívó szűrő  
 ES Filtro para aspirador



HEPA H13	
-------------	--

**LUND**

No.	For / Dla	
67115	67110, 67120	100
67116	67111	200

EN Roller for vacuum cleaner  
 PL Walek do odkurzacza  
 DE Staubsauger Bar-Rolle  
 RU Валик для пылесоса  
 CZ Váleček do vysavače  
 RO Rolă pt. aspirator  
 HU Porszívó tengely  
 ES Rodillo de aspiradora



**LUND**

No.	For / Dla	
67123	67121	60

EN Rechargeable vacuum cleaner  
 PL Bezprzewodowy odkurzacz pionowy  
 DE Akku-hand Bodenbürstsauger  
 RU Перезаряжаемый пылесос  
 CZ Akumulátorový vysavač  
 RO Aspirator reincărcabil  
 HU Újratölthető porszívó  
 ES Aspiradora recargable



22.2V 2200mAh Li-Ion	200 W	10/20 kPa
4-5h	12-30 min	CYCLONIC CYKLONOWY
HEPA H13	BAGLESS BEZ- WORKOWY	BRUSHLESS MOTOR SIŁNIK BEZ- SZCZOTKOWY



**LUND**

No.	Power / Moc [W]	
67121	200	4

EN Vacuum cleaner filter  
 PL Filtr do odkurzacza  
 DE Staubsaugerfilter  
 RU Фильтр для пылесоса  
 CZ Filtr pro vysavače  
 RO Filtru aspirator  
 HU Porszívó szűrő  
 ES Filtro para aspirador



HEPA H13	
-------------	--

**LUND**

No.	For / Dla	
67122	67121	100

EN Microfiber for vacuum cleaner  
 PL Mikrofibra do odkurzacza  
 DE Mikrofaser für Staubsauger  
 RU Микрофибра для пылесоса  
 CZ Mikrovlákno do vysavače  
 RO Rezervă microfibra pt. aspirator  
 HU Mikroszálás kendő porszívóhoz  
 ES Microfibra de aspiradora

23,5x9,5 cm	MICROFIBER MIKROFIBRA	
----------------	--------------------------	--



**LUND**

No.	Size / Rozmiar [cm]	For / Dla	
67124	23.5x9.5	67121	300

EN Steam cleaner  
 PL Myjka parowa  
 DE Dampfreiniger  
 RU Паровой очиститель  
 CZ Parní čistič  
 RO Curatitor cu aburi  
 HU Gőztisztító  
 ES Limpiador a vapor



220-240V-50/60Hz	900-1050 W
0.3 MPa	350 ml
28 g/min	max °C 110
10 ELEMENTS ELEMENTY	2m



**LUND**

No.	Power / Moc [W]	
67200	900-1050	6

EN Accessories for steam cleaner  
 PL Akcesoria do myjki parowej  
 DE Dampfreiniger-Zubehör  
 RU Аксессуары для парочистителя

CZ Příslušenství pro parní čistič  
 RO Accesorii pt. curatator cu aburi  
 HU Tartozékok gőztisztítóhoz  
 ES Accesorios para la limpiadora a vapor

4 PCS	
-------	--

**INCLUDED:**

- Brass brush
- Bent nozzle
- Round small nylon brush
- Towel microfiber cloth

**W ZESTAWIE:**

- Szczotka z włosiem z mosiądzu
- Zaokrąglona dysza
- Mała okrągła szczotka
- Mała nakładka z mikrofibry



**LUND**

No.	For / Dla	pcs / szt.	
67202	67200, 67201	4	200

EN Microfibre for steam cleaner  
 PL Mikrofibra do myjki parowej  
 DE Mikrofaser-Bezug für Dampfreiniger  
 RU Микрофибра для парочистителя  
 CZ Násada z mikrovlákna na parní čistič  
 RO Rezerva microfibră pt. curatator cu aburi  
 HU Mikroszálas kendő gőztisztítóhoz  
 ES Microfibra para la limpiadora a vapor



**LUND**

No.	Size / Rozmiar [cm]	For / Dla	pcs / szt.	
67204	35x11	67201	3	100

EN Steam cleaner  
 PL Myjka parowa  
 DE Dampfreiniger  
 RU Паровой очиститель

CZ Parní čistič  
 RO Curatitor cu aburi  
 HU Gőztisztító  
 ES Limpiador a vapor

220-240V-50/60Hz	900-1050 W	0.3 MPa
400 ml	28-40 g/min	max °C 110
17 ELEMENTS ELEMENTY	3m	

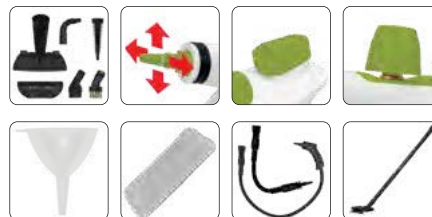

**LUND**

No.	Power / Moc [W]	
67201	900-1050	4

EN Tube for steam cleaner  
 PL Wąż do myjki parowej  
 DE Schlauch für Dampfreiniger  
 RU Шланг для парочистителя

CZ Hadice pro parní čistič  
 RO Tub pt. curatator cu aburi  
 HU Tömlő gőztisztítóhoz  
 ES Manguera para la limpiadora a vapor

**INCLUDED:**

- Flexible tube with nozzle

**W ZESTAWIE:**

- Elastyczny wąż z dyszą

4 PCS	
-------	--

--



**LUND**

No.	L [cm]	For / Dla	
67203	55	67200, 67201	70

3 PCS	MICROFIBER MIKROFIBRA	
-------	-----------------------	--

EN Steam mop  
 PL Mop parowy  
 DE Dampfmopp  
 RU Паровая швабра  
 CZ Parní mop  
 RO Abur mop  
 HU Gőztisztító mop  
 ES Trapeador a vapor



220-240V~ 50/60Hz	<b>1500</b> W
<b>550</b> ml	<b>10-26</b> g/min
max °C <b>110</b>	<b>14</b> ELEMENTS
<b>5 m</b>	

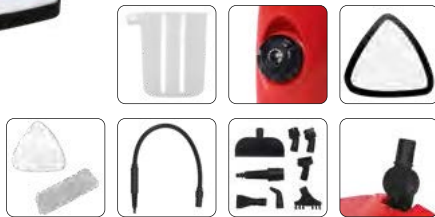

**LUND**

No.	Power / Moc [W]	
67220	1500	4

EN Tube and jet nozzle for steam mop  
 PL Wąż i dysza do mopa parowego  
 DE Schlauch und Düse für Dampfmopp  
 RU Шланг и насадка для паровой швабры  
 CZ Hadice a tryska pro parní mop  
 RO Tub si duza jet pt. mop cu abur  
 HU Törmlő és fúvóka gőzfelmosóhoz  
 ES Manguera y boquilla para la mopa a vapor

<b>2</b> PCS	<b>80</b> cm	
-----------------	-----------------	--

**INCLUDED:**  
 - Flexible tube  
 - Jet nozzle

**W ZESTAWIE:**  
 - Elastyczny wąż  
 - Długa dysza



**LUND**

No.	L [cm]	For / Dla	pcs / szt.	
67225	80	67220, 67221	2	50

EN Microfibre for steam mop  
 PL Mikrofibra do mopa parowego  
 DE Mikrofaser-Bezug für Dampfmopp  
 RU Микрофибра для паровой швабры  
 CZ Násada z mikrovlákna na parní mop  
 RO Rezerva microfibră pt. mop cu abur  
 HU Mikroszálás kendő gőzfelmosóhoz  
 ES Microfibra para mopa a vapor

<b>3</b> PCS	<b>MICROFIBER</b> MIKROFIBRA	
-----------------	---------------------------------	--



**LUND**

No.	For / Dla	pcs / szt.	
67222	67220	3	67

EN Accessories for steam mop  
 PL Akcesoria do mopa parowego  
 DE Dampfmopp-Zubehör  
 RU Аксессуары для паровой швабры  
 CZ Příslušenství pro parní mop  
 RO Accesorii pt. mop cu abur  
 HU Tartozékok gőzfelmosóhoz  
 ES Accesorios para la mopa a vapor

**INCLUDED:**  
 - Brass brush  
 - Round small nylon brush  
 - Round large nylon brush  
 - Slender brush  
 - Scrap shovel  
 - Bent nozzle  
 - Towel microfibre cloth

**W ZESTAWIE:**  
 - Szczotka z włosiem z mosiądzu  
 - Mała okrągła szczotka  
 - Duża okrągła szczotka  
 - Szczotka do fug  
 - Skrobak  
 - Zaokrąglona dysza  
 - Mała nakładka z mikrofibry

<b>7</b> PCS	
-----------------	--



**LUND**

No.	For / Dla	pcs / szt.	
67224	67220, 67221	7	150

EN Electric mop  
 PL Mop elektryczny  
 DE Elektrischer Wischmopp  
 RU Электрическая швабра  
 CZ Elektrický mop  
 RO Mop electric  
 HU Elektromos felmosó  
 ES Mopa eléctrica

<b>7.4 V</b> 2000mAh <b>Li-Ion</b>	<b>200</b> min
<b>200</b> ml	<b>4h</b>
<b>35-40</b> min	
<b>LED CHARGE INDICATOR</b> WSKAZNIK NAŁADZIWANIA BATERII	<b>TELESCOPIC HANDLE</b> UCHWYT TELESKOPOWY



**LUND**

No.	Battery voltage / Napięcie akumulatora [V d.c.]	
67182	7.4	6

EN Microfiber pads for electric mops  
 PL Mikrofibra do mopów elektrycznych  
 DE Mikrofaser-Bezug für elektrische Wischmopps  
 RU Микрофибра для электрических швабр  
 CZ Tkanina z mikrovlákna do elektrických mopů  
 RO Rezervă microfibra pt. mop electric  
 HU Mikroszálás feltét elektromos felmosóhoz  
 ES Microfibra para mopa eléctrica



**LUND**

No.	For / Dla	pcs / szt.	
67183	67182	3	200

EN Travel iron  
 PL Żelazko turystyczne  
 DE Kompakt-Bügeleisen  
 RU Туристический утюг

CZ Turistická žehlička  
 RO Fier de calcat pt calatorii  
 HU Hordozható vasaló  
 ES Plancha de viaje

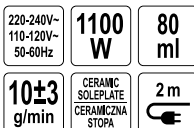

**FUNCTIONS:**

- Dry
- Steam
- Burst of steam
- Temperature control

**FUNKCJE:**

- Prasowanie na sucho
- Prasowanie z parą
- Uderzenie pary
- Regulacja temperatury



**LUND**

No.	Power / Moc [W]	
68100	1100	10

EN Garment steamer  
 PL Parownica do ubrań  
 DE Dampfglätter  
 RU Отпариватель для одежды  
 CZ Oděv parník  
 RO Aparat de calcat vertical  
 HU Ruha gőztisztító  
 ES Vapor de la ropa



**LUND**

No.	Power / Moc [W]	
68090	900-1100	10

EN Steam iron  
 PL Żelazko parowe  
 DE Dampfbügeleisen  
 RU Паровой утюг  
 CZ Napařovací žehlička  
 RO Fier de calcat cu abur  
 HU Gőzölös vasaló  
 ES Plancha de vapor



**FUNCTIONS:**

- Dry
- Spray
- Steam
- Burst of steam
- Vertical steam
- Self-cleaning
- Anti-drip
- Anti-calcium
- Auto shut off
- Temperature control

**FUNKCJE:**

- Prasowanie na sucho
- Spryskiwacz
- Prasowanie z parą
- Uderzenie pary
- Pionowy wyrzut pary
- Funkcja samoczyszczenia
- Blokada kapienia
- System antywapienny
- Automagiczne wyłączenie
- Regulacja temperatury



**LUND**

No.	Power / Moc [W]	
68115	2800	10

EN Tower fan  
 PL Wentylator kolumnowy  
 DE Säulenventilator  
 RU Вентилятор колонный  
 CZ Sloupový ventilátor  
 RO Ventilator turn  
 HU Oszloplventilátor  
 ES Ventilador de torre

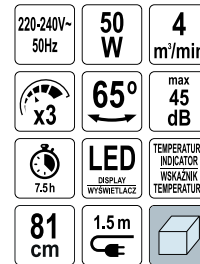

**FEATURES:**

- 3 wind modes (natural, normal, sleep)
- Remote control
- Control panel
- LED display
- Handle

**CECHY:**

- 3 tryby podmuchu (naturalny, normalny, nocny)
- Pilot
- Panel sterowania
- Wyświetlacz LED
- Uchwyt



**LUND**

No.	Power / Moc [W]	
66841	50	1



EN Tower fan  
 PL Wentylator kolumnowy  
 DE Säulenventilator  
 RU Вентилятор колонный  
 CZ Sloupový ventilátor  
 RO Ventilator turn  
 HU Oszlopventilátor  
 ES Ventilador de torre

**FEATURES:**

- 3 wind modes (natural, normal, sleep)
- Remote control
- Control panel
- LED display
- Handle

**CECHY:**

- 3 tryby podmuchu (naturalny, normalny, nocny)
- Pilot
- Panel sterowania
- Wyświetlacz LED
- Uchwyt

220-240V-50Hz	50 W	4 m <sup>3</sup> /min
x3	65°	max 45 dB
7.5h	LED DISPLAY WYŚWIETLACZ	TEMPERATURE INDICATOR WSKAZNIK TEMPERATURY
95.5 cm	1.5 m	



**LUND**

No.	Power / Moc [W]	
66842	50	1

EN Aroma diffuser  
 PL Dyfuzor zapachu  
 DE Aroma-Diffusor  
 RU Диффузор запаха  
 CZ Difuzér vůně  
 RO Difuzer parfum  
 HU Illatdiffúzor  
 ES Difusor de fragancias

**FEATURES:**

- Work type: ultrasounds
- Mist type: low, high

**CECHY:**

- Rodzaj pracy: ultradźwięki
- Rodzaje mgiełki: niska, wysoka

12 W	120 ml	30 ml/h	7 COLOURS KOLORY
20m <sup>2</sup>	2 h		



**LUND**

No.	Power / Moc [W]	
66901	12	24

EN Aroma diffuser  
 PL Dyfuzor zapachu  
 DE Aroma-Diffusor  
 RU Диффузор запаха  
 CZ Difuzér vůně  
 RO Difuzer parfum  
 HU Illatdiffúzor  
 ES Difusor de fragancias

**FEATURES:**

- Work type: ultrasounds
- Mist type: low, high

**CECHY:**

- Rodzaj pracy: ultradźwięki
- Rodzaje mgiełki: niska, wysoka



**LUND**

No.	Power / Moc [W]	
66903	12	12

EN Aroma diffuser  
 PL Dyfuzor zapachu  
 DE Aroma-Diffusor  
 RU Диффузор запаха  
 CZ Difuzér vůně  
 RO Difuzer parfum  
 HU Illatdiffúzor  
 ES Difusor de fragancias

**FEATURES:**

- Work type: ultrasounds

**CECHY:**

- Rodzaj pracy: ultradźwięki

5W	100 ml	15 ml/h	7 COLOURS KOLORY
15m <sup>2</sup>	3 h		



**LUND**

No.	Power / Moc [W]	
66900	5	36

EN Aroma diffuser  
 PL Dyfuzor zapachu  
 DE Aroma-Diffusor  
 RU Диффузор запаха  
 CZ Difuzér vůně  
 RO Difuzer parfum  
 HU Illatdiffúzor  
 ES Difusor de fragancias

**FEATURES:**

- Work type: ultrasounds
- Mist type: low, high

**CECHY:**

- Rodzaj pracy: ultradźwięki
- Rodzaje mgiełki: niska, wysoka



**LUND**

No.	Power / Moc [W]	
66902	12	12

12 W	500 ml	40-60 ml/h	7 COLOURS KOLORY
50m <sup>2</sup>	1h 3h 6h		

20

**LUND**

No.	Power / Moc [W]	
66903	12	12



EN Aroma diffuser  
 PL Dyfuzor zapachu  
 DE Aroma-Diffusor  
 RU Диффузор запаха  
 CZ Difuzér vůně  
 RO Difuzer parfum  
 HU Illatdiffúzor  
 ES Difusor de fragancias

**FEATURES:**

- Work type: ultrasounds
- Mist type: low, high

**CECHY:**

- Rodzaj pracy: ultradźwięki
- Rodzaje mgiełki: niska, wysoka



12 W	500 ml	40-60 ml/h	7 COLOURS KOLORÓV
50m <sup>2</sup>	2h 4h		



**LUND**

No.	Power / Moc [W]	
66904	12	12

EN Air purifier  
 PL Oczyszczacz powietrza  
 DE Luftreiniger  
 RU Очиститель воздуха  
 CZ Čistička vzduchu  
 RO Purificator aer  
 HU Légtisztító  
 ES Purificador de aire

**FEATURES:**

- 4 stages of air purification: polypropylene pre filter, HEPA H10, carbon filter, ionizer
- 3 levels of purification speed
- Sleep mode
- Smart mode
- PM 2.5 detection
- CADR 220 m<sup>3</sup>/h (Clean Air Delivery Rate for particulate matter PM 2.5)
- Temperature detection and indicator
- Odor sensor
- Filter replace reminder

**CECHY:**

- 4 etapy oczyszczania: filtr wstępny z polipropylenu, filtr HEPA H10, filtr węglowy, jonizator
- 3 prędkości oczyszczania
- Tryb uspienia
- Tryb automatyczny
- Czujnik pyłu PM 2.5
- CADR 220 m<sup>3</sup>/h (szybkość dostarczania czystego powietrza dla cząstek stałych PM 2.5)
- Czujnik i wskaźnik temperatury
- Czujnik zapachu
- Funkcja przypominania o wymianie filtra



220-240V-50/60Hz	40 W	PM 2.5	220 m <sup>3</sup> /h CADR
HEPA H10	8h	20-35 m <sup>2</sup>	8 min
	2m		



**LUND**

No.	Power / Moc [W]	
66930	40	1

EN Air purifier filter  
 PL Filtr do oczyszczacza powietrza  
 DE Filter für Luftreiniger  
 RU Фильтр для очистки воздуха  
 CZ Filtr do čističky vzduchu  
 RO Filtru pt. purificator aer  
 HU Légtisztító szűrő  
 ES Filtro para purificador de aire

**TYPE OF FILTERS:**

- Aluminium mesh
- HEPA H12
- Carbon filter
- Photocatalysis

**TYPY FILTRÓW:**

- Aluminiowa siatka
- HEPA H12
- Filtr węglowy
- Filtr fotokatalizacyjny

**LUND**

No.	For / Dla	
66937	66934, 66936	20

EN Aroma diffuser  
 PL Dyfuzor zapachu  
 DE Aroma-Diffusor  
 RU Диффузор запаха  
 CZ Difuzér vůně  
 RO Difuzer parfum  
 HU Illatdiffúzor  
 ES Difusor de fragancias

**FEATURES:**

- Work type: ultrasounds
- Mist type: low, high

**CECHY:**

- Rodzaj pracy: ultradźwięki
- Rodzaje mgiełki: niska, wysoka



13 W	1000 ml	50-70 ml/h	7 COLOURS KOLORÓV
50m <sup>2</sup>	3h 6h 9h		



**LUND**

No.	Power / Moc [W]	
66906	13	12

EN Air purifier filter  
 PL Filtr do oczyszczacza powietrza  
 DE Filter für Luftreiniger  
 RU Фильтр для очистки воздуха  
 CZ Filtr do čističky vzduchu  
 RO Filtru pt. purificator aer  
 HU Légtisztító szűrő  
 ES Filtro para purificador de aire

3 in 1	
3 w 1	

**TYPE OF FILTERS:**

- Polypropylene pre-filter
- HEPA H10
- Carbon filter

**TYPY FILTRÓW:**

- Filtr wstępny z polipropylenu
- HEPA H10
- Filtr węglowy

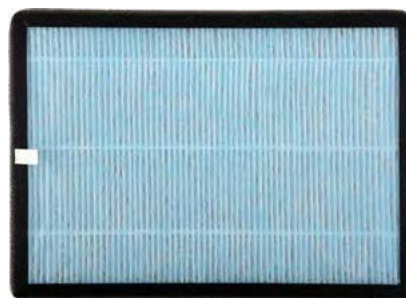

**LUND**

No.	For / Dla	
66931	66930	40

EN Air purifier filter  
 PL Filtr do oczyszczacza powietrza  
 DE Filter für Luftreiniger  
 RU Фильтр для очистки воздуха  
 CZ Filtr do čističky vzduchu  
 RO Filtru pt. purificator aer  
 HU Légtisztító szűrő  
 ES Filtro para purificador de aire

**TYPE OF FILTERS:**

- Aluminium mesh
- HEPA H12
- Carbon filter
- Photocatalysis

**TYPY FILTRÓW:**

- Aluminiowa siatka
- HEPA H12
- Filtr węglowy
- Filtr fotokatalizacyjny

**LUND**

No.	For / Dla	
66937	66934, 66936	20

4 in 1	
4 w 1	



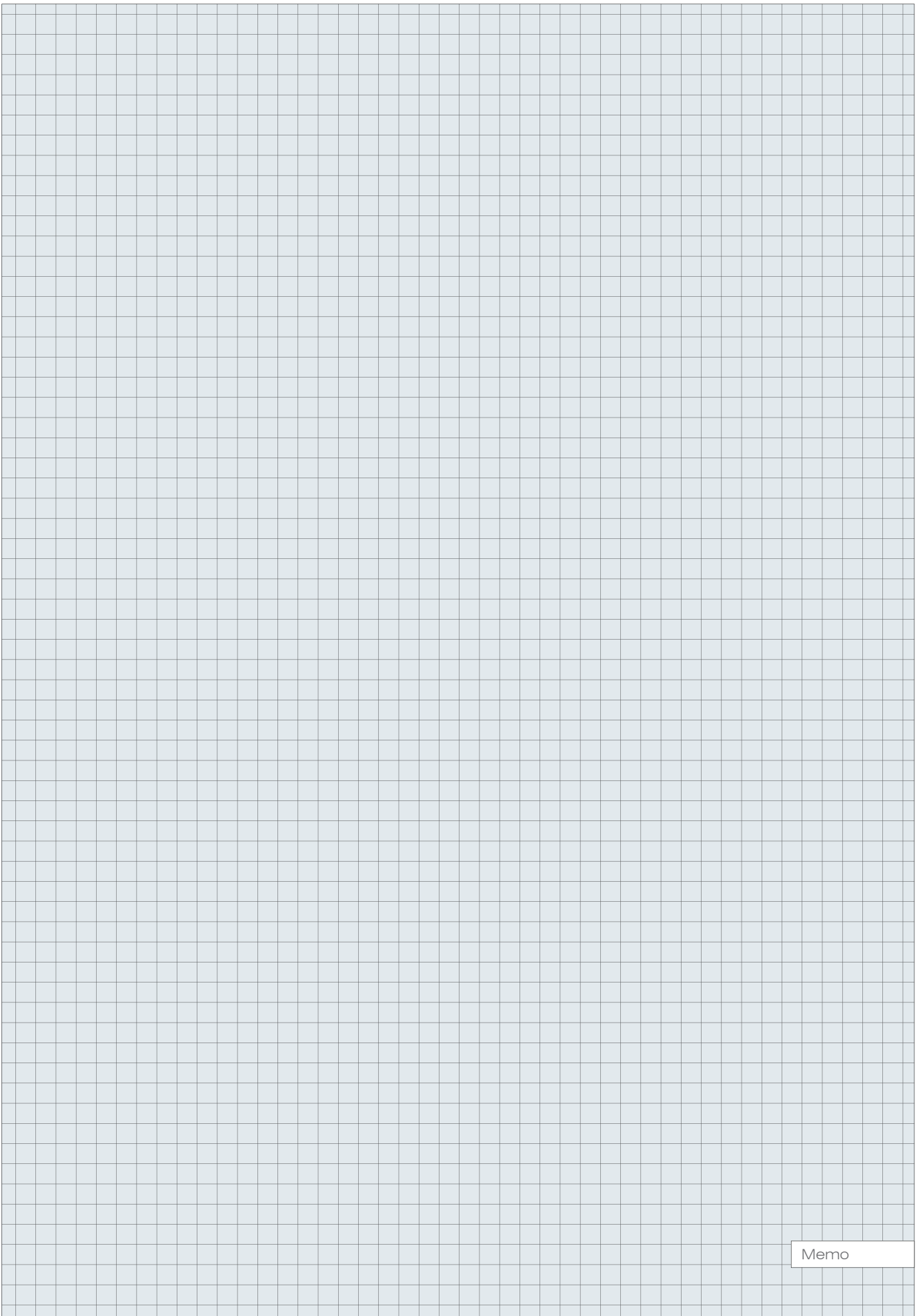

Memo







21

Household equipment  
Gospodarstwo domowe



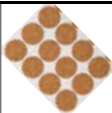

<b>Mailboxes</b> Skrzynki na listy	
.....	332-333
<b>Coal stoves accessories</b> Akcesoria do piecy węglowych	
.....	333-336
<b>Brushes</b> Szczotki	
.....	336-340
<b>Multipurpose trays</b> Podstawki gospodarcze	
.....	340
<b>Bags</b> Worki	
.....	340-342
<b>Tarpaulins &amp; accessories</b> Plandeki i akcesoria	
.....	342-343
<b>Vacuum cleaners, ash separators &amp; accessories</b> Odkurzacze, separatory popiołu i akcesoria	
.....	343-344
<b>Syphon pumps</b> Pompy syfonowe	
.....	344
<b>Pumps</b> Pompki	
.....	344

<b>Vaselines</b> Wazeliny techniczne	
.....	345
<b>Hand trucks</b> Wózki magazynowe	
.....	345
<b>Floor conveyors</b> Transport poziomy	
.....	346
<b>Casters</b> Kółka	
.....	346-348
<b>Seals</b> Uszczelnienia	
.....	349
<b>Self-adhesive furniture pads</b> Podkładki samoprzylepne pod meble	
.....	349-352
<b>Hooks &amp; furniture protection</b> Haczyki i zabezpieczenia	
.....	352-354

EN Mailbox  
 PL Skrzynka na listy  
 DE Briefkasten  
 RU Почтовый ящик  
 CZ Schránka na dopisy  
 RO Cutie poștală  
 HU Levélláda  
 ES Buzón

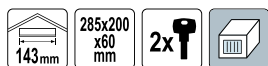

No.	Dimensions / Wymiary [mm]	Slot width / Szerokość wrzutu [mm]	Color / Kolor	
78540	285x200x60	143	czarny	12
78541	285x200x60	143	grafitowy	12
78542	285x200x60	143	brązowy	12
78543	285x200x60	143	zielony	12

EN Mailbox  
 PL Skrzynka na listy  
 DE Briefkasten  
 RU Почтовый ящик  
 CZ Schránka na dopisy  
 RO Cutie poștală  
 HU Levélláda  
 ES Buzón

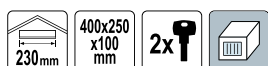

No.	Dimensions / Wymiary [mm]	Slot width / Szerokość wrzutu [mm]	Color / Kolor	
78570	400x250x100	230	czarny	6
78571	400x250x100	230	grafitowy	6
78572	400x250x100	230	brązowy	6

EN Mailbox  
 PL Skrzynka na listy  
 DE Briefkasten  
 RU Почтовый ящик  
 CZ Schránka na dopisy  
 RO Cutie poștală  
 HU Levélláda  
 ES Buzón

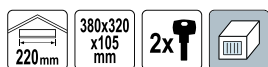

No.	Dimensions / Wymiary [mm]	Slot width / Szerokość wrzutu [mm]	Color / Kolor	
78580	380x320x105	220	czarny	5
78581	380x320x105	220	grafitowy	5
78582	380x320x105	220	brązowy	5

EN Mailbox  
 PL Skrzynka na listy  
 DE Briefkasten  
 RU Почтовый ящик  
 CZ Schránka na dopisy  
 RO Cutie poștală  
 HU Levélláda  
 ES Buzón

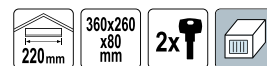

No.	Dimensions / Wymiary [mm]	Slot width / Szerokość wrzutu [mm]	Color / Kolor	
78555	360x260x80	220	czarny	6
78556	360x260x80	220	grafitowy	6
78557	360x260x80	220	brązowy	6

EN Mailbox  
 PL Skrzynka na listy  
 DE Briefkasten  
 RU Почтовый ящик  
 CZ Schránka na dopisy  
 RO Cutie poștală  
 HU Levélláda  
 ES Buzón

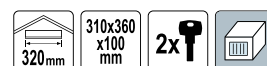

No.	Dimensions / Wymiary [mm]	Slot width / Szerokość wrzutu [mm]	Color / Kolor	
78575	310x360x100	320	czarny	6
78576	310x360x100	320	grafitowy	6
78577	310x360x100	320	brązowy	6

EN Mailbox  
 PL Skrzynka na listy  
 DE Briefkasten  
 RU Почтовый ящик  
 CZ Schránka na dopisy  
 RO Cutie poștală  
 HU Levélláda  
 ES Buzón

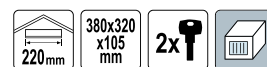

No.	Dimensions / Wymiary [mm]	Slot width / Szerokość wrzutu [mm]	Color / Kolor	
78585	380x320x105	220	czarny	5
78586	380x320x105	220	grafitowy	5
78587	380x320x105	220	brązowy	5

EN Mailbox  
 PL Skrzynka na listy  
 DE Briefkasten  
 RU Почтовый ящик  
 CZ Schránka na dopisy  
 RO Cutie poștală  
 HU Levélláda  
 ES Buzón

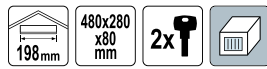

No.	Dimensions / Wymiary [mm]	Slot width / Szerokość wrzutu [mm]	Color / Kolor	
78590	480x280x80	198	czarny	5
78591	480x280x80	198	grafitowy	5
78592	480x280x80	198	brązowy	5

EN Fireplace tool set  
 PL Zestaw kominkowy  
 DE Kaminset  
 RU Каминный набор  
 CZ Krbové nářadí  
 RO Set unelte șemineu  
 HU Kandalló tisztító készlet  
 ES Herramientas de chimenea

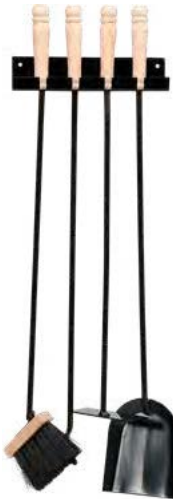

No.	pcs / szt.	
72973	4	1

EN Stove metal plate  
 PL Blacha przypiecowa  
 DE Ofenplatte  
 RU Напольный лист для печи  
 CZ Podložka pod pec z plechu  
 RO Tava protectie soba  
 HU Hőterelő lemez kályhához  
 ES Chapa para suelo estufas



No.	Size / Rozmiar [mm]	Thickness / Grubość [mm]	
72936	500x600	0.5	10
72937	500x800	0.5	10

EN Fireplace tool set  
 PL Zestaw kominkowy  
 DE Kaminset  
 RU Каминный набор  
 CZ Krbové nářadí  
 RO Set unelte șemineu  
 HU Kandalló tisztító készlet  
 ES Herramientas de chimenea



No.	pcs / szt.	
72972	4	1

EN Stove metal plate  
 PL Blacha przypiecowa  
 DE Ofenplatte  
 RU Напольный лист для печи  
 CZ Podložka pod pec z plechu  
 RO Tava protectie soba  
 HU Hőterelő lemez kályhához  
 ES Chapa para suelo estufas



No.	Size / Rozmiar [mm]	Thickness / Grubość [mm]	
72933	300x500	0.5	10
72934	400x600	0.5	10
72935	500x650	0.5	10

EN Chimney brush  
 PL Przetyczka do wyczystki kominowej  
 DE Kaminbürste  
 RU Щетка для дымохода  
 CZ Kominový kartáč  
 RO Coș de perie  
 HU Kéménykefe  
 ES Brosse de cheminée

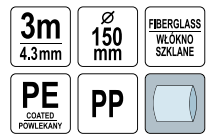

No.	Brush diameter / Średnica wyciora [mm]	
72955	150	20

- EN Chimney cleaner
- PL Wycior kominowy
- DE Schornsteinreiniger
- RU Щетка для трубочистов
- CZ Kartáč kominový
- RO Racletă pt. coșul de fum
- HU Kéménytisztító kefe
- ES Arilla para baquetas de calefacción central



No.	Ø [mm]	
72948	120	15
72950	150	20
72951	175	18
72952	200	18

- EN Chimney cleaner
- PL Wycior kominowy
- DE Schornsteinreiniger
- RU Щетка для трубочистов
- CZ Kartáč kominový
- RO Racletă pt. coșul de fum
- HU Kéménytisztító kefe
- ES Arilla para baquetas de calefacción central



No.	Ø [mm]	
72994	120	15
72995	150	20
72996	175	18
72997	200	18
72998	250	12

- EN Chimneysweep ball
- PL Kula kominarska stalowa
- DE Zuggewicht aus Stahl
- RU Шар дымоходный для чистки дымоходов
- CZ Kominová koule
- RO Acél öntvény kéménygolyó
- HU Bilá curatát cos de fum
- ES Bola de chimenea de acero



No.	m [kg]	
73025	1.3	5
73026	1.8	5
73027	2.5	5

- EN Chimney cleaner
- PL Wycior kominowy
- DE Schornsteinreiniger
- RU Щетка для трубочистов
- CZ Kartáč kominový
- RO Racletă pt. coșul de fum
- HU Kéménytisztító kefe
- ES Arilla para baquetas de calefacción central



No.	Ø [mm]	
72953	250	12
72954	300	8

- EN Chimney rope
- PL Lina kominarska
- DE Schornsteinfeger-Seil
- RU Трос для чистки дымоходов
- CZ Kominové lano
- RO Franghie pt. cos de fum
- HU Kémény kötél
- ES Cuerda de chimenea



No.	Ø [mm]	L [m]	
73021	6	10	15
73022	8	10	15

- EN Iron chimneysweep ball
- PL Kula kominarska żelazna
- DE Schornsteinfegerkugel
- RU Гиря для трубочистов
- CZ Kaminkrčcio kamuolys
- RO Bilă pt. coșul de fum
- HU Kémény golyó
- ES Esfera del deholinador



No.	m [kg]	
72938	1.5	4
72939	2.5	4



EN Chimney brush with iron ball  
 PL Zestaw kominarski  
 DE Schornsteinfeger-Garnitur: Zuggewicht Russbesen Seil  
 RU Набор для чистки дымохода

CZ Kominový set  
 RO Perie cos cu bila + franghie  
 HU Kéménytisztító szettek  
 ES Redondo limpieza cepillo bola de acero



**VOREL**

No.	Brush diameter / Średnica wyciora [mm]	Ball weight / Masa kuli [kg]	Rope length / Długość liny [m]	
73031	125	1.3	10	1
73032	150	1.3	10	1
73033	175	1.8	10	1
73034	200	1.8	10	1
73035	250	2.5	10	1

EN Chimney wire  
 PL Drut kominowy  
 DE Schornsteindraht  
 RU Проволока для трубочистов  
 CZ Kamínkréčio trosas  
 RO Sărmă pt. coșul de fum  
 HU Kéménytisztító drót  
 ES Alambre de chimeneas

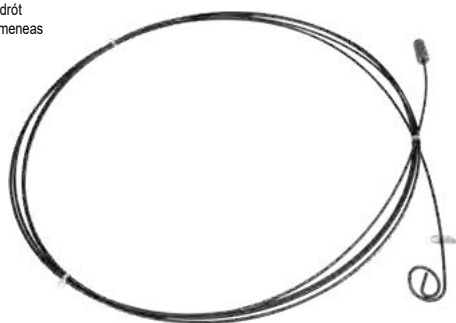

No.	Ø [mm]	L [m]	
72942	3.5	6	25
72943	3.5	8	20
72944	3.5	10	20
72945	3.5	12	20

EN Shovel  
 PL Szufelka angielska  
 DE Kehrschaufel  
 RU Совок  
 CZ Lopatka  
 RO Faras carbune  
 HU Lapát  
 ES Recogedor

340 mm



**VOREL**

No.	W [mm]	L [mm]	
72974	340	200	18

EN Central heating cleaning rod  
 PL Pręt do wyciorów  
 DE Stab für die Reiniger der Zentralheizung  
 RU Черенок для щеток – центральное отопление  
 CZ Tyč k čištění  
 RO Tije pt. racleți încălzire centrală  
 HU CO pálica a füstcsőtisztító keféhez  
 ES Baqueta para limpiar el sistema de calefacción central



No.	Ø [mm]	L [mm]	
72956	7	600	50
72958	7	800	50
72960	7	1000	50

EN Chimney cleaner  
 PL Wycior do C.O.  
 DE Schornsteinreiniger  
 RU Щетка для трубочистов  
 CZ Kartáč kominový  
 RO Racletă pt. coșul de fum  
 HU Kéménytisztító kefe  
 ES Arilla para baquetas de calefacción central



No.	Ø [mm]	
72963	30	50
72964	40	50
72965	50	50
72966	60	35
72967	70	35
72968	80	30
72969	90	20
72970	100	20

EN Shovel  
 PL Szufelka  
 DE Kehrschaufel  
 RU Совок  
 CZ Lopatka  
 RO Lopățică  
 HU Lapát  
 ES Pala

220 mm



**VOREL**

No.	W [mm]	L [mm]	
72976	220	380	20

EN Poker  
 PL Pogrzebacz  
 DE Schürhaken  
 RU Кочерга  
 CZ Pohrabáč  
 RO Vătrai  
 HU Piszkavas  
 ES Alizador

620 mm



No.	L [mm]	
72981	620	50

EN Shovel  
 PL Szufelka  
 DE Kehrschaufel  
 RU Совок  
 CZ Lopatka  
 RO Lopățiță  
 HU Lapát  
 ES Pala



No.	W [mm]	L [mm]	
72978	145	490	40
72977	180	550	30

EN Coal hod  
 PL Węglarka  
 DE Kohlenkasten  
 RU Ведро для угля  
 CZ Uhlák  
 RO Cos carbuni  
 HU Szenes kosár  
 ES Cubo para carbón

385x210 x125 mm



No.	W [mm]	H [mm]	L [mm]	
72984	210	125	385	5

EN Coal hod  
 PL Węglarka  
 DE Kohlenkasten  
 RU Ведро для угля  
 CZ Uhlák  
 RO Cos carbuni  
 HU Szenes kosár  
 ES Cubo para carbón

370x200 x175 mm



No.	W [mm]	H [mm]	L [mm]	
72985	200	175	370	5

EN Shovel  
 PL Szufelka  
 DE Kehrschaufel  
 RU Совок  
 CZ Lopatka  
 RO Lopățiță  
 HU Lapát  
 ES Pala

220 mm



No.	W [mm]	L [mm]	
72975	220	460	40

EN Shovel  
 PL Szufelka  
 DE Kehrschaufel  
 RU Совок  
 CZ Lopatka  
 RO Lopățiță  
 HU Lapát  
 ES Pala

110 mm



No.	W [mm]	L [mm]	
72979	110	500	5/30

EN Microfiber spray mop and window wiper  
 PL Mop ze spryskiwaczem z myjką do okien  
 DE Spritz Mop  
 RU Спрей швабра  
 CZ Stříkací mop  
 RO Mop cu pulverizare  
 HU Permetező mop  
 ES Rociar fregona

350 ml

41x13 cm

x2

MICROFIBER  
 MIKROFIBRA



**FEATURES:**  
 - For every type of surface:  
 wood, floor panel, tile,  
 stone, PVC  
 - Multidirectional mop head

**CECHY:**  
 - Do każdego rodzaju  
 powierzchni: drewna,  
 paneli podłogowych, płytek,  
 kamienia, PCV  
 - Wielokierunkowa stopa  
 czyszcząca



No.	
67160	12

EN Double-sided microfiber spray mop  
 PL Dwustronny mop ze spryskiwaczem  
 DE Spritz Mop  
 RU Спрей швабра  
 CZ Stříkací mop  
 RO Mop cu pulverizare  
 HU Permetező mop  
 ES Rociar fregona

**FEATURES:**

- Wet & dry cleaning
- For every type of surface: wood, floor panel, tile, stone, PVC
- Multidirectional mop head

**CECHY:**

- Mycie na mokro i na sucho
- Do każdego rodzaju powierzchni: drewna, paneli podłogowych, płytek, kamienia, PCV
- Wielokierunkowa stopa czyszcząca

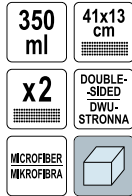

**LUND**

No.	Image
67161	

EN Microfiber  
 PL Mikrofibra  
 DE Mikrofaser  
 RU Микроволокно

CZ Mikrovlákno  
 RO Microfibră  
 HU Mikroszálás  
 ES Microfibra



**LUND**

No.	Size / Rozmiar [mm]	For / Dla	Image
67164	410x130	67161	

EN Microfiber  
 PL Mikrofibra  
 DE Mikrofaser  
 RU Микроволокно  
 CZ Mikrovlákno  
 RO Microfibră  
 HU Mikroszálás  
 ES Microfibra



**LUND**

No.	Size / Rozmiar [mm]	For / Dla	Image
67166	260x70	67162	

EN Microfiber spray mop and window wiper  
 PL Mop ze spryskiwaczem z myjką do okien  
 DE Spritz Mop  
 RU Спрей швабра  
 CZ Stříkací mop  
 RO Mop cu pulverizare  
 HU Permetező mop  
 ES Rociar fregona

**FEATURES:**

- For every type of surface: wood, floor panel, tile, stone, PVC
- Multidirectional mop head

**CECHY:**

- Do każdego rodzaju powierzchni: drewna, paneli podłogowych, płytek, kamienia, PCV
- Wielokierunkowa stopa czyszcząca

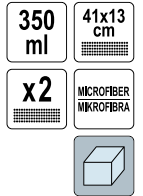

**LUND**

No.	Image
67162	

EN Microfiber  
 PL Mikrofibra  
 DE Mikrofaser  
 RU Микроволокно

CZ Mikrovlákno  
 RO Microfibră  
 HU Mikroszálás  
 ES Microfibra



**LUND**

No.	Size / Rozmiar [mm]	For / Dla	Image
67165	410x130	67160, 67162	

EN Floor sweeper  
 PL Szczotka obrotowa  
 DE Boden sweeper  
 RU Турбо-щётка  
 CZ Mechanický zametač  
 RO Podea peria  
 HU Forgó keféş  
 ES Barredora de escoba

**FEATURES:**

- Great for pet hair
- Capacious basket
- For every type of surface: wood, floor panel, tile, stone, PVC

**CECHY:**

- Odpowiednia do sierści zwierząt
- Pojemny kosz
- Do każdego rodzaju powierzchni: drewna, paneli podłogowych, płytek, kamienia, PCV



**LUND**

No.	Image
67163	

EN Broom  
 PL Zamiatacz  
 DE Feger  
 RU Подметальная машина  
 CZ Smeták  
 RO Matura  
 HU Seprű fej  
 ES Barredor

300 mm



No.	Working width / Szerokość robocza [mm]	
35930	300	10

EN Broom  
 PL Zamiatacz  
 DE Feger  
 RU Подметальная машина  
 CZ Smeták  
 RO Matura  
 HU Seprű fej  
 ES Barredor

270 mm



No.	Working width / Szerokość robocza [mm]	
35932	270	18

EN Brush  
 PL Zmiotka ręczna  
 DE Handfeger  
 RU Ручная щетка-веник  
 CZ Smetáček  
 RO Perie cu maner  
 HU Kézi seprű  
 ES Escoba manual

290 mm



No.	Working width / Szerokość robocza [mm]	
35940	290	25

EN Scrubbing brush  
 PL Szczotka do szorowania  
 DE Scheuerbürste  
 RU Щетка для чистки  
 CZ Rýžový kartáč  
 RO Perie pt. curatat  
 HU Súrolókefe  
 ES Cepillo para frotar

300 mm



No.	Working width / Szerokość robocza [mm]	
35964	300	10

EN Broom with handle  
 PL Zamiatacz z trzonkiem  
 DE Feger mit Stiel  
 RU Подметальная машина с ручкой  
 CZ Smeták s násadou  
 RO Matura cu coada  
 HU Seprű nyéllel  
 ES Barredor con mango

300 mm



No.	Working width / Szerokość robocza [mm]	L [mm]	
35931	300	1180	12

EN Broom  
 PL Zamiatacz z odbojnikiem  
 DE Feger mit Puffer  
 RU Подметальная машина с бампером  
 CZ Smeták s chrániči  
 RO Matura cu protectie  
 HU Seprű fej útközővel  
 ES Barredor con tope

290 mm



No.	Working width / Szerokość robocza [mm]	
35933	290	18

EN Scrubbing brush  
 PL Szczotka do szorowania  
 DE Scheuerbürste  
 RU Щетка для чистки  
 CZ Rýžový kartáč  
 RO Perie pt. curatat  
 HU Súrolókefe  
 ES Cepillo para frotar

300 mm



No.	Working width / Szerokość robocza [mm]	
35963	300	10

EN Scrubbing brush with a handle  
 PL Szczotka z trzonkiem  
 DE Bürste mit Stiel  
 RU Щетка с черенком  
 CZ Kartáč s násadou  
 RO Perie pt. curatat cu maner  
 HU Kefe nyéllel  
 ES Cepillo con mango

300 mm



No.	Working width / Szerokość robocza [mm]	L [mm]	
35968	300	1240	10



EN Hand scrub brush  
 PL Szczotka ręczna  
 DE Handbürste  
 RU Ручная щетка  
 CZ Ruční kartáč  
 RO Perie de mana pt. curatat  
 HU Kézi kefe  
 ES Cepillo manual

200 mm



**VOREL**

No.	Working width / Szerokość robocza [mm]	
35970	200	10

EN Broom  
 PL Miotła  
 DE Strassenbesen  
 RU Метла

CZ Metla  
 RO Matura  
 HU Partvis  
 ES Cepillo pelo largo

250 mm



No.	
35869	10

EN Broom  
 PL Miotła  
 DE Strassenbesen  
 RU Метла

CZ Metla  
 RO Matura  
 HU Partvis  
 ES Cepillo pelo largo

NYLON



No.	Working width / Szerokość robocza [mm]	
35914	400	10
35915	500	10
35916	600	10
35918	800	10

EN Broom  
 PL Miotła  
 DE Strassenbesen  
 RU Метла

CZ Metla  
 RO Matura  
 HU Partvis  
 ES Cepillo pelo largo



No.	Working width / Szerokość robocza [mm]	
35867	300	10
35868	400	10

EN Broom  
 PL Miotła  
 DE Strassenbesen  
 RU Метла  
 CZ Metla  
 RO Matura  
 HU Partvis  
 ES Cepillo pelo largo



No.	Working width / Szerokość robocza [mm]	
35870	300	10
35872	400	10
35874	500	10
35875	600	10
35876	800	10
35877	1000	10

EN Wire broom for pavement  
 PL Miotła drucziana do bruku  
 DE Stahldrahtbesen für Pflastersteine  
 RU Проволочная метла для тротуара

CZ Drátěná metla do dlažby  
 RO Matura pt. pavaje  
 HU Drótszerű járádkhoz  
 ES Escoba de alambre para adoquines

STEEL WIRE DRUT STALOWY



**VOREL**

No.	Working width / Szerokość robocza [mm]	
35923	300	10
35924	400	10

EN Broom  
 PL Miotła  
 DE Strassenbesen  
 RU Метла  
 CZ Metla  
 RO Matura  
 HU Partvis  
 ES Cepillo pelo largo



No.	Working width / Szerokość robocza [mm]	L [mm]	
35911	250	1150	200

EN Broom  
 PL Miotła  
 DE Strassenbesen  
 RU Метла  
 CZ Metla  
 RO Matura  
 HU Partvis  
 ES Cepillo pelo largo



No.	Working width / Szerokość robocza [mm]	
35893	300	12
35894	400	12
35895	500	12

EN Broom  
 PL Miotła  
 DE Strassenbesen  
 RU Метла  
 CZ Metla  
 RO Matura  
 HU Partvis  
 ES Cepillo pelo largo



No.	Working width / Szerokość robocza [mm]	
35899	250	12

EN Microfiber  
 PL Mikrofibra  
 DE Mikrofaser  
 RU Микроволокно  
 CZ Mikrovláknó  
 RO Microfibră  
 HU Mikroszálás  
 ES Microfibra



**LUND**

No.	Size / Rozmiar [mm]	For / Dla	
67171	250x70	67170	500

EN Waste bags  
 PL Worki na odpady, mocne  
 DE Müllbeutel  
 RU Пакеты для мусора  
 CZ Pytle na odpad  
 RO Saci gunoi  
 HU Szemeteszsák  
 ES Bolsas para desperdicios



**VOREL**

No.	Capacity / Pojemność [l]	Thickness / Grubość [µm]	pcs / szt.	
09465	120	30	10	25
09466	160	40	10	15
09467	240	45	10	10

EN All purpose boot tray  
 PL Wielofunkcyjna podstawka gospodarcza  
 DE Garten- und Haushalt-Unterlage  
 RU Многофункциональный поднос

CZ Multifunkční podložka  
 RO Tava multifunctionala  
 HU Többfunkciós tálcá  
 ES Bandeja de arranque universal



**VOREL**

No.	Dimensions / Wymiary [mm]	
67260	780x384x32	30

EN Waste bags  
 PL Worki na odpady domowe  
 DE Müllbeutel  
 RU Пакеты для мусора  
 CZ Pytle na odpad  
 RO Saci gunoi  
 HU Szemeteszsák  
 ES Bolsas para desperdicios



**VOREL**

No.	Capacity / Pojemność [l]	Thickness / Grubość [µm]	pcs / szt.	Material / Material	
09486	35	6	50	HDPE	40
09487	35	11	30	MDPE	45
09489	60	13	20	MDPE	45

EN Waste bags super strong  
 PL Worki na odpady super mocne  
 DE Müllsäcke extra stark  
 RU Пакеты для мусора прочные  
 CZ Super- silný pytle na odpad  
 RO Sac gunoi super rezistent  
 HU Szemeteszsák  
 ES Sacos de residuos super fuertes



No.	Capacity / Pojemność [l]	Thickness / Grubość [µm]	pcs / szt.	
09473	35	30	50	10

EN Waste bags strong with holder  
 PL Worki na odpady z uszami, mocne  
 DE Müllsäcke mit Griff stark  
 RU Пакеты для мусора с завязками прочные  
 CZ Odpadkové pytle s rukojetí  
 RO Sac gunoi rezistent cu maner  
 HU Szemeteszsák  
 ES Sacos de desecho fuertes con soporte



No.	Capacity / Pojemność [l]	Thickness / Grubość [µm]	pcs / szt.	
09474	60	20	20	25

EN Waste bags  
 PL Worki na odpady z nadrukiem  
 DE Müllbeutel  
 RU Пакеты для мусора  
 CZ Pytle na odpad  
 RO Saci gunoi  
 HU Szemeteszsák  
 ES Bolsas para desperdicios



No.	Capacity / Pojemność [l]	Thickness / Grubość [µm]	pcs / szt.	
10001	60	30	15	30
10011	120	40	10	25

EN Waste bags  
 PL Worki na odpady z nadrukiem  
 DE Müllbeutel  
 RU Пакеты для мусора  
 CZ Pytle na odpad  
 RO Saci gunoi  
 HU Szemeteszsák  
 ES Bolsas para desperdicios



No.	Capacity / Pojemność [l]	Thickness / Grubość [µm]	pcs / szt.	
10003	60	30	15	30
10013	120	40	10	25

EN Waste bags with cord  
 PL Worki na odpady domowe z taśmą  
 DE Müllbeutel mit Band  
 RU Пакеты для мусора с лентой  
 CZ Pytle na odpad  
 RO Saci gunoi  
 HU Szemeteszsák  
 ES Bolsas para desperdicios



No.	Capacity / Pojemność [l]	Thickness / Grubość [µm]	pcs / szt.	
09490	60	30	10	25

EN Waste bags  
 PL Worki na odpady z nadrukiem  
 DE Müllbeutel  
 RU Пакеты для мусора  
 CZ Pytle na odpad  
 RO Saci gunoi  
 HU Szemeteszsák  
 ES Bolsas para desperdicios



No.	Capacity / Pojemność [l]	Thickness / Grubość [µm]	pcs / szt.	
10000	60	30	15	30
10010	120	40	10	25

EN Waste bags  
 PL Worki na odpady z nadrukiem  
 DE Müllbeutel  
 RU Пакеты для мусора  
 CZ Pytle na odpad  
 RO Saci gunoi  
 HU Szemeteszsák  
 ES Bolsas para desperdicios



No.	Capacity / Pojemność [l]	Thickness / Grubość [µm]	pcs / szt.	
10002	60	30	15	30
10012	120	40	10	25

EN Waste bags  
 PL Worki na odpady z nadrukiem  
 DE Müllbeutel  
 RU Пакеты для мусора  
 CZ Pytle na odpad  
 RO Saci gunoi  
 HU Szemeteszsák  
 ES Bolsas para desperdicios



No.	Capacity / Pojemność [l]	Thickness / Grubość [µm]	pcs / szt.	
10014	120	40	10	25

EN Waste bags  
 PL Worki na odpady z nadrukiem  
 DE Müllbeutel  
 RU Пакеты для мусора

CZ Pytle na odpad  
 RO Saci gunoi  
 HU Szemeteszsák  
 ES Bolsas para desperdicios

10 PCS 120L 40 µm OTHER INNE



No.	Capacity / Pojemność [l]	Thickness / Grubość [µm]	pcs / szt.	
10015	120	40	10	25

EN Tarpaulin  
 PL Plandeka  
 DE Plane  
 RU Тент

CZ Plachta  
 RO Husă  
 HU Ponyva  
 ES Toldo



57 g/m<sup>2</sup>  
 PE PP

No.	Size / Rozmiar [m]	m [g/m <sup>2</sup> ]	
85122	2x3	57	30
85123	3x5	57	20
85124	4x5	57	10
85125	4x6	57	8
85126	5x8	57	5
85128	6x10	57	3
85129	8x12	57	2
85130	10x15	57	2

EN Tarpaulin  
 PL Plandeka  
 DE Plane  
 RU Тент

CZ Plachta  
 RO Husă  
 HU Ponyva  
 ES Toldo



75 g/m<sup>2</sup>  
 PE PP

No.	Size / Rozmiar [m]	m [g/m <sup>2</sup> ]	
85112	2x3	75	30
85113	3x5	75	10
85114	4x5	75	10
85115	4x6	75	8
85116	5x8	75	5
85118	6x10	75	3
85119	8x12	75	2
85120	10x15	75	2

EN Tarpaulin clips  
 PL Uchwyty zaciskowe ze śrubą do mocowania plandek  
 DE Kunststoff Planenhalter  
 RU Пластиковый клипс зажим для палаток и тентов

CZ Držáky k zakrývacím plachtám  
 RO Clame pt. prelate  
 HU Ponyvarögzítő klipsz  
 ES Pinzas para lonas

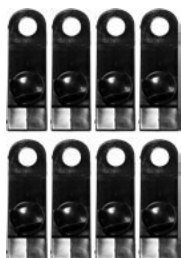

8 PCS NYLON  
 FOR TARPAILINS DO PLANDEK



No.	pcs / szt.	
85170	8	12/48

EN Tarpaulin  
 PL Plandeka  
 DE Plane  
 RU Тент

CZ Plachta  
 RO Husă  
 HU Ponyva  
 ES Toldo



57 g/m<sup>2</sup> PE



No.	Size / Rozmiar [m]	m [g/m <sup>2</sup> ]	
85131	2x3	57	30
85132	3x5	57	20
85133	4x5	57	10
85134	4x6	57	8
85135	5x8	57	5

EN Tarpaulin  
 PL Plandeka  
 DE Plane  
 RU Тент

CZ Plachta  
 RO Husă  
 HU Ponyva  
 ES Toldo



90 g/m<sup>2</sup> PE PP



No.	Size / Rozmiar [m]	m [g/m <sup>2</sup> ]	
85020	2x3	90	30
85030	3x5	90	18
85040	4x5	90	9
85050	4x6	90	10
85060	5x8	90	5
85080	6x10	90	4
85090	8x12	90	2
85100	10x15	90	1

EN Tarpaulin clips  
 PL Uchwyty zaciskowe do mocowania plandek  
 DE Kunststoff Planenhalter  
 RU Пластиковый клипс зажим для палаток и тентов

CZ Držáky k zakrývacím plachtám  
 RO Clame pt. prelate  
 HU Ponyvarögzítő klipsz  
 ES Pinzas para lonas



8 PCS PP  
 FOR TARPAILINS DO PLANDEK



No.	pcs / szt.	
85172	8	72



EN Tarpaulin clips  
 PL Uchwyty zaciskowe do mocowania plandek  
 DE Kunststoff Planenhalter  
 RU Пластиковый клипс зажим для палаток и тентов  
 CZ Držáky k zakrývacím plachtám  
 RO Clame pt. prelate  
 HU PONYVARÓZGÍTÓ KLIPSZ  
 ES Pinzas para lonas

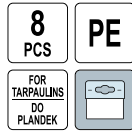

**VOREL**

No.	pcs / szt.	
85174	8	12/48

EN Ball bungee cords  
 PL Guma mocująca z kulką  
 DE Planenspanner Spanngummi mit Kunststoffkugel  
 RU Резиновая петля с шариком  
 CZ Upinací guma s plastovo kuličkou  
 RO Cordelina elastica cu bila fixare  
 HU PONYVA RÓZGÍTŐ GUMIPÓK  
 ES Tensor de goma con bola de plástico



**VOREL**

No.	pcs / szt.	
85180	8	24/96

EN Tarpaulin repair tape  
 PL Taśma klejąca do naprawy plandek  
 DE Planen-Reparatur-Klebeband  
 RU Самоклеящаяся лента тарпаулиновая для ремонта тентов  
 CZ Páska maskovací textilní pro plachtoviny  
 RO Bandă adezivă de reparații pt. prelate  
 HU Szövetszalag ezüst  
 ES Cinta adhesiva de reparación para lonas

**VOREL**

No.	W [mm]	L [m]	
85191	50	8	72

EN Ash separator  
 PL Separator do popiołu  
 DE Ascheabscheider  
 RU Пелла сепаратор  
 CZ Odlučovač popela  
 RO Filtru pt. cenusaă  
 HU Hamuporszívó  
 ES Separador de ceniza



No.		
72920	1	

EN Elastic rope  
 PL Linka pleciona, elastyczna  
 DE Polypropylen-Gummileine  
 RU Шнур эластичный  
 CZ Lano opletené elastické  
 RO Funie elastica  
 HU Rugalmas kótél  
 ES Cuerda trenzada



**VOREL**

No.	Ø [mm]	L [mm]	
85177	8	15	20
85178	8	30	8

EN Tarpaulin repair tape  
 PL Taśma klejąca do naprawy plandek  
 DE Planen-Reparatur-Klebeband  
 RU Самоклеящаяся лента тарпаулиновая для ремонта тентов  
 CZ Páska maskovací textilní pro plachtoviny  
 RO Bandă adezivă de reparații pt. prelate  
 HU Szövetszalag ezüst  
 ES Cinta adhesiva de reparación para lonas



**VOREL**

No.	W [mm]	L [m]	
85190	50	8	72

EN Ash cleaner  
 PL Odkurzacz do popiołu  
 DE Aschesauger  
 RU Пылесос для зоны  
 CZ Vysavač popela  
 RO Aspirator pt. cenusa  
 HU Hamuporszívó  
 ES Aspirador de cenizas

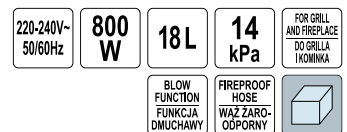

No.	Power / Moc [W]	
72928	800	1

- EN Ash cleaner
- PL Odkurzacz do popiołu
- DE Aschesauger
- RU Пылесос для золы
- CZ Vysavač popela
- RO Aspirator pt. cenusa
- HU Hamuporszívó
- ES Aspirador de cenizas



No.	Power / Moc [W]	
78870	800	1



220-240V-50/60Hz	800 W	20 L	16 kPa
FOR GRILL AND FIREPLACE DO GRILLA I KAMINA	BLOW FUNCTION FUNKCJA ODMUCHAWY	FIREPROOF HOSE WAZ ZARODOPORNY	



- EN Vacuum cleaner filter
- PL Filtr do odkurzacza
- DE Staubsaugerfilter
- RU Фильтр для пылесоса
- CZ Filtr pro vysavače
- RO Filtru aspirator
- HU Porszívó szűrő
- ES Filtro para aspirador



No.	For / Dla	
72931	78870	40

- EN Metal hose
- PL Waż metalowy
- DE Metallschlauch
- RU Металлический шланг
- CZ Kovová hadice
- RO Furtun metalic
- HU Hajlékony, fém tömlő
- ES Manguera de metal



1m	∅ 38 mm
GALVANIZED STEEL STAL OCYNKOWANA	

No.	For / Dla	
72922	72920	20

- EN Metal hose
- PL Waż metalowy
- DE Metallschlauch
- RU Металлический шланг
- CZ Kovová hadice
- RO Furtun metalic
- HU Hajlékony, fém tömlő
- ES Manguera de metal



1m	∅ 38 mm	Al 23cm	
----	---------	---------	--

No.	For / Dla	
72932	72930	20

- EN Syphon pump
- PL Pompa syfonowa
- DE Siphon-Pumpe
- RU Сифонный насос
- CZ Pumpa syfónová
- RO Pompa manuala pt. combustibil
- HU Szifon pumpa
- ES Bomba de sifón



6.2 l/min	∅ 14 mm 390 mm
∅ 12 mm 540 mm	5-50 °C

No.		
78020		30/60

- EN Syphon pump
- PL Pompa syfonowa
- DE Siphon-Pumpe
- RU Сифонный насос
- CZ Pumpa syfónová
- RO Pompa manuala pt. combustibil
- HU Szifon pumpa
- ES Bomba de sifón



10 l/min	∅ 25 mm 850 mm
∅ 22 mm 130 mm	5-50 °C

No.		
78021		24

- EN Multi-purpose pump
- PL Pompa wielofunkcyjna
- DE Multifunktionale Pumpe
- RU Многофункциональный насос
- CZ Univerzální pumpička
- RO Pompă multifuncțională
- HU Többfunkciós szivattyú
- ES Bomba multiusos



40 cm	3x120cm	WATER OIL GASOLINE WATER OIL GASOLINE	PP	PVC	
-------	---------	---------------------------------------	----	-----	--

No.		
78022		6/24

EN Vaseline CZ Technická vazelína  
 PL Wazelina techniczna RO Vaselină tehnică  
 DE Vaseline HU Műszaki vazelin  
 RU Вазелин технический ES Vaselina tecnica



No.	Capacity / Pojemnosť [ml]	
86700	50	50
86701	100	50



EN Folding hand truck  
 PL Składany wózek magazynowy  
 DE Klappbare Transportkarre  
 RU Складная бытовая тележка  
 CZ Skládací hliníkový rudi  
 RO Cărucior transport pliabil  
 HU Összecsukható kézikocsi  
 ES Carretilla de mano plegable



No.	Max. load capacity / Maks. obciążenie [kg]	
78660	70	1

EN Folding hand truck  
 PL Składany wózek magazynowy  
 DE Klappbare Transportkarre  
 RU Складная бытовая тележка  
 CZ Skládací hliníkový rudi  
 RO Cărucior transport pliabil  
 HU Összecsukható kézikocsi  
 ES Carretilla de mano plegable



No.	Max. load capacity / Maks. obciążenie [kg]	
78662	70	5

EN Folding hand truck  
 PL Składany wózek magazynowy  
 DE Klappbare Transportkarre  
 RU Складная бытовая тележка  
 CZ Skládací hliníkový rudi  
 RO Cărucior transport pliabil  
 HU Összecsukható kézikocsi  
 ES Carretilla de mano plegable



No.	Max. load capacity / Maks. obciążenie [kg]	
78661	90	1

EN Folding hand truck  
 PL Składany wózek magazynowy  
 DE Klappbare Transportkarre  
 RU Складная бытовая тележка  
 CZ Skládací hliníkový rudi  
 RO Cărucior transport pliabil  
 HU Összecsukható kézikocsi  
 ES Carretilla de mano plegable



No.	Max. load capacity / Maks. obciążenie [kg]	
78663	130	1

EN Lifting and moving straps  
 PL Pasy do przenoszenia mebli  
 DE Gürtel zum Bewegen von Heben  
 RU Ремни для переноски мебели  
 CZ Pohyblivé pásy pro zvedání nábytku  
 RO Curele pt. mutar obiecte  
 HU Emelő mozgó pántok  
 ES Cinturones para llevar muebles

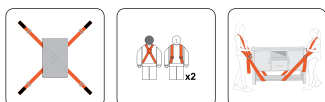
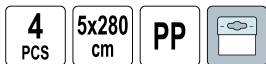

No.	pcs / szt.	
74721	4	10/20

EN Lifting and moving strap  
 PL Pas do przenoszenia ładunku  
 DE Gürtel zum Bewegen von Heben  
 RU Такелажный ремень для переноски грузов  
 CZ Pás pro ruční přenášení nákladu  
 RO Curea pt. mutar obiecte  
 HU Melő mozgó pánt  
 ES Cinturón para llevar carga

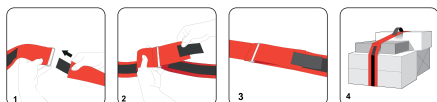

No.	pcs / szt.
74723	32/128

EN Furniture transport roller set  
 PL Zestaw rolek do transportu mebli  
 DE Möbel transportroller set  
 RU Набор для перемещения мебели  
 CZ Sada na stěhování nábytku  
 RO Set transport si ridicat mobila  
 HU Bútor szállító készlet  
 ES Muebles transporte conjunto



No.	pcs / szt.	
87245	5	12

EN Lifting and moving straps  
 PL Pasy do przenoszenia mebli  
 DE Gürtel zum Bewegen von Heben  
 RU Ремни для переноски мебели  
 CZ Pohyblivé pásy pro zvedání nábytku  
 RO Curele pt. mutar obiecte  
 HU Emelő mozgó pántok  
 ES Cinturones para llevar muebles

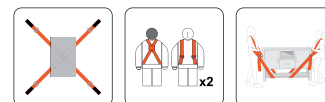

No.	pcs / szt.	
74722	4	15/30

EN Lifting and moving straps  
 PL Pasy do przenoszenia mebli  
 DE Gürtel zum Bewegen von Heben  
 RU Такелажный ремень для переноски мебели  
 CZ Pohyblivé pásy pro zvedání nábytku  
 RO Curele pt. mutar obiecte  
 HU Emelő mozgó pántok  
 ES Cinturones para llevar muebles

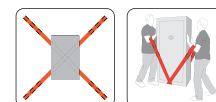

No.	pcs / szt.	
74724	2	33/66

EN Fixed caster  
 PL Kółko stałe  
 DE Bockrolle  
 RU Ролик с стационарной опорой  
 CZ Pevné kolečko  
 RO Roata de carucior fixa  
 HU Szállítógörgők  
 ES Rueda fija

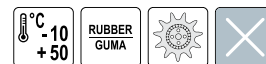

No.	Ø [mm]	W [mm]	H [mm]	Max. load capacity / Maks. obciążenie [kg]	
87301	75	23	97	40	60
87302	100	27	130	60	32
87303	125	34	155	100	22
87305	160	40	195	130	10
87307	200	46	235	150	8



EN Swivel caster  
 PL Kółko skrętne z czarną gumą  
 DE Lenkrolle mit Feststeller  
 RU Ролик с вращающийся опорой  
 CZ Otočné kolečko  
 RO Roata de carucior mobila  
 HU Szállítógörgők  
 ES Rueda giratoria con freno

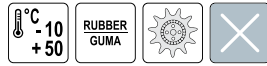

**VOREL**

No.	Ø [mm]	W [mm]	H [mm]	Max. load capacity / Maks. obciążenie [kg]	
87311	75	23	97	40	48
87312	100	27	130	60	26
87313	125	34	155	100	20
87315	160	40	195	130	10
87317	200	46	235	150	6

EN Swivel caster  
 PL Kółko skrętne z szarą gumą  
 DE Lenkrolle mit Feststeller  
 RU Ролик с вращающийся опорой  
 CZ Otočné kolečko  
 RO Roata de carucior mobila  
 HU Szállítógörgők  
 ES Rueda giratoria con freno



**VOREL**

No.	Ø [mm]	W [mm]	H [mm]	Max. load capacity / Maks. obciążenie [kg]	
87331	75	22	97	40	38
87332	100	26	130	60	24
87333	125	33	153	100	18
87335	160	39	190	130	8
87337	200	44	230	150	6

EN Swivel caster  
 PL Kółko skrętne z szarą gumą  
 DE Lenkrolle mit Feststeller  
 RU Ролик с вращающийся опорой  
 CZ Otočné kolečko  
 RO Roata de carucior mobila  
 HU Szállítógörgők  
 ES Rueda giratoria con freno



**VOREL**

No.	Ø [mm]	W [mm]	H [mm]	Max. load capacity / Maks. obciążenie [kg]	
87361	50	16	72	20	100
87362	75	21	104	30	52
87363	100	26	134	45	28
87364	125	27	161	50	24

EN Swivel caster  
 PL Kółko skrętne z czarną gumą  
 DE Lenkrolle mit Feststeller  
 RU Ролик с вращающийся опорой  
 CZ Otočné kolečko  
 RO Roata de carucior mobila  
 HU Szállítógörgők  
 ES Rueda giratoria con freno



**VOREL**

No.	Ø [mm]	W [mm]	H [mm]	Max. load capacity / Maks. obciążenie [kg]	
87321	75	23	97	40	40
87322	100	27	130	60	20
87323	125	34	155	100	16
87325	160	40	195	130	8
87327	200	46	235	150	6

EN Fixed caster  
 PL Kółko stałe  
 DE Bockrolle  
 RU Ролик с стационарной опорой  
 CZ Pevné kolečko  
 RO Roata de carucior fixa  
 HU Szállítógörgők  
 ES Rueda fija



**VOREL**

No.	Ø [mm]	W [mm]	H [mm]	Max. load capacity / Maks. obciążenie [kg]	
87351	50	16	72	20	140
87352	75	21	104	30	60
87353	100	26	134	45	38
87354	125	27	161	50	25

EN Swivel caster  
 PL Kółko skrętne z szarą gumą  
 DE Lenkrolle mit Feststeller  
 RU Ролик с вращающийся опорой  
 CZ Otočné kolečko  
 RO Roata de carucior mobila  
 HU Szállítógörgők  
 ES Rueda giratoria con freno



**VOREL**

No.	Ø [mm]	W [mm]	H [mm]	Max. load capacity / Maks. obciążenie [kg]	
87371	50	16	70	20	120
87372	75	21	101	30	64
87373	100	26	132	45	34
87374	125	27	158	50	24

EN Swivel caster  
 PL Kółko skrętne z szarą gumą  
 DE Lenkrolle mit Feststeller  
 RU Ролик с вращающейся опорой

CZ Otočné kolečko  
 RO Roata de carucior mobila  
 HU Szállítógörgők  
 ES Rueda giratoria con freno



No.	Ø [mm]	W [mm]	H [mm]	Max. load capacity / Maks. obciążenie [kg]	
87381	50	16	72	20	96
87382	75	21	104	30	50
87383	100	26	134	45	26
87384	125	27	161	50	22

EN Swivel caster  
 PL Kółko skrętne  
 DE Lenkrolle mit Feststeller  
 RU Ролик с вращающейся опорой

CZ Otočné kolečko  
 RO Roata de carucior mobila  
 HU Szállítógörgők  
 ES Rueda giratoria con freno

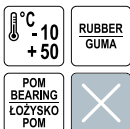

No.	Ø [mm]	W [mm]	H [mm]	Max. load capacity / Maks. obciążenie [kg]	
87401	40	17	54	20	260
87402	50	22	65	25	120
87403	65	23	84	30	78

EN Swivel caster  
 PL Kółko skrętne  
 DE Lenkrolle mit Feststeller  
 RU Ролик с вращающейся опорой

CZ Otočné kolečko  
 RO Roata de carucior mobila  
 HU Szállítógörgők  
 ES Rueda giratoria con freno



No.	Ø [mm]	W [mm]	H [mm]	Max. load capacity / Maks. obciążenie [kg]	
87431	75	23	97	40	60
87432	100	31	130	60	32
87433	125	33	155	100	26
87435	160	40	195	130	12
87437	200	40	235	150	8

EN Fixed caster  
 PL Kółko stałe  
 DE Bockrolle  
 RU Ролик с стационарной опорой

CZ Pevné kolečko  
 RO Roata de carucior fixa  
 HU Szállítógörgők  
 ES Rueda fija

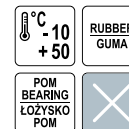

No.	Ø [mm]	W [mm]	H [mm]	Max. load capacity / Maks. obciążenie [kg]	
87391	40	17	54	20	280
87392	50	22	65	25	130
87393	65	23	84	30	90

EN Swivel caster  
 PL Kółko skrętne  
 DE Lenkrolle mit Feststeller  
 RU Ролик с вращающейся опорой

CZ Otočné kolečko  
 RO Roata de carucior mobila  
 HU Szállítógörgők  
 ES Rueda giratoria con freno

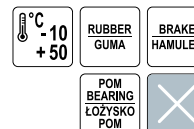

No.	Ø [mm]	W [mm]	H [mm]	Max. load capacity / Maks. obciążenie [kg]	
87411	40	17	54	20	230
87412	50	22	65	25	110
87413	65	23	84	30	72

EN Wheel  
 PL Kółko, czarna guma  
 DE Transportrad  
 RU Ролик

CZ Kolečko  
 RO Roata de carucior  
 HU Önálló görgők  
 ES Rueda

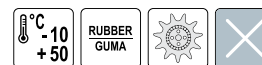

No.	Ø [mm]	W [mm]	Axle diameter / Średnica osi [mm]	Axle length / Długość osi [mm]	Max. load capacity / Maks. obciążenie [kg]	
87451	75	22	12	30	40	150
87452	100	26	12	40	60	66
87453	125	33	15	40	100	36
87454	150	39	20	55	110	22
87455	160	39	20	55	130	20
87456	200	44	20/25	55	150	12
87457	250	48	20/25	55	180	8

EN Seal for windows and doors  
 PL Uszczelka do okien i drzwi  
 DE Dichtung für Fenster und Türen  
 RU Уплотнители для окон и дверей  
 CZ Těsnění oken a dveří  
 RO Seal pt. ferestre si usi  
 HU Seal az ablakok és ajtók  
 ES Sellar para ventanas y puertas



No.	Size / Rozmiar [mm]	L [m]	Type / Typ	Color / Kolor	
76752	9x7.4	6 (2x3)	D	biały	24
76762	9x7.4	6 (2x3)	D	brązowy	24

EN Seal for windows and doors  
 PL Uszczelka do okien i drzwi  
 DE Dichtung für Fenster und Türen  
 RU Уплотнители для окон и дверей  
 CZ Těsnění oken a dveří  
 RO Seal pt. ferestre si usi  
 HU Seal az ablakok és ajtók  
 ES Sellar para ventanas y puertas

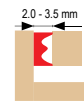

No.	Size / Rozmiar [mm]	L [m]	Type / Typ	Color / Kolor	
76750	9x4	6 (2x3)	E	biały	24
76760	9x4	6 (2x3)	E	brązowy	24

EN Seal for windows and doors  
 PL Uszczelka do okien i drzwi  
 DE Dichtung für Fenster und Türen  
 RU Уплотнители для окон и дверей  
 CZ Těsnění oken a dveří  
 RO Seal pt. ferestre si usi  
 HU Seal az ablakok és ajtók  
 ES Sellar para ventanas y puertas

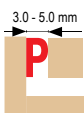

No.	Size / Rozmiar [mm]	L [m]	Type / Typ	Color / Kolor	
76751	9x5.5	6 (2x3)	P	biały	24
76761	9x5.5	6 (2x3)	P	brązowy	24

EN Self-adhesive pad for furniture  
 PL Podkładka samoprzylepna, korkowa  
 DE Klebegleiter für Möbel  
 RU Самоклеящая подкладка под мебель

CZ Podložka samolepící pod nábytek  
 RO Adeziv pad sub mobilier  
 HU Őntapadó, bútöríáb alátét  
 ES Arandela adhesiva bajo los muebles

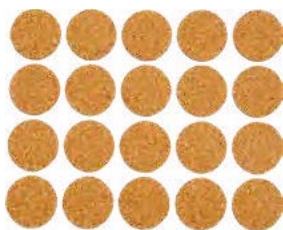

No.	Ø [mm]	pcs / szt.	
74802	20	20	60/720
74804	28	12	60/720

EN Seal for windows and doors  
 PL Uszczelka do okien i drzwi  
 DE Dichtung für Fenster und Türen  
 RU Уплотнители для окон и дверей  
 CZ Těsnění oken a dveří  
 RO Seal pt. ferestre si usi  
 HU Seal az ablakok és ajtók  
 ES Sellar para ventanas y puertas

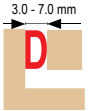

No.	Size / Rozmiar [mm]	L [m]	Type / Typ	Color / Kolor	
76757	9x7.4	100 (2x50)	D	biały	6
76767	9x7.4	100 (2x50)	D	brązowy	6

EN Seal for windows and doors  
 PL Uszczelka do okien i drzwi  
 DE Dichtung für Fenster und Türen  
 RU Уплотнители для окон и дверей  
 CZ Těsnění oken a dveří  
 RO Seal pt. ferestre si usi  
 HU Seal az ablakok és ajtók  
 ES Sellar para ventanas y puertas

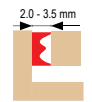

No.	Size / Rozmiar [mm]	L [m]	Type / Typ	Color / Kolor	
76755	9x4	150 (2x75)	E	biały	6
76765	9x4	150 (2x75)	E	brązowy	6

EN Seal for windows and doors  
 PL Uszczelka do okien i drzwi  
 DE Dichtung für Fenster und Türen  
 RU Уплотнители для окон и дверей  
 CZ Těsnění oken a dveří  
 RO Seal pt. ferestre si usi  
 HU Seal az ablakok és ajtók  
 ES Sellar para ventanas y puertas

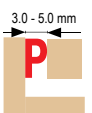

No.	Size / Rozmiar [mm]	L [m]	Type / Typ	Color / Kolor	
76756	9x5.5	100 (2x50)	P	biały	6
76766	9x5.5	100 (2x50)	P	brązowy	6

EN Self-adhesive pad for furniture  
 PL Podkładka samoprzylepna, korkowa  
 DE Klebegleiter für Möbel  
 RU Самоклеящая подкладка под мебель

CZ Podložka samolepící pod nábytek  
 RO Adeziv pad sub mobilier  
 HU Őntapadó, bútöríáb alátét  
 ES Arandela adhesiva bajo los muebles



No.	Size / Rozmiar [mm]	pcs / szt.	
74812	100x120	1	60/720

- EN Self-adhesive pad for furniture
- PL Podkładka samoprzylepna, antypoślizgowa
- DE Klebgleiter für Möbel
- RU Самоклеящая подкладка под мебель
- CZ Podložka samolepící pod nábytek
- RO Adeziv pad sub mobilier
- HU Őntapadó, bútorláb alátét
- ES Arandela adhesiva bajo los muebles



No.	Ø [mm]	pcs / szt.	
74816	10	24	60/720
74818	20	20	60/720
74820	28	12	60/720

- EN Self-adhesive pad for furniture
- PL Podkładka samoprzylepna z włókniny
- DE Klebgleiter für Möbel
- RU Самоклеящая подкладка под мебель
- CZ Podložka samolepící pod nábytek
- RO Adeziv pad sub mobilier
- HU Őntapadó, bútorláb alátét
- ES Arandela adhesiva bajo los muebles



No.	Ø [mm]	pcs / szt.	
74831	20	20	60/720
74833	28	12	60/720
74835	40	4	60/720

- EN Self-adhesive pad for furniture
- PL Podkładka samoprzylepna z włókniny
- DE Klebgleiter für Möbel
- RU Самоклеящая подкладка под мебель
- CZ Podložka samolepící pod nábytek
- RO Adeziv pad sub mobilier
- HU Őntapadó, bútorláb alátét
- ES Arandela adhesiva bajo los muebles



No.	Size / Rozmiar [mm]	pcs / szt.	
74841	20x20	20	60/720
74843	28x28	12	60/720

- EN Self-adhesive pad for furniture
- PL Podkładka samoprzylepna z włókniny
- DE Klebgleiter für Möbel
- RU Самоклеящая подкладка под мебель
- CZ Podložka samolepící pod nábytek
- RO Adeziv pad sub mobilier
- HU Őntapadó, bútorláb alátét
- ES Arandela adhesiva bajo los muebles



No.	Size / Rozmiar [mm]	pcs / szt.	
74849	100x120	1	60/720

- EN Self-adhesive pad for furniture
- PL Podkładka samoprzylepna, antypoślizgowa
- DE Klebgleiter für Möbel
- RU Самоклеящая подкладка под мебель
- CZ Podložka samolepící pod nábytek
- RO Adeziv pad sub mobilier
- HU Őntapadó, bútorláb alátét
- ES Arandela adhesiva bajo los muebles



No.	Size / Rozmiar [mm]	pcs / szt.	
74828	100x120	1	60/720

- EN Self-adhesive pad for furniture
- PL Podkładka samoprzylepna z włókniny mix
- DE Klebgleiter für Möbel
- RU Самоклеящая подкладка под мебель
- CZ Podložka samolepící pod nábytek
- RO Adeziv pad sub mobilier
- HU Őntapadó, bútorláb alátét
- ES Arandela adhesiva bajo los muebles



No.	Ø [mm]	pcs / szt.	
74838	20, 38	12	60/720

- EN Self-adhesive pad for furniture
- PL Podkładka samoprzylepna z włókniny mix
- DE Klebgleiter für Möbel
- RU Самоклеящая подкладка под мебель
- CZ Podložka samolepící pod nábytek
- RO Adeziv pad sub mobilier
- HU Őntapadó, bútorláb alátét
- ES Arandela adhesiva bajo los muebles



No.	Size / Rozmiar [mm]	pcs / szt.	
74846	20x45	10	60/720

- EN Self-adhesive pad for furniture
- PL Podkładka samoprzylepna z włókniny mix
- DE Klebgleiter für Möbel
- RU Самоклеящая подкладка под мебель
- CZ Podložka samolepící pod nábytek
- RO Adeziv pad sub mobilier
- HU Őntapadó, bútorláb alátét
- ES Arandela adhesiva bajo los muebles



No.	Ø [mm]	pcs / szt.	
74858	20, 38	12	60/720



EN Self-adhesive pad for furniture  
 PL Podkładka samoprzylepna z włókniny  
 DE Klebgleiter für Möbel  
 RU Самоклеящая подкладка под мебель  
 CZ Podložka samolepící pod nábytek  
 RO Adeziv pad sub mobilier  
 HU Öntapadó, bútorláb alátét  
 ES Arandela adhesiva bajo los muebles



No.	Size / Rozmiar [mm]	pcs / szt.	
74861	20x20	20	60/720
74863	28x28	12	60/720

EN Self-adhesive pad for furniture  
 PL Podkładka samoprzylepna z włókniny  
 DE Klebgleiter für Möbel  
 RU Самоклеящая подкладка под мебель  
 CZ Podložka samolepící pod nábytek  
 RO Adeziv pad sub mobilier  
 HU Öntapadó, bútorláb alátét  
 ES Arandela adhesiva bajo los muebles

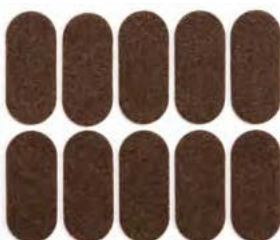

No.	Size / Rozmiar [mm]	pcs / szt.	
74866	20x45	10	60/720

EN Self-adhesive pad for furniture  
 PL Podkładka samoprzylepna, antypoślizgowa  
 DE Klebgleiter für Möbel  
 RU Самоклеящая подкладка под мебель  
 CZ Podložka samolepící pod nábytek  
 RO Adeziv pad sub mobilier  
 HU Öntapadó, bútorláb alátét  
 ES Arandela adhesiva bajo los muebles

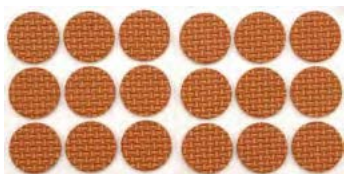

No.	Ø [mm]	pcs / szt.	
74882	25	18	24/432

EN Self-adhesive silicone pad for furniture  
 PL Podkładka samoprzylepna, silikonowa  
 DE Klebgleiter für Möbel  
 RU Самоклеящая подкладка под мебель  
 CZ Podložka samolepící pod nábytek  
 RO Adeziv pad sub mobilier  
 HU Öntapadó, bútorláb alátét  
 ES Arandela adhesiva bajo los muebles



No.	Ø [mm]	pcs / szt.	
74910	8	25	32/576
74911	10	20	32/576
74912	13	12	32/576
74913	15	9	32/576
74914	19	6	32/576

EN Self-adhesive pad for furniture  
 PL Podkładka samoprzylepna z włókniny  
 DE Klebgleiter für Möbel  
 RU Самоклеящая подкладка под мебель  
 CZ Podložka samolepící pod nábytek  
 RO Adeziv pad sub mobilier  
 HU Öntapadó, bútorláb alátét  
 ES Arandela adhesiva bajo los muebles



No.	Ø [mm]	pcs / szt.	
74851	20	20	60/720
74853	28	12	60/720
74855	40	4	60/720
74856	50	2	60/720

EN Self-adhesive pad for furniture  
 PL Podkładka samoprzylepna z włókniny  
 DE Klebgleiter für Möbel  
 RU Самоклеящая подкладка под мебель  
 CZ Podložka samolepící pod nábytek  
 RO Adeziv pad sub mobilier  
 HU Öntapadó, bútorláb alátét  
 ES Arandela adhesiva bajo los muebles



No.	Size / Rozmiar [mm]	pcs / szt.	
74869	100x120	1	60/720

EN Self-adhesive pad for furniture  
 PL Podkładka samoprzylepna, antypoślizgowa  
 DE Klebgleiter für Möbel  
 RU Самоклеящая подкладка под мебель  
 CZ Podložka samolepící pod nábytek  
 RO Adeziv pad sub mobilier  
 HU Öntapadó, bútorláb alátét  
 ES Arandela adhesiva bajo los muebles



No.	Ø [mm]	pcs / szt.	
74885	18	32	24/432
74886	25	18	24/432
74887	38	8	24/432



EN Felt & plastic furniture glides  
 PL Podkładki plastikowo-filcowe na gwóźdź  
 DE Kunststoff- und Filzgleiter zum Nageln

RU Подкладки пластиковые фильцевые на гвоздь  
 CZ Plastové podložky s plstí na hřebík  
 RO Şaibe din plastic-pâslă pt. cuie

HU Műanyag-filc alátét szőghéz  
 ES Arandelas de plástico y fieltro con clavo



**VOREL**

No.	Ø [mm]	pcs / szt.	
74920	17	16	16/288
74921	20	12	16/288
74922	24	12	16/288
74923	28	8	16/256
74924	30	8	16/256

EN Self-adhesive hanging hooks  
 PL Haczyki naścienne samoprzylepne  
 DE Selbstklebende Wandhaken  
 RU Крючки настенные на липучках  
 CZ Háčky nástěnné samolepící  
 RO Cârîige perete autocolante  
 HU Műanyag, fali kampó, öntapadós  
 ES Ganchos adhesivos para pared



**VOREL**

No.	Max. load capacity / Maks. obciążenie [kg]	pcs / szt.	
74730	1	3	12/144

EN Self-adhesive hanging hooks  
 PL Haczyki naścienne samoprzylepne  
 DE Selbstklebende Wandhaken  
 RU Крючки настенные на липучках  
 CZ Háčky nástěnné samolepící  
 RO Cârîige perete autocolante  
 HU Műanyag, fali kampó, öntapadós  
 ES Ganchos adhesivos para pared



**VOREL**

No.	Max. load capacity / Maks. obciążenie [kg]	pcs / szt.	
74731	0.8	3	18/216

EN Self-adhesive hanging hooks  
 PL Haczyki naścienne samoprzylepne  
 DE Selbstklebende Wandhaken  
 RU Крючки настенные на липучках  
 CZ Háčky nástěnné samolepící  
 RO Cârîige perete autocolante  
 HU Műanyag, fali kampó, öntapadós  
 ES Ganchos adhesivos para pared

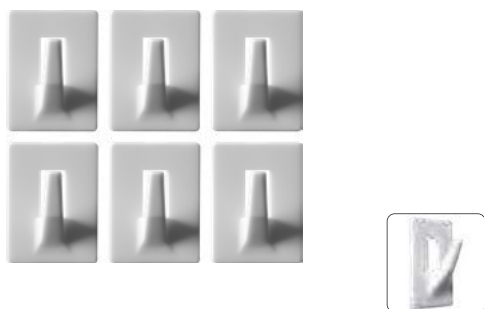

**VOREL**

No.	Max. load capacity / Maks. obciążenie [kg]	pcs / szt.	
74734	0.4	6	12/192

21

EN Self-adhesive hanging hooks  
 PL Haczyki naścienne samoprzylepne  
 DE Selbstklebende Wandhaken  
 RU Крючки настенные на липучках  
 CZ Háčky nástěnné samolepící  
 RO Cârîige perete autocolante  
 HU Műanyag, fali kampó, öntapadós  
 ES Ganchos adhesivos para pared

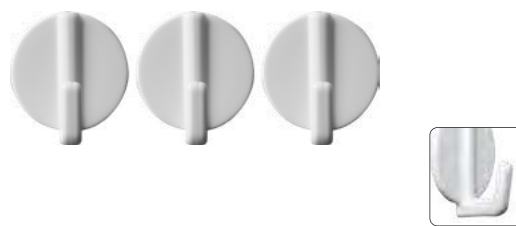

**VOREL**

No.	Max. load capacity / Maks. obciążenie [kg]	pcs / szt.	
74732	1	3	12/192

EN Self-adhesive hanging hooks  
 PL Haczyki naścienne samoprzylepne  
 DE Selbstklebende Wandhaken  
 RU Крючки настенные на липучках  
 CZ Háčky nástěnné samolepící  
 RO Cârîige perete autocolante  
 HU Műanyag, fali kampó, öntapadós  
 ES Ganchos adhesivos para pared

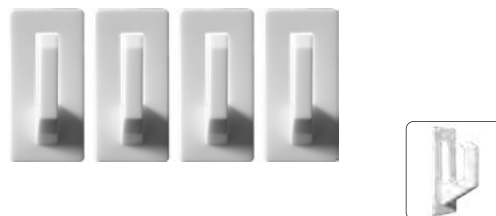

**VOREL**

No.	Max. load capacity / Maks. obciążenie [kg]	pcs / szt.	
74733	0.8	4	12/192

EN Self-adhesive hanging hooks  
 PL Haczyki naścienne samoprzylepne  
 DE Selbstklebende Wandhaken  
 RU Крючки настенные на липучках  
 CZ Háčky nástěnné samolepící  
 RO Cârîige perete autocolante  
 HU Műanyag, fali kampó, öntapadós  
 ES Ganchos adhesivos para pared

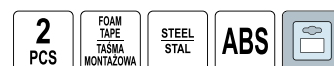

**VOREL**

No.	Max. load capacity / Maks. obciążenie [kg]	pcs / szt.	
74750	1	2	12/192

EN Self-adhesive hanging hooks  
 PL Haczyki naścienne samoprzylepne  
 DE Selbstklebende Wandhaken  
 RU Крючки настенные на липучках  
 CZ Háčky nástěnné samolepící  
 RO Cârîlige perete autocolante  
 HU Mûanyag, fali kampó, öntapadós  
 ES Ganchos adhesivos para pared



**VOREL**

No.	Max. load capacity / Maks. obciążenie [kg]	pcs / szt.	
74751	0.8	3	16/192

EN Self-adhesive hanging hooks  
 PL Haczyki naścienne samoprzylepne  
 DE Selbstklebende Wandhaken  
 RU Крючки настенные на липучках  
 CZ Háčky nástěnné samolepící  
 RO Cârîlige perete autocolante  
 HU Mûanyag, fali kampó, öntapadós  
 ES Ganchos adhesivos para pared



**VOREL**

No.	Max. load capacity / Maks. obciążenie [kg]	pcs / szt.	
74753	0.4	5	16/288

EN Wall hooks with screws  
 PL Haczyki naścienne na wkręt  
 DE Wandhaken zum Anschrauben  
 RU Крючки настенные на шурупах  
 CZ Háčky nástěnné na šroub  
 RO Cârîlige perete cu șurub  
 HU Mûanyag, fali kampó, csavaros  
 ES Ganchos atornillados para pared



**VOREL**

No.	Max. load capacity / Maks. obciążenie [kg]	pcs / szt.	
74766	8	3	12/192

EN Corner cushions  
 PL Ochraniacze na narożniki meblowe  
 DE Eckenschoner für Möbel  
 RU Насадки на углы мебели  
 CZ Chrániče na rohy nábytku  
 RO Protecție colțuri mobilă  
 HU Bûtor sarokvédô  
 ES Protectores esquineros para muebles

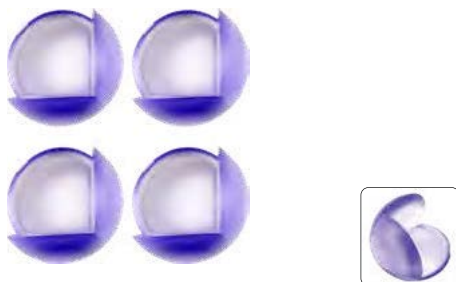

**VOREL**

No.	pcs / szt.	
74772	4	16/288

EN Self-adhesive hanging hooks  
 PL Haczyki naścienne samoprzylepne  
 DE Selbstklebende Wandhaken  
 RU Крючки настенные на липучках  
 CZ Háčky nástěnné samolepící  
 RO Cârîlige perete autocolante  
 HU Mûanyag, fali kampó, öntapadós  
 ES Ganchos adhesivos para pared



**VOREL**

No.	Max. load capacity / Maks. obciążenie [kg]	pcs / szt.	
74752	1.2	3	18/216

EN Wall hooks with screws  
 PL Haczyki naścienne na wkręt  
 DE Wandhaken zum Anschrauben  
 RU Крючки настенные на шурупах  
 CZ Háčky nástěnné na šroub  
 RO Cârîlige perete cu șurub  
 HU Mûanyag, fali kampó, csavaros  
 ES Ganchos atornillados para pared



**VOREL**

No.	Max. load capacity / Maks. obciążenie [kg]	pcs / szt.	
74765	5	3	16/256

EN Corner cushions  
 PL Ochraniacze na narożniki meblowe  
 DE Eckenschoner für Möbel  
 RU Насадки на углы мебели  
 CZ Chrániče na rohy nábytku  
 RO Protecție colțuri mobilă  
 HU Bûtor sarokvédô  
 ES Protectores esquineros para muebles



**VOREL**

No.	pcs / szt.	
74771	4	16/288

EN Corner cushions  
 PL Ochraniacze na narożniki meblowe  
 DE Eckenschoner für Möbel  
 RU Насадки на углы мебели  
 CZ Chrániče na rohy nábytku  
 RO Protecție colțuri mobilă  
 HU Bûtor sarokvédô  
 ES Protectores esquineros para muebles



**VOREL**

No.	pcs / szt.	
74773	4	12/144

EN Multi-purpose latches  
 PL Zabezpieczenie otwarcia drzwi meblowych  
 DE Schutzsicherung gegen das Öffnen der Möbeltüren  
 RU Блокатор открывания дверей мебели  
 CZ Pojistka proti otevření nábytkových dveří  
 RO Protecție deschidere ușii mobilă  
 HU Bútorajtó-útköző  
 ES Protectores para las portezuelas de muebles para prevenir su apertura



No.	pcs / szt.	
74775	2	16/256

EN Multi-purpose latches  
 PL Zabezpieczenie otwarcia drzwi meblowych  
 DE Schutzsicherung gegen das Öffnen der Möbeltüren  
 RU Блокатор открывания дверей мебели  
 CZ Pojistka proti otevření nábytkových dveří  
 RO Protecție deschidere ușii mobilă  
 HU Bútorajtó-útköző  
 ES Protectores para las portezuelas de muebles para prevenir su apertura

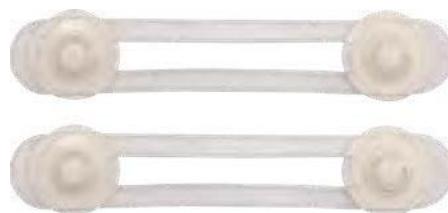

No.	pcs / szt.	
74776	2	12/216

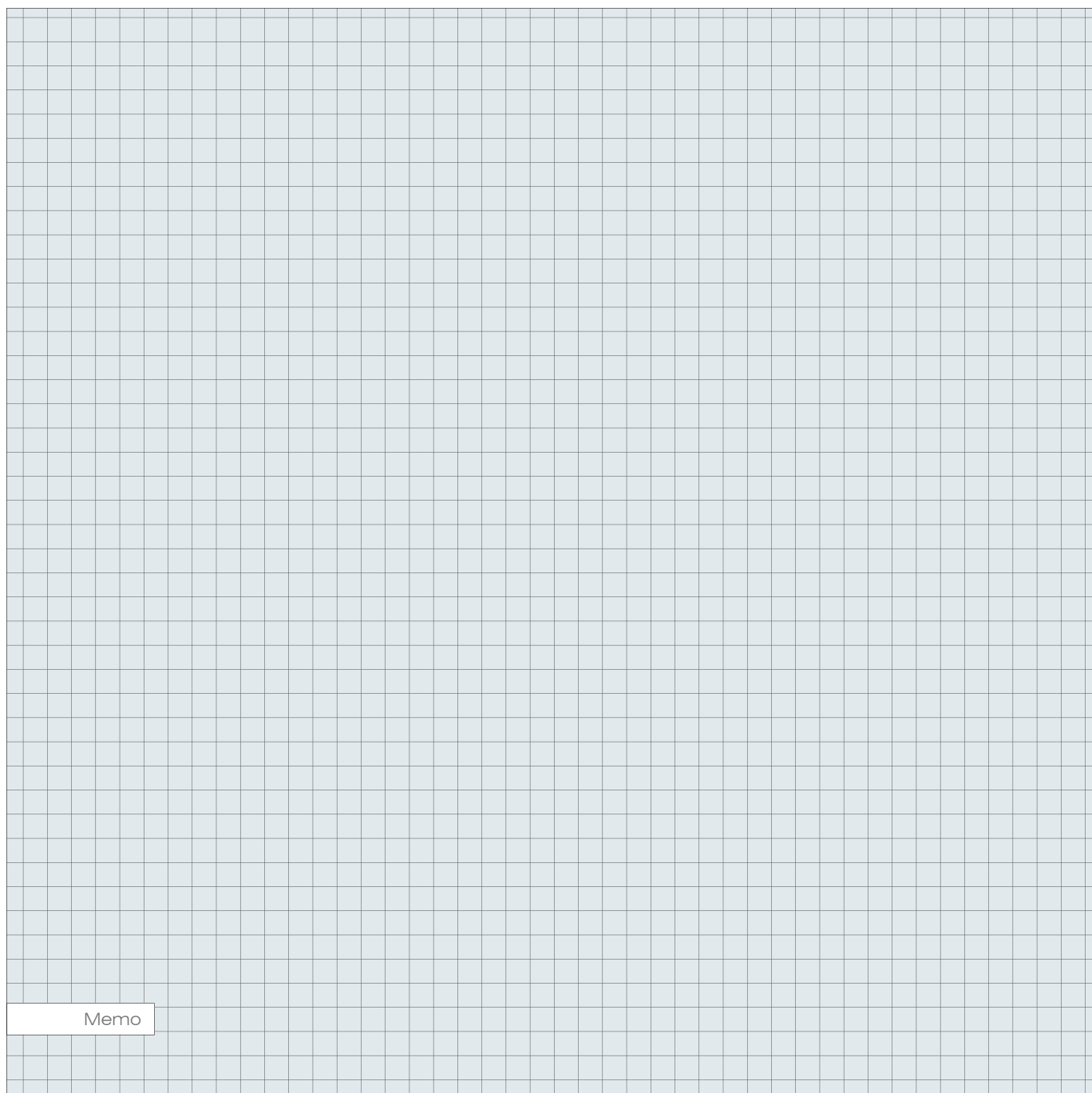

Memo



A large grid of graph paper for taking notes, consisting of 20 columns and 40 rows of small squares.





Memo

22

Health & safety products  
Artykuły BHP



<b>Gloves</b> Rękawice		358-361
<b>Goggles &amp; shields</b> Okulary i osłony przeciwodpryskowe		361-362
<b>Dust masks</b> Maski przeciwpyłowe		362-363
<b>Face shields</b> Osłony twarzy		363
<b>Knee pads</b> Nakolanniki		363-364
<b>Hearing protectors</b> Nauszniki przeciwhałasowe		365
<b>Safety helmets</b> Kaski ochronne		365

<b>Rain boots</b> Kalosze		365-366
<b>Working shoes</b> Buty robocze		366
<b>Safety sandals</b> Sandaly robocze		366
<b>Shoes accessories</b> Akcesoria do obuwia		366-367
<b>Working clothes</b> Odzież robocza		367-369
<b>Hats</b> Czapki		367
<b>Safety vests</b> Kamizelki ostrzegawcze		367
<b>Waterproof jackets</b> Kurtki przeciwdeszczowe		368



EN Working gloves  
 PL Rękawice robocze  
 DE Arbeitshandschuhe  
 RU Рабочие перчатки  
 CZ Pracovní rukavice  
 RO Mănuși de lucru  
 HU Munkakesztyű  
 ES Guantes de trabajo



**8**  
 SIZE / ROZMIAR

POLYESTER  
 POLYESTER

COTTON  
 BAWELNA

PVC

✕

No.	Size / Rozmiar	
74094	8	240

EN Working gloves  
 PL Rękawice robocze  
 DE Arbeitshandschuhe  
 RU Рабочие перчатки  
 CZ Pracovní rukavice  
 RO Mănuși de lucru  
 HU Munkakesztyű  
 ES Guantes de trabajo



**8**  
 SIZE / ROZMIAR

COTTON  
 BAWELNA

PVC

✕

No.	Size / Rozmiar	
74102	8	10/240

EN Working gloves  
 PL Rękawice robocze  
 DE Arbeitshandschuhe  
 RU Рабочие перчатки  
 CZ Pracovní rukavice  
 RO Mănuși de lucru  
 HU Munkakesztyű  
 ES Guantes de trabajo



**10**  
 SIZE / ROZMIAR

POLYESTER  
 POLYESTER

COTTON  
 BAWELNA

PVC

✕

No.	Size / Rozmiar	
74108	10	240

EN Working gloves  
 PL Rękawice robocze  
 DE Arbeitshandschuhe  
 RU Рабочие перчатки  
 CZ Pracovní rukavice  
 RO Mănuși de lucru  
 HU Munkakesztyű  
 ES Guantes de trabajo



No.	Size / Rozmiar	
74126	8	12/300
74132	9	12/300

EN Working gloves  
 PL Rękawice robocze  
 DE Arbeitshandschuhe  
 RU Рабочие перчатки  
 CZ Pracovní rukavice  
 RO Mănuși de lucru  
 HU Munkakesztyű  
 ES Guantes de trabajo



**10**  
 SIZE / ROZMIAR

COTTON  
 BAWELNA

PVC

☞



No.	Size / Rozmiar	
74100	10	12/300

EN Working gloves  
 PL Rękawice robocze  
 DE Arbeitshandschuhe  
 RU Рабочие перчатки  
 CZ Pracovní rukavice  
 RO Mănuși de lucru  
 HU Munkakesztyű  
 ES Guantes de trabajo



**10**  
 SIZE / ROZMIAR

POLYESTER  
 POLYESTER

COTTON  
 BAWELNA

PVC

✕

No.	Size / Rozmiar	
74104	10	10/240

EN Working gloves  
 PL Rękawice robocze  
 DE Arbeitshandschuhe  
 RU Рабочие перчатки  
 CZ Pracovní rukavice  
 RO Mănuși de lucru  
 HU Munkakesztyű  
 ES Guantes de trabajo



POLYESTER  
 POLYESTER

PU

☞



No.	Size / Rozmiar	
74125	8	12/300
74130	9	12/300
74131	10	12/300



POLYESTER  
 POLYESTER

PU

☞



EN Working gloves  
 PL Rękawice robocze  
 DE Arbeitshandschuhe  
 RU Рабочие перчатки  
 CZ Pracovní rukavice  
 RO Mănuși de lucru  
 HU Munkakesztyű  
 ES Guantes de trabajo



No.	Size / Rozmiar	
74127	8	12/300
74134	9	12/300
74135	10	12/300



EN Working gloves  
 PL Rękawice robocze  
 DE Arbeitshandschuhe  
 RU Рабочие перчатки  
 CZ Pracovní rukavice  
 RO Mănuși de lucru  
 HU Munkakesztyű  
 ES Guantes de trabajo



No.	Size / Rozmiar	
74128	8	12/300
74136	9	12/300
74137	10	12/300

EN Gardening gloves  
 PL Rękawice ogrodnicze  
 DE Arbeitshandschuh  
 RU Перчатки  
 CZ Pracovní rukavice  
 RO Mănuși  
 HU Védőkesztyű  
 ES Guantes



No.	Size / Rozmiar	
74117	8	50/1000

EN Gardening gloves  
 PL Rękawice ogrodnicze  
 DE Arbeitshandschuh  
 RU Перчатки  
 CZ Pracovní rukavice  
 RO Mănuși  
 HU Védőkesztyű  
 ES Guantes



No.	Size / Rozmiar	
74121	8	50/1000

EN Gardening gloves  
 PL Rękawice ogrodnicze  
 DE Arbeitshandschuh  
 RU Перчатки  
 CZ Pracovní rukavice  
 RO Mănuși  
 HU Védőkesztyű  
 ES Guantes



No.	Size / Rozmiar	
74123	8	50/1000

EN Gardening gloves  
 PL Rękawice ogrodnicze  
 DE Arbeitshandschuh  
 RU Перчатки  
 CZ Pracovní rukavice  
 RO Mănuși  
 HU Védőkesztyű  
 ES Guantes



No.	Size / Rozmiar	
74113	8	50/1000

EN Gardening gloves  
 PL Rękawice ogrodnicze  
 DE Arbeitshandschuh  
 RU Перчатки  
 CZ Pracovní rukavice  
 RO Mănuși  
 HU Védőkesztyű  
 ES Guantes



No.	Size / Rozmiar	
74115	8	50/1000

EN Working gloves  
 PL Rękawice robocze  
 DE Arbeitshandschuhe  
 RU Рабочие перчатки  
 CZ Pracovní rukavice  
 RO Mănuși de lucru  
 HU Munkakesztyű  
 ES Guantes de trabajo



No.	Size / Rozmiar	
74150	10	12/120

EN Working gloves  
 PL Rękawice robocze  
 DE Arbeitshandschuhe  
 RU Рабочие перчатки  
 CZ Pracovní rukavice  
 RO Mănuși de lucru  
 HU Munkakesztyű  
 ES Guantes de trabajo



No.	Size / Rozmiar	
74160	10.5	12/120

EN Working gloves  
 PL Rękawice robocze  
 DE Arbeitshandschuhe  
 RU Рабочие перчатки  
 CZ Pracovní rukavice  
 RO Mănuși de lucru  
 HU Munkakesztyű  
 ES Guantes de trabajo

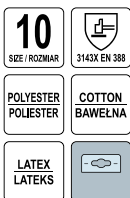

No.	Size / Rozmiar	
74146	10	12/120

EN Working gloves  
 PL Rękawice robocze  
 DE Arbeitshandschuhe  
 RU Рабочие перчатки  
 CZ Pracovní rukavice  
 RO Mănuși de lucru  
 HU Munkakesztyű  
 ES Guantes de trabajo

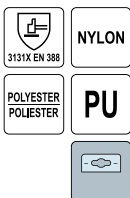

No.	Size / Rozmiar	
74079	9	12/120
74080	10	12/120

EN Working gloves  
 PL Rękawice robocze  
 DE Arbeitshandschuhe  
 RU Рабочие перчатки  
 CZ Pracovní rukavice  
 RO Mănuși de lucru  
 HU Munkakesztyű  
 ES Guantes de trabajo



No.	Size / Rozmiar	
74151	10	12/120

EN Working gloves  
 PL Rękawice robocze  
 DE Arbeitshandschuhe  
 RU Рабочие перчатки  
 CZ Pracovní rukavice  
 RO Mănuși de lucru  
 HU Munkakesztyű  
 ES Guantes de trabajo

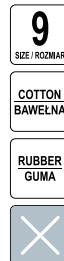

No.	Size / Rozmiar	
74162	9	600

EN Working gloves  
 PL Rękawice robocze  
 DE Arbeitshandschuhe  
 RU Рабочие перчатки  
 CZ Pracovní rukavice  
 RO Mănuși de lucru  
 HU Munkakesztyű  
 ES Guantes de trabajo

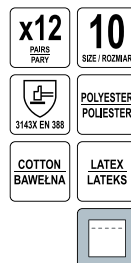

No.	Size / Rozmiar	Pairs / Pary	
74145	10	12	10

EN Working gloves  
 PL Rękawice robocze  
 DE Arbeitshandschuhe  
 RU Рабочие перчатки  
 CZ Pracovní rukavice  
 RO Mănuși de lucru  
 HU Munkakesztyű  
 ES Guantes de trabajo



No.	Size / Rozmiar	Pairs / Pary	
74077	9	12	10
74078	10	12	10

EN Insulated gloves  
 PL Rękawice robocze ocieplane  
 DE Arbeitshandschuh  
 RU Перчатки  
 CZ Pracovní rukavice  
 RO Mănuși  
 HU Védőkesztyű  
 ES Guantes



**10**  
 SIZE / ROZMIAR

2231 EN 388

POLYESTER  
 POLYESTER

LATEX  
 LATEKS



No.	Size / Rozmiar	
74149	10	12/120

EN Assembly gloves  
 PL Rękawice ochronne  
 DE Schutzhandschuhe  
 RU Защитные перчатки  
 CZ Ochranné rukavice  
 RO Mănuși protecție  
 HU Védőkesztyű  
 ES Guantes de protección



**10**  
 SIZE / ROZMIAR

SYNTHETIC  
 LEATHER  
 SZTUCZNA  
 SKÓRA

COTTON  
 BAWELNA



No.	Size / Rozmiar	
74060	10	10/120

EN Polycarbonate protection shield  
 PL Osłona twarzy przeciwdpryskowa  
 DE Gesichtsschutz  
 RU Маска защитная  
 CZ Ochranná přilba  
 RO Masca protecție  
 HU Hegesztősisak  
 ES Pantalla protectora antipedacitos



**1**  
 OPTICAL CLASS  
 KLASA OPTYCZNA

PC

No.		
74459		25/50

EN Safety glasses  
 PL Okulary ochronne  
 DE Schutzbrille  
 RU Очки защитные открытые  
 CZ Ochranné brýle  
 RO Ochelari pt. protecție  
 HU Védőszemüveg  
 ES Gafas protectoras



**1**  
 OPTICAL CLASS  
 KLASA OPTYCZNA

PC



No.	Type / Typ	
74501	TVS	8/80

EN Insulated gloves  
 PL Rękawice ocieplane  
 DE Isolierhandschuhe  
 RU Утепленные перчатки  
 CZ Zimní rukavice  
 RO Mănuși izolate  
 HU Szigetelt kesztyű  
 ES Guantes aislados



**11**  
 SIZE / ROZMIAR

COTTON  
 BAWELNA



No.	Size / Rozmiar	
74003	11	10/120

EN Working gloves  
 PL Rękawice robocze  
 DE Arbeitshandschuhe  
 RU Рабочие перчатки  
 CZ Pracovní rukavice  
 RO Mănuși de lucru  
 HU Munkakesztyű  
 ES Guantes de trabajo



3131X EN 388

NYLON

POLYESTER  
 POLYESTER

PU



No.	Size / Rozmiar	
74081	9	12/120
74082	10	12/120

EN Polycarbonate protection shield  
 PL Osłona twarzy przeciwdpryskowa  
 DE Gesichtsschutz  
 RU Маска защитная  
 CZ Ochranná přilba  
 RO Masca protecție  
 HU Hegesztősisak  
 ES Pantalla protectora antipedacitos



**1**  
 OPTICAL CLASS  
 KLASA OPTYCZNA

PC

No.		
74460		20

EN Safety glasses  
 PL Okulary ochronne  
 DE Schutzbrille  
 RU Очки защитные открытые  
 CZ Ochranné brýle  
 RO Ochelari pt. protecție  
 HU Védőszemüveg  
 ES Gafas protectoras



**1**  
 OPTICAL CLASS  
 KLASA OPTYCZNA

PC



No.	Type / Typ	
74505	STD SG-007	12/240

EN Safety glasses  
 PL Okulary ochronne  
 DE Schutzbrille  
 RU Очки защитные открытые  
 CZ Ochranné brýle  
 RO Ochelari pt. protectie  
 HU Védőszemüveg  
 ES Gafas protectoras



No.	Type / Typ	
74503	DY-8525	12/240

EN Safety glasses  
 PL Okulary ochronne  
 DE Schutzbrille  
 RU Очки защитные открытые  
 CZ Ochranné brýle  
 RO Ochelari pt. protectie  
 HU Védőszemüveg  
 ES Gafas protectoras



No.	Type / Typ	
74508	HF-103	10/120

EN Disposable dust masks  
 PL Półmaski filtrujące jednorazowe  
 DE Atemschutzmaske  
 RU Респиратор противопылевой одноразовый  
 CZ Protiprašná maska  
 RO Masca praf  
 HU Eldobható porvédőmaszk  
 ES Mascarilla desechable para protección contra polvo



No.	pcs / szt.	
74540	5	50/50

EN Disposable dust masks  
 PL Półmaski filtrujące jednorazowe  
 DE Atemschutzmaske  
 RU Респиратор противопылевой одноразовый  
 CZ Protiprašná maska  
 RO Masca praf  
 HU Eldobható porvédőmaszk  
 ES Mascarilla desechable para protección contra polvo



No.	pcs / szt.	
74542	5	50/50

EN Safety glasses  
 PL Okulary ochronne  
 DE Schutzbrille  
 RU Очки защитные открытые  
 CZ Ochranné brýle  
 RO Ochelari pt. protectie  
 HU Védőszemüveg  
 ES Gafas protectoras



No.	Type / Typ	
74504	DY-8526	15/150

EN Safety glasses  
 PL Okulary ochronne  
 DE Schutzbrille  
 RU Очки защитные открытые  
 CZ Ochranné brýle  
 RO Ochelari pt. protectie  
 HU Védőszemüveg  
 ES Gafas protectoras



No.	Type / Typ	
74509	HF-105	10/100

EN Disposable dust masks  
 PL Półmaski filtrujące jednorazowe  
 DE Atemschutzmaske  
 RU Респиратор противопылевой одноразовый  
 CZ Protiprašná maska  
 RO Masca praf  
 HU Eldobható porvédőmaszk  
 ES Mascarilla desechable para protección contra polvo



No.	pcs / szt.	
74541	5	15/50

EN Disposable dust masks  
 PL Półmaski filtrujące jednorazowe  
 DE Atemschutzmaske  
 RU Респиратор противопылевой одноразовый  
 CZ Protiprašná maska  
 RO Masca praf  
 HU Eldobható porvédőmaszk  
 ES Mascarilla desechable para protección contra polvo



No.	pcs / szt.	
74543	5	15/50



EN Anti pollution mask  
 PL Półmaska antysmogowa  
 DE Atemschutzmaske-Smogmaske  
 RU Антисмоговая полумаска  
 CZ Ochranná maska proti znečišťování ovzduší  
 RO Masca antipoluare  
 HU Eldobható porvédőmaszk, szelepes  
 ES Mascarilla desechable para



**VOREL**

No.	Type / Typ	
74555	antysmogowa, VZ/PZ	50

EN Face shield  
 PL Osłona siatkowa twarzy z nagłowiem  
 DE Gesichtsschutz mit Maschenvisier  
 RU Сетчатая защитная маска с обвязкой для головы  
 CZ Síťová ochrana tváře s postrojem  
 RO Vizor protecție față  
 HU Hálós arcvédő  
 ES Pantalla con visor de malla metálica



**FLO**

No.		
74468		25

EN Replacement visor  
 PL Wymienna osłona  
 DE Ersatz-Visier  
 RU Заменяемая защита  
 CZ Náhradní hledí  
 RO Protecție schimbabilă  
 HU Csere pajzs arcvédőhöz  
 ES Visera de repuesto



No.	Size / Rozmiar [mm]	Type / Typ	For / Dla	
74466	350x200	OT 1-N	74460	10/100

EN Face shield with PC visor  
 PL Przyłbica z osłoną wymienną  
 DE Gesichtsschutz mit austauschbarer Visier  
 RU Шлем с заменяемой защитой  
 CZ Štít s vyměnitelným krytem  
 RO Vizieră cu protecție schimbabilă  
 HU Arcvédő cserélhető pajzsral  
 ES Antifaz con protección reemplazable

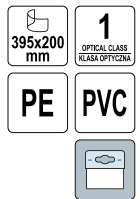

**VOREL**

No.		
74471		25

EN Face shield with steel mesh and ear muff  
 PL Przyłbica z osłoną wymienną i nausznikami przeciwhałasowymi  
 DE Gesichtsschutz mit austauschbarem Visier und Gehörschutz  
 RU Шлем с заменяемой защитой и наушниками против шума  
 CZ Štít s vyměnitelným krytem a chrániči proti hluku  
 RO Vizieră cu protecție schimbabilă și căști de protecție antizgomot  
 HU Arcvédő cserélhető pajzsral és fülvédő kagylóval  
 ES Antifaz con protección reemplazable y protectores de oídos



**VOREL**

No.		
74462		40

EN Knee pads  
 PL Nakolanniki  
 DE Knieschützer  
 RU Наколенники  
 CZ Chrániče kolen  
 RO Genunchiere  
 HU Térdvédő  
 ES Rodilleras



No.		
74600		50

EN Knee pads  
 PL Nakolanniki  
 DE Knieschützer  
 RU Наколенники  
 CZ Chrániče kolen  
 RO Genunchiere  
 HU Térdvédő  
 ES Rodilleras



No. 74610 20

EN Knee pads  
 PL Nakolanniki  
 DE Knieschützer  
 RU Наколенники  
 CZ Chrániče kolen  
 RO Genunchiere  
 HU Térdvédő  
 ES Rodilleras



**VOREL**  
 No. 74624 12/24

EN Knee pads  
 PL Nakolanniki  
 DE Knieschützer  
 RU Наколенники  
 CZ Chrániče kolen  
 RO Genunchiere  
 HU Térdvédő  
 ES Rodilleras



**VOREL**  
 No. 74602 6/36

EN Knee pads  
 PL Nakolanniki - wkładki  
 DE Knieschützer  
 RU Наколенники  
 CZ Chrániče kolen  
 RO Genunchiere  
 HU Térdvédő  
 ES Rodilleras

**VOREL**  
 No. 74595 60

EN Knee pads  
 PL Nakolanniki  
 DE Knieschützer  
 RU Наколенники  
 CZ Chrániče kolen  
 RO Genunchiere  
 HU Térdvédő  
 ES Rodilleras



No. 74622 50

EN Knee pads  
 PL Nakolanniki  
 DE Knieschützer  
 RU Наколенники  
 CZ Chrániče kolen  
 RO Genunchiere  
 HU Térdvédő  
 ES Rodilleras



**VOREL**  
 No. 74601 24

EN Knee pads  
 PL Nakolanniki  
 DE Knieschützer  
 RU Наколенники  
 CZ Chrániče kolen  
 RO Genunchiere  
 HU Térdvédő  
 ES Rodilleras



**VOREL**  
 No. 74604 20

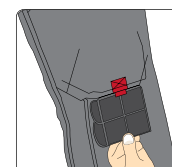

EN Safety earmuffs  
 PL Nauszniki przeciwhałasowe  
 DE Gehörschutz  
 RU Противошумные наушники  
 CZ Chrániče sluchu  
 RO Căști antifonice  
 HU Hallásvédő fültek  
 ES Auriculares de protección auditiva



No.		
74580		60

EN Safety helmet  
 PL Kask ochronny  
 DE Schutzhelm  
 RU Каска защитная  
 CZ Ochranná přilba  
 RO Cască de protecție  
 HU Védősisak  
 ES Casco de protección



No.	Color / Kolor	
74171	pomarańczowy	30
74172	żółty	30
74173	biały	30
74174	czerwony	30
74175	niebieski	30
74176	zielony	30

EN Men's rain boots  
 PL Kalosze męskie  
 DE Herren - Gummistiefel  
 RU Галоши мужские  
 CZ Pánské galoše  
 RO Cizme bărbați  
 HU Férfi gumicsizma  
 ES Chanclos para hombre



No.	Size / Rozmiar	
73937	41	5
73938	42	5
73939	43	5
73940	44	5
73941	45	5
73942	46	5
73943	47	5

EN Safety earmuffs  
 PL Nauszniki przeciwhałasowe  
 DE Gehörschutz  
 RU Противошумные наушники  
 CZ Chrániče sluchu  
 RO Căști antifonice  
 HU Hallásvédő fültek  
 ES Auriculares de protección auditiva



No.		
74581		10/60

EN Women's rain boots  
 PL Kalosze damskie  
 DE Damen - Gummistiefel  
 RU Галоши женские  
 CZ Dámské galoše  
 RO Cizme damă  
 HU Női gumicsizma  
 ES Chanclos para mujer



No.	Size / Rozmiar	
73931	36	7
73932	37	7
73933	38	7
73934	39	7
73935	40	7
73936	41	7

EN Women's rain boots  
 PL Kalosze damskie  
 DE Damen - Gummistiefel  
 RU Галоши женские  
 CZ Dámské galoše  
 RO Cizme damă  
 HU Női gumicsizma  
 ES Chanclos para mujer



No.	Size / Rozmiar	
73945	37	5
73946	38	5
73947	39	5

- EN Men's rain boots
- PL Kalosze męskie
- DE Herren - Gummistiefel
- RU Галоши мужские
- CZ Pánské galoše
- RO Cizme bărbați
- HU Férfi gumicsizma
- ES Chanclos para hombre



No.	Size / Rozmiar	
73950	41	5
73951	42	5
73952	43	5
73953	44	5
73954	45	5
73955	46	5

- EN Men's rain boots
- CZ Pánské galoše
- PL Kalosze męskie
- RO Cizme bărbați
- DE Herren - Gummistiefel
- HU Férfi gumicsizma
- RU Галоши мужские
- ES Chanclos para hombre



No.	Size / Rozmiar	
73966	40	5
73967	41	5
73968	42	5
73969	43	5
73970	44	5
73971	45	5
73972	46	5
73973	47	5

- EN Safety sandals
- PL Sandały robocze
- DE Arbeitshalbschuhe
- RU Полуботинки рабочие
- CZ Pracovní polobotky
- RO Bocanci de lucru
- HU Munkavédelmi félcipő
- ES Zapato de trabajo

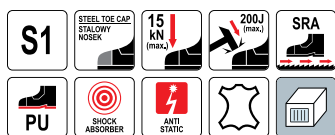

No.	Size / Rozmiar	Series / Seria	
72801	39	SALTA	10
72802	40	SALTA	10
72803	41	SALTA	10
72804	42	SALTA	10
72805	43	SALTA	10
72806	44	SALTA	10
72807	45	SALTA	10
72808	46	SALTA	10
72809	47	SALTA	10

- EN Felt PVC boots
- PL Buty gumowo-filcowe
- DE Gummistiefel mit Filtz
- RU Сапоги резиновые с войлоком
- CZ Holinky s filcem
- RO Cizme PVC
- HU Gumi - filc csizma
- ES Botas de goma fieltro



No.	Size / Rozmiar	
73958	40	5
73959	41	5
73960	42	5
73961	43	5
73962	44	5
73963	45	5
73964	46	5



- EN Oil spray
- PL Płynny tuszcz do obuwia
- DE Wartungs-Spray Schuhe
- RU Жидкий жир для обуви
- CZ Olejový spray na obuv
- RO Spray intretinere incaltaminte
- HU Cipőapoló olaj
- ES Aceite para botas



No.	Capacity / Pojemność [ml]	
72890	150	20

- EN Ravvivant spray
- PL Spray ożywiający kolor do nubuku i zamszu
- DE Wildleder und Nubuk Pflegespray
- RU Спрей освежающий цвет nubука и замши
- CZ Spray na semišovou obuv
- RO Spray revitalizant incaltaminte
- HU Nubukvelőrápoló spray
- ES Spray para suede



No.	Capacity / Pojemność [ml]	
72891	250	20



EN Antibacterial insole  
 PL Antybakteryjna wkładka do butów  
 DE Antibakterielle Einlage für Schuhe  
 RU Антибактериальная стелька  
 CZ Antibakteriální vložka do bot  
 RO Tălpiци antibacterieni  
 HU Antibakteriális cipőbetét  
 ES Plantilla antibacterial

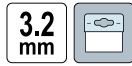

No.	Size / Rozmiar	Thickness / Grubość [mm]	
72683	39/40	3.2	50
72684	41/42	3.2	50
72685	43/44	3.2	50
72686	45/46	3.2	50

EN Winter hat  
 PL Czapka zimowa  
 DE Wintermütze  
 RU Зимняя шапка  
 CZ Zimní čepice  
 RO Căciulă iarnă  
 HU Téli sapka  
 ES Gorro de invierno



No.	Color / Kolor	
74231	szary	200

EN Winter hat  
 PL Czapka zimowa  
 DE Wintermütze  
 RU Зимняя шапка  
 CZ Zimní čepice  
 RO Căciulă iarnă  
 HU Téli sapka  
 ES Gorro de invierno



No.	Color / Kolor	
74233	żółty	200

EN Reflective vest  
 PL Kamizelka ostrzegawcza  
 DE Warnweste  
 RU Жилет безопасности  
 CZ Výstražná vesta  
 RO Vestă de avertizare  
 HU Fényvisszaverő mellény  
 ES chaleco reflectante



100% polyester  
 100% poliester

No.	Size / Rozmiar	Series / Seria	
74660	L	VEST-0	100
74661	XL	VEST-0	100
74662	XXL	VEST-0	100
74663	XXXL	VEST-0	100

EN Winter hat  
 PL Czapka zimowa  
 DE Wintermütze  
 RU Зимняя шапка  
 CZ Zimní čepice  
 RO Căciulă iarnă  
 HU Téli sapka  
 ES Gorro de invierno



No.	Color / Kolor	
74230	czarny	200

EN Winter hat  
 PL Czapka zimowa  
 DE Wintermütze  
 RU Зимняя шапка  
 CZ Zimní čepice  
 RO Căciulă iarnă  
 HU Téli sapka  
 ES Gorro de invierno



No.	Color / Kolor	
74232	ciemnoszary	200

EN Balaclava  
 PL Kominarka  
 DE Kapuzenmütze  
 RU Балаклава  
 CZ Kukla  
 RO Cagula  
 HU Simaszok  
 ES Pasamontañas



No.	Color / Kolor	
74240	ciemnobrazowy	120



- EN Reflective vest
- PL Kamizelka ostrzegawcza
- DE Warnweste
- RU Жилет безопасности
- CZ Výstražná vesta
- RO Vestă de avertizare
- HU Fényvisszaverő mellény
- ES chaleco reflectante



100% polyester  
100% poliester

No.	Size / Rozmiar	Series / Seria	
74664	L	VEST-G	100
74665	XL	VEST-G	100
74666	XXL	VEST-G	100
74667	XXXL	VEST-G	100

- EN Waterproof jacket
- PL Kurtka przeciwdeszczowa
- DE Regenjacke
- RU Куртка-дождевик
- CZ Bunda do deště
- RO Giacă impermeabilă
- HU Vízhatalan dzseki
- ES Chaqueta impermeable



70% PVC, 30% polyester  
70% PVC, 30% poliester



**CLOUDBURST**

No.	Size / Rozmiar	
74626	L	20
74627	XXL	20
74628	XXXL	20

- EN Raincoat
- PL Plaszcz przeciwdeszczowy
- DE Regenmantel
- RU Дождевик
- CZ Pláštěnka
- RO Pelerina ploaie
- HU Esőkabát
- ES Impermeable



70% PVC, 30% polyester  
70% PVC, 30% poliester



**CLOUDBURST**

No.	Size / Rozmiar	
74631	XL	10
74632	XXL	10
74633	XXXL	10

- EN Raincoat
- PL Plaszcz przeciwdeszczowy
- DE Regenmantel
- RU Дождевик
- CZ Pláštěnka
- RO Pelerina ploaie
- HU Esőkabát
- ES Impermeable



**NAVY COMPACT**

No.	Size / Rozmiar	
74653	L	20
74654	XL	20
74655	XXL	20

- EN Rainsuit
- PL Komplet przeciwdeszczowy
- DE Regenschutz-Set
- RU Противодждевой набор
- CZ Protidešťová sada
- RO Costum impermeabil
- HU Esővédő szett
- ES Juego impermeable



**NAVY COMPACT**

No.	Size / Rozmiar	
74657	L	20
74658	XL	20
74659	XXL	20

EN Rain suit military style  
 PL Komplet przeciwdeszczowy moro  
 DE Regenbekleidung militärischen Stil  
 RU Дождь костюмы военный стиль  
 CZ Oblek maskáčový do deště  
 RO Îmbrăcămintă de ploaie camuflaj  
 HU Eső ruházat  
 ES Ropa de lluvia camo



70% polyester, 30% PVC  
 70% polyester, 30% PVC

No.	Size / Rozmiar	
74646	L	20
74647	XXL	20

**MORO COMPACT**

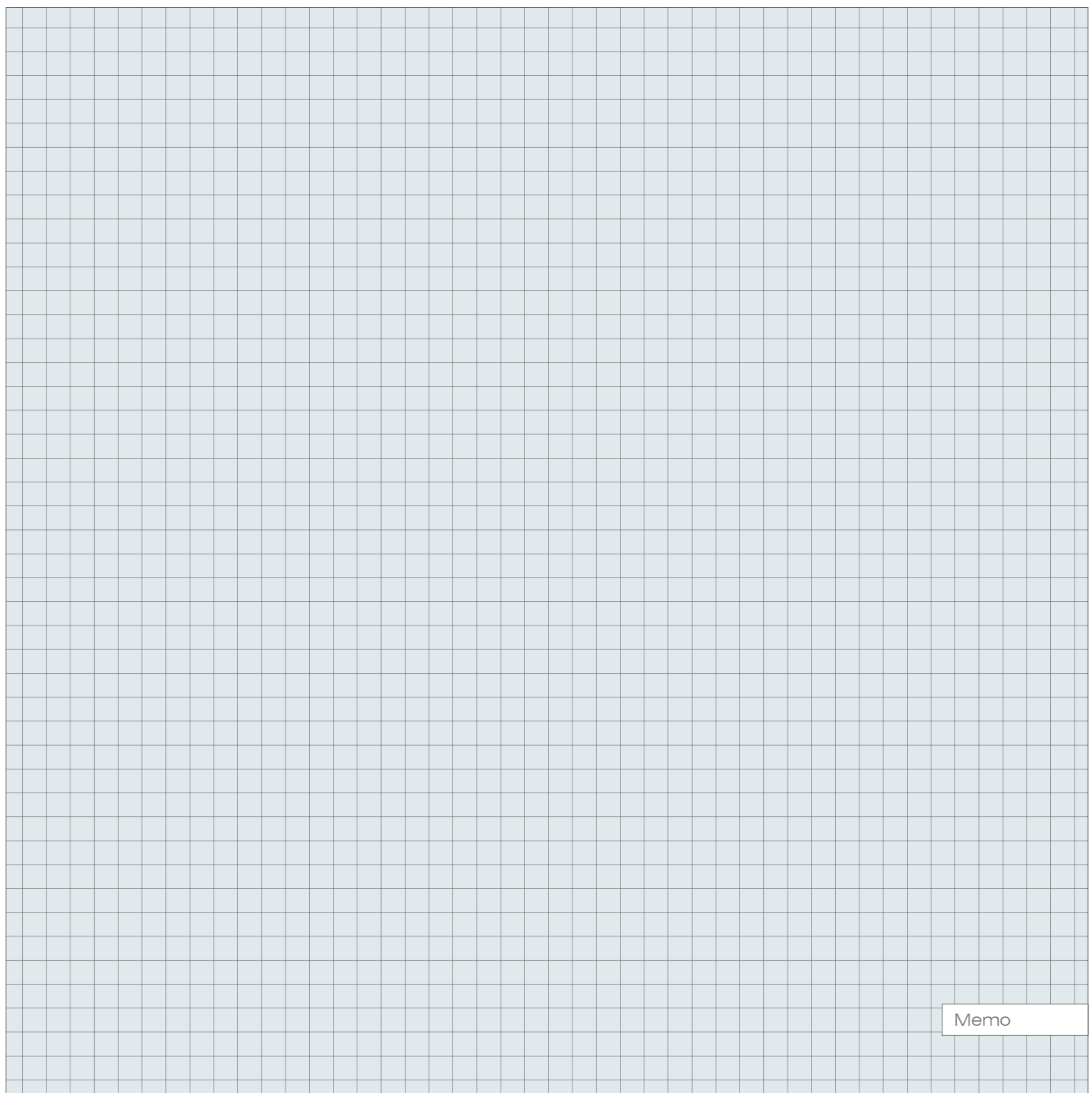

Memo



23

Electric products  
Artykuły elektryczne





**Extension cords & cable reels**  
**Przedłużacze listwowe**  
**i bębnowe**

.....372-374

**Extension cords French type**

Przedłużacze elektryczne z uziemieniem..... 372

**Extension cords**

Przedłużacze elektryczne bez uziemienia..... 373

**Cable reels French type**

Przedłużacze bębnowe z uziemieniem..... 374

**Travel adapters**  
**Adaptory podróżne**

.....374

**Adaptors**  
**Rozgałęźniki**

.....375

**Lamps**  
**Lampy**

.....375-383

**Halogen bulbs**

Żarniki do lamp halogenowych..... 375

**Workshop lamps**

Lampy warsztatowe..... 375

**LED flashlights**

Latarki diodowe..... 378

**Bicycle lamps**

Lampy rowerowe..... 380

**Night lamps**

Lampki nocne..... 380

**Insect killer lamps & accessories**

Lampy owadobójcze i akcesoria..... 380

EN Surge protector power strip  
 PL Listwa zasilająca przeciwprzepięciowa  
 DE Überspannungsschutzleiste  
 RU Колодка электрическая с защитой от перенапряжения  
 CZ Prodlužovací kabel s přepětovou ochranou  
 RO Prelungitor cu protectie  
 HU Túlfeszültségvédő elosztó  
 ES Regleta de protección contra sobretensiones

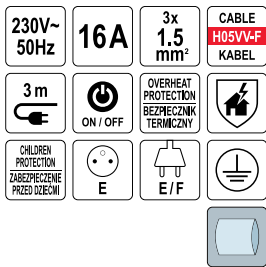

**STKOR**

No.	L [m]	☺	Socket type / Typ gniazda	📦
72370	3	5	E	30
72371	3	6	E	20

EN Surge protector power strip  
 PL Listwa zasilająca przeciwprzepięciowa  
 DE Überspannungsschutzleiste  
 RU Колодка электрическая с защитой от перенапряжения  
 CZ Prodlužovací kabel s přepětovou ochranou  
 RO Prelungitor cu protectie  
 HU Túlfeszültségvédő elosztó  
 ES Regleta de protección contra sobretensiones

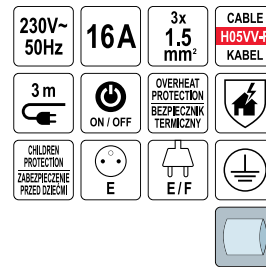

**STKOR**

No.	L [m]	☺	Socket type / Typ gniazda	📦
72372	3	5	E	30
72373	3	6	E	20

EN Extension cord  
 PL Przedłużacz elektryczny  
 DE Verlängerungsschnur  
 RU Удлинитель электрический  
 CZ Elektrický prodlužovač  
 RO Prelungitor electric  
 HU Elektromos hosszabbító  
 ES Extensión eléctrica



**LUND**

No.	L [m]	☺	Socket type / Typ gniazda	📦
72460	2	5	E	25



EN Extension cord  
 PL Przedłużacz elektryczny  
 DE Verlängerungskabel  
 RU Удлинитель электрический  
 CZ Elektrický prodlužovač  
 RO Prelungitor electric  
 HU Elektromos hosszabbító  
 ES Extensión eléctrica

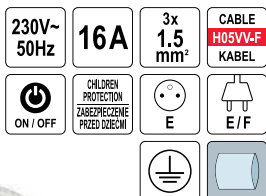

**STKOR**

No.	L [m]	☺	Socket type / Typ gniazda	📦
72350	1.5	3	E	40
72351	3.0	3	E	40
72352	5.0	3	E	30
72353	1.5	4	E	30
72354	3.0	4	E	30
72355	5.0	4	E	20
72356	1.5	5	E	30
72357	3.0	5	E	30
72358	5.0	5	E	20

EN Cord extension with earthing  
 PL Przedłużacz elektryczny z uziemieniem  
 DE Verlängerungskabel mit Erdung  
 RU Удлинитель электрический с заземлением  
 CZ Elektrický prodlužovač  
 RO Prelungitor electric  
 HU Elektromos hosszabbító  
 ES Extensión eléctrica

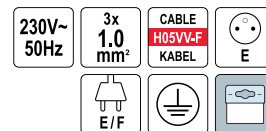

**VOREL**

No.	L [m]	☺	Socket type / Typ gniazda	📦
72500	1.5	3	E	30
72501	1.5	4	E	30
72504	3.0	3	E	30
72505	3.0	4	E	1/30
72506	3.0	5	E	1/30
72508	5.0	3	E	1/30
72509	5.0	4	E	30
72510	5.0	5	E	30

EN Cord extension with earthing  
 PL Przedłużacz elektryczny z uziemieniem  
 DE Verlängerungskabel mit Erdung  
 RU Удлинитель электрический с заземлением  
 CZ Elektrický prodloužovač  
 RO Prelungitor electric  
 HU Elektromos hosszabbító  
 ES Extensión eléctrica

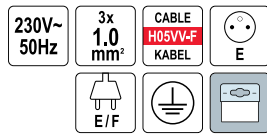

No.	L [m]	⊕	Socket type / Typ gniazda	📦
72615	1.5	3	E	12/48
72616	3.0	3	E	30
72617	5.0	3	E	12/48
72620	1.5	4	E	1/30
72621	3.0	4	E	12/48
72622	5.0	4	E	30

EN Cord extension with switch  
 PL Przedłużacz elektryczny z wyłącznikiem  
 DE Steckdosenleiste mit Schalter  
 RU Удлинитель электрический с выключателем  
 CZ Elektrický prodloužovač  
 RO Prelungitor electric  
 HU Elektromos hosszabbító  
 ES Extensión para arbol de navidad verde

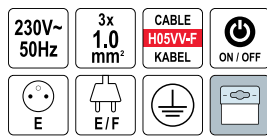

No.	L [m]	⊕	Socket type / Typ gniazda	📦
72625	1.5	3	E	30
72626	3.0	3	E	1/30
72627	5.0	3	E	30
72630	1.5	4	E	12/48
72631	3.0	4	E	30
72632	5.0	4	E	30

EN Garden extension cable  
 PL Przedłużacz  
 DE Gartenverlängerungskabel  
 RU Электроудлинитель  
 CZ Prodloužovací kabel zahradní  
 RO Prelungitor electric  
 HU Kerti hosszabbító  
 ES Cable de extensión para jardín



No.	L [m]	📦
82671	10	10
82673	20	10
82675	30	5
82677	40	5

EN Cord extension with switch  
 PL Przedłużacz elektryczny z wyłącznikiem  
 DE Steckdosenleiste mit Schalter  
 RU Удлинитель электрический с выключателем  
 CZ Elektrický prodloužovač  
 RO Prelungitor electric  
 HU Elektromos hosszabbító  
 ES Extensión para arbol de navidad verde

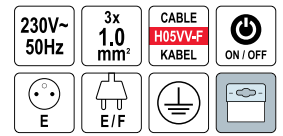

No.	L [m]	⊕	Socket type / Typ gniazda	📦
72524	1.5	3	E	30
72525	1.5	4	E	30
72526	1.5	5	E	30
72527	1.5	6	E	1/30
72528	3.0	3	E	30
72529	3.0	4	E	30
72530	3.0	5	E	30
72531	3.0	6	E	1/30
72532	5.0	3	E	12/48
72533	5.0	4	E	30
72534	5.0	5	E	30
72535	5.0	6	E	12/48

EN Cord extension without earthing  
 PL Przedłużacz elektryczny bez uziemienia  
 DE Steckdosenleiste ohne Zuleitung  
 RU Удлинитель электрический без заземления  
 CZ Elektrický prodloužovač  
 RO Prelungitor electric  
 HU Elektromos hosszabbító  
 ES Extensión eléctrica

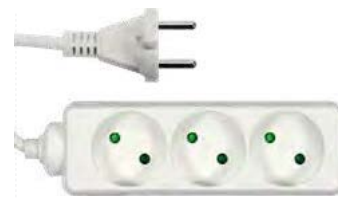
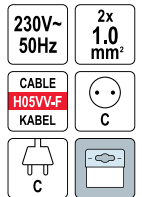

No.	L [m]	⊕	Socket type / Typ gniazda	📦
72484	1.5	3	C	30
72486	1.5	4	C	30
72489	3.0	3	C	30
72490	3.0	4	C	30
72493	5.0	3	C	30
72494	5.0	4	C	1/30

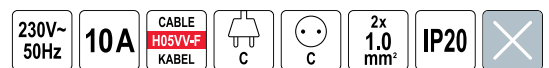

- EN Cable reel
- PL Przedłużacz bębnowy
- DE Kabeltrommel
- RU Удлинитель на катушке
- CZ Bubenový prodloužovač
- RO Prelungitor pe tambur
- HU Kábeldob
- ES Cable de prolongación de tambor



230V~50Hz

CABLE H05VV-F KABEL

OVERHEAT PROTECTION BEZPEČENÍK TERMICZNY

CHILDREN PROTECTION ZABEZPEČENIE PRZED DZIECI

E

E/F



No.	L [m]	Wire section area / Pole przekroju przewodu [mm <sup>2</sup> ]	Socket type / Typ gniazda	Box
82682	25	3Gx1.0	E	2
82684	40	3Gx1.0	E	2
82685	50	3Gx1.5	E	2

- EN Cable reel
- PL Przedłużacz bębnowy
- DE Kabeltrommel
- RU Удлинитель на катушке
- CZ Bubenový prodloužovač
- RO Prelungitor pe tambur
- HU Kábeldob
- ES Cable de prolongación de tambor



230V~50Hz

CABLE H05VV-F KABEL

OVERHEAT PROTECTION BEZPEČENÍK TERMICZNY

CHILDREN PROTECTION ZABEZPEČENIE PRZED DZIECI

E

E/F



No.	L [m]	Wire section area / Pole przekroju przewodu [mm <sup>2</sup> ]	Socket type / Typ gniazda	Box
82691	15	3Gx1.0	E	1
82692	25	3Gx1.0	E	1
82693	40	3Gx1.0	E	1
82694	50	3Gx1.5	E	1

- EN Travel adapter Europe to USA
- PL Adapter podróży Europa-USA
- DE Reiseadapter Europa-USA
- RU Дорожный адаптер-переходник Европа-США
- CZ Cestovní adaptér Evropa-USA
- RO Adaptor de călătorie din Europa-SUA
- HU Utazó adapter Európa-USA
- ES Adaptador de viaje Europa-EE.UU.

EURO

USA



No.	Socket type / Typ gniazda	Box
72441	F	100

- EN Cable reel
- PL Przedłużacz zwijany
- DE Einziehbares Verlängerungskabel
- RU Удлинитель электрический
- CZ Bubenový prodloužovač
- RO Prelungitor pe tambur
- HU Kábeldob
- ES Extensión eléctrica



230V~50Hz

CABLE H05VV-F KABEL

OVERHEAT PROTECTION BEZPEČENÍK TERMICZNY

CHILDREN PROTECTION ZABEZPEČENIE PRZED DZIECI

E

E/F



No.	L [m]	Wire section area / Pole przekroju przewodu [mm <sup>2</sup> ]	Socket type / Typ gniazda	Box
72570	15	3Gx1.0	E	4
72572	25	3Gx1.0	E	4
72573	30	3Gx1.5	E	4

- EN Travel adapter World to Europe
- PL Adapter podróży Świat-Europa
- DE Reiseadapter Welt-Europa
- RU Дорожный адаптер-переходник Мир-Европа
- CZ Cestovní adaptér Svět-Evropa
- RO Adaptor de călătorie World to Europa
- HU Utazó adapter Világ-Európa
- ES Adaptador de viaje Mundo-Europa

AUS

USA

EURO

UK



No.	Socket type / Typ gniazda	Box
72440	uniwersalne	100

- EN Travel adapter Europe to UK
- PL Adapter podróży Europa-UK
- DE Reiseadapter Europa-UK
- RU Дорожный адаптер-переходник Европа-Англия
- CZ Cestovní adaptér Evropa-UK
- RO Adaptor de călătorie din Europa-UK
- HU Utazó adapter Európa-UK
- ES Adaptador de viaje Europa-Gran Bretaña

EURO

UK



No.	Socket type / Typ gniazda	Box
72442	F	100



EN Adapter  
 PL Rozgałęźnik  
 DE Abzweigung  
 RU Разветвитель  
 CZ Rozdvojka  
 RO Splitter  
 HU Osztó  
 ES Enchufe múltiple

230V~  
50Hz

16A





No.	Icon	Socket type / Typ gniazda	Icon
72404	2	E	100

EN Adapter  
 PL Rozgałęźnik  
 DE Abzweigung  
 RU Разветвитель  
 CZ Rozdvojka  
 RO Splitter  
 HU Osztó  
 ES Enchufe múltiple

230V~  
50Hz

2.5  
A



No.	Icon	Socket type / Typ gniazda	Icon
72400	2	C	200
72401	3	C	20/100
72402	4	C	100

EN String floodlight set  
 PL Zestaw reflektorów  
 DE LED-Leuchten-Set  
 RU Набор светильников  
 CZ Sada reflektorů  
 RO Set proiector șir  
 HU Reflektorkészlet  
 ES Conjunto de focos

220-240V~  
50Hz

CRI  
80

5x

6W  
600lm

TOTAL  
30 W  
3000lm

5000K

20000 h

LINKABLE  
MOŽLIVOSŤ  
LÁČZENIA

CLIP HOOK  
KARABINCZYK

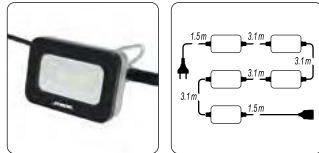
No.	Power / Moc [W]	Luminous flux / Strumień świetlny [lm]	Lifetime / Żywotność [h]	Icon
82861	6 x5	600 x5	20000	4

EN Adapter  
 PL Rozgałęźnik  
 DE Abzweigung  
 RU Разветвитель  
 CZ Rozdvojka  
 RO Splitter  
 HU Osztó  
 ES Enchufe múltiple

230V~  
50Hz

16A



No.	Icon	Socket type / Typ gniazda	Icon
72407	3	E	100

EN Halogen projector bulbs  
 PL Żarniki do lamp halogenowych  
 DE Halogenstab  
 RU Галогенная трубка  
 CZ Žárovka do halogenové lampy  
 RO Bec cu halogen pt. proiector  
 HU Halogén lámpaizzó  
 ES Filamentos de bombillas halogenas

2  
PCS

R7s



No.	Filament power / Moc żarnika halogenowego [W]	Luminous flux / Strumień świetlny [lm]	Lifetime / Żywotność [h]	Icon
82771	120	2200	1000	50/200
82772	400	8600	1000	50/200

EN String floodlight set  
 PL Zestaw reflektorów  
 DE LED-Leuchten-Set  
 RU Набор светильников  
 CZ Sada reflektorů  
 RO Set proiector șir  
 HU Reflektorkészlet  
 ES Conjunto de focos

220-240V~  
50Hz

CRI  
80

5x

9W  
900lm

TOTAL  
45 W  
4500lm

5000K

20000 h

LINKABLE  
MOŽLIVOSŤ  
LÁČZENIA

CLIP HOOK  
KARABINCZYK

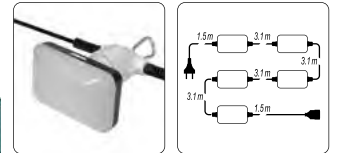
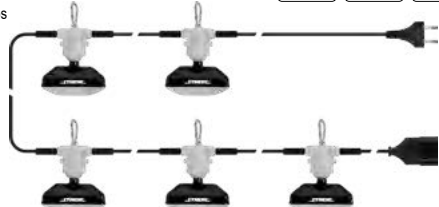
No.	Power / Moc [W]	Luminous flux / Strumień świetlny [lm]	Lifetime / Żywotność [h]	Icon
82863	9 x5	900 x5	20000	4

EN Workshop LED battery lamp  
 PL Diodowa lampa warsztatowa akumulatorowa  
 DE LED Akku-Werkstattlampe  
 RU Светодиодная беспроводная лампа  
 CZ Aku pracovní LED svítlna  
 RO Lampa portabilă cu acumulator leduri  
 HU Akkumulátoros LED szerelőlámpa  
 ES Lámpara de trabajo LED recargable



FRONT LIGHT  
LATARKA

5+3  
W

300/170  
lm

3.7 V  
2000mAh  
Li-ion

4h

3.5-5h

IP44

IK08

x1  
HOOK  
HAK

USB  
CHARGING  
LADOWANIE



No.	Power / Moc [W]	Battery capacity / Pojemność akumulatora [mAh]	Icon
82736	5+3	2000	30



EN LED work light  
 PL Lampa robocza LED  
 DE LED Handleuchte  
 RU Светодиодный светильник для мастерской  
 CZ Pracovní LED svítidla  
 RO Lampa portabila cu LED  
 HU LED szerelőlámpa  
 ES Lámpara de taller LED

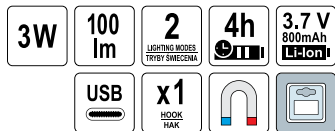

No.	Power / Moc [W]	Battery capacity / Pojemność akumulatora [mAh]	
82723	3	800	12/48

EN LED work light  
 PL Lampa robocza LED  
 DE LED Handleuchte  
 RU Светодиодный светильник для мастерской  
 CZ Pracovní LED svítidla  
 RO Lampa portabila cu LED  
 HU LED szerelőlámpa  
 ES Lámpara de taller LED

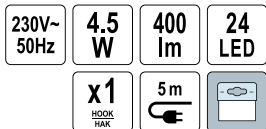

No.	Power / Moc [W]	Light source / Źródło światła [LED]	
82706	4.5	24	10/20

EN Work light  
 PL Lampa warsztatowa  
 DE Werkstattlampe  
 RU Лампа-переноска  
 CZ Pracovní lampa  
 RO Lampă pt. atelier  
 HU Szerelőlámpa  
 ES Lámpara de taller



No.	Max. power of light source / Maks. moc źródła światła [W]	Series / Seria	
82715	60	PLASTIC	10

EN Work light  
 PL Lampa warsztatowa  
 DE Werkstattlampe  
 RU Лампа-переноска  
 CZ Pracovní lampa  
 RO Lampă pt. atelier  
 HU Szerelőlámpa  
 ES Lámpara de taller

No.	Max. power of light source / Maks. moc źródła światła [W]	Series / Seria	
82717	100	GUMMI	10

EN LED work light  
 PL Lampa robocza LED  
 DE LED Handleuchte  
 RU Светодиодный светильник для мастерской  
 CZ Pracovní LED svítidla  
 RO Lampa portabila cu LED  
 HU LED szerelőlámpa  
 ES Lámpara de taller LED



No.	Power / Moc [W]	Light source / Źródło światła [LED]	
82699	3.2	16	10/20

EN Work light  
 PL Lampa warsztatowa  
 DE Werkstattlampe  
 RU Лампа-переноска  
 CZ Pracovní lampa  
 RO Lampă pt. atelier  
 HU Szerelőlámpa  
 ES Lámpara de taller

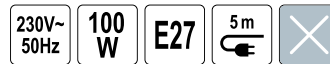

No.	Max. power of light source / Maks. moc źródła światła [W]	Series / Seria	
82713	100	PRACTIC	10

EN Work light  
 PL Lampa warsztatowa  
 DE Werkstattlampe  
 RU Лампа-переноска  
 CZ Pracovní lampa  
 RO Lampă pt. atelier  
 HU Szerelőlámpa  
 ES Lámpara de taller



No.	Max. power of light source / Maks. moc źródła światła [W]	Series / Seria	
82714	60	CLASSIC	10

EN Work light  
 PL Lampa warsztatowa  
 DE Werkstattlampe  
 RU Лампа-переноска  
 CZ Pracovní lampa  
 RO Lampă pt. atelier  
 HU Szerelőlámpa  
 ES Lámpara de taller



EN Workshop LED battery lamp  
 PL Diodowa lampa warsztatowa akumulatorowa  
 DE LED Akku-Werkstattlampe  
 RU Светодиодная беспроводная лампа  
 CZ Aku pracovní LED svítidla  
 RO Lampa portabila cu acumulator leduri  
 HU Akkumulátoros LED szerelőlámpa  
 ES Lámpara de trabajo LED recargable

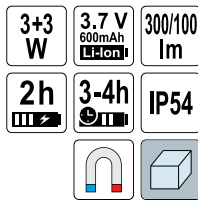

No.	Power / Moc [W]	Battery capacity / Pojemność akumulatora [mAh]	Icon
82734	3+3	600	120

EN LED work light  
 PL Lampa robocza LED  
 DE LED Handleuchte  
 RU Светодиодный светильник для мастерской  
 CZ Pracovní LED svítidla  
 RO Lampa portabila cu LED  
 HU LED szerelőlámpa  
 ES Lámpara de taller LED



No.	Battery type / Rodzaj baterii	Icon
82724	3x1.5V; AAA	12/48

EN LED work light  
 PL Lampa robocza LED  
 DE LED Handleuchte  
 RU Светодиодный светильник для мастерской  
 CZ Pracovní LED svítidla  
 RO Lampa portabila cu LED  
 HU LED szerelőlámpa  
 ES Lámpara de taller LED

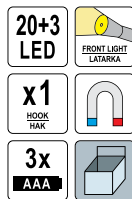

No.	Light source / Źródło światła [LED]	Battery type / Rodzaj baterii	Icon
82730	20+3	3x1.5V; AAA	12/48

EN Workshop LED battery lamp  
 PL Diodowa lampa warsztatowa akumulatorowa  
 DE LED Akku-Werkstattlampe  
 RU Светодиодная беспроводная лампа  
 CZ Aku pracovní LED svítidla  
 RO Lampa portabila cu acumulator leduri  
 HU Akkumulátoros LED szerelőlámpa  
 ES Lámpara de trabajo LED recargable

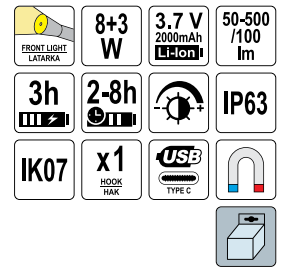

No.	Power / Moc [W]	Battery capacity / Pojemność akumulatora [mAh]	Icon
82743	8+3	2000	50

EN LED work light  
 PL Lampa robocza LED  
 DE LED Handleuchte  
 RU Светодиодный светильник для мастерской  
 CZ Pracovní LED svítidla  
 RO Lampa portabila cu LED  
 HU LED szerelőlámpa  
 ES Lámpara de taller LED

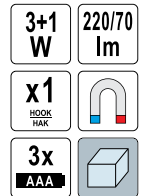

No.	Battery type / Rodzaj baterii	Icon
82733	3x1.5V; AAA	24/48

EN LED work light  
 PL Lampa robocza LED  
 DE LED Handleuchte  
 RU Светодиодный светильник для мастерской  
 CZ Pracovní LED svítidla  
 RO Lampa portabila cu LED  
 HU LED szerelőlámpa  
 ES Lámpara de taller LED

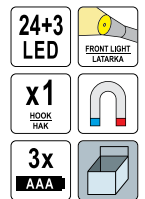

No.	Light source / Źródło światła [LED]	Battery type / Rodzaj baterii	Icon
82731	24+3	3x1.5V; AAA	12/48

- EN LED work light
- PL Lampa robocza LED
- DE LED Handleuchte
- RU Светодиодный светильник для мастерской
- CZ Pracovní LED svítidla
- RO Lampa portabila cu LED
- HU LED szerezőlámpa
- ES Lámpara de taller LED



No.	Battery type / Rodzaj baterii	
82726	3x1.5V; AA	12/48

- EN Under bonnet work lamp
- PL Lampa do oświetlenia komory silnika
- DE Motorhauben-Leuchte
- RU Лампа освещения моторного отсека
- CZ Dílnská lampa pro osvětlení motorového prostoru
- RO Lampă de lucru sub capotă
- HU Motorér-megvilágító lámpa
- ES Lámpara para capó de coche



No.	Power / Moc [W]	Battery capacity / Pojemność akumulatora [mAh]	
82707	15	4000	20



- EN UV LED flashlight and glasses set
- PL Zestaw latarka UV LED i okulary
- DE UV LED Taschenlampe mit UV Schutzbrille
- RU Комплект для проверки утечек хладагента - УФ фонарь с очками
- CZ UV LED svítilna + brýle
- RO Set lanternă UV LED și ochelari
- HU UV LED zseblámpa + szemüveg
- ES UV LED linterna con gafas para

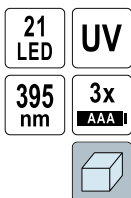

No.	Light source / Źródło światła [LED]	Battery type / Rodzaj baterii	
82756	21	3x1.5V; AAA	80

- EN LED flashlight
- PL Latarka LED
- DE LED Taschenlampe
- RU Светодиодный фонарь
- CZ LED svítilna
- RO Lanternă cu LED
- HU LED zseblámpa
- ES Linterna LED



No.	Power / Moc [W]	Battery type / Rodzaj baterii	
88560	10	3x1.5V; AA	12/24



- EN LED flashlight
- PL Latarka LED
- DE LED Taschenlampe
- RU Светодиодный фонарь
- CZ LED svítilna
- RO Lanternă cu LED
- HU LED zseblámpa
- ES Linterna LED

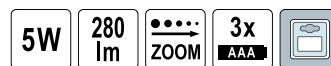

No.	Power / Moc [W]	Battery type / Rodzaj baterii	
88555	5	3x1.5V; AAA	12/48





EN LED headlamp  
 PL Latarka czołowa LED  
 DE LED Kopflampe  
 RU Налобный светодиодный фонарь  
 CZ Čelová lampa LED  
 RO Lanterna cu LED pt. cap  
 HU LED fejlámpa  
 ES Lámpara LED de cabeza

3 LIGHTING MODES TRYBY SWIECENIA  
 Micro USB  
 3.7 V 850mAh Li-Ion  
 5h  
 3W  
 130 lm  
 4 LED  
 160 lm



VOREL

No.		
88677		12/48

EN LED headlamp  
 PL Latarka czołowa LED  
 DE LED Kopflampe  
 RU Налобный светодиодный фонарь  
 CZ Čelová lampa LED  
 RO Lanterna cu LED pt. cap  
 HU LED fejlámpa  
 ES Lámpara LED de cabeza

1 LED  
 1W  
 3 LIGHTING MODES TRYBY SWIECENIA  
 3x AAA



VOREL

No.	Battery type / Rodzaj baterii	
88674	3x1.5V; AAA	12/48

EN LED headlamp  
 PL Latarka czołowa LED  
 DE LED Kopflampe  
 RU Налобный светодиодный фонарь  
 CZ Čelová lampa LED  
 RO Lanterna cu LED pt. cap  
 HU LED fejlámpa  
 ES Lámpara LED de cabeza

3W  
 150 lm  
 3x AAA



VOREL

No.	Battery type / Rodzaj baterii	
88676	3x1.5V; AAA	12/48

EN LED headlamp  
 PL Latarka czołowa LED  
 DE LED Kopflampe  
 RU Налобный светодиодный фонарь  
 CZ Čelová lampa LED  
 RO Lanterna cu LED pt. cap  
 HU LED fejlámpa  
 ES Lámpara LED de cabeza

5 LIGHTING MODES TRYBY SWIECENIA  
 3+3 W  
 320/200 lm  
 150m  
 3.7 V 1200mAh Li-Po  
 3.5h  
 3-8h  
 IPX4  
 IK06  
 USB CABLE KABEL  
 USB CABLE KABEL

POWER COB LED



STHOR

No.	Power / Moc [W]	
88681	3 (COB), 3 (XPE)	60/120

EN LED headlamp  
 PL Latarka czołowa LED  
 DE LED Kopflampe  
 RU Налобный светодиодный фонарь  
 CZ Čelová lampa LED  
 RO Lanterna cu LED pt. cap  
 HU LED fejlámpa  
 ES Lámpara LED de cabeza

1 LED  
 1W  
 3 LIGHTING MODES TRYBY SWIECENIA  
 3x AAA  
 ELASTIC STRAP ELASTYCZNY PASEK



VOREL

No.	Battery type / Rodzaj baterii	
88672	3x1.5V; AAA	12/60

EN LED headlamp  
 PL Latarka czołowa LED  
 DE LED Kopflampe  
 RU Налобный светодиодный фонарь  
 CZ Čelová lampa LED  
 RO Lanterna cu LED pt. cap  
 HU LED fejlámpa  
 ES Lámpara LED de cabeza

1+2 LED  
 100 lm  
 3x AAA



VOREL

No.	Battery type / Rodzaj baterii	
88675	3x1.5V; AAA	12/48

EN LED headlamp  
 PL Latarka czołowa LED  
 DE LED Kopflampe  
 RU Налобный светодиодный фонарь  
 CZ Čelová lampa LED  
 RO Lanterna cu LED pt. cap  
 HU LED fejlámpa  
 ES Lámpara LED de cabeza

4 LIGHTING MODES TRYBY SWIECENIA  
 5W 2x3W  
 430/200 lm  
 50m  
 3.7 V 1200mAh Li-Po  
 3.5-4h  
 3-4h  
 IP44  
 IK06  
 USB CABLE KABEL  
 USB CABLE KABEL



STHOR

No.	Power / Moc [W]	
88680	5 (COB), 3 x2 (XPE)	10/100



- EN LED bike light set
- PL Zestaw lamp rowerowych LED
- DE Fahrrad-Beleuchtungsset LED
- RU Набор светодиодных велосипедных фонарей
- CZ Set LED osvětlení na kolo
- RO Set lanterna bicicleta LED
- HU LED kerékpár lámpa szett
- ES Juego de luces LED para bicicleta

5 LED 2x AAA 3W 150 lm  
3x AAA ZOOM



No.	Battery type / Rodzaj baterii	
88422	3x1.5V; AAA, 2x1.5V; AAA	12/48

- EN Night lamp with body and light sensor
- PL Lampka nocna z czujnikiem ruchu i zmierzchu
- DE Nachtleuchte mit Bewegungsmelder und Helligkeitssensor
- RU Ночник с датчиком движения и сумеречного света
- CZ Noční lampa se senzorem pohybu a soumraku
- RO Lampa de veghe cu senzor lumina
- HU Mozgás- és szűrületérzékelős éjjeli lámpa
- ES Luz de noche con sensor de movimiento y crepuscular

1W 50 lm 120° 3m  
3x AAA



No.	Power / Moc [W]	Luminous flux / Strumień świetlny [lm]	
82831	1	50	25/100

- EN Insect killer lamp with fan
- PL Lampka owadobójcza z wentylatorem
- DE Insektizidlampe mit Ventilator
- RU Инсектицидная лампа с вентилятором
- CZ Lampa na hubeňí hmyzu s ventilátorem
- RO Lampă împotriva insectelor cu ventilator
- HU Ventilátoros rovarirtó lámpa
- ES Lámpara insecticida con ventilador

- FEATURES:**
- Funnel prevents insects from escaping
  - Storage box for insects
- CECHY:**
- Lejek zabezpiecza przed ucieczką owadów
  - Pojemnik na owady



No.	Power / Moc [W]	
67011	5	12

- EN Night lamp with body and light sensor
- PL Lampka nocna z czujnikiem ruchu i zmierzchu
- DE Nachtleuchte mit Bewegungsmelder und Helligkeitssensor
- RU Ночник с датчиком движения и сумеречного света
- CZ Noční lampa se senzorem pohybu a soumraku
- RO Lampa de veghe cu senzor lumina
- HU Mozgás- és szűrületérzékelős éjjeli lámpa
- ES Luz de noche con sensor de movimiento y crepuscular

3W 120 lm 120° 3m  
3x AAA



No.	Power / Moc [W]	Luminous flux / Strumień świetlny [lm]	
82830	3	120	25/100

- EN Night lamp with body and light sensor
- PL Lampka nocna z czujnikiem ruchu i zmierzchu
- DE Nachtleuchte mit Bewegungsmelder und Helligkeitssensor
- RU Ночник с датчиком движения и сумеречного света
- CZ Noční lampa se senzorem pohybu a soumraku
- RO Lampa de veghe cu senzor lumina
- HU Mozgás- és szűrületérzékelős éjjeli lámpa
- ES Luz de noche con sensor de movimiento y crepuscular

1W 50 lm 120°  
3.7V 600mAh Li-PO  
2h  
3h  
USB BATTERY CHARGER LASORABVA



No.	Power / Moc [W]	Luminous flux / Strumień świetlny [lm]	Battery capacity / Pojemność akumulatora [mAh]	
82832	1	50	600	25/100



5W UVA LED 365 nm 20000 h  
30m² USB CHARGING LASOWANIE ANTI-SLIP FEET NOŻKI ANTY-POŚLIZGOWE



EN Insect killer lamp with fan  
 PL Lampa owadobójcza z wentylatorem  
 DE Insektizidlampe mit Ventilator  
 RU Инсектицидная лампа с вентилятором  
 CZ Lampa na hubení hmyzu s ventilátorem  
 RO Lampă împotriva insectelor cu ventilator  
 HU Ventilátoros rovarirtó lámpa  
 ES Lámpara insecticida con ventilador

220-240V~50Hz  
 20 W  
 UVA T5 4W  
 365 nm  
 8000 h  
 25m<sup>2</sup>  
 1.1 m

- FEATURES:**
- Flap prevents insects from escaping
  - Storage box for insects
  - Free standing or hanging

- CECHY:**
- Klapka zabezpieczająca przed ucieczką owadów
  - Pojemnik na owady
  - Możliwość postawienia lub zawieszenia



**LUND**

No.	Power / Moc [W]	
67026	20	6

EN Insect killer lamp with fan  
 PL Lampa owadobójcza z wentylatorem  
 DE Insektizidlampe mit Ventilator  
 RU Инсектицидная лампа с вентилятором  
 CZ Lampa na hubení hmyzu s ventilátorem  
 RO Lampă împotriva insectelor cu ventilator  
 HU Ventilátoros rovarirtó lámpa  
 ES Lámpara insecticida con ventilador

220-240V~50/60Hz  
 15 W  
 UVA 56V 7W  
 365 nm  
 3000 h  
 300m<sup>2</sup>  
 IPX4  
 3 m

- FEATURES:**
- Funnel prevents insects from escaping
  - Storage box for insects
  - Chain 65 cm
  - Free standing or hanging
  - Inside and outside use

- CECHY:**
- Lejek zabezpiecza przed ucieczką owadów
  - Pojemnik na owady
  - Łańcuch 65 cm
  - Możliwość postawienia lub zawieszenia
  - Zastosowanie we wnętrzach i na zewnątrz



**LUND**

No.	Power / Moc [W]	
67013	15	6

EN Insect killer lamp UVA  
 PL Lampa owadobójcza UVA  
 DE UVA-Insektenlampe  
 RU Лампа от насекомых УФА  
 CZ UVA lampa na hubení hmyzu  
 RO Lampă UVA împotriva insectelor  
 HU UVA rovarirtó lámpa  
 ES Lámpara de UVA insecticida

- FEATURES:**
- Free standing or hanging
- CECHY:**
- Możliwość postawienia lub zawieszenia

220-240V~50Hz  
 2300V  
 17 W  
 UVA T5 6W  
 365 nm  
 8000 h  
 30m<sup>2</sup>  
 1 m

**LUND**

No.	Power / Moc [W]	
67032	17	6

EN Insect killer lamp with fan  
 PL Lampa owadobójcza z wentylatorem  
 DE Insektizidlampe mit Ventilator  
 RU Инсектицидная лампа с вентилятором  
 CZ Lampa na hubení hmyzu s ventilátorem  
 RO Lampă împotriva insectelor cu ventilator  
 HU Ventilátoros rovarirtó lámpa  
 ES Lámpara insecticida con ventilador

220-240V~50/60Hz  
 15 W  
 UVA 56V 7W  
 365 nm  
 3000 h  
 60m<sup>2</sup>  
 1.9 m

- FEATURES:**
- Funnel prevents insects from escaping
  - Storage box for insects

- CECHY:**
- Lejek zabezpiecza przed ucieczką owadów
  - Pojemnik na owady



**LUND**

No.	Power / Moc [W]	
67012	15	6

EN Insect killer lamp with fan  
 PL Lampa owadobójcza z wentylatorem  
 DE Insektizidlampe mit Ventilator  
 RU Инсектицидная лампа с вентилятором  
 CZ Lampa na hubení hmyzu s ventilátorem  
 RO Lampă împotriva insectelor cu ventilator  
 HU Ventilátoros rovarirtó lámpa  
 ES Lámpara insecticida con ventilador

- FEATURES:**
- Funnel prevents insects from escaping
  - Storage box for insects
  - Water tray
  - Light sensor automatically recognize the brightness of natural light to switch ON/OFF
  - Free standing or hanging
  - Inside and outside use

- CECHY:**
- Lejek zabezpiecza przed ucieczką owadów
  - Pojemnik na owady
  - Tacka na wodę
  - Czujnik światła automatycznie włącza i wyłącza urządzenie
  - Możliwość postawienia lub zawieszenia
  - Zastosowanie we wnętrzach i na zewnątrz



220-240V~50/60Hz  
 15 W  
 UVA 56V 7W  
 365 nm  
 3000 h  
 IPX4  
 3 m

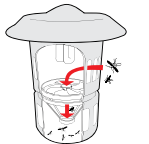

**LUND**

No.	Power / Moc [W]	
67014	15	2





EN Insect killer lamp UVA  
 PL Lampa owadobójcza UVA  
 DE UVA-Insektenlampe  
 RU Лампа от насекомых УФА  
 CZ UVA lampa na hubení hmyzu  
 RO Lampă UVA împotriva insectelor  
 HU UVA rovarirtó lámpa  
 ES Lámpara de UVA insecticida

**FEATURES:**  
 - Free standing or hanging

**CECHY:**  
 - Możliwość postawienia lub zawieszenia



**LUND**

No.	Power / Moc [W]	
67033	26	6

EN UVA bulb for insect killer lamp  
 PL Żarówka UVA do lamp owadobójczych  
 DE UVA-Leuchte für Insektenlampen  
 RU Лампочка УФА для ламп-убийц  
 CZ UVA žárovka do lamp na hubení hmyzu  
 RO Bec UVA pt. lampă împotriva insectelor  
 HU UVA izzó rovarirtó lámpához  
 ES Bombilla de UVA para lámparas insecticidas



**LUND**

No.	For / Dla	
67019	67012, 67013, 67014	200

EN UVA tube for insect killer lamp  
 PL Światłówka UVA do lamp owadobójczych  
 DE UVA-Leuchtstoffröhre für Insektenlampen  
 RU Флуоресцентная лампа УФА для ламп-убийц  
 CZ UVA zářivka do lamp na hubení hmyzu  
 RO Tub UVA pt. lampă împotriva insectelor  
 HU UVA égő rovarirtó lámpához  
 ES Tubo de UVA para lámparas insecticidas



**LUND**

No.	For / Dla	
67054	67032	100/300

EN Insect killer lamp UVA  
 PL Lampa owadobójcza UVA  
 DE UVA-Insektenlampe  
 RU Лампа от насекомых УФА  
 CZ UVA lampa na hubení hmyzu  
 RO Lampă UVA împotriva insectelor  
 HU UVA rovarirtó lámpa  
 ES Lámpara de UVA insecticida

**FEATURES:**  
 - Free standing or hanging

**CECHY:**  
 - Możliwość postawienia lub zawieszenia

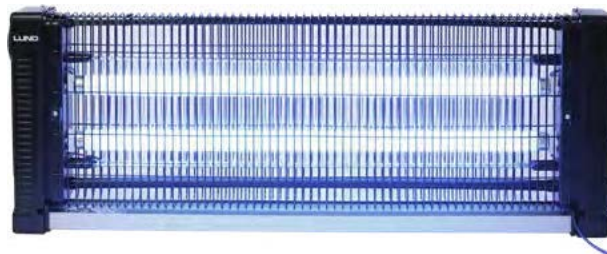
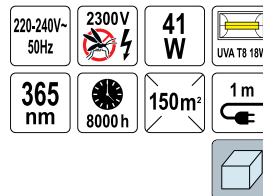

**LUND**

No.	Power / Moc [W]	
67034	41	4

EN UVA tube for insect killer lamp  
 PL Światłówka UVA do lamp owadobójczych  
 DE UVA-Leuchtstoffröhre für Insektenlampen  
 RU Флуоресцентная лампа УФА для ламп-убийц  
 CZ UVA zářivka do lamp na hubení hmyzu  
 RO Tub UVA pt. lampă împotriva insectelor  
 HU UVA égő rovarirtó lámpához  
 ES Tubo de UVA para lámparas insecticidas



**LUND**

No.	For / Dla	
67053	67026	500

EN UVA tube for insect killer lamp  
 PL Światłówka UVA do lamp owadobójczych  
 DE UVA-Leuchtstoffröhre für Insektenlampen  
 RU Флуоресцентная лампа УФА для ламп-убийц  
 CZ UVA zářivka do lamp na hubení hmyzu  
 RO Tub UVA pt. lampă împotriva insectelor  
 HU UVA égő rovarirtó lámpához  
 ES Tubo de UVA para lámparas insecticidas



**LUND**

No.	For / Dla	
67055	67033	25/100



EN UVA tube for insect killer lamp  
 PL Świelówka UVA do lamp owadobójczych  
 DE UVA-Leuchtstoffröhre für Insektenlampen  
 RU Флуоресцентная лампа УФА для ламп-убийц  
 CZ UVA zářivka do lamp na hubení hmyzu  
 RO Tub UVA pt. lampă împotriva insectelor  
 HU UVA égő rovarirtó lámpához  
 ES Tubo de UVA para lámparas insecticidas



**LUND**

No.	For / Dla	
67056	67034	25/100

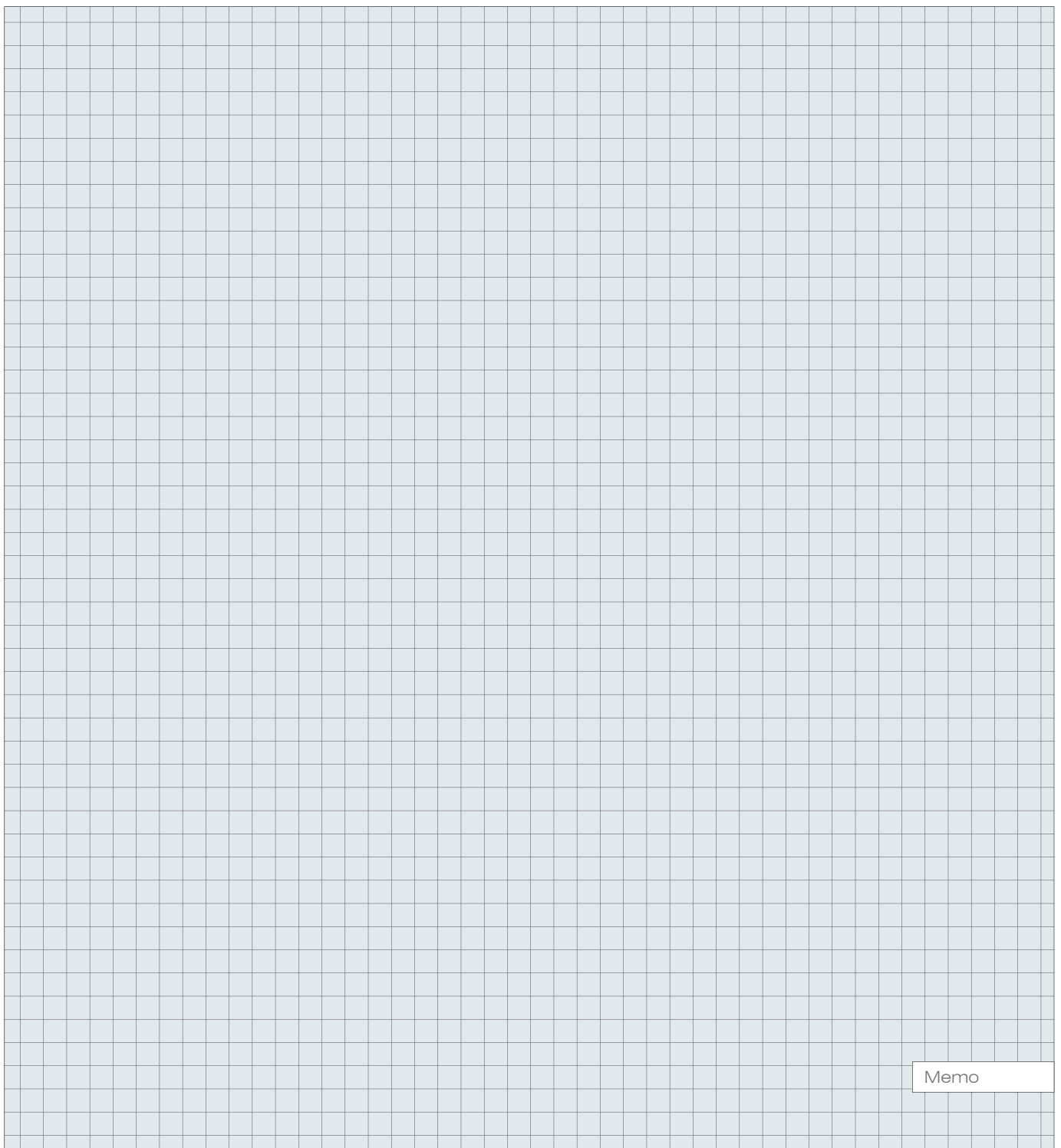

Memo

24

Garden tools & power tools  
Narzędzia i elektronarzędzia ogrodowe





## Watering program Program wodny



386-404

### Hose connectors, male connectors, couplings, hose menders

Złącza, nypły, łączniki, rozgałęziacze, reparatory..... 386

### Hose nozzles (sprinklers) & sets

Zraszacze i zestawy..... 389

### Garden hoses

Wężę ogrodowe..... 394

### Garden hose carts, holders & guides

Wózki, stojaki i prowadnice do węży..... 396

### Pumps

Pompy..... 396

### Irrigation valve boxes

Skrzynki zaworowe..... 396

### PE pipes adapters

Złączki do rur PE..... 397

### Water filters

Filtry do wody..... 403

## Pruners & shears

### Sekatory i nożyce ogrodowe



404-409

### Pruners

Sekatory..... 404

### Lopping shears

Sekatory do gałęzi..... 406

### Leverage tree pruners

Sekatory gąsienicowe..... 408

### Hedge shears

Nożyce do żywopłotu..... 408

### Grass shears

Nożyce do trawy..... 409

## Hand tools

### Narzędzia ręczne



409-426

### Small garden tools

Małe narzędzia ogrodowe..... 409

### Big garden tools

Duże narzędzia ogrodowe..... 412

### Handles

Trzonki..... 424

## Sprayers & accessories

### Opryskiwacze i akcesoria



426-428

## Garden accessories

### Akcesoria ogrodowe



428-438

## BBQ grills & accessories

### Grille i akcesoria



438-448

### Gas BBQ grills

Grille gazowe..... 438

### Charcoal BBQ grills

Grille węglowe..... 441

### Smokers

Wędzarnie..... 444

### Fire pits

Paleniska ogrodowe..... 445

### Accessories

Akcesoria..... 447

EN Hose connector  
 PL Złącze  
 DE Schlauchkupplung  
 RU Соединитель  
 CZ Rychlospojka  
 RO Conector  
 HU Gyorscsatlakozó  
 ES Conector



∅1/2"  
12.7mm

∅3/4"  
19mm

ABS  
PP



No.	Hose diameter / Šrednica węža	Package	
89221	1/2" (12.7 mm)	✕	150/600
89222	1/2" (12.7 mm)	☑	24/288
89223	3/4" (19.0 mm)	✕	60/240
89224	3/4" (19.0 mm)	☑	24/288

EN Hose connector  
 PL Złącze  
 DE Schlauchkupplung  
 RU Соединитель  
 CZ Rychlospojka  
 RO Conector  
 HU Gyorscsatlakozó  
 ES Conector



∅1/2"  
12.7mm

∅3/4"  
19mm

STOP

ABS  
PP



No.	Hose diameter / Šrednica węža	Package	
89225	1/2" (12.7 mm)	✕	150/600
89226	1/2" (12.7 mm)	☑	24/288
89227	3/4" (19.0 mm)	✕	60/240
89228	3/4" (19.0 mm)	☑	24/288

EN Brass hose connector  
 PL Złącze mosiężne  
 DE Schlauch-Schnellkupplung  
 RU Быстросъемная муфта  
 CZ Rychlospojka  
 RO Manșon de îmbinare  
 HU Csatlakozó  
 ES Conexión



∅1/2"  
12.7mm

∅3/4"  
19mm

BRASS  
MOSIĄDZ



No.	Hose diameter / Šrednica węža	Package	
89100	1/2" (12.7 mm)		48
89102	3/4" (19.0 mm)		48

EN Hose mender  
 PL Reparatör do węža  
 DE Schlauchreparatur  
 RU Муфта ремонтная для шланга

CZ Hadicová spojka  
 RO Mufă înădire  
 HU Tömítőoldó  
 ES Reparatör para manguera



No.	Hose diameter / Šrednica węža	Package	
89229	1/2" (12.7 mm)	✕	150/600
89230	1/2" (12.7 mm)	☑	24/288
89231	3/4" (19.0 mm)	✕	60/240
89232	3/4" (19.0 mm)	☑	24/288

EN Hose connector  
 PL Złącze  
 DE Schlauchkupplung  
 RU Соединитель  
 CZ Rychlospojka  
 RO Conector  
 HU Gyorscsatlakozó  
 ES Conector



∅1/2"  
12.7mm

∅3/4"  
19mm

ABS  
PP



No.	Hose diameter / Šrednica węža	Package	
89001	1/2" (12.7 mm)		30/240
89002	3/4" (19.0 mm)		30/240

EN Hose connector  
 PL Złącze  
 DE Schlauchkupplung  
 RU Соединитель  
 CZ Rychlospojka  
 RO Conector  
 HU Gyorscsatlakozó  
 ES Conector



∅1/2"  
12.7mm

∅3/4"  
19mm

STOP

ABS  
PP



No.	Hose diameter / Šrednica węža	Package	
89003	1/2" (12.7 mm)		30/240
89004	3/4" (19.0 mm)		30/240

EN Brass hose connector  
 PL Złącze mosiężne  
 DE Schlauch-Schnellkupplung  
 RU Быстросъемная муфта  
 CZ Rychlospojka  
 RO Manșon de îmbinare  
 HU Csatlakozó  
 ES Conexión



∅1/2"  
12.7mm

∅3/4"  
19mm

STOP

BRASS  
MOSIĄDZ



No.	Hose diameter / Šrednica węža	Package	
89101	1/2" (12.7 mm)		48
89103	3/4" (19.0 mm)		48

∅1/2"  
12.7mm

∅3/4"  
19mm

ABS  
PP





EN Hose mender  
 PL Reparatör do węży  
 DE Schlauchreparatur  
 RU Муфта ремонтная для шланга  
 CZ Hadicová spojka  
 RO Mufă înădire  
 HU Tömlőtoldó  
 ES Reparatör para manguera

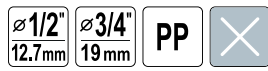

No.	Hose diameter / Średnica węży	Package
89007	1/2" (12.7 mm)	30/240
89008	3/4" (19.0 mm)	30/240

EN Hose reducer  
 PL Reparatör redukcyjny do węży  
 DE Reparaturstück mit Reduzierung  
 RU Редуктор для шланга  
 CZ Hadicová redukční spojka  
 RO Reductie  
 HU Tömlő összekötő  
 ES Reductor de manguera

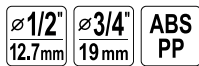

No.	Hose diameter / Średnica węży	Package
89233	1/2" (12.7 mm), 3/4" (19.0 mm)	60/240
89234	1/2" (12.7 mm), 3/4" (19.0 mm)	24/288

EN Tap adaptor  
 PL Przyłącze do kranu  
 DE Wasserhahnanschluss  
 RU Адаптер для крана  
 CZ Kohoutkový adaptér  
 RO Mufă pt. robinet  
 HU Csapcsatlakozó  
 ES Conexión de grifo



No.	Package
89253	24/240

EN Tap adaptor  
 PL Przyłącze do kranu  
 DE Wasserhahnanschluss  
 RU Адаптер для крана  
 CZ Kohoutkový adaptér  
 RO Mufă pt. robinet  
 HU Csapcsatlakozó  
 ES Conexión de grifo



No.	Connector thread size / Rozmiar gwintu przyłącza	Package
89015	G3/4	30/240

EN Hose mender  
 PL Reparatör do węży  
 DE Schlauchreparatur  
 RU Муфта ремонтная для шланга  
 CZ Hadicová spojka  
 RO Mufă înădire  
 HU Tömlőtoldó  
 ES Reparatör para manguera



No.	Hose diameter / Średnica węży	Package
89104	1/2" (12.7 mm)	48
89105	3/4" (19.0 mm)	48

EN Hose reducer  
 PL Reparatör redukcyjny do węży  
 DE Reparaturstück mit Reduzierung  
 RU Редуктор для шланга  
 CZ Hadicová redukční spojka  
 RO Reductie  
 HU Tömlő összekötő  
 ES Reductor de manguera

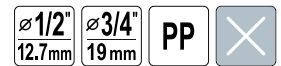

No.	Hose diameter / Średnica węży	Package
89011	1/2" (12.7 mm), 3/4" (19.0 mm)	30/240

EN Tap adaptor  
 PL Przyłącze do kranu  
 DE Wasserhahnanschluss  
 RU Адаптер для крана  
 CZ Kohoutkový adaptér  
 RO Mufă pt. robinet  
 HU Csapcsatlakozó  
 ES Conexión de grifo



No.	Connector thread size / Rozmiar gwintu przyłącza	Package
89239	G3/4	250/1000
89240	G3/4	24/288

EN Tap adaptor  
 PL Przyłącze do kranu  
 DE Wasserhahnanschluss  
 RU Адаптер для крана  
 CZ Kohoutkový adaptér  
 RO Mufă pt. robinet  
 HU Csapcsatlakozó  
 ES Conexión de grifo



No.	Connector thread size / Rozmiar gwintu przyłącza	Package
89110	G3/4	48

EN Tap adaptor  
 PL Przyłącze do kranu  
 DE Wasserhahnanschluss  
 RU Адаптер для крана  
 CZ Kohoutkový adaptér  
 RO Mufă pt. robinet  
 HU Csapcsatlakozó  
 ES Conexión de grifo

(F) G3/4 ABS



FLO

No.	Connector thread size / Rozmiar gwintu przyłącza	Package	
89235	G3/4	✕	250/1000
89236	G3/4	📦	24/288

EN Tap adaptor  
 PL Przyłącze do kranu  
 DE Wasserhahnanschluss  
 RU Адаптер для крана  
 CZ Kohoutkový adaptér  
 RO Mufă pt. robinet  
 HU Csapcsatlakozó  
 ES Conexión de grifo

(F) G3/4 (F) G1 BRASS MOSIADZ



FLO

No.	Connector thread size / Rozmiar gwintu przyłącza	
89106	G3/4	48
89107	G1	48

EN Tap adaptor  
 PL Przyłącze do kranu  
 DE Wasserhahnanschluss  
 RU Адаптер для крана  
 CZ Kohoutkový adaptér  
 RO Mufă pt. robinet  
 HU Csapcsatlakozó  
 ES Conexión de grifo

(F) G1/2 (F) G3/4 (F) G1 ABS



FLO

No.	Connector thread size / Rozmiar gwintu przyłącza	
89017	G1/2, G3/4	30/240
89018	G3/4, G1	30/240

EN Hose coupling  
 PL Łącznik  
 DE Schlauchkupplung  
 RU Соединитель  
 CZ Spojka  
 RO Racord  
 HU Tömlőcsatlakozás  
 ES Acoplador

ABS



FLO

No.	Water outlet diameter / Średnica przyłącza wody	Package	
89245	1/2" (12.7 mm)	✕	125/500
89246	1/2" (12.7 mm)	📦	24/288

EN Tap adaptor  
 PL Przyłącze do kranu  
 DE Wasserhahnanschluss  
 RU Адаптер для крана  
 CZ Kohoutkový adaptér  
 RO Mufă pt. robinet  
 HU Csapcsatlakozó  
 ES Conexión de grifo

(F) G3/4 ABS



FLO

No.	Connector thread size / Rozmiar gwintu przyłącza	
89013	G3/4	30/240

EN Tap adaptor  
 PL Przyłącze do kranu  
 DE Wasserhahnanschluss  
 RU Адаптер для крана  
 CZ Kohoutkový adaptér  
 RO Mufă pt. robinet  
 HU Csapcsatlakozó  
 ES Conexión de grifo

(F) G1/2 (F) G3/4 (F) G1 ABS



FLO

No.	Connector thread size / Rozmiar gwintu przyłącza	Package	
89241	G1/2, G3/4	✕	250/1000
89242	G1/2, G3/4	📦	24/288
89251	G3/4, G1	✕	100/1000
89252	G3/4, G1	📦	24/288

EN Tap adaptor  
 PL Przyłącze do kranu  
 DE Wasserhahnanschluss  
 RU Адаптер для крана  
 CZ Kohoutkový adaptér  
 RO Mufă pt. robinet  
 HU Csapcsatlakozó  
 ES Conexión de grifo

(F) G1/2 (F) G3/4 (F) G1 BRASS MOSIADZ



FLO

No.	Connector thread size / Rozmiar gwintu przyłącza	
89108	G1/2, G3/4	48
89109	G3/4, G1	48

EN Hose coupling  
 PL Łącznik  
 DE Schlauchkupplung  
 RU Соединитель  
 CZ Spojka  
 RO Racord  
 HU Tömlőcsatlakozás  
 ES Acoplador

ABS



FLO

No.		
89020		30/240

EN Hose coupling  
 PL Łącznik  
 DE Schlauchkupplung  
 RU Соединитель  
 CZ Spojka  
 RO Racord  
 HU Tömrlőcsatlakozás  
 ES Acoplador



No.	Package
89113	48

EN Y-switch coupling with swivel  
 PL Rozdzielacz z zaworami  
 DE 2-Wege Ventil  
 RU Распределитель внешний  
 CZ Rozbočovač s uzavíracími ventily  
 RO Racord iny cu robinet  
 HU Y-elágazó, 2 db külső menetes elzáróval  
 ES Distribuidor tipo „Y”



No.	Connector thread size / Rozmiar gwintu przyłącza	Package
89247	G3/4	24/240
89248	G3/4	12/96

EN Adjustable spray nozzle  
 PL Zraszacz prosty regulowany  
 DE Spritze  
 RU Распылитель поливочный  
 CZ Postřikovač  
 RO Stropitor apă  
 HU Szórófej  
 ES Rociador



No.	Package
89201	25/100
89202	12/120

EN Adjustable spray nozzle  
 PL Zraszacz prosty regulowany  
 DE Spritze  
 RU Распылитель поливочный  
 CZ Postřikovač  
 RO Stropitor apă  
 HU Szórófej  
 ES Rociador



No.	Package
89187	48

EN Hose coupling  
 PL Rozdzielacz  
 DE Wasserverteiler  
 RU Тройник-соединитель  
 CZ Rozdělovač  
 RO Racord 3 căi  
 HU Vízelosztó  
 ES Divisor de manguera



No.	Package
89243	125/250
89244	24/288

EN Y-switch coupling with swivel  
 PL Rozdzielacz z zaworami  
 DE 2-Wege Ventil  
 RU Распределитель внешний  
 CZ Rozbočovač s uzavíracími ventily  
 RO Racord iny cu robinet  
 HU Y-elágazó, 2 db külső menetes elzáróval  
 ES Distribuidor tipo „Y”

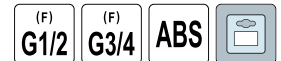

No.	Connector thread size / Rozmiar gwintu przyłącza	Package
89022	G1/2, G3/4	12/120

EN Adjustable spray nozzle  
 PL Zraszacz prosty regulowany  
 DE Spritze  
 RU Распылитель поливочный  
 CZ Postřikovač  
 RO Stropitor apă  
 HU Szórófej  
 ES Rociador



No.	Package
89200	25/200

EN Straight nozzle  
 PL Zraszacz prosty  
 DE Spritze  
 RU Распылитель поливочный  
 CZ Postřikovač  
 RO Stropitor apă  
 HU Szórófej  
 ES Rociador simple



No.	Package
89120	48

EN Adjustable spray gun  
 PL Pistolet zraszający regulowany  
 DE Regelbare Sprühpistole  
 RU Регулируемый оросительный пистолет  
 CZ Kropící pistole regulovatelná  
 RO Pistolet de irigare ajustabil  
 HU Öntöző pisztoly állítható sugarú  
 ES Pistola rociadora ajustable

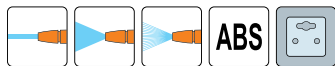

FLO

No. 89210 12/48

EN Adjustable spray gun  
 PL Pistolet zraszający regulowany  
 DE Regelbare Sprühpistole  
 RU Регулируемый оросительный пистолет  
 CZ Kropící pistole regulovatelná  
 RO Pistolet de irigare ajustabil  
 HU Öntöző pisztoly állítható sugarú  
 ES Pistola rociadora ajustable

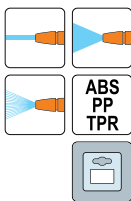

FLO

No. 89214 12/48

EN Adjustable spray gun  
 PL Pistolet zraszający regulowany  
 DE Regelbare Sprühpistole  
 RU Регулируемый оросительный пистолет  
 CZ Kropící pistole regulovatelná  
 RO Pistolet de irigare ajustabil  
 HU Öntöző pisztoly állítható sugarú  
 ES Pistola rociadora ajustable

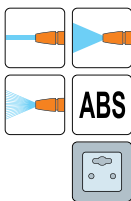

FLO

No. 89193 12/48

EN Adjustable spray gun  
 PL Pistolet zraszający regulowany  
 DE Regelbare Sprühpistole  
 RU Регулируемый оросительный пистолет  
 CZ Kropící pistole regulovatelná  
 RO Pistolet de irigare ajustabil  
 HU Öntöző pisztoly állítható sugarú  
 ES Pistola rociadora ajustable

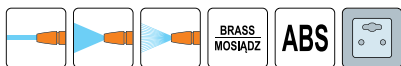

FLO

No. 89215 12/24

EN Adjustable spray gun  
 PL Pistolet zraszający regulowany  
 DE Regelbare Sprühpistole  
 RU Регулируемый оросительный пистолет  
 CZ Kropící pistole regulovatelná  
 RO Pistolet de irigare ajustabil  
 HU Öntöző pisztoly állítható sugarú  
 ES Pistola rociadora ajustable

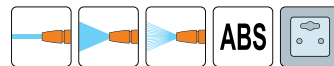

FLO

No. 89213 12/48

EN Adjustable spray gun  
 PL Pistolet zraszający regulowany  
 DE Regelbare Sprühpistole  
 RU Регулируемый оросительный пистолет  
 CZ Kropící pistole regulovatelná  
 RO Pistolet de irigare ajustabil  
 HU Öntöző pisztoly állítható sugarú  
 ES Pistola rociadora ajustable

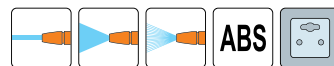

FLO

No. 89189 12/48

EN Adjustable spray gun  
 PL Pistolet zraszający regulowany  
 DE Regelbare Sprühpistole  
 RU Регулируемый оросительный пистолет  
 CZ Kropící pistole regulovatelná  
 RO Pistolet de irigare ajustabil  
 HU Öntöző pisztoly állítható sugarú  
 ES Pistola rociadora ajustable

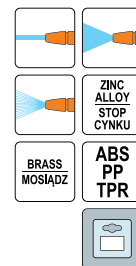

FLO

No. 89190 12/48

EN Sprinkling gun  
 PL Pistolet zraszający regulowany  
 DE Spritzpistole  
 RU Оросительный пистолет  
 CZ Postřikovací pistole  
 RO Pistol pt. pulverizare  
 HU Öntöző pisztoly  
 ES Pistola para regar



FLO

No. 89209 12/48



EN Multifunction sprinkling gun  
 PL Wielofunkcyjny pistolet zraszający  
 DE Multifunktions-Spritzpistole  
 RU Многофункциональный оросительный пистолет  
 CZ Multifunkční postřikovací pistole  
 RO Pistol multifuncțional pt. pulverizare  
 HU Többfunkciós öntöző pisztoly  
 ES Pistola para regar multifuncional

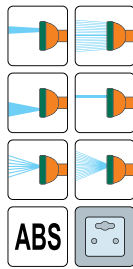

No.	
89220	12/48

EN Multifunction sprinkling gun  
 PL Wielofunkcyjny pistolet zraszający  
 DE Multifunktions-Spritzpistole  
 RU Многофункциональный оросительный пистолет  
 CZ Multifunkční postřikovací pistole  
 RO Pistol multifuncțional pt. pulverizare  
 HU Többfunkciós öntöző pisztoly  
 ES Pistola para regar multifuncional

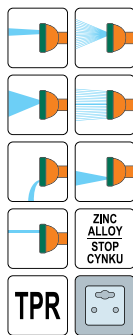

No.	
89192	12/48

EN Multifunction sprinkling gun  
 PL Wielofunkcyjny pistolet zraszający  
 DE Multifunktions-Spritzpistole  
 RU Многофункциональный оросительный пистолет  
 CZ Multifunkční postřikovací pistole  
 RO Pistol multifuncțional pt. pulverizare  
 HU Többfunkciós öntöző pisztoly  
 ES Pistola para regar multifuncional

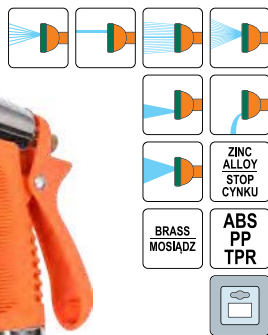

No.	
89191	12/48

EN Basic hose set with adjustable spray gun  
 PL Zestaw złączek ze zraszaczem pistoletowym  
 DE Spritzbrause und Anschlusset  
 RU Набор поливочный  
 CZ Rozprašovací pistole na vodu + spojky  
 RO Pistol reglabil cu și accesorii  
 HU Részecs készlet – os tömlőhöz  
 ES Juego de rociar para manguera

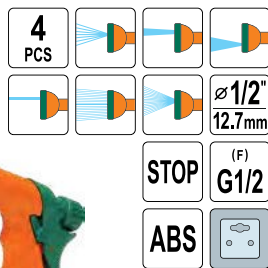

No.	Hose diameter / Šrednica węža	Connector thread size / Rozmiar gwintu przyłącza	pcs / szt.	
89206	1/2" (12.7 mm)	G1/2	4	12/48

EN Multifunction sprinkling gun  
 PL Wielofunkcyjny pistolet zraszający  
 DE Multifunktions-Spritzpistole  
 RU Многофункциональный оросительный пистолет  
 CZ Multifunkční postřikovací pistole  
 RO Pistol multifuncțional pt. pulverizare  
 HU Többfunkciós öntöző pisztoly  
 ES Pistola para regar multifuncional

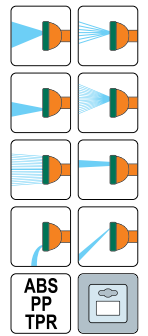

No.	
89211	12/48

EN Multifunction sprinkling gun  
 PL Wielofunkcyjny pistolet zraszający  
 DE Multifunktions-Spritzpistole  
 RU Многофункциональный оросительный пистолет  
 CZ Multifunkční postřikovací pistole  
 RO Pistol multifuncțional pt. pulverizare  
 HU Többfunkciós öntöző pisztoly  
 ES Pistola para regar multifuncional

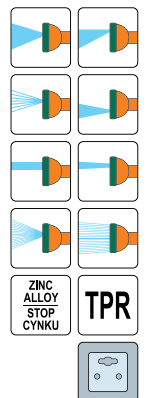

No.	
89195	6/24

EN Basic hose set with straight nozzle  
 PL Zestaw złączek ze zraszaczem prostym  
 DE Bewässerungs Spritz und Anschlussset  
 RU Набор поливочный  
 CZ Sada postřikovač a spojky  
 RO Ștut furtun apă cu accesorii pt. robinet  
 HU Készlet gyorskapocsal csaphoz  
 ES Juego de rociar tubuladura de grifo

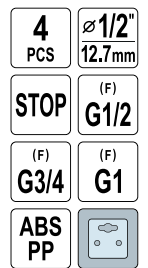

No.	Hose diameter / Šrednica węža	Connector thread size / Rozmiar gwintu przyłącza	pcs / szt.	
89203	1/2" (12.7 mm)	G3/4, G1	4	12/72
89204	1/2" (12.7 mm)	G1/2, G3/4	4	12/72

EN Basic hose set with adjustable spray gun  
 PL Zestaw złączek ze zraszaczem pistoletowym  
 DE Spritzbrause und Anschlusset  
 RU Набор поливочный  
 CZ Rozprašovací pistole na vodu + spojky  
 RO Pistol reglabil cu și accesorii  
 HU Részecs készlet – os tömlőhöz  
 ES Juego de rociar para manguera

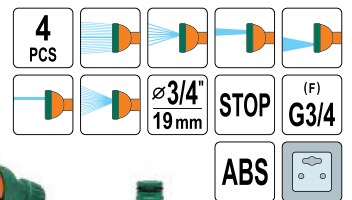

No.	Hose diameter / Šrednica węža	Connector thread size / Rozmiar gwintu przyłącza	pcs / szt.	
89207	3/4" (19.0 mm)	G3/4	4	12/48

EN Basic hose set with adjustable spray gun  
 PL Zestaw złączek ze zraszczaczem pistoletowym  
 DE Spritzbrause und Anschlussset  
 RU Набор поливочный  
 CZ Rozprašovací pistole na vodu + spojky  
 RO Pistol reglabil cu și accesorii  
 HU Részes készlet – os tömlőhöz  
 ES Juego de rociar para manguera

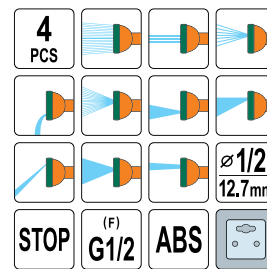

No.	Hose diameter / Šrednica weža	Connector thread size / Rozmiar gwintu przyłącza	pcs / szt.	
89208	1/2" (12.7 mm)	G1/2	4	12/48

EN Coil hose set with spray gun  
 PL Wąż spiralny z pistoletem zraszającym  
 DE Spiralschlauch mit Multifunktionsbrause  
 RU Спиральный шланг в наборе с пистолетом  
 CZ Pištoľ striekacia s vinutou hadicou  
 RO Furtuh in spirala cu pistol pt. stropit  
 HU Locsoló pisztoly tömlővel  
 ES Manguera espiral con rociador

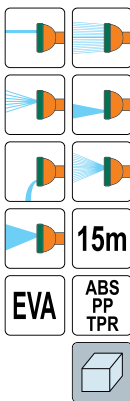

No.	Hose length / Długość węża [m]	
89351	15	8

EN Sprinkling lance  
 PL Lanza zraszająca wielofunkcyjna  
 DE Multifunktions-Spritzstab  
 RU Пика для распылителя многофункциональная  
 CZ Multifunkční postřikovací nadstavec  
 RO Tijă pt. irigare  
 HU Többfunkciós esőztető fej  
 ES Lanza para regar multifuncional

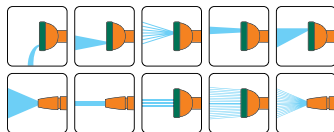

No.	
89218	12

EN 3-arms revolving sprinkler  
 PL Zraszacz 3-ramienny  
 DE 3-Arm Kreis-Regner  
 RU Трехсторонний распылитель  
 CZ Rozprašovač třiramenný  
 RO Aspersol cu 3 brate  
 HU Forgó locsoló leszűrhető  
 ES Rociador 3-brazos



No.	
89272	12/48

EN Garden shower  
 PL Prysznic ogrodowy  
 DE Gartendusche  
 RU Распылитель садовый  
 CZ Zahradní sprcha  
 RO Duș pt. grădină  
 HU Kerti zuhany  
 ES Regadera para jardín



No.	
89390	6

EN 3-arms revolving sprinkler  
 PL Zraszacz 3-ramienny  
 DE 3-Arm Kreis-Regner  
 RU Трехсторонний распылитель  
 CZ Rozprašovač třiramenný  
 RO Aspersol cu 3 brate  
 HU Forgó locsoló leszűrhető  
 ES Rociador 3-brazos



No.	
89263	12/48

EN Impulse sprinkler  
 PL Zraszacz impulsowy  
 DE Impulssprenger  
 RU Распылитель импульсный на пике  
 CZ Postřikovač  
 RO Stropitor apă  
 HU Impulzus szórófej  
 ES Rociador

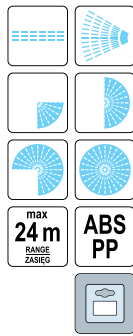

FLO

No.	89269	12/48
-----	-------	-------

EN Impulse sprinkler  
 PL Zraszacz impulsowy  
 DE Impulssprenger  
 RU Распылитель импульсный на пике  
 CZ Postřikovač  
 RO Stropitor apă  
 HU Impulzus szórófej  
 ES Rociador

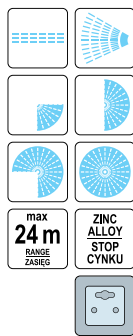

FLO

No.	89260	12/48
-----	-------	-------

EN Impulse sprinkler  
 PL Zraszacz impulsowy  
 DE Impulssprenger  
 RU Распылитель импульсный на пике  
 CZ Postřikovač  
 RO Stropitor apă  
 HU Impulzus szórófej  
 ES Rociador

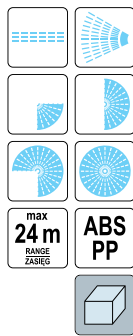

FLO

No.	89275	48
-----	-------	----

EN Oscillating sprinkler  
 PL Zraszacz oscylacyjny  
 DE Rechteckregner  
 RU Распылитель осциллирующий  
 CZ Obdélníkový zavlažovač  
 RO Aspersor oscilant  
 HU Oszillációs szórófej  
 ES Aspersor oscilante

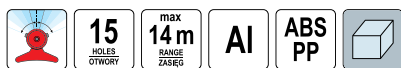

FLO

No.	89277	12
-----	-------	----

EN Impulse sprinkler  
 PL Zraszacz impulsowy  
 DE Impulssprenger  
 RU Распылитель импульсный на пике  
 CZ Postřikovač  
 RO Stropitor apă  
 HU Impulzus szórófej  
 ES Rociador

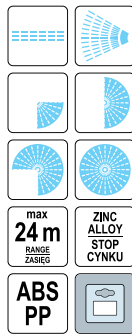

FLO

No.	89259	48
-----	-------	----

EN Sprinkler  
 PL Zraszacz szpilkowy  
 DE Sprenger  
 RU Дождеватель  
 CZ Kolíkový zavlažovač  
 RO Aspersol  
 HU Esőztető  
 ES Aspersor

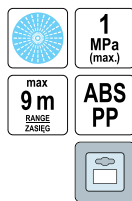

FLO

No.	89257	20/120
-----	-------	--------

EN Swing joint  
 PL Łącznik elastyczny do zraszaczy  
 DE Regneranschluss für Sprinkler  
 RU Гибкий соединитель для оросителей  
 CZ Elastická spojka do postřikovačů  
 RO Aspersor articulat oscilant  
 HU Rugalmas locsoló összekötő  
 ES Conector flexible para aspersor



FLO

No.	88925	Connector thread size / Rozmiar gwintu przyłącza	100
-----	-------	--	-----

EN Impulse pop-up sprinkler  
 PL Zraszacz wynurzalny  
 DE Tauchimpulssprinkler  
 RU Дождеватель выдвижной  
 CZ Zavlažovač výsuvný  
 RO Aspersor cu impuls  
 HU Esőztető szórófej  
 ES Rociador de emerger



FLO

No.	89280	12
-----	-------	----

EN Pop-up sprinkler  
 PL Zraszacz wynurzalny  
 DE Auftauch-Sprinkler  
 RU Выдвижной спринклер  
 CZ Výsuvný zavlažovač  
 RO Aspersor pop-up  
 HU Süllyesztett öntözőfej  
 ES Aspersor emergente



(F) max 8 m RANGE ZASIEG  
 ABS POM PE



No.	
89162	100

EN Pop-up sprinkler  
 PL Zraszacz wynurzalny  
 DE Auftauch-Sprinkler  
 RU Выдвижной спринклер  
 CZ Výsuvný zavlažovač  
 RO Aspersor pop-up  
 HU Süllyesztett öntözőfej  
 ES Aspersor emergente



(F) G1/2



No.	
89164	50

EN Nozzle for pop-up sprinkler  
 PL Głowica zraszacza  
 DE Sprinklerkopf  
 RU Спринклерная головка  
 CZ Zavlažovací hlavice  
 RO Duza pt. aspersor pop-up  
 HU Öntözőfej  
 ES Cabeza de aspersor



max 4.2 m RANGE ZASIEG  
 SS STAINLESS STEEL STAL NIERDZEWNA  
 POM



No.	
89166	30/1200

EN Garden hose  
 PL Wąż ogrodowy  
 DE Gartenschlauch  
 RU Садовый шланг  
 CZ Zahradní hadice  
 RO Furtun de gradina  
 HU Kerti tömlő  
 ES Manguera de jardín



No.	L [m]	Diameter / Średnica	
89302	20	1/2" (12.7 mm)	1
89303	30	1/2" (12.7 mm)	1
89305	50	1/2" (12.7 mm)	1
89307	20	3/4" (19.0 mm)	1
89308	30	3/4" (19.0 mm)	1
89310	50	3/4" (19.0 mm)	1
89298	20	1" (25.0 mm)	1
89299	30	1" (25.0 mm)	1
89300	50	1" (25.0 mm)	1

EN Pop-up sprinkler  
 PL Zraszacz wynurzalny  
 DE Auftauch-Sprinkler  
 RU Выдвижной спринклер  
 CZ Výsuvný zavlažovač  
 RO Aspersor pop-up  
 HU Süllyesztett öntözőfej  
 ES Aspersor emergente



(F) G1/2



No.	
89163	100

EN Nozzle for pop-up sprinkler  
 PL Głowica zraszacza  
 DE Sprinklerkopf  
 RU Спринклерная головка  
 CZ Zavlažovací hlavice  
 RO Duza pt. aspersor pop-up  
 HU Öntözőfej  
 ES Cabeza de aspersor



max 5.2 m RANGE ZASIEG  
 SS STAINLESS STEEL STAL NIERDZEWNA  
 POM



No.	
89165	30/1200

EN Nozzle for pop-up sprinkler  
 PL Głowica zraszacza  
 DE Sprinklerkopf  
 RU Спринклерная головка  
 CZ Zavlažovací hlavice  
 RO Duza pt. aspersor pop-up  
 HU Öntözőfej  
 ES Cabeza de aspersor



max 3 m RANGE ZASIEG  
 SS STAINLESS STEEL STAL NIERDZEWNA  
 POM



No.	
89167	30/1200

8 bar 15 bar 5°C -5 +50 Juv





EN Garden hose  
 PL Wąż ogrodowy  
 DE Gartenschlauch  
 RU Садовый шланг  
 CZ Zahradní hadice  
 RO Furtun de gradina  
 HU Kerti tömlő  
 ES Manguera de jardín



No.	L [m]	Diameter / Šrednica	
89311	20	1/2" (12.7 mm)	1
89312	30	1/2" (12.7 mm)	1
89313	50	1/2" (12.7 mm)	1
89314	20	3/4" (19.0 mm)	1
89315	30	3/4" (19.0 mm)	1
89316	50	3/4" (19.0 mm)	1
89318	20	1" (25.0 mm)	1
89319	30	1" (25.0 mm)	1
89320	50	1" (25.0 mm)	1

EN Garden hose  
 PL Wąż ogrodowy  
 DE Gartenschlauch  
 RU Садовый шланг  
 CZ Zahradní hadice  
 RO Furtun de gradina  
 HU Kerti tömlő  
 ES Manguera de jardín



No.	L [m]	Diameter / Šrednica	
89380	15	1/2" (12.7 mm)	1
89381	25	1/2" (12.7 mm)	1
89382	35	1/2" (12.7 mm)	1
89383	45	1/2" (12.7 mm)	1
89384	15	3/4" (19.0 mm)	1
89385	25	3/4" (19.0 mm)	1
89386	35	3/4" (19.0 mm)	1
89387	45	3/4" (19.0 mm)	1

EN Drip hose  
 PL Wąż kroplujący  
 DE Tropfschlauch  
 RU Капельный шланг  
 CZ Kapací hadice  
 RO Picurare furtun  
 HU Locsolótömlő  
 ES Manguera de goteo

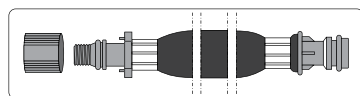
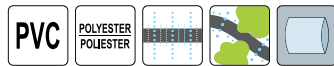

No.	L [m]	
89370	7.5	32
89371	15.0	15
89372	22.5	12
89373	30.0	8

EN Garden hose  
 PL Wąż ogrodowy  
 DE Gartenschlauch  
 RU Садовый шланг  
 CZ Zahradní hadice  
 RO Furtun de gradina  
 HU Kerti tömlő  
 ES Manguera de jardín



No.	L [m]	Diameter / Šrednica	
89290	20	1/2" (12.7 mm)	1
89291	30	1/2" (12.7 mm)	1
89292	50	1/2" (12.7 mm)	1
89293	20	3/4" (19.0 mm)	1
89294	30	3/4" (19.0 mm)	1
89295	50	3/4" (19.0 mm)	1

EN Soaker hose  
 PL Wąż zraszający  
 DE Einweichen Schlauch  
 RU Спринклерный шланг  
 CZ Hádiový zavlažovač  
 RO Furtun de aspersoare  
 HU Esőztetőtömlő  
 ES Manguera de remojo

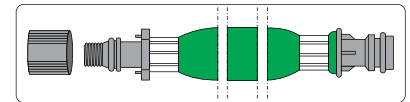
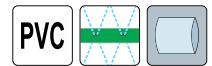

No.	L [m]	
89360	7.5	32
89361	15.0	15

EN Pump drain hose  
 PL Wąż odpływowy do pomp  
 DE Abflussschlauch für die Pumpen  
 RU Сливной шланг для насосов  
 CZ Výtlačná hadice pro čerpadla  
 RO Furtun de evacuare pt. pompe  
 HU Elfolyó tömlő szivattyúhoz  
 ES Manguera de salida para bombas



No.	L [m]	Diameter / Šrednica	Wall thickness / Grubość ścianki [mm]	
79960	10	1" (25.0 mm)	1.2	15
79962	20	1" (25.0 mm)	1.2	8
79963	30	1" (25.0 mm)	1.2	6
79965	50	1" (25.0 mm)	1.2	3
79968	20	1-1/4" (32.0 mm)	1.4	6
79971	50	1-1/4" (32.0 mm)	1.4	3

- EN Hose holder  
 PL Stojak do węzła ogrodowego  
 DE Gartenschlauchträger  
 RU Барабан для намотки поливочного шланга  
 CZ Stojan navjenci na zahradní hadici  
 RO Suport pt. furtun  
 HU Utartódob locsolótömlőhöz  
 ES Estante para manguera de jardín

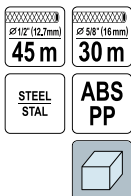

No. 89330  5

- EN Hose holder  
 PL Stojak do węzła ogrodowego  
 DE Gartenschlauchträger  
 RU Барабан для намотки поливочного шланга  
 CZ Stojan navjenci na zahradní hadici  
 RO Suport pt. furtun  
 HU Utartódob locsolótömlőhöz  
 ES Estante para manguera de jardín

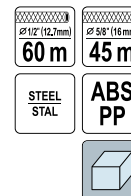

No. 89331  5

- EN Hose cart  
 PL Wózek do węzła ogrodowego  
 DE Gartenschlauchwagen  
 RU Барабан для намотки поливочного шланга  
 CZ Stojan navjenci na zahradní hadici  
 RO Suport pt. furtun  
 HU Utartódob locsolótömlőhöz  
 ES Carretilla para manguera de jardín

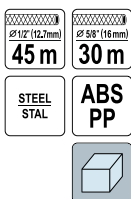

No. 89335  5

- EN Hose cart  
 PL Wózek do węzła ogrodowego  
 DE Gartenschlauchwagen  
 RU Барабан для намотки поливочного шланга  
 CZ Stojan navjenci na zahradní hadici  
 RO Suport pt. furtun  
 HU Utartódob locsolótömlőhöz  
 ES Carretilla para manguera de jardín

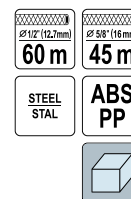

No. 89336  5

- EN Hose hanger  
 PL Wieszak na wąż ogrodowy  
 DE Gartenschlauchträger  
 RU Кронштейн настенный для шланга  
 CZ Věšák na hadici zahradní  
 RO Suport de perete pt. furtun  
 HU Kertitömlő-akasztó  
 ES Colgador para manguera de jardín



No. 89345  60

- EN Hand pump  
 PL Pompa ręczna  
 DE Schwengepumpe  
 RU Насос ручной  
 CZ Pumpa ruční  
 RO Pompa manuala  
 HU Kézi szivattyú  
 ES Bomba de mano



- EN Pump base  
 PL Podstawa pod pompę  
 DE Pumpenständer  
 RU Подставка для насоса  
 CZ Podstavec pumpy  
 RO Suport pt. pompa  
 HU Szivattyútalp  
 ES Soporite para bomba



- EN Round irrigation valve box  
 PL Okrągła skrzynka zaworowa ogrodowa  
 DE Rundes Gartenventilgehäuse  
 RU Круглый садовый вентиляционный ящик  
 CZ Kulatý zahradní ventilyový box  
 RO Cutie rotundă de supapă de irigare  
 HU Kerek kerti szelepedoboz  
 ES Caja redonda para válvulas, jardín



No. 89552  1



No. 89553 For / Dla 89552  1



No. 88780  10

EN Irrigation valve box  
 PL Skrzynka zaworowa ogrodowa  
 DE Gartenventilgehäuse  
 RU Садовый вентиляный ящик  
 CZ Zahradní ventilyový box  
 RO Cutie cu supape pt. irigație  
 HU Kerti szelepdoboz  
 ES Caja para válvulas, jardín

420x290  
520x390  
x320(H)  
mm

PP



FLO

No.

88783

4

EN Irrigation valve box  
 PL Skrzynka zaworowa ogrodowa  
 DE Gartenventilgehäuse  
 RU Садовый вентиляный ящик  
 CZ Zahradní ventilyový box  
 RO Cutie cu supape pt. irigație  
 HU Kerti szelepdoboz  
 ES Caja para válvulas, jardín

550x390  
650x500  
x320(H)  
mm

PP



FLO

No.

88784

2

EN Quick coupler valve  
 PL Zawór szybkozłączny  
 DE Schnellkupplungsventil  
 RU Клапан быстрого соединения  
 CZ Rychloupínací ventil  
 RO Supară cu cuplare rapidă  
 HU Gyorscsatlakozó szelep  
 ES Válvula de conexión rápida



(F)  
1  
25mm

QUICK  
RELEASE  
SZYBKO-  
ZŁĄCZE

WATER  
STOP VALVE  
ZAWÓR  
ODCIĄNĄCY  
WODĘ

POM



EN Quick coupler valve key  
 PL Klucz do zaworu szybkozłącznego  
 DE Schlüssel für Schnellkupplungsventil  
 RU Ключ для клапана быстрого соединения  
 CZ Klíč rychloupínacího ventilu  
 RO Cheie pt. supară cu cuplare rapidă  
 HU Kulcs gyorscsatlakozó szelephez  
 ES Llave para la válvula de conexión rápida



(M)  
3/4  
19mm

QUICK  
RELEASE  
SZYBKO-  
ZŁĄCZE

POM



FLO

No.

88927

No.

88927

EN Adapter  
 PL Złączka do rur  
 DE Rohrverbindung  
 RU Ниппель для труб  
 CZ Trubková spojka  
 RO Adaptor  
 HU Csatlakozó csőhöz  
 ES Conector de tubos



(M)  
G1 1/4

32  
mm

1  
MPa  
(max.)

PP



FLO

No.

88897

Connector thread size / Rozmiar gwintu przyłącza

G1-1/4 (M)

Water outlet diameter / Średnica przyłącza wody [mm]

32

No.

30/180

EN Adapter  
 PL Złączka do rur  
 DE Rohrverbindung  
 RU Ниппель для труб  
 CZ Trubková spojka  
 RO Adaptor  
 HU Csatlakozó csőhöz  
 ES Conector de tubos



(M)  
G1

25  
mm

1  
MPa  
(max.)

PP



FLO

No.

88851

Connector thread size / Rozmiar gwintu przyłącza

G1 (M)

Water outlet diameter / Średnica przyłącza wody [mm]

25

No.

30/240

EN Adapter  
 PL Złączka do rur  
 DE Rohrverbindung  
 RU Ниппель для труб  
 CZ Trubková spojka  
 RO Adaptor  
 HU Csatlakozó csőhöz  
 ES Conector de tubos



(M)  
G1

32  
mm

1  
MPa  
(max.)

PP



FLO

No.

88896

Connector thread size / Rozmiar gwintu przyłącza

G1 (M)

Water outlet diameter / Średnica przyłącza wody [mm]

32

No.

30/180

EN Adapter  
 PL Złączka do rur  
 DE Rohrverbindung  
 RU Ниппель для труб  
 CZ Trubková spojka  
 RO Adaptor  
 HU Csatlakozó csőhöz  
 ES Conector de tubos



(M)  
G3/4

25  
mm

1  
MPa  
(max.)

PP



FLO

No.

88850

Connector thread size / Rozmiar gwintu przyłącza

G3/4 (M)

Water outlet diameter / Średnica przyłącza wody [mm]

25

No.

50/200

EN Adapter  
 PL Złączka do rur  
 DE Rohrverbindung  
 RU Ниппель для труб  
 CZ Trubková spojka  
 RO Adaptor  
 HU Csatlakozó csőhöz  
 ES Conector de tubos



(M)  
G3/4

32  
mm

1  
MPa  
(max.)

PP



FLO

No.

88895

Connector thread size / Rozmiar gwintu przyłącza

G3/4 (M)

Water outlet diameter / Średnica przyłącza wody [mm]

32

No.

30/180

EN Adapter  
 PL Złączka do rur  
 DE Rohrverbindung  
 RU Ниппель для труб  
 CZ Trubková spojka  
 RO Adaptor  
 HU Csatlakozó csőhöz  
 ES Conector de tubos

(M) G1/2 25 mm 1 MPa (max.) PP



No.	Connector thread size / Rozmiar gwintu przyłącza	Water outlet diameter / Średnica przyłącza wody [mm]	
88849	G1/2 (M)	25	30/240

EN Adapter  
 PL Złączka do rur  
 DE Rohrverbindung  
 RU Ниппель для труб  
 CZ Trubková spojka  
 RO Adaptor  
 HU Csatlakozó csőhöz  
 ES Conector de tubos

(F) G1 32 mm 1 MPa (max.) PP



No.	Connector thread size / Rozmiar gwintu przyłącza	Water outlet diameter / Średnica przyłącza wody [mm]	
88893	G1-1/4 (F)	32	30/180

EN Adapter  
 PL Złączka do rur  
 DE Rohrverbindung  
 RU Ниппель для труб  
 CZ Trubková spojka  
 RO Adaptor  
 HU Csatlakozó csőhöz  
 ES Conector de tubos

(F) G1 32 mm 1 MPa (max.) PP



No.	Connector thread size / Rozmiar gwintu przyłącza	Water outlet diameter / Średnica przyłącza wody [mm]	
88892	G1 (F)	32	30/180

EN Adapter  
 PL Złączka do rur  
 DE Rohrverbindung  
 RU Ниппель для труб  
 CZ Trubková spojka  
 RO Adaptor  
 HU Csatlakozó csőhöz  
 ES Conector de tubos

(F) G3/4 32 mm 1 MPa (max.) PP



No.	Connector thread size / Rozmiar gwintu przyłącza	Water outlet diameter / Średnica przyłącza wody [mm]	
88891	G3/4 (F)	32	30/180

EN Adapter  
 PL Złączka do rur  
 DE Rohrverbindung  
 RU Ниппель для труб  
 CZ Trubková spojka  
 RO Adaptor  
 HU Csatlakozó csőhöz  
 ES Conector de tubos

(M) G1/2 32 mm 1 MPa (max.) PP



No.	Connector thread size / Rozmiar gwintu przyłącza	Water outlet diameter / Średnica przyłącza wody [mm]	
88894	G1/2 (M)	32	30/180

EN Adapter  
 PL Złączka do rur  
 DE Rohrverbindung  
 RU Ниппель для труб  
 CZ Trubková spojka  
 RO Adaptor  
 HU Csatlakozó csőhöz  
 ES Conector de tubos

(F) G1 25 mm 1 MPa (max.) PP



No.	Connector thread size / Rozmiar gwintu przyłącza	Water outlet diameter / Średnica przyłącza wody [mm]	
88842	G1 (F)	25	30/240

EN Adapter  
 PL Złączka do rur  
 DE Rohrverbindung  
 RU Ниппель для труб  
 CZ Trubková spojka  
 RO Adaptor  
 HU Csatlakozó csőhöz  
 ES Conector de tubos

(F) G3/4 25 mm 1 MPa (max.) PP



No.	Connector thread size / Rozmiar gwintu przyłącza	Water outlet diameter / Średnica przyłącza wody [mm]	
88841	G3/4 (F)	25	30/240

EN Adapter  
 PL Złączka do rur  
 DE Rohrverbindung  
 RU Ниппель для труб  
 CZ Trubková spojka  
 RO Adaptor  
 HU Csatlakozó csőhöz  
 ES Conector de tubos

(F) G1/2 25 mm 1 MPa (max.) PP



No.	Connector thread size / Rozmiar gwintu przyłącza	Water outlet diameter / Średnica przyłącza wody [mm]	
88840	G1/2 (F)	25	30/240



EN Adapter  
 PL Złącza do rur  
 DE Rohrverbindung  
 RU Ниппель для труб  
 CZ Trubková spojka  
 RO Adaptor  
 HU Csatlakozó csőhöz  
 ES Conector de tubos



No.	Connector thread size / Rozmiar gwintu przyłącza	Water outlet diameter / Średnica przyłącza wody [mm]	
88890	G1/2 (F)	32	30/180

EN Adapter - pipe plug  
 PL Ząslepka do rur  
 DE Rohrstopfen  
 RU Заглушка для труб  
 CZ Záslepka do trubek  
 RO Adaptor - conector teava  
 HU Elzáró sapka csőhöz  
 ES Tapa de tubos

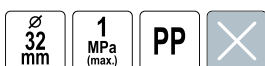

No.	Water outlet diameter / Średnica przyłącza wody [mm]	
88850	32	30/240

EN Adapter  
 PL Złącza do rur  
 DE Rohrverbindung  
 RU Ниппель для труб  
 CZ Trubková spojka  
 RO Adaptor  
 HU Csatlakozó csőhöz  
 ES Conector de tubos

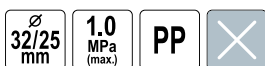

No.	Water outlet diameter / Średnica przyłącza wody [mm]	
88859	32x25	15/90

EN Adapter 90°  
 PL Kolanek do rur  
 DE Rohrkümmer  
 RU Кольцо для труб  
 CZ Trubkový ohyb  
 RO Adaptor 90°  
 HU Derékszög csőhöz  
 ES Codo para tubos



No.	Connector thread size / Rozmiar gwintu przyłącza	Water outlet diameter / Średnica przyłącza wody [mm]	
88917	G1-1/4 (M)	32	15/150

EN Adapter - pipe plug  
 PL Ząslepka do rur  
 DE Rohrstopfen  
 RU Заглушка для труб  
 CZ Záslepka do trubek  
 RO Adaptor - conector teava  
 HU Elzáró sapka csőhöz  
 ES Tapa de tubos



No.	Water outlet diameter / Średnica przyłącza wody [mm]	
88853	25	50/200

EN Adapter  
 PL Złącza do rur  
 DE Rohrverbindung  
 RU Ниппель для труб  
 CZ Trubková spojka  
 RO Adaptor  
 HU Csatlakozó csőhöz  
 ES Conector de tubos

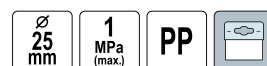

No.	Water outlet diameter / Średnica przyłącza wody [mm]	
88858	25x25	50/200

EN Adapter  
 PL Złącza do rur  
 DE Rohrverbindung  
 RU Ниппель для труб  
 CZ Trubková spojka  
 RO Adaptor  
 HU Csatlakozó csőhöz  
 ES Conector de tubos

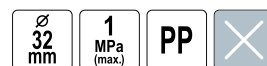

No.	Water outlet diameter / Średnica przyłącza wody [mm]	
88899	32x32	15/90

EN Adapter 90°  
 PL Kolanek do rur  
 DE Rohrkümmer  
 RU Кольцо для труб  
 CZ Trubkový ohyb  
 RO Adaptor 90°  
 HU Derékszög csőhöz  
 ES Codo para tubos



No.	Connector thread size / Rozmiar gwintu przyłącza	Water outlet diameter / Średnica przyłącza wody [mm]	
88870	G1 (M)	25	50/200

EN Adapter 90°  
 PL Kolanko do rur  
 DE Rohrkrümmmer  
 RU Колено для труб  
 CZ Trubkový ohyb  
 RO Adaptor 90°  
 HU Derékszög csőhöz  
 ES Codo para tubos

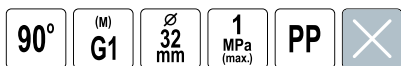

No.	Connector thread size / Rozmiar gwintu przyłącza	Water outlet diameter / Średnica przyłącza wody [mm]	
88916	G1 (M)	32	15/150

EN Adapter 90°  
 PL Kolanko do rur  
 DE Rohrkrümmmer  
 RU Колено для труб  
 CZ Trubkový ohyb  
 RO Adaptor 90°  
 HU Derékszög csőhöz  
 ES Codo para tubos



No.	Connector thread size / Rozmiar gwintu przyłącza	Water outlet diameter / Średnica przyłącza wody [mm]	
88915	G3/4 (M)	32	15/150

EN Adapter 90°  
 PL Kolanko do rur  
 DE Rohrkrümmmer  
 RU Колено для труб  
 CZ Trubkový ohyb  
 RO Adaptor 90°  
 HU Derékszög csőhöz  
 ES Codo para tubos

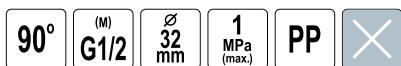

No.	Connector thread size / Rozmiar gwintu przyłącza	Water outlet diameter / Średnica przyłącza wody [mm]	
88914	G1/2 (M)	32	15/150

EN Adapter 90°  
 PL Kolanko do rur  
 DE Rohrkrümmmer  
 RU Колено для труб  
 CZ Trubkový ohyb  
 RO Adaptor 90°  
 HU Derékszög csőhöz  
 ES Codo para tubos

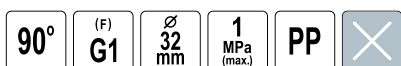

No.	Connector thread size / Rozmiar gwintu przyłącza	Water outlet diameter / Średnica przyłącza wody [mm]	
88913	G1 (F)	32	15/150

EN Adapter 90°  
 PL Kolanko do rur  
 DE Rohrkrümmmer  
 RU Колено для труб  
 CZ Trubkový ohyb  
 RO Adaptor 90°  
 HU Derékszög csőhöz  
 ES Codo para tubos

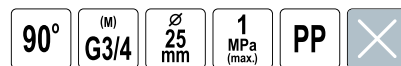

No.	Connector thread size / Rozmiar gwintu przyłącza	Water outlet diameter / Średnica przyłącza wody [mm]	
88869	G3/4 (M)	25	15/150

EN Adapter 90°  
 PL Kolanko do rur  
 DE Rohrkrümmmer  
 RU Колено для труб  
 CZ Trubkový ohyb  
 RO Adaptor 90°  
 HU Derékszög csőhöz  
 ES Codo para tubos

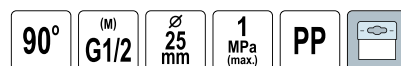

No.	Connector thread size / Rozmiar gwintu przyłącza	Water outlet diameter / Średnica przyłącza wody [mm]	
88871	G1/2 (M)	25	50/200

EN Adapter 90°  
 PL Kolanko do rur  
 DE Rohrkrümmmer  
 RU Колено для труб  
 CZ Trubkový ohyb  
 RO Adaptor 90°  
 HU Derékszög csőhöz  
 ES Codo para tubos

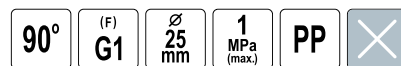

No.	Connector thread size / Rozmiar gwintu przyłącza	Water outlet diameter / Średnica przyłącza wody [mm]	
88874	G1 (F)	25	15/150

EN Adapter 90°  
 PL Kolanko do rur  
 DE Rohrkrümmmer  
 RU Колено для труб  
 CZ Trubkový ohyb  
 RO Adaptor 90°  
 HU Derékszög csőhöz  
 ES Codo para tubos



No.	Connector thread size / Rozmiar gwintu przyłącza	Water outlet diameter / Średnica przyłącza wody [mm]	
88857	G3/4 (F)	25	50/200

EN Adapter 90°  
 PL Kolanko do rur  
 DE Rohrkümmmer  
 RU Колено для труб  
 CZ Trubkový ohyb  
 RO Adaptor 90°  
 HU Derékszög csőhöz  
 ES Codo para tubos

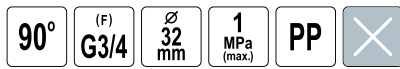

No.	Connector thread size / Rozmiar gwintu przyłącza	Water outlet diameter / Średnica przyłącza wody [mm]	Box icon
88912	G3/4 (F)	32	15/150

EN Adapter 90°  
 PL Kolanko do rur  
 DE Rohrkümmmer  
 RU Колено для труб  
 CZ Trubkový ohyb  
 RO Adaptor 90°  
 HU Derékszög csőhöz  
 ES Codo para tubos

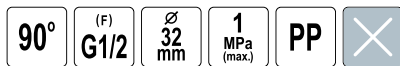

No.	Connector thread size / Rozmiar gwintu przyłącza	Water outlet diameter / Średnica przyłącza wody [mm]	Box icon
88911	G1/2 (F)	32	15/150

EN Adapter 90°  
 PL Kolanko do rur  
 DE Rohrkümmmer  
 RU Колено для труб  
 CZ Trubkový ohyb  
 RO Adaptor 90°  
 HU Derékszög csőhöz  
 ES Codo para tubos



No.	Water outlet diameter / Średnica przyłącza wody [mm]	Box icon
88910	32x32	15/90

EN Adapter  
 PL Trójnik  
 DE T-Stück  
 RU Тройник  
 CZ Rozdělovač  
 RO Adaptor  
 HU Hármás elosztó  
 ES Tubos en T



No.	Connector thread size / Rozmiar gwintu przyłącza	Water outlet diameter / Średnica przyłącza wody [mm]	Box icon
88860	G1 (M)	25x25	50/200

EN Adapter 90°  
 PL Kolanko do rur  
 DE Rohrkümmmer  
 RU Колено для труб  
 CZ Trubkový ohyb  
 RO Adaptor 90°  
 HU Derékszög csőhöz  
 ES Codo para tubos

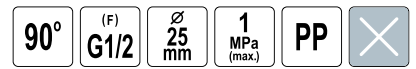

No.	Connector thread size / Rozmiar gwintu przyłącza	Water outlet diameter / Średnica przyłącza wody [mm]	Box icon
88872	G1/2 (F)	25	15/150

EN Adapter 90°  
 PL Kolanko do rur  
 DE Rohrkümmmer  
 RU Колено для труб  
 CZ Trubkový ohyb  
 RO Adaptor 90°  
 HU Derékszög csőhöz  
 ES Codo para tubos



No.	Water outlet diameter / Średnica przyłącza wody [mm]	Box icon
88856	25x25	50/200

EN Adapter  
 PL Trójnik  
 DE T-Stück  
 RU Тройник  
 CZ Rozdělovač  
 RO Adaptor  
 HU Hármás elosztó  
 ES Tubos en T



No.	Connector thread size / Rozmiar gwintu przyłącza	Water outlet diameter / Średnica przyłącza wody [mm]	Box icon
88908	G1-1/4 (M)	32x32	15/90

EN Adapter  
 PL Trójnik  
 DE T-Stück  
 RU Тройник  
 CZ Rozdělovač  
 RO Adaptor  
 HU Hármás elosztó  
 ES Tubos en T



No.	Connector thread size / Rozmiar gwintu przyłącza	Water outlet diameter / Średnica przyłącza wody [mm]	Box icon
88907	G1 (M)	32x32	15/90

EN Adapter  
 PL Trójnik  
 DE T-Stück  
 RU Тройник  
 CZ Rozdělovač  
 RO Adaptor  
 HU Hármás elosztó  
 ES Tubos en T



No.	Connector thread size / Rozmiar gwintu przyłącza	Water outlet diameter / Średnica przyłącza wody [mm]	
88861	G3/4 (M)	25x25	50/200

EN Adapter  
 PL Trójnik  
 DE T-Stück  
 RU Тройник  
 CZ Rozdělovač  
 RO Adaptor  
 HU Hármás elosztó  
 ES Tubos en T



No.	Connector thread size / Rozmiar gwintu przyłącza	Water outlet diameter / Średnica przyłącza wody [mm]	
88862	G1/2 (M)	25x25	50/200

EN Adapter  
 PL Trójnik  
 DE T-Stück  
 RU Тройник  
 CZ Rozdělovač  
 RO Adaptor  
 HU Hármás elosztó  
 ES Tubos en T



No.	Connector thread size / Rozmiar gwintu przyłącza	Water outlet diameter / Średnica przyłącza wody [mm]	
88863	G1 (F)	25x25	50/200

EN Adapter  
 PL Trójnik  
 DE T-Stück  
 RU Тройник  
 CZ Rozdělovač  
 RO Adaptor  
 HU Hármás elosztó  
 ES Tubos en T



No.	Connector thread size / Rozmiar gwintu przyłącza	Water outlet diameter / Średnica przyłącza wody [mm]	
88855	G3/4 (F)	25x25	50/200

EN Adapter  
 PL Trójnik  
 DE T-Stück  
 RU Тройник  
 CZ Rozdělovač  
 RO Adaptor  
 HU Hármás elosztó  
 ES Tubos en T



No.	Connector thread size / Rozmiar gwintu przyłącza	Water outlet diameter / Średnica przyłącza wody [mm]	
88906	G3/4 (M)	32x32	15/90

EN Adapter  
 PL Trójnik  
 DE T-Stück  
 RU Тройник  
 CZ Rozdělovač  
 RO Adaptor  
 HU Hármás elosztó  
 ES Tubos en T



No.	Connector thread size / Rozmiar gwintu przyłącza	Water outlet diameter / Średnica przyłącza wody [mm]	
88905	G1/2 (M)	32x32	15/90

EN Adapter  
 PL Trójnik  
 DE T-Stück  
 RU Тройник  
 CZ Rozdělovač  
 RO Adaptor  
 HU Hármás elosztó  
 ES Tubos en T



No.	Connector thread size / Rozmiar gwintu przyłącza	Water outlet diameter / Średnica przyłącza wody [mm]	
88904	G1 (F)	32x32	15/90

EN Adapter  
 PL Trójnik  
 DE T-Stück  
 RU Тройник  
 CZ Rozdělovač  
 RO Adaptor  
 HU Hármás elosztó  
 ES Tubos en T



No.	Connector thread size / Rozmiar gwintu przyłącza	Water outlet diameter / Średnica przyłącza wody [mm]	
88903	G3/4 (F)	32x32	15/90



EN Adapter  
 PL Trójnik  
 DE T-Stück  
 RU Тройник  
 CZ Rozdělovač  
 RO Adaptor  
 HU Hármás elosztó  
 ES Tubos en T



No.	Connector thread size / Rozmiar gwintu przyłącza	Water outlet diameter / Średnica przyłącza wody [mm]	Box icon
88864	G1/2 (F)	25x25	50/200

EN Adapter  
 PL Trójnik  
 DE T-Stück  
 RU Тройник  
 CZ Rozdělovač  
 RO Adaptor  
 HU Hármás elosztó  
 ES Tubos en T

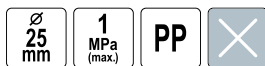

No.	Water outlet diameter / Średnica przyłącza wody [mm]	Box icon
88865	25x25x25	15/120

EN Adapter  
 PL Trójnik  
 DE T-Stück  
 RU Тройник  
 CZ Rozdělovač  
 RO Adaptor  
 HU Hármás elosztó  
 ES Tubos en T

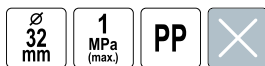

No.	Water outlet diameter / Średnica przyłącza wody [mm]	Box icon
88909	32x32x32	15/90

EN Water filter  
 PL Filtr wody  
 DE Wasserfilter  
 RU Фильтр очистки воды  
 CZ Vodní filtr  
 RO Filtru apa  
 HU Vízsűrítő  
 ES Filtro de agua



No.	Connector thread size / Rozmiar gwintu przyłącza	Box icon
88931	G1 BSP (M)	24

EN Adapter  
 PL Trójnik  
 DE T-Stück  
 RU Тройник  
 CZ Rozdělovač  
 RO Adaptor  
 HU Hármás elosztó  
 ES Tubos en T



No.	Connector thread size / Rozmiar gwintu przyłącza	Water outlet diameter / Średnica przyłącza wody [mm]	Box icon
88900	G1/2 (F)	32x32	15/90

EN Adapter  
 PL Trójnik  
 DE T-Stück  
 RU Тройник  
 CZ Rozdělovač  
 RO Adaptor  
 HU Hármás elosztó  
 ES Tubos en T

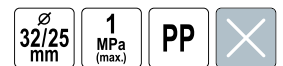

No.	Water outlet diameter / Średnica przyłącza wody [mm]	Box icon
88902	32x25x32	15/90

EN Water filter  
 PL Filtr wody  
 DE Wasserfilter  
 RU Фильтр очистки воды  
 CZ Vodní filtr  
 RO Filtru apa  
 HU Vízsűrítő  
 ES Filtro de agua



No.	Connector thread size / Rozmiar gwintu przyłącza	Box icon
88930	G3/4 BSP (M)	24

EN Water filter  
 PL Filtr wody  
 DE Wasserfilter  
 RU Фильтр очистки воды  
 CZ Vodní filtr  
 RO Filtru apa  
 HU Vízsűrítő  
 ES Filtro de agua

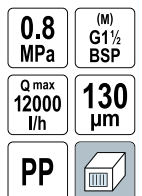

No.	Connector thread size / Rozmiar gwintu przyłącza	Box icon
88932	G1-1/2 BSP (M)	9

EN Water filter  
 PL Filtr wody  
 DE Wasserfilter  
 RU Фильтр очистки воды  
 CZ Vodní filtr  
 RO Filtru apa  
 HU Vízszűrő  
 ES Filtro de agua



0.8 MPa (M) G2 BSP  
 Q max 22000 l/h 130 µm  
 PP



No.	Connector thread size / Rozmiar gwintu przyłącza	
88933	G2 BSP (M)	9

EN Filter element of screen filter  
 PL Wkład siatkowy do filtra wody  
 DE Mascheneinsatz für Wasserfilter  
 RU Сетчатый картридж для фильтра очистки воды  
 CZ Sítovaná vložka vodního filtru  
 RO Sita filtru  
 HU Hálós betét vízszűrőbe  
 ES Cartucho de malla para filtro de agua



(M) G1 1/2 BSP (M) G2 BSP  
 120 µm MESH SITO PP  
 SS STAINLESS STEEL STAŁ NIERDZEWNA



No.	Connector thread size / Rozmiar gwintu przyłącza	For / Dla	
88936	G1-1/2 BSP (M), G2 BSP (M)	88932, 88933	32

EN Filter element of disc filter  
 PL Wkład dyskowy do filtra wody  
 DE Scheibenfiltereinsatz für Wasserfilter  
 RU Дискковый картридж для фильтра очистки воды  
 CZ Disková vložka do vodního filtru  
 RO Disc filtru  
 HU Lemezse betét vízszűrőbe  
 ES Cartucho de disco para filtro de agua



(M) G1 1/2 BSP (M) G2 BSP  
 130 µm PP



No.	Connector thread size / Rozmiar gwintu przyłącza	For / Dla	
88939	G1-1/2 BSP (M), G2 BSP (M)	88932, 88933	32

EN Bypass pruner  
 PL Sekator uniwersalny  
 DE Gartenschere  
 RU Секатор  
 CZ Zahradní nůžky  
 RO Foarfece pt. pomi  
 HU Metszőolló  
 ES Tijera de poda

ø 15mm 190 mm



No.	L [mm]	
99194	190	12/120

EN Filter element of screen filter  
 PL Wkład siatkowy do filtra wody  
 DE Mascheneinsatz für Wasserfilter  
 RU Сетчатый картридж для фильтра очистки воды  
 CZ Sítovaná vložka vodního filtru  
 RO Sita filtru  
 HU Hálós betét vízszűrőbe  
 ES Cartucho de malla para filtro de agua



(M) G3/4 BSP (M) G1 BSP  
 120 µm MESH SITO PP  
 SS STAINLESS STEEL STAŁ NIERDZEWNA



No.	Connector thread size / Rozmiar gwintu przyłącza	For / Dla	
88935	G3/4 BSP (M), G1 BSP (M)	88930, 88931	144

EN Filter element of disc filter  
 PL Wkład dyskowy do filtra wody  
 DE Scheibenfiltereinsatz für Wasserfilter  
 RU Дискковый картридж для фильтра очистки воды  
 CZ Disková vložka do vodního filtru  
 RO Disc filtru  
 HU Lemezse betét vízszűrőbe  
 ES Cartucho de disco para filtro de agua



(M) G3/4 (M) G1  
 130 µm PP



No.	Connector thread size / Rozmiar gwintu przyłącza	For / Dla	
88938	G3/4 BSP (M), G1 BSP (M)	88930, 88931	144

EN Bypass pruner  
 PL Sekator uniwersalny  
 DE Gartenschere  
 RU Секатор  
 CZ Zahradní nůžky  
 RO Foarfece pt. pomi  
 HU Metszőolló  
 ES Tijera de poda

ø 10mm 180 mm



No.	L [mm]	
99193	180	12/120

EN Bypass pruner  
 PL Sekator uniwersalny  
 DE Gartenschere  
 RU Секатор  
 CZ Zahradní nůžky  
 RO Foarfece pt. pomi  
 HU Metszőolló  
 ES Tijera de poda

200 mm



No.	L [mm]	
99230	200	20/60

EN Bypass pruner  
 PL Sekator uniwersalny  
 DE Gartenschere  
 RU Секатор  
 CZ Zahradní nůžky  
 RO Foarfece pt. pomi  
 HU Metszőolló  
 ES Tijera de poda



No.	L [mm]	
99190	200	18/72

EN Bypass pruner  
 PL Sekator uniwersalny  
 DE Gartenschere  
 RU Секатор  
 CZ Zahradní nůžky  
 RO Foarfece pt. pomi  
 HU Metszőolló  
 ES Tijera de poda



No.	L [mm]	
99202	180	18/72

EN Bypass pruner  
 PL Sekator uniwersalny  
 DE Gartenschere  
 RU Секатор  
 CZ Zahradní nůžky  
 RO Foarfece pt. pomi  
 HU Metszőolló  
 ES Tijera de poda



No.	L [mm]	
99204	220	20/60

EN Bypass pruner  
 PL Sekator uniwersalny  
 DE Gartenschere  
 RU Секатор  
 CZ Zahradní nůžky  
 RO Foarfece pt. pomi  
 HU Metszőolló  
 ES Tijera de poda



No.	L [mm]	
99206	210	20/60

EN Bypass pruner  
 PL Sekator uniwersalny  
 DE Gartenschere  
 RU Секатор  
 CZ Zahradní nůžky  
 RO Foarfece pt. pomi  
 HU Metszőolló  
 ES Tijera de poda



No.	L [mm]	
99209	215	6/48

EN Bypass pruner  
 PL Sekator uniwersalny  
 DE Gartenschere  
 RU Секатор  
 CZ Zahradní nůžky  
 RO Foarfece pt. pomi  
 HU Metszőolló  
 ES Tijera de poda



No.	L [mm]	
99203	205	20/60

EN Bypass pruner  
 PL Sekator uniwersalny  
 DE Gartenschere  
 RU Секатор  
 CZ Zahradní nůžky  
 RO Foarfece pt. pomi  
 HU Metszőolló  
 ES Tijera de poda



No.	L [mm]	
99208	200	12/60

EN Anvil pruner  
 PL Sekator kowadełkowy  
 DE Amboss-Gartenschere  
 RU Секатор с наковальней  
 CZ Kovadlinkové zahradní nůžky  
 RO Foarfecca nicovala  
 HU Metszőolló  
 ES Tijera de poda de yunque



No.	L [mm]	
99207	205	20/60

EN Anvil pruner  
 PL Sekator kowadełkowy  
 DE Amboss-Gartenschere  
 RU Секатор с наковальней  
 CZ Kovadlinkové zahradní nůžky  
 RO Foarfeca nicovala  
 HU Metszőolló  
 ES Tijera de poda de yunque



No.	L [mm]	Box icon
99191	200	18/72

EN By-pass pruners set  
 PL Zestaw sekatorów  
 DE Scherenset  
 RU Набор ножниц  
 CZ Zahradnické nůžky sada  
 RO Set de foarfece pt. pomi  
 HU Metszős olló készlet  
 ES Juego de tijeras



No.	L [mm]	Box icon
99195	150	24

EN Flower shears  
 PL Nożyce florystyczne  
 DE Blumenschere  
 RU Цветочные ножницы  
 CZ Květinové nůžky  
 RO Foarfece de grădină  
 HU Virág ollók  
 ES Tijeras de podar

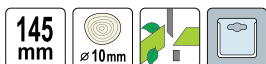

No.	L [mm]	Box icon
99181	145	12/120

EN Flower shears  
 PL Nożyce florystyczne  
 DE Blumenschere  
 RU Цветочные ножницы  
 CZ Květinové nůžky  
 RO Foarfece de grădină  
 HU Virág ollók  
 ES Tijeras de podar

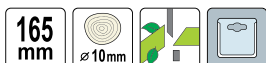

No.	L [mm]	Box icon
99182	165	12/120

EN Grafting tool  
 PL Sekator do szczepień  
 DE Gartenschere zum Pfropfen  
 RU Секатор для прививки  
 CZ Roubovací nůžky  
 RO Instrument pt. altoit  
 HU Öltő olló  
 ES Tijera injertadora



No.	Box icon
99250	20

EN Fruit and flower shears  
 PL Sekator do obcinania zawiązków  
 DE Blumen- und Rebschere  
 RU Секатор  
 CZ Nožnice zahradnické  
 RO Foarfece pt. pomi  
 HU Metszőolló  
 ES Podadera para cortar germenos



No.	L [mm]	Box icon
99240	190	12/72

EN Flower shears  
 PL Nożyce florystyczne  
 DE Blumenschere  
 RU Цветочные ножницы  
 CZ Květinové nůžky  
 RO Foarfece de grădină  
 HU Virág ollók  
 ES Tijeras de podar



No.	L [mm]	Box icon
99180	170	12/120

EN Bypass lopper  
 PL Sekator do gałęzi  
 DE Astschere  
 RU Сучкорез  
 CZ Nůžky na větve  
 RO Foarfeca curbata pt. taiat crengi  
 HU Ágvágó olló  
 ES Tijera para ramas



No.	L [mm]	Box icon
99101	430	12



EN Bypass lopper  
 PL Sekator do gałęzi  
 DE Astschere  
 RU Сучкорез  
 CZ Nůžky na větve  
 RO Foarfeca curbata pt. taiat crengi  
 HU Ágvágó olló  
 ES Tijera para ramas



No.	L [mm]	
99103	535	12

EN Bypass lopper  
 PL Sekator do gałęzi  
 DE Astschere  
 RU Сучкорез  
 CZ Nůžky na větve  
 RO Foarfeca curbata pt. taiat crengi  
 HU Ágvágó olló  
 ES Tijera para ramas



No.	L [mm]	
99109	660	12

EN Bypass lopper  
 PL Sekator do gałęzi  
 DE Astschere  
 RU Сучкорез  
 CZ Nůžky na větve  
 RO Foarfeca curbata pt. taiat crengi  
 HU Ágvágó olló  
 ES Tijera para ramas



No.	L [mm]	
99111	700	12

EN Telescopic bypass lopper  
 PL Sekator teleskopowy do gałęzi  
 DE Teleskop-Astschere  
 RU Сучкорез телескопический  
 CZ Teleskopické nůžky na větve  
 RO Foarfeca telescopica pt. crengi  
 HU Ágvágó teleszkópos  
 ES Tijera de poda telescópica



No.	L [mm]	
99114	660-1000	12

EN Bypass lopper  
 PL Sekator do gałęzi  
 DE Astschere  
 RU Сучкорез  
 CZ Nůžky na větve  
 RO Foarfeca curbata pt. taiat crengi  
 HU Ágvágó olló  
 ES Tijera para ramas



No.	L [mm]	
99104	630	12

EN Bypass lopper  
 PL Sekator do gałęzi  
 DE Astschere  
 RU Сучкорез  
 CZ Nůžky na větve  
 RO Foarfeca curbata pt. taiat crengi  
 HU Ágvágó olló  
 ES Tijera para ramas



No.	L [mm]	
99116	690	12

EN Telescopic bypass lopper  
 PL Sekator teleskopowy do gałęzi  
 DE Teleskop-Astschere  
 RU Сучкорез телескопический  
 CZ Teleskopické nůžky na větve  
 RO Foarfeca telescopica pt. crengi  
 HU Ágvágó teleszkópos  
 ES Tijera de poda telescópica



No.	L [mm]	
99119	660-910	12

EN Telescopic bypass lopper  
 PL Sekator teleskopowy do gałęzi  
 DE Teleskop-Astschere  
 RU Сучкорез телескопический  
 CZ Teleskopické nůžky na větve  
 RO Foarfeca telescopica pt. crengi  
 HU Ágvágó teleszkópos  
 ES Tijera de poda telescópica



No.	L [mm]	
99113	690-1030	6

EN Bypass lopper  
 PL Sekator do gałęzi  
 DE Astschere  
 RU Сучкорез  
 CZ Nůžky na větve  
 RO Foarfeca curbata pt. taiat crengi  
 HU Ágvágó olló  
 ES Tijera para ramas



**FLO**

No.	L [mm]	
99115	620-940	12

EN Bypass lopper  
 PL Sekator do gałęzi  
 DE Astschere  
 RU Сучкорез  
 CZ Nůžky na větve  
 RO Foarfeca curbata pt. taiat crengi  
 HU Ágvágó olló  
 ES Tijera para ramas

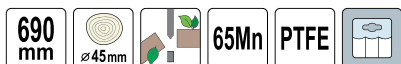

**FLO**

No.	L [mm]	
99112	690	12

EN Telescopic handle  
 PL Przedłużka teleskopowa  
 DE Teleskopstange  
 RU Рукотка телескопическая

CZ Teleskopický prodlužovač  
 RO Prelungitor telescopic  
 HU Teleszkópos hosszabbító  
 ES Tubo de prolongación telescópico

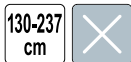

**FLO**

No.	L [mm]	
99315	1300-2370	12

EN Hedge shears  
 PL Nożyce do żywoplotu  
 DE Heckenschere  
 RU Кусторезы  
 CZ Nožnice na živý plot  
 RO Foarfeca pt. gard viu  
 HU Sívényvágó olló  
 ES Tijeras para seto vivo



**FLO**

No.	L [mm]	
99005	550	20

EN Bypass lopper  
 PL Sekator do gałęzi  
 DE Astschere  
 RU Сучкорез  
 CZ Nůžky na větve  
 RO Foarfeca curbata pt. taiat crengi  
 HU Ágvágó olló  
 ES Tijera para ramas



**FLO**

No.	L [mm]	
99110	660	12

EN Leverage tree pruner  
 PL Sekator gasienicowy z piłą  
 DE Baumsäge mit Astschere  
 RU Сучкорез штанговый с пилой  
 CZ Sříhač na větve s pilovým listem  
 RO Fierastrau pt. pomi cu prelungitor  
 HU Kőteles ágvágó  
 ES Podadera de palanca con sierra



**FLO**

No.	L [mm]	
99310	330	12/24

EN Hedge shears  
 PL Nożyce do żywoplotu  
 DE Heckenschere  
 RU Кусторезы  
 CZ Nožnice na živý plot  
 RO Foarfeca pt. gard viu  
 HU Sívényvágó olló  
 ES Tijeras para seto vivo



**FLO**

No.	L [mm]	
99001	415	12

EN Hedge shears  
 PL Nożyce do żywoplotu  
 DE Heckenschere  
 RU Кусторезы  
 CZ Nožnice na živý plot  
 RO Foarfeca pt. gard viu  
 HU Sívényvágó olló  
 ES Tijeras para seto vivo

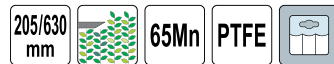

**FLO**

No.	L [mm]	
99006	630	12

EN Hedge shears  
 PL Nożyce do żywoplotu  
 DE Heckenschere  
 RU Кусторезы  
 CZ Nožnice na živý plot  
 RO Foarfeca pt. gard viu  
 HU Sövényvágó olló  
 ES Tijeras para seto vivo

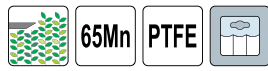

No.	L [mm]	Blade length / Długość ostrza [mm]	18
99007	590	185	18
99008	620	215	18

EN Grass shears  
 PL Nożyce do trawy wielopozycyjne  
 DE Handgrassschere  
 RU Ножницы для стрижки травы  
 CZ Nožnice na trávu  
 RO Foarfeca pt. gazon  
 HU Forgátható fűnyíró olló  
 ES Tijeras de césped



No.	L [mm]	12/48
99300	320	12/48

EN Pruning saw  
 PL Pila ogrodnicza  
 DE Gartensäge  
 RU Пила садовая  
 CZ Zahradní pilka  
 RO Fierastrău pt. curatat copaci  
 HU Kerti fűrészt  
 ES Sierra para jardín

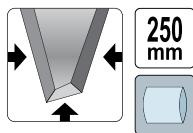

No.	L [mm]	12/120
28640	250	12/120

EN Pruning saw with sheath  
 PL Pila ogrodnicza z kaburą  
 DE Gartensäge mit Holster  
 RU Пила садовая с кабурой  
 CZ Zahradní pilka s pouzdrzem  
 RO Ferăstrău pt. curatat copaci cu toc  
 HU Keti fűrészt tokkal  
 ES Sierra para jardín con funda

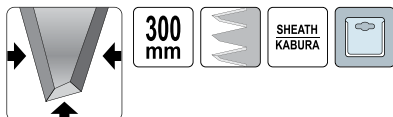

No.	L [mm]	12/36
28642	300	12/36

EN Hedge shears  
 PL Nożyce do żywoplotu  
 DE Heckenschere  
 RU Кусторезы  
 CZ Nožnice na živý plot  
 RO Foarfeca pt. gard viu  
 HU Sövényvágó olló  
 ES Tijeras para seto vivo



No.	L [mm]	12
99009	650-860	12

EN Grass shears  
 PL Nożyce do trawy wielopozycyjne  
 DE Handgrassschere  
 RU Ножницы для стрижки травы  
 CZ Nožnice na trávu  
 RO Foarfeca pt. gazon  
 HU Forgátható fűnyíró olló  
 ES Tijeras de césped



No.	L [mm]	12/48
99301	300	12/48

EN Folding pruning saw  
 PL Pila ogrodnicza składana  
 DE Klappgartensäge  
 RU Пила садовая складная  
 CZ Skládací zahradní pilka  
 RO Fierastrău pliabil pt. curatat copaci  
 HU Összecsukható kerti fűrészt  
 ES Sierra para jardín plegable

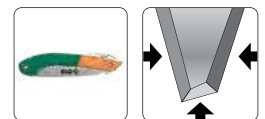

No.	L [mm]	20/60
28641	180	20/60

EN Pruning saw with sheath  
 PL Pila ogrodnicza z kaburą  
 DE Gartensäge mit Holster  
 RU Пила садовая с кабурой  
 CZ Zahradní pilka s pouzdrzem  
 RO Ferăstrău pt. curatat copaci cu toc  
 HU Keti fűrészt tokkal  
 ES Sierra para jardín con funda

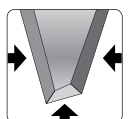
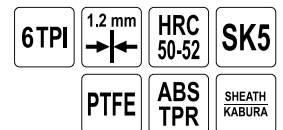

No.	L [mm]	Package	24
28611	240	12/36	24
28612	300	12/36	24

- EN Folding pruning saw
- PL Pila ogrodnicza składana
- DE Klappgartensäge
- RU Пила садовая складная
- CZ Skládací zahradní pilka
- RO Fierastrau pliabil pt. curatat copaci
- HU Összecsukható kerti fűrész
- ES Sierra para jardín plegable



No.	L [mm]	
28630	150	10/40

- EN Folding pruning saw
- PL Pila ogrodnicza składana
- DE Klappgartensäge
- RU Пила садовая складная
- CZ Skládací zahradní pilka
- RO Fierastrau pliabil pt. curatat copaci
- HU Összecsukható kerti fűrész
- ES Sierra para jardín plegable

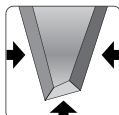

No.	L [mm]	
28631	210	12/72
28632	250	12/72

- EN Transplanter
- PL Łopatka
- DE Blumenkelle
- RU Совок посадочный
- CZ Lopatka
- RO Mini-lopata gradinarit
- HU Ásó
- ES Paleta estrecha



No.	L [mm]	
99048	350	25/100

- EN Rake
- PL Grabki
- DE Blumenrechen
- RU Грабли
- CZ Hrabičky
- RO Mini grebla
- HU Gereblye
- ES Rastrillo



No.	L [mm]	
99051	300	25/100

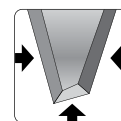

- EN Curved pruning saw
- PL Pila ogrodnicza zakrzywiona
- DE Gebogene Gartensäge
- RU Пила садовая с изогнутым полотном
- CZ Zahradní pilka zahnutá
- RO Fierastrau curbat pt. curatat copaci
- HU ívelt kerti fűrész
- ES Sierra para jardín curvada

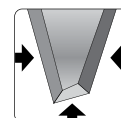

No.	L [mm]	
28613	330	24

- EN Transplanter
- PL Łopatka
- DE Blumenkelle
- RU Совок посадочный
- CZ Lopatka
- RO Mini-lopata gradinarit
- HU Ásó
- ES Paleta estrecha



No.	L [mm]	
99047	350	25/100

- EN Hoe and cultivator
- PL Motyczka z pazurkami
- DE Kleinhacke
- RU Рыхлитель комбинированный
- CZ Motyčka s kultivátorem
- RO Cultivator cu sapaliga
- HU Kerti villás kapa
- ES Escarificador y azadilla



No.	L [mm]	
99050	300	50



EN Hoe  
 PL Motyczka  
 DE Garten Handhacke  
 RU Мотыжка  
 CZ Motyčka  
 RO Sapaliga  
 HU Kerti kapa  
 ES Azadilla

300 mm



FLO

No.	L [mm]	
99052	300	100

EN Transplanter  
 PL Łopatka  
 DE Blumenkelle  
 RU Совок посадочный  
 CZ Lopatka  
 RO Mini-lopată gradinarit  
 HU Ásó  
 ES Paleta estrecha

320 mm



FLO

No.	L [mm]	
35765	320	50

EN Cultivator  
 PL Pazaruki  
 DE Grubber  
 RU Рыхлитель  
 CZ Kultivátor  
 RO Cultivator  
 HU Kultivátor  
 ES Escarifi cador

330 mm



FLO

No.	L [mm]	
35767	330	50

EN Transplanter  
 PL Łopatka  
 DE Blumenkelle  
 RU Совок посадочный  
 CZ Lopatka  
 RO Mini-lopată gradinarit  
 HU Ásó  
 ES Paleta estrecha

330 mm



FLO

No.	L [mm]	
99035	330	24/48

EN Cultivator  
 PL Pazaruki  
 DE Grubber  
 RU Рыхлитель  
 CZ Kultivátor  
 RO Cultivator  
 HU Kultivátor  
 ES Escarifi cador

310 mm



FLO

No.	L [mm]	
99049	310	25/100

EN Hoe  
 PL Motyczka  
 DE Garten Handhacke  
 RU Мотыжка  
 CZ Motyčka  
 RO Sapaliga  
 HU Kerti kapa  
 ES Azadilla

350 mm



FLO

No.	L [mm]	
35768	350	50

EN Transplanter  
 PL Łopatka  
 DE Blumenkelle  
 RU Совок посадочный  
 CZ Lopatka  
 RO Mini-lopată gradinarit  
 HU Ásó  
 ES Paleta estrecha

330 mm



FLO

No.	L [mm]	
99034	330	24/48

EN Rake  
 PL Grabki  
 DE Blumenrechen  
 RU Грабли  
 CZ Hrabičky  
 RO Mini grebla  
 HU Gereblye  
 ES Rastrillo

300 mm



FLO

No.	L [mm]	
99036	300	24/48

EN Hoe and cultivator  
 PL Motyczka z pazurkami  
 DE Kleinhacke  
 RU Рыхлитель комбинированный  
 CZ Motyčka s kultivátorem  
 RO Cultivator cu sapaliga  
 HU Kerti villás kapa  
 ES Escarificador y azadilla

300 mm



FLO

No.	L [mm]	
99037	300	24/48

EN Garden rake  
 PL Grabki wachlarzowe  
 DE Landschaftsbesen  
 RU Грабли веерные  
 CZ Hraňičky  
 RO Grebla de gradina  
 HU Kerti gereblye  
 ES Rastrillo de abanico de hojalata

400 mm



FLO

No.	L [mm]	
99039	400	24/48

EN Bulb planter  
 PL Sadzarka do cebuli  
 DE Blumenzweibelpflanzer  
 RU Конус посадочный для рассады  
 CZ Sázeč  
 RO Plantator  
 HU Palántázó  
 ES Plantadora para cebollas

X



FLO

No.		
99033		10/60

EN Nut collector  
 PL Zbieracz do orzechów  
 DE Nussammler  
 RU Полл для сбора ореха  
 CZ Sběrač ořechů  
 RO Colector nuci  
 HU Diógyűjtő  
 ES Recolector de nueces

127 cm 28 cm SS STAINLESS STEEL STAL NIERDZEWNA



FLO

No.	L [cm]	
89890	127	2

EN Cultivator  
 PL Pazurki  
 DE Grubber  
 RU Рыхлитель  
 CZ Kultivátor  
 RO Cultivator  
 HU Kultivátor  
 ES Escarifi cador

395 mm



FLO

No.	L [mm]	
99038	395	24/48

EN Patio weeder  
 PL Chwastownik  
 DE Fugenkratzer  
 RU Очиститель щелевой  
 CZ Čistič mezer  
 RO Cuijt pt. curățat dale  
 HU Fugakaparó  
 ES Musgo cuchillo

320 mm



FLO

No.	L [mm]	
99040	320	24/48

EN Fruit pick up tool  
 PL Zbierak do owoców  
 DE Obstpflücker  
 RU Съёмник для фруктов  
 CZ Sběrač ovoce  
 RO Culegator pt. fructe  
 HU Karos gyümölcszedő  
 ES Recolector de frutas

160 mm



FLO

No.	Ø [mm]	
89880	160	12/48

EN Nut collector  
 PL Zbieracz do orzechów  
 DE Nussammler  
 RU Полл для сбора ореха  
 CZ Sběrač ořechů  
 RO Colector nuci  
 HU Diógyűjtő  
 ES Recolector de nueces

105-145 cm 28 cm SS STAINLESS STEEL STAL NIERDZEWNA TELESCOPIC HANDLE ÜCHWYTT TELESKOPIWY AI

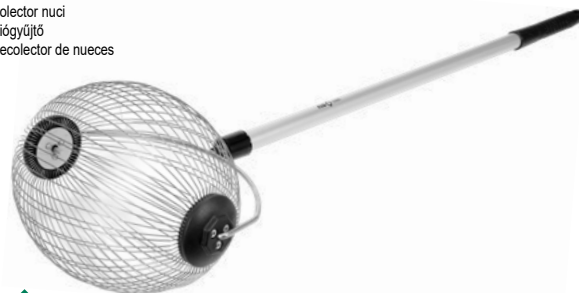

FLO

No.	L [cm]	
89891	105-145	2

EN Multifunctional shovel  
 PL Saperka wielofunkcyjna  
 DE Kombi-Faltschaufel  
 RU Сопёрная лопата многофункциональная  
 CZ Lopatka víceúčelová  
 RO Lopata multifunctionala  
 HU Többfunkciós ásó  
 ES Zapadora multifuncion

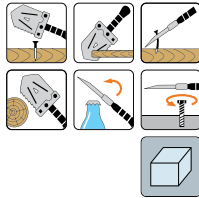

FLO

No.	36
99053	

EN Garden tool set  
 PL Komplet narzędzi ogrodowych  
 DE Garten-Kleingerätesatz  
 RU Набор садово-огородного инструмента  
 CZ Sada zahradnického náčiní  
 RO Set pt. grădinarit  
 HU Kertész készlet  
 ES Juego de herramientas de jardín



FLO

No.	L [mm]	50
99028	205	

EN Transplanting spade  
 PL Szpadel szkółkarski  
 DE Baumschulspaten  
 RU Лопата для саженцев  
 CZ Školkařský ryč  
 RO Cazma pt. plantat  
 HU Faiskolai ásó  
 ES Pala de vivero



FLO

No.	Handle type / Typ trzonka	140
35811	DY	

EN Flat spade  
 PL Szpadel prosty  
 DE Rodespaten  
 RU Заступ  
 CZ Ryč rovný  
 RO Hârleț cu coadă  
 HU Egyenes ásó  
 ES Pala recta



FLO

No.	Handle type / Typ trzonka	200
35809	DY	

EN Folding shovel  
 PL Saperka składana  
 DE Faltschaufel  
 RU Сопёрная лопата складная  
 CZ Lopatka skládací  
 RO Lopata demontabila  
 HU Összecsukható ásó  
 ES Zapadora desmontable



FLO

No.	36
99054	

EN Garden roller  
 PL Walec ogrodowy  
 DE Gartenwalze  
 RU Садовый каток  
 CZ Zahradní válec  
 RO Tavalug gazon  
 HU Kerti henger  
 ES Rodillo de jardín



FLO

No.	Working part width / Szerokość części roboczej [mm]	1
88720	500	

EN Flat spade  
 PL Szpadel prosty  
 DE Rodespaten  
 RU Заступ  
 CZ Ryč rovný  
 RO Hârleț cu coadă  
 HU Egyenes ásó  
 ES Pala recta



FLO

No.	Handle type / Typ trzonka	140
35720	DY	

EN Flat spade  
 PL Szpadel prosty  
 DE Rodespaten  
 RU Заступ  
 CZ Ryč rovný  
 RO Hârleț cu coadă  
 HU Egyenes ásó  
 ES Pala recta



No.	Handle type / Typ trzonka	
35836	DY	6

EN Sharp spade  
 PL Szpadel ostry  
 DE Scharfer Spaten  
 RU Штыковая лопата  
 CZ Ryč špičatý  
 RO Hârleț ascuțit  
 HU Hegyes ásó  
 ES Pala puntiaguda



No.	Handle type / Typ trzonka	
35721	DY	140

EN Mini shovel  
 PL Szperka profilowana  
 DE Feldspaten  
 RU Лопата саперная  
 CZ Vojenská lopata  
 RO Lopată mică  
 HU Profilozott ásó  
 ES Zapa perfilada



No.	Handle type / Typ trzonka	
35833	DY	200

EN Sand shovel  
 PL Łopata piaskowa  
 DE Sandschaufel  
 RU Лопата для песка  
 CZ Lopata na písek  
 RO Lopată pt. nisip  
 HU Homoklapát  
 ES Pala para arena



No.	Handle type / Typ trzonka	
35722	DY	120

EN Sharp spade  
 PL Szpadel ostry  
 DE Scharfer Spaten  
 RU Штыковая лопата  
 CZ Ryč špičatý  
 RO Hârleț ascuțit  
 HU Hegyes ásó  
 ES Pala puntiaguda



No.	Handle type / Typ trzonka	
35810	DY	200

EN Sharp spade  
 PL Szpadel ostry  
 DE Scharfer Spaten  
 RU Штыковая лопата  
 CZ Ryč špičatý  
 RO Hârleț ascuțit  
 HU Hegyes ásó  
 ES Pala puntiaguda



No.	Handle type / Typ trzonka	
35837	DY	6

EN Sand shovel  
 PL Łopata piaskowa  
 DE Sandschaufel  
 RU Лопата для песка  
 CZ Lopata na písek  
 RO Lopată pt. nisip  
 HU Homoklapát  
 ES Pala para arena



No.	Handle type / Typ trzonka	
35843	DY	120

EN Sand shovel  
 PL Łopata piaskowa  
 DE Sandschaufel  
 RU Лопата для песка  
 CZ Lopata na písek  
 RO Lopată pt. nisip  
 HU Homoklapát  
 ES Pala para arena



No.	Handle type / Typ trzonka	
35835	DY	6



EN Sand shovel  
 PL Łopata piaskowa  
 DE Sandschaufel  
 RU Лопата для песка  
 CZ Lopata na písek  
 RO Lopată pt. nisip  
 HU Homoklapát  
 ES Pala para arena

130 cm DY



FLO

No.	Handle type / Typ trzonka	
35861	DY	120

EN Coal shovel  
 PL Łopata węglowa  
 DE Kohlschaufel  
 RU Лопата для угля  
 CZ Lopata na uhlí  
 RO Lopată pt. carbune  
 HU Szénlapát  
 ES Pala para carbón

No 2 DY



FLO

No.	Handle type / Typ trzonka	
35863	DY	120

EN Rake  
 PL Grabie  
 DE Rechen  
 RU Грабли  
 CZ Hrábě  
 RO Greblă  
 HU Gereblye  
 ES Rastrillo

130 cm P



FLO

No.	Number of teeth / Liczba zębów	Handle type / Typ trzonka	
35756	10	P	250
35757	12	P	250
35758	14	P	250
35759	16	P	250

EN Hand cultivator with handle  
 PL Kultywator ręczny oprawiony  
 DE Handkultivator, eingefasst  
 RU Культиватор ручной садовый  
 CZ Ruční kultivátor s násadou  
 RO Cultivator cu maner  
 HU Kézi kultivátor, nyeles  
 ES Cultivador manual enmarcado

P



FLO

No.	Handle type / Typ trzonka	
35701	P	250

EN Gardening shovel  
 PL Łopata kanadyjska  
 DE Kanadischer Spaten  
 RU Канадская лопата  
 CZ Kanadská lopata  
 RO Hariet gradina  
 HU Kanadai lapát  
 ES Pala canadiense

130 cm DY



FLO

No.	Handle type / Typ trzonka	
35855	DY	140

EN Digging fork  
 PL Widły  
 DE Grabegabel  
 RU Вилы  
 CZ Zahradnické vidlice  
 RO Furcă pt. grădinărit  
 HU Vasvilla  
 ES Horca

DY



FLO

No.	Handle type / Typ trzonka	
35817	DY	200

EN Garden hoe  
 PL Motyka ogrodowa  
 DE Gartenhacke  
 RU Тяпка садовая  
 CZ Zahradní motyka  
 RO Sapaliga gradina  
 HU Kerti kapa  
 ES Azada de jardín

120 cm P



FLO

No.	Working width / Szerokość robocza [mm]	Handle type / Typ trzonka	
35761	120	P	500
35762	140	P	500

EN Cultivator  
 PL Pazurki  
 DE Grubber  
 RU Рыхлитель  
 CZ Kultivátor  
 RO Cultivator  
 HU Kultivátor  
 ES Escarifi cador

P



FLO

No.	Handle type / Typ trzonka	
35705	P	500

EN Spring rake  
 PL Grabie wachlarzowe  
 DE Laubrechen  
 RU Грабли веерные  
 CZ Hrábě na listí  
 RO Greblă evantai  
 HU Lombseprű  
 ES Rastrillo para hojas

120 cm



No.	Working width / Szerokość robocza [mm]	Number of teeth / Liczba zębów	
35799	400	21	250

EN Earth auger  
 PL Świder do gleby  
 DE Erdbohrer  
 RU Бур шнековый  
 CZ Zemní vrták  
 RO Burghiu pt. pământ  
 HU Talajfúró  
 ES Taladro de tierra



No.	Working diameter / Średnica robocza [mm]	
35667	110	50
35668	140	50
35670	170	50
35669	200	30
35672	230	25
35671	250	24

EN Long handle steel edger  
 PL Nóż do darni  
 DE Rasenkantenstecher  
 RU Полулунный нож для обрезки краев дерна  
 CZ Nůz na okraje trávníku  
 RO Tăietor de borduri  
 HU Gyepgondozás  
 ES Cortador de bordes para césped



No.	Working width / Szerokość robocza [mm]	Handle type / Typ trzonka	
35680	200	T	250

EN Flat spade  
 PL Szpadel prosty  
 DE Rodespaten  
 RU Заступ  
 CZ Rýč rovný  
 RO Hârleț cu coadă  
 HU Egyenes ásó  
 ES Pala recta

117 cm



No.	Handle type / Typ trzonka	
35800	T	140

EN Adjustable leaf rake  
 PL Grabie wachlarzowe regulowane  
 DE Verstellbarer Laubrechen  
 RU Регулируемые веерные грабли  
 CZ Hrábě na listí nastavitelné  
 RO Greblă evantai reglabilă  
 HU Állítható kerti lombseprű  
 ES Rastrillo para hojas ajustable



No.	Working width / Szerokość robocza [mm]	Number of teeth / Liczba zębów	
35797	255-580	20	5

EN Manual cultivator  
 PL Kultywator ręczny  
 DE Handgrubber  
 RU Ручной культиватор  
 CZ Ruční kultivátor  
 RO Cultivator manual  
 HU Kézi kultivátor  
 ES Cultivador manual

∅ 22 mm

95x50 cm



No.	Working width / Szerokość robocza [mm]	
35677	500	12

EN Cut lawn edger  
 PL Obcinarka do krawędzi trawnika  
 DE Kantenschneider  
 RU Инструмент для обрезки края газона  
 CZ Rezačka okrajů trávníku  
 RO Tăietor marginii de gazon de grădină  
 HU Gyepszegélyvágó  
 ES Cortadora de bordes de césped

114 cm

150x1.5 mm

65Mn PVC



No.	Working part diameter / Średnica części roboczej [mm]	
35685	150	1

EN Flat spade  
 PL Szpadel prosty  
 DE Rodespaten  
 RU Заступ  
 CZ Rýč rovný  
 RO Hârleț cu coadă  
 HU Egyenes ásó  
 ES Pala recta

117 cm



No.	Handle type / Typ trzonka	
35802	T	140

EN Flat spade  
 PL Szpadel prosty  
 DE Rodespaten  
 RU Заступ  
 CZ Rýč rovný  
 RO Hârleț cu coadă  
 HU Egyenes ásó  
 ES Pala recta



No.	Handle type / Typ trzonka	
35801	T	200

EN Flat spade  
 PL Szpadel prosty  
 DE Rodespaten  
 RU Заступ  
 CZ Rýč rovný  
 RO Hârleț cu coadă  
 HU Egyenes ásó  
 ES Pala recta



No.	Handle type / Typ trzonka	
35805	DY	140

EN Drainage spade  
 PL Szpadel drenarski  
 DE Drainagespaten  
 RU Дренажная лопата  
 CZ Drenážní rýč  
 RO Cazma îngusta  
 HU Drénező ásó  
 ES Pala de drenaje



No.	Handle type / Typ trzonka	
35807	T	140

EN Sand shovel  
 PL Łopata piaskowa  
 DE Sandschaufel  
 RU Лопата для песка  
 CZ Lopata na písek  
 RO Lopată pt. nisip  
 HU Homoklapát  
 ES Pala para arena



No.	Handle type / Typ trzonka	
35839	DY	120

EN Flat spade  
 PL Szpadel prosty  
 DE Rodespaten  
 RU Заступ  
 CZ Rýč rovný  
 RO Hârleț cu coadă  
 HU Egyenes ásó  
 ES Pala recta



No.	Handle type / Typ trzonka	
35803	DY	140

EN Sharp spade  
 PL Szpadel ostry  
 DE Scharfer Spaten  
 RU Штыковая лопата  
 CZ Rýč špičatý  
 RO Hârleț ascuțit  
 HU Hegyes ásó  
 ES Pala puntiaguda



No.	Handle type / Typ trzonka	
35806	DY	140

EN Drainage spade  
 PL Szpadel drenarski  
 DE Drainagespaten  
 RU Дренажная лопата  
 CZ Drenážní rýč  
 RO Cazma îngusta  
 HU Drénező ásó  
 ES Pala de drenaje



No.	Handle type / Typ trzonka	
35808	DY	140

EN Sand shovel  
 PL Łopata piaskowa  
 DE Sandschaufel  
 RU Лопата для песка  
 CZ Lopata na písek  
 RO Lopată pt. nisip  
 HU Homoklapát  
 ES Pala para arena



No.	Handle type / Typ trzonka	
35840	T	200

EN Shovel  
 PL Łopata  
 DE Schaufel  
 RU Лопата  
 CZ Lopata  
 RO Lopată  
 HU Lapát  
 ES Pala

DY AI



No.	Handle type / Typ trzonka	
35846	DY	100

EN Coal shovel  
 PL Łopata węglowa  
 DE Kohlschaufel  
 RU Лопата для угля  
 CZ Lopata na uhlí  
 RO Lopată pt. carbune  
 HU Szénlapát  
 ES Pala para carbón

№ 3 DY



No.	Handle type / Typ trzonka	
35860	DY	90

EN Digging fork  
 PL Widły  
 DE Grabegabel  
 RU Вилы  
 CZ Zahradnické vidlice  
 RO Furcă pt. grădinărit  
 HU Vasvilla  
 ES Horca

P



No.	Number of teeth / Liczba zębów	Handle type / Typ trzonka	
35815	3	P	100
35816	4	P	200

EN Digging fork  
 PL Widły  
 DE Grabegabel  
 RU Вилы  
 CZ Zahradnické vidlice  
 RO Furcă pt. grădinărit  
 HU Vasvilla  
 ES Horca

x4 TEETH ZĘBY DY



No.	Number of teeth / Liczba zębów	Handle type / Typ trzonka	
35813	4	DY	140

EN Coal shovel  
 PL Łopata węglowa  
 DE Kohlschaufel  
 RU Лопата для угля  
 CZ Lopata na uhlí  
 RO Lopată pt. carbune  
 HU Szénlapát  
 ES Pala para carbón

№ 2 T



No.	Handle type / Typ trzonka	
35850	T	120

EN Sand shovel  
 PL Łopata piaskowa  
 DE Sandschaufel  
 RU Лопата для песка  
 CZ Lopata na písek  
 RO Lopată pt. nisip  
 HU Homoklapát  
 ES Pala para arena

130 cm P



No.	L [cm]	Handle type / Typ trzonka	
35842	130	P	100

EN Digging fork  
 PL Widły  
 DE Grabegabel  
 RU Вилы  
 CZ Zahradnické vidlice  
 RO Furcă pt. grădinărit  
 HU Vasvilla  
 ES Horca

x4 TEETH ZĘBY DY



No.	Number of teeth / Liczba zębów	Handle type / Typ trzonka	
35865	4	DY	140

EN Digging fork  
 PL Widły  
 DE Grabegabel  
 RU Вилы  
 CZ Zahradnické vidlice  
 RO Furcă pt. grădinărit  
 HU Vasvilla  
 ES Horca

x4 TEETH ZĘBY DY



No.	Number of teeth / Liczba zębów	Handle type / Typ trzonka	
35864	4	DY	140



EN Digging fork  
 PL Widły  
 DE Grabegabel  
 RU Вилы  
 CZ Zahradnické vidlice  
 RO Furcă pt. grădinărit  
 HU Vasvilla  
 ES Horca

120 cm FIBERGLASS WŁÓKNO SZKLANE DY



No.	Number of teeth / Liczba zębów	Handle type / Typ trzonka	
35890	4	DY	6

EN Digging fork  
 PL Widły  
 DE Grabegabel  
 RU Вилы  
 CZ Zahradnické vidlice  
 RO Furcă pt. grădinărit  
 HU Vasvilla  
 ES Horca

120 cm FIBERGLASS WŁÓKNO SZKLANE DY



No.	Number of teeth / Liczba zębów	Handle type / Typ trzonka	
35892	4	DY	6

EN Cultivator  
 PL Pazurki  
 DE Grubber  
 RU Рылитель

CZ Kultivátor  
 RO Cultivator  
 HU Kultivátor  
 ES Escarifi cador

125 cm P



No.	Handle type / Typ trzonka	
35763	P	5

EN Rake  
 PL Grabie  
 DE Rechen  
 RU Грабли  
 CZ Hrábě  
 RO Greblă  
 HU Gereblye  
 ES Rastrillo

150 cm



No.	L [cm]	Number of teeth / Liczba zębów	
35779	150	12	150
35780	150	16	155

EN Household forks  
 PL Widły gospodarcze  
 DE Mistgabel  
 RU Вилы хозяйственные  
 CZ Hospodářské vidle  
 RO Furca  
 HU Szénavilla  
 ES Horquilla

120 cm FIBERGLASS WŁÓKNO SZKLANE DY



No.	Number of teeth / Liczba zębów	Handle type / Typ trzonka	
35891	4	DY	6

EN Weed puller  
 PL Wyrywacz chwastów  
 DE Unkrautentferner  
 RU Приспособление для вырывания сорняков  
 CZ Vytrhávač plevelu  
 RO Dispozitiv de scos buruieni  
 HU Gyomkihúzó  
 ES Extractor de maleza

19 mm 98x21,5 cm ABS



No.	Working width / Szerokość robocza [mm]	
35673	215	12

EN Rake  
 PL Grabie  
 DE Rechen  
 RU Грабли

CZ Hrábě  
 RO Greblă  
 HU Gereblye  
 ES Rastrillo

P



No.	Number of teeth / Liczba zębów	Handle type / Typ trzonka	
35740	6	P	10
35741	8	P	10
35781	10	P	10
35782	12	P	10
35783	16	P	10
35784	14	P	10

EN Spring rake  
 PL Grabie wachlarzowe  
 DE Laubrechen  
 RU Грабли веерные  
 CZ Hrábě na listí  
 RO Greblă evantai  
 HU Lombseprű  
 ES Rastrillo para hojas

390 mm



FLO

No.	Working width / Szerokość robocza [mm]	Number of teeth / Liczba zębów	
35798	390	21	58

EN Spring rake  
 PL Grabie wachlarzowe  
 DE Laubrechen  
 RU Грабли веерные  
 CZ Hrábě na listí  
 RO Greblă evantai  
 HU Lombseprű  
 ES Rastrillo para hojas

530 mm



FLO

No.	Working width / Szerokość robocza [mm]	
99400	530	24

EN Hoe and cultivator  
 PL Spulchniacz z motyczką  
 DE Doppelhacke mit 2 Zinken  
 RU Рыхлитель с мотыгой  
 CZ Kultivátor s motykou  
 RO Cultivator cu sapaliga  
 HU Kerti villás kapa  
 ES Cultivador con azada

P



FLO

No.	Handle type / Typ trzonka	
35792	P	5

EN Garden hoe  
 PL Motyka ogrodowa  
 DE Gartenhacke  
 RU Тяпка садовая  
 CZ Zahradní motyka  
 RO Sapaliga gradina  
 HU Kerti kapa  
 ES Azada de jardín

P



FLO

No.	Working width / Szerokość robocza [mm]	Handle type / Typ trzonka	
35773	120	P	500
35774	140	P	500
35776	160	P	500

EN Spring rake  
 PL Grabie wachlarzowe  
 DE Laubrechen  
 RU Грабли веерные  
 CZ Hrábě na listí  
 RO Greblă evantai  
 HU Lombseprű  
 ES Rastrillo para hojas

X



FLO

No.	Working width / Szerokość robocza [mm]	L [cm]	Number of teeth / Liczba zębów	
35785	435	145	23	12

EN Hoe and cultivator  
 PL Motyczka z pazurkami  
 DE Kleinhacke  
 RU Рыхлитель комбинированный  
 CZ Motyczka s kultivátorem  
 RO Cultivator cu sapaliga  
 HU Kerti villás kapa  
 ES Escarificador y azadilla

P



FLO

No.	Handle type / Typ trzonka	
35764	P	5

EN Garden hoe  
 PL Motyka ogrodowa  
 DE Gartenhacke  
 RU Тяпка садовая  
 CZ Zahradní motyka  
 RO Sapaliga gradina  
 HU Kerti kapa  
 ES Azada de jardín

P



FLO

No.	Working width / Szerokość robocza [mm]	Handle type / Typ trzonka	
35770	170	P	5

EN Garden hoe  
 PL Motyka ogrodowa  
 DE Gartenhacke  
 RU Тяпка садовая  
 CZ Zahradní motyka  
 RO Sapaliga gradina  
 HU Kerti kapa  
 ES Azada de jardín

P



FLO

No.	Working width / Szerokość robocza [mm]	Handle type / Typ trzonka	
35777	170	P	5

EN Plastic rake  
 PL Grabie plastikowe  
 DE Plasteharken  
 RU Грабли пластиковые  
 CZ Plastové hrábě  
 RO Greblă de plastic  
 HU Műanyag gereblye  
 ES Rastrillo de plástico



No.	Working width / Szerokość robocza [mm]	Number of teeth / Liczba zębów	
35788	550	16	10
35789	590	18	10

EN Rake  
 PL Grabie  
 DE Rechen  
 RU Грабли  
 CZ Hrábě  
 RO Greblă  
 HU Gereblye  
 ES Rastrillo

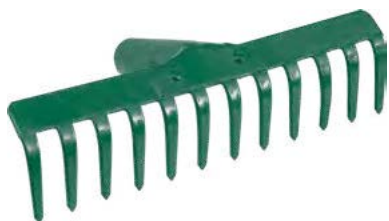

No.	Working width / Szerokość robocza [mm]	Number of teeth / Liczba zębów	
35750	270	12	48
35751	340	14	28

EN Spring rake  
 PL Grabie wachlarzowe  
 DE Laubrechen  
 RU Грабли веерные  
 CZ Hrábě na listí  
 RO Greblă evantai  
 HU Lombseprű  
 ES Rastrillo para hojas



No.	Working width / Szerokość robocza [mm]	Number of teeth / Liczba zębów	
35786	435	23	10

EN Spring rake  
 PL Grabie wachlarzowe  
 DE Laubrechen  
 RU Грабли веерные  
 CZ Hrábě na listí  
 RO Greblă evantai  
 HU Lombseprű  
 ES Rastrillo para hojas



No.	Working width / Szerokość robocza [mm]	Number of teeth / Liczba zębów	
35790	435	20	20
35791	580	27	20

EN Grass cultivator  
 PL Wertykulator do trawy  
 DE Schneidrechen  
 RU Грабли азрационные  
 CZ Kultivátor oboustranný  
 RO Cultivator  
 HU Kétoldalas talajazító, gypepez  
 ES Cultivador de dos lados



No.	Working width / Szerokość robocza [mm]	
35700	380	5/10

EN Rake  
 PL Grabie  
 DE Rechen  
 RU Грабли  
 CZ Hrábě  
 RO Greblă  
 HU Gereblye  
 ES Rastrillo



No.	Working width / Szerokość robocza [mm]	Number of teeth / Liczba zębów	
35755	360	14	20

EN Spring rake  
 PL Grabie wachlarzowe  
 DE Laubrechen  
 RU Грабли веерные  
 CZ Hrábě na listí  
 RO Greblă evantai  
 HU Lombseprű  
 ES Rastrillo para hojas



No.	Working width / Szerokość robocza [mm]	Number of teeth / Liczba zębów	
35787	460	20	10

EN Spring rake  
 PL Grabie wachlarzowe  
 DE Laubrechen  
 RU Грабли веерные  
 CZ Hrábě na listí  
 RO Greblă evantai  
 HU Lombseprű  
 ES Rastrillo para hojas



No.	Working width / Szerokość robocza [mm]	
99390	410	40

EN Spring rake  
 PL Grabie wachlarzowe  
 DE Laubrechen  
 RU Грабли веерные  
 CZ Hrábě na listí  
 RO Greblă evantai  
 HU Lombseprű  
 ES Rastrillo para hojas



460 mm



No.	Working width / Szerokość robocza [mm]	
99391	460	50

EN Cultivator  
 PL Pazurki  
 DE Grubber  
 RU Рыхлитель  
 CZ Kultivátor  
 RO Cultivator  
 HU Kultivátor  
 ES Escarifi cador



No.	Working width / Szerokość robocza [mm]	
35793	100	60
35794	130	40

EN Hoe  
 PL Motyczka  
 DE Garten Handhacke  
 RU Мотыжка  
 CZ Motyčka  
 RO Sapaliga  
 HU Kerti villás kapa  
 ES Azadilla



160 mm



No.	Working width / Szerokość robocza [mm]	
35775	160	30

EN Hoe and cultivator  
 PL Motyczka z pazurkami  
 DE Kleinhacke  
 RU Рыхлитель комбинированный  
 CZ Motyčka s kultivátorem  
 RO Cultivator cu sapaliga  
 HU Kerti villás kapa  
 ES Escarificador y azadilla



70 mm



No.	Working width / Szerokość robocza [mm]	
35795	70	60

EN Spring rake  
 PL Grabie wachlarzowe  
 DE Laubrechen  
 RU Грабли веерные  
 CZ Hrábě na listí  
 RO Greblă evantai  
 HU Lombseprű  
 ES Rastrillo para hojas



425 mm



No.	Working width / Szerokość robocza [mm]	
99401	425	60

EN Cultivator  
 PL Obsypnik  
 DE Häufel  
 RU Культиватор  
 CZ Zасыpávač  
 RO Cultivator  
 HU Kultivátor  
 ES Arado



190 mm



No.	Working width / Szerokość robocza [mm]	
35710	190	5/15

EN Hoe and cultivator  
 PL Motyczka z pazurkami  
 DE Kleinhacke  
 RU Рыхлитель комбинированный  
 CZ Motyčka s kultivátorem  
 RO Cultivator cu sapaliga  
 HU Kerti villás kapa  
 ES Escarificador y azadilla



75 mm



No.	Working width / Szerokość robocza [mm]	
35760	75	60

EN Broom  
 PL Miotła  
 DE Strassenbesen  
 RU Метла  
 CZ Metla  
 RO Matura  
 HU Partvis  
 ES Cepillo pelo largo



No.	Bristle length / Długość włosia [mm]	
35905	275	12



EN Broom  
PL Miotła  
DE Strassenbesen  
RU Метла  
CZ Metla  
RO Matura  
HU Partvis  
ES Cepillo pelo largo



No.	Bristle length / Długość włosia [mm]	
35906	135	12

EN Broom  
PL Miotła  
DE Strassenbesen  
RU Метла  
CZ Metla  
RO Matura  
HU Partvis  
ES Cepillo pelo largo



No.	Bristle length / Długość włosia [mm]	
35908	210	8

EN Wire paving brush  
PL Szczotka do bruku z radełkiem  
DE Bürste mit Schaber für  
Reinigung von Pflastersteinen  
RU Щетка для тротуарной плитки  
с шипом  
CZ Kartáč do dlažby s rádýlkem  
RO Perie din sarma pt. pavaj  
HU Járdakefe pengével  
ES Cepillo para adoquines, con  
ruedas de trazado



No.	L [mm]	
35927	1460	10

EN Lawn mover brush  
PL Szczotka do kosiarki  
DE Rasenmäher Reinigungsbürste mit Schaber  
RU Щетка для очистки газонокосилки  
CZ Kartáč na čištění sekačky  
RO Perie pt. curatat motocoase  
HU Ecset a kaszák tisztításához  
ES Cepillo limpieza



No.	Working width / Szerokość robocza [mm]	L [mm]	
35950	50	310	15

EN Sickle  
PL Sierp  
DE Sichel  
RU Сеп  
CZ Srp  
RO Secera  
HU Sarló  
ES Hoz



No.	
35832	30

EN Forged scythe  
PL Kosa kuta  
DE Sensenklänge geschmiedet  
RU Коса  
CZ Kosa kovaná  
RO Lama de coasa  
HU Kovácsolt kasza  
ES Guadana forjada



No.	Type / Typ	
35824	No 6	25
35826	No 7	25
35828	No 8	25

EN Stake for scythe  
PL Klepadło do kosy  
DE Dengelamboss für Sensen  
RU Бабка для отбивки кос (наковальня)  
CZ Naklepávací kovadlinka  
RO Inel de stângere pt. coasă  
HU Kaszarógzó gyűrű  
ES Anillo para guadanar



No.	
35821	30

EN Ring for scythe  
PL Pierścień do kosy  
DE Sensenring  
RU Кольцо для косы  
CZ Kroužek na kosu  
RO Inel pt. coasa  
HU Kasza bilincs  
ES Anillo para guadaña



GALVANIZED  
STEEL  
STAL  
OCYNKOWANA



No.	
35823	30

EN Wedge for scythe  
PL Klin drewniany do kosy  
DE Holzkeil für Sensen  
RU Клиn деревянный  
для косы  
CZ Klín dřevěný na kosu  
RO Pană de lemn pt. coasă  
HU Faék kaszához  
ES Cuna de madera para  
guadanar



No.	
35831	12/144

EN Wooden handle for scythe  
 PL Trzonek do kosy  
 DE Sensesstiel  
 RU Косовище деревянное  
 CZ Násada na kosu  
 RO Coadă de coasă  
 HU Kaszanyél  
 ES Astil para guadas

174  
cm



No.	L [cm]	
35830	174	10

EN Wooden handle for shovel  
 PL Trzonek do łopaty  
 DE Schaufelstiel gerade  
 RU Черенок для лопаты  
 CZ Násada na lopatu  
 RO Coadă din lemn  
 HU Lapátnyél  
 ES Astil para pala

130  
cm

P



No.	L [cm]	Type / Typ	
99410	130	P	10

EN Wooden handle for broom  
 PL Trzonek do miotły ulicznej  
 DE Stiel für einen Straßenbesen  
 RU Черенок для метлы  
 CZ Násada na silniční metlu  
 RO Coadă matură cu filet  
 HU Utcaseprű nyél  
 ES Palo de escoba de calle

125  
cm



VOREL

No.	L [cm]	
99420	125	25

EN Broom handle with thread  
 PL Trzonek do miotły z gwintem  
 DE Besenstiel, holz, mit Gewinde  
 RU Черенок для метлы с резьбой  
 CZ Násada na metlu se závitem  
 RO Coadă de mătură cu filet  
 HU Menetes seprűnyél  
 ES Astil para escoba con rosca

120  
cm

P



No.	L [cm]	Ø [mm]	Type / Typ	
99416	120	22	P	25

EN Wooden handle  
 PL Trzonek uniwersalny  
 DE Universalstiel  
 RU Черенок для грабеля  
 CZ Násada univerzální  
 RO Coadă din lemn  
 HU Univerzális nyél  
 ES Astil universal

P



No.	L [cm]	Ø [mm]	Type / Typ	
99403	100	28	P	25
99404	110	28	P	25
99402	130	28	P	25
99408	150	28	P	25

EN Wooden handle  
 PL Trzonek do grabi wachlarzowych  
 DE Schaufelstiel P-Griff  
 RU Черенок для лопаты  
 CZ Násada na lopatu  
 RO Coadă de lopată cu maner  
 HU Lapátnyél  
 ES Astil para pala

130  
cm

P



No.	L [cm]	Ø [mm]	Type / Typ	
99415	130	22	P	25

EN Wooden handle for broom  
 PL Trzonek do miotły ulicznej  
 DE Stiel für einen Straßenbesen  
 RU Черенок для метлы  
 CZ Násada na silniční metlu  
 RO Coadă matură cu filet  
 HU Utcaseprű nyél  
 ES Palo de escoba de calle

150  
cm



No.	L [cm]	
99421	150	25

EN Broom handle with thread  
 PL Trzonek do miotły z gwintem  
 DE Besenstiel, holz, mit Gewinde  
 RU Черенок для метлы с резьбой  
 CZ Násada na metlu se závitem  
 RO Coadă de mătură cu filet  
 HU Menetes seprűnyél  
 ES Astil para escoba con rosca

120  
cm

P



No.	L [cm]	Type / Typ	
99418	120	P	25

EN Steel handle with thread  
 PL Trzonek metalowy z gwintem  
 DE Besenstiel mit Gewinde  
 RU Черенок с резьбой  
 CZ Násada na metlu se závitem  
 RO Coadă cu filet  
 HU Menetes seprűnyél  
 ES Astil para escoba con rosca

118 cm P



No.	L [cm]	Ø [mm]	
99419	118	21	24

EN Wooden handle for shovel  
 PL Trzonek do łopaty  
 DE Schaufelstiel gerade  
 RU Черенок для лопаты  
 CZ Násada na lopatu  
 RO Coadă din lemn  
 HU Lapátnyél  
 ES Astil para pala

115 cm T



No.	L [cm]	Type / Typ	
99409	115	T	10

EN Wooden handle  
 PL Trzonek  
 DE Schaufelstiel D-Griff  
 RU Черенок для лопат  
 CZ Násada na lopatu  
 RO Coadă de lopata cu maner  
 HU Lapátnyél  
 ES Astil para pala

90 cm DY



No.	L [cm]	Type / Typ	
99413	90	DY	10

EN Handle for hammer-axe  
 PL Trzonek do siekiero-młota  
 DE Stiel für Hammeraxt  
 RU Черенок для топора  
 CZ Násada na sekery  
 RO Coadă din lemn  
 HU Baltanyél  
 ES Astil para hachuela

90 cm



No.	L [cm]	For head / Do obucha [kg]	
99405	90	2.5	10
99406	90	4.0	10

EN Handle „T” for spade  
 PL Trzonek do szpadla  
 DE Spadelstiel T-griff  
 RU Черенок для лопаты  
 CZ Násada na rýč  
 RO Coadă din lemn  
 HU Ásónyél  
 ES Astil para laya

90 cm T



No.	L [cm]	Type / Typ	
99407	90	T	10

EN Wooden handle  
 PL Trzonek  
 DE Schaufelstiel D-Griff  
 RU Черенок для лопаты  
 CZ Násada na lopatu  
 RO Coadă de lopata cu maner  
 HU Lapátnyél  
 ES Astil para pala

90 cm DY



No.	L [cm]	Type / Typ	
99412	90	DY	10

EN Wooden handle for hammer-axe  
 PL Trzonek do toporka  
 DE Beilstiel  
 RU Черенок для топора  
 CZ Násada na sekery - kálač  
 RO Coadă de topor  
 HU Ácszekerke nyél  
 ES Astil para hacha con martillo



No.	L [cm]	For head / Do obucha [kg]	
99425	36	0.6	75
99426	40	0.8	25

EN Axe handle  
 PL Trzonek do siekiery  
 DE Axtstiel  
 RU Рукьятка топора  
 CZ Topírko do sekery  
 RO Cap de topor  
 HU Baltanyél  
 ES Astil de hacha



No.	L [cm]	For head / Do obucha [kg]	
99427	50	1.0	25
99428	60	1-1.25	25
99429	70	1.25-1.8	25

- EN Axe handle
- PL Trzonek do siekiery
- DE Axtstiel
- RU Рукотка топора
- CZ Topůrko do sekery
- RO Cap de topor
- HU Báltányél
- ES Astil de hacha



No.	L [cm]	For head / Do obucha [kg]	
99430	80	1.8-2.0	25

- EN Pressure sprayer
- PL Spryskiwacz ciśnieniowy ręczny
- DE Drucksprüher
- RU Опрыскиватель ручной
- CZ Ruční tlakový postřikovač
- RO Vermorel
- HU Permetező kézi
- ES Rociador de presión, de mano



No.	Tank capacity / Pojemność zbiornika [l]	
89507	1.0	20
89508	1.5	15
89509	2.0	15

- EN Pressure sprayer
- PL Opyskiwacz ciśnieniowy plecakowy
- DE Rücken-Drucksprüher
- RU Опрыскиватель ручной ранцевый
- CZ Tlakový postřikovač zádový
- RO Pulverizator portabil
- HU Permetező hát
- ES Rociador de presión tipo „mochila”



No.	Tank capacity / Pojemność zbiornika [l]	
89520	8	6

- EN Hammer handle
- PL Trzonek do młotka
- DE Hammerstiel
- RU Рукотка молотка
- CZ Topůrko do kladiva
- RO Cap de ciocan
- HU Kalapácsnyél
- ES Astil de martillo



No.	L [cm]	For head / Do obucha [kg]	
99435	28	0.1-0.3	65
99436	32	0.3-0.7	65
99438	36	0.7-1.5	65
99440	40	0.8-2.0	50
99442	50	2.0-3.0	50
99443	60	3.0-4.0	25
99444	70	4.0-6.0	25
99445	80	5.0-8.0	25
99446	90	8.0-10.0	10

- EN Pressure sprayer
- PL Opyskiwacz ciśnieniowy
- DE Drucksprüher
- RU Опрыскиватель ручной
- CZ Ruční tlakový postřikovač
- RO Pulverizator de mana
- HU Permetező kézi
- ES Rociador de presión

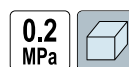

No.	Tank capacity / Pojemność zbiornika [l]	
89515	5	6
89518	8	6

- EN Pressure sprayer
- PL Opyskiwacz ciśnieniowy plecakowy
- DE Rücken-Drucksprüher
- RU Опрыскиватель ручной ранцевый
- CZ Tlakový postřikovač zádový
- RO Pulverizator portabil
- HU Permetező hát
- ES Rociador de presión tipo „mochila”

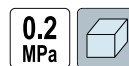

No.	Tank capacity / Pojemność zbiornika [l]	
89526	15	1
89528	20	1



EN Battery sprayer  
 PL Opryskiwacz akumulatorowy  
 DE Akku-Sprühgerät  
 RU Аккумуляторный опрыскиватель  
 CZ Bateriový postřikovač  
 RO Vermorel cu acumulator  
 HU Akkumulátoros permetező  
 ES Pulverizador a batería



12V 0.15-0.4 MPa 3.1 l/min 16L  
 8.0 Ah PE SS STAINLESS STEEL STAL NIERZYSZCZONA



No.	Voltage / Napiecie [V d.c.]	Tank capacity / Pojemność zbiornika [l]	
89610	12	16	1

EN Pump for pressure sprayer  
 PL Pompka do spryskiwacza  
 DE Druckpumpe für Drucksprüher  
 RU Насос на опрыскиватели

CZ Pumpa do postřikovače  
 RO Pompa pt. vermored  
 HU Szivattyú esőztetőhöz  
 ES Bomba para el rociador



No.	For / Dla	
89536	89515, 89518, 89520	60

EN Spray nozzle set  
 PL Zestaw końcówek rozpylających  
 DE Spritzdüsenatz  
 RU Форсунки сменные для опрыскивателей

CZ Sada rozprašovacích koncovek  
 RO Set racorduri vermored  
 HU Porlasztó tömlővég készlet  
 ES Juego de boquillas rociadores



No.	
89538	100

EN Shower spray gun  
 PL Pistolet do opryskiwacza  
 DE Spritzpistole  
 RU Пистолет для опрыскивателей

CZ Rozprašovací pistole na vodu  
 RO Pistol pt. stropit  
 HU Locsoló pisztoly  
 ES Pistola de pulverización ajustable



No.	
89540	200

EN Battery sprayer  
 PL Opryskiwacz akumulatorowy  
 DE Akku-Sprühgerät  
 RU Аккумуляторный опрыскиватель  
 CZ Bateriový postřikovač  
 RO Vermorel cu acumulator  
 HU Akkumulátoros permetező  
 ES Pulverizador a batería



12V 0.15-0.4 MPa 3.1 l/min 16L  
 8.0 Ah PE SS STAINLESS STEEL STAL NIERZYSZCZONA



No.	Voltage / Napiecie [V d.c.]	Tank capacity / Pojemność zbiornika [l]	
89611	12	16	1

EN Straight nozzle for pressure sprayer  
 PL Końcówka rozpylająca do spryskiwaczy  
 DE Sprühdüse für Drucksprüher  
 RU Распылитель на опрыскиватели

CZ Rozprašovací koncovka k postřikovači  
 RO Doza pt. vermored  
 HU Porlasztó tömlővég esőztetőhöz  
 ES Puna de atomización para rociador



No.	For / Dla	
89537	89515, 89518, 89520	300

EN Shower spray gun  
 PL Pistolet do opryskiwacza  
 DE Spritzpistole  
 RU Пистолет для опрыскивателей

CZ Rozprašovací pistole na vodu  
 RO Pistol pt. stropit  
 HU Locsoló pisztoly  
 ES Pistola de pulverización ajustable



No.	
89539	200



- EN Fibreglass spray lance  
 PL Lanza z włókna szklanego  
 DE Fibreglaslanze  
 RU Трубка фиберглассовая
- CZ Násadec postřikovače ze skleněného vlákna  
 RO Lance din fibra de sticla  
 HU Üveggyapot lándzsa  
 ES Lanza de fibra de vidrio



No.	L [cm]	Ø [mm]	
89541	80	8	250

- EN Telescopic handle  
 PL Lanza teleskopowa  
 DE Teleskoplanze  
 RU Штанга телескопическая для опрыскивателя  
 CZ Násadec teleskopický  
 RO Maner telescopic  
 HU Teleszkópos lándzsa  
 ES Lanza telescópica

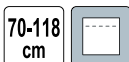

No.	L [cm]	
89542	70-118	100

- EN Set of gaskets for pressure sprayer  
 PL Zestaw uszczelek do spryskiwaczy  
 DE Dichtungssatz für Drucksprüher  
 RU Набор прокладок для опрыскивателя  
 CZ Sada těsnění k postřikovači  
 RO Set de garnituri pt. vermores  
 HU Tömítéskészlet esőztetőhöz  
 ES Juego de juntas para rociadores



No.	For / Dla	
89545	89515, 89518, 89520	500

- EN Slow release watering bag  
 PL Worek nawadniający  
 DE Bewässerungssack  
 RU Мешок для орошения  
 CZ Zavlažovací pytel  
 RO Punga pt. irigat  
 HU Faöntöző zsák  
 ES Bolsa de riego



No.	Capacity / Pojemność [l]	
89715	60	24

- EN 4-nozzle connector  
 PL Przyłącze 4-dyszowe  
 DE Querlanze mit 4 Düsen  
 RU Штанга с 4 форсунками для опрыскивателей (вертикальная)
- CZ Připojka 4-trysková  
 RO Sistem irigatii  
 HU 4-fűvókás csatlakozó  
 ES Conexión de cuatro surtidores



No.	L [cm]	
89543	64.5	100

- EN Set of gaskets for pressure sprayer  
 PL Zestaw uszczelek do spryskiwaczy  
 DE Dichtungssatz für Drucksprüher  
 RU Набор прокладок для опрыскивателя
- CZ Sada těsnění k postřikovači  
 RO Set de garnituri pt. vermores  
 HU Tömítéskészlet esőztetőhöz  
 ES Juego de juntas para rociadores



No.	For / Dla	
89547	89526, 89528	500

- EN Slow release watering bag  
 PL Worek nawadniający  
 DE Bewässerungssack  
 RU Мешок для орошения  
 CZ Zavlažovací pytel  
 RO Punga pt. irigat  
 HU Faöntöző zsák  
 ES Bolsa de riego

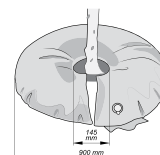
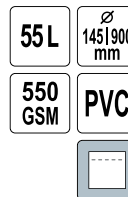

No.	Capacity / Pojemność [l]	
89720	55	20

EN Slow release watering bag  
 PL Worek nawadniający  
 DE Bewässerungssack  
 RU Мешок для орошения  
 CZ Zavlazovací pytel  
 RO Punga pt. iringat  
 HU Faöntöző zsák  
 ES Bolsa de riego



75L  $\varnothing$  145/1000 mm  
 550 GSM PVC

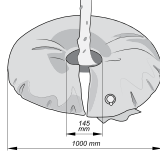

No.	Capacity / Pojemność [l]	
89722	75	20

EN Compressible rain barrel  
 PL Zbiornik na wodę deszczową  
 DE Regenwasserbehälter  
 RU Бак для дождевой воды  
 CZ Nádrž na dešťovou vodu  
 RO Butoi de ploaie compresibil  
 HU Esővízgyűjtő tartály  
 ES Depósito de agua pluvial



250L 60x88 cm  
 3/4" 19mm PVC  
 PP UV



No.	Capacity / Pojemność [l]	
89702	250	6

EN Valves set  
 PL Zestaw zaworów  
 DE Ventil-Set  
 RU Комплект клапанов  
 CZ Sada ventilů  
 RO Set valve  
 HU Szelepkészlet  
 ES Juego de válvulas

3 PCS 3/4" 19mm  
 PVC PP



No.	Hose diameter / Średnica węży	pcs / szt.	
89081	3/4" (19.0 mm)	3	50

EN Lawn edge  
 PL Obrzeże trawnikowe, zielone  
 DE Gartenumrandung  
 RU Ограда для огорода  
 CZ Plastový okraj trávníku  
 RO Gărduj plastic grădină  
 HU Ágyásszegély  
 ES Borde para jardín



No.	H [mm]	L [m]	
88700	100	9	48
88701	150	9	36
88702	200	9	24

EN Compressible rain barrel  
 PL Zbiornik na wodę deszczową  
 DE Regenwasserbehälter  
 RU Бак для дождевой воды  
 CZ Nádrž na dešťovou vodu  
 RO Butoi de ploaie compresibil  
 HU Esővízgyűjtő tartály  
 ES Depósito de agua pluvial



100L 40x78 cm  
 3/4" 19mm PVC  
 PP UV



No.	Capacity / Pojemność [l]	
89700	100	6

EN Compressible rain barrel  
 PL Zbiornik na wodę deszczową  
 DE Regenwasserbehälter  
 RU Бак для дождевой воды  
 CZ Nádrž na dešťovou vodu  
 RO Butoi de ploaie compresibil  
 HU Esővízgyűjtő tartály  
 ES Depósito de agua pluvial



500L 80x98 cm  
 3/4" 19mm PVC  
 PP UV



No.	Capacity / Pojemność [l]	
89704	500	4



EN Lawn edge  
 PL Obrzeże trawnikowe, brązowe  
 DE Gartenumrandung  
 RU Ограда для огорода  
 CZ Plastový okraj trávníku  
 RO Gărduj plastic grădină  
 HU Ágyásszegély  
 ES Borde para jardín



No.	H [mm]	L [m]	
88703	100	9	48
88704	150	9	36
88705	200	9	24

- EN Flexible lawn edge with pegs
- PL Obrzeże trawnikowe ze szpilkami
- DE Rasenkantenband mit Bodenankern
- RU Бордюр для газона со шпильками
- CZ Pružný okraj trávníku s kolíky
- RO Margine flexibilă pt. gazon cu cuie
- HU Ágyás-gyepszegély karókkal
- ES Bordura para jardín con estacas



FLO

No.	H [mm]	L [m]	
88710	40	10	9

- EN Plant protection fleece
- PL Agrowłóknina
- DE Agrotexilien
- RU Геотекстиль нетканый иглопробивной
- CZ Agrovláknina
- RO Folie lână de protecție a plantelor
- HU Geotextília
- ES Tela antiheladas



FLO

No.	Size / Rozmiar [m]	m [g/m <sup>2</sup> ]	
91000	1.6x50	19	12
91003	1.6x50	50	1

- EN Ground cover pegs
- PL Szpilki do włókniny
- DE Anker für Bodenplanen
- RU Шпильки для крепления ткани
- CZ Upevňovací kolíky do země
- RO Cuie pt. folie sol
- HU Rögzítő tűske
- ES Clavos de jardinería para tela



FLO

No.	L [mm]	pcs / szt.	
88715	120	25	40
88716	150	25	32

- EN Ground cover pegs
- PL Kolki do agrowłókniny, agrotkaniny
- DE Bodenanker für Unkrautvlies, Gartenvlies
- RU Кольшки для крепления агроткани
- CZ Hřebíky k upevnění textilií
- RO Cuie pt. folie antiburieni
- HU Geotextília rögzítő tűske
- ES Clavos para malla antihierbas, tela antiheladas



FLO

No.	pcs / szt.	
91061	100	10

- EN Edging pegs
- PL Szpilki do obrzeży
- DE Bodenanker für Rasenkanten
- RU Шпильки для газонного бордюра
- CZ Kotvíci kolíky na okraj trávníku
- RO Cuie pt. margine gazon
- HU Karók gyepszegélyhez
- ES Estacas para bordura



FLO

No.	L [mm]	pcs / szt.	
88713	180	25	60
88714	250	25	48

- EN Weed mat
- PL Agrotkanina
- DE Unkrautvlies
- RU Геотекстиль нетканый
- CZ Tkaná textilie
- RO Folie antiburieni
- HU Agroszövet
- ES Malla antihierbas



FLO

No.	Size / Rozmiar [m]	m [g/m <sup>2</sup> ]	
91050	1.6x50	70	1
91052	1.6x50	90	1

- EN Ground cover staples
- PL Szpilki do agrowłókniny, agrotkaniny
- DE Erdankern für Unkrautvlies, Gartenvlies
- RU Шпильки для агроткани
- CZ Hřebíky ve tvaru U k upevnění textilií
- RO Capse pt. folie antiburieni
- HU Rögzítő tűske geotextíliához és agroszövethez
- ES Grapas para malla antihierbas, tela antiheladas

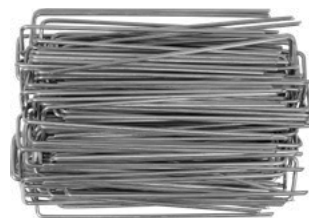
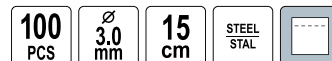

FLO

No.	pcs / szt.	
91060	100	10

- EN Shade cloth
- PL Mata do cieniowania
- DE Schattenmatte
- RU Коврик для тонировки
- CZ Podložka pro stínování
- RO Panza pt. umbra
- HU Árnyékoló háló
- ES Tela de malla sombra

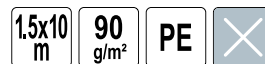

FLO

No.	Size / Rozmiar [m]	
88740	1.5x10	9



EN Twist tie  
 PL Drut ogrodniczy  
 DE Gartendraht  
 RU Проволока огородная

CZ Drát pro zahrádkáře  
 RO Sârmă pt. grădină  
 HU Kötöződrót  
 ES Alambre de jardinero

2  
PCS

50m



FLO

No.	L [m]	
88801	50	12/48

EN Garden flexible tie  
 PL Drut ogrodniczy w osłonie z pianki  
 DE Gartendraht, in einer Abdeckung aus Schaumstoff  
 RU Проволока огородная покрытая пенкой  
 CZ Drát pro zahrádkáře s pěnovým pláštěm  
 RO Sârmă pt. grădină cu izolație din spumă  
 HU Kötöződrót, plasztik bevonattal  
 ES Alambre de jardinero en cubierta de espuma

10mm

10m



FLO

No.	L [m]	
88809	10	40

EN Plant clips set  
 PL Klipsy do mocowania roślin  
 DE Clips  
 RU Зажимы  
 CZ Klipy  
 RO Set clipsuri  
 HU Csatok  
 ES Clips

45  
PCS

3,4x3,0cm x15  
3,0x2,3cm x15  
2,3x2,0cm x15

PP



FLO

No.	pcs / szt.	
88812	45	24/48

EN Plant tying machine  
 PL Zszywacz ogrodniczy  
 DE Garten Bindezange  
 RU Стеллер садовый для подвязки  
 CZ Vázací kleště  
 RO Masina de legat plante  
 HU Kertészeti kötözőgép  
 ES Atadora de jardín

**FUNCTIONS:**  
 - Fast and easy plant tying

**FUNKCJE:**  
 - Szybkie i łatwe podwiązanie roślin

FLO

No.	
88830	20

Compatible with 88831 (tape), 88832 (staples)  
 Kompatybilne z 88831 (taśma), 88832 (zszywki)

EN Twist tie with cutter  
 PL Drut ogrodniczy powlekany z obcinaczem  
 DE Gartendraht, beschichtet, mit Abscheider  
 RU Проволока огородная с диспенсером  
 CZ Drát pro zahrádkáře potažený plástem s odzvěvačem  
 RO Sârmă pt. grădină izolată cu tăietor  
 HU Galvanizált kötöződrót, darabolóval  
 ES Alambre de jardinero cubierto con tronizador



FLO

No.	L [m]	
88805	30	24/144
88806	50	24/144

EN Plant binding set  
 PL Zestaw ogrodniczy do podwiązania roślin  
 DE Gartensatz zum Abbinden von Pflanzen  
 RU Набор огородный для подвязки растений

CZ Souprava pro zahrádkáře k vyvazování rostlin  
 RO Set pt. grădină pt. legare plante  
 HU Kertészeti szett növények felkötéséhez  
 ES Juego para jardín para sujetar plantas

71  
PCS



FLO

No.	pcs / szt.	
88811	71	24

EN String set  
 PL Zestaw sznurków  
 DE Schnursatz  
 RU Набор шнуров  
 CZ Sada provázků  
 RO Set sfori  
 HU Zsinórkészlet  
 ES Juego de cuerdas

6  
PCS

1.0mm  
COTTON-SHREKMA

1.5mm  
JUTE I. JUTA

1.5mm  
JUTE I. JUTA



FLO

No.	pcs / szt.	
88820	6	36



ABS

STEEL  
STAL

SK5



EN Universal gardening tape  
 PL Uniwersalna taśma ogrodnicza  
 DE Universelles Pflanzen-Klebeband  
 RU Универсальная садовая лента  
 CZ Univerzální zahradnická páska  
 RO Bandă universală pt. grădinarit  
 HU Kertészeti univerzális szalag  
 ES Cinta de jardín universal



No.	W [mm]	L [m]	→ ← [mm]	For / Dla	pcs / szt.	
88831	11	23	0.12	88830	20	25

EN Tying machine staples  
 PL Zszywki do zszywacza ogrodniczego  
 DE Heftklammern für Bindezange  
 RU Скобы для садового степлера  
 CZ Sponky pro vázací kleště  
 RO Capse pt. mașină de legat plante  
 HU Kötözőgép kapocs  
 ES Grapas para atadora de jardín



No.	Staple length / Długość zszywki [mm]	Staple thickness / Grubość zszywki [mm]	Staple width / Szerokość zszywki [mm]	For / Dla	pcs / szt.	
88832	4	0.55	6.95	88830	10000	100

EN Plant antifreeze protective cover set  
 PL Pokrowce przeciw zamarzaniu roślin  
 DE Winterschutzsäcke für Pflanzen  
 RU Чехлы для защиты от заморозки растений  
 CZ Kryty proti zamrznání rostliny  
 RO Set protecții anti îngheț pt. plante  
 HU Fagyvédő fólia növényekre  
 ES Cubre plantas



No.	Size / Rozmiar [cm]	pcs / szt.	
89753	80x75	3	24

EN Vegetable growing house  
 PL Miniszklarnia przydomowa  
 DE Mini Garten-Gewächshaus  
 RU Садовая мини-теплица  
 CZ Mini skleník do zahrádky  
 RO Sera pt. legume  
 HU Mini kerti üvegház  
 ES Mini invernadero doméstico

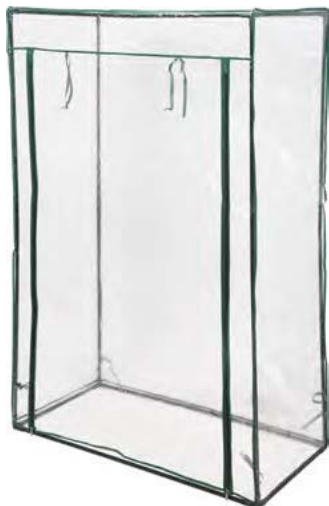

No.	Dimensions / Wymiary [cm]	
90000	100x50x150	1



EN Frost protection fleece jacket  
 PL Kaptur ochronny dla roślin  
 DE Pflanzenschutzhaube  
 RU Укрывной копак для растений  
 CZ Ochranná kapuce na rostliny  
 RO Protecție anti îngheț  
 HU Védőgallér növényekre  
 ES Saco protector para plantas



No.	Size / Rozmiar [cm]	
89750	120x180	24

EN Black net tunnel  
 PL Czarny tunel ochrony roślin  
 DE Pflanzenschutztunnel schwarz  
 RU Черный туннель для защиты растений  
 CZ Černý tunel pro ochranu rostlin  
 RO Protecție plante tip tunel  
 HU Fekete védőalagút növényekre  
 ES Túnel de malla negra para plantas



No.	Dimensions / Wymiary [cm]	
89770	300x45x45	12

EN Vegetable growing house  
 PL Miniszklarnia przydomowa  
 DE Mini Garten-Gewächshaus  
 RU Садовая мини-теплица  
 CZ Mini skleník do zahrádky  
 RO Sera pt. legume  
 HU Mini kerti üvegház  
 ES Mini invernadero doméstico



No.	Dimensions / Wymiary [cm]	
90001	120x60x60	1

EN 5-tier greenn house  
 PL Miniszklarnia 5 poziomów  
 DE Mini Gewächshaus 5 Regale  
 RU Мини-теплица 5 уровней  
 CZ 5 úroňový mini skleník  
 RO Sera cu 5 rafturi  
 HU Mini üvegház 5 szintes  
 ES Mini invernadero 5 niveles



No.	Dimensions / Wymiary [cm]	
90002	200x69x49	1

EN Walk-in greenhouse  
 PL Szklarnia foliowa  
 DE Folienwachshaus  
 RU Пленочная теплица  
 CZ Fóliový skleník  
 RO Sera  
 HU Fólia üvegház  
 ES Invernadero de plástico



No.	Dimensions / Wymiary [cm]	
90031	143x143x195	1

EN Garden greenhouse  
 PL Miniszklarnia naskrzyniowa  
 DE Mini-Gewächshaus  
 RU Мини-теплица гроубокс  
 CZ Mini skleník podstavec  
 RO Sera gradina  
 HU Mini ládás üvegház  
 ES Mini invernadero instalado en una base

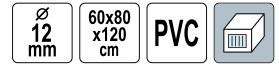

No.	Dimensions / Wymiary [cm]	
90003	60x80x120	1

EN Walk-in greenhouse  
 PL Szklarnia foliowa  
 DE Folienwachshaus  
 RU Пленочная теплица  
 CZ Fóliový skleník  
 RO Sera  
 HU Fólia üvegház  
 ES Invernadero de plástico



No.	Dimensions / Wymiary [cm]	
90030	143x73x195	1

EN Germination tray set  
 PL Doniczki torfowe do rozsad  
 DE Torf-Anzuchtöpfen  
 RU Торфяные горшки для рассады  
 CZ Rašelinové květináče pro sazenice  
 RO Set lavi germinative  
 HU Tőzegcsesérp palántázáshoz  
 ES Macetas de turba para plántulas



No.	pcs / szt.	
90350	10	40

EN Germination kit  
 PL Zestaw do rozsad  
 DE Anzuchtset  
 RU Набор для рассады  
 CZ Sada pro sazenice  
 RO Trusa de germinare  
 HU Palántázó készlet  
 ES Kit para plántulas

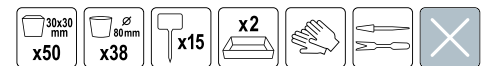

No.	pcs / szt.	
90360	63	24



- EN Soil survey instrument
- PL Miernik ogrodniczy
- DE Gartenmessgerät
- RU Измеритель огородный
- CZ Zahradnický měřicí přístroj
- RO Aparat de măsurat grădinaresc
- HU Négyfunkciós, kerti mérőműszer
- ES Medidor de horticultor

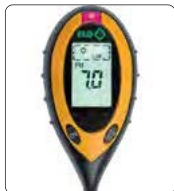
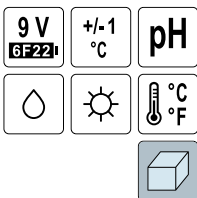

No.	Dimensions / Wymiary [cm]	Boxes
89000		10

- EN Swing seat cover
- PL Pokrowiec na huśtawkę
- DE Schutzhülle für Schaukel
- RU Чехол для садовых качели
- CZ Ochranný kryt na houpačku
- RO Husa pt. balansoar terasa
- HU Kerti hintaágy takaró
- ES Funda para columpio

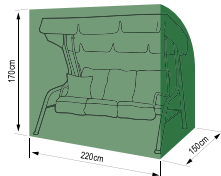
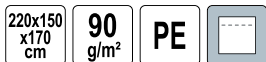

No.	Dimensions / Wymiary [cm]	Boxes
92105	220x150x170	8

- EN Outdoor furniture cover
- PL Pokrowiec na meble ogrodowe
- DE Gartenmöbel-Schutzhülle
- RU Чехол для садовой мебели
- CZ Ochranný kryt na zahradní nábytek
- RO Husa mobilier de exterior
- HU Kerti butor takaró ponyva
- ES Funda para muebles de jardín

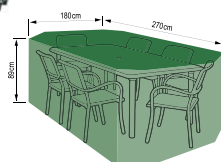
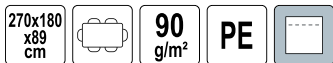

No.	Dimensions / Wymiary [cm]	Boxes
92115	270x180x89	12

- EN Stackable patio chair cover
- PL Pokrowiec na krzesła ogrodowe
- DE Schutzhülle für Stapelstühle
- RU Чехол на садовые стулья
- CZ Ochranný kryt na zahradní křesla
- RO Husa pt. scaune terasa
- HU Takaró összerakott székekhez
- ES Funda para sillas de jardín

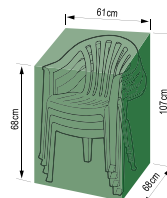
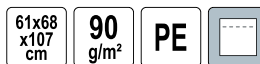

No.	Dimensions / Wymiary [cm]	Boxes
92100	61x68x107	24

- EN Outdoor furniture cover
- PL Pokrowiec na meble ogrodowe
- DE Gartenmöbel-Schutzhülle
- RU Чехол для садовой мебели
- CZ Ochranný kryt na zahradní nábytek
- RO Husa mobilier de exterior
- HU Kerti butor takaró ponyva
- ES Funda para muebles de jardín

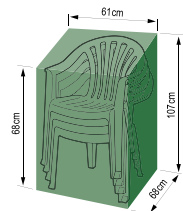
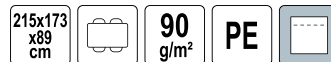

No.	Dimensions / Wymiary [cm]	Boxes
92110	215x173x89	12

- EN Folding garden trash bag
- PL Kosz ogrodowy składany
- DE Klappbarer Gartenkorb
- RU Складная садовая корзина
- CZ Skládací zahradní koš
- RO Cos gunoi gradina pliabil
- HU Összecsukható kerti szemetes
- ES Contenedor plegable para jardín



No.	Size / Rozmiar [mm]	Boxes
90150	880x450	12





EN Garden basket  
 PL Kosz ogrodniczy  
 DE Gartenkorb  
 RU Корзина садовая  
 CZ Zahradní koš  
 RO Coș de grădină  
 HU Kerti kosár  
 ES Cesta de jardín



FLO

No.	Capacity / Pojemność [l]	
35610	25	480
35611	35	280

EN Garden bucket  
 PL Wiadro ogrodnicze  
 DE Garten Eimer  
 RU Ведро огородное  
 CZ Zahradní vědro  
 RO Găleată de grădină  
 HU Kerti vödör  
 ES Cubo de jardín



FLO

No.	Capacity / Pojemność [l]	
35600	15	500

EN Garden cart  
 PL Wózek ogrodowy  
 DE Gartenwagen  
 RU Садовая тележка  
 CZ Zahradní vozík  
 RO Carucior gradina  
 HU Kerti kocsi  
 ES Carrito de jardín



**FEATURES:**  
 - Pneumatic wheels  
**CECHY:**  
 - Kola pompowane



FLO

No.	Max. load capacity / Maks. obciążenie [kg]	Dimensions / Wymiary [mm]	
90200	300	1020x515x400	1

EN Universal grow bag  
 PL Uniwersalna torba ogrodowa  
 DE Mehrzweck-Gartentasche  
 RU Универсальная садовая сумка  
 CZ Univerzální zahradní taška  
 RO Geanta univerzala pt. cultivat  
 HU Univerzális kertésztaška  
 ES Bolsa de jardín universal



FLO

No.	Size / Rozmiar [mm]	
90240	440x370	24

EN Bucket  
 PL Wiadro  
 DE Eimer  
 RU Ведро  
 CZ Vědro  
 RO Găleată  
 HU Vödör  
 ES Cubo



VOREL

No.	Capacity / Pojemność [l]	
89560	5	900
89561	7	750
89562	10	600
89563	12	500
89564	15	350

EN Garden tipping cart  
 PL Wózek ogrodowy z wywrotką  
 DE Gartenwagen mit Kippfunktion  
 RU Садовая тележка-самосвал  
 CZ Zahradní vozík sklápěcí  
 RO Carucior gradina  
 HU Kerti kocsi billenő funkcióval  
 ES Carrito de jardín basculante

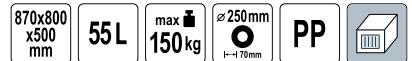

**FEATURES:**  
 - Pneumatic wheels  
**CECHY:**  
 - Kola pompowane



FLO

No.	Max. load capacity / Maks. obciążenie [kg]	Dimensions / Wymiary [mm]	
90204	150	870x800x500	1

EN Garden tipping cart  
 PL Wózek ogrodowy z wywrotką  
 DE Gartenwagen mit Kippfunktion  
 RU Садовая тележка-самосвал  
 CZ Zahradní vozík sklápěcí  
 RO Carucior gradina  
 HU Kerti kocsi billenő funkcióval  
 ES Carrito de jardín basculante

975x510  
x1000  
mm

75L

max  
200kg

ø 260mm  
L-475mm

PP



**FEATURES:**  
 - Pneumatic wheels  
**CECHY:**  
 - Kola pompowane



No.	Max. load capacity / Maks. obciążenie [kg]	Dimensions / Wymiary [mm]	
90205	200	975x510x1000	1

EN Garden bags with cord  
 PL Worki ogrodowe z taśmą  
 DE Gartensäcke mit Band  
 RU Мешки для огорода с лентой

CZ Zahradní pytle zatahovací  
 RO Saci gunoi pt. gradina cu strangere  
 HU Szalagos kerti szeméteszsák  
 ES Bolsas de jardín con cinta

STRING  
TAPE  
TASMA  
SCĂGĂAȚĂ

LDPE



No.	Capacity / Pojemność [l]	Thickness / Grubość [µm]	pcs / szt.
09480	60	60	10
09482	120	60	10

EN Perforated waste bags for leaves  
 PL Worki perforowane na liście  
 DE Gartenmüllsäcke perforiert  
 RU Мусорные пакеты прочные для листьев

CZ Perforované odpadové pytle na list  
 RO Saci pt. frunze și deșeuri din grădină  
 HU Szalagos kerti szeméteszsák  
 ES Sacos perforados para residuos de jardín

PERFO-  
RATED  
PERFO-  
ROWANY

LDPE



No.	Capacity / Pojemność [l]	Thickness / Grubość [µm]	pcs / szt.
09484	200	40	10

EN Trash gripper  
 PL Ręczny chwytak do śmieci  
 DE Manueller Abfall-Greifer  
 RU Ручной захват для мусора

CZ Ruční sběrač odpadků  
 RO Cleste pt. adunat gunoi  
 HU Kézi szemétszedő  
 ES Recogedor manual de basura

ø 14 mm

760 mm

AI

ABS  
PP  
TPR



No.	L [mm]	
89896	760	24

EN Garden bags  
 PL Worki ogrodowe  
 DE Gartensäcke  
 RU Мешки для огорода  
 CZ Zahradní pytle  
 RO Saci gunoi pt. gradina  
 HU Kerti szeméteszsák  
 ES Bolsas de jardín

LDPE



No.	Capacity / Pojemność [l]	Thickness / Grubość [µm]	pcs / szt.
09481	120	60	10

EN Waste bags for grass  
 PL Worki perforowane na trawę  
 DE Gartenmüllsäcke perforiert  
 RU Мусорные пакеты прочные для листьев  
 CZ Perforované odpadové pytle na tráve  
 RO Saci pt. iarba și deșeuri din grădină  
 HU Szalagos kerti szeméteszsák  
 ES Sacos perforados para residuos de jardín

PERFO-  
RATED  
PERFO-  
ROWANY

LDPE



No.	Capacity / Pojemność [l]	Thickness / Grubość [µm]	pcs / szt.
09483	120	35	10

EN Compost and gravel sieve  
 PL Sito do kompostu i żwiru  
 DE Sieb für Kompost und Kies  
 RU Сито для компоста и гравия  
 CZ Prohazovací síto na kompost a štěrk  
 RO Sită compost și zgură  
 HU Rosta komposztáláshoz és sóderhez  
 ES Cedazo para estiércol y guija

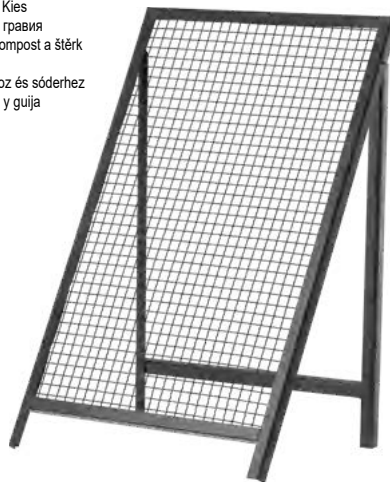

No.	Dimensions / Wymiary [cm]	Eyelet size / Rozmiar oczka [mm]
34949	60x100	20x20

EN Composter  
 PL Kompostownik  
 DE Kompostierer  
 RU Компостовник  
 CZ Kompostér  
 RO Compostor  
 HU Komposztáló láda  
 ES Compostador



No.	Capacity / Pojemność [l]	
35623	480	10

EN Composter  
 PL Kompostownik  
 DE Kompostierer  
 RU Компостовник  
 CZ Kompostér  
 RO Compostor  
 HU Komposztáló láda  
 ES Compostador



No.	Capacity / Pojemność [l]	
35625	1000	6

EN Seeder  
 PL Siewnik  
 DE Streuwagen  
 RU Сеялка  
 CZ Sečí stroj  
 RO Semanatoare  
 HU Magszóró  
 ES Sembradora



No.	Capacity / Pojemność [l]	
89870	12	1

EN Multiple holder  
 PL Wieszak na narzędzia  
 DE Werkzeughalter  
 RU Подвеска для инструмента  
 CZ Věšák na nářadí  
 RO Suport multiplu  
 HU Szerszámakasztó  
 ES Colgador para herramientas



No.	
89950	40



EN Composter  
 PL Kompostownik  
 DE Kompostierer  
 RU Компостовник  
 CZ Kompostér  
 RO Compostor  
 HU Komposztáló láda  
 ES Compostador



No.	Capacity / Pojemność [l]	
35624	740	7

EN Spreader  
 PL Rozsiewacz  
 DE Streuer  
 RU Разбрасыватель-сеялка  
 CZ Sečí strojek  
 RO Dispozitiv de imprastiere  
 HU Magszóró  
 ES Esparcidor



No.	Capacity / Pojemność [l]	
89860	3	12

EN Garden rack  
 PL Stojak ogrodowy  
 DE Gartengeräteständer  
 RU Садовая подставка  
 CZ Zahradní stojan  
 RO Raft pt. gradina  
 HU Kerti állvány  
 ES Soporte para herramientas de jardinería

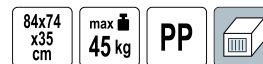

No.	Dimensions / Wymiary [mm]	
89990	840x740x350	1



- EN Gutter mesh with hooks
- PL Siatka zabezpieczająca rynny z uchwyłami mocującymi
- DE Schutzgitter für Rinnen mit Spannvorrichtungen
- RU Защитная сетка желоба с монтажными ручками
- CZ Ochranná síť proti zanášení okapových žlabů s úchytkami
- RO Plasă de protecție burlane cu suporturi de protecție
- HU Lombfogó háló rögzítő fűlekkel
- ES Malla de protección para la canaleta con mandriles de sujeción

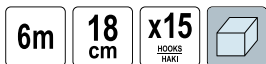

No.			
69851			30

- EN Portable car shower set
- PL Samochodowy prysznic turystyczny
- DE Campingdusche
- RU Портативный автомобиль душ
- CZ Mobilní auto sprcha
- RO Dus portabil masina
- HU Autós hordozható zuhany
- ES Portátil ducha de coche

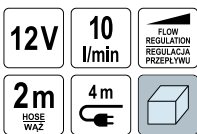

**FUNCTIONS:**

- Taking shower, washing car, washing dishes and others

**FUNKCJE:**

- Prysznic, mycie samochodu, mycie naczyń i inne



No.	Voltage / Napięcie [V d.c.]	
82991	12	10

- EN Gas grill
- PL Grill gazowy
- DE Gasgrill
- RU Газовый гриль
- CZ Plynový gril
- RO Grătarul cu gaz
- HU Gázgrill
- ES Barbacoa de gas

**FEATURES:**

- Thermo gauge
- Bowl for fat
- Foldable side shelves

**CECHY:**

- Termometr
- Misa na tłuszcz
- Składane półki boczne



No.			
99644			1

- EN Rain pipe guard
- PL Ostona rynny - sito do rury spustowej
- DE Fallrohrschutz
- RU Защитный кожух водосточного желоба
- CZ Ochrana okapového svodu
- RO Protecție pt. burlane
- HU Sító eresz burkolat leeresztő csőhöz
- ES Protector de canalón tamiza para tubo de descarga

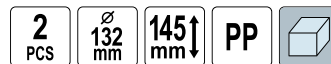

No.	Ø [mm]	pcs / szt.	
69860	132	2	24

- EN Portable car shower set
- PL Samochodowy prysznic turystyczny
- DE Campingdusche
- RU Портативный автомобиль душ
- CZ Mobilní auto sprcha
- RO Dus portabil masina
- HU Autós hordozható zuhany
- ES Portátil ducha de coche



**FUNCTIONS:**

- Taking shower, washing car, washing dishes, watering plants and others

**FUNKCJE:**

- Prysznic, mycie samochodu, mycie naczyń, podlewanie roślin i inne

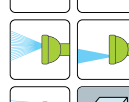
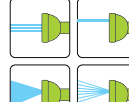

No.	Voltage / Napięcie [V d.c.]	
82992	12	10





EN Gas grill  
 PL Grill gazowy  
 DE Gasgrill  
 RU Газовый гриль  
 CZ Plynový gril  
 RO Grătarul cu gaz  
 HU Gázgrill  
 ES Barbacoa de gas



**FEATURES:**

- Thermo gauge
- Bowl for fat

**CECHY:**

- Termometr
- Misa na tłuszcz



**LUND**

No.

99645



1

EN Gas grill  
 PL Grill gazowy  
 DE Gasgrill  
 RU Газовый гриль  
 CZ Plynový gril  
 RO Grătarul cu gaz  
 HU Gázgrill  
 ES Barbacoa de gas

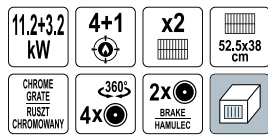

**FEATURES:**

- Ignition in the knob
- Thermo gauge
- Sliding tray for fat

**CECHY:**

- Zapalnik w pokrętle
- Termometr
- Wysuwana taca na tłuszcz



**LUND**

No.

99646



1

EN Gas grill  
 PL Grill gazowy  
 DE Gasgrill  
 RU Газовый гриль  
 CZ Plynový gril  
 RO Grătarul cu gaz  
 HU Gázgrill  
 ES Barbacoa de gas

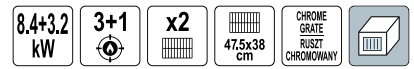

**FEATURES:**

- Ignition in the knob
- Thermo gauge
- Sliding tray for fat

**CECHY:**

- Zapalnik w pokrętle
- Termometr
- Wysuwana taca na tłuszcz



**LUND**

No.

99647



1

EN Gas and charcoal grill  
 PL Grill gazowo-węglowy  
 DE Gas- und Kohlegrill  
 RU Газово-угольный гриль  
 CZ Gril na plyn a uhlí  
 RO Gratar pe gaz si carbuni  
 HU Kombinált grill, gáz, szén  
 ES Barbacoa a gas y carbón

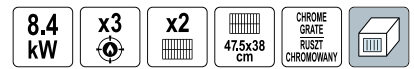

**FEATURES:**

- Thermo gauges
- Sliding trays for fat
- Charcoal bowl
- Foldable side shelves

**CECHY:**

- Termometry
- Wysuwane tace na tłuszcz
- Płyta na węgiel
- Składane półki boczne



**LUND**

No.

99649



1

EN Gas grill  
 PL Grill gazowy  
 DE Gasgrill  
 RU Газовый гриль  
 CZ Plynový gril  
 RO Grătarul cu gaz  
 HU Gázgrill  
 ES Barbacoa de gas

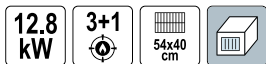

**FEATURES:**

- Ignition in the knob
- Thermo gauge
- Sliding tray for fat



**CECHY:**

- Zapalnik w pokrętle
- Termometr
- Wysuwana taca na tłuszcz



**LUND**

No.

99642

1

EN Gas grill  
 PL Grill gazowy  
 DE Gasgrill  
 RU Газовый гриль  
 CZ Plynový gril  
 RO Grătarul cu gaz  
 HU Gázgrill  
 ES Barbacoa de gas

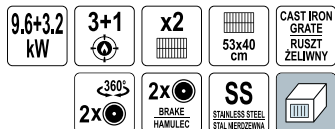

**FEATURES:**

- Ignition in the knob
- Thermo gauge
- Sliding tray for fat
- Space for a gas bottle
- Wheels with a brake



**CECHY:**

- Zapalnik w pokrętle
- Termometr
- Wysuwana taca na tłuszcz
- Miejsce na butlę gazową
- Kola z hamulcem



**LUND**

No.

99654

1

EN Gas grill  
 PL Grill gazowy  
 DE Gasgrill  
 RU Газовый гриль  
 CZ Plynový gril  
 RO Grătarul cu gaz  
 HU Gázgrill  
 ES Barbacoa de gas



**FEATURES:**

- Ignition in the knob
- Thermo gauge
- Sliding tray for fat
- Side handles
- Wheels with a brake



**CECHY:**

- Zapalnik w pokrętle
- Termometr
- Wysuwana taca na tłuszcz
- Uchwyty boczne
- Kola z hamulcem



**LUND**

No.

99643

1

EN Gas grill  
 PL Grill gazowy  
 DE Gasgrill  
 RU Газовый гриль  
 CZ Plynový gril  
 RO Grătarul cu gaz  
 HU Gázgrill  
 ES Barbacoa de gas

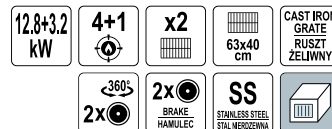

**FEATURES:**

- Ignition in the knob
- Thermo gauge
- Sliding tray for fat
- Space for a gas bottle
- Wheels with a brake



**CECHY:**

- Zapalnik w pokrętle
- Termometr
- Wysuwana taca na tłuszcz
- Miejsce na butlę gazową
- Kola z hamulcem



**LUND**

No.

99655

1

EN Cast iron plate  
 PL Płyta żeliwna  
 DE Gusseisenplatte  
 RU Чугунная пластина  
 CZ Litinová deska  
 RO Tava oțel  
 HU Öntöttvas lemez  
 ES Placa de acero fundido



**LUND**

No.	For / Dia	
99659	99642, 99643, 99651, 99652, 99653, 99654, 99655	5

EN Charcoal grill  
 PL Grill węglowy  
 DE Holzkohlegrill  
 RU Гриль угольный  
 CZ Gril na dřevěné uhlí  
 RO Gratar carbuni  
 HU Faszén grill  
 ES Barbacoa de carbón



**FEATURES:**

- Firebowl height: 59 cm
- Metal shelf
- Metal handle

**CECHY:**

- Wysokość paleniska: 59 cm
- Metalowa półka
- Metalowy uchwyt



**LUND**

No.	
99919	1

EN Charcoal grill  
 PL Grill węglowy  
 DE Holzkohlegrill  
 RU Гриль угольный  
 CZ Gril na dřevěné uhlí  
 RO Gratar carbuni  
 HU Faszén grill  
 ES Barbacoa de carbón

**FEATURES:**

- Adjustable cooking height
- Zinc plated charcoal plates
- Folding shelf

**CECHY:**

- Regulowana wysokość rusztów
- Ocynkowane płyty na węgiel
- Składana półka



**LUND**

No.	
99495	1

EN Gas regulator and hose  
 PL Reduktor z węzłem  
 DE Schlauch und Regler  
 RU Газовый шланг с редуктором  
 CZ Regulátor plynu a hadice  
 RO Furtun pt. gaz cu regulator  
 HU Nyomásszabályozó szett  
 ES Regulador de gas con manguera



**VOREL**

No.	L [m]	
99670	1.0	16
99671	1.5	16

EN Charcoal grill  
 PL Grill węglowy  
 DE Holzkohlegrill  
 RU Гриль угольный  
 CZ Gril na dřevěné uhlí  
 RO Gratar carbuni  
 HU Faszén grill  
 ES Barbacoa de carbón

**FEATURES:**

- Firebowl height: 73 cm
- Warming rack: 46 x 7 cm
- 2 metal shelves

**CECHY:**

- Wysokość paleniska: 73 cm
- Kratka podgrzewająca: 46 x 7 cm
- 2 metalowe półki

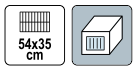

**LUND**

No.	
99582	1

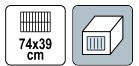

EN Charcoal grill  
 PL Grill węglowy  
 DE Holzkohlegrill  
 RU Гриль угольный  
 CZ Gril na dřevěné uhlí  
 RO Gratar carbuni  
 HU Faszén grill  
 ES Barbacoa de carbón

**FEATURES:**

- Grate height: 57 cm
- Air flow
- Ashpan

**CECHY:**

- Wysokość ruszty: 57 cm
- Obieg powietrza
- Popielnik



**LUND**

No.

99918



1

EN Charcoal grill  
 PL Grill węglowy  
 DE Holzkohlegrill  
 RU Гриль угольный  
 CZ Gril na dřevěné uhlí  
 RO Gratar carbuni  
 HU Faszén grill  
 ES Barbacoa de carbón

**FEATURES:**

- Air flow
- Metal shelf

**CECHY:**

- Obieg powietrza
- Metalowa półka



**LUND**

No.

99904



1

EN Charcoal grill  
 PL Grill węglowy  
 DE Holzkohlegrill  
 RU Гриль угольный  
 CZ Gril na dřevěné uhlí  
 RO Gratar carbuni  
 HU Faszén grill  
 ES Barbacoa de carbón

**FEATURES:**

- Grate height: 59 cm
- Air flow
- Ashpan
- Rain cover

**CECHY:**

- Wysokość ruszty: 59 cm
- Obieg powietrza
- Popielnik
- Pokrowiec przeciwdeszczowy



**LUND**

No.

99906



1

EN Charcoal grill  
 PL Grill węglowy  
 DE Holzkohlegrill  
 RU Гриль угольный  
 CZ Gril na dřevěné uhlí  
 RO Gratar carbuni  
 HU Faszén grill  
 ES Barbacoa de carbón

**FEATURES:**

- Firebowl height: 65 cm
- Warming rack: 45 x 8 cm
- 3 wooden shelves

**CECHY:**

- Wysokość paleniska: 65 cm
- Kratka podgrzewająca: 45 x 8 cm
- 3 drewniane półki



**LUND**

No.

99911



1



EN Charcoal grill  
 PL Grill węglowy  
 DE Holzkohlegrill  
 RU Гриль угольный  
 CZ Gril na dřevěné uhlí  
 RO Gratar carbuni  
 HU Faszén grill  
 ES Barbacoa de carbón



**FEATURES:**  
 - Grill adjustment  
 - 3 wooden shelves  
 - Air flow



**CECHY:**  
 - Regulacja ruszty  
 - 3 drewniane półki  
 - Obieg powietrza



**LUND**

No.

99905



1

EN Charcoal grill  
 PL Grill węglowy  
 DE Holzkohlegrill  
 RU Гриль угольный  
 CZ Gril na dřevěné uhlí  
 RO Gratar carbuni  
 HU Faszén grill  
 ES Barbacoa de carbón

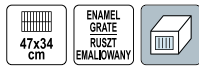

**FEATURES:**  
 - Thermo gauge  
 - Air flow  
 - Chimney



**CECHY:**  
 - Termometr  
 - Obieg powietrza  
 - Komin

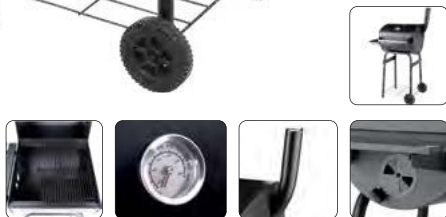

**LUND**

No.

99902



1

EN Charcoal grill  
 PL Grill węglowy  
 DE Holzkohlegrill  
 RU Гриль угольный  
 CZ Gril na dřevěné uhlí  
 RO Gratar carbuni  
 HU Faszén grill  
 ES Barbacoa de carbón



**FEATURES:**  
 - Thermo gauge  
 - Air flow  
 - Ashpan



**CECHY:**  
 - Termometr  
 - Obieg powietrza  
 - Popielnik



**LUND**

No.

99584



1

EN Charcoal grill  
 PL Grill węglowy  
 DE Holzkohlegrill  
 RU Гриль угольный  
 CZ Gril na dřevěné uhlí  
 RO Gratar carbuni  
 HU Faszén grill  
 ES Barbacoa de carbón



**FEATURES:**  
 - Firebowl height: 75 cm  
 - 2 wooden shelves  
 - Thermo gauge  
 - Air flow  
 - Ashpan



**CECHY:**  
 - Wysokość paleniska: 75 cm  
 - 2 drewniane półki  
 - Termometr  
 - Obieg powietrza  
 - Popielnik

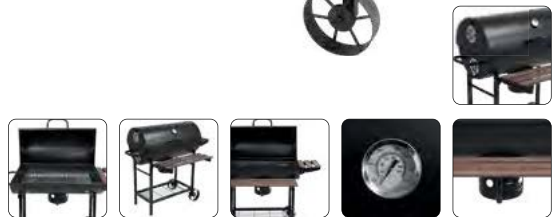

**LUND**

No.

99908



1

EN Charcoal grill  
 PL Grill węglowy  
 DE Holzkohlegrill  
 RU Гриль угольный  
 CZ Gril na dřevěné uhlí  
 RO Gratar carbuni  
 HU Faszén grill  
 ES Barbacoa de carbón



**FEATURES:**

- Metal fireplace
- Thermo gauge
- Air flow
- Ashpan

**CECHY:**

- Płyta żaroodporna
- Termometr
- Obieg powietrza
- Popielnik



**LUND**

No.  
99900



1

EN Charcoal grill  
 PL Grill węglowy  
 DE Holzkohlegrill  
 RU Гриль угольный  
 CZ Gril na dřevěné uhlí  
 RO Gratar carbuni  
 HU Faszén grill  
 ES Barbacoa de carbón



**FEATURES:**

- Grate height: 85 cm
- Grill adjustment system
- Warming rack: 75 x 24 cm
- Thermo gauge
- Folding shelves
- Air flow
- Bottle opener
- Ashpan

**CECHY:**

- Wysokość rusztu: 85 cm
- System regulacji rusztu
- Kratka podgrzewająca: 75 x 24 cm
- Termometr
- Składane półki
- Obieg powietrza
- Otwieracz do butelek
- Popielnik



**LUND**

No.  
99917



1

EN Charcoal grill  
 PL Grill węglowy  
 DE Holzkohlegrill  
 RU Гриль угольный  
 CZ Gril na dřevěné uhlí  
 RO Gratar carbuni  
 HU Faszén grill  
 ES Barbacoa de carbón

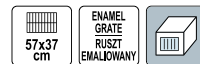

**FEATURES:**

- Firebowl height: 85 cm
- Grill adjustment system
- Air flow
- Thermo gauge
- Ashpan
- Folding shelf

**CECHY:**

- Wysokość paleniska: 85 cm
- System regulacji rusztu
- Obieg powietrza
- Termometr
- Popielnik
- Składana półka



**LUND**

No.  
99910



1

EN Smoker  
 PL Wędzarnia  
 DE Räucherer  
 RU Коптильня  
 CZ Udírna  
 RO Afumător  
 HU Füstölővel  
 ES Ahumador



**FEATURES:**

- Thermo gauge
- 2 x cooking grill
- 2 x porcelain bowl
- 4 x hangers
- Air flow

**CECHY:**

- Termometr
- 2 ruszty
- 2 porcelanowe misy
- 4 haczyki
- Obieg powietrza



**LUND**

No.  
99920



1

EN Smoker  
 PL Wędzarnia  
 DE Räucherherd  
 RU Коптильня  
 CZ Udirna  
 RO Afumător  
 HU Füstölővel  
 ES Ahumador

**FEATURES:**

- Thermo gauge
- 2 x cooking grill
- 2 x porcelain bowl
- 4 x vent

**CECHY:**

- Termometr
- 2 ruszty
- 2 porcelanowe misy
- 4 otwory wentylacyjne



**LUND**

No. 99916  1

EN Charcoal grill  
 PL Grill węglowy  
 DE Holzkohlegrill  
 RU Гриль угольный  
 CZ Gril na dřevěné uhlí  
 RO Gratar carbuni  
 HU Faszén grill  
 ES Barbacoa de carbón



**LUND**

No. 99903  1

EN Fire pit  
 PL Palenisko ogrodowe  
 DE Gartenfeuerstelle  
 RU Садовый очаг  
 CZ Zahradní ohniště  
 RO Vatra de foc  
 HU Kerti tűzrakó  
 ES Fogón para jardín



**INCLUDED:**

- Poker

**W ZESTAWIE:**

- Pogrzebacz

**FEATURES:**

- Folding legs

**CECHY:**

- Składane nóżki



**LUND**

No. 99912  1

EN Fire pit  
 PL Palenisko ogrodowe  
 DE Gartenfeuerstelle  
 RU Садовый очаг  
 CZ Zahradní ohniště  
 RO Vatra de foc  
 HU Kerti tűzrakó  
 ES Fogón para jardín



**INCLUDED:**

- Steel poker
- Log store

**W ZESTAWIE:**

- Stalowy pogrzebacz
- DREWOTNIA



**LUND**

No. 99914  1

EN Fire pit  
 PL Palenisko ogrodowe  
 DE Gartenfeuerstelle  
 RU Садовый очаг  
 CZ Zahradní ohniště  
 RO Vatra de foc  
 HU Kerti tűzrakó  
 ES Fogón para jardín



**INCLUDED:**

- Poker

**W ZESTAWIE:**

- Pogrzebacz



**LUND**

No. 99702  1

EN Fire pit  
 PL Palenisko ogrodowe  
 DE Gartenfeuerstelle  
 RU Садовый очаг  
 CZ Zahradní ohniště  
 RO Vatra de foc  
 HU Kerti tűzrakó  
 ES Fogón para jardín



**INCLUDED:**

- Poker

**W ZESTAWIE:**

- Pogrzebacz



**LUND**

No. 99913  1

EN Fire pit  
 PL Palenisko ogrodowe  
 DE Gartenfeuerstelle  
 RU Садовый очаг  
 CZ Zahradní ohniště  
 RO Vatra de foc  
 HU Kerti tűzrakó  
 ES Fogón para jardín



**INCLUDED:**

- Poker

**W ZESTAWIE:**

- Pogrzebacz



**LUND**

No.	1
99707	1

EN Fire pit  
 PL Palenisko ogrodowe  
 DE Gartenfeuerstelle  
 RU Садовый очаг  
 CZ Zahradní ohniště  
 RO Vatra de foc  
 HU Kerti tűzrakó  
 ES Fogón para jardín

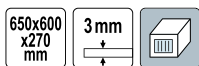

**LUND**

No.	1
99704	1

EN Fire pit  
 PL Palenisko ogrodowe  
 DE Gartenfeuerstelle  
 RU Садовый очаг  
 CZ Zahradní ohniště  
 RO Vatra de foc  
 HU Kerti tűzrakó  
 ES Fogón para jardín

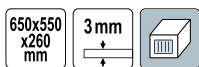

**LUND**

No.	1
99706	1

EN Fire pit  
 PL Palenisko ogrodowe  
 DE Gartenfeuerstelle  
 RU Садовый очаг  
 CZ Zahradní ohniště  
 RO Vatra de foc  
 HU Kerti tűzrakó  
 ES Fogón para jardín

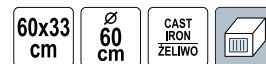

**LUND**

No.	1
99711	1

EN Fire pit  
 PL Palenisko ogrodowe  
 DE Gartenfeuerstelle  
 RU Садовый очаг  
 CZ Zahradní ohniště  
 RO Vatra de foc  
 HU Kerti tűzrakó  
 ES Fogón para jardín

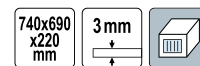

**LUND**

No.	1
99705	1

EN Fire pit  
 PL Palenisko ogrodowe  
 DE Gartenfeuerstelle  
 RU Садовый очаг  
 CZ Zahradní ohniště  
 RO Vatra de foc  
 HU Kerti tűzrakó  
 ES Fogón para jardín

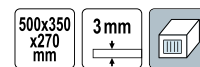

**LUND**

No.	1
99708	1



EN BBQ cover  
 PL Pokrowiec na grilla  
 DE Wetterschutzhaube  
 RU Обложка гриля  
 CZ Obal na gril  
 RO Gratar acoperă  
 HU Grill takaróponyva  
 ES Cubierta de barbacoa

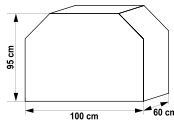

**LUND**

No.	Dimensions / Wymiary [cm]	For / Dla	
99760	100x60x95	99495, 99512, 99514, 99519, 99586, 99588, 99595, 99644, 99645, 99646, 99900, 99902, 99908, 99910	20

EN BBQ cover  
 PL Pokrowiec na grilla  
 DE Wetterschutzhaube  
 RU Обложка гриля  
 CZ Obal na gril  
 RO Gratar acoperă  
 HU Grill takaróponyva  
 ES Cubierta de barbacoa

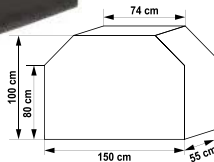

**LUND**

No.	Dimensions / Wymiary [cm]	For / Dla	
99762	150x55x100	99643, 99649, 99652, 99653, 99655, 99656	20

EN BBQ apron with accessories  
 PL Fartuch do grillowania z akcesoriami  
 DE Grillschürze  
 RU Фартук для барбекю  
 CZ Grilovací zástěra  
 RO Gratar șorț  
 HU Grill kötény  
 ES Delantal de la parrilla



No.		
99783		8/16

EN BBQ cover  
 PL Pokrowiec na grilla  
 DE Wetterschutzhaube  
 RU Обложка гриля  
 CZ Obal na gril  
 RO Gratar acoperă  
 HU Grill takaróponyva  
 ES Cubierta de barbacoa

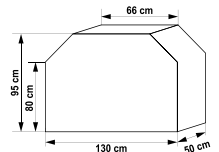

**LUND**

No.	Dimensions / Wymiary [cm]	For / Dla	
99761	130x50x95	99642, 99647, 99649, 99651, 99654, 99917	20

EN BBQ apron  
 PL Fartuch do grillowania  
 DE Grillschürze  
 RU Фартук для барбекю  
 CZ Grilovací zástěra  
 RO Gratar șorț  
 HU Grill kötény  
 ES Delantal de la parrilla



No.		
99782		60

EN Barbecue air blower  
 PL Dmuchawa do rozpalania grilla  
 DE Grillgebläse  
 RU Ручной вентилятор для гриля и барбекю  
 CZ Ruční dmychadlo ke grilu  
 RO Suflantă de aer pt. grătar  
 HU Kézi fúvó a grillezéshez  
 ES Soplador para encender barbacoas



**LUND**

No.	L [mm]	
99800	250	36

- EN Charcoal chimney
- PL Komin do rozpalania węgla
- DE Anzündkamin
- RU Устройство для зажигания угля
- CZ Zapalovací komin
- RO Dispozitiv pt. aprins carbuni
- HU Faszéngyújtó kémény
- ES Encendedor de carbón



**LUND**

No.	Ø [mm]	H [mm]	
99805	170	270	12

- EN Barbecue cleaning brush
- PL Szczotka do grilla
- DE Grillbürste
- RU Щетка для гриля
- CZ Kartáč do grilu
- RO Perie pt. curatat gratar
- HU Grillkefe
- ES Cepillo para barbacoa



**VOREL**

No.	L [mm]	
99528	305	16

- EN Barbecue fork
- PL Widelec ogniskowy
- DE Lagerfeuerspies
- RU Шампур-вилка для гриля
- CZ Vidlička na orekání
- RO Furculita pt. gratar
- HU Grillvilla
- ES Tenedor de fuego



No.	L [cm]	
99568	100	10/100

- EN Heat resistant gloves
- PL Rękawice odporne na wysoką temperaturę
- DE Hitzebeständige Handschuhe
- RU Термостойкие перчатки
- CZ Teplně odolné rukavice
- RO Mănuși rezistente la căldură
- HU Hőálló kesztyű
- ES Guantes para altas temperaturas

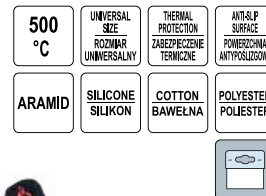

**LUND**

No.	
99820	50

- EN Barbecue fork
- PL Widelec ogniskowy
- DE Lagerfeuerspies
- RU Шампур-вилка для гриля
- CZ Vidlička na orekání
- RO Furculita pt. gratar
- HU Grillvilla
- ES Tenedor de fuego



No.	L [cm]	
99575	120	60

- EN Barbecue fork
- PL Widelec ogniskowy
- DE Lagerfeuerspies
- RU Шампур-вилка для гриля
- CZ Vidlička na orekání
- RO Furculita pt. gratar
- HU Grillvilla
- ES Tenedor de fuego

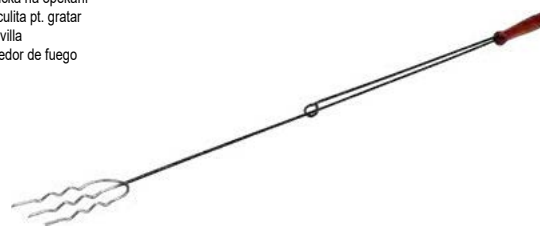

No.	L [cm]	
99576	120	60

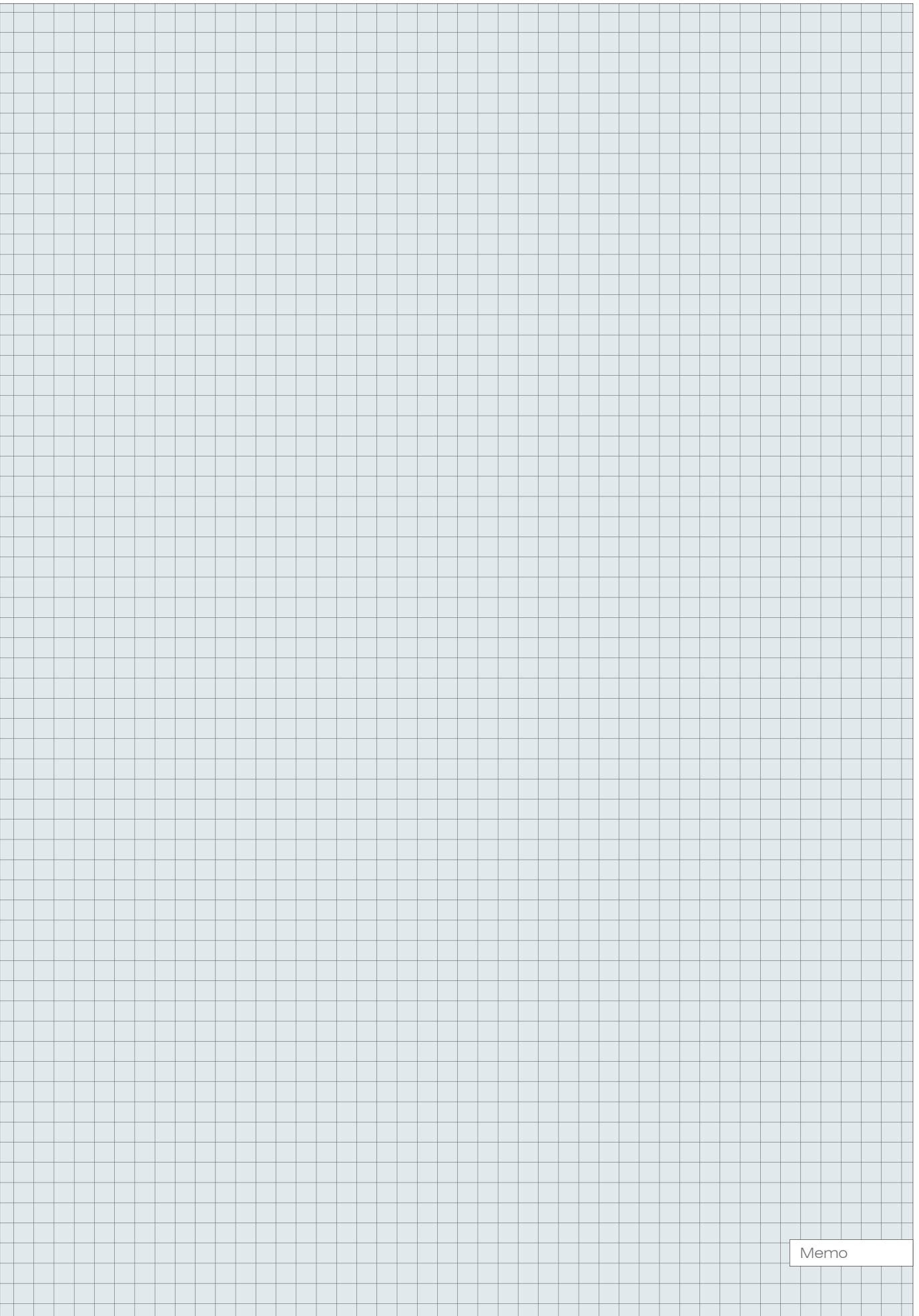

Memo

**25**

**Sanitary ware & hydraulics**  
**Armatura sanitarna i hydraulika**

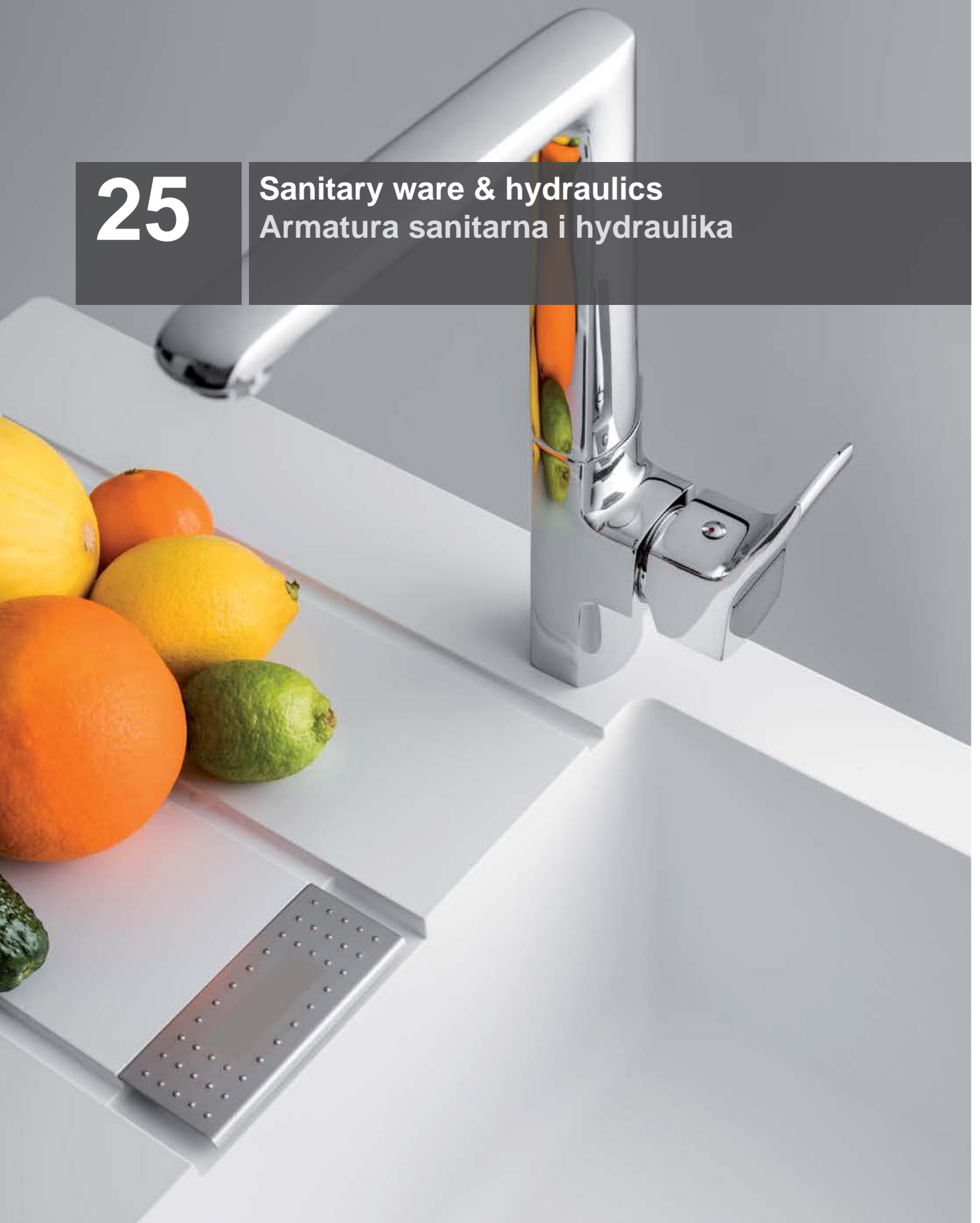



**Mixers, faucets**  
Baterie

.....452-466

**Linear drains**  
Odpływy liniowe

.....466-469

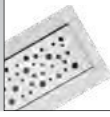
**Pop-up wastes**  
Korki automatyczne

.....469-470

**Shower handles**  
Słuchawki prysznicowe

.....470-473

**Shower & connecting hoses**  
Wężę prysznicowe i przyłączeniowe

.....474-476

**Bathroom & shower sets**  
Komplety łazienkowe i prysznicowe

.....477-478

**Bathroom accessories**  
Akcesoria łazienkowe

.....478-481

**Toilet seats**  
Deski toaletowe

.....481-482

**Plastic stools**  
Stołki plastikowe

.....483

**Hydraulic accessories**  
Akcesoria hydrauliczne

.....483-485



<p>The exclusive composition with sapphire hardness developed by famous spanish company.</p> <p>Głowica z wkładem ceramicznym o twardości szafiru renomowanego hiszpańskiego producenta.</p>  <p><b>CORUNDOx</b></p>	<p>Mixing water flow with intake air reduces consumption by half, without splashing.</p> <p>Zmieszany strumień wody z zasysanym powietrzem oszczędza zużycie o połowę i nie chlapie.</p>  <p><b>ECOflow</b></p>	<p>The most effective way to save water and energy - flowing only cold water when the lever is centered.</p> <p>Najefektywniejszy sposób oszczędzania wody i energii - dla uchwyty usytuowanego na wprost popłyne tylko zimna woda.</p>  <p><b>ECOstart</b></p>
<p>Nano-size cavities on the disc surface to keep the lubrication, provides a higher durability and an improved smooth feeling.</p> <p>Mikrozagiębnienia dzięki którym smar w głowicy nie wypłukuje się i głowica działa gładko przez wiele lat.</p>  <p><b>NANOCave</b></p>	<p>Rubbing the lime away with a finger and the stream is like in brand new faucet again.</p> <p>Przetarcie palcem usuwa kamień i przywraca strumień jak w nowej baterii.</p>  <p><b>SMARTclean</b></p>	<p>Reduced noise thanks to silencer in eccentric wall connector.</p> <p>Obniżony hałas dzięki użyciu tłumików w złączach.</p>  <p><b>LOWnoise</b></p>
<p>Ergonomic faucet provides more space for comfortable using.</p> <p>Ergonomiczna bateria zapewniająca przestrzeń dla wygodnego użytkownika.</p>  <p><b>ERGOsize</b></p>	<p>Simple and effective installation thanks to the large nut that screw without any tools.</p> <p>Łatwy i trwały montaż dzięki dużej nakrętkie, którą przykręcisz bez użycia jakiegokolwiek narzędzi.</p>  <p><b>SMARTnut</b></p>	<p>Improved lime protection: integrated honeycomb structure replaces conventional wire mesh screens prone to lime build-up.</p> <p>Lepsza ochrona przeciwkwapinna: struktura plastra miodu zastępuje klasyczne wkłady siateczkowe, które mają tendencję do zarastania.</p>  <p><b>HEXAGONal</b></p>
<p>Body without holes and nooks that could accumulate dirt and microorganisms.</p> <p>Korpus bez otworów i zakamarków, które gromadzą brud i mikroorganizmy.</p>  <p><b>CLEANbody</b></p>	<p>Innovative mounting system for hose nut and safe servicing aerator.</p> <p>Innowacyjny system montażu wężyków i bezpiecznego serwisowania aeratora.</p>  <p><b>SMARTtool</b></p>	<p>Multi-purpose hydraulic wrench for installation of faucet and small plumbing work.</p> <p>Wielofunkcyjny klucz hydrauliczny do montażu baterii i drobnych prac hydraulicznych.</p>  <p><b>SMARTtool</b></p>
<p>High quality stainless steel is characterized by increased resistance to chemicals, preserving its appearance even after many years of use.</p> <p>Wysokiej jakości stal nierdzewna charakteryzuje się zwiększoną odpornością na chemikalia, zachowując swój wygląd nawet po wielu latach użytkowania.</p>  <p><b>304 Sus304</b></p>	<p>Stainless steel is free of zinc and lead - toxic elements, which in micro quantities get into the water in brass faucets.</p> <p>Stal nierdzewna jest wolna od cynku i ołowiu - toksycznych pierwiastków, które w mikro ilościach dostają się do wody w mosiężnych kranach.</p>  <p><b>NOlead</b></p>	<p>All parts are made of stainless steel, so they are rust-resistant.</p> <p>Wszystkie części wykonane są ze stali nierdzewnej i są odporne na rdzę.</p>  <p><b>FULL steel</b></p>

- EN Basin mixer
- PL Bateria umywalkowa
- DE Einhand-Waschtischbatterie
- RU Смеситель для раковины
- CZ Umyvadlová baterie
- RO Baterie lavoar
- HU Mosdó csaptelep
- ES Monomando de lavabo



**FALA**

No.	Series / Seria	
75801	Steely 1	20



- EN Basin mixer
- PL Bateria umywalkowa
- DE Einhand-Waschtischbatterie
- RU Смеситель для раковины
- CZ Umyvadlová baterie
- RO Baterie lavoar
- HU Mosdó csaptelep
- ES Monomando de lavabo



**FALA**

No.	Series / Seria	
75802	Steely 2	12



- EN Basin mixer
- PL Bateria umywalkowa
- DE Einhand-Waschtischbatterie
- RU Смеситель для раковины
- CZ Umyvadlová baterie
- RO Baterie lavoar
- HU Mosdó csaptelep
- ES Monomando de lavabo



**FALA**

No.	Series / Seria	
75803	Steely 3	10



EN Shower column  
 PL Kolumna prysznicowa  
 DE Duschsäule  
 RU Душевая штанга  
 CZ Sprchový sloup  
 RO Coloană de duș  
 HU Zuhanyoszlop  
 ES Columna de ducha



**FALA**

No.	Series / Seria	
75662	Steely 1	5

EN Shower column  
 PL Kolumna prysznicowa  
 DE Duschsäule  
 RU Душевая штанга  
 CZ Sprchový sloup  
 RO Coloană de duș  
 HU Zuhanyoszlop  
 ES Columna de ducha



**FALA**

No.	Series / Seria	
75664	Steely 3	5

EN Single-lever sink mixer  
 PL Bateria zlewozmywakowa  
 DE Einhand-Spültischbatterie  
 RU Смеситель для кухни  
 CZ Dřezová baterie  
 RO Baterie stativă bucatărie  
 HU Mosogató csaptelep  
 ES Monomando de fregadero

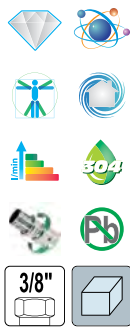

**FALA**

No.	Series / Seria	
75716	Steely 1	10

EN Shower column  
 PL Kolumna prysznicowa  
 DE Duschsäule  
 RU Душевая штанга  
 CZ Sprchový sloup  
 RO Coloană de duș  
 HU Zuhanyoszlop  
 ES Columna de ducha



**FALA**

No.	Series / Seria	
75663	Steely 2	5

EN Shower column  
 PL Kolumna prysznicowa  
 DE Duschsäule  
 RU Душевая штанга  
 CZ Sprchový sloup  
 RO Coloană de duș  
 HU Zuhanyoszlop  
 ES Columna de ducha



**FALA**

No.	Series / Seria	
75665	Steely 4	5

EN Single-lever sink mixer  
 PL Bateria zlewozmywakowa  
 DE Einhand-Spültischbatterie  
 RU Смеситель для кухни  
 CZ Dřezová baterie  
 RO Baterie stativă bucatărie  
 HU Mosogató csaptelep  
 ES Monomando de fregadero

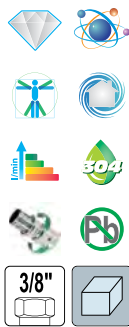

**FALA**

No.	Series / Seria	
75718	Steely 2	10

EN Single-lever sink mixer  
 PL Bateria zlewozmywakowa  
 DE Einhand-Spültischbatterie  
 RU Смеситель для кухни  
 CZ Dřezová baterie  
 RO Baterie stativă bucatărie  
 HU Mosogató csaptelep  
 ES Monomando de fregadero

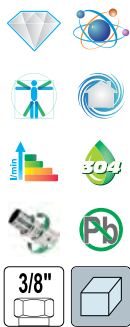

**FALA**

No.	Series / Seria	Boxes
75719	Steely 3	10

EN Single-lever sink mixer  
 PL Bateria zlewozmywakowa  
 DE Einhand-Spültischbatterie  
 RU Смеситель для кухни  
 CZ Dřezová baterie  
 RO Baterie stativă bucatărie  
 HU Mosogató csaptelep  
 ES Monomando de fregadero



**FALA**

No.	Series / Seria	Boxes
75806	Steely 5	5

EN Basin mixer  
 PL Bateria umywalkowa  
 DE Einhand-Waschtischbatterie  
 RU Смеситель для раковины  
 CZ Umyvadlová baterie  
 RO Baterie lavoar  
 HU Mosdó csaptelep  
 ES Monomando de lavabo



**FALA**

No.	Series / Seria	Boxes
75807	Retro Black 1	12

EN Single-lever sink mixer  
 PL Bateria zlewozmywakowa  
 DE Einhand-Spültischbatterie  
 RU Смеситель для кухни  
 CZ Dřezová baterie  
 RO Baterie stativă bucatărie  
 HU Mosogató csaptelep  
 ES Monomando de fregadero



**FALA**

No.	Series / Seria	Boxes
75805	Steely 4	5

EN Built-in shower system  
 PL Podtynkowy system prysznicowy  
 DE Unterputz-duschsystem  
 RU Душевой гарнитур скрытого монтажа  
 CZ Sprchový podomítkový set  
 RO Set de dus incastat baterie  
 HU Falsik alatti zuhanyszett  
 ES Sistema dual de ducha empotrado



**FALA**

No.	Series / Seria	Boxes
75870	Steely R	4

EN Bath mixer  
 PL Bateria wannowa  
 DE Einhand-Wannenbatterie  
 RU Смеситель для ванны  
 CZ Vanové baterie  
 RO Baterie cada / dus  
 HU Egykaros kádcsaptelep  
 ES Monomando para baño



**FALA**

No.	Series / Seria	Boxes
75808	Retro Black 1	12



EN Shower column  
 PL Kolumna prysznicowa  
 DE Duschsäule  
 RU Душевая штанга  
 CZ Sprchový sloup  
 RO Coloană de duș  
 HU Zuhanyoszlop  
 ES Columna de ducha



**FALA**

No.	Series / Seria	
75809	Retro Black 1	5

EN Basin mixer  
 PL Bateria umywalkowa wysoka  
 DE Einhand-Waschtischbatterie  
 RU Смеситель для раковины  
 CZ Umyvadlová baterie  
 RO Baterie lavoar  
 HU Mosdó csaptelep  
 ES Monomando de lavabo



**FALA**

No.	Series / Seria	
75812	Retro Black 2	12

EN Basin mixer  
 PL Bateria umywalkowa wysoka  
 DE Einhand-Waschtischbatterie  
 RU Смеситель для раковины  
 CZ Umyvadlová baterie  
 RO Baterie lavoar  
 HU Mosdó csaptelep  
 ES Monomando de lavabo



**FALA**

No.	Series / Seria	
75815	Retro Black 3	6

EN Basin mixer  
 PL Bateria umywalkowa  
 DE Einhand-Waschtischbatterie  
 RU Смеситель для раковины  
 CZ Umyvadlová baterie  
 RO Baterie lavoar  
 HU Mosdó csaptelep  
 ES Monomando de lavabo



**FALA**

No.	Series / Seria	
75811	Retro Black 2	12

EN Shower column  
 PL Kolumna prysznicowa  
 DE Duschsäule  
 RU Душевая штанга  
 CZ Sprchový sloup  
 RO Coloană de duș  
 HU Zuhanyoszlop  
 ES Columna de ducha



**FALA**

No.	Series / Seria	
75813	Retro Black 2	5

EN Bath mixer  
 PL Bateria wannowa  
 DE Einhand-Wannenbatterie  
 RU Смеситель для ванны  
 CZ Vanové baterie  
 RO Baterie cada / dus  
 HU Egykaros kádcsaptelep  
 ES Monomando para baño



**FALA**

No.	Series / Seria	
75816	Retro Black 3	12

- EN Single-lever shower mixer
- PL Bateria prysznicowa
- DE Einhand-Brausebatterie
- RU Смеситель для душа
- CZ Sprchová baterie
- RO Baterie dus
- HU Egykaros zuhanycsaptelep
- ES Monomando de ducha



**FALA**

No.	Series / Seria	
75817	Retro Black 3	12

- EN Basin mixer
- PL Bateria umywalkowa
- DE Einhand-Waschtischbatterie
- RU Смеситель для раковины
- CZ Umyvadlová baterie
- RO Baterie lavoar
- HU Mosdó csaptelep
- ES Monomando de lavabo



**FALA**

No.	Series / Seria	
75827	Retro Bronze 1	12

- EN Shower column
- PL Kolumna prysznicowa
- DE Duschsäule
- RU Душевая штанга
- CZ Sprchový sloup
- RO Coloană de duș
- HU Zuhanyoszlop
- ES Columna de ducha

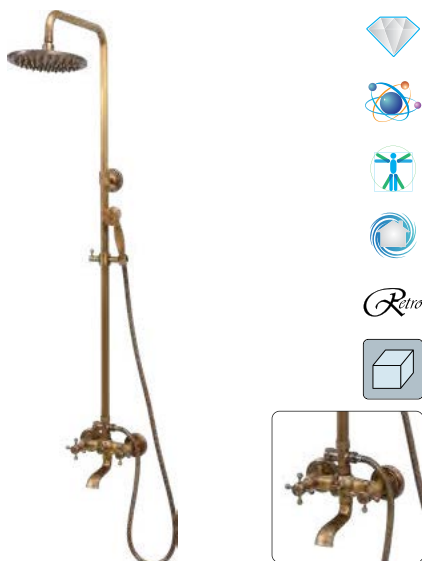

**FALA**

No.	Series / Seria	
75829	Retro Bronze 1	5

- EN Shower column
- PL Kolumna prysznicowa
- DE Duschsäule
- RU Душевая штанга
- CZ Sprchový sloup
- RO Coloană de duș
- HU Zuhanyoszlop
- ES Columna de ducha



**FALA**

No.	Series / Seria	
75818	Retro Black 3	5

- EN Bath mixer
- PL Bateria wannowa
- DE Einhand-Wannenbatterie
- RU Смеситель для ванны
- CZ Vanové baterie
- RO Baterie cada / dus
- HU Egykaros kádcsaptelep
- ES Monomando para bañoo



**FALA**

No.	Series / Seria	
75828	Retro Bronze 1	12

- EN Basin mixer
- PL Bateria umywalkowa
- DE Einhand-Waschtischbatterie
- RU Смеситель для раковины
- CZ Umyvadlová baterie
- RO Baterie lavoar
- HU Mosdó csaptelep
- ES Monomando de lavabo



**FALA**

No.	Series / Seria	
75836	Retro Bronze 2	12

EN Basin mixer  
 PL Bateria umywalkowa wysoka  
 DE Einhand-Waschtischbatterie  
 RU Смеситель для раковины  
 CZ Umyvadlová baterie  
 RO Bateria lavoar  
 HU Mosdó csaptelep  
 ES Monomando de lavabo

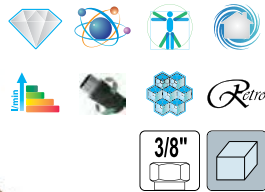

**FALA**

No.	Series / Seria	
75837	Retro Bronze 2	12

EN Single-lever sink mixer  
 PL Bateria zlewozmywakowa  
 DE Einhand-Spültischbatterie  
 RU Смеситель для кухни  
 CZ Dřezová baterie  
 RO Baterie stativă bucătărie  
 HU Mosogató csaptelep  
 ES Monomando de fregadero



**FALA**

No.	Series / Seria	
75834	Retro Black 1	12

EN Single-lever sink mixer  
 PL Bateria zlewozmywakowa  
 DE Einhand-Spültischbatterie  
 RU Смеситель для кухни  
 CZ Dřezová baterie  
 RO Baterie stativă bucătărie  
 HU Mosogató csaptelep  
 ES Monomando de fregadero



**FALA**

No.	Series / Seria	
75830	Retro Bronze 1	12

EN Shower column  
 PL Kolumna prysznicowa  
 DE Duschsäule  
 RU Душевая штанга  
 CZ Sprchový sloup  
 RO Coloană de duș  
 HU Zuhanyoszlop  
 ES Columna de ducha

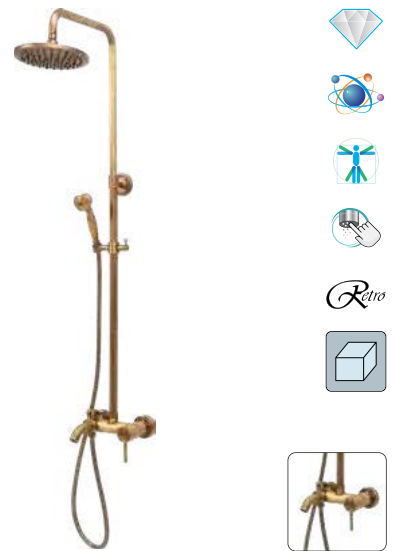

**FALA**

No.	Series / Seria	
75838	Retro Bronze 2	5

EN Single-lever sink mixer  
 PL Bateria zlewozmywakowa  
 DE Einhand-Spültischbatterie  
 RU Смеситель для кухни  
 CZ Dřezová baterie  
 RO Baterie stativă bucătărie  
 HU Mosogató csaptelep  
 ES Monomando de fregadero



**FALA**

No.	Series / Seria	
75835	Retro Black 2	12

EN Single-lever sink mixer  
 PL Bateria zlewozmywakowa  
 DE Einhand-Spültischbatterie  
 RU Смеситель для кухни  
 CZ Dřezová baterie  
 RO Baterie stativă bucătărie  
 HU Mosogató csaptelep  
 ES Monomando de fregadero



**FALA**

No.	Series / Seria	
75831	Retro Bronze 2	12

EN Single-lever sink mixer  
 PL Bateria zlewozmywakowa  
 DE Einhand-Spültischbatterie  
 RU Смеситель для кухни  
 CZ Dřezová baterie  
 RO Baterie stativă bucatărie  
 HU Mosogató csaptelep  
 ES Monomando de fregadero

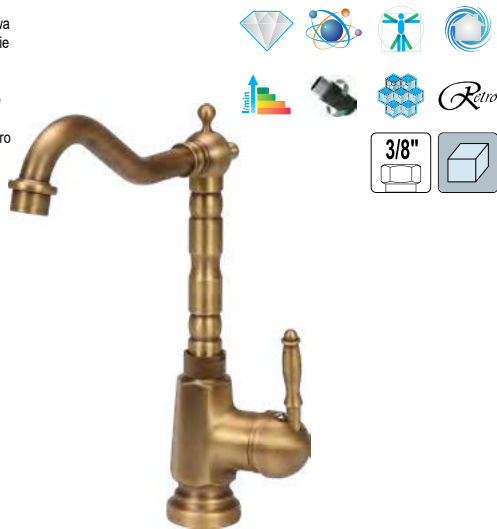

**FALA**

No.	Series / Seria	
75832	Retro Bronze 3	12

EN Basin mixer  
 PL Bateria umywalkowa  
 DE Einhand-Waschtischbatterie  
 RU Смеситель для раковины  
 CZ Umyvadlová baterie  
 RO Baterie lavoar  
 HU Mosdó csaptelep  
 ES Monomando de lavabo



**FALA**

No.	Series / Seria	
75880	Noir 1	12

EN Shower column  
 PL Kolumna prysznicowa  
 DE Duschsäule  
 RU Душевая штанга  
 CZ Sprchový sloup  
 RO Coloană de duș  
 HU Zuhanyoszlop  
 ES Columna de ducha



**FALA**

No.	Series / Seria	
75883	Noir 1	4

EN Single-lever sink mixer  
 PL Bateria zlewozmywakowa  
 DE Einhand-Spültischbatterie  
 RU Смеситель для кухни  
 CZ Dřezová baterie  
 RO Baterie stativă bucatărie  
 HU Mosogató csaptelep  
 ES Monomando de fregadero



**FALA**

No.	Series / Seria	
75833	Retro Bronze 4	12

EN Bath mixer  
 PL Bateria wannowa  
 DE Einhand-Wannenbatterie  
 RU Смеситель для ванны  
 CZ Vanové baterie  
 RO Baterie cada / dus  
 HU Egykaros kádcsaptelep  
 ES Monomando para baño



**FALA**

No.	Series / Seria	
75882	Noir 1	8

EN Single-lever sink mixer  
 PL Bateria zlewozmywakowa  
 DE Einhand-Spültischbatterie  
 RU Смеситель для кухни  
 CZ Dřezová baterie  
 RO Baterie stativă bucatărie  
 HU Mosogató csaptelep  
 ES Monomando de fregadero



**FALA**

No.	Series / Seria	
75884	Noir 1	12



EN Basin mixer  
 PL Bateria umywalkowa  
 DE Einhand-Waschtischbatterie  
 RU Смеситель для раковины  
 CZ Umyvadlová baterie  
 RO Baterie lavoar  
 HU Mosdó csaptelep  
 ES Monomando de lavabo



**FALA**

No.	Series / Seria	Box
75885	Noir 2	12

EN Basin mixer  
 PL Bateria umywalkowa  
 DE Einhand-Waschtischbatterie  
 RU Смеситель для раковины  
 CZ Umyvadlová baterie  
 RO Baterie lavoar  
 HU Mosdó csaptelep  
 ES Monomando de lavabo

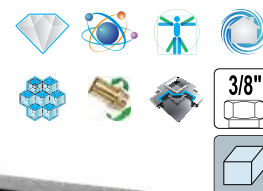

**FALA**

No.	Series / Seria	Box
75886	Noir 2	12

EN Single-lever shower mixer  
 PL Bateria prysznicowa  
 DE Einhand-Brausebatterie  
 RU Смеситель для душа  
 CZ Sprchová baterie  
 RO Baterie dus  
 HU Egykaros zuhanycsaptelep  
 ES Monomando de ducha



**FALA**

No.	Series / Seria	Box
75887	Noir 2	8

EN Bath mixer  
 PL Bateria wannowa  
 DE Einhand-Wannenbatterie  
 RU Смеситель для ванны  
 CZ Vanové baterie  
 RO Baterie cada / dus  
 HU Egykaros kádcsaptelep  
 ES Monomando para baño



**FALA**

No.	Series / Seria	Box
75888	Noir 2	8

EN Shower column  
 PL Kolumna prysznicowa  
 DE Duschsäule  
 RU Душевая штанга  
 CZ Sprchový sloup  
 RO Coloană de duș  
 HU Zuhanyoszlop  
 ES Columna de ducha



**FALA**

No.	Series / Seria	Box
75889	Noir 2	4

EN Single-lever sink mixer  
 PL Bateria zlewozmywakowa  
 DE Einhand-Spültischbatterie  
 RU Смеситель для кухни  
 CZ Dřezová baterie  
 RO Baterie stativă bucatărie  
 HU Mosogató csaptelep  
 ES Monomando de fregadero



**FALA**

No.	Series / Seria	Box
75705	Flexible-Black	10

EN Single-lever sink mixer  
 PL Bateria zlewozmywakowa  
 DE Einhand-Spültischbatterie  
 RU Смеситель для кухни  
 CZ Dřezová baterie  
 RO Baterie stativă bucatărie  
 HU Mosogató csaptelep  
 ES Monomando de fregadero

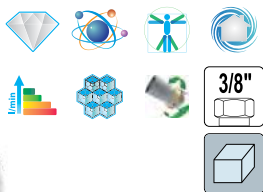

**FALA**

No.	Series / Seria	10
75706	Flexible-White	10

EN Single-lever sink mixer  
 PL Bateria zlewozmywakowa  
 DE Einhand-Spültischbatterie  
 RU Смеситель для кухни  
 CZ Dřezová baterie  
 RO Baterie stativă bucatărie  
 HU Mosogató csaptelep  
 ES Monomando de fregadero

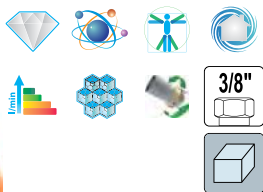

**FALA**

No.	Series / Seria	10
75708	Flexible-Orange	10

EN Single-lever sink mixer  
 PL Bateria zlewozmywakowa  
 DE Einhand-Spültischbatterie  
 RU Смеситель для кухни  
 CZ Dřezová baterie  
 RO Baterie stativă bucatărie  
 HU Mosogató csaptelep  
 ES Monomando de fregadero



**FALA**

No.	Series / Seria	10
75710	Flexible-Light Grey	10

EN Single-lever sink mixer  
 PL Bateria zlewozmywakowa  
 DE Einhand-Spültischbatterie  
 RU Смеситель для кухни  
 CZ Dřezová baterie  
 RO Baterie stativă bucatărie  
 HU Mosogató csaptelep  
 ES Monomando de fregadero

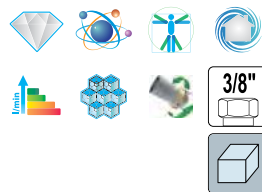

**FALA**

No.	Series / Seria	10
75707	Flexible-Red	10

EN Single-lever sink mixer  
 PL Bateria zlewozmywakowa  
 DE Einhand-Spültischbatterie  
 RU Смеситель для кухни  
 CZ Dřezová baterie  
 RO Baterie stativă bucatărie  
 HU Mosogató csaptelep  
 ES Monomando de fregadero

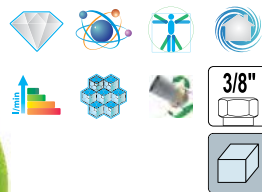

**FALA**

No.	Series / Seria	10
75709	Flexible-Green	10

EN Single-lever sink mixer  
 PL Bateria zlewozmywakowa  
 DE Einhand-Spültischbatterie  
 RU Смеситель для кухни  
 CZ Dřezová baterie  
 RO Baterie stativă bucatărie  
 HU Mosogató csaptelep  
 ES Monomando de fregadero



**FALA**

No.	Series / Seria	10
75711	Flexible-Dark Grey	10

EN Single-lever sink mixer  
 PL Bateria zlewozmywakowa  
 DE Einhand-Spültischbatterie  
 RU Смеситель для кухни  
 CZ Dřezová baterie  
 RO Baterie stativă bucatărie  
 HU Mosogató csaptelep  
 ES Monomando de fregadero



**FALA**

No.	Series / Seria	
75712	Flexible-Brown	10

EN Single-lever sink mixer  
 PL Bateria zlewozmywakowa  
 DE Einhand-Spültischbatterie  
 RU Смеситель для кухни  
 CZ Dřezová baterie  
 RO Baterie stativă bucatărie  
 HU Mosogató csaptelep  
 ES Monomando de fregadero



**FALA**

No.	Series / Seria	
75729	Flexible-Steely Black	10

EN Single-lever sink mixer  
 PL Bateria zlewozmywakowa  
 DE Einhand-Spültischbatterie  
 RU Смеситель для кухни  
 CZ Dřezová baterie  
 RO Baterie stativă bucatărie  
 HU Mosogató csaptelep  
 ES Monomando de fregadero



**FALA**

No.	Series / Seria	
75775	Black Flexible-Black	10

EN Single-lever sink mixer  
 PL Bateria zlewozmywakowa  
 DE Einhand-Spültischbatterie  
 RU Смеситель для кухни  
 CZ Dřezová baterie  
 RO Baterie stativă bucatărie  
 HU Mosogató csaptelep  
 ES Monomando de fregadero



**FALA**

No.	Series / Seria	
75776	Black Flexible-White	10

EN Single-lever sink mixer  
 PL Bateria zlewozmywakowa  
 DE Einhand-Spültischbatterie  
 RU Смеситель для кухни  
 CZ Dřezová baterie  
 RO Baterie stativă bucatărie  
 HU Mosogató csaptelep  
 ES Monomando de fregadero



**FALA**

No.	Series / Seria	
75777	Black Flexible-Red	10

EN Single-lever sink mixer  
 PL Bateria zlewozmywakowa  
 DE Einhand-Spültischbatterie  
 RU Смеситель для кухни  
 CZ Dřezová baterie  
 RO Baterie stativă bucatărie  
 HU Mosogató csaptelep  
 ES Monomando de fregadero



**FALA**

No.	Series / Seria	
75778	Black Flexible-Orange	10





EN Single-lever sink mixer  
 PL Bateria zlewozmywakowa ścienna  
 DE Einhand-Spültischbatterie  
 RU Смеситель для кухни  
 CZ Dřezová baterie  
 RO Baterie bucătărie  
 HU Mosogató csaptelep  
 ES Monomando de fregadero



**FALA**

No.	Series / Seria	Box
75671	Flexible-White	10

EN Single-lever sink mixer  
 PL Bateria zlewozmywakowa ścienna  
 DE Einhand-Spültischbatterie  
 RU Смеситель для кухни  
 CZ Dřezová baterie  
 RO Baterie bucătărie  
 HU Mosogató csaptelep  
 ES Monomando de fregadero



**FALA**

No.	Series / Seria	Box
75672	Flexible-Red	10

EN Single-lever sink mixer  
 PL Bateria zlewozmywakowa ścienna  
 DE Einhand-Spültischbatterie  
 RU Смеситель для кухни  
 CZ Dřezová baterie  
 RO Baterie bucătărie  
 HU Mosogató csaptelep  
 ES Monomando de fregadero



**FALA**

No.	Series / Seria	Box
75673	Flexible-Orange	10

EN Single-lever sink mixer  
 PL Bateria zlewozmywakowa ścienna  
 DE Einhand-Spültischbatterie  
 RU Смеситель для кухни  
 CZ Dřezová baterie  
 RO Baterie bucătărie  
 HU Mosogató csaptelep  
 ES Monomando de fregadero



**FALA**

No.	Series / Seria	Box
75674	Flexible-Green	10

EN Pop-up waste  
 PL Korek z sitkiem  
 DE Waschbecken Stöpsel  
 RU Пробка  
 CZ Zátka  
 RO Sifon chiuveta  
 HU Mosdo lefolyó elzaro  
 ES Tapón

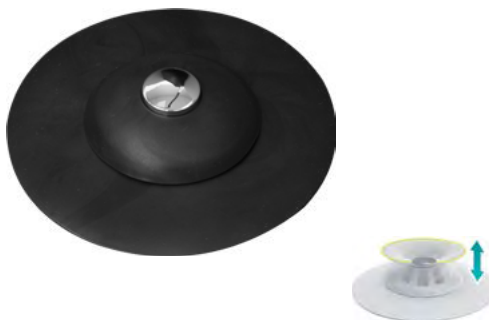

**FALA**

No.	Box
74780	240

EN Pop-up waste  
 PL Korek z sitkiem  
 DE Waschbecken Stöpsel  
 RU Пробка  
 CZ Zátka  
 RO Sifon chiuveta  
 HU Mosdo lefolyó elzaro  
 ES Tapón



**FALA**

No.	Box
74781	240

EN Pop-up waste  
 PL Korek z sitkiem  
 DE Waschbecken Stöpsel  
 RU Пробка  
 CZ Zátka  
 RO Sifon chiuveta  
 HU Mosdo lefolyo elzaro  
 ES Tapón



**FALA**

**SMARTstop**

No.	
74782	240

EN Pop-up waste  
 PL Korek z sitkiem  
 DE Waschbecken Stöpsel  
 RU Пробка  
 CZ Zátka  
 RO Sifon chiuveta  
 HU Mosdo lefolyo elzaro  
 ES Tapón



**FALA**

**SMARTstop**

No.	
74784	240

EN Organizer  
 PL Organizator  
 DE Organizer  
 RU Органайзер  
 CZ Organizér  
 RO Organizator  
 HU Szervező  
 ES Organizador



**FALA**

No.	
74785	144

EN Organizer  
 PL Organizator  
 DE Organizer  
 RU Органайзер  
 CZ Organizér  
 RO Organizator  
 HU Szervező  
 ES Organizador



**FALA**

No.	
74786	144

EN Organizer  
 PL Organizator  
 DE Organizer  
 RU Органайзер  
 CZ Organizér  
 RO Organizator  
 HU Szervező  
 ES Organizador



**FALA**

No.	
74787	144

EN Organizer  
 PL Organizator  
 DE Organizer  
 RU Органайзер  
 CZ Organizér  
 RO Organizator  
 HU Szervező  
 ES Organizador



**FALA**

No.	
74789	144

EN Mat  
PL Mata  
DE Matte  
RU Коврик  
CZ Podložka  
RO Mat  
HU Lábtörő  
ES Alfombra



**FALA**

No.

74790



50/200

EN Mat  
PL Mata  
DE Matte  
RU Коврик  
CZ Podložka  
RO Mat  
HU Lábtörő  
ES Alfombra



**FALA**

No.

74791



50/200

EN Mat  
PL Mata  
DE Matte  
RU Коврик  
CZ Podložka  
RO Mat  
HU Lábtörő  
ES Alfombra



**FALA**

No.

74792



50/200

EN Mat  
PL Mata  
DE Matte  
RU Коврик  
CZ Podložka  
RO Mat  
HU Lábtörő  
ES Alfombra



**FALA**

No.

74794



50/200

EN Soap dispenser  
PL Dozownik mydła w płynie  
DE Seifenspender  
RU Дозатор для мыла  
CZ Dávkovač mydla  
RO Dozator sapun lichid  
HU Folyékonyszappan adagoló  
ES Dispensador de jabón



**FALA**

No.

69395



100

EN Soap dispenser  
PL Dozownik mydła w płynie  
DE Seifenspender  
RU Дозатор для мыла  
CZ Dávkovač mydla  
RO Dozator sapun lichid  
HU Folyékonyszappan adagoló  
ES Dispensador de jabón



**FALA**

No.

69396



100

EN Soap dispenser  
PL Dozownik mydła w płynie  
DE Seifenspender  
RU Дозатор для мыла  
CZ Dávkovač mydla  
RO Dozator sapun lichid  
HU Folyékonyszappan adagoló  
ES Dispensador de jabón



**FALA**

No.

69397



100

EN Soap dispenser  
PL Dozownik mydła w płynie  
DE Seifenspender  
RU Дозатор для мыла  
CZ Dávkovač mydla  
RO Dozator sapun lichid  
HU Folyékonyszappan adagoló  
ES Dispensador de jabón



**FALA**

No.

69390



60

EN Soap dispenser CZ Dávkač mýdla  
 PL Dozownik mydła w płynie RO Dozator sapun lichid  
 DE Seifenspender HU Folyékonyszappan adagoló  
 RU Дозатор для мыла ES Dispensador de jabón

**FALA**

No.	
69391	24



Special inspection window for 100% outflow control and comfortable cleaning.

Specjalne okienko rewizyjne to 100% kontroli drożności i wygodne czyszczenie.



**SMARTthru**

Easy to clean thanks to contained hook.

Łatwy do utrzymania w czystości dzięki dołączonemu haczykowi.



**EASYclean**

Stabilizing body grips, additional stiffening in the floor.

Uchwyty stabilizujące korpus. Dodatkowe usztywnienie konstrukcji w podłodze.



**GRIPstrong**

Waterproof cloth included – as essential part of waterproofing.

Mata uszczelniająca w zestawie – niezbędna część przy wykonywaniu hydroizolacji.



**HYDRocloth**

Effective and durable strainer which prevents clogging of the trap and makes cleaning easier.

Skuteczne i trwałe sito, które zapobiega zapychaniu syfonu oraz ułatwia bieżącą obsługę odpływu.



**STRAINer**

High quality precision welds guarantee no leaking of the drain.

Wysokiej jakości precyzyjne spawy gwarantujące szczelność odpływu.



**HQwelding**

Low siphon made of stainless steel AISI 304 makes installation easier.

Niski syfon wykonany ze stali nierdzewnej AISI 304 ułatwiający instalację.



52 mm  
**EXTRASlim**

Wide range of height adjustment allows adjusting to the floor level.

Szeroki zakres regulacji wysokości, który umożliwi dopasowanie odpływu do powierzchni posadzki.



**EASYfix**

It can prevent stink and worms both in use and after dry (no water in siphon).

Zapobiega przedostawaniu się zapachów oraz robaków podczas używania jak i po wysuszeniu (brak wody w syfonie).



**WET&DRY**

EN Linear drain  
 PL Odplyw liniowy  
 DE Duschrinne  
 RU Душевой лоток  
 CZ Odtokový žlab  
 RO Rigola dus  
 HU Zuhanyfolyóka  
 ES Canal de ducha



EN Linear drain  
 PL Odplyw liniowy  
 DE Duschrinne  
 RU Душевой лоток  
 CZ Odtokový žlab  
 RO Rigola dus  
 HU Zuhanyfolyóka  
 ES Canal de ducha



**FALA**

No.	Body length / Długość rynny [mm]	Series / Seria	
75345	500	Rotary	5
75346	600	Rotary	5
75347	700	Rotary	5
75348	800	Rotary	5
75349	900	Rotary	5

**FALA**

No.	Body length / Długość rynny [mm]	Series / Seria	
75350	300	Brick	5
75351	400	Brick	5
75352	500	Brick	5
75353	600	Brick	5
75354	700	Brick	5
75355	800	Brick	5
75356	900	Brick	5



EN Linear drain  
 PL Odpływ liniowy  
 DE Duschrinne  
 RU Душевой лоток  
 CZ Odtokový žlab  
 RO Rigola dus  
 HU Zuhanyfolyóka  
 ES Canal de ducha



**FALA**

No.	Body length / Długość rynny [mm]	Series / Seria	Package	
75360	300	Madeira		6
75361	400	Madeira		6
75362	500	Madeira		6
75363	600	Madeira		6
75364	700	Madeira		6
75365	800	Madeira		6
75366	900	Madeira		6

EN Linear drain  
 PL Odpływ liniowy  
 DE Duschrinne  
 RU Душевой лоток  
 CZ Odtokový žlab  
 RO Rigola dus  
 HU Zuhanyfolyóka  
 ES Canal de ducha



**FALA**

No.	Body length / Długość rynny [mm]	Series / Seria	Package	
75374	300	Napo		6
75375	400	Napo		6
75376	500	Napo		6
75377	600	Napo		6
75378	700	Napo		6
75379	800	Napo		6
75380	900	Napo		6

EN Linear drain  
 PL Odpływ liniowy  
 DE Duschrinne  
 RU Душевой лоток  
 CZ Odtokový žlab  
 RO Rigola dus  
 HU Zuhanyfolyóka  
 ES Canal de ducha



**FALA**

No.	Body length / Długość rynny [mm]	Series / Seria	
71610	600	Wet & dry white glass	6
71611	700	Wet & dry white glass	6
71612	800	Wet & dry white glass	6

EN Linear drain  
 PL Odpływ liniowy  
 DE Duschrinne  
 RU Душевой лоток  
 CZ Odtokový žlab  
 RO Rigola dus  
 HU Zuhanyfolyóka  
 ES Canal de ducha



**FALA**

No.	Body length / Długość rynny [mm]	Series / Seria	Package	
75367	300	Tocantins		6
75368	400	Tocantins		6
75369	500	Tocantins		6
75370	600	Tocantins		6
75371	700	Tocantins		6
75372	800	Tocantins		6
75373	900	Tocantins		6

EN Linear drain  
 PL Odpływ liniowy  
 DE Duschrinne  
 RU Душевой лоток  
 CZ Odtokový žlab  
 RO Rigola dus  
 HU Zuhanyfolyóka  
 ES Canal de ducha



**FALA**

No.	Body length / Długość rynny [mm]	Series / Seria	
75381	600	White Glass	6
75382	700	White Glass	6
75383	800	White Glass	6
75384	900	White Glass	6

EN Linear drain  
 PL Odpływ liniowy  
 DE Duschrinne  
 RU Душевой лоток  
 CZ Odtokový žlab  
 RO Rigola dus  
 HU Zuhanyfolyóka  
 ES Canal de ducha



**FALA**

No.	Body length / Długość rynny [mm]	Series / Seria	
75386	600	Black Glass	6
75387	700	Black Glass	6
75388	800	Black Glass	6
75389	900	Black Glass	6

EN Linear drain  
 PL Odpływ liniowy  
 DE Duschrinne  
 RU Душевой лоток  
 CZ Odtokový žlab  
 RO Rigola dus  
 HU Zuhanyfolyóka  
 ES Canal de ducha



**FALA**

No.	Body length / Długość rynny [mm]	Series / Seria	
71614	600	Wet & dry black glass	6
71615	700	Wet & dry black glass	6
71616	800	Wet & dry black glass	6

EN Linear drain  
 PL Odpływ liniowy  
 DE Duschrinne  
 RU Душевой лоток  
 CZ Odtokový žlab  
 RO Rigola dus  
 HU Zuhanyfolyóka  
 ES Canal de ducha



**FALA**

No.	Body length / Długość rynny [mm]	Series / Seria	
75448	600	Line	6
75449	700	Line	6
75450	800	Line	6
75451	900	Line	6

EN Linear drain  
 PL Odpływ liniowy  
 DE Duschrinne  
 RU Душевой лоток  
 CZ Odtokový žlab  
 RO Rigola dus  
 HU Zuhanyfolyóka  
 ES Canal de ducha

**FALA**

No.	Body length / Długość rynny [mm]	Series / Seria	
71635	500	Slim black	5
71636	600	Slim black	5
71637	700	Slim black	5
71638	800	Slim black	5
71639	900	Slim black	5

EN Linear drain  
 PL Odpływ liniowy  
 DE Duschrinne  
 RU Душевой лоток  
 CZ Odtokový žlab  
 RO Rigola dus  
 HU Zuhanyfolyóka  
 ES Canal de ducha



**FALA**

No.	Body length / Długość rynny [mm]	Series / Seria	
75421	600	Olimp	6
75422	700	Olimp	6
75423	800	Olimp	6
75424	900	Olimp	6

EN Linear drain  
 PL Odpływ liniowy  
 DE Duschrinne  
 RU Душевой лоток  
 CZ Odtokový žlab  
 RO Rigola dus  
 HU Zuhanyfolyóka  
 ES Canal de ducha



**FALA**

No.	Body length / Długość rynny [mm]	Series / Seria	
71630	500	Slim	5
71631	600	Slim	5
71632	700	Slim	5
71633	800	Slim	5
71634	900	Slim	5



EN Linear drain  
 PL Odpływ liniowy  
 DE Duschrinne  
 RU Душевой лоток  
 CZ Odtokový žlab  
 RO Rigola dus  
 HU Zuhanyfolyóka  
 ES Canal de ducha



**FALA**

No.	Body length / Długość rynny [mm]	Series / Seria	
71603	600	Wet & dry	6
71604	700	Wet & dry	6
71605	800	Wet & dry	6

EN Linear drain  
 PL Odpływ liniowy  
 DE Duschrinne  
 RU Душевой лоток  
 CZ Odtokový žlab  
 RO Rigola dus  
 HU Zuhanyfolyóka  
 ES Canal de ducha



**FALA**

No.	Body size / Rozmiar rynny [mm]	Series / Seria	
71620	150x150	Wet & dry	10

EN Pop-up waste  
 PL Korek do umywalki  
 DE Waschbecken Stöpsel  
 RU Автоматическая пробка  
 CZ Automatická zátka  
 RO Sifon chiuveta  
 HU Mosdo lefolyó elzaro  
 ES Tapón automat. para batería de lado



**FALA**

No.	
75498	12/48

EN Linear drain  
 PL Odpływ liniowy  
 DE Duschrinne  
 RU Душевой лоток  
 CZ Odtokový žlab  
 RO Rigola dus  
 HU Zuhanyfolyóka  
 ES Canal de ducha

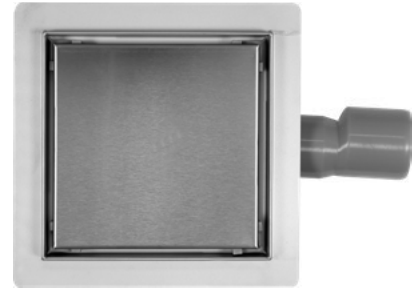

**FALA**

No.	Body size / Rozmiar rynny [mm]	Series / Seria	
75334	150x150	Quad	10
75335	200x200	Quad	10
75336	250x250	Quad	10

EN Aerator and sealing set for sanitary mixers  
 PL Perlator i zestaw uszczelki do baterii  
 DE Strahlregler- und Dichtungsgummissatz für Armatur  
 RU Аэратор с набором прокладок для смесителя  
 CZ Perlator a sada těsnění do baterie  
 RO Sita și garnituri pt. baterii sanitare  
 HU Levegőtető és tömítőgumi készlet csaptelephez  
 ES Aireado y juego de juntas

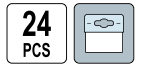

**FALA**

No.	
75327	25/200

EN Pop-up waste  
 PL Korek do umywalki  
 DE Waschbecken Stöpsel  
 RU Автоматическая пробка  
 CZ Automatická zátka  
 RO Sifon chiuveta  
 HU Mosdo lefolyó elzaro  
 ES Tapón automat. para batería de lado



**FALA**

No.	
75499	12/48

EN Pop-up waste  
 PL Korek automatyczny  
 DE Waschbecken Stöpsel  
 RU Автоматическая пробка для умывальника  
 CZ Automatická zátka  
 RO Sifon chiuveta  
 HU Mosdo lefolyo elzaro  
 ES Tapón automat. para bateria de lado

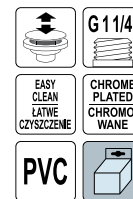

**FALA**

No.

75483



48/96

EN Pop-up waste  
 PL Korek automatyczny  
 DE Waschbecken Stöpsel  
 RU Автоматическая пробка для умывальника  
 CZ Automatická zátka  
 RO Sifon chiuveta  
 HU Mosdo lefolyo elzaro  
 ES Tapón automat. para bateria de lado



**FALA**

No.

75484



20/40

EN Shower handle  
 PL Słuchawka prysznicowa  
 DE Handbrause  
 RU Разбрызгиватель для душа  
 CZ Ruční sprcha  
 RO Cap duș  
 HU Kézi zuhanyfej  
 ES Ducha



**FALA**

No.

75544



15/60

EN Shower handle  
 PL Słuchawka prysznicowa  
 DE Handbrause  
 RU Разбрызгиватель для душа  
 CZ Ruční sprcha  
 RO Cap duș  
 HU Kézi zuhanyfej  
 ES Ducha



**FALA**

No.

75551



30/60

EN Pop-up waste  
 PL Korek automatyczny  
 DE Waschbecken Stöpsel  
 RU Автоматическая пробка для умывальника  
 CZ Automatická zátka  
 RO Sifon chiuveta  
 HU Mosdo lefolyo elzaro  
 ES Tapón automat. para bateria de lado

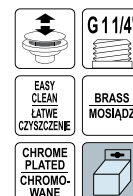

**FALA**

No.

75487



20/40

EN Shower handle  
 PL Słuchawka prysznicowa  
 DE Handbrause  
 RU Разбрызгиватель для душа  
 CZ Ruční sprcha  
 RO Cap duș  
 HU Kézi zuhanyfej  
 ES Ducha



**FALA**

No.

75545



15/60

EN Shower handle  
 PL Słuchawka prysznicowa  
 DE Handbrause  
 RU Разбрызгиватель для душа  
 CZ Ruční sprcha  
 RO Cap duș  
 HU Kézi zuhanyfej  
 ES Ducha

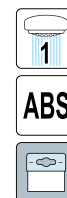

**FALA**

No.

75550



30/60



EN Shower handle  
 PL Słuchawka prysznicowa  
 DE Handbrause  
 RU Разбрызгиватель для душа  
 CZ Ruční sprcha  
 RO Cap duș  
 HU Kézi zuhanyfej  
 ES Ducha



**FALA**

No.	Series / Seria	
75627	Delta	24/48

EN Shower handle  
 PL Słuchawka prysznicowa  
 DE Handbrause  
 RU Разбрызгиватель для душа  
 CZ Ruční sprcha  
 RO Cap duș  
 HU Kézi zuhanyfej  
 ES Ducha



**FALA**

No.	Series / Seria	
75626	Kile	25/50

EN Shower handle  
 PL Słuchawka prysznicowa  
 DE Handbrause  
 RU Разбрызгиватель для душа  
 CZ Ruční sprcha  
 RO Cap duș  
 HU Kézi zuhanyfej  
 ES Ducha



**FALA**

No.	Series / Seria	
75628	Deimos	12

EN Shower handle  
 PL Słuchawka prysznicowa  
 DE Handbrause  
 RU Разбрызгиватель для душа  
 CZ Ruční sprcha  
 RO Cap duș  
 HU Kézi zuhanyfej  
 ES Ducha



**FALA**

No.	Series / Seria	
75633	Japet	12

EN Shower handle  
 PL Słuchawka prysznicowa  
 DE Handbrause  
 RU Разбрызгиватель для душа  
 CZ Ruční sprcha  
 RO Cap duș  
 HU Kézi zuhanyfej  
 ES Ducha



**FALA**

No.	Series / Seria	
75631	Hermana	25/50

EN Shower handle  
 PL Słuchawka prysznicowa  
 DE Handbrause  
 RU Разбрызгиватель для душа  
 CZ Ruční sprcha  
 RO Cap duș  
 HU Kézi zuhanyfej  
 ES Ducha



**FALA**

No.	Series / Seria	
75625	Delfos	25/50

EN Shower handle  
 PL Słuchawka prysznicowa  
 DE Handbrause  
 RU Разбрызгиватель для душа  
 CZ Ruční sprcha  
 RO Cap duș  
 HU Kézi zuhanyfej  
 ES Ducha



**FALA**

No.	Series / Seria	
75632	Fobos	12

EN Shower handle  
 PL Słuchawka prysznicowa  
 DE Handbrause  
 RU Разбрызгиватель для душа  
 CZ Ruční sprcha  
 RO Cap duș  
 HU Kézi zuhanyfej  
 ES Ducha



**FALA**

No.	Series / Seria	
75634	Dione	12

EN Shower handle  
 PL Słuchawka prysznicowa  
 DE Handbrause  
 RU Разбрызгиватель для душа  
 CZ Ruční sprcha  
 RO Cap duș  
 HU Kézi zuhanyfej  
 ES Ducha

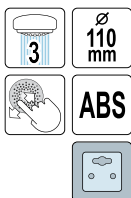

**FALA**

No.	Series / Seria	Box
75635	Mimas	12

EN Shower handle  
 PL Słuchawka prysznicowa  
 DE Handbrause  
 RU Разбрызгиватель для душа  
 CZ Ruční sprcha  
 RO Cap duș  
 HU Kézi zuhanyfej  
 ES Ducha

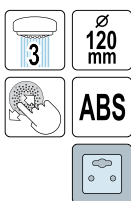

**FALA**

No.	Series / Seria	Box
75639	White Moon	12

EN Shower handle  
 PL Słuchawka prysznicowa  
 DE Handbrause  
 RU Разбрызгиватель для душа  
 CZ Ruční sprcha  
 RO Cap duș  
 HU Kézi zuhanyfej  
 ES Ducha



**FALA**

No.	Series / Seria	Box
75619	Salto	25/50

EN Shower handle  
 PL Słuchawka prysznicowa  
 DE Handbrause  
 RU Разбрызгиватель для душа  
 CZ Ruční sprcha  
 RO Cap duș  
 HU Kézi zuhanyfej  
 ES Ducha



**FALA**

No.	Series / Seria	Box
75621	Salto	25/50

EN Shower handle  
 PL Słuchawka prysznicowa  
 DE Handbrause  
 RU Разбрызгиватель для душа  
 CZ Ruční sprcha  
 RO Cap duș  
 HU Kézi zuhanyfej  
 ES Ducha



**FALA**

No.	Series / Seria	Box
75636	Silver Moon	12

EN Shower handle  
 PL Słuchawka prysznicowa  
 DE Handbrause  
 RU Разбрызгиватель для душа  
 CZ Ruční sprcha  
 RO Cap duș  
 HU Kézi zuhanyfej  
 ES Ducha



**FALA**

No.	Series / Seria	Box
75624	Salto	25/50

EN Shower handle  
 PL Słuchawka prysznicowa  
 DE Handbrause  
 RU Разбрызгиватель для душа  
 CZ Ruční sprcha  
 RO Cap duș  
 HU Kézi zuhanyfej  
 ES Ducha



**FALA**

No.	Series / Seria	Box
75620	Salto	25/50

EN Shower handle  
 PL Słuchawka prysznicowa  
 DE Handbrause  
 RU Разбрызгиватель для душа  
 CZ Ruční sprcha  
 RO Cap duș  
 HU Kézi zuhanyfej  
 ES Ducha



**FALA**

No.	Series / Seria	Box
75622	Salto	25/50

EN Shower handle  
 PL Sluchawka prysznicowa  
 DE Handbrause  
 RU Разбрызгиватель для душа  
 CZ Ruční sprcha  
 RO Cap duș  
 HU Kézi zuhanyfej  
 ES Ducha



**FALA**

No.	Series / Seria	
75623	Salto	25/50

EN Shower holder  
 PL Uchwyt do słuchawki prysznicowej  
 DE Brauseporter  
 RU Держатель душ  
 CZ Držák s kloubem na sprchu  
 RO Suport pt. dus  
 HU Zuhanycső tartó  
 ES Grifo para ducha



**FALA**

No.		
75535		100

EN Shower holder  
 PL Uchwyt do słuchawki prysznicowej  
 DE Brauseporter  
 RU Держатель душ  
 CZ Držák s kloubem na sprchu  
 RO Suport pt. dus  
 HU Zuhanycső tartó  
 ES Grifo para ducha

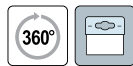

**FALA**

No.		
75537		100

EN Shower holder  
 PL Uchwyt do słuchawki prysznicowej  
 DE Brauseporter  
 RU Держатель душ  
 CZ Držák s kloubem na sprchu  
 RO Suport pt. dus  
 HU Zuhanycső tartó  
 ES Grifo para ducha

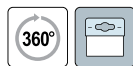

**FALA**

No.		
75564		50/200

EN Shower holder  
 PL Uchwyt do słuchawki prysznicowej  
 DE Brauseporter  
 RU Держатель душ  
 CZ Držák s kloubem na sprchu  
 RO Suport pt. dus  
 HU Zuhanycső tartó  
 ES Grifo para ducha



**FALA**

No.		
75527		100

EN Shower holder  
 PL Uchwyt do słuchawki prysznicowej  
 DE Brauseporter  
 RU Держатель душ  
 CZ Držák s kloubem na sprchu  
 RO Suport pt. dus  
 HU Zuhanycső tartó  
 ES Grifo para ducha



**FALA**

No.		
75536		100

EN Shower holder  
 PL Uchwyt do słuchawki prysznicowej  
 DE Brauseporter  
 RU Держатель душ  
 CZ Držák s kloubem na sprchu  
 RO Suport pt. dus  
 HU Zuhanycső tartó  
 ES Grifo para ducha

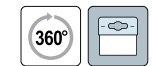

**FALA**

No.		
75539		100

EN Shower holder  
 PL Uchwyt do słuchawki prysznicowej  
 DE Brauseporter  
 RU Держатель душ  
 CZ Držák s kloubem na sprchu  
 RO Suport pt. dus  
 HU Zuhanycső tartó  
 ES Grifo para ducha



**FALA**

No.		
75565		30/180

EN Shower hose  
 PL Wąż prysznicowy  
 DE Brausenschlauch  
 RU Шланг для душа  
 CZ Sprchová hadice  
 RO Furtun duș  
 HU Zuhanycső  
 ES Manguera de ducha



**FALA**

No.	L [m]	
75553	1.5	30/60
75554	1.7	30/60

EN Shower hose  
 PL Wąż prysznicowy  
 DE Brausenschlauch  
 RU Шланг для душа  
 CZ Sprchová hadice  
 RO Furtun duș  
 HU Zuhanycső  
 ES Manguera de ducha



**FALA**

No.	L [m]	
75578	1.5	30/60
75579	1.7	30/60

EN Shower hose  
 PL Wąż prysznicowy  
 DE Brausenschlauch  
 RU Шланг для душа  
 CZ Sprchová hadice  
 RO Furtun duș  
 HU Zuhanycső  
 ES Manguera de ducha

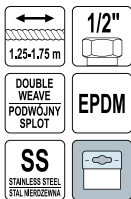

**FALA**

No.	L [m]	
75650	1.25-1.75	50

EN Shower hose  
 PL Wąż prysznicowy  
 DE Brausenschlauch  
 RU Шланг для душа  
 CZ Sprchová hadice  
 RO Furtun duș  
 HU Zuhanycső  
 ES Manguera de ducha



**FALA**

No.	L [m]	
75648	1.5	50
75649	2.0	50

EN Shower hose  
 PL Wąż prysznicowy  
 DE Brausenschlauch  
 RU Шланг для душа  
 CZ Sprchová hadice  
 RO Furtun duș  
 HU Zuhanycső  
 ES Manguera de ducha



**FALA**

No.	L [m]	
75645	1.50	50
75646	1.75	50
75647	2.00	50

EN Shower hose  
 PL Wąż prysznicowy  
 DE Brausenschlauch  
 RU Шланг для душа  
 CZ Sprchová hadice  
 RO Furtun duș  
 HU Zuhanycső  
 ES Manguera de ducha

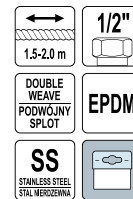

**FALA**

No.	L [m]	
75651	1.5-2.0	50



EN Shower hose  
 PL Wąż prysznicowy  
 DE Brausenschlauch  
 RU Шланг для душа  
 CZ Sprchová hadice  
 RO Furtun duș  
 HU Zuhanycső  
 ES Manguera de ducha

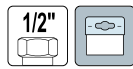

**FALA**

No.	L [m]	☐
75652	1.5	50
75653	2.0	50

EN Flexible connecting hose  
 PL Wąż przyłączeniowy elastyczny  
 DE Edelstahl Flexschlauch  
 RU Гибкий шланг для смесителя  
 CZ Flexibilní nerezové hadice na vodu  
 RO Racorduri flexibile pt. apa  
 HU Rugalmas rozsdamentes acél cső a víz  
 ES Manguera flexible de acero inoxidable para el agua

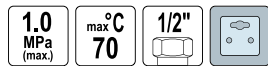

**FALA**

No.	L [mm]	☐
71800	300	180
71801	400	150
71802	500	120
71803	600	120
71804	800	100
71805	1000	80

EN Flexible connecting hose  
 PL Wąż przyłączeniowy elastyczny  
 DE Edelstahl Flexschlauch  
 RU Гибкий шланг для смесителя  
 CZ Flexibilní nerezové hadice na vodu  
 RO Racorduri flexibile pt. apa  
 HU Rugalmas rozsdamentes acél cső a víz  
 ES Manguera flexible de acero inoxidable para el agua

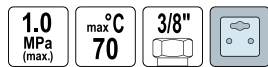

**FALA**

No.	L [mm]	☐
71814	300	180
71815	400	150
71816	500	120
71817	600	120
71818	800	100
71819	1000	80

EN Shower hose  
 PL Wąż prysznicowy  
 DE Brausenschlauch  
 RU Шланг для душа  
 CZ Sprchová hadice  
 RO Furtun duș  
 HU Zuhanycső  
 ES Manguera de ducha

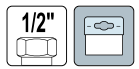

**FALA**

No.	L [m]	☐
75654	1.5	50
75655	2.0	50

EN Flexible connecting hose  
 PL Wąż przyłączeniowy elastyczny  
 DE Edelstahl Flexschlauch  
 RU Гибкий шланг для смесителя  
 CZ Flexibilní nerezové hadice na vodu  
 RO Racorduri flexibile pt. apa  
 HU Rugalmas rozsdamentes acél cső a víz  
 ES Manguera flexible de acero inoxidable para el agua

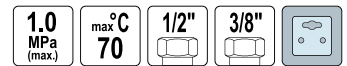

**FALA**

No.	L [mm]	☐
71807	300	180
71808	400	150
71809	500	120
71810	600	120
71811	800	100
71812	1000	80

EN Flexible connecting hose  
 PL Wąż przyłączeniowy elastyczny  
 DE Edelstahl Flexschlauch  
 RU Гибкий шланг для смесителя  
 CZ Flexibilní nerezové hadice na vodu  
 RO Racorduri flexibile pt. apa  
 HU Rugalmas rozsdamentes acél cső a víz  
 ES Manguera flexible de acero inoxidable para el agua



**FALA**

No.	L [mm]	☐
71820	300	180
71821	400	150
71822	500	120
71823	600	120
71824	800	10/100
71825	1000	80

EN Flexible connecting hose  
 PL Wąż przyłączeniowy elastyczny  
 DE Edelstahl Flexschlauch  
 RU Гибкий шланг для смесителя  
 CZ Flexibilní nerezové hadice na vodu  
 RO Racorduri flexibile pt. apa  
 HU Rugalmas rozsdamentes acél cső a víz  
 ES Manguera flexible de acero inoxidable para el agua



**FALA**

No.	L [mm]	
71827	300	180
71828	400	150
71829	500	120
71830	600	120
71831	800	100
71832	1000	10/80

EN Flexible connecting hose  
 PL Wąż przyłączeniowy elastyczny  
 DE Edelstahl Flexschlauch  
 RU Гибкий шланг для смесителя  
 CZ Flexibilní nerezové hadice na vodu  
 RO Racorduri flexibile pt. apa  
 HU Rugalmas rozsdamentes acél cső a víz  
 ES Manguera flexible de acero inoxidable para el agua



**FALA**

No.	L [mm]	
71840	300	200
71841	400	180
71842	500	150
71843	600	120
71844	800	100

EN Flexible connecting hose  
 PL Wąż przyłączeniowy elastyczny  
 DE Edelstahl Flexschlauch  
 RU Гибкий шланг для смесителя  
 CZ Flexibilní nerezové hadice na vodu  
 RO Racorduri flexibile pt. apa  
 HU Rugalmas rozsdamentes acél cső a víz  
 ES Manguera flexible de acero inoxidable para el agua



**FALA**

No.	L [mm]	
71851	300	200
71852	400	180
71853	500	150
71854	600	120
71855	800	100

EN Flexible connecting hose  
 PL Wąż przyłączeniowy elastyczny  
 DE Edelstahl Flexschlauch  
 RU Гибкий шланг для смесителя  
 CZ Flexibilní nerezové hadice na vodu  
 RO Racorduri flexibile pt. apa  
 HU Rugalmas rozsdamentes acél cső a víz  
 ES Manguera flexible de acero inoxidable para el agua



**FALA**

No.	L [mm]	
71833	300	180
71834	400	150
71835	500	120
71836	600	120
71838	1000	80

EN Flexible connecting hose  
 PL Wąż przyłączeniowy elastyczny  
 DE Edelstahl Flexschlauch  
 RU Гибкий шланг для смесителя  
 CZ Flexibilní nerezové hadice na vodu  
 RO Racorduri flexibile pt. apa  
 HU Rugalmas rozsdamentes acél cső a víz  
 ES Manguera flexible de acero inoxidable para el agua

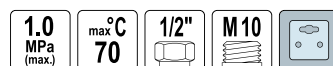

**FALA**

No.	L [mm]	
71846	300	200
71847	400	180
71848	500	150
71849	600	120
71850	800	100

EN Flexible connecting hose  
 PL Wąż przyłączeniowy elastyczny  
 DE Edelstahl Flexschlauch  
 RU Гибкий шланг для смесителя  
 CZ Flexibilní nerezové hadice na vodu  
 RO Racorduri flexibile pt. apa  
 HU Rugalmas rozsdamentes acél cső a víz  
 ES Manguera flexible de acero inoxidable para el agua

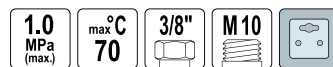

**FALA**

No.	L [mm]	
71856	300	200
71857	400	180
71858	500	150
71859	600	120
71860	800	10/100

EN Bathroom set  
 PL Zestaw łazienkowy  
 DE Brausegarnitur  
 RU Набор для душевой  
 CZ Sprchová souprava  
 RO Set pt. dus  
 HU Zuhanyzó készlet  
 ES Juego de baño ducha

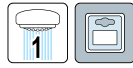

**FALA**

No.	
75555	12

EN Bathroom set  
 PL Zestaw łazienkowy  
 DE Brausegarnitur  
 RU Набор для душевой  
 CZ Sprchová souprava  
 RO Set pt. dus  
 HU Zuhanyzó készlet  
 ES Juego de baño ducha

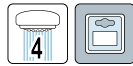

**FALA**

No.	
75558	12

EN Shower panel  
 PL Panel prysznicowy  
 DE Hydromassageduschpaneel  
 RU Гидромассажная панель  
 CZ Hydromasážní panel  
 RO Panou de hidromasaj  
 HU Hidromassázs panel  
 ES Columna de hidromasaje



**FALA**

No.	Series / Seria	
75980	Steely 1	1

EN Bathroom set  
 PL Zestaw łazienkowy  
 DE Brausegarnitur  
 RU Набор для душевой  
 CZ Sprchová souprava  
 RO Set pt. dus  
 HU Zuhanyzó készlet  
 ES Juego de baño ducha



**FALA**

No.	
75559	16

EN Shower panel  
 PL Panel prysznicowy  
 DE Hydromassageduschpaneel  
 RU Гидромассажная панель  
 CZ Hydromasážní panel  
 RO Panou de hidromasaj  
 HU Hidromassázs panel  
 ES Columna de hidromasaje



**FALA**

No.	Series / Seria	
75981	Steely 2	1

- EN Shower panel
- PL Panel prysznicowy
- DE Hydromassageduschpaneel
- RU Гидромассажная панель
- CZ Hydromasážní panel
- RO Panou de hidromasaj
- HU Hidromassázs panel
- ES Columna de hidromasaje



- EN Shower panel
- PL Panel prysznicowy
- DE Hydromassageduschpaneel
- RU Гидромассажная панель
- CZ Hydromasážní panel
- RO Panou de hidromasaj
- HU Hidromassázs panel
- ES Columna de hidromasaje



**FALA**

No.	Series / Seria	1
75979	Steely 6	1

**FALA**

No.	Series / Seria	1
75983	Steely 4	1

- EN Shower panel
- PL Panel prysznicowy
- DE Hydromassageduschpaneel
- RU Гидромассажная панель
- CZ Hydromasážní panel
- RO Panou de hidromasaj
- HU Hidromassázs panel
- ES Columna de hidromasaje



- EN Robe hook
- PL Haczyk pojedynczy
- DE Einzelhaken
- RU Крючок одинарный
- CZ Háček
- RO Agatatoare simpla
- HU Fali akasztó
- ES Perchero de pared



**FALA**

No.	Series / Seria	6/24
69311	Quad Chrom	6/24

- EN Soap dish
- PL Mydelniczka
- DE Seifenschale
- RU Мыльница
- CZ Mydelnička
- RO Sapuniera
- HU Szappantartó tál
- ES Jabonera



**FALA**

No.	Series / Seria	1
75984	Steely 5	1

**FALA**

No.	Series / Seria	4/24
69313	Quad Chrom	4/24



EN Toilet paper holder  
 PL Uchwyt na papier toaletowy  
 DE WC Papierhalter  
 RU Держатель для туалетной бумаги без крышек  
 CZ Držák na toaletní papír  
 RO Porthartie  
 HU WC papír tartó  
 ES Portarrollos para papel higiénico



**FALA**

No.	Series / Seria	Icon
69314	Quad Chrom	4/24

EN Toilet paper holder  
 PL Uchwyt na zapasowy papier  
 DE Reserverpapierhalter  
 RU Держатель для запасного рулона туалетной бумаги  
 CZ Držák na toaletní papír  
 RO Porthartie igienica  
 HU WC papír tartó  
 ES Portarrollos para papel higiénico



**FALA**

No.	Series / Seria	Icon
69316	Quad Chrom	5/30

EN Toilet brush holder  
 PL Szczotka WC  
 DE WC-Garnitur  
 RU Туалетная щетка настенная  
 CZ WC štětka  
 RO Suport perie WC  
 HU WC kefe  
 ES Escobillero mura



**FALA**

No.	Series / Seria	Icon
69320	Quad Chrom	4/8

EN Soap dish  
 PL Mydelniczka  
 DE Seifenschale  
 RU Мыльница  
 CZ Mýdelnička  
 RO Sapuniera  
 HU Szappantartó tál  
 ES Jabonera



**FALA**

No.	Series / Seria	Icon
69339	Cuboid White	6/144

EN Toilet paper holder  
 PL Uchwyt na papier toaletowy  
 DE WC Papierhalter  
 RU Держатель для туалетной бумаги без крышек  
 CZ Držák na toaletní papír  
 RO Porthartie  
 HU WC papír tartó  
 ES Portarrollos para papel higiénico



**FALA**

No.	Series / Seria	Icon
69315	Quad Chrom	4/24

EN Towel ring  
 PL Uchwyt na ręcznik  
 DE Handtuchring  
 RU Кольцо для полотенца  
 CZ Držák ručníků  
 RO Portprosop  
 HU Törölközőtartó  
 ES Toallero anillo



**FALA**

No.	Series / Seria	Icon
69319	Quad Chrom	4/24

EN Glass shelf  
 PL Półka szklana  
 DE Ablagekonsole aus Glas  
 RU Этажерка настенная  
 CZ Polička do koupelny  
 RO Polita sticla  
 HU Piperepolc - üveg  
 ES Estante



**FALA**

No.	Series / Seria	Icon
69321	Quad Chrom	4/8

EN Lotion dispenser  
 PL Dozownik mydła w płynie  
 DE Seifenspender  
 RU Дозатор для жидкого мыла  
 CZ Dávkovač mydla  
 RO Dozator sapun  
 HU Folyékony szappan adagoló  
 ES Dosificador



**FALA**

No.	Series / Seria	Icon
69340	Cuboid White	6/72

EN Toilet brush holder  
 PL Szczotka WC  
 DE WC-Bürste  
 RU Щетка туалетная  
 CZ WC kartáč  
 RO Perie WC  
 HU WC kefe tartó  
 ES Escobillero



**FALA**

No.	Series / Seria	
69341	Cuboid White	6/48

EN Toothbrush holder  
 PL Kubek na szczoteczki do zębów  
 DE Zahnpfutzbecher  
 RU Стакан для зубных щеток  
 CZ Dóza na zubní kartáčky  
 RO Suport pt. periute dinti  
 HU Fogkefetartó pohár  
 ES Portacepillos



**FALA**

No.	Series / Seria	
69351	Nickel	6/96

EN Lotion dispenser  
 PL Dozownik mydła w płynie  
 DE Seifenspender  
 RU Дозатор для жидкого мыла  
 CZ Dávkovač mýdla  
 RO Dozator sapun  
 HU Folyékony szappan adagoló  
 ES Dosificador



**FALA**

No.	Series / Seria	
69353	Nickel	6/72

EN Robe hook  
 PL Haczyk pojedynczy  
 DE Einzelhaken  
 RU Крючок одинарный  
 CZ Háček  
 RO Agatatoare simpla  
 HU Fali akasztó  
 ES Perchero de pared



**FALA**

No.	Series / Seria	
69370	Steely	165



EN Tumbler  
 PL Kubek kosmetyczny  
 DE Becher  
 RU Стакан  
 CZ Dóza  
 RO Suport periută  
 HU Fűrdőszobai pohár  
 ES Vaso



**FALA**

No.	Series / Seria	
69350	Nickel	6/96

EN Soap dish  
 PL Mydelniczka  
 DE Seifenschale  
 RU Мыльница  
 CZ Mydelnička  
 RO Sapuniera  
 HU Szappantartó tál  
 ES Jabonera



**FALA**

No.	Series / Seria	
69352	Nickel	6/192

EN Toilet brush holder  
 PL Szczotka WC  
 DE WC-Bürste  
 RU Щетка туалетная  
 CZ WC kartáč  
 RO Perie WC  
 HU WC kefe tartó  
 ES Escobillero



**FALA**

No.	Series / Seria	
69354	Nickel	6/24

EN Robe hook  
 PL Haczyk pojedynczy  
 DE Einzelhaken  
 RU Крючок одинарный  
 CZ Háček  
 RO Agatatoare simpla  
 HU Fali akasztó  
 ES Perchero de pared



**FALA**

No.	Series / Seria	
69371	Steely	165



EN Robe hook  
 PL Haczyk podwójny  
 DE Einzelhaken  
 RU Крючок одинарный  
 CZ Háček  
 RO Agatoare simpla  
 HU Fali akasztó  
 ES Perchero de pared

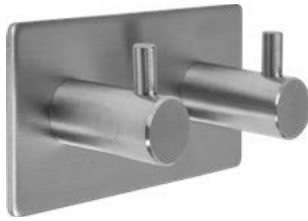

**FALA**

No.	Series / Seria	Quantity
69372	Steely	110

EN Towel ring  
 PL Uchwyt na ręcznik  
 DE Handtuchring  
 RU Кольцо для полотенца  
 CZ Držák ručníků  
 RO Portprosop  
 HU Törölközőtartó  
 ES Toallero anillo



**FALA**

No.	Series / Seria	Quantity
69374	Steely	25

EN Shelf  
 PL Półka  
 DE Ablagekonsole  
 RU Этажерка настенная  
 CZ Półka do koupelny  
 RO Polita  
 HU Piperepolc  
 ES Estante

**FALA**

No.	Series / Seria	Quantity
69378	Steely	30

EN Toilet seat  
 PL Deska sedesowa  
 DE WC Deckel  
 RU Сиденье для унитаза  
 CZ WC sedátko  
 RO Capac WC  
 HU WC-ülőke  
 ES Asiento de inodoro

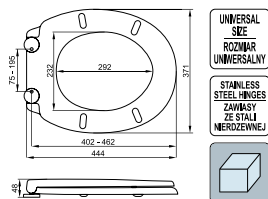

**FALA**

No.	Quantity
75465	5

EN Robe hook  
 PL Haczyk podwójny  
 DE Einzelhaken  
 RU Крючок одинарный  
 CZ Háček  
 RO Agatoare simpla  
 HU Fali akasztó  
 ES Perchero de pared



**FALA**

No.	Series / Seria	Quantity
69373	Steely	220

EN Toilet paper holder  
 PL Uchwyt na papier toaletowy  
 DE WC Papierhalter  
 RU Держатель для туалетной бумаги без крышки  
 CZ Držák na toaletní papír  
 RO Porthartie  
 HU WC papír tartó  
 ES Portarrollos para papel higiénico



**FALA**

No.	Series / Seria	Quantity
69375	Steely	50



EN Toilet seat  
 PL Deska sedesowa  
 DE WC Deckel  
 RU Сиденье для унитаза  
 CZ WC sedátko  
 RO Capac WC  
 HU WC-ülőke  
 ES Asiento de inodoro

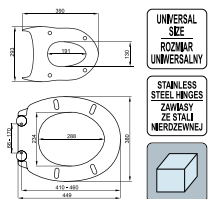

**FALA**

No.	Quantity
75467	5

EN Toilet seat  
 PL Deska sedesowa  
 DE WC Deckel  
 RU Сиденье для унитаза  
 CZ WC sedátko  
 RO Capac WC  
 HU WC-ülőke  
 ES Asiento de inodoro

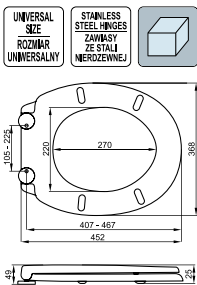

FALA

No. 75469 5

EN Toilet seat  
 PL Deska sedesowa  
 DE WC Deckel  
 RU Сиденье для унитаза  
 CZ WC sedátko  
 RO Capac WC  
 HU WC-ülőke  
 ES Asiento de inodoro

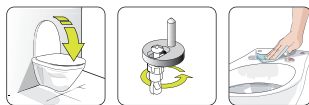

FALA

No. 75470 6

EN Toilet seat  
 PL Deska sedesowa  
 DE WC Deckel  
 RU Сиденье для унитаза  
 CZ WC sedátko  
 RO Capac WC  
 HU WC-ülőke  
 ES Asiento de inodoro

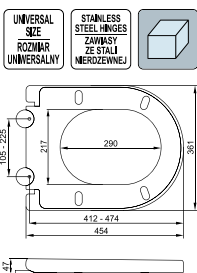

FALA

No. 75472 5

EN Toilet seat  
 PL Deska sedesowa  
 DE WC Deckel  
 RU Сиденье для унитаза  
 CZ WC sedátko  
 RO Capac WC  
 HU WC-ülőke  
 ES Asiento de inodoro

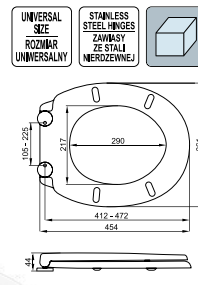

FALA

No. 75464 5

EN Toilet seat  
 PL Deska sedesowa  
 DE WC Deckel  
 RU Сиденье для унитаза  
 CZ WC sedátko  
 RO Capac WC  
 HU WC-ülőke  
 ES Asiento de inodoro



FALA

No. 75471 5

EN LED toilet light  
 PL Lampka LED do podświetlania WC  
 DE WC LED Lampe  
 RU LED ночник для туалета  
 CZ WC LED světlo  
 RO Lumină pt. toaletă  
 HU LED WC megvilágítás  
 ES WC LED lámpara



FALA

No. 75455 100



EN Plastic stool  
 PL Stolek plastikowy  
 DE Kunststoff Hocker  
 RU Пластиковый табурет  
 CZ Plastová stolička  
 RO Scaun de plastic  
 HU Műanyag széklét  
 ES Taburete de plástico



**FALA**

No.	Dimensions / Wymiary [mm]	
75915	300x200x210	10/20

EN Waste pump for shower and basin  
 PL Pompa łazienkowa do pryszniczki i umywalki  
 DE Haushaltspumpe für Dusche und Waschtisch  
 RU Санитарный насос  
 CZ Koupeľňové čerpadlo pro sprchy  
 RO Pompa pt. ape uzate - dus, lovoar  
 HU Szivattyú zuhanyzóhoz  
 ES Bomba de evacuación



**FALA**

No.	Power / Moc [W]	
75944	250	4

EN Sewage lifting station with grinder  
 PL Pompa sanitarna z rozdrabniaczem  
 DE Kleinhebeanlage fäkalienthaltiges Abwasser  
 RU Канализационная насосная установка  
 CZ Sanitární kalové čerpadlo  
 RO Stația pt. evacuarea apelor uzate  
 HU Átemelő szivattyú  
 ES Estación de levantamiento para aguas residuales



**FALA**

No.	Power / Moc [W]	
75951	600	1

EN Plastic stool  
 PL Stolek plastikowy  
 DE Kunststoff Hocker  
 RU Пластиковый табурет  
 CZ Plastová stolička  
 RO Scaun de plastic  
 HU Műanyag széklét  
 ES Taburete de plástico



**FALA**

No.	Dimensions / Wymiary [mm]	
75916	300x200x210	10/20

EN Waste pump for shower and basin  
 PL Pompa łazienkowa do pryszniczki i umywalki  
 DE Haushaltspumpe für Dusche und Waschtisch  
 RU Санитарный насос  
 CZ Koupeľňové čerpadlo pro sprchy  
 RO Pompa pt. ape uzate - dus, lovoar  
 HU Szivattyú zuhanyzóhoz  
 ES Bomba de evacuación



**FALA**

No.	Power / Moc [W]	
75945	250	1

EN Sewage lifting station with grinder  
 PL Pompa sanitarna z rozdrabniaczem  
 DE Kleinhebeanlage fäkalienthaltiges Abwasser  
 RU Канализационная насосная установка  
 CZ Sanitární kalové čerpadlo  
 RO Stația pt. evacuarea apelor uzate  
 HU Átemelő szivattyú  
 ES Estación de levantamiento para aguas residuales



**FALA**

No.	Power / Moc [W]	
75953	600	1

Convenient and easy to use.  
Wygodna i łatwa obsługa.

**Rotation 360°**

Mixing water flow with intake air reduces consumption by half, without splashing.  
Zmieszany strumień wody z zasasywanym powietrzem oszczędza zużycie o połowę i nie chlapie.

**ECOflow**

Additional protection against contamination.  
Dodatkowa ochrona przed zanieczyszczeniami.

**built-in-filter**

Simple and effective installation thanks to the nut.  
Łatwy i trwały montaż dzięki nakrętce.

**SMARTnut**

EN Instant heating faucet  
PL Przepływowy podgrzewacz wody z baterią  
DE Elektrische Warmwasser-Armatur  
RU Миттвеий водонагрівач  
CZ Ohřivač vody  
RO Robinet electric  
HU Átfolyós vízmelegítő csaptelep  
ES Calefacción instantáneo grifo

220-240V~50-60Hz 3000 W 1/2" 0.04-0.6 MPa 200 mm  
1.2 m



**FALA**



No.	Series / Seria	
75930	Strokkur 1	10

EN Instant heating faucet  
PL Przepływowy podgrzewacz wody z baterią  
DE Elektrische Warmwasser-Armatur  
RU Миттвеий водонагрівач  
CZ Ohřivač vody  
RO Robinet electric  
HU Átfolyós vízmelegítő csaptelep  
ES Calefacción instantáneo grifo

220-240V~50-60Hz 3000 W 1/2" 0.04-0.6 MPa 100 mm  
1.2 m



**FALA**



No.	Series / Seria	
75931	Strokkur 2	10

EN Instant heating faucet  
PL Przepływowy podgrzewacz wody z baterią  
DE Elektrische Warmwasser-Armatur  
RU Миттвеий водонагрівач  
CZ Ohřivač vody  
RO Robinet electric  
HU Átfolyós vízmelegítő csaptelep  
ES Calefacción instantáneo grifo

220-240V~50-60Hz 3000 W 1/2" 0.04-0.6 MPa 200 mm 1.2 m



**FALA**



No.	Series / Seria	
75932	Strokkur 3	10

EN Instant heating faucet  
PL Przepływowy podgrzewacz wody z baterią  
DE Elektrische Warmwasser-Armatur  
RU Миттвеий водонагрівач  
CZ Ohřivač vody  
RO Robinet electric  
HU Átfolyós vízmelegítő csaptelep  
ES Calefacción instantáneo grifo

230V~50Hz 3000 W 1/2" 0.1-0.6 MPa  
LCD 1.2 m



**FALA**



No.	Series / Seria	
75921	Katla 1	10

EN Instant heating faucet  
PL Przepływowy podgrzewacz wody z baterią  
DE Elektrische Warmwasser-Armatur  
RU Миттвеий водонагрівач  
CZ Ohřivač vody  
RO Robinet electric  
HU Átfolyós vízmelegítő csaptelep  
ES Calefacción instantáneo grifo

230V~50Hz 3000 W 1/2" 0.1-0.6 MPa  
LCD 1.2 m



**FALA**



No.	Series / Seria	
75922	Katla 2	10

EN Instant heating faucet  
 PL Przepływowy podgrzewacz wody z baterią  
 DE Elektrische Warmwasser-Armatur  
 RU Миттевий водонагривач  
 CZ Ohříváč vody  
 RO Robinet electric  
 HU Átfolyós vízmelegítő csaptelep  
 ES Calefacción instantáneo grifo

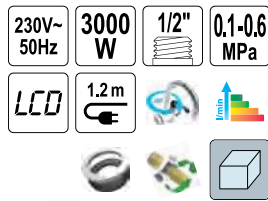

**FALA**

No.	Series / Seria	
75923	Katla 3	10

EN Instant heating faucet  
 PL Przepływowy podgrzewacz wody z baterią  
 DE Elektrische Warmwasser-Armatur  
 RU Миттевий водонагривач  
 CZ Ohříváč vody  
 RO Robinet electric  
 HU Átfolyós vízmelegítő csaptelep  
 ES Calefacción instantáneo grifo



**FALA**

No.	Series / Seria	
75924	Katla 4	10

Memo

No.	Page	No.	Page	No.	Page	No.	Page	No.	Page	No.	Page	No.	Page	No.	Page
00250	150	04681	154	05850	165	06307	166	06781	162	07880	115	08522	105	08821	90
00300	146	04682	154	05901	168	06308	166	06795	169	07881	115	08534	116	08822	90
00320	146	04683	154	05902	168	06309	166	06796	169	07882	115	08536	116	08825	90
00510	146	04684	154	05903	168	06310	168	06797	169	07883	115	08538	116	08827	90
00610	146	04690	150	05904	168	06320	168	06799	169	07884	115	08540	116	08828	90
01060	146	04691	150	05905	168	06330	168	06820	108	07885	115	08542	116	08829	90
02300	146	04692	151	05906	168	06331	168	06840	109	07886	115	08545	116	08831	90
02400	146	04693	151	05911	168	06335	170	06860	109	07910	115	08553	116	08832	90
03150	146	04699	150	05912	168	06338	179	06930	101	07911	115	08554	116	08833	90
03160	146	04700	154	05913	168	06340	163	06940	101	07912	115	08556	116	08834	90
03220	146	04710	154	05914	168	06341	163	06950	101	07913	115	08558	116	08835	90
03221	147	04714	151	05915	168	06350	163	06960	101	07914	115	08560	116	08837	90
03225	147	04715	151	05916	168	06351	163	06963	101	07915	115	08562	116	08838	90
03240	83	04716	151	05921	168	06360	163	06964	101	07916	115	08565	116	08845	90
03241	83	04717	151	05922	168	06370	163	06965	102	07930	113	08573	116	08851	90
03245	84	04718	152	05923	168	06380	163	06970	102	07950	116	08574	116	08853	90
03246	84	04720	155	05924	168	06381	179	06971	102	07955	116	08576	116	08854	90
03300	85	04721	155	05925	168	06382	179	06972	102	07956	117	08578	116	08855	90
03301	85	04730	152	05926	168	06383	179	06973	102	07957	117	08580	116	08860	92
03900	148	04731	152	05950	166	06384	179	06974	102	07960	117	08582	116	08861	92
03940	148	04732	152	05960	167	06388	179	06975	102	07962	117	08585	116	08864	92
03960	148	04734	152	05971	167	06390	179	06976	102	07970	116	08630	90	08865	92
03963	148	04735	153	05972	167	06391	179	06977	102	07974	91	08631	90	08868	92
03990	84	04736	153	05973	167	06392	179	06978	102	07975	91	08633	90	08869	92
04000	147	04737	153	05980	168	06393	179	06979	102	07976	91	08635	90	08873	92
04020	147	04739	153	06001	167	06394	179	06980	102	07977	91	08639	90	08875	92
04022	147	04755	165	06002	167	06395	179	06981	102	07978	91	08640	90	08876	91
04050	148	04756	165	06003	167	06396	179	06982	102	07984	91	08641	90	08900	92
04060	149	04770	165	06004	167	06397	179	06983	102	07985	91	08642	90	09005	170
04100	149	05050	108	06005	167	06398	179	06985	102	07986	91	08644	90	09006	170
04200	147	05100	108	06006	167	06399	179	06986	102	07987	91	08646	90	09010	170
04210	147	05290	149	06010	167	06400	160	06987	103	07988	91	08663	91	09015	170
04300	132	05300	180	06011	167	06401	161	06988	103	08170	90	08665	91	09017	170
04301	132	05301	180	06012	167	06410	160	06989	103	08171	90	08669	91	09025	170
04320	134	05302	180	06013	167	06420	160	06990	103	08174	90	08671	91	09031	170
04360	168	05311	180	06014	167	06430	160	06992	103	08175	90	08672	91	09036	171
04405	148	05312	180	06015	167	06440	160	06993	103	08190	91	08674	91	09038	171
04410	147	05319	180	06030	165	06450	172	06994	103	08191	91	08683	91	09040	171
04440	148	05325	180	06040	165	06452	172	06995	103	08288	115	08711	89	09044	171
04450	136	05540	85	06050	165	06453	172	07060	114	08289	115	08712	89	09046	171
04451	136	05560	85	06060	165	06457	172	07080	114	08290	115	08714	89	09048	171
04452	136	05580	85	06080	165	06460	172	07100	114	08291	115	08715	89	09049	171
04490	149	05600	85	06100	165	06470	161	07120	114	08292	115	08731	89	09050	171
04500	149	05750	169	06109	163	06472	161	07180	114	08293	115	08732	89	09051	171
04510	149	05751	169	06110	163	06500	161	07240	114	08301	115	08734	89	09060	170
04540	149	05752	169	06120	163	06510	161	07320	114	08302	115	08735	89	09062	171
04542	149	05760	169	06121	163	06512	162	07400	114	08303	115	08751	89	09063	171
04544	150	05761	169	06130	165	06520	161	07506	114	08304	115	08752	89	09065	171
04546	150	05770	169	06140	166	06530	161	07508	114	08306	115	08754	89	09077	171
04591	155	05771	169	06150	166	06532	162	07510	114	08307	115	08755	89	09080	170
04592	155	05772	169	06290	166	06537	163	07512	114	08308	115	08780	89	09090	170
04593	155	05773	169	06294	166	06538	163	07530	115	08312	103	08781	89	09094	171
04594	155	05774	169	06295	166	06540	161	07540	115	08314	103	08782	89	09096	171
04600	154	05801	164	06296	166	06640	162	07560	115	08315	104	08783	89	09097	171
04610	154	05802	164	06297	166	06650	162	07580	115	08316	104	08785	89	09100	135
04620	154	05803	164	06298	166	06660	162	07610	115	08318	104	08786	89	09120	136
04630	154	05804	164	06299	166	06670	162	07620	115	08350	104	08788	89	09130	135
04640	154	05805	164	06300	166	06680	162	07630	115	08400	104	08790	89	09150	136
04650	154	05821	164	06301	166	06690	162	07664	115	08500	104	08791	89	09160	136
04660	154	05822	164	06302	166	06700	162	07665	115	08501	104	08792	89	09162	138
04668	154	05823	164	06303	166	06701	162	07666	115	08510	104	08793	89	09163	138
04670	154	05830	164	06304	166	06740	162	07667	115	08511	105	08811	90	09164	138
04677	153	05831	164	06305	166	06760	162	07668	115	08520	105	08819	90	09165	138
04680	153	05840	164	06306	166	06780	162	07879	115	08521	105	08820	90	09170	137



No.	Page	No.	Page	No.	Page	No.	Page	No.	Page	No.	Page	No.	Page	No.	Page
09171	137	09476	177	10064	188	16555	200	18375	194	21703	85	23312	80	23670	81
09172	137	09477	177	10065	188	16556	200	18377	195	21704	85	23313	80	23680	81
09173	137	09478	177	10101	188	16557	200	18380	193	21705	85	23315	80	23690	81
09174	137	09480	436	10104	188	17300	192	18382	193	21706	85	23316	80	23692	81
09175	137	09481	436	10106	188	17301	192	18390	193	21709	85	23317	80	23693	81
09177	137	09482	436	10109	188	17302	192	18470	195	21900	78	23318	80	23694	81
09180	181	09483	436	10111	188	17303	192	18473	194	21905	78	23325	80	23710	81
09190	181	09484	436	10122	188	17304	193	18501	194	21910	78	23326	80	23720	81
09200	181	09486	340	10123	188	17310	193	18502	194	21915	78	23327	80	23722	81
09204	181	09487	340	10125	188	17430	192	18503	194	21919	78	23331	80	23723	81
09207	181	09489	340	10128	188	17435	192	18504	194	21921	78	23371	82	23724	81
09302	173	09490	341	10129	188	17470	192	18530	195	21924	78	23372	82	23730	81
09303	173	09521	175	10130	188	17471	192	18790	195	21927	78	23373	82	23740	81
09307	173	09522	175	10133	188	17473	192	18797	194	21929	78	23374	82	23750	81
09308	173	09523	175	10135	188	17474	192	18798	194	21932	78	23375	82	23752	81
09310	174	09524	175	10138	188	17480	192	18799	194	21934	78	23376	82	23800	81
09311	174	09525	175	10139	188	17481	192	18800	195	21936	78	23377	82	23820	81
09331	174	09531	175	12100	188	17483	192	18810	195	21941	78	23379	82	23830	81
09332	174	09532	175	12200	188	17484	192	19750	196	21944	78	23380	82	23832	81
09334	173	09533	175	12300	188	17488	191	19755	196	21948	78	23381	82	23840	81
09336	173	09534	175	12500	188	17489	191	19763	196	21950	78	23390	82	23850	81
09338	174	09535	175	13200	188	17490	191	19765	196	21951	78	23391	82	23860	81
09345	173	09536	175	13300	188	17495	191	19766	196	21952	78	23392	82	23862	81
09346	173	09537	175	13500	188	17497	191	19767	196	21955	78	23393	82	23880	81
09359	173	09560	175	14100	189	17498	191	19770	196	21956	78	23394	82	23882	81
09363	174	09561	175	14200	189	17500	190	20100	77	21958	78	23395	82	23883	81
09365	174	09562	175	14300	189	17501	190	20150	77	21961	78	23396	82	23920	81
09370	173	09581	176	14500	189	17505	191	20200	77	21963	78	23397	82	23930	81
09371	173	09583	176	15004	189	17506	191	20250	77	21966	78	23398	82	23932	81
09372	173	09585	176	15005	189	17507	191	20280	77	21998	78	23399	82	23960	81
09373	173	09587	176	15006	189	17508	191	20300	77	21999	78	23400	82	23962	81
09375	174	09589	176	15007	189	17560	199	20320	77	22130	77	23402	82	23980	81
09377	174	09590	177	15010	189	17570	195	20350	77	22180	77	23403	82	23982	81
09378	174	09636	176	15020	189	17606	200	20400	77	22190	77	23411	82	23988	82
09385	174	09638	176	15050	189	17608	200	20420	77	22250	77	23412	82	23990	81
09390	175	09640	176	15070	189	17610	200	20450	77	22300	77	23413	82	23992	81
09395	175	09642	176	15100	190	17612	200	20500	77	22310	77	23414	82	23999	81
09397	172	09647	176	15110	190	17615	200	20550	77	22330	77	23415	82	24000	88
09398	172	09648	176	15113	190	17620	200	20600	77	22340	77	23416	82	24060	86
09400	179	09649	176	15115	190	17701	158	20650	77	22350	80	23417	82	24070	86
09406	174	09650	176	15120	189	17702	158	20700	77	22380	80	23418	82	24080	86
09408	174	09651	176	15130	189	17704	158	20800	77	22381	80	23419	82	24090	86
09413	174	09653	177	15200	189	17705	159	20850	77	22431	81	23420	82	24091	86
09421	175	09655	176	15220	190	17730	159	20900	77	22460	80	23421	82	24095	86
09422	175	09656	176	15240	190	17733	159	21000	77	22465	81	23422	82	24112	135
09425	175	09900	163	15291	200	18002	197	21100	77	22466	81	23423	82	24122	135
09427	175	09903	163	15292	200	18010	197	21200	77	22500	81	23424	82	24130	135
09429	175	09910	164	15301	201	18020	197	21250	77	22550	88	23460	83	24140	135
09430	175	09920	176	16000	200	18021	197	21300	77	22551	88	23590	82	24295	88
09445	172	09930	176	16001	200	18180	85	21400	77	22552	88	23591	82	24300	86
09446	172	09950	176	16002	200	18200	193	21600	77	22565	84	23592	83	24310	86
09457	177	10000	341	16012	200	18201	193	21650	78	22570	84	23593	83	24320	86
09459	177	10001	341	16030	148	18250	193	21680	79	22571	84	23594	83	24330	86
09462	177	10002	341	16280	199	18300	193	21682	79	22572	84	23601	82	24340	86
09463	177	10003	341	16300	199	18350	193	21684	79	22590	81	23602	82	24350	86
09465	340	10010	341	16301	199	18355	194	21686	79	22591	81	23603	82	24370	86
09466	340	10011	341	16340	200	18356	194	21688	79	22610	78	23604	82	24390	86
09467	340	10012	341	16360	200	18357	194	21690	79	22611	78	23605	83	24410	86
09470	177	10013	341	16380	200	18360	193	21691	79	22612	79	23606	83	24430	86
09471	177	10014	341	16400	200	18361	193	21692	79	22613	79	23608	83	24450	86
09472	177	10015	342	16551	200	18362	193	21695	79	22616	79	23620	81	24470	86
09473	341	10061	188	16552	200	18370	194	21700	85	22617	79	23640	81	24500	87
09474	341	10062	188	16553	200	18372	194	21701	85	22640	79	23650	81	24510	87
09475	177	10063	188	16554	200	18374	194	21702	85	23311	80	23660	81	24520	87

No.	Page	No.	Page	No.	Page	No.	Page	No.	Page	No.	Page	No.	Page	No.	Page
24530	87	25516	61	28011	95	29995	59	32627	60	34204	63	35430	62	35793	422
24550	87	25517	61	28012	95	29996	59	32685	60	34205	63	35450	62	35794	422
24570	87	25518	61	28370	94	29997	59	32687	60	34206	63	35451	62	35795	422
24590	87	25519	61	28371	94	30010	58	32705	60	34207	63	35452	62	35797	416
24610	87	25520	61	28372	94	30020	58	32715	60	34208	63	35600	435	35798	420
24630	87	25521	61	28373	94	30030	58	32720	59	34210	63	35610	435	35799	416
24650	87	25530	61	28380	94	30040	58	32900	66	34212	63	35611	435	35800	416
24670	87	25700	62	28381	94	30050	58	32901	66	34220	63	35623	437	35801	417
24700	87	25830	110	28382	94	30060	58	32902	66	34222	63	35624	437	35802	416
24710	87	25881	110	28385	94	30080	58	32922	66	34225	63	35625	437	35803	417
24730	87	25885	110	28386	94	30100	58	32923	66	34243	63	35667	416	35805	417
24740	87	25886	110	28387	94	30150	58	32924	65	34245	63	35668	416	35806	417
24750	87	25887	110	28394	95	30200	58	32925	65	34247	63	35669	416	35807	417
24800	88	25971	111	28395	95	30220	58	32926	65	34251	63	35670	416	35808	417
24810	88	25972	111	28401	95	30222	58	32927	65	34254	63	35671	416	35809	413
24813	88	26130	112	28611	409	30224	58	32928	65	34256	63	35672	416	35810	414
24820	88	26131	112	28612	409	30310	58	32930	64	34300	63	35673	419	35811	413
24823	88	26132	112	28613	410	30320	58	32999	65	34600	63	35677	416	35813	418
24900	87	26140	112	28630	410	30330	58	33000	64	34750	63	35680	416	35815	418
24940	87	26150	114	28631	410	30340	58	33001	64	34900	63	35685	416	35816	418
24960	87	26200	114	28632	410	30350	58	33002	64	34944	170	35700	421	35817	415
24961	87	26210	114	28640	409	30360	58	33003	64	34945	170	35701	415	35821	423
24962	87	26220	114	28641	409	30380	58	33004	64	34946	170	35705	415	35823	423
24963	87	26225	114	28642	409	30390	58	33005	64	34947	170	35710	422	35824	423
24964	87	27000	96	28650	95	30395	58	33006	64	34949	436	35720	413	35826	423
24965	87	27100	96	28680	84	30400	58	33007	64	34950	181	35721	414	35828	423
24966	87	27200	96	28690	84	30410	58	33008	64	35000	182	35722	414	35830	424
25160	111	27322	96	28710	85	30420	58	33022	65	35007	182	35740	419	35831	423
25161	111	27333	96	28720	85	30430	58	33024	64	35010	182	35741	419	35832	423
25162	111	27495	96	28725	85	30440	58	33026	64	35012	183	35750	421	35833	414
25163	111	27500	99	28740	95	30450	58	33028	64	35013	183	35751	421	35835	414
25164	111	27501	99	28745	95	30460	58	33030	64	35014	183	35755	421	35836	414
25165	111	27502	99	28746	95	30480	58	33032	64	35015	183	35756	415	35837	414
25166	111	27505	99	28750	95	30500	58	33035	64	35017	183	35757	415	35839	417
25170	112	27506	99	28755	95	30510	58	33038	64	35018	183	35758	415	35840	417
25171	113	27510	99	28771	95	30520	58	33039	64	35020	183	35759	415	35842	418
25172	113	27511	99	28772	95	30531	58	33040	64	35021	184	35760	422	35843	414
25173	113	27513	99	28773	95	30532	58	33065	64	35025	184	35761	415	35846	418
25230	113	27520	99	28790	97	30533	58	33067	64	35026	184	35762	415	35850	418
25300	113	27530	99	28880	146	30534	58	33080	64	35030	184	35763	419	35855	415
25301	113	27533	99	29000	97	30535	58	33085	64	35031	184	35764	420	35860	418
25307	113	27535	100	29050	97	30536	58	33087	64	35032	184	35765	411	35861	415
25310	114	27541	100	29090	100	31030	58	33105	64	35033	184	35767	411	35863	415
25351	112	27542	100	29100	100	31050	58	33107	64	35060	184	35768	411	35864	418
25352	112	27543	100	29210	98	31070	58	33125	64	35061	184	35770	420	35865	418
25353	112	27544	100	29220	98	31100	58	33127	64	35062	185	35773	420	35867	339
25360	112	27545	100	29311	98	31150	58	33147	64	35063	185	35774	420	35868	339
25370	112	27575	90	29312	98	31200	58	33177	64	35064	185	35775	422	35869	339
25380	112	27600	96	29313	98	31300	59	33530	61	35210	108	35776	420	35870	339
25390	112	27610	97	29317	98	31400	59	33532	61	35240	109	35777	420	35872	339
25400	270	27630	97	29318	98	31500	59	33535	61	35250	62	35779	419	35874	339
25405	88	27800	100	29319	98	31600	59	33550	60	35300	62	35780	419	35875	339
25410	270	27810	101	29323	98	31800	59	33555	61	35351	62	35781	419	35876	339
25411	270	27811	101	29400	159	32000	59	33557	60	35352	62	35782	419	35877	339
25412	270	27812	101	29401	159	32110	59	33650	60	35353	62	35783	419	35890	419
25420	117	27813	101	29404	159	32201	59	33655	61	35355	62	35784	419	35891	419
25450	270	27814	101	29410	160	32202	59	33657	60	35359	62	35785	420	35892	419
25500	61	27815	101	29420	220	32203	59	33900	60	35360	62	35786	421	35893	340
25510	61	27820	101	29440	160	32204	59	33905	61	35362	62	35787	421	35894	340
25511	61	27830	101	29444	160	32205	59	33907	60	35364	62	35788	421	35895	340
25512	61	27831	101	29445	160	32206	59	33925	61	35372	62	35789	421	35899	340
25513	61	27833	101	29992	59	32207	59	33950	61	35373	62	35790	421	35905	422
25514	61	27834	101	29993	59	32208	59	34182	225	35374	62	35791	421	35906	423
25515	61	27850	98	29994	59	32625	59	34184	226	35376	62	35792	420	35908	423

No.	Page	No.	Page	No.	Page	No.	Page	No.	Page	No.	Page	No.	Page	No.	Page
35911	340	38403	70	42304	46	49802	182	51645	8	53140	16	54510	121	55500	126
35914	339	38404	70	42305	46	49805	182	51650	8	53150	16	54600	12	55505	126
35915	339	38406	70	42306	46	49806	182	51671	9	53170	16	54610	12	55541	126
35916	339	38407	70	42307	47	49810	182	51672	9	53180	16	54620	12	55542	126
35918	339	38408	70	42308	47	49830	181	51673	9	53190	16	54630	12	55544	126
35923	339	38409	70	42309	47	49840	133	51674	9	53220	16	54640	12	55545	126
35924	339	38430	72	43050	47	49841	133	51675	9	53240	16	54650	12	55620	120
35927	423	38431	72	43051	47	49900	181	51676	9	53332	16	54660	12	55625	120
35930	338	38432	72	43052	47	50070	10	51677	9	53335	16	54670	12	55630	120
35931	338	38433	72	43053	47	50090	10	51678	9	53336	16	54680	12	55635	120
35932	338	38434	72	43055	47	50100	10	51679	9	53337	16	54690	12	55645	120
35933	338	38435	72	43056	47	50110	10	51680	9	53338	16	54700	12	55660	120
35940	338	38436	72	43057	47	50120	10	51681	9	53339	16	54710	12	55690	120
35950	423	38500	71	43058	47	50130	10	51682	9	53340	16	54720	12	55740	124
35963	338	38515	71	43060	47	50150	10	51683	9	53341	16	54730	12	55792	121
35964	338	38525	71	43061	47	50170	10	51684	9	53400	16	54750	12	55820	120
35968	338	38531	71	43062	47	50190	10	51685	9	53410	16	54760	12	55830	120
35970	339	38620	71	43063	47	50220	10	51686	9	53420	16	54780	12	56040	40
36000	72	38641	71	43510	48	50270	10	51687	9	53430	16	54811	122	56050	40
36004	72	38642	71	43600	109	50330	10	51688	9	53440	16	54812	122	56060	40
36005	72	38643	71	43603	109	50560	10	51689	9	53450	16	54813	122	56070	40
36006	72	38750	71	44100	48	50580	10	51690	9	53460	16	54814	122	56080	40
36008	72	38751	71	44102	48	50590	10	51691	9	53470	16	54815	122	56100	40
36014	72	38830	72	44110	48	50610	10	51692	9	53480	16	54816	122	56120	40
36015	72	39000	234	44300	48	50630	10	51693	9	53490	16	54817	122	56130	40
36016	72	39001	234	44301	48	50850	8	51694	9	53500	17	54830	122	56140	40
36018	72	39002	234	44330	49	50861	8	51695	9	53520	17	54831	122	56170	40
36032	73	39005	234	44400	49	50871	8	51696	9	53540	17	54832	122	56380	40
36033	73	40010	44	44500	49	50880	9	51705	9	53560	17	54833	122	56390	40
36034	73	40011	44	45000	52	51040	8	51710	9	53561	17	54834	122	56391	40
36037	73	40012	44	45010	53	51042	8	51715	10	53563	17	54835	122	56392	40
36038	73	40013	44	45012	52	51044	8	51720	9	53571	17	54836	122	56393	40
36039	73	40014	44	45020	53	51046	8	51721	9	53572	17	54837	122	56400	40
36570	120	40015	44	45050	52	51047	8	51722	9	53573	17	54850	122	56470	40
36650	72	40016	44	45100	53	51048	8	51740	11	53575	17	54851	122	56473	40
37100	70	40017	44	45151	53	51049	8	51741	11	53576	17	54852	122	56475	41
37101	70	40018	44	45160	53	51051	8	52580	11	53577	17	54853	122	56477	41
37102	70	40041	44	45201	53	51060	8	52630	11	53580	18	54854	122	56478	41
37103	70	40042	44	45500	52	51070	8	52652	10	53600	16	54855	122	56505	41
37104	70	40043	44	45503	52	51080	8	52653	10	53610	16	54856	122	56506	41
37106	70	40044	44	45504	52	51090	8	52654	10	53630	16	54870	122	56507	41
37107	70	40045	44	48000	92	51100	8	52655	10	53650	16	54871	122	56600	41
37108	70	40047	44	48050	93	51110	8	52656	10	53670	16	54875	122	56622	39
37109	70	40048	44	48060	92	51120	8	52657	10	53700	17	54876	123	56623	39
37110	70	40050	44	48070	93	51130	8	52658	10	53710	17	54900	123	56624	39
37111	70	40051	44	48080	92	51140	8	52659	10	53730	17	54901	123	56625	39
37112	70	40054	45	48081	93	51150	8	52660	10	54000	12	54902	123	56629	39
37113	70	40055	45	48082	93	51160	8	52661	10	54061	12	54903	123	56630	39
37114	70	40056	45	48100	92	51170	8	52680	11	54062	12	55100	121	56631	39
37115	70	40057	45	48150	93	51180	8	52700	11	54063	12	55150	121	56632	39
37150	70	40160	46	48200	93	51190	8	52730	11	54065	12	55200	121	56633	39
37200	70	40180	46	48330	93	51200	8	52740	11	54066	12	55210	121	56634	39
37250	70	40200	46	48350	94	51210	8	52750	11	54067	12	55211	121	56635	39
37300	70	40700	46	49200	93	51220	8	52770	11	54068	12	55212	121	56639	39
37380	70	41121	45	49450	94	51240	8	52790	11	54070	13	55215	121	56640	39
37400	70	41151	45	49600	94	51270	8	52820	11	54071	13	55216	121	56642	39
37430	70	41152	45	49770	94	51300	8	52900	11	54072	13	55217	121	56643	39
37500	70	41381	45	49771	94	51320	8	52935	12	54073	13	55220	121	56644	39
37800	70	41500	45	49772	94	51560	8	52936	12	54080	12	55221	121	56645	39
37900	70	41510	120	49773	94	51580	8	53002	16	54081	12	55222	121	56649	39
38150	70	42300	46	49774	94	51590	8	53003	16	54497	121	55250	120	56710	11
38200	70	42301	46	49775	94	51620	8	53100	16	54498	121	55300	120	56720	11
38401	70	42302	47	49800	182	51630	8	53120	16	54499	121	55350	120	56730	11
38402	70	42303	46	49801	182	51640	8	53130	16	54500	121	55400	126	56770	11

No.	Page	No.	Page	No.	Page	No.	Page	No.	Page	No.	Page	No.	Page	No.	Page
56780	11	58700	22	61040	28	65840	38	67171	340	67883	319	69395	465	71605	469
56790	11	60750	28	61050	28	65850	38	67182	325	67884	319	69396	465	71610	467
56980	226	60780	27	61060	28	66080	37	67183	326	67885	319	69397	465	71611	467
57000	226	60781	27	61070	28	66112	38	67200	324	67887	319	69502	142	71612	467
57010	226	60782	27	61080	28	66113	38	67201	324	67888	319	69503	142	71614	468
57020	226	60783	27	61090	28	66200	38	67202	324	67889	319	69504	142	71615	468
57030	227	60785	27	61110	28	66210	38	67203	324	67890	319	69505	142	71616	468
57050	227	60880	26	61120	28	66301	35	67204	324	67900	306	69506	142	71620	469
57091	230	60881	26	61140	28	66302	35	67220	325	67901	306	69507	142	71630	468
57092	230	60882	26	61160	28	66310	36	67222	325	67920	303	69508	142	71631	468
57097	230	60883	26	61210	29	66330	36	67224	325	67961	302	69509	142	71632	468
57100	227	60885	26	61220	29	66400	36	67225	325	68011	317	69510	142	71633	468
57160	227	60886	26	61230	29	66410	36	67260	340	68012	317	69539	142	71634	468
57210	227	60887	26	61240	29	66570	36	67420	317	68032	311	69540	142	71635	468
57220	227	60888	26	61250	29	66580	37	67450	316	68033	311	69542	142	71636	468
57221	227	60889	26	61260	29	66710	37	67451	316	68090	326	69543	142	71637	468
57260	227	60890	26	61270	29	66720	37	67453	316	68100	326	69546	142	71638	468
57300	13	60891	26	61280	29	66760	37	67455	317	68115	326	69550	143	71639	468
57350	13	60912	26	61290	29	66770	37	67457	316	68172	306	69551	143	71800	475
57400	13	60913	26	61300	29	66841	326	67458	315	68173	307	69552	143	71801	475
57450	13	60914	26	61320	29	66842	327	67470	318	68174	307	69572	142	71802	475
57451	13	60915	26	61340	29	66900	327	67480	318	68194	307	69608	143	71803	475
57600	223	60916	26	61350	29	66901	327	67481	318	68250	321	69609	143	71804	475
57610	224	60917	26	61550	29	66902	327	67500	313	68251	321	69610	143	71805	475
57612	224	60918	26	64050	33	66903	327	67501	314	68260	321	69612	143	71807	475
57613	224	60920	26	64060	32	66904	328	67520	315	68269	313	69613	143	71808	475
57614	224	60921	26	64070	33	66906	328	67525	314	68270	312	69630	142	71809	475
57616	224	60922	26	64090	33	66930	328	67526	314	68271	312	69631	142	71810	475
57620	224	60923	26	64310	34	66931	328	67527	315	68272	312	69635	142	71811	475
57630	224	60924	26	64330	34	66937	328	67528	314	68273	312	69637	142	71812	475
57640	224	60931	26	64370	33	67011	380	67530	315	68280	311	69851	438	71814	475
57660	224	60932	26	64371	34	67012	381	67572	308	68360	320	69860	438	71815	475
57700	228	60933	26	64384	34	67013	381	67573	308	68361	320	70000	130	71816	475
57730	228	60934	26	64385	31	67014	381	67574	308	68362	320	70020	130	71817	475
57740	228	60935	26	64395	34	67019	382	67575	309	68363	320	70023	130	71818	475
57830	219	60936	26	64396	34	67026	381	67576	309	68364	320	70030	130	71819	475
58140	19	60937	26	64400	33	67032	381	67585	309	68365	320	70035	130	71820	475
58150	19	60938	26	64401	33	67033	382	67586	310	68470	308	70100	130	71821	475
58160	18	60939	26	64553	35	67034	382	67587	310	68477	307	70160	131	71822	475
58210	18	60950	26	64554	35	67053	382	67590	309	69311	478	70201	131	71823	475
58240	18	60951	26	64555	225	67054	382	67640	310	69313	478	70202	131	71824	475
58260	18	60952	26	64650	32	67055	382	67641	310	69314	479	70210	131	71825	475
58440	218	60953	26	64654	29	67056	383	67642	311	69315	479	70270	131	71827	476
58441	219	60954	26	64655	30	67090	321	67660	313	69316	479	70280	212	71828	476
58450	219	60955	26	64658	30	67091	321	67661	313	69319	479	70320	131	71829	476
58455	219	60956	26	64660	31	67093	322	67700	303	69320	479	70330	131	71830	476
58456	220	60957	26	64952	30	67094	322	67702	304	69321	479	70340	131	71831	476
58539	218	60958	26	64960	30	67095	322	67703	304	69339	479	70400	131	71832	476
58540	216	60959	26	65025	31	67110	322	67705	304	69340	479	70410	131	71833	476
58550	217	60961	26	65041	30	67112	322	67707	305	69341	480	70420	131	71834	476
58600	18	60962	26	65045	32	67115	323	67709	304	69350	480	70430	131	71835	476
58602	18	60963	26	65100	32	67116	323	67710	305	69351	480	70480	131	71836	476
58633	19	60964	26	65105	30	67120	323	67780	302	69352	480	70490	131	71838	476
58634	19	60965	26	65120	31	67121	323	67781	303	69353	480	70500	131	71840	476
58640	19	60966	26	65123	31	67122	323	67790	303	69354	480	70510	131	71841	476
58641	19	60967	26	65124	32	67123	323	67805	302	69370	480	71000	132	71842	476
58643	20	60968	26	65150	32	67124	323	67811	302	69371	480	71040	132	71843	476
58661	20	60969	26	65233	54	67160	336	67840	305	69372	481	71050	132	71844	476
58685	20	60970	26	65235	54	67161	337	67841	306	69373	481	71052	132	71846	476
58687	20	60975	28	65260	228	67162	337	67851	305	69374	481	71060	132	71847	476
58688	21	60990	27	65270	228	67163	337	67877	318	69375	481	71080	133	71848	476
58690	21	61010	28	65700	35	67164	337	67880	318	69378	481	71160	133	71849	476
58691	22	61020	28	65705	35	67165	337	67881	319	69390	465	71603	469	71850	476
58693	23	61030	28	65800	36	67166	337	67882	319	69391	466	71604	469	71851	476



No.	Page	No.	Page	No.	Page	No.	Page	No.	Page	No.	Page	No.	Page	No.	Page
71852	476	72407	375	72931	344	73271	140	73801	139	73964	366	74439	278	74667	368
71853	476	72440	374	72932	344	73300	140	73802	139	73966	366	74440	276	74721	346
71854	476	72441	374	72933	333	73325	156	73803	139	73967	366	74441	277	74722	346
71855	476	72442	374	72934	333	73330	156	73804	139	73968	366	74442	276	74723	346
71856	476	72460	372	72935	333	73331	156	73805	139	73969	366	74443	277	74724	346
71857	476	72484	373	72936	333	73340	157	73806	139	73970	366	74447	277	74730	352
71858	476	72486	373	72937	333	73341	157	73807	139	73971	366	74450	277	74731	352
71859	476	72489	373	72938	334	73342	157	73808	139	73972	366	74451	278	74732	352
71860	476	72490	373	72939	334	73343	157	73831	138	73973	366	74452	278	74733	352
71970	133	72493	373	72942	335	73350	158	73833	138	74003	361	74453	278	74734	352
71971	133	72494	373	72943	335	73351	158	73835	138	74060	361	74454	278	74750	352
71972	133	72500	372	72944	335	73352	158	73840	140	74077	360	74455	278	74751	353
71975	134	72501	372	72945	335	73353	158	73843	140	74078	360	74457	277	74752	353
71976	134	72504	372	72948	334	73360	158	73845	140	74079	360	74459	361	74753	353
71977	134	72505	372	72950	334	73362	158	73850	140	74080	360	74460	361	74765	353
71980	133	72506	372	72951	334	73400	155	73853	140	74081	361	74462	363	74766	353
71981	133	72508	372	72952	334	73403	155	73855	140	74082	361	74466	363	74771	353
71982	133	72509	372	72953	334	73404	155	73875	140	74094	358	74468	363	74772	353
71983	133	72510	372	72954	334	73410	156	73881	139	74100	358	74471	363	74773	353
71990	134	72524	373	72955	333	73412	156	73882	139	74102	358	74480	277	74775	354
71991	134	72525	373	72956	335	73413	156	73883	139	74104	358	74483	278	74776	354
71992	134	72526	373	72958	335	73420	155	73884	139	74108	358	74484	278	74780	463
71993	134	72527	373	72960	335	73430	157	73885	139	74113	359	74501	361	74781	463
71994	134	72528	373	72963	335	73470	269	73886	139	74115	359	74503	362	74782	464
71995	134	72529	373	72964	335	73473	269	73887	139	74117	359	74504	362	74784	464
71996	134	72530	373	72965	335	73490	201	73888	139	74121	359	74505	361	74785	464
71997	134	72531	373	72966	335	73500	270	73892	139	74123	359	74508	362	74786	464
72000	134	72532	373	72967	335	73503	201	73893	139	74125	358	74509	362	74787	464
72001	134	72533	373	72968	335	73561	138	73894	139	74126	358	74540	362	74789	464
72010	134	72534	373	72969	335	73562	138	73895	139	74127	359	74541	362	74790	465
72011	134	72535	373	72970	335	73563	138	73896	139	74128	359	74542	362	74791	465
72012	134	72570	374	72972	333	73565	138	73897	139	74130	358	74543	362	74792	465
72013	134	72572	374	72973	333	73567	138	73898	139	74131	358	74555	363	74794	465
72015	134	72573	374	72974	335	73568	138	73906	139	74132	358	74580	365	74802	349
72016	134	72615	373	72975	336	73569	138	73909	139	74134	359	74581	365	74804	349
72017	134	72616	373	72976	335	73570	138	73929	139	74135	359	74595	364	74812	349
72018	134	72617	373	72977	336	73571	138	73931	365	74136	359	74600	363	74816	350
72019	134	72620	373	72978	336	73572	138	73932	365	74137	359	74601	364	74818	350
72020	134	72621	373	72979	336	73573	138	73933	365	74145	360	74602	364	74820	350
72021	134	72622	373	72981	336	73574	138	73934	365	74146	360	74604	364	74828	350
72022	134	72625	373	72984	336	73575	138	73935	365	74149	361	74610	364	74831	350
72040	133	72626	373	72985	336	73590	138	73936	365	74150	360	74622	364	74833	350
72060	133	72627	373	72994	334	73598	139	73937	365	74151	360	74624	364	74835	350
72080	133	72630	373	72995	334	73780	139	73938	365	74160	360	74626	368	74838	350
72100	133	72631	373	72996	334	73781	139	73939	365	74162	360	74627	368	74841	350
72120	133	72632	373	72997	334	73782	139	73940	365	74171	365	74628	368	74843	350
72140	133	72683	367	72998	334	73783	139	73941	365	74172	365	74631	368	74846	350
72350	372	72684	367	73021	334	73784	139	73942	365	74173	365	74632	368	74849	350
72351	372	72685	367	73022	334	73785	139	73943	365	74174	365	74633	368	74851	351
72352	372	72686	367	73025	334	73786	139	73945	365	74175	365	74646	369	74853	351
72353	372	72801	366	73026	334	73787	139	73946	365	74176	365	74647	369	74855	351
72354	372	72802	366	73027	334	73788	139	73947	365	74230	367	74653	368	74856	351
72355	372	72803	366	73031	335	73789	139	73950	366	74231	367	74654	368	74858	350
72356	372	72804	366	73032	335	73790	139	73951	366	74232	367	74655	368	74861	351
72357	372	72805	366	73033	335	73791	139	73952	366	74233	367	74657	368	74863	351
72358	372	72806	366	73034	335	73792	139	73953	366	74240	367	74658	368	74866	351
72370	372	72807	366	73035	335	73793	139	73954	366	74410	276	74659	368	74869	351
72371	372	72808	366	73051	258	73794	139	73955	366	74411	276	74660	367	74882	351
72372	372	72809	366	73052	255	73795	139	73958	366	74420	276	74661	367	74885	351
72373	372	72890	366	73056	255	73796	139	73959	366	74421	276	74662	367	74886	351
72400	375	72891	366	73057	255	73797	139	73960	366	74422	276	74663	367	74887	351
72401	375	72920	343	73060	259	73798	139	73961	366	74430	276	74664	368	74910	351
72402	375	72922	344	73260	140	73799	139	73962	366	74431	276	74665	368	74911	351
72404	375	72928	343	73270	140	73800	139	73963	366	74432	276	74666	368	74912	351

No.	Page	No.	Page	No.	Page	No.	Page	No.	Page	No.	Page	No.	Page	No.	Page
74913	351	75352	466	75553	474	75779	462	76101	106	76857	271	77930	286	78388	124
74914	351	75353	466	75554	474	75801	452	76160	106	76858	271	78000	222	78400	229
74920	352	75354	466	75555	477	75802	452	76180	107	76859	271	78002	222	78401	229
74921	352	75355	466	75558	477	75803	452	76181	107	76870	272	78003	222	78405	229
74922	352	75356	466	75559	477	75805	454	76182	107	76877	272	78007	222	78410	229
74923	352	75360	467	75564	473	75806	454	76183	107	76880	272	78020	344	78432	282
74924	352	75361	467	75565	473	75807	454	76184	107	76881	272	78021	344	78434	282
75000	141	75362	467	75578	474	75808	454	76185	107	76882	272	78022	344	78436	282
75031	142	75363	467	75579	474	75809	455	76186	107	76883	272	78027	140	78477	219
75050	141	75364	467	75619	472	75811	455	76190	107	76884	272	78030	222	78540	332
75060	141	75365	467	75620	472	75812	455	76210	108	77004	283	78031	222	78541	332
75100	141	75366	467	75621	472	75813	455	76214	108	77005	283	78032	223	78542	332
75120	178	75367	467	75622	472	75815	455	76220	108	77006	283	78035	223	78543	332
75121	178	75368	467	75623	473	75816	455	76230	108	77061	283	78037	221	78555	332
75122	178	75369	467	75624	472	75817	456	76250	108	77062	283	78039	221	78556	332
75123	178	75370	467	75625	471	75818	456	76305	109	77063	283	78040	220	78557	332
75124	178	75371	467	75626	471	75827	456	76311	109	77064	283	78041	220	78570	332
75125	178	75372	467	75627	471	75828	456	76312	109	77100	285	78042	220	78571	332
75130	178	75373	467	75628	471	75829	456	76314	109	77105	285	78043	221	78572	332
75131	178	75374	467	75631	471	75830	457	76320	54	77170	286	78044	223	78575	332
75132	178	75375	467	75632	471	75831	457	76526	105	77180	286	78045	221	78576	332
75133	178	75376	467	75633	471	75832	458	76621	105	77190	286	78046	220	78577	332
75140	141	75377	467	75634	471	75833	458	76622	105	77191	286	78047	221	78580	332
75141	141	75378	467	75635	472	75834	457	76640	105	77192	286	78061	221	78581	332
75201	125	75379	467	75636	472	75835	457	76650	105	77193	286	78067	221	78582	332
75202	125	75380	467	75639	472	75836	456	76660	106	77200	285	78068	221	78585	332
75230	141	75381	467	75645	474	75837	457	76700	110	77203	285	78080	249	78586	332
75231	141	75382	467	75646	474	75838	457	76705	110	77204	285	78081	249	78587	332
75233	141	75383	467	75647	474	75852	462	76710	110	77205	285	78082	249	78590	333
75238	178	75384	467	75648	474	75853	462	76750	349	77210	284	78084	249	78591	333
75239	178	75386	467	75649	474	75870	454	76751	349	77211	284	78085	249	78592	333
75240	178	75387	467	75650	474	75880	458	76752	349	77212	284	78090	249	78620	282
75245	141	75388	467	75651	474	75882	458	76755	349	77213	284	78091	249	78622	282
75246	141	75389	467	75652	475	75883	458	76756	349	77250	284	78097	251	78624	282
75247	141	75421	468	75653	475	75884	458	76757	349	77300	284	78107	249	78626	283
75260	140	75422	468	75654	475	75885	459	76760	349	77350	284	78113	249	78628	283
75261	140	75423	468	75655	475	75886	459	76761	349	77400	284	78132	250	78630	283
75262	140	75424	468	75662	453	75887	459	76762	349	77500	284	78133	250	78632	283
75270	178	75448	468	75663	453	75888	459	76765	349	77600	284	78136	250	78633	283
75271	178	75449	468	75664	453	75889	459	76766	349	77606	284	78137	250	78641	282
75272	178	75450	468	75665	453	75915	483	76767	349	77607	284	78138	250	78642	282
75273	178	75451	468	75670	462	75916	483	76800	271	77608	284	78139	250	78660	345
75274	178	75455	482	75671	463	75921	484	76806	271	77609	284	78143	250	78661	345
75285	178	75464	482	75672	463	75922	484	76807	271	77612	285	78151	250	78662	345
75286	178	75465	481	75673	463	75923	485	76810	271	77618	285	78154	254	78663	345
75287	178	75467	481	75674	463	75924	485	76811	271	77700	285	78155	250	78720	290
75288	178	75469	482	75675	462	75930	484	76814	271	77704	285	78158	251	78730	290
75295	140	75470	482	75676	462	75931	484	76815	271	77705	285	78180	251	78731	290
75300	178	75471	482	75705	459	75932	484	76818	271	77715	299	78181	251	78734	291
75301	178	75472	482	75706	460	75944	483	76819	271	77815	297	78186	251	78736	291
75302	178	75483	470	75707	460	75945	483	76822	271	77830	296	78187	251	78738	291
75303	178	75484	470	75708	460	75951	483	76823	271	77831	296	78190	251	78750	290
75304	178	75487	470	75709	460	75953	483	76826	271	77833	296	78250	252	78751	290
75327	469	75498	469	75710	460	75979	478	76830	271	77834	296	78252	252	78752	290
75334	469	75499	469	75711	460	75980	477	76832	271	77835	296	78260	252	78756	229
75335	469	75527	473	75712	461	75981	477	76835	272	77837	296	78261	252	78771	292
75336	469	75535	473	75716	453	75983	478	76836	272	77838	296	78262	252	78780	292
75345	466	75536	473	75718	453	75984	478	76850	271	77840	296	78266	252	78785	293
75346	466	75537	473	75719	454	76000	106	76851	271	77845	296	78300	223	78788	292
75347	466	75539	473	75729	461	76010	106	76852	271	77850	297	78301	223	78789	293
75348	466	75544	470	75775	461	76011	106	76853	271	77861	297	78303	223	78791	293
75349	466	75545	470	75776	461	76015	106	76854	271	77881	297	78306	223	78794	293
75350	466	75550	470	75777	461	76035	106	76855	271	77900	286	78341	124	78799	293
75351	466	75551	470	75778	461	76036	106	76856	271	77910	286	78381	123	78800	291
												78385	124	78801	291

No.	Page	No.	Page	No.	Page	No.	Page	No.	Page	No.	Page	No.	Page	No.	Page
78802	292	79491	254	79965	395	81109	204	81716	199	82315	240	82692	374	85040	342
78811	292	79502	261	79968	395	81110	204	81719	199	82320	240	82693	374	85050	342
78812	292	79503	261	79971	395	81114	205	81731	228	82322	243	82694	374	85060	342
78813	292	79550	264	79977	273	81115	205	81741	233	82331	240	82699	376	85080	342
78814	292	79551	264	79978	273	81117	205	81751	198	82341	240	82706	376	85090	342
78815	292	79552	265	79979	273	81118	206	81772	54	82343	242	82707	378	85100	342
78819	293	79560	265	79982	273	81119	206	81773	55	82351	241	82713	376	85112	342
78821	293	79561	265	79983	273	81122	207	81775	55	82355	72	82714	376	85113	342
78822	293	79562	265	79984	273	81133	206	81780	54	82360	240	82715	376	85114	342
78824	293	79563	265	80012	230	81137	205	81783	54	82370	240	82717	376	85115	342
78825	293	79564	265	80022	230	81142	207	81784	55	82372	241	82723	376	85116	342
78826	293	79565	265	80032	230	81150	205	81785	198	82373	241	82724	377	85118	342
78830	293	79566	266	80042	230	81370	211	81786	197	82374	241	82726	378	85119	342
78831	293	79567	266	80052	230	81371	211	81791	196	82375	241	82730	377	85120	342
78833	293	79570	268	80062	230	81372	211	81794	196	82377	240	82731	377	85122	342
78834	293	79580	268	80072	230	81373	211	81795	197	82378	240	82732	378	85123	342
78835	293	79630	268	80082	230	81374	211	81801	55	82379	240	82733	377	85124	342
78855	256	79639	269	80107	231	81378	211	81824	229	82380	240	82734	377	85125	342
78870	344	79640	269	80111	230	81379	211	81825	229	82384	241	82736	375	85126	342
78890	259	79641	269	80252	231	81380	211	81830	218	82386	241	82743	377	85128	342
78894	258	79675	262	80271	231	81387	212	81860	218	82388	241	82756	378	85129	342
78910	125	79725	262	80300	231	81390	211	82000	297	82390	241	82771	375	85130	342
78911	124	79734	262	80307	231	81391	211	82001	298	82392	241	82772	375	85131	342
78912	124	79771	260	80308	231	81399	212	82005	297	82393	241	82830	380	85132	342
78972	253	79772	260	80309	231	81400	212	82015	298	82395	241	82831	380	85133	342
78974	253	79773	260	80312	231	81401	212	82020	298	82397	242	82832	380	85134	342
78981	252	79774	260	80320	232	81490	211	82021	298	82400	241	82861	375	85135	342
78982	253	79775	260	80330	232	81491	211	82022	298	82401	241	82863	375	85170	342
78983	253	79781	256	80340	232	81492	211	82023	298	82402	241	82920	236	85172	342
78985	253	79782	256	80350	232	81500	211	82031	297	82403	241	82941	270	85174	343
78986	253	79783	256	80402	231	81501	211	82032	297	82404	241	82942	258	85177	343
78987	253	79790	260	80412	232	81502	211	82100	234	82405	241	82942	258	85178	343
78992	248	79791	260	80450	232	81519	211	82107	234	82406	241	82951	238	85178	343
78995	248	79792	260	80470	225	81520	211	82120	234	82407	241	82952	238	85180	343
78997	248	79800	268	80471	225	81521	211	82200	235	82408	241	82953	238	85190	343
79049	248	79810	260	80472	225	81522	211	82201	234	82409	241	82954	238	85191	343
79054	248	79811	260	80473	225	81523	211	82205	235	82410	241	82955	238	86700	345
79087	253	79812	260	80474	225	81524	211	82206	235	82411	241	82967	238	86701	345
79088	253	79823	273	80500	225	81525	211	82209	235	82412	241	82970	239	86750	125
79089	253	79824	273	80510	225	81527	211	82227	235	82413	241	82971	239	86751	125
79254	254	79861	264	80520	225	81553	210	82231	235	82414	241	82991	438	86752	125
79257	254	79862	264	80530	225	81556	210	82232	235	82415	241	82992	438	86760	125
79309	254	79863	264	80600	225	81560	210	82233	236	82431	236	83000	236	86761	125
79314	258	79865	264	80601	225	81562	210	82234	235	82440	236	83001	237	86770	125
79320	255	79866	264	80602	225	81570	210	82260	243	82445	236	83002	237	86771	125
79324	258	79867	264	80620	226	81617	208	82261	243	82502	236	83003	237	87245	346
79325	258	79869	264	80640	226	81618	208	82262	243	82504	236	83004	237	87301	346
79327	255	79880	260	80660	227	81618	208	82265	242	82506	236	83005	237	87302	346
79328	255	79909	256	80661	227	81631	209	82266	242	82520	236	83009	222	87303	346
79346	269	79919	268	80751	233	81632	209	82267	242	82541	232	83016	237	87305	346
79350	264	79924	268	80752	233	81633	210	82270	242	82542	232	83017	237	87307	346
79354	256	79926	261	80753	233	81638	209	82271	242	82543	233	83018	237	87311	347
79358	264	79927	261	80901	208	81640	209	82272	242	82544	233	83260	239	87312	347
79365	256	79928	261	80902	208	81643	209	82273	242	82610	233	83261	239	87313	347
79366	256	79929	261	80903	208	81644	209	82274	242	82611	233	83262	239	87315	347
79367	256	79930	261	80970	205	81647	210	82275	242	82650	233	83280	239	87317	347
79368	256	79931	261	81060	207	81650	207	82280	242	82671	373	84400	198	87321	347
79386	270	79932	261	81070	206	81651	207	82281	242	82673	373	85000	242	87322	347
79390	272	79933	261	81072	206	81653	208	82282	242	82675	373	85001	242	87323	347
79391	272	79943	256	81080	206	81661	208	82300	239	82677	373	85002	242	87325	347
79398	271	79944	260	81100	204	81690	228	82301	240	82682	374	85003	242	87327	347
79416	254	79960	395	81101	204	81700	198	82305	240	82684	374	85004	242	87331	347
79448	261	79962	395	81107	204	81711	198	82308	240	82685	374	85005	242	87332	347
79468	265	79963	395	81108	204	81713	198	82310	240	82691	374	85020	342	87333	347
												85030	342	87335	347

No.	Page	No.	Page	No.	Page	No.	Page	No.	Page	No.	Page	No.	Page	No.	Page
87337	347	88801	431	88931	403	89221	386	89335	396	89482	268	91050	430	99315	408
87351	347	88805	431	88932	403	89222	386	89336	396	89483	267	91052	430	99390	421
87352	347	88806	431	88933	404	89223	386	89345	396	89484	267	91060	430	99391	422
87353	347	88809	431	88935	404	89224	386	89351	392	89485	267	91061	430	99400	420
87354	347	88811	431	88936	404	89225	386	89360	395	89486	267	92100	434	99401	422
87361	347	88812	431	88938	404	89226	386	89361	395	89507	426	92105	434	99402	424
87362	347	88820	431	88939	404	89227	386	89370	395	89508	426	92110	434	99403	424
87363	347	88830	431	89000	434	89228	386	89371	395	89509	426	92115	434	99404	424
87364	347	88831	432	89001	386	89229	386	89372	395	89515	426	99001	408	99405	425
87371	347	88832	432	89002	386	89230	386	89373	395	89518	426	99005	408	99406	425
87372	347	88840	398	89003	386	89231	386	89380	395	89520	426	99006	408	99407	425
87373	347	88841	398	89004	386	89232	386	89381	395	89526	426	99007	409	99408	424
87374	347	88842	398	89007	387	89233	387	89382	395	89528	426	99008	409	99409	425
87381	348	88849	398	89008	387	89234	387	89383	395	89536	427	99009	409	99410	424
87382	348	88850	397	89011	387	89235	388	89384	395	89537	427	99028	413	99412	425
87383	348	88851	397	89013	388	89236	388	89385	395	89538	427	99033	412	99413	425
87384	348	88853	399	89015	387	89239	387	89386	395	89539	427	99034	411	99415	424
87391	348	88855	402	89017	388	89240	387	89387	395	89540	427	99035	411	99416	424
87392	348	88856	401	89018	388	89241	388	89390	392	89541	428	99036	411	99418	424
87393	348	88857	400	89020	388	89242	388	89401	266	89542	428	99037	412	99419	425
87401	348	88858	399	89022	389	89243	389	89402	266	89543	428	99038	412	99420	424
87402	348	88859	399	89081	429	89244	389	89403	266	89545	428	99039	412	99421	424
87403	348	88860	401	89100	386	89245	388	89404	266	89547	428	99040	412	99425	425
87411	348	88861	402	89101	386	89246	388	89405	266	89552	396	99047	410	99426	425
87412	348	88862	402	89102	386	89247	389	89406	266	89553	396	99048	410	99427	425
87413	348	88863	402	89103	386	89248	389	89411	266	89560	435	99049	411	99428	425
87431	348	88864	403	89104	387	89251	388	89412	266	89561	435	99050	410	99429	425
87432	348	88865	403	89105	387	89252	388	89413	266	89562	435	99051	410	99430	426
87433	348	88869	400	89106	388	89253	387	89414	266	89563	435	99052	411	99435	426
87435	348	88870	399	89107	388	89257	393	89415	266	89564	435	99053	413	99436	426
87437	348	88871	400	89108	388	89259	393	89416	266	89610	427	99054	413	99438	426
87451	348	88872	401	89109	388	89260	393	89421	267	89611	427	99101	406	99440	426
87452	348	88874	400	89110	387	89263	392	89422	267	89700	429	99103	407	99442	426
87453	348	88890	399	89113	389	89269	393	89423	267	89702	429	99104	407	99443	426
87454	348	88891	398	89120	389	89272	392	89424	267	89704	429	99109	407	99444	426
87455	348	88892	398	89162	394	89275	393	89425	267	89715	428	99110	408	99445	426
87456	348	88893	398	89163	394	89277	393	89426	267	89720	428	99111	407	99446	426
87457	348	88894	398	89164	394	89280	393	89441	266	89722	429	99112	408	99460	65
88422	380	88895	397	89165	394	89290	395	89442	266	89750	432	99113	407	99461	65
88555	378	88896	397	89166	394	89291	395	89443	266	89753	432	99114	407	99462	65
88560	378	88897	397	89167	394	89292	395	89444	266	89770	432	99115	408	99463	65
88672	379	88899	399	89187	389	89293	395	89452	266	89860	437	99116	407	99464	65
88674	379	88900	403	89189	390	89294	395	89453	266	89870	437	99119	407	99472	65
88675	379	88902	403	89190	390	89295	395	89454	266	89880	412	99180	406	99495	441
88676	379	88903	402	89191	391	89298	394	89456	267	89890	412	99181	406	99528	448
88677	379	88904	402	89192	391	89299	394	89457	267	89891	412	99182	406	99568	448
88680	379	88905	402	89193	390	89300	394	89458	267	89896	436	99190	405	99575	448
88681	379	88906	402	89195	391	89302	394	89459	267	89950	437	99191	406	99576	448
88700	429	88907	401	89200	389	89303	394	89462	267	89990	437	99193	404	99582	441
88701	429	88908	401	89201	389	89305	394	89463	267	90000	432	99194	404	99584	443
88702	429	88909	403	89202	389	89307	394	89464	267	90001	432	99195	406	99642	440
88703	429	88910	401	89203	391	89308	394	89465	267	90002	433	99202	405	99643	440
88704	429	88911	401	89204	391	89310	394	89466	267	90003	433	99203	405	99644	438
88705	429	88912	401	89206	391	89311	395	89467	267	90030	433	99204	405	99645	439
88710	430	88913	400	89207	391	89312	395	89470	267	90031	433	99206	405	99646	439
88713	430	88914	400	89208	392	89313	395	89471	267	90150	434	99207	405	99647	439
88714	430	88915	400	89209	390	89314	395	89472	267	90200	435	99208	405	99649	439
88715	430	88916	400	89210	390	89315	395	89473	267	90204	435	99209	405	99654	440
88716	430	88917	399	89211	391	89316	395	89474	267	90205	436	99230	404	99655	440
88720	413	88920	399	89213	390	89318	395	89475	267	90240	435	99240	406	99659	441
88740	430	88925	393	89214	390	89319	395	89478	268	90350	433	99250	406	99670	441
88780	396	88926	397	89215	390	89320	395	89479	268	90360	433	99300	409	99671	441
88783	397	88927	397	89218	392	89330	396	89480	268	91000	430	99301	409	99702	445
88784	397	88930	403	89220	391	89331	396	89481	268	91003	430	99310	408	99704	446



No.	Page	No.	Page	No.	Page	No.	Page	No.	Page	No.	Page	No.	Page	No.	Page
99705	446	99711	446	99782	447	99820	448	99904	442	99910	444	99914	445	99919	441
99706	446	99760	447	99783	447	99900	444	99905	443	99911	442	99916	445	99920	444
99707	446	99761	447	99800	447	99902	443	99906	442	99912	445	99917	444		
99708	446	99762	447	99805	448	99903	445	99908	443	99913	445	99918	442		

Memo

## PL

I. TOYA S.A. informuje, iż:

- 1) niniejszy katalog nie stanowi oferty w rozumieniu prawa cywilnego;
- 2) prezentowane w niniejszym katalogu artykuły mogą w rzeczywistości odbiegać od wskazanego na zdjęciach wzoru, w szczególności jeżeli chodzi o cechy zewnętrzne, tj. wielkość, kolor, sposób opakowania, ilość przedmiotów w opakowaniu;
- 3) nie ponosi odpowiedzialności za drobne różnice w sposobie pakowania czy właściwościach artykułów pozostających bez wpływu na jego przeznaczony cel lub sposób użytkowania;
- 4) nie ponosi odpowiedzialności wynikającej z jakichkolwiek niedokładności lub nieścisłości, co do informacji zawartych w przedmiotowym katalogu;
- 5) nie ponosi odpowiedzialności za ewentualną szkodę powstałą w wyniku otrzymania towaru o innych właściwościach niż prezentowany na zdjęciach.

II. Pomimo najlepszych starań poczynionych przez TOYA S.A. nie może ona zagwarantować, iż informacje zawarte w niniejszym katalogu w pełni odpowiadają rzeczywistości.

III. Wszelkie decyzje podjęte na podstawie informacji zawartych w przedmiotowym katalogu podejmowane są na własne ryzyko osoby, która korzysta z tych informacji.

## GB

I. TOYA S.A. informs that:

- 1) the present catalogue does not constitute an offer as construed in the civil law;
- 2) the goods presented in the present catalogue may in fact differ from the models shown in the pictures, particularly as far as external properties are concerned, namely size, colour, packaging, number of items in the package;
- 3) the company will not be held responsible for small differences in packaging or properties of the goods, which do not affect the purpose or the exploitation of the tools;
- 4) the company will not be held responsible for any inaccuracies or imprecision regarding the information presented in the catalogue;
- 5) the company will not be held responsible for any damage caused by goods whose properties differ from those of the tools presented in the photographs.

II. In spite of all the efforts made by TOYA S.A., the company cannot guarantee the information contained in the present catalogue fully correspond to the reality.

III. Any decisions made on the basis of the information contained in the present catalogue will be made at the risk of the person who makes them using the aforementioned information.

## D

I. TOYA S.A. informiert, dass:

- 1) der vorliegende Katalog kein Angebot im zivilrechtlichen Sinne darstellt;
- 2) die im vorliegenden Katalog präsentierten Artikel in der Realität von den auf den Musterfotos gezeigten abweichen können, und zwar besonders dann, wenn es um äußere Eigenschaften geht, wie z.B. Größe, Farbe, Art der Verpackung, Anzahl der Gegenstände in der Verpackung;
- 3) sie keine Verantwortung für geringfügige Unterschiede bei der Verpackungsart oder den Eigenschaften der Artikel übernimmt, die ohne Auswirkungen auf seinen Bestimmungszweck oder die Art der Nutzung bleiben;
- 4) sie keine Verantwortung für irgendwelche Oberflächlichkeiten und Ungenauigkeiten bzgl. der im Sachkatalogkatalog enthaltenen Informationen übernimmt;
- 5) sie keine Verantwortung für eventuelle Schäden, die im Ergebnis des Erhalts der Ware mit anderen als auf den Fotos dargestellten Eigenschaften entstanden sind, übernimmt.

II. Trotz großer Bemühungen seitens TOYA S.A. kann die Firma nicht garantieren, dass die im vorliegenden Katalog enthaltenen Informationen voll der Realität entsprechen.

III. Sämtliche Entscheidungen, die auf der Grundlage der im Sachkatalog enthaltenen Informationen getroffen wurden, gehen auf das Risiko der Person, die diese Informationen benutzt.

## RUS

I. TOYA S.A. заявляет:

- 1) настоящий каталог не является торговым предложением с точки зрения гражданского законодательства;
- 2) изделия, представленные в настоящем каталоге, могут отличаться от образцов на снимках, особенно внешним видом, то есть размером, цветом, способом упаковки, количеством предметов в упаковке;
- 3) производитель не отвечает за мелкие отличия в способе упаковки или свойствах изделий, которые не влияют на предназначение или способ пользования изделиями;
- 4) производитель не отвечает за мелкие неточности в сведениях из предметного каталога;
- 5) производитель не отвечает за ущерб, нанесенный вследствие поставки товара, отличающегося параметрами от указанного на снимках.

II. Несмотря на все усилия в данном направлении, компания TOYA S.A. не гарантирует, что информация, метящаяся в настоящем каталоге, полностью отвечает действительности.

III. Риск, связанный с любыми решениями, принятыми на основании информации из предметного каталога, берут на себя лица, пользующиеся указанной информацией.

## UA

I. Інформація від виробника, TOYA S.A.:

- 1) цей каталог не є комерційною пропозицією з точки зору цивільного законодавства;
  - 2) вироби, представлені у цьому каталозі, можуть відрізнятися від зображень на фотографіях, особливо зовнішнім виглядом, тобто розміром, кольором, способом упаковки, кількістю предметів в упаковці;
  - 3) виробник не несе відповідальність за дрібні відмінності у способі упаковки чи властивостях виробів, які не мають впливу на їх призначення чи спосіб користування ними;
  - 4) виробник не несе відповідальність за дрібні неточності у інформації, включеної у цей каталог;
  - 5) виробник не несе відповідальність за можливі збитки, нанесені внаслідок отримання виробів, що своїми параметрами відрізняються від зображень на фотографіях.
- II. Незважаючи на зусилля у даному напрямку, фірма TOYA S.A. не гарантує, що інформація, включена у цей каталог, повністю відповідає дійсності.

III. Приймаючи будь-які рішення на підставі інформації, включеної у цей каталог, не забувайте, що пов'язаний з ними ризик беруть на себе особи, що використовують включену у каталог інформацію.

## LT

I. TOYA S.A. informuoja, kad:

- 1) šis katalogas nėra civilinės teisės supratimu pasiūlymas;
- 2) rodomos šame kataloge prekės gali tikrumoje skirtis nuo parodyto nuotraukose pavyzdžio, ypač jų išorine išvaizda ir požymiais, t.y. dydžiu, spalva, įpakavimo būdu, elementų kiekiu pakuotėje;
- 3) gamintojas neneša atsakomybės už nereikšmingus skirtumus įpakavime arba gaminio savybėse, kurios neturi įtakos jo paskirčiai arba jo varojimo būdui.
- 4) neneša taip pat atsakomybės dėl bet kokių netikslumų arba nepakankamai preciziškų apibrėžimų pateiktoje kataloge informacijoje.
- 5) neneša atsakomybės už galimai patirtus nuostolius gavus prekę su savybėmis, kurios nėra tapačios su pateiktomis nuotraukose.

II. Nežiūrint geriausių TOYA S.A. pastangų, bendrovė negali garantuoti, kad pateikta šiame kataloge informacija pilnai atitinka tikrovę.

III. Bet kokie sprendimai priimami šiame kataloge pateiktą informaciją pagrindu yra besinaudojančio šia informacija asmens priimami savo paties rizika.

## LV

I. A/S „TOYA“ informē, ka:

- 1) šis katalogs nav piedāvājums civillikuma izpratnē;
- 2) piedāvāti šī katalogā produkti realitātē var atšķirties no rādīta uz fotogrāfijas parauga, sevišķi ārēju īpašību sfērā, t.i. ar lielumu, krāsu, pakošanas veidu, priekšmetu skaitu iepakojumā;
- 3) nav atbildīga par smalkām atšķirībām iepakošanas veidā vai produktu īpašībām, ja tie neietekmē ierīces paredzētu mērķu vai lietošanas veidu;
- 4) nav atbildīga par kaut kādām neprecizitātēm informācijās, kas ir norādītas šī katalogā;
- 5) nav atbildīga par iespējamam zaudējumam, savienotiem ar produkta saņemšanu ar citām īpašībām, nekā rādītas uz fotogrāfijas.

II. Neskatoties uz visaugstāko rūpību, ar kuru A/S „TOYA“ sagatavoja savu katalogu, tā nevar garantēt, ka informācijas šī katalogā pilnīgi atbild realitātei.

III. Visi lēmumi, pieņemti pamatojoties uz informācijas no kataloga - ir pieņemti uz personas, kura lieto šo informāciju, risku.

## CZ

I. TOYA S.A. informuje že:

- 1) tento katalog nepředstavuje nabídku ve smyslu občanského práva;
- 2) výrobky prezentované v tomto katalogu se mohou ve skutečnosti lišit od modelů uvedených na obrázcích, zejména co se týká vnějších znaků, tj. velikosti, barvy, způsobu balení, počtu předmětů v balení;
- 3) nenes odpovědnost za drobné rozdíly ve způsobu balení nebo ve vlastnostech výrobků, které nemají zásadní vliv na jejich určený účel nebo způsob používání;
- 4) nenes odpovědnost vyplývající z jakýchkoli nepřesností co do informací uvedených v předmětném katalogu;
- 5) nenes odpovědnost za případné škody vzniklé v důsledku obdržení zboží s jinými vlastnostmi, než je uvedeno na obrázcích.

II. Navzdory mimořádnému úsilí vynaloženému firmou TOYA S.A. tato nemůže garantovat, zda informace uvedené v tomto katalogu zcela odpovídají skutečnosti.

III. Veškerá rozhodnutí přijatá na základě informací uvedených v předmětném katalogu jsou přijímána na vlastní riziko osoby, která tyto informace využívá.

## SK

I. TOYA S.A. informuje že:

- 1) tento katalog nepredstavuje ponuku v zmysle občianskeho práva;

- 2) výrobky prezentované v tomto katalogu sa v skutočnosti môžu líšiť od modelov zobrazených na obrázkoch, najmä pokiaľ sa jedná o vonkajšie znaky, t.j. veľkosť, farbu, spôsob balenia, počet predmetov v balení;
- 3) nenesie zodpovednosť za drobné rozdiely v spôsobe balenia či vlastnostiach výrobkov, ktoré nemajú zásadný vplyv na ich určený účel alebo spôsob používania;
- 4) nenesie zodpovednosť vyplývajúcu z akejkoľvek nepresnosti týkajúcej sa informácií uvedených v predmetnom katalogu;
- 5) nenesie zodpovednosť za prípadné škody vzniknuté v dôsledku obdržania tovaru s inými vlastnosťami, než je uvedené na obrázkoch.

II. Aj napriek mimoriadnemu úsilíu zo strany firmy TOYA S.A. táto nemôže garantovať, či informácie uvedené v tomto katalogu plne zodpovedajú skutočnosti.

III. Všetky rozhodnutia prijaté na základe informácií uvedených v predmetnom katalogu sú prijímané na vlastné riziko osoby, ktorá tieto informácie využíva.

## H

I. A TOYA S.A. tájékoztatja, hogy:

- 1) a jelen katalógus a polgári jog szerinti nem kereskedelmi ajánlat;
  - 2) a jelen katalógusban bemutatott árucikkek a valóságban eltérhetnek a képeken látható mintától, különösen a külső tulajdonságok, mint a méret, szín, csomagolási mód, a csomagban lévő tárgyak száma tekintetében;
  - 3) nem vállal felelősséget a csomagolás módjában vagy az árucikkek olyan tulajdonságaiban történt változtatásokért, amelyek nem befolyásolják lényeges módon annak rendeltetését vagy a felhasználás módját;
  - 4) nem vállal felelősséget a jelen katalógusban lévő információk pontatlanságáért;
  - 5) nem vállal felelősséget azokért az esetleges károkért, amik az árucikkek a fényképeken látható tulajdonságoktól eltérő tulajdonságokkal történő leszállításából erednek.
- II. A TOYA S.A. minden igyekezete ellenére nem tudja garantálni, hogy a jelen katalógusban

található információk teljes egészében megfelelnek a valóságnak.

III. A tárgyi katalógusban található információk alapján meghozott bármilyen döntés annak a személynek a rizikója, aki ezeket az információkat felhasználja.

## RO

I. TOYA S.A. informează că:

- 1) prezentul catalog nu constituie ofertă în înțelesul dreptului civil;
- 2) articolele prezentate în prezentul catalog se pot diferi față de mostrele din fotografiile, în special aspectul exterior, adică mărimea, culoarea, modul de ambalare, cantitatea obiectelor în ambalaj;
- 3) nu-și asumă răspunderea referitor la mici diferențe la modul de ambalare sau la articolele al căror proprietăți nu au influență referitor la destinația sau modul lor de utilizare;
- 4) nu-și asumă răspunderea referitor la orice inexactitate sau imprecizie, datorită informațiilor cuprinse în catalogul respectiv;
- 5) nu-și asumă răspunderea referitor la o eventuală pagubă ca urmare a primirii marfei cu alte proprietăți decât cele prezentate pe fotografii;

II. Cu toate strădanile TOYA S.A., firma nu poate garanta că, informațiile din prezentul catalog corespund realității;

III. Orice decizie preluată în baza informațiilor cuprinse în catalogul respectiv, sunt preluate pe riscul și răspunderea persoanei care a făcut folos de aceste informații.

## E

I. TOYA S.A. comunica lo siguiente:

- 1) el presente catálogo no constituye una oferta, en el sentido que la noción adquiere en la ley civil;
- 2) los artículos presentados en el presente catálogo pueden en realidad diferir de los modelos indicados en las fotografías, especialmente en cuanto a sus propiedades externas, es decir el tamaño, el color, el empaque o la cantidad de los objetos en el empaque;
- 3) la empresa no se hace responsable por pequeñas diferencias en cuanto al empaque o las propiedades de los artículos, siempre y cuando estas diferencias no afectan el propósito o el modo de operación de las herramientas;
- 4) la empresa no se hace responsable por ninguna imprecisión en cuanto a la información presentada en el presente catálogo;
- 5) la empresa no se hace responsable por ningún daño que surja del hecho de que los artículos recibidos difieran de los artículos presentados en las fotografías en cuanto a sus propiedades.

II. A pesar de los mejores intentos de parte TOYA S.A. la empresa no puede garantizar que la información presentada en el presente catálogo corresponda completamente a la realidad.

III. Todas las decisiones tomadas en base a la información presentada en el presente son responsabilidad de la persona que recurra a la dicha información.

Memo



**REG-707**  
Branded rack YATO 100 cm /  
Regał firmowy YATO 100 cm



**REG-777**  
Hangers set for power tools YATO /  
Zestaw zawieszni na elektronarzędzia YATO



Hangers set for power tools YATO 18 V /  
Zestaw zawieszni na elektronarzędzia YATO 18 V



**REG-918**  
Display for sanding paper YATO in rolls /  
Ekspozytor na papier ścierny YATO w rolkach



**REG-919**  
Display for sanding paper YATO in sheets /  
Ekspozytor na papier ścierny YATO w arkuszach



**REG-908**  
Standing display for YATO rectifiers /  
Ekspozytor stojący na prostowniki YATO



**REG-925**  
Display for YATO work clothes /  
Ekspozytor na ubrania robocze YATO



**REG-603**  
Rotary display rack YATO /  
Ekspozytor obrotowy YATO



Standing triangular display  
for YATO sets /  
Trójstronny ekspozytor stojący  
na zestawy YATO



**REG-763**  
Standing display for YATO shoes /  
Ekspozytor stojący na buty YATO



**REG-977**  
Chrome tube mannequin /  
Manekin z rury chromowej



**REG-764**  
Standing display  
for YATO levels /  
Ekspozytor stojący  
na poziomice YATO



**REG-708**  
Branded rack VOREL 100 cm /  
Regał firmowy VOREL 100 cm



Standing display for window seals VOREL /  
Ekspozytor stojący na uszczelki do okien VOREL



**REG-954**  
Display for ropes /  
Ekspozytor na liny



**REG-706**  
Branded rack STHOR 100 cm /  
Regał firmowy STHOR 100 cm



**REG-709**  
Branded rack FLO 100 cm /  
Regał firmowy FLO 100 cm

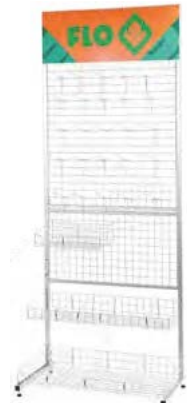

**REG-715**  
Mesh display rack FLO 230 cm /  
Regał siatkowy FLO 230 cm



**REG-147**  
Kitchen faucet display rack FALA /  
Ekspozytor na baterie kuchenne FALA



**REG-146**  
Bath faucet display rack FALA /  
Ekspozytor na baterie łazienkowe FALA



**REG-149**  
Stand for linear drains FALA /  
Ekspozytor na odpływy liniowe FALA



**REG-808**  
Display for wave toilet seats FALA /  
Ekspozytor na deski toaletowe FALA





**REG-992**  
Display rack for REG-707 for pipe wrenches YATO /  
Ekspozytor do REG-707 na klucze do rur YATO



**REG-994**  
Display rack for REG-707 for YATO bits /  
Ekspozytor do REG-707 na nasadki YATO



**REG-994P**  
Display rack with the lid for REG-707 for YATO bits /  
Ekspozytor z pokrywą do REG-707 na nasadki YATO



**REG-998**  
Display rack for REG-707 for YATO hammers /  
Ekspozytor do REG-707 na młotki YATO



**REG-993**  
Display rack for REG-707 for YATO pneumatic tools /  
Ekspozytor do REG-707 na narzędzia pneumatyczne YATO



**REG-951**  
Display for carpentry clamps /  
Ekspozytor na ściski stolarskie



**REG-804**  
Tag for YATO shoes / Zawieszka na buty YATO



**REG-991**  
Display rack for REG-707 for YATO disc saws /  
Ekspozytor do REG-707 na piły tarczowe YATO



**REG-952**  
Display for the disc for disc cutters /  
Ekspozytor na tarcze do szlifierek kątowych



**REG-761**  
Hook for axes / Wieszak na siekiery



**REG-930**  
Display for YATO buck saws /  
Ekspozytor na piły kabłąkowe YATO



**REG-909**  
Display stand for FLO garden tools /  
Ekspozytor na narzędzia ogrodowe FLO



**REG-868**  
Hook 30 cm for trowels / Hak 30 cm na kielnie



**REG-144**  
Pendant for wall mounted faucet FALA /  
Zawieszka na baterię ścienną FALA



**REG-145**  
Pendant for deck mounted faucet FALA /  
Zawieszka na baterię stojącą FALA



**REG-911**  
Pallet display for garden tools /  
Ekspozytor paletowy na narzędzia ogrodnicze



**REG-799**  
Display stand VOREL /  
Display ekspozycyjny VOREL



**REG-902**  
Standing display for YATO sockets /  
Ekspozytor stojący na nasadki YATO



**REG-807**  
Display box for STHOR drill bits /  
Ekspozytor skrzynka na wiertła STHOR



**REG-604**  
Wall-stand display rack YATO /  
Ekspozytor stojąco-wiszący YATO



**REG-605**  
Waterfall display rack YATO /  
Ekspozytor kaskadowy YATO











































**REG-705**  
Advertising wobler YATO /  
Wobler reklamowy YATO



**REG-803**  
YATO wrench tester /  
Tester kluczy YATO



**REG-711**  
Rack shelf for REG-707 YATO /  
Półka do REG-707 YATO

	Colour box		Sleeve
	Box with colour label		White sleeve with label
	PVC colour box		Carton envelope
	Box		Bulk
	Display colour box		Plastic holder
	Hanging colour box		Flag tied on card
	Blister card		Metal box
	Double blister card		Metal box with colour label
	Double blister transparent		Metal box with sleeve
	Half double blister card		Plastic box
	Sliding card		Plastic box with colour sleeve
	Plastic hanger		Plastic case with colour label
	Hanging card		Plastic case with label
	Header card		Plastic case with colour sleeve
	Tied on card		Plastic tube with colour label
	Skin card		Metal clip
	Polybag with header card		Wooden box with sleeve
	Polybag		Pouch
	Printed polybag		Shrink card / Plastic tray
	Polybag with hanger		Nylon case

FALA linear drains create unlimited possibilities for arranging your bathroom!  
 Odpływy liniowe FALA stwarzają nieograniczone możliwości w aranżacji Twojej łazienki!



**INOX**  
 STAINLESS  
 STEEL

White Glass  
**75381** – 60 cm  
**75382** – 70 cm  
**75383** – 80 cm  
**75384** – 90 cm

Black Glass  
**75386** – 60 cm  
**75387** – 70 cm  
**75388** – 80 cm  
**75389** – 90 cm

Olimp  
**75421** – 60 cm  
**75422** – 70 cm  
**75423** – 80 cm  
**75424** – 90 cm

Line  
**75448** – 60 cm  
**75449** – 70 cm  
**75450** – 80 cm  
**75451** – 90 cm

It can prevent stink and worms both in use and after dry.

Zapobiega przedostawaniu się zapachów oraz robaków podczas używania, jak i po wysuszeniu.



**WET&DRY**

Efficient and durable screen prevents siphon trap from clogging up.

Skuteczne i trwałe sito zapobiega zapychaniu syfonu.



**STRAINER**

Easy cleaning due to a hook included in the delivery.

Łatwe do utrzymania w czystości dzięki dołączonemu haczykowi.



**EASYclean**

Top-quality precise welded joints warrant drain tightness.

Wysokiej jakości precyzyjne spawy gwarantują szczelność odpływu.



**HQwelding**

Holders stabilising the body. Additional rigidity through structure supports.

Uchwyty stabilizujące korpus. Dodatkowe usztywnienie konstrukcji w podłodze.



**GRIPstrong**

Low siphon trap, made of AISI 304 stainless steel, easy to install.

Niski syfon wykonany ze stali nierdzewnej AISI 304 ułatwia instalację.



**EXTRAslim**

Sealing mat included in delivery – necessary in case hydroisolation is to be applied.

Mata uszczelniająca w zestawie – niezbędna część przy wykonywaniu hydroizolacji.



**HYDRocloth**

Extensive height regulation which enables the drain to be adjusted against the floor level.

Szeroki zakres regulacji wysokości umożliwia dopasowanie odpływu do powierzchni posadzki.



**EASYfix**





MANUFACTURER / PRODUCENT

TOYA S.A.  
ul. Sołtysowicka 13-15  
51-168 Wrocław  
☎ (+48 71) 32 46 200  
fax: (+48 71) 32 46 370  
sales@yato.pl (sale)  
export@yato.pl (export)  
import@yato.pl (import)

ODDZIAŁ WARSZAWSKI  
Teren Mapletree Park Nadarzyn  
al. Kasztanowa 160  
05-831 Młochów k. Warszawy  
☎ (+48 22) 73 82 800  
☎ (+48 22) 73 82 828  
sales@yato.pl (sale)  
export@yato.pl (export)

TOYA ROMANIA S.A.  
Șos. Stefănești, 8-8A,  
Stefăneștii De Jos, Ilfov  
☎ (+40 031) 710 8692  
office@yato.ro

YATO TOOLS (SHANGHAI) CO., LTD.  
No. 1, Lane 1300, East Kangqiao Road  
Shanghai, China 201315  
☎ (+86 21) 681 829 50  
fax: (+86 21) 681 829 51  
yato@yato-sh.com

YATO TOOLS (JIAXING) CO., LTD.  
No.1033 Huyan Road, Baibu Town,  
Haiyan County, Jiaxing City, Zhejiang Province, China  
☎ (+86 21) 681 829 50  
yato@yato-sh.com

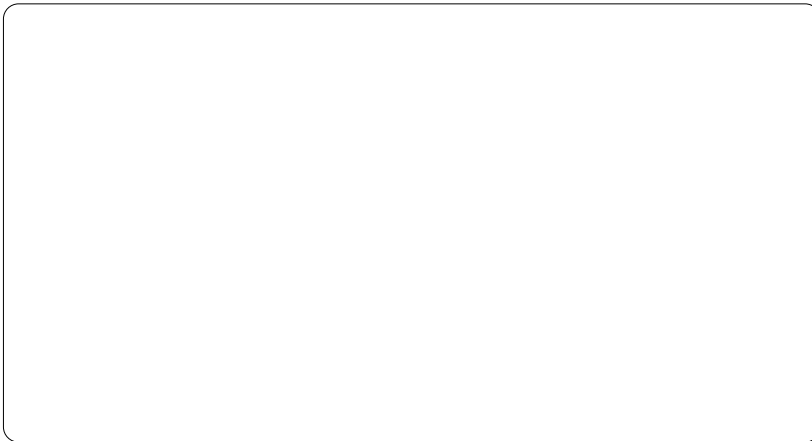

YOUR TRUSTED SUPPLIER / TWÓJ ZAUFANY DOSTAWCA



GET ACQUAINTED WITH OUR WIDE OFFER /  
ZOBACZ NASZĄ BOGATĄ OFERTĘ

