

YATO

2025





www.yato.com

Gas-powered garden equipment is indispensable for maintaining extensive green areas. Their robust construction and high power enable efficient operation even in challenging conditions, such as uneven terrain or dense vegetation. The versatility of these tools, combined with their ease of use, makes them a popular choice among both homeowners with private gardens and professionals specializing in green space maintenance.

Ogrodowe urządzenia spalinowe są niezastąpione w pielęgnacji rozległych terenów zielonych. Solidna konstrukcja i duża moc pozwalają na efektywną pracę w trudnych warunkach, takich jak nierówny teren czy gęsta roślinność. Uniwersalność tych urządzeń, połączona z łatwością obsługi, sprawia, że są one chętnie wybierane zarówno przez właścicieli przydomowych ogrodów, jak i profesjonalistów zajmujących się utrzymaniem zieleni.



YT-85520
2,1 kW
2,86 KM



YT-85521
2,1 kW
2,86 KM



YT-85525
2,4 kW
3,26 KM



YT-85528
3,5 kW
4,76 KM



YT-85532
3,5 kW
4,76 KM



YT-85533
4,5 kW
6,12 KM



YT-85537
4,5 kW
6,12 KM



YT-85545
3,5 kW
4,76 KM



YT-85570
4,1 kW
5,58 KM

więcej na stronach:
more on pages:
575-576



YATO mobile power stations are perfect wherever traditional energy sources are unavailable. Whether it's a power outage at home, a camping trip, an outdoor concert, or working in the open air, you can connect up to 11 devices directly, ensuring reliable energy whenever you need it!

Mobilne stacje zasilania YATO świetnie sprawdzą się wszędzie tam, gdzie nie ma dostępu do tradycyjnych źródeł energii. Idealne podczas awarii prądu, na camping czy przy pracy na świeżym powietrzu. Podłączysz do nich bezpośrednio nawet 11 urządzeń, zapewniając sobie energię w każdej sytuacji!

YT-83090

300 W
315 Wh

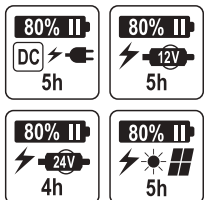

YT-83092

1200 W
917 Wh

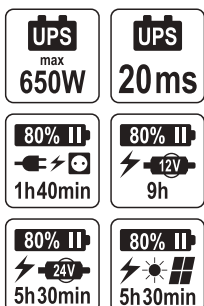

YT-83091

600 W
504 Wh

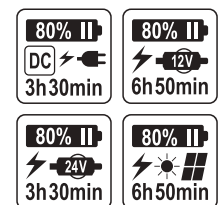

1

SPANNERS / KLUCZE

6-19



2

SOCKETS, ACCESSORIES & SETS / KLUCZE NASADOWE, AKCESORIA I ZESTAWY

20-61



3

IMPACT SOCKETS, ACCESSORIES & SETS / UDAROWE KLUCZE NASADOWE, AKCESORIA I ZESTAWY

62-71



4

TORQUE WRENCHES & TORQUE MULTIPLIERS / KLUCZE DYNAMOMETRYCZNE I WZMACNIACZE MOMENTU

72-77



5

SCREWDRIVERS & SCREWDRIVER BITS / WKRĘTAKI I KOŃCÓWKI WKRĘTAKOWE

78-105

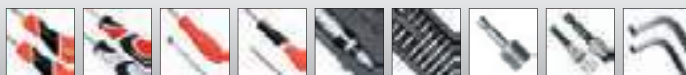

6

PLIERS / SZCZYPCE

106-119



7

ELECTRICIAN TOOLS / NARZĘDZIA DLA ELEKTRYKÓW

120-141

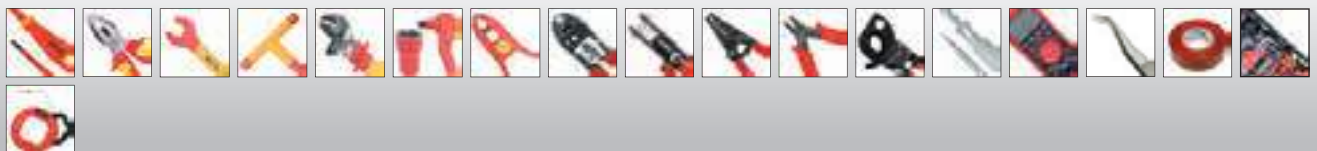

8

HAMMERS, CHISELS, PUNCHES & AXES / MŁOTKI, DŁUTA, PRZECINAKI I SIEKIERY

142-155



9

CLAMPS, VICES & HOLDERS / ŚCISKI, IMADŁA I WSPORNIKI

156-161



10

CUTTING TOOLS / NARZĘDZIA TNĄCE

162-245

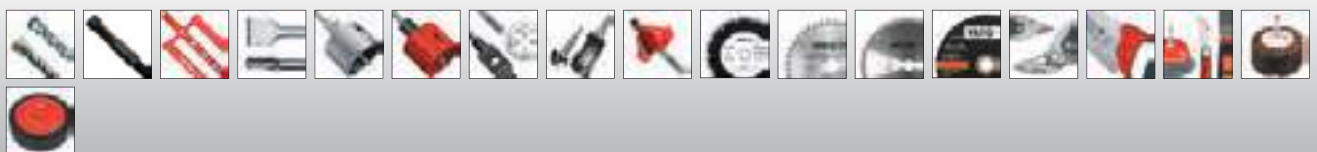

11

PLUMBING TOOLS / NARZĘDZIA HYDRAULICZNE

246-263

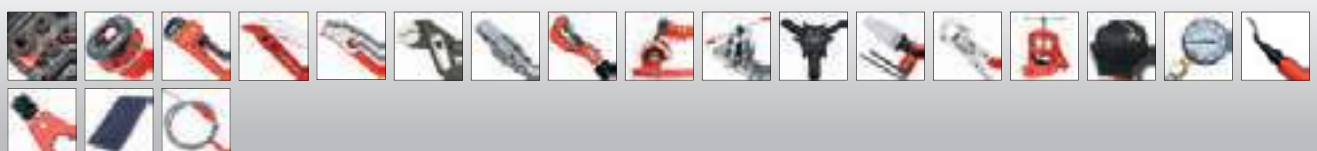

12

FASTENING TOOLS / NARZĘDZIA DO ŁĄCZENIA

264-285



13

CONSTRUCTION TOOLS / NARZĘDZIA BUDOWLANE

286-313

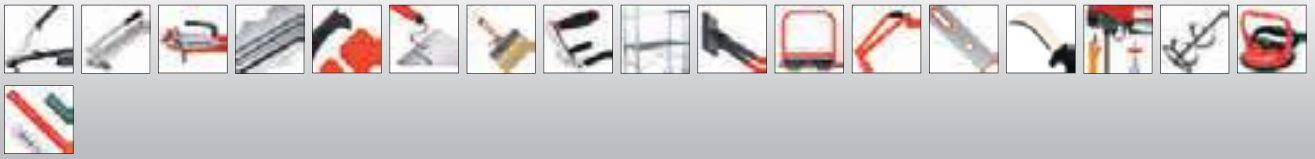

14

MEASURING TOOLS / NARZĘDZIA MIERNICZE

314-329



15

PNEUMATIC TOOLS / NARZĘDZIA PNEUMATYCZNE

330-353



16

SPECIAL AUTOMOTIVE TOOLS & EQUIPMENT / NARZĘDZIA I WYPOSAŻENIE WARSZTATU SAMOCHODOWEGO

354-505

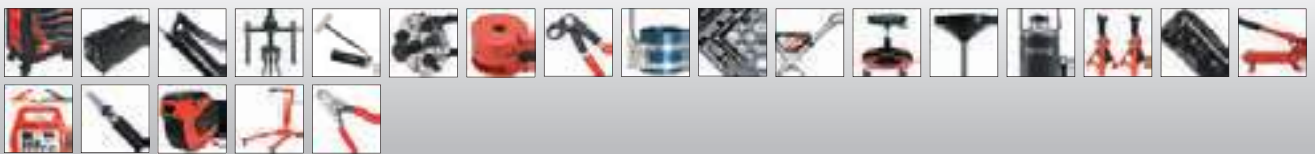

17

WELDING EQUIPMENT & ACCESSORIES / NARZĘDZIA SPAWALNICZE I AKCESORIA

506-513



18

POWER & GASOLINE TOOLS / ELEKTRONARZĘDZIA I NARZĘDZIA SPALINOWE

514-587



19

ACCESSORIES / AKCESORIA

588-603



20

HEALTH & SAFETY ARTICLES / ARTYKUŁY BHP

604-633

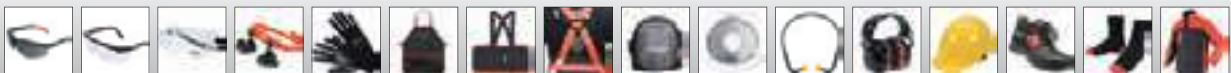

21

ELECTRIC PRODUCTS / ARTYKUŁY ELEKTRYCZNE

634-653



22

GARDEN TOOLS / NARZĘDZIA OGRODNICZE















654-669



1

Spanners
Klucze



Combination spanners Klucze płasko-oczkowe	8-9		Half-moon spanners Klucze oczkowe typu „C”	15	
Combination spanners & sets, polished head Klucze płasko-oczkowe i zestawy, polerowana główka	8		Flare nut wrenches & sets Klucze oczkowe półotwarte i zestawy	15	
Stubby combination spanners, polished head Klucze płasko-oczkowe krótkie, polerowana główka	9		Torx ring spanner sets Zestawy kluczy oczkowych „Torx”	15	
Combination ratchet wrenches Klucze płasko-oczkowe z grzechotką	9-11		Torx type double head flexible wrenches & sets Klucze przegubowe „Torx” i zestawy	16	
Combination ratchet wrenches & sets Klucze płasko-oczkowe z grzechotką i zestawy	9		L-type socket wrenches Klucze nasadowe typu „L”	16	
Flexible ratchet combination wrenches & sets Klucze płasko-oczkowe z grzechotką i przegubem i zestawy	11		Double ratchet wrenches Dwustronne klucze nasadowe z grzechotką	17	
X-handle combination wrenches Klucze płasko-oczkowe skręcone	11-12		T-type socket wrenches Klucze nasadowe typu „T”	17-18	
X-handle combination wrenches & sets Klucze płasko-oczkowe skręcone i zestawy	11		Socket wrenches with handle Klucze nasadowe z rękojeścią	17	
X-handle combination ratchet wrenches Klucze płasko-oczkowe skręcone z grzechotką	12		T-type deep socket wrenches with rotary handle Klucze nasadowe typu „T” z obrotową rączką	17	
Double open end spanners Klucze płaskie	12		T-type adapters with rotary handle Adaptery typu „T” z obrotową rączką	17	
Double open end spanners & sets, polished head Klucze płaskie i zestawy, polerowana główka	12		T-type deep socket wrenches Klucze nasadowe typu „T”	18	
Double ratchet spanner sets Zestawy kluczy oczkowych z grzechotką	13		T-handle swivel socket wrenches Klucze nasadowe typu „T” z przegubem	18	
Bi-hexagonal ring spanners Klucze oczkowe odgięte	13-14		Adjustable wrenches Klucze nastawne	19	
Bi-hexagonal ring spanners & sets, polished head Klucze oczkowe odgięte i zestawy, polerowana główka	13		Flexible hook wrenches Klucze hakowe	19	
Combination ratchet wrenches Klucze oczkowe odgięte z grzechotką	14				
Impact wrenches Klucze do pobijania	14				
Ring impact wrenches Klucze oczkowe do pobijania	14				
Open end impact wrenches Klucze płaskie do pobijania	14				

EN Combination spanner
 PL Klucz płasko-oczkowy
 DE Ringmaulschlüssel
 RU Ключ комбинированный
 CZ Klíč očkoplochy
 HU Csillag-villás kulcs
 RO Cheie combinată
 FR Clé mixte
 IT Chiave combinata
 ES Llave combinada
 CN 两用扳手



DIN 3113 CrV
 AS-DRIVE

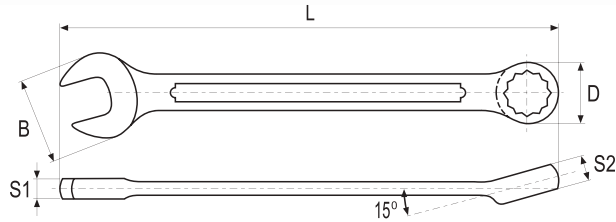

- Application: workshop
- Head offset: 15°
- Surface finish: chromed, satin
- Przeznaczenie: warsztat
- Kąt odchylenia główek: 15°
- Wykończenie powierzchni: chromowana, satynowa

YATO	Ø [mm]	L [mm]	B [mm]	D [mm]	S1 [mm]	S2 [mm]	PCS	ROBIE
YT-0335	6	110	14.8	10.5	3.7	4.9	10	300/600
YT-0336	7	120	16.1	11.3	4.0	5.3	10	300/600
YT-0337	8	130	18.5	12.9	4.2	5.0	10	180/360
YT-0338	9	140	20.5	14.6	4.2	5.0	10	180/360
YT-0339	10	150	22.2	16.2	4.9	6.4	10	180/360
YT-0340	11	160	25.5	17.3	4.9	7.0	10	180/360
YT-0341	12	170	26.7	18.7	5.3	7.6	10	120/240
YT-0342	13	180	28.0	19.6	5.5	8.2	10	120/240
YT-0343	14	190	30.3	21.4	5.9	7.7	10	50/100
YT-0344	15	200	32.8	22.8	6.2	8.5	10	50/100
YT-0345	16	210	33.9	23.7	6.1	9.1	10	50/100
YT-0346	17	220	35.9	24.7	6.5	9.1	10	50/100
YT-0347	18	230	37.8	26.9	6.9	10.0	10	50/100

YATO	Ø [mm]	L [mm]	B [mm]	D [mm]	S1 [mm]	S2 [mm]	PCS	ROBIE
YT-0348	19	235	38.9	27.7	7.0	10.1	10	50/100
YT-0349	20	250	41.4	29.2	7.3	11.0	10	40/80
YT-0350	21	260	43.4	31.0	7.1	10.9	10	40/80
YT-0351	22	270	45.9	32.2	8.1	11.2	5	20/40
YT-0352	23	280	47.8	34.3	7.8	11.1	5	20/40
YT-0353	24	290	49.9	34.8	9.2	11.2	5	20/40
YT-0354	25	300	51.2	36.6	9.2	12.4	5	20/40
YT-0355	26	310	53.2	37.4	9.2	12.9	5	20/40
YT-0356	27	320	55.9	39.3	9.3	12.7	5	15/30
YT-0357	28	330	56.5	40.9	9.9	13.5	5	15/30
YT-0358	29	340	60.0	42.4	10.0	13.6	5	15/30
YT-0359	30	350	60.9	43.8	10.0	14.7	5	10/20
YT-0360	32	370	64.5	46.6	11.3	14.9	5	10/20

EN Combination spanner
 PL Klucz płasko-oczkowy
 DE Ringmaulschlüssel
 RU Ключ комбинированный
 CZ Klíč očkoplochy
 HU Csillag-villás kulcs
 RO Cheie combinată
 FR Clé mixte
 IT Chiave combinata
 ES Llave combinada
 CN 两用扳手



AS-DRIVE

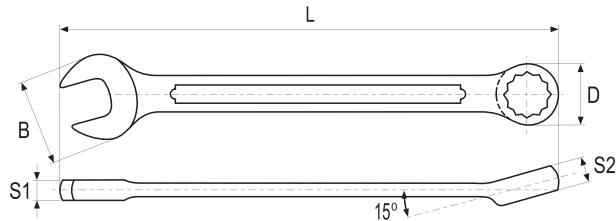

- Application: workshop
- Head offset: 15°
- Surface finish: chromed, satin
- Przeznaczenie: warsztat
- Kąt odchylenia główek: 15°
- Wykończenie powierzchni: chromowana, satynowa

YATO	Ø [mm]	L [mm]	B [mm]	D [mm]	S1 [mm]	S2 [mm]	PCS	ROBIE
YT-00760	34	425	65.2	51.0	13.0	16.0	5	5/20
YT-00761	36	460	73.0	57.0	14.0	17.5	5	5/15
YT-00762	38	460	73.0	57.0	14.0	17.5	5	5/15
YT-00763	41	500	83.0	61.5	15.0	19.0	5	5/10
YT-00764	46	540	88.3	69.0	16.5	21.0	5	5/10

YATO	Ø [mm]	L [mm]	B [mm]	D [mm]	S1 [mm]	S2 [mm]	PCS	ROBIE
YT-00765	48	570	92.0	72.0	16.5	22.0	5	5/10
YT-00766	50	598	96.0	74.0	18.0	23.5	2	2/8
YT-00767	55	620	105.6	82.4	19.0	25.0	2	2/6
YT-00768	60	660	115.2	89.8	21.0	27.0	2	2/6
YT-00769	65	680	124.8	97.3	23.0	29.0	2	2/4

EN Combination spanner set
 PL Zestaw kluczy płasko-oczkowych
 DE Maul-Ringschlüssel-Satz
 RU Набор комбинированных ключей
 CZ Sada očkoplochyh klíčů
 HU Csillag-villáskulcs készlet
 RO Set chei combinate
 FR Jeu de clés mixtes
 IT Set chiavi combinate
 ES Juego de llaves combinadas
 CN 两用扳手组套

DIN 3113 CrV
 AS-DRIVE



12 PCS



17 PCS



25 PCS

YATO	Ø [mm]	PCS
YT-0362	8, 9, 10, 11, 12, 13, 14, 15, 17, 19, 22, 24	6

YATO	Ø [mm]	PCS
YT-0363	8, 9, 10, 11, 12, 13, 14, 15, 16, 17, 18, 19, 22, 24, 27, 30, 32	3

YATO	Ø [mm]	PCS
YT-0365	6, 7, 8, 9, 10, 11, 12, 13, 14, 15, 16, 17, 18, 19, 20, 21, 22, 23, 24, 25, 26, 27, 28, 30, 32	3

EN Stubby combination spanner
 PL Klucz płasko-oczkowy krótki
 DE Ringmaulschlüssel kurz
 RU Ключ комбинированный короткий
 CZ Klíč očkoločný krátký
 HU Rövid csillag-villás kulcs
 RO Cheie combinată scurtă
 FR Clé mixte courte
 IT Chiave combinata corta
 ES Llave combinada corta
 CN 两用短扳手



CrV AS-DRIVE

1

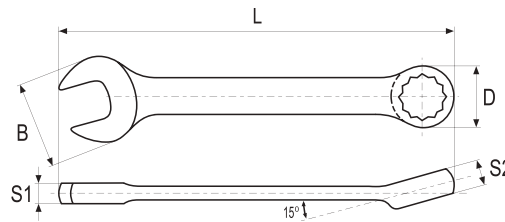

• Application: workshop
 • Head offset: 15°
 • Surface finish: chromed

• Przeznaczenie: warsztat
 • Kąt odchylenia główki: 15°
 • Wykończenie powierzchni: chromowana

YATO	Ø [mm]	L [mm]	B [mm]	D [mm]	S1 [mm]	S2 [mm]	PCS ROBE	Box
YT-4901	8	91	19.2	13.9	5.0	6.3	10	120/240
YT-4902	9	97	21.7	16.4	5.4	6.4	10	120/240
YT-4903	10	97	21.9	16.6	5.2	6.4	10	120/240
YT-4904	11	100	23.2	18.3	5.9	7.2	10	120/240
YT-4905	12	108	27.4	20.2	6.4	7.6	10	120/240
YT-4906	13	109	27.9	20.7	6.7	7.7	10	120/240

YATO	Ø [mm]	L [mm]	B [mm]	D [mm]	S1 [mm]	S2 [mm]	PCS ROBE	Box
YT-4907	14	115	29.3	22.1	6.1	8.3	10	60/120
YT-4908	15	120	31.2	24.0	6.8	9.6	10	60/120
YT-4909	16	121	32.0	24.3	6.8	9.6	10	60/120
YT-4910	17	128	36.6	27.1	7.4	9.9	10	60/120
YT-4911	18	127	36.2	26.8	7.4	9.9	10	60/120
YT-4912	19	135	39.2	19.5	8.8	10.8	10	60/120

EN Stubby ratchet combination spanner set
 PL Zestaw kluczy płasko-oczkowych krótkich z grzechotką
 DE Kurzes Ratschen-Ringmaulschlüssel-Satz
 RU Набор комбинированных коротких ключей с трещоткой
 CZ Sada krátkých očkoločných klíčů s ráčnou
 HU Rövid lapos- és racsnis kulcs készlet
 RO Set chei combinate scurte cu clichet
 FR Jeu de clés mixtes à cliquet courtes
 IT Set chiavi combinate corte con cricchetto
 ES Juego de llaves combinadas cortas con carraca
 CN 扳手组套



8
PCS

70T

CrV HRC
42-46

AS-DRIVE

YATO	Ø [mm]	Box
YT-49123	10, 11, 12, 13, 14, 15, 17, 19	20

EN Combination ratchet wrench
 PL Klucz płasko-oczkowy z grzechotką
 DE Ratschen-Ringmaulschlüssel
 RU Ключ комбинированный с трещоткой
 CZ Klíč očkoločný ráčnový
 HU Csillag-villás kulcs racsnis
 RO Cheie combinată cu clichet
 FR Clé mixte à cliquet
 IT Chiave combinata a cricchetto
 ES Llave combinada con carraca
 CN 棘轮两用扳手



72T CrV
6140

AS-DRIVE

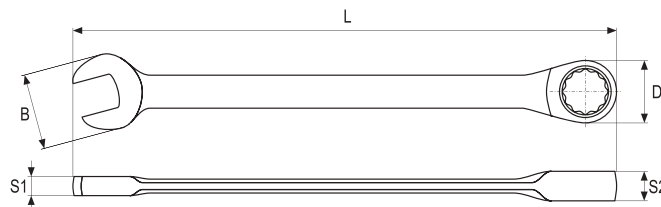

• Application: service
 • 72 teeth ratchet
 • Minimum operation angle: 5°
 • Surface finish: chromed, mirror

• Przeznaczenie: serwis
 • Grzechotka 72 zębów
 • Minimalny kąt pracy: 5°
 • Wykończenie powierzchni: chromowana, polerowana

YATO	Ø [mm]	L [mm]	B [mm]	D [mm]	S1 [mm]	S2 [mm]	PCS ROBE	Box
YT-01906	6	120	14.7	18.0	4.0	6.5	10	50/100
YT-01907	7	130	16.2	18.0	4.3	7.0	10	50/100
YT-01908	8	141	17.6	18.2	4.8	7.2	10	50/100
YT-01909	9	151	19.4	20.4	4.8	7.4	10	50/100
YT-0191	10	160	22.1	22.2	6.0	7.8	10	50/100
YT-0192	11	165	24.7	24.2	6.6	8.5	10	50/100
YT-0193	12	170	26.4	25.5	6.7	8.9	10	50/100
YT-0194	13	180	27.5	26.7	6.6	9.2	10	50/100
YT-0195	14	190	30.8	29.0	7.4	9.4	10	50/100
YT-0196	15	200	32.9	30.8	7.7	10.1	10	50/100
YT-0197	16	210	34.3	31.5	7.8	10.3	10	50/100

YATO	Ø [mm]	L [mm]	B [mm]	D [mm]	S1 [mm]	S2 [mm]	PCS ROBE	Box
YT-0198	17	225	36.8	33.6	8.4	10.6	10	50/100
YT-0199	18	235	39.2	35.6	9.1	10.8	10	50/100
YT-0200	19	245	40.1	37.3	9.5	11.3	10	50/100
YT-0189	21	290	45.2	43.0	9.9	13.3	6	30/60
YT-0201	22	290	45.6	44.2	10.5	13.4	6	24/48
YT-0202	24	335	52.8	50.0	11.3	14.5	6	48
YT-0203	25	335	52.0	47.4	10.2	14.3	6	48
YT-0204	27	355	55.6	52.7	10.9	15.7	6	30
YT-0205	30	400	62.5	57.7	12.2	17.1	6	24
YT-0206	32	420	65.0	61.7	13.2	17.9	6	24

- EN Combination ratchet wrench set
- PL Zestaw kluczy płasko-oczkowych z grzechotką
- DE Ratschen-Ringmaulschlüssel-Satz
- RU Набор комбинированных ключей с трещоткой
- CZ Sada oškoplochých ráčnových klíčů
- HU Racsnis csillag-villás kulcs készlet
- RO Set chei combinate cu clichet
- FR Jeu de clés mixtes à cliquet
- IT Set chiavi combinate a cricchetto
- ES Juego de llaves combinadas con carraca
- CN 棘轮两用扳手套



7
PCS

72T

CrV
6140

AS-DRIVE

YATO	Ø [mm]	
YT-0208	10, 12, 13, 14, 15, 17, 19	10/20

- EN Combination ratchet wrench
- PL Klucz płasko-oczkowy z grzechotką
- DE Ratschen-Ringmaulschlüssel
- RU Ключ комбинированный с трещоткой
- CZ Klíč oškoplochý ráčnový
- HU Csillag-villás kulcs racsnis
- RO Cheie combinată cu clichet
- FR Clé mixte à cliquet
- IT Chiave combinata a cricchetto
- ES Llave combinada con carraca
- CN 棘轮两用扳手



72T

CrV

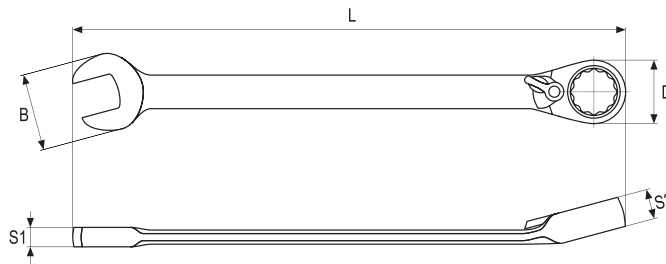

YATO	Ø [mm]	L [mm]	B [mm]	D [mm]	S1 [mm]	S2 [mm]	PCS	
YT-1651	8	140	17.5	19.0	6.0	7.2	10	50/100
YT-1652	9	150	19.8	20.7	6.4	7.5	10	50/100
YT-1653	10	160	22.1	23.1	6.4	7.9	10	50/100
YT-1654	11	165	23.9	25.0	6.6	8.4	10	50/100
YT-1655	12	170	27.1	26.0	6.5	8.9	10	50/100
YT-1656	13	180	27.9	27.6	7.1	9.1	10	50/100
YT-1657	14	190	31.6	28.3	7.3	9.5	10	50/100
YT-1658	15	200	32.8	31.4	8.1	9.8	10	50/100
YT-1659	16	210	33.9	32.9	8.4	10.3	10	50/100
YT-1660	17	225	38.0	34.5	8.7	10.5	10	50/100
YT-1661	18	235	39.8	36.9	9.3	10.7	10	50/100

YATO	Ø [mm]	L [mm]	B [mm]	D [mm]	S1 [mm]	S2 [mm]	PCS	
YT-1662	19	245	41.8	38.3	9.5	11.3	10	50/100
YT-1663	20	245	41.9	38.1	9.7	11.4	6	30/60
YT-1664	21	290	44.9	43.0	9.8	13.6	6	30/60
YT-1665	22	290	44.8	43.8	10.0	13.6	6	30/60
YT-1666	23	290	44.9	43.3	10.3	13.7	6	24/48
YT-1667	24	330	52.0	49.4	10.2	14.5	6	24/48
YT-1669	26	360	56.3	53.6	12.1	15.7	6	30
YT-1670	27	360	55.6	52.9	12.2	16.1	6	30
YT-1671	28	360	56.1	53.6	12.6	16.0	6	24
YT-1672	30	400	62.1	58.0	11.9	17.2	6	24
YT-1673	32	420	64.1	62.0	12.9	17.7	6	24

- EN Combination ratchet wrench set
- PL Zestaw kluczy płasko-oczkowych z grzechotką
- DE Ratschen-Ringmaulschlüssel-Satz
- RU Набор комбинированных ключей с трещоткой
- CZ Sada oškoplochých ráčnových klíčů
- HU Racsnis csillag-villás kulcs készlet
- RO Set chei combinate cu clichet
- FR Jeu de clés mixtes à cliquet
- IT Set chiavi combinate a cricchetto
- ES Juego de llaves combinadas con carraca
- CN 棘轮两用扳手套



12
PCS

72T

HRC
42-49

CrV

AS-DRIVE

YATO	Ø [mm]	
YT-16505	8, 9, 10, 11, 12, 13, 14, 15, 16, 17, 18, 19	10

- EN Flexible ratchet combination wrench
- PL Klucz płasko-oczkowy z grzechotką i przegubem
- DE Ratschenringmaulschlüssel
- RU Ключ комбинированный трещоточный с карданом
- CZ Klíč očkoplochý ráčnový s kloubem
- HU Csuklós racsnis csillag-villáskulcs
- RO Cheie combinată cu clichet și cap flexibil
- FR Clé mixte à cliquet articulée
- IT Chiave combinata a cricchetto con testa flessibile
- ES Llave combinada de cabeza flexible con carraca
- CN 活头棘轮两用扳手

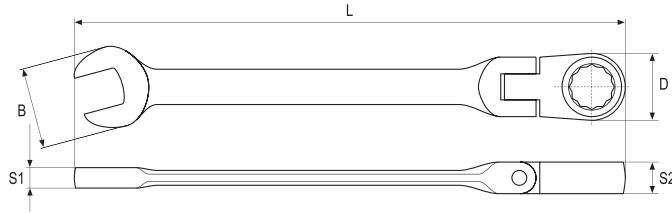
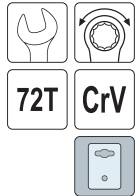

YATO	Ø [mm]	L [mm]	B [mm]	D [mm]	S1 [mm]	S2 [mm]	PCS ROTE	Box
YT-1674	8	140	18.0	19.6	6.3	7.3	10	50/100
YT-1675	9	145	19.7	21.1	4.7	7.6	10	50/100
YT-1676	10	160	22.8	23.2	6.3	7.8	10	50/100
YT-1677	11	160	24.0	24.7	5.4	8.5	10	50/100
YT-1678	12	170	26.4	26.7	6.8	8.8	10	50/100
YT-1679	13	180	28.4	27.3	7.2	9.1	10	50/100
YT-1680	14	185	29.5	28.7	6.8	9.4	10	50/100
YT-1681	15	195	32.9	30.8	7.2	9.8	10	50/100

YATO	Ø [mm]	L [mm]	B [mm]	D [mm]	S1 [mm]	S2 [mm]	PCS ROTE	Box
YT-1682	16	210	34.4	33.3	7.6	10.3	10	50/100
YT-1683	17	230	36.7	35.7	8.3	10.5	10	50/100
YT-1684	18	235	39.0	35.9	8.0	10.8	10	50/100
YT-1685	19	245	40.8	37.6	9.5	11.2	10	50/100
YT-1686	20	245	40.9	38.2	8.8	11.1	6	30/60
YT-1687	21	290	45.0	42.8	9.8	13.6	6	30/60
YT-1688	22	290	45.2	42.7	9.8	13.5	6	30/60
YT-1690	24	330	51.3	48.7	10.4	14.5	6	24/48

- EN Flexible ratchet combination wrench set
- PL Zestaw kluczy płasko-oczkowych z grzechotką i przegubem
- DE Gelenk Ratschen-Ring-Maulschlüssel Satz
- RU Набор ключей комбинированных трещоточных с карданом
- CZ Sada očkoplochých ráčnových klíčů s kloubem
- HU Csuklós racsnis csillag-villáskulcs készlet
- RO Set chei combinate flexible cu clichet
- FR Jeu de clés mixtes à cliquet articulée
- IT Set chiavi combinate a cricchetto e testa flessibile
- ES Juego de llaves combinadas con carraca de cabeza flexible
- CN 活头棘轮扳手套



YATO	Ø [mm]	Box
YT-16973	8, 9, 10, 11, 12, 13, 14, 15, 16, 17, 18, 19	10

- EN Combination spanner
- PL Klucz płasko-oczkowy
- DE Ringmaulschlüssel
- RU Ключ комбинированный
- CZ Klíč očkoplochý
- HU Csillag-villás kulcs
- RO Cheie combinată
- FR Clé mixte
- IT Chiave combinata
- ES Llave combinada
- CN 两用扳手

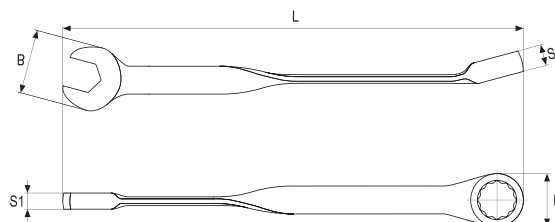

YATO	Ø [mm]	L [mm]	B [mm]	D [mm]	S1 [mm]	S2 [mm]	Box
YT-01851	10	165	20.6	15.7	5.9	7.1	100/200
YT-01852	12	204	25.6	20.2	7.0	8.0	40/120
YT-01853	13	204	25.5	20.0	6.8	8.2	40/120
YT-01854	14	216	28.4	21.4	7.2	8.4	40/120

YATO	Ø [mm]	L [mm]	B [mm]	D [mm]	S1 [mm]	S2 [mm]	Box
YT-01855	15	230	30.9	25.1	7.4	9.4	40/120
YT-01856	17	244	34.5	26.8	7.7	10.0	40/80
YT-01858	19	259	38.4	28.9	8.0	9.9	40/80

1

- EN Combination spanner set
- PL Zestaw kluczy płasko-oczkowych
- DE Maul-Ringschlüssel-Satz
- RU Набор комбинированных ключей
- CZ Sada očkoplochých klíčů
- HU Csillag-villáskulcs készlet
- RO Set chei combinate
- FR Jeu de clés mixtes
- IT Set chiavi combinate
- ES Juego de llaves combinadas
- CN 两用扳手组套



14
PCS

YATO	∅ [mm]	
YT-01865	10, 12, 13, 14, 15, 17, 18, 19, 21, 22, 24, 27, 30, 32	4

- EN Combination ratchet wrench
- PL Klucz płasko-oczkowy z grzechotką
- DE Ratschen-Ringmaulschlüssel
- RU Ключ комбинированный с трещоткой
- CZ Klíč očkoplochý ráčnový
- HU Csillag-villás kulcs rácsnis
- RO Cheie combinată cu clichet
- FR Clé mixte à cliquet
- IT Chiave combinata a cricchetto
- ES Llave combinada con carraca
- CN 棘轮两用扳手



72T
CrV
50BV30

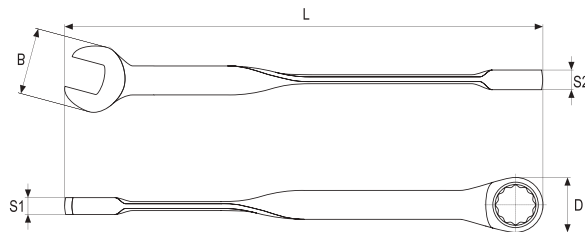

YATO	∅ [mm]	L [mm]	B [mm]	D [mm]	S1 [mm]	S2 [mm]	
YT-01870	8	153	20.0	21.2	5.0	8.2	25/200
YT-01872	10	167	24.8	24.9	6.3	9.0	25/200
YT-01874	12	177	27.7	27.1	6.5	9.5	25/150
YT-01875	13	182	29.5	28.3	7.1	9.5	25/150

YATO	∅ [mm]	L [mm]	B [mm]	D [mm]	S1 [mm]	S2 [mm]	
YT-01876	14	192	32.3	31.5	7.7	9.6	25/100
YT-01877	15	201	34.3	30.9	7.3	9.6	25/100
YT-01879	17	228	38.7	35.3	8.0	10.7	20/80

- EN Double open end spanner
- PL Klucz płaski
- DE Doppelmaulschlüssel
- RU Ключ рожковый
- CZ Plochý klíč
- HU Villáskulcs
- RO Cheie fixă
- FR Clé plate
- IT Chiave piatta
- ES Llave fija
- CN 双头呆扳手



DIN
3110
CrV

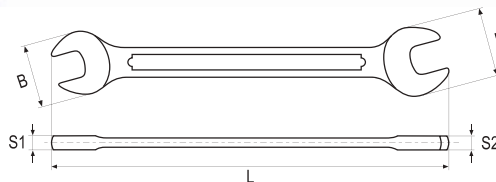

* Surface finish: chromed, satin / mirror

* Wykończenie powierzchni: chromowana, satynowa / polerowana

YATO	∅ [mm]	L [mm]	B [mm]	D [mm]	S1 [mm]	S2 [mm]	PCS PAIRS	
YT-0367	6x7	120	15.1	16.8	3.5	3.6	10	360/720
YT-0368	8x9	140	18.7	20.8	3.7	3.6	10	180/360
YT-0369	10x11	155	22.4	25.5	4.6	4.6	10	150/300
YT-0332	10x13	170	22.5	29.3	4.6	5.3	10	150/300
YT-0370	12x13	170	27.1	29.3	4.9	5.3	10	80/160
YT-0333	13x17	180	29.3	37.5	5.3	6.3	10	50/100
YT-0371	14x15	180	31.0	33.0	5.3	5.4	10	80/160
YT-0372	16x17	200	34.9	37.5	6.5	6.3	10	50/100

YATO	∅ [mm]	L [mm]	B [mm]	D [mm]	S1 [mm]	S2 [mm]	PCS PAIRS	
YT-0334	17x19	220	37.5	38.7	6.3	6.3	10	50/100
YT-0373	18x19	220	38.7	41.0	6.6	6.3	10	50/100
YT-0374	20x22	230	42.1	46.8	7.1	6.8	10	30/60
YT-0375	21x23	245	44.4	48.6	7.3	6.9	10	30/60
YT-0376	24x27	260	51.6	56.9	8.1	8.1	5	20/40
YT-0377	25x28	270	52.3	57.9	8.4	8.3	5	20/40
YT-0378	30x32	295	61.4	65.1	8.0	8.6	5	15/30

- EN Double open end spanner set
- PL Zestaw kluczy płaskich
- DE Doppelmaulschlüsselsatz
- RU Набор рожковых ключей
- CZ Sada plochých klíčů
- HU Villás kulcskészlet
- RO Set chei fixe
- FR Jeu de clés plates
- IT Set di chiavi piatte
- ES Juego de llaves fijas
- CN 双头呆扳手组套



10
PCS

12
PCS

YATO	∅ [mm]	
YT-0380	6x7, 8x9, 10x11, 12x13, 14x15, 16x17, 18x19, 20x22, 21x23, 24x27	6

YATO	∅ [mm]	
YT-0381	6x7, 8x9, 10x11, 12x13, 14x15, 16x17, 18x19, 20x22, 21x23, 24x27, 25x28, 30x32	8

- EN Double ratchet spanner set
- PL Zestaw kluczy oczkowych z grzechotką
- DE Ringschlüsselsatz
- RU Набор ключей накидных
- CZ Očkový klíč
- HU Csillagkulcs készlet
- RO Set chei inelare
- FR Set de clés à oeil à cliquet
- IT Set chiavi a cricchetto
- ES Llaves de anillo
- CN 双头梅花棘轮扳手组套



5
PCS

72T

CrV
6140

YATO	Ø [mm]	
YT-5038	8x9, 10x11, 12x13, 14x15, 17x19	10/30

- EN Bi-hexagonal ring spanner
- PL Klucz oczkowy odgięty
- DE Doppelringschlüssel
- RU Ключ накидной изогнутый
- CZ Očkový klíč ohnutý
- HU Hajlított csillagkulcs
- RO Cheie inelară curbată
- FR Clé contre-coudée
- IT Chiave poligonale doppio piegato
- ES Llave de estrella acodada
- CN 双头高颈梅花扳手

DIN
838

CrV

AS-DRIVE

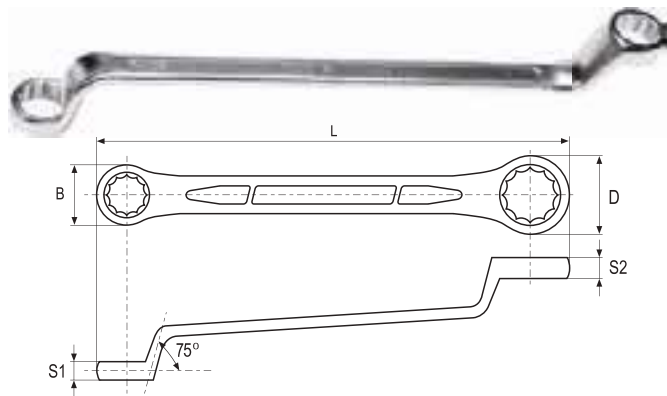

- Application: industry
- Surface finish: chromed, satin / mirror
- Przeznaczenie: przemysł
- Wykończenie powierzchni: chromowana, satynowa / polerowana

YATO	Ø [mm]	L [mm]	B [mm]	D [mm]	S1 [mm]	S2 [mm]	
YT-03950	6x7	165	11.0	12.7	5.4	5.5	10/400
YT-03951	8x9	185	13.9	15.5	6.8	7.2	10/200
YT-03952	10x11	200	16.3	17.6	6.8	7.2	10/200
YT-03953	12x13	220	19.6	21.5	7.2	7.7	10/120
YT-03954	14x15	230	23.6	21.9	8.9	9.1	10/100
YT-03955	16x17	255	24.6	26.4	8.6	9.3	10/60
YT-03956	18x19	270	27.5	28.8	10.5	10.2	5/50

- EN Bi-hexagonal ring spanner
- PL Klucz oczkowy odgięty
- DE Doppelringschlüssel
- RU Ключ накидной изогнутый
- CZ Očkový klíč ohnutý
- HU Hajlított csillagkulcs
- RO Cheie inelară curbată
- FR Clé contre-coudée
- IT Chiave poligonale doppio piegato
- ES Llave de estrella acodada
- CN 双头高颈梅花扳手

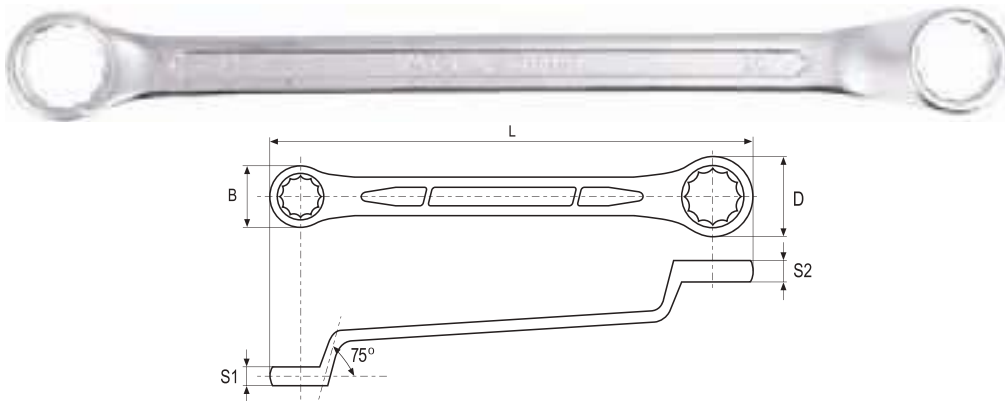

DIN
838

CrV

AS-DRIVE

- Application: industry
- Surface finish: chromed, satin / mirror
- Przeznaczenie: przemysł
- Wykończenie powierzchni: chromowana, satynowa / polerowana

YATO	Ø [mm]	L [mm]	B [mm]	D [mm]	S1 [mm]	S2 [mm]	PCS	
YT-0383	6x7	165	11.0	12.7	5.4	5.5	10	200/400
YT-0384	8x9	185	13.9	15.5	6.8	7.2	10	100/200
YT-0385	10x11	200	16.3	17.6	6.8	7.2	10	100/200
YT-0386	12x13	220	19.6	21.5	7.2	7.7	10	60/120
YT-0387	14x15	230	23.6	21.9	8.9	9.1	10	50/100
YT-0388	16x17	255	24.6	26.4	8.6	9.3	10	30/60

YATO	Ø [mm]	L [mm]	B [mm]	D [mm]	S1 [mm]	S2 [mm]	PCS	
YT-0389	18x19	270	27.5	28.8	10.5	10.2	5	25/50
YT-0390	20x22	290	30.9	33.4	10.5	11.4	5	20/40
YT-0391	21x23	310	31.9	34.4	11.8	12.4	5	20/40
YT-0392	24x27	330	36.2	40.6	11.5	13.2	5	20/40
YT-0394	30x32	390	44.0	47.1	13.8	14.9	3	15/30

- EN Bi-hexagonal ring spanner set
- PL Zestaw kluczy oczkowych odgiętych
- DE Doppelringschlüsselsatz
- RU Набор ключей накидных изогнутых
- CZ Sada vyhnutých očkových klíčů
- HU Hajlított csillagkulcs készlet
- RO Set chei inelare cu cot
- FR Set de clés contre-coudées
- IT Set chiavi poligonali doppio piegate
- ES Juego de llaves de estrella acodadas
- CN 双头高颈梅花扳手组套



DIN
838

CrV

AS-DRIVE

8
PCS

YATO	Ø [mm]	
YT-0396	6x7, 8x9, 10x11, 12x13, 14x15, 16x17, 18x19, 20x22	6

12
PCS

YATO	Ø [mm]	
YT-0398	6x7, 8x9, 10x11, 12x13, 14x15, 16x17, 18x19, 20x22, 21x23, 24x27, 25x28, 30x32	4

EN Combination ratchet wrench
 PL Klucz oczkowy odgięty z grzechotką
 DE Kombinationsratchetschlüssel
 RU Трещотка для бит
 CZ Kombinovaný rohatkový klíč
 HU Kombinált racsnis kulcs
 RO Cheie curbată cu clichet
 FR Clé mixte à cliquet
 IT Chiave ad anello piegata a cricchetto
 ES Llave de trinquete combinada
 CN 双向棘轮扳手

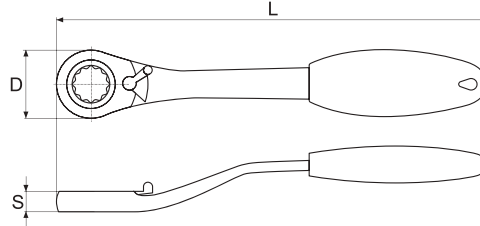
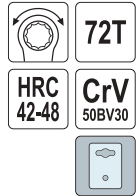

YATO	Ø [mm]	L [mm]	D [mm]	S [mm]	☐
YT-02370	8	140	18	8	10/200
YT-02371	9	145	22	8	10/200
YT-02372	10	145	23	8	10/200
YT-02373	11	170	24	9	10/100
YT-02374	12	175	24	9	10/100
YT-02375	13	190	30	9	10/100
YT-02376	14	195	31	10	10/100
YT-02377	15	195	31	10	10/100
YT-02378	16	195	31	11	10/100
YT-02379	17	225	35	11	10/60

YATO	Ø [mm]	L [mm]	D [mm]	S [mm]	☐
YT-02380	18	225	35	11	10/60
YT-02381	19	225	36	11	10/60
YT-02382	20	250	43	13	5/40
YT-02383	21	250	43	14	5/40
YT-02384	22	250	43	14	5/40
YT-02385	24	265	47	15	5/40
YT-02386	27	280	50	15	5/20
YT-02387	30	290	57	17	5/20
YT-02388	32	290	57	18	5/20

EN Ring impact wrench
 PL Klucz do pobijania oczkowy
 DE Schlagringschlüssel
 RU Ключ закрытый для растряски
 CZ Klíč maticový očkový rázový
 HU Utócsillagkulcs
 RO Cheie inelară de impact
 FR Clé à frapper à oeil
 IT Chiave poligonale semplice a percussione
 ES Llave de muletilla para usarse dando golpes
 CN 敲击梅花扳手

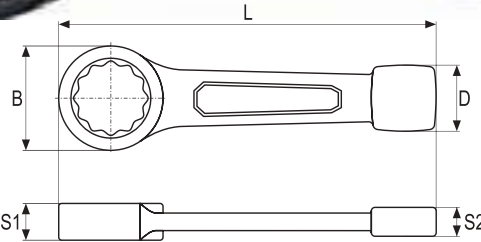

- Application: industry
- 12 point profile
- AS-DRIVE system
- Drop forged
- Surface finish: black oxidised

- Przeznaczenie: przemysł
- Profil 12-kątny
- System AS-DRIVE
- Kute
- Wykończenie powierzchni: czarna, oksydowana

YATO	Ø [mm]	L [mm]	B [mm]	D [mm]	S1 [mm]	S2 [mm]	☐
YT-1601	24	160	41	31	15.0	10	5/25
YT-1602	27	185	47	33	15.0	12	5/25
YT-1603	30	190	51	35	16.5	14	5/25
YT-1604	32	195	54	37	16.5	15	5/25
YT-1605	36	210	60	39	20.0	17	5/10
YT-1606	38	210	60	39	20.0	17	5/10
YT-1607	41	225	66	42	20.0	18	5/10

YATO	Ø [mm]	L [mm]	B [mm]	D [mm]	S1 [mm]	S2 [mm]	☐
YT-1608	46	240	74	44	22.0	19	5/10
YT-1609	50	250	80	45	23.0	20	5/10
YT-1610	55	270	86	55	25.0	22	5/10
YT-1611	58	270	86	55	25.0	22	5
YT-1612	60	270	92	60	25.0	23	5
YT-1613	65	290	100	65	30.0	24	5
YT-1614	70	310	108	70	32.0	25	5

EN Open end impact wrench
 PL Klucz do pobijania płaski
 DE Schlagschraubenschlüssel
 RU Ключ плоский для растряски
 CZ Klíč maticový plochý rázový
 HU Utólaposkulcs
 RO Cheie fixă de șoc
 FR Clé à frapper plate
 IT Chiave a forchetta semplice a percussione
 ES Llave de boca abierta para usarse dando golpes
 CN 敲击开口扳手

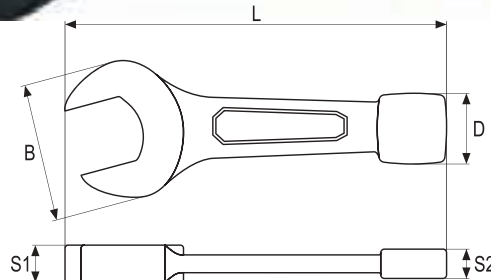
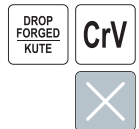

- Application: industry
- Head offset: 15°
- Drop forged
- Surface finish: black oxidised

- Przeznaczenie: przemysł
- Kąt odchylenia główki: 15°
- Kute
- Wykończenie powierzchni: czarna, oksydowana

YATO	Ø [mm]	L [mm]	B [mm]	D [mm]	S1 [mm]	S2 [mm]	☐
YT-1615	27	180	55	33	15	12	5/25
YT-1616	30	187	63	35	17	14	5/25
YT-1617	32	195	67	37	18	15	5/25
YT-1618	36	210	77	39	18	17	5/10

YATO	Ø [mm]	L [mm]	B [mm]	D [mm]	S1 [mm]	S2 [mm]	☐
YT-1619	41	225	89	42	20	18	5/10
YT-1620	46	255	98	44	20	19	5/15
YT-1621	50	280	107	45	22	20	5
YT-1622	55	310	118	55	25	22	5

- EN Half-moon spanner
 PL Klucz oczkowy typu „C”
 DE Starter- und Blockschlüssel
 RU Ключ накладной изогнутой „С”
 CZ Klíč očkoploché typ „C”
 HU Félhold alakú csillagkulcs
- RO Cheie inelara semi-luna
 FR Clé à oeil „C”
 IT Chiave poligonale doppio speciale tipo „C”
 ES Llave de estrella tipo „C”
 CN C型梅花扳手

CrV
6140

AS-DRIVE

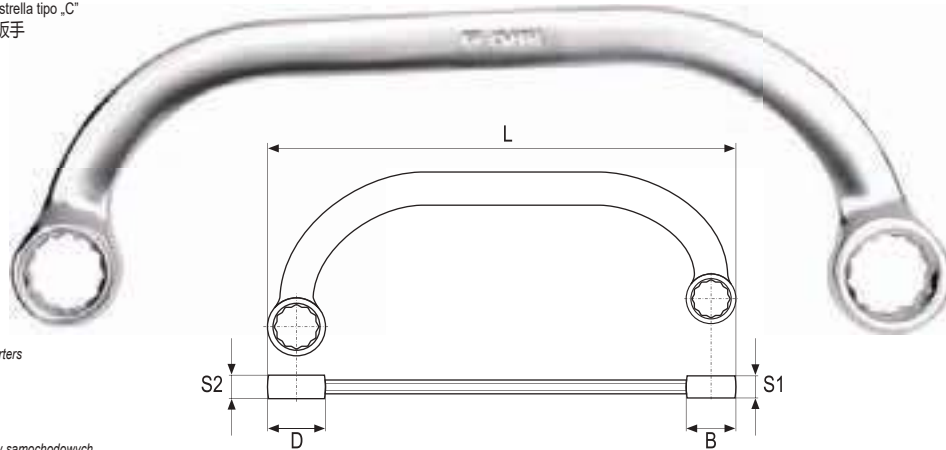

- Application: industry
- Excellent for work in tight spaces
- Used for dismantling of collector tubes, alternators and starters
- Surface finish: chromed, satin

- Przeznaczenie: przemysł
- Do pracy w miejscach szczególnie trudno dostępnych
- Ułatwia odkręcanie kolektorów, alternatorów i rozruszników samochodowych
- Wykończenie powierzchni: chromowana, satynowa

YATO	Ø [mm]	L [mm]	B [mm]	D [mm]	S1 [mm]	S2 [mm]	PCS	NOTE
YT-0170	10x12	145	16.8	19.2	6.8	6.8	10/60	
YT-0171	11x13	170	18.5	21.2	8.4	8.6	10/60	
YT-0172	14x15	195	22.8	25.8	9.2	9.9	10/60	

YATO	Ø [mm]	L [mm]	B [mm]	D [mm]	S1 [mm]	S2 [mm]	PCS	NOTE
YT-0173	16x17	220	26.2	28.6	9.9	10.5	10/60	
YT-0175	19x22	260	28.7	32.9	10.4	10.9	10/60	

- EN Flare nut wrench
 PL Klucz oczkowy półotwarty
 DE Schraubenschlüssel, halboffen
 RU Ключ накладной полуоткрытый
 CZ Klíč prstencový polootevřený
 HU Csuklós, nyitott
 RO Cheie inelară semideschisă
 FR Clé mixte à cliquet
 IT Chiave poligonale semiaperto
 ES Llave semiabierta
 CN 油管扳手

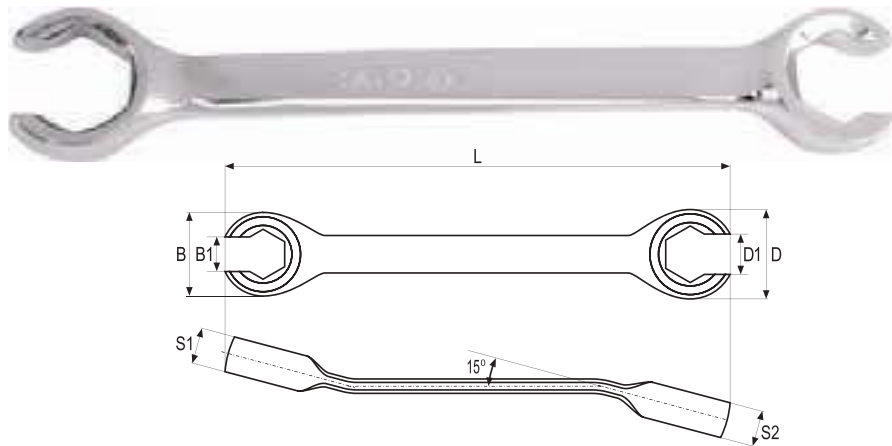

CrV
6140



YATO	Ø [mm]	L [mm]	B [mm]	B1 [mm]	D [mm]	D1 [mm]	S1 [mm]	S2 [mm]	PCS	NOTE
YT-0135	8x10	140	18.7	6.2	21.8	7.2	7.7	8.4	10	200/400
YT-0136	11x12	160	21.2	8.1	24.0	9.2	8.5	9.5	10	100/200
YT-0137	13x14	175	26.3	9.6	27.3	10.7	9.6	10.5	10	100/200
YT-0138	15x17	190	31.2	11.8	31.2	13.0	11.5	10.9	10	50/100

YATO	Ø [mm]	L [mm]	B [mm]	B1 [mm]	D [mm]	D1 [mm]	S1 [mm]	S2 [mm]	PCS	NOTE
YT-01385	17x19	195	29.0	14.5	31.2	15.0	12.4	12.8	10	50/100
YT-0139	19x21	230	36.3	14.7	42.1	16.7	12.4	12.8	10	50/100
YT-0140	22x24	250	42.7	17.1	44.2	18.6	13.2	13.9	10	50/100

- EN Flare nut wrench set
 PL Zestaw kluczy oczkowych półotwartych
 DE Schraubenschlüssel, halboffen
 RU Ключ накладной полуоткрытый
 CZ Klíč prstencový polootevřený
 HU Csuklós, nyitott
 RO Cheie inelară semideschisă
 FR Set de clés à tête fendue
 IT Set chiavi poligonali semiaperte
 ES Llaves semiabiertas
 CN 油管扳手组套

4
PCS



CrV
6140



YATO	Ø [mm]	PCS
YT-0143	8x10, 11x12, 13x14, 15x17	25/50

- EN Torx ring spanner set
 PL Zestaw kluczy oczkowych Torx
 DE Torx-Ringschlüsselsatz
 RU Набор накладных ключей
 CZ Očkové klíče
 HU Csillagkulcs készlet
 RO Set chei inelare Torx
 FR Set de clés à oeil
 IT Set chiavi doppie Torx
 ES Llaves de anillo Torx
 CN 星型扳手组套

4
PCS



CrV
6150



YATO	Ø	PCS
YT-0530	E6xE8, E10xE12, E14xE18, E20xE24	10/60

1

EN Torx type double head flexible wrench
 PL Klucz przegubowy Torx
 DE Torx Doppel-Gelenkschlüssel
 RU Ключ двусторонний шарнирный Torx
 CZ Oboustranný kloubový klíč Torx
 HU Csavarkulcs Torx

RO Cheie Torx cu articulație
 FR Clé articulée Torx
 IT Chiave snodata Torx
 ES Llave articulada Torx
 CN 双摇头杆

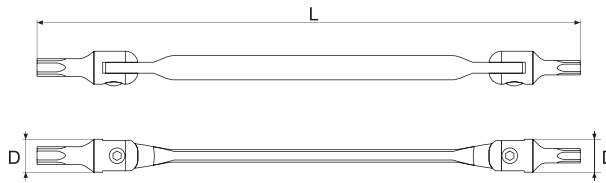
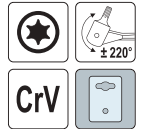

YATO	⊕	L [mm]	D [mm]	
YT-05311	T15xT20	202	12.4	25/100
YT-05312	T25xT27	216	13.9	25/100
YT-05313	T30xT40	229	17.8	25/100
YT-05314	T45xT50	243	19.7	10/50
YT-05315	T55xT60	255	21.8	10/50

EN Torx type double head flexible wrench set
 PL Zestaw kluczy Torx z przegubem
 DE Torx Doppel-Gelenkschlüssel-Satz
 RU Набор ключей Torx с шарниром
 CZ Klíče kloubové zástrčné Torx sada
 HU Kétféjű Torx flexibilis szárral készlet
 RO Set chei Torx cu articulație
 FR Clé à double tête de type Torx
 IT Set di chiavi snodate Torx
 ES Juego de llaves articuladas Torx
 CN 双摇头杆

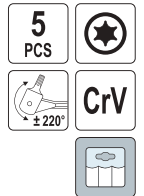

YATO	⊕	
YT-05320	T15xT20, T25xT27, T30xT40, T45xT50, T55xT60	20

EN Socket wrench
 PL Klucz nasadowy
 DE Steckschlüssel
 RU Ключ торцевой
 CZ Nastrčný klíč
 HU Nyeles dugókulcs
 RO Cheie tubulară
 FR Clé à douille
 IT Chiave a pipa
 ES Llave tubular
 CN 套筒扳手

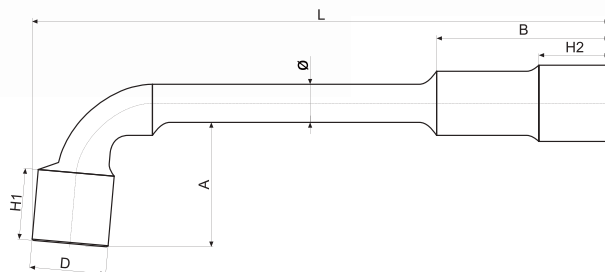
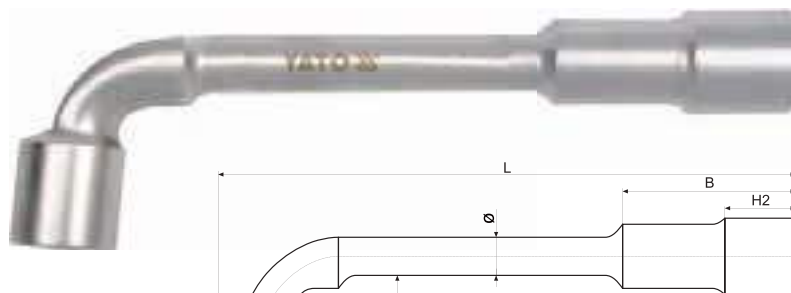

YATO	⊕	L [mm]	B [mm]	H1 [mm]	H2 [mm]	A [mm]	D [mm]	Ø [mm]	
YT-1627	7	106	27.0	10.1	10.2	21.0	10.7	7	12/60
YT-1628	8	117	29.5	11.9	12.3	18.5	12.2	9	12/60
YT-1629	9	121	31.7	12.8	13.4	19.1	13.2	10	12/60
YT-1630	10	131	35.1	16.9	16.4	23.3	15.0	10	12/60
YT-1631	11	138	36.0	16.8	16.5	24.7	16.3	11	12/60
YT-1632	12	147	42.5	18.2	17.9	17.9	18.0	12	12/60
YT-1633	13	154	44.2	19.1	18.5	30.1	19.3	12	12/60
YT-1634	14	162	47.0	20.3	19.3	30.2	20.8	13	12/60
YT-1635	15	173	48.9	21.6	20.6	31.6	22.3	13	12/60
YT-1636	16	182	55.0	23.1	23.2	37.3	23.6	14	12/60

YATO	⊕	L [mm]	B [mm]	H1 [mm]	H2 [mm]	A [mm]	D [mm]	Ø [mm]	
YT-1637	17	188	57.0	25.5	25.1	37.9	25.1	14	12/36
YT-1638	18	192	57.1	24.6	25.1	40.1	26.0	14	12/36
YT-1639	19	207	62.3	27.4	26.9	41.6	28.2	16	12/36
YT-1640	20	215	62.4	28.3	27.0	42.4	29.2	16	6/24
YT-1641	21	221	65.0	30.6	30.5	54.0	30.2	16	6/24
YT-1642	22	232	67.5	30.6	30.8	49.1	31.7	16	6/24
YT-1644	24	253	78.2	31.7	32.3	53.5	33.6	17	6/18
YT-1647	27	288	85.3	36.4	36.9	54.7	37.6	20	6/12
YT-1649	30	310	95.0	38.6	38.4	65.3	42.0	22	6/12

- EN Ratchet wrench
PL Klucz nasadkowy z grzechotką
DE Gerüstratsche
RU Ключ торцовый с трещоткой
CZ Ráčnový kľúč prúchozí
HU Kettős racsnis kulcs
RO Cheie tubulara cu clichet
FR Clé à tube à cliquet
IT Chiavi a cricchetto per ponteggi
ES Llave de vaso con carraca
CN 尖尾棘轮扳手

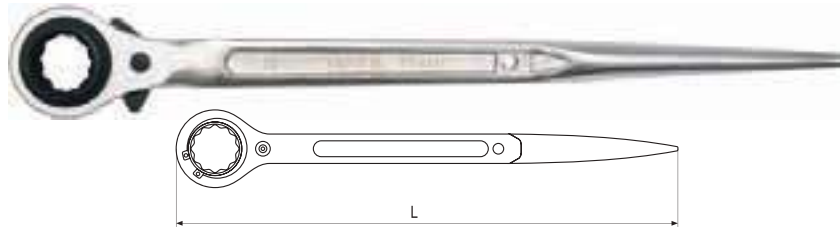

YATO	Ø [mm]	L [mm]	
YT-4937	19x22	315	2/40

- EN Double ratchet wrench
PL Dwustronny klucz nasadkowy z grzechotką
DE Gerüstratsche
RU Ключ торцовый с трещоткой
CZ Ráčnový kľúč prúchozí dvoustranný
HU Kettős racsnis kulcs
RO Cheie tubulara dubla cu clichet
FR Clé à oeil à cliquet
IT Chiave a cricco doppio
ES Llave de vaso con carraca
CN 尖尾棘轮扳手

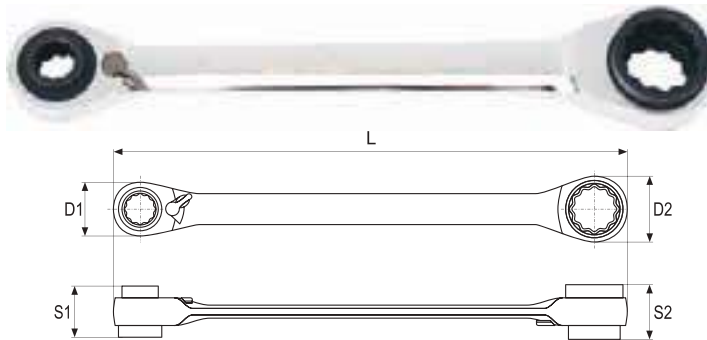

YATO	Ø [mm]	L [mm]	D1 [mm]	D2 [mm]	S1 [mm]	S2 [mm]	
YT-4945	10x13x17x19	200	29	35	17	22	5/50

- EN Socket wrench
PL Klucz nasadowy
DE Steckschlüssel
RU Ключ торцевой
CZ Nastrčný kľúč
HU Nyeles dugkulcs
- RO Cheie tubulară
FR Clé à douille
IT Chiave con bussola
ES Llave tubular
CN 套筒扳手

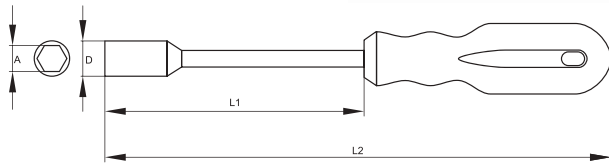
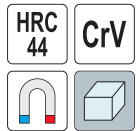

YATO	Ø [mm]	D [mm]	L1 [mm]	L2 [mm]	PCS ROCK	
YT-1542	6	9.1	125	242	6	120
YT-1543	7	10.9	125	242	6	120
YT-1544	8	12.0	125	242	6	120
YT-1546	10	14.1	125	242	6	120
YT-1549	13	18.0	125	242	6	120

- EN Socket wrench with rotary grip
PL Klucz nasadowy z obrotową rękojeścią
DE Steckschlüssel mit drehbarem Griff
RU Торцовый ключ с вращательной ручкой
CZ Kľúč nástrčný s otočnou rukojeťou
HU Nyeles dugkulcs, forgatható karral
- RO Cheie tubulară cu mâner rotativ
FR Clé à douille avec poignée coulissante
IT Chiave a bussola con manico scorrevole
ES Llave tubular con mango giratorio
CN 套筒扳手

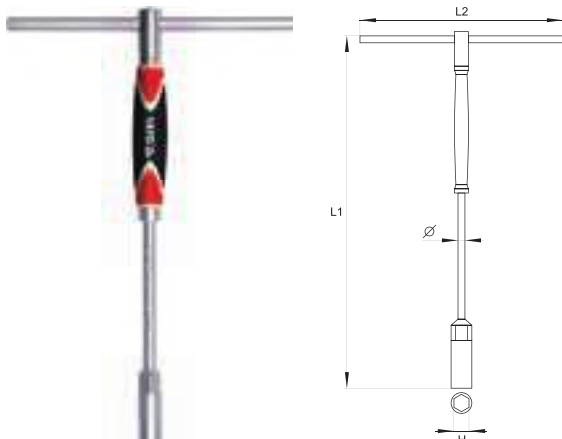

- Ergonomic handle
- Movable handle with position locking system
- Long bar for work in deeply set, difficult to reach places
- Ergonomiczna rękojeść
- Przesuwane pokrętko z blokadą położenia
- Długi trzpień umożliwiający pracę w głębokich wnękach



YATO	Ø [mm]	L1 [mm]	L2 [mm]	Ø [mm]	
YT-1552	8	310	200	10	10/40
YT-1554	10	310	200	10	10/40
YT-1556	12	310	200	10	10/40
YT-1557	13	310	200	10	10/40
YT-1558	14	310	200	10	10/40

- EN Socket adaptor with rotary grip
PL Adapter z obrotową rękojeścią
DE Adapter mit drehbarem Griff
RU Адаптер с вращательной ручкой
CZ Adaptér s otočnou rukojeťou
HU Adapter, forgatható karral
- RO Adaptor cu mâner rotativ
FR Adapteur avec poignée coulissante
IT Adattatore con manico scorrevole
ES Adaptador con mango giratorio
CN 套筒接头

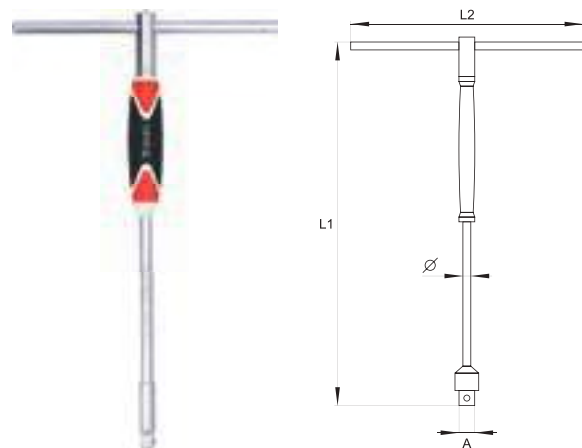

- Ergonomic handle
- Movable handle with position locking system
- Long bar for work in deeply set, difficult to reach places
- Ergonomiczna rękojeść
- Przesuwane pokrętko z blokadą położenia
- Długi trzpień umożliwiający pracę w głębokich wnękach



YATO	Ø H	L1 [mm]	L2 [mm]	Ø [mm]	
YT-1565	1/4" (6.3 mm)	310	200	8	10/40
YT-1566	3/8" (9.5 mm)	310	200	10	10/40
YT-1567	1/2" (12.7 mm)	310	200	10	10/40

1

- EN Socket wrench
- PL Klucz nasadowy
- DE Steckschlüssel
- RU Ключ торцевой
- CZ Nástrčný klíč
- HU Nyeles dugókulcs
- RO Cheie tubulară
- FR Clé à douille
- IT Chiave con bussola
- ES Llave tubular
- CN 套筒扳手

CrV
6140

AS-DRIVE

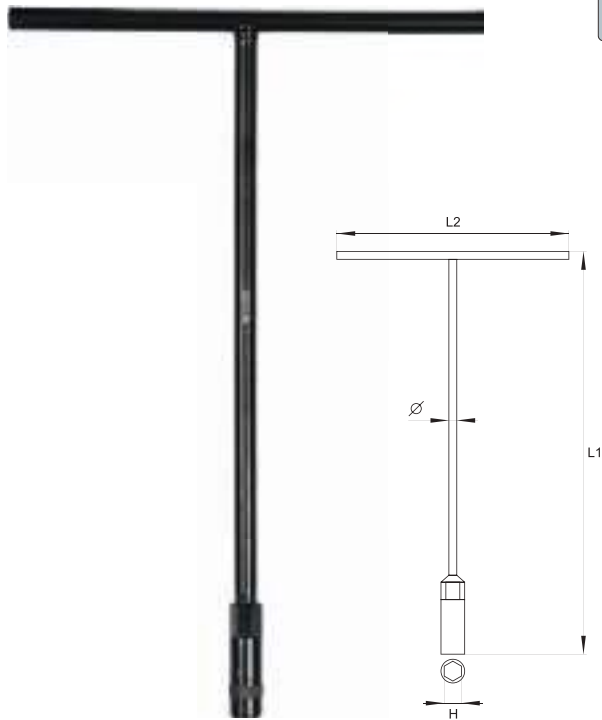

YATO	Ø [mm]	L1 [mm]	L2 [mm]	Ø [mm]	
YT-1571	8	310	200	10	10/40
YT-1573	10	310	200	10	10/40
YT-1575	12	310	200	10	10/40
YT-1576	13	310	200	10	10/40

- EN Swivel socket wrench
- PL Klucz nasadowy z przegubem
- DE Gelenk-Steckschlüssel
- RU Ключ торцевой с карданом
- CZ Nástrčný klíč s kloubem
- HU Csuklós nyeles dugókulcs
- RO Cheie tubulară cu articulație
- FR Clé à douille à cardan
- IT Chiave con bussola snodata
- ES Llave de tubo articulada
- CN 活动套筒扳手



CrV
50BV30

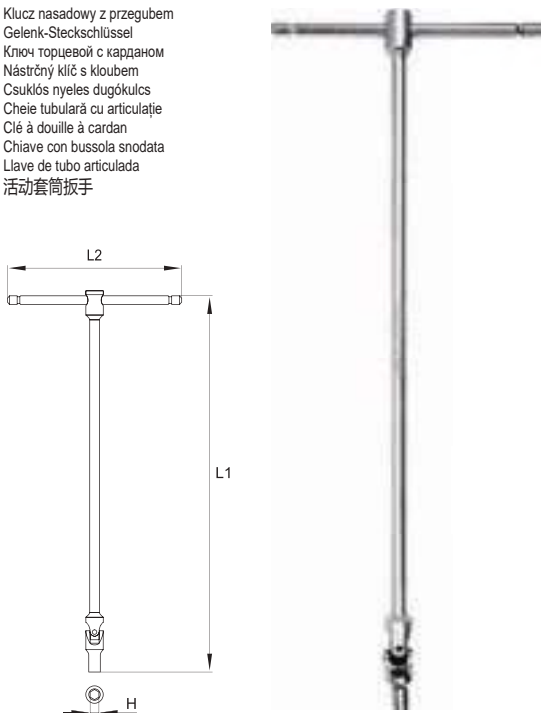

YATO	Ø [mm]	L1 [mm]	L2 [mm]	
YT-15273	8	450	180	10/40
YT-15275	10	450	180	10/40
YT-15277	12	450	180	10/40
YT-15278	13	450	180	10/40
YT-15279	14	450	180	10/40
YT-15280	15	450	180	10/40
YT-15282	17	450	180	10/40

- EN Socket wrench set
- PL Zestaw kluczy nasadowych
- DE Steckschlüsselsatz
- RU Набор торцевых ключей
- HU Nyeles dugókulcs készlet
- RO Set cheie tubulare
- FR Ensemble de clé à douille
- IT Set di chiavi con bussola
- ES Juego de llaves de vaso tubulares
- CN 套筒扳手组套

8
mm

10
mm

13
mm

AS-DRIVE

CrV
6140



YATO	Ø [mm]	
YT-15791	8, 10, 13	4/16

- EN Swivel wrench
- PL Klucz z przegubem
- DE Gelenkgriff
- RU Вороток с карданом
- CZ Třhák s kloubem
- HU Csuklós hajtószer
- RO Antrenor cardanic
- FR Clé avec cardan
- IT Chiave snodata
- ES Llave articulada
- CN 活动套筒扳手



CrV
50BV30

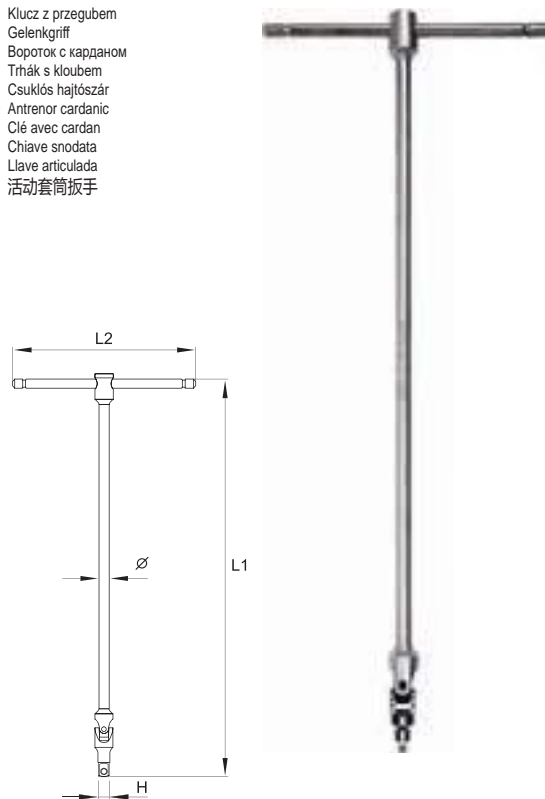

YATO	Ø H	L1 [mm]	L2 [mm]	
YT-15291	1/4" (6.3 mm)	450	180	10/40
YT-15292	3/8" (9.5 mm)	450	180	10/40
YT-15293	1/2" (12.7 mm)	450	180	10/40

EN Adjustable wrench
PL Klucz nastawny
DE Rollgabelschlüssel
RU Ключ разводной

CZ Nastavitelný klíč
HU Állítható villáskulcs
RO Cheie reglabilă
FR Clé à molette

IT Chiave a rullino
ES Llave ajustable
CN 活络扳手



1



YATO	L [mm]	
YT-2071	150	6/60
YT-2072	200	6/60
YT-2073	250	6/36
YT-2074	300	6/24
YT-2075	375	6/12



DIN 3117 CrV

YATO	L [mm]	
YT-2170	150	6/72
YT-2171	200	6/60
YT-2172	250	6/48
YT-2173	300	6/36



DIN 3117 DROP FORGED KUTE

YATO	L [mm]	Max. jaws range / Maks. rozwarcie szczęk [mm]	
YT-21650	150	19.3	6/60
YT-21651	200	24.0	6/60
YT-21652	250	30.0	6/36
YT-21653	300	36.0	6/24
YT-21654	375	45.0	2/16

EN Flexible hook wrench
PL Klucz hakowy
DE Hakenschlüssel

RU Ключ сегментный шарнирный
CZ Hákový klíč
HU Körmös kulcs

RO Cheie universală cu cârlig
FR Clé à crochet

ES Llave de gancho articulada
CN 方头钩型扳手

CrV



YATO	L [mm]	⌀ [mm]	
YT-01670	170	15-35	10/50
YT-01671	210	35-50	10/50
YT-01672	280	50-80	10/50
YT-01673	340	80-120	5/10
YT-01674	470	120-180	5/10



YATO	L [mm]	⌀ [mm]	
YT-01675	170	15-35	10/50
YT-01676	210	35-50	10/50
YT-01677	280	50-80	10/50
YT-01678	340	80-120	5/10
YT-01679	470	120-180	5/10

2

Sockets, accessories & sets
Klucze nasadowe,
akcesoria i zestawy

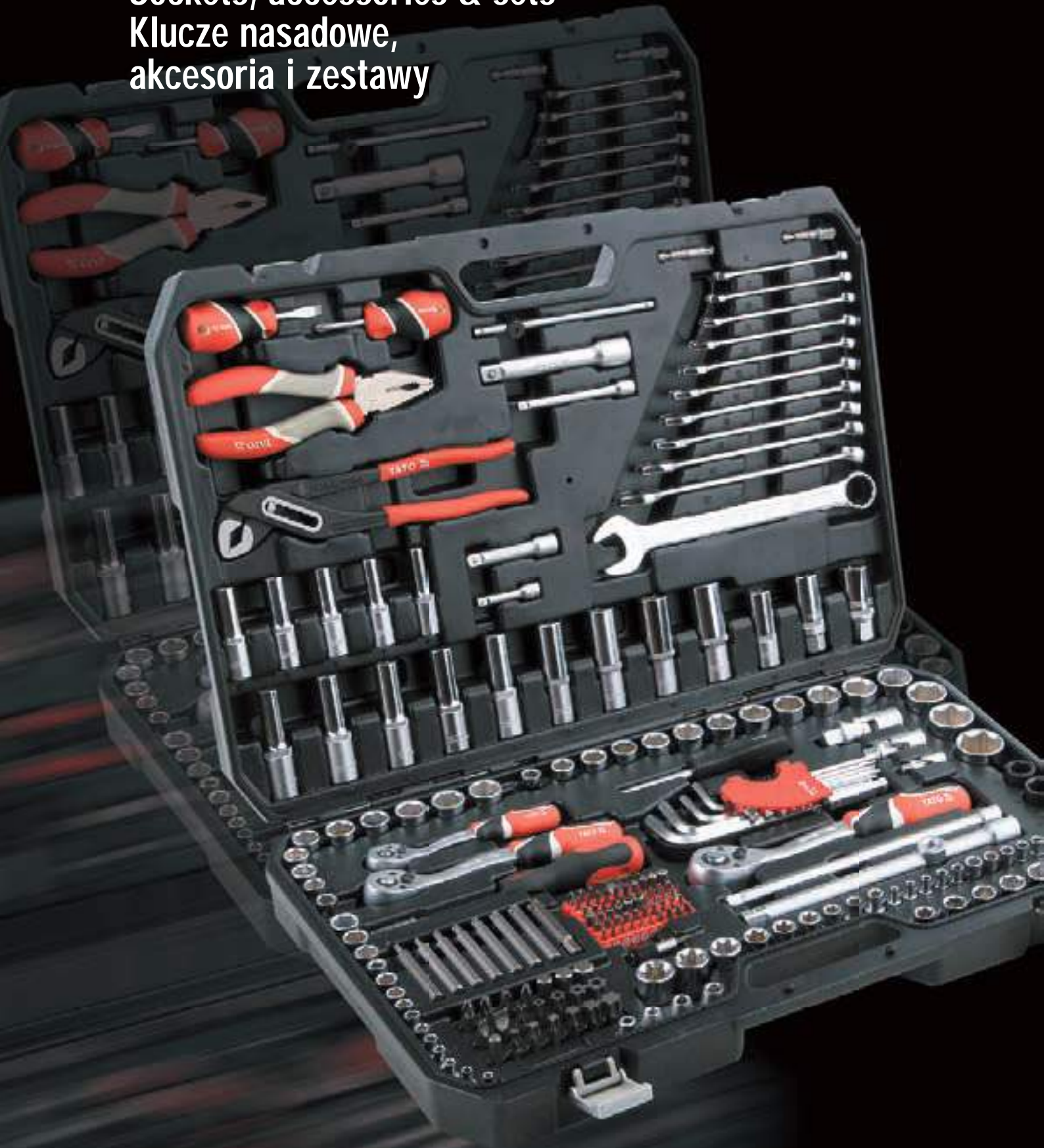

Sockets 1/4" Klucze nasadowe 1/4"		23
---	---	----

Hexagonal sockets Klucze nasadowe sześciokątne, krótkie	23
Hexagonal deep sockets Klucze nasadowe sześciokątne, długie	23

Accessories 1/4" Akcesoria 1/4"		23-25
---	---	-------

Extension bars Przedłużki	23
Extension bars with wobble Przedłużki uchyłne	24
Adapters Redukcje	24
Bit adapters Adaptory do bitów	24
Universal joints Przeguby Cardana	24
Spinner handles Pokręta do nasadek	24
Sliding T-bars Pokręta typu „T”	25
Flexible handles Pokręta łamane	25

Ratchet handles 1/4" Grzechotki 1/4"		25-26
--	--	-------

Ratchet handles Grzechotki	25
Flexible ratchet handles Grzechotki z przegubem	25
Composite ratchet handles Grzechotki powlekane	26
Curved ratchet handles Grzechotki wygięte	26
Telescopic ratchet handles Grzechotki z przedłużonym uchwytem	26
Bit and socket drive ratchet handles Grzechotki do bitów i nasadek	26
Rotary head ratchet handles Grzechotki z obrotową głowicą	26

Sockets 3/8" Klucze nasadowe 3/8"		27
---	---	----

Hexagonal sockets Klucze nasadowe sześciokątne, krótkie	27
Hexagonal deep sockets Klucze nasadowe sześciokątne, długie	27

Accessories 3/8" Akcesoria 3/8"		27-28
---	---	-------

Extension bars Przedłużki	27
Extension bars with wobble Przedłużki uchyłne	27
Adapters Redukcje	28
Bit adapters Adaptory do bitów	28

Universal joints Przeguby Cardana	28
Sliding T-bars Pokręta typu „T”	28
Flexible handles Pokręta łamane	28

Ratchet handles 3/8" Grzechotki 3/8"		29
--	---	----

Ratchet handles Grzechotki	29
Flexible ratchet handles Grzechotki z przegubem	29
Composite ratchet handles Grzechotki powlekane	29
Curved ratchet handles Grzechotki wygięte	29
Telescopic ratchet handles Grzechotki z przedłużonym uchwytem	29
Rotary head ratchet handles Grzechotki z obrotową głowicą	29

Sockets 1/2" Klucze nasadowe 1/2"		30-31
---	---	-------

Hexagonal sockets Klucze nasadowe sześciokątne, krótkie	30
Bi-hexagonal sockets Klucze nasadowe dwunastokątne, krótkie	30
Spline sockets Klucze nasadowe „Spline”	30
Hexagonal deep sockets Klucze nasadowe sześciokątne, długie	31
Bi-hexagonal deep sockets Klucze nasadowe dwunastokątne, długie	31





Accessories 1/2" Akcesoria 1/2"		31-32
---	---	-------

Extension bars Przedłużki	31
Extension bars with wobble Przedłużki uchyłne	31
Adapters Redukcje	31
Bit adapters Adaptory do bitów	32
Universal joints Przeguby Cardana	32
Sliding T-bars Pokręta typu „T”	32
Flexible handles Pokręta łamane	32
L-type handles Pokręta typu „L”	32

Ratchet handles 1/2" Grzechotki 1/2"		33
--	---	----

Ratchet handles Grzechotki	33
Flexible ratchet handles Grzechotki z przegubem	33
Composite ratchet handles Grzechotki powlekane	33



Curved ratchet handles Grzechotki wygięte.....	33	Sockets 3/4" Klucze nasadowe 3/4".....	53	
Telescopic ratchet handles Grzechotki z przedłużonym uchwytem.....	33			
Rotary head ratchet handles Grzechotki z obrotową głowicą.....	33			
Socket sets Zestawy kluczy nasadowych.....	34-50	Accessories 3/4" Akcesoria 3/4".....	54	
Socket sets 1/4" Zestawy kluczy nasadowych 1/4".....	34	Extension bars Przedłużki.....	54	
Socket sets 3/8" Zestawy kluczy nasadowych 3/8".....	36	Adapters Redukcje.....	54	
Socket sets 1/2" Zestawy kluczy nasadowych 1/2".....	37	Universal joints Przeguby Cardana.....	54	
Socket sets 1/2", 1/4" Zestawy kluczy nasadowych 1/2", 1/4".....	38	Sliding T-bars Pokręta typu „T”.....	54	
Socket sets 1/2", 3/8", 1/4" Zestawy kluczy nasadowych 1/2", 3/8", 1/4".....	43	Flexible handles Pokręta łamane.....	54	
		L-type handles Pokręta typu „L”.....	54	
Socket sets Zestawy kluczy nasadowych.....	51	Ratchet handles 3/4" Grzechotki 3/4".....	55	
Socket sets 1/4" Zestawy kluczy nasadowych 1/4".....	51	Socket sets 3/4" Zestawy kluczy nasadowych 3/4".....	55	
Socket sets 1/2" Zestawy kluczy nasadowych 1/2".....	51			
Socket sets 1/2", 3/8" Zestawy kluczy nasadowych 1/2", 3/8".....	51			
Tool sets Zestawy narzędziowe.....	52	Bit sockets & sets 1/4", 3/8", 1/2" Klucze trzpieniowe i zestawy 1/4", 3/8", 1/2".....	56-61	
Torx sockets & sets Klucze nasadowe „Torx” i zestawy.....	52-53			

EN Hexagonal socket
PL Nasadka sześciokątna
DE Sechskantenschlüssel
RU Головка шестигранная короткая
CZ Šestihranný nástavec
HU Dugókulcs hatszög
RO Cheie tubulară hexagonală
FR Douille courte
IT Chiave a bussola esagonale
ES Boquilla hexagonal corta
CN 六角套筒

1/4"
6.3mm
DIN 3121
CrV
50BV30
AS-DRIVE

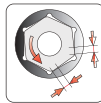
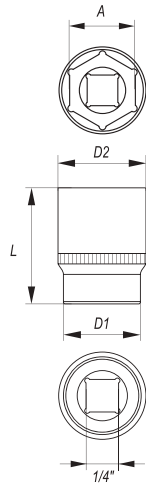

- Drive locks
- Surface finish: chromed, satin / mirror
- Zamki blokujące
- Wykończenie powierzchni: chromowana, satynowa / polerowana

YATO	o A [mm]	D1 [mm]	D2 [mm]	L [mm]	PCS FRONT	
YT-1401	4.0	7.0	12	25	24	240/480
YT-1403	5.0	8.0	12	25	24	240/480
YT-1404	5.5	8.5	12	25	24	240/480
YT-1405	6.0	9.0	12	25	24	240/480
YT-1406	7.0	10.0	12	25	24	240/480
YT-1407	8.0	12.0	11	25	24	240/480
YT-1408	9.0	13.0	12	25	24	240/480
YT-1409	10.0	15.0	12	25	24	240/480
YT-1410	11.0	16.0	14	25	24	240/480
YT-1411	12.0	17.0	15	25	24	240/480
YT-1412	13.0	18.0	16	25	24	240/480

EN Hexagonal deep socket
PL Nasadka sześciokątna długa
DE Sechskantenschlüssel, lange
RU Головка шестигранная длинная
CZ Šestihranný hluboký nástavec
HU Dugókulcs hatszög hosszú
RO Cheie tubulară hexagonală adâncă
FR Douille longue
IT Chiave a bussola esagonale
ES Boquilla hexagonal larga
CN 六角长套筒

1/4"
6.3mm
DIN 3121
CrV
50BV30
AS-DRIVE

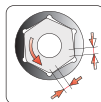
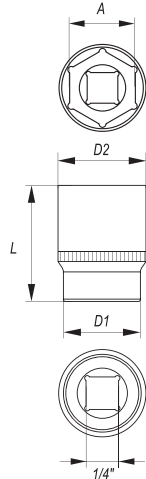

- Drive locks
- Surface finish: chromed, satin / mirror
- Zamki blokujące
- Wykończenie powierzchni: chromowana, satynowa / polerowana

YATO	o A [mm]	D1 [mm]	D2 [mm]	L [mm]	PCS FRONT	
YT-1413	4.0	7.0	12	50	24	240/480
YT-1414	4.5	7.5	12	50	24	240/480
YT-1415	5.0	8.0	12	50	24	240/480
YT-1416	5.5	8.5	12	50	24	240/480
YT-1417	6.0	9.0	12	50	24	240/480
YT-1418	7.0	10.0	12	50	24	240/480
YT-1419	8.0	12.0	12	50	24	240/480
YT-1420	9.0	13.0	12	50	24	240/480
YT-1421	10.0	14.0	13	50	24	240/480
YT-1422	11.0	16.0	14	50	24	120/240
YT-1423	12.0	17.0	15	50	24	120/240
YT-1424	13.0	18.0	16	50	24	120/240

EN Hexagonal socket
PL Nasadka sześciokątna
DE Sechskantenschlüssel
RU Головка шестигранная короткая
CZ Šestihranný nástavec
HU Dugókulcs hatszög
RO Cheie tubulară hexagonală
FR Douille courte
IT Chiave a bussola esagonale
ES Boquilla hexagonal corta
CN 六角套筒

1/4"
6.3mm
CrV
50BV30
AS-DRIVE

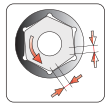
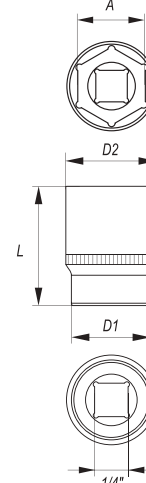

YATO	o A [mm]	D1 [mm]	D2 [mm]	L [mm]	
YT-14120	5.0	8.0	12	25	12/360
YT-14121	5.5	8.5	12	25	12/360
YT-14123	6.0	9.0	12	25	12/360
YT-14124	7.0	10.0	12	25	12/360
YT-14125	8.0	12.0	12	25	6/360
YT-14126	9.0	13.0	12	25	6/360
YT-14127	10.0	15.0	12	25	6/360
YT-14128	12.0	17.0	15	25	6/360
YT-14129	13.0	18.0	16	25	6/360

EN Extension bar
PL Przedłużka
DE Verlängerung
RU Удлинитель для воротка
CZ Prodlužovací příravek
HU Toldalék
RO Prelungitor
FR Rallonge
IT Prolunga
ES Tubo de prolongación
CN 接杆

1/4"
6.3mm
DIN 3121
CrV
50BV30

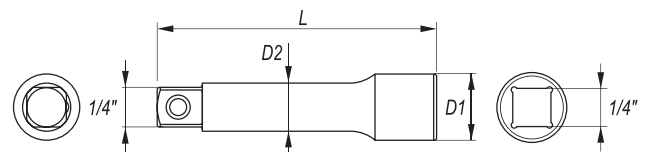

YATO	o	D1 [mm]	D2 [mm]	L [mm]	PCS FRONT	
YT-1429	1/4" (6.3 mm)	12.4	8.3	50.8	30	150/300
YT-1430	1/4" (6.3 mm)	12.4	8.3	76.0	30	150/300
YT-1431	1/4" (6.3 mm)	12.4	8.3	101.6	20	100/200
YT-1432	1/4" (6.3 mm)	12.4	8.3	152.4	20	100/200

- EN Extension bar with wobble
 PL Przedłużka uchylna
 DE Gelenkverlängerung
 RU Удлинитель наклонный
 CZ Odklonylný prodlužovací přípravek
 HU Csuklós toldalék
- RO Prelungitor rabatabil
 FR Rallonge angulaire
 IT Prolunga
 ES Tubo de prolongación desviable
 CN 转向接杆

1/4"
6.3mm

DIN
3121

CrV
50BV30

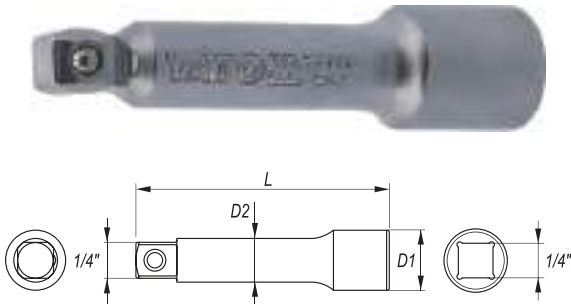

YATO	Ø	D1 [mm]	D2 [mm]	L [mm]	PCS PKING	
YT-1433	1/4" (6.3 mm)	12.4	8.3	50.8	30	150/300
YT-1434	1/4" (6.3 mm)	12.4	8.3	76.0	30	150/300
YT-1435	1/4" (6.3 mm)	12.4	8.3	101.6	20	100/200
YT-1436	1/4" (6.3 mm)	12.4	8.3	152.4	20	100/200

- EN Adapter
 PL Redukcja
 DE Reduktion
 RU Переходник
 CZ Redukce
 HU Redukció
- RO Reducție
 FR Réduction
 IT Riduttore
 ES Reducción
 CN 转换头

1/4"
6.3mm

DIN
3121

CrV
50BV30

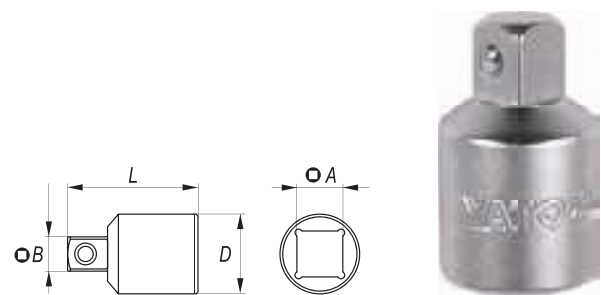

YATO	Ø A	Ø B	D [mm]	L [mm]	PCS PKING	
YT-1438	1/4" (6.3 mm) (F)	3/8" (9.5 mm) (M)	12	25	10	250/500

- EN Bit adapter
 PL Adapter do bitów
 DE Bithalter
 RU Держатель винтовёртовых наконечников
 CZ Držák na šroubovakové koncovky
 HU Szár a csavarhúzóvégekehez
 RO Adaptor biți
 FR Adaptateur d'embouts
 IT Chiave esagonale a bussola
 ES Mandril para puntas
 CN 旋具头接头

1/4"
6.3mm

CrV
6140

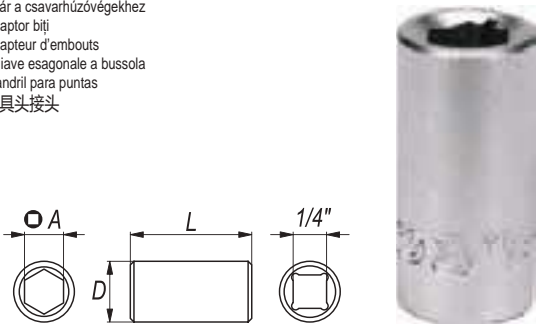

YATO	Ø	Ø A	D [mm]	L [mm]	
YT-12971	1/4" (6.3 mm)	1/4" (6.3 mm)	11.8	24	5/600

- EN Bit adapter
 PL Adapter do bitów
 DE Bithalter
 RU Держатель винтовёртовых наконечников
 CZ Držák na šroubovakové koncovky
 HU Szár a csavarhúzóvégekehez
 RO Adaptor biți
 FR Adaptateur d'embouts
 IT Chiave esagonale a bussola
 ES Mandril para puntas
 CN 旋具头接头

1/4"
6.3mm

CrV
6140

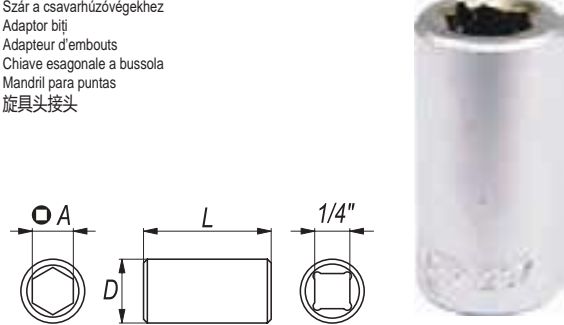

YATO	Ø	Ø A	D [mm]	L [mm]	PCS PKING	
YT-1297	1/4" (6.3 mm)	1/4" (6.3 mm)	11.8	24	24	240/480

- EN Universal joint
 PL Przegub Cardana
 DE Kardangelenk
 RU Карданный шарнир
 CZ Kardanový kloub
 HU Kardán csukló
- RO Articulație Cardanică
 FR Cardan
 IT Snodo cardanico
 ES Articulación Cardan
 CN 万向接头

1/4"
6.3mm

DIN
3121

CrV
50BV30

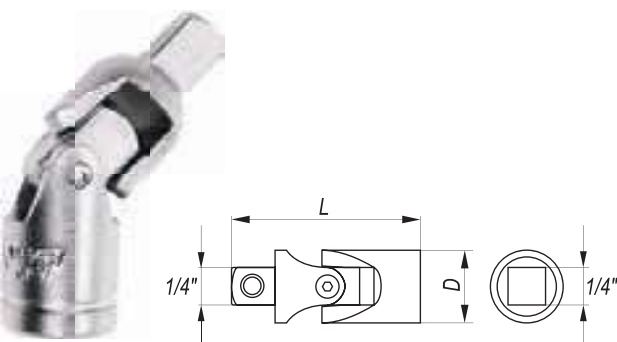

YATO	Ø	D [mm]	L [mm]	PCS PKING	
YT-1437	1/4" (6.3 mm)	14	35	20	120/240

- EN Spinner handle
 PL Pokrętko do nasadek
 DE Drehgriff für Steckschlüssel
 RU Ручка с соединением под головки
 CZ Nástróná rukojeť
 HU Csavarhúzószájajtószer
- RO Prelungitor cu mâner
 FR Barre
 IT Porta bussola con manico
 ES Destornillador con cuadradillo
 CN 旋柄

1/4"
6.3mm

CrV
50BV30



YATO	Ø	L [mm]	PCS PKING	
YT-1427	1/4" (6.3 mm)	150	12	48

EN Sliding T-bar
PL Pokrętko typu „T”
DE Handgriff mit Gleitstück
RU Вороток Т-образный
CZ Otočná račká typ „T”
HU „T” alakú hajtókar

RO Antrenor culisabil tip „T”
FR Barre type „T”
IT Manopola „T” scorrevole
ES Mango tipo „T”
CN 滑行杆

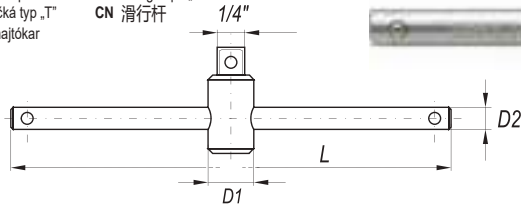

1/4"
6.3mm
DIN
3121
CrV
50BV30

YATO	Ø	D1 [mm]	D2 [mm]	L [mm]	PCS PIECE	Box
YT-1426	1/4" (6.3 mm)	13.3	6.3	152.4	10	100/200

EN Flexible handle
PL Pokrętko lamane
DE Gelenkgriff
RU Вороток шарнирный
CZ Otočná lomená račká
HU Hajlított hajtókar

RO Antrenor drept cu prindere flexibilă
FR Barre pivotante
IT Manopola a snodo
ES Mango articulado
CN 转向手柄

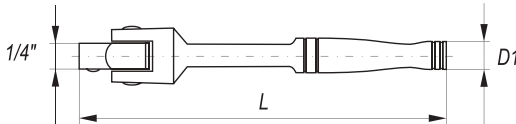

1/4"
6.3mm
DIN
3121
CrV
50BV30

YATO	Ø	D [mm]	L [mm]	PCS PIECE	Box
YT-1425	1/4" (6.3 mm)	13	140	10	100/200

EN Quick release ratchet handle
PL Grzechotka
DE Hebelumschaltknarre
RU Трещотка

CZ Ráčna
HU Racsnis hajtókar
RO Antrenor cu clichet
FR Clé à cliquet

IT Chiave a cricchetto
ES Llave de carraca
CN 快速脱落棘轮扳手

1/4"
6.3mm
DIN
3122
QUICK
RELEASE
SZYBKO-
ZŁĄCZE
72T



CrV
6140

YATO	Ø	T	L [mm]	PCS PIECE	Box
YT-0307	1/4" (6.3 mm)	72	146	12	24/96



CrV
6140

YATO	Ø	T	L [mm]	PCS PIECE	Box
YT-0310	1/4" (6.3 mm)	72	125	12	36/72



CrV
6140

YATO	Ø	T	L [mm]	PCS PIECE	Box
YT-0313	1/4" (6.3 mm)	72	125	12	24/96



CrV
6135

YATO	Ø	T	L [mm]	PCS PIECE	Box
YT-0316	1/4" (6.3 mm)	72	145	12	24/96



CrV
6140

YATO	Ø	T	L [mm]	PCS PIECE	Box
YT-0322	1/4" (6.3 mm)	72	148	12	48/96

EN Quick release ratchet handle
PL Grzechotka
DE Hebelumschaltknarre
RU Трещотка
CZ Ráčna
HU Racsnis hajtókar

RO Antrenor cu clichet
FR Clé à cliquet
IT Chiave a cricchetto
ES Carraca
CN 快速脱落棘轮扳手

1/4"
6.3mm
QUICK
RELEASE
SZYBKO-
ZŁĄCZE
90T
CrV
CrMo

EN Flexible ratchet handle
PL Grzechotka z przegubem
DE Gelenk-Hebelumschaltknarre
RU Трещотка шарнирная
CZ Kloubová ráčna
HU Csuklós racsni
RO Antrenor cu clichet flexibil
FR Clé à cliquet articulée
IT Cricchetto articolato
ES Llave de carraca articulada
CN 棘轮扳手



1/4"
6.3mm
DIN
3122
QUICK
RELEASE
SZYBKO-
ZŁĄCZE
72T
CrV
6140



YATO	Ø	T	L [mm]	PCS PIECE	Box
YT-03241	1/4" (6.3 mm)	90	160	6/36	



YATO	Ø	T	L [mm]	PCS PIECE	Box
YT-0325	1/4" (6.3 mm)	72	159	12	48/96

EN Composite ratchet handle
 PL Grzechotka powlekana
 DE Verbundwerkstoff-Ratsche
 RU Трещотка композитная
 CZ Ráčna kompozitní
 HU Racsnis hajtókar
 RO Antrenor cu clichet
 FR Clé à cliquet
 IT Cricchetto composito
 ES Llave de carraca
 CN 快速脱落棘轮扳手

1/4" 6.3mm
 DIN 3122
 QUICK RELEASE SZYBKO-ZŁĄCZE
 72T
 CrV 6135



YATO	Ø	T	L [mm]	PCS PER PKG	
YT-0290	1/4" (6.3 mm)	72	144	12	48/96

YATO	Ø	T	L [mm]	PCS PER PKG	
YT-0293	1/4" (6.3 mm)	72	144	12	48/96

EN Quick release ratchet handle
 PL Grzechotka
 DE Hebelumschaltknarre
 RU Трещотка
 CZ Ráčna
 HU Racsnis hajtókar
 RO Antrenor cu clichet
 FR Clé à cliquet
 IT Chiave a cricchetto
 ES Llave de carraca
 CN 快速脱落棘轮扳手

1/4" 6.3mm
 QUICK RELEASE SZYBKO-ZŁĄCZE

72T
 CrV 6140



YATO	Ø	T	L [mm]	PCS PER PKG	
YT-0730	1/4" (6.3 mm)	72	155	12	12/96

EN Telescopic ratchet handle
 PL Grzechotka z przedłużanym uchwytem
 DE Umschaltknarre ausziehbar
 RU Трещотка телескопическая
 CZ Ráčna teleskopická
 HU Racsnis hajtókar teleszkópos
 RO Antrenor cu clichet telescopic
 FR Clé à cliquet télescopique
 IT Chiave a cricchetto telescopico
 ES Llave carraca telescópica
 CN 可伸缩快速脱落棘轮扳手



1/4" 6.3mm
 QUICK RELEASE SZYBKO-ZŁĄCZE

72T
 CrV 6135



YATO	Ø	T	L [mm]	PCS PER PKG	
YT-0297	1/4" (6.3 mm)	72	150-200	12	12/48

EN Swivel ratchet handle for bits and sockets
 PL Grzechotka z obrotową głowicą do bitów i nasadek
 DE Drehkopfratsche für Bits und Steckschlüssel
 RU Трещотка для бит и головок с шарниром
 CZ Ráčna s otočnou hlavou na hlavice a bity
 HU Racsnis hajtószár bit és dugókulcshoz
 RO Antrenor clichet cu articulație pt. tubulare și biți
 FR Cliquet à tête pivotante pour embouts et douilles
 IT Cricchetto con testa rotante per punte e chiavi a bussola
 ES Carraca con cabeza giratoria
 CN 套筒旋具两用棘轮扳手

1/4" 6.3mm

1/4" 6.3mm

DIN 3122

72T

CrV 6140

3D



YATO	Ø	T	L [mm]	PCS PER PKG	
YT-03311	1/4" (6.3 mm) x 1/4" (6.3 mm)	72	115	10	10/100

EN Quick release ratchet handle
 PL Grzechotka
 DE Hebelumschaltknarre
 RU Трещотка
 CZ Ráčna
 HU Racsnis hajtókar
 RO Antrenor cu clichet
 FR Clé à cliquet
 IT Chiave a cricchetto
 ES Llave de carraca
 CN 快速脱落棘轮扳手

1/4" 6.3mm
 QUICK RELEASE SZYBKO-ZŁĄCZE

72T
 CrV 6135



YATO	Ø	T	L [mm]	PCS PER PKG	
YT-0733	1/4" (6.3 mm)	72	155	12	24/96

EN Ratchet handle and bit drive
 PL Grzechotka do bitów i nasadek
 DE Bit- und Steckschlüssel-Umschaltknarre
 RU Трещотка для битов и головок
 CZ Ráčna kombinovaná pro bity a nástrčné kľíče
 HU Bit és dugófej behajtó racsnis hajtókar
 RO Antrenor cu clichet pt. biți
 FR Clé à cliquet
 IT Cricchetto bussola per punte e snodi
 ES Carraca para boquillas y puntas
 CN 套筒旋具两用棘轮扳手

1/4" 6.3mm

1/4" 6.3mm

DIN 3122

72T

CrV 6140



YATO	Ø	T	L [mm]	PCS PER PKG	
YT-0331	1/4" (6.3 mm) x 1/4" (6.3 mm)	72	136	12	48

EN Swivel ratchet handle
 PL Grzechotka z obrotową głowicą
 DE Drehkopfratsche
 RU Трещотка с шарниром
 CZ Ráčna s otočnou hlavou
 HU Forgófejes racsnis szár
 HU Forgófejes racsnis szár
 RO Antrenor clichet cu articulație
 FR Cliquet à tête pivotante
 IT Cricchetto con testa rotante
 ES Carraca con cabeza giratoria
 CN 旋转头快速脱落棘轮扳手

1/4" 6.3mm

DIN 3122

72T

CrV

QUICK RELEASE SZYBKO-ZŁĄCZE



YATO	Ø	T	L [mm]	
YT-07200	1/4" (6.3 mm)	72	145	10/50

EN Hexagonal socket
PL Nasadka sześciokątna
DE Sechskantenschlüssel
RU Головка шестигранная короткая
CZ Šestihranný nástavec
HU Dugókulcs hatszög
RO Cheie tubulară hexagonală
FR Douille courte
IT Chiave a bussola esagonale
ES Boquilla hexagonal corta
CN 六角套筒

3/8"
9.5 mm

DIN
3121

CrV
50BV30

AS-DRIVE

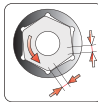
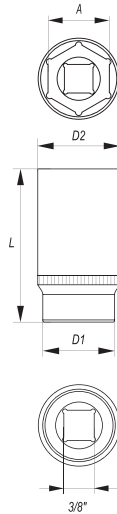

- Drive locks
- Surface finish: chromed, satin / mirror
- Zamki blokujące
- Wykończenie powierzchni: chromowana, satynowa / polerowana

YATO	∅ A [mm]	D1 [mm]	D2 [mm]	L [mm]	PCS	PCPS	
YT-3801	6	10	17	28	24	240/480	
YT-3802	7	11	17	28	24	240/480	
YT-3803	8	12	17	28	24	240/480	
YT-3804	9	13	17	28	24	240/480	
YT-3805	10	14	17	28	24	240/480	
YT-3806	11	16	17	28	24	240/480	
YT-3807	12	18	17	28	24	240/480	
YT-3808	13	19	18	28	24	240/480	
YT-3809	14	20	19	28	24	240/480	
YT-3810	15	21	19	28	12	240/480	
YT-3811	16	22	21	28	12	240/480	
YT-3812	17	24	22	30	12	120/240	
YT-3813	18	25	23	30	12	120/240	
YT-3814	19	26	24	30	12	120/240	

EN Extension bar
PL Przedłużka
DE Verlängerung
RU Удлинитель для воротка
CZ Prodlužovací přípravek
HU Toldalék

RO Prelungitor
FR Rallonge
IT Prolunga
ES Tubo de prolongación
CN 接杆

3/8"
9.5 mm

DIN
3121

CrV
50BV30

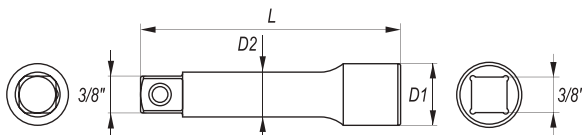

YATO	∅	D1 [mm]	D2 [mm]	L [mm]	PCS	PCPS	
YT-3842	3/8" (9.5 mm)	18	12.3	42.0	10	100/200	
YT-3843	3/8" (9.5 mm)	18	12.3	76.0	10	100/200	
YT-3844	3/8" (9.5 mm)	18	12.3	152.4	10	50/100	
YT-3845	3/8" (9.5 mm)	18	12.3	254.0	10	50	

EN Hexagonal deep socket
PL Nasadka sześciokątna długa
DE Sechskantenschlüssel, lange
RU Головка шестигранная длинная
CZ Šestihranný hluboký nástavec
HU Dugókulcs hatszög hosszú
RO Cheie tubulară hexagonală adâncă
FR Douille longue
IT Chiave a bussola esagonale
ES Boquilla hexagonal larga
CN 六角长套筒

3/8"
9.5 mm

DIN
3121

CrV
50BV30

AS-DRIVE

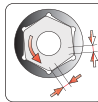
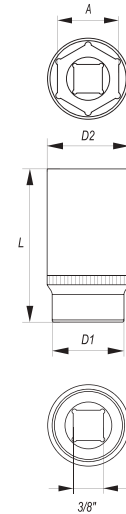

- Drive locks
- Surface finish: chromed, satin / mirror
- Zamki blokujące
- Wykończenie powierzchni: chromowana, satynowa / polerowana

YATO	∅ A [mm]	D1 [mm]	D2 [mm]	L [mm]	PCS	PCPS	
YT-3820	6	10	17	63	24	48/96	
YT-3821	7	10	17	63	24	48/96	
YT-3822	8	12	17	63	24	48/96	
YT-3823	9	13	17	63	24	48/96	
YT-3824	10	14	17	63	24	48/96	
YT-3825	11	16	17	63	24	48/96	
YT-3826	12	18	17	63	24	48/96	
YT-3827	13	19	17	63	24	48/96	
YT-3828	14	20	19	63	24	48/96	
YT-3829	15	21	19	63	12	60/120	
YT-3830	16	22	20	63	12	60/120	
YT-3831	17	24	23	63	12	60/120	
YT-3832	18	25	23	63	12	60/120	
YT-3833	19	26	24	63	12	60/120	

EN Extension bar with wobble
PL Przedłużka uchylna
DE Gelenkverlängerung
RU Удлинитель наклонный
CZ Odchylný prodlužovací přípravek
HU Csuklós toldalék

RO Prelungitor rabatabil
FR Rallonge angulaire
IT Prolunga
ES Tubo de prolongación desviado
CN 转向接杆

3/8"
9.5 mm

DIN
3121

CrV
50BV30

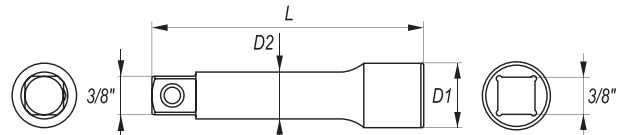

YATO	∅	D1 [mm]	D2 [mm]	L [mm]	PCS	PCPS	
YT-3847	3/8" (9.5 mm)	18	12.3	76.0	10	100/200	
YT-3848	3/8" (9.5 mm)	18	12.3	152.4	10	50/100	
YT-3849	3/8" (9.5 mm)	18	12.3	254.0	10	50	

- EN Adapter
- PL Redukcja
- DE Reduktion
- RU Переходник
- CZ Redukce
- HU Redukció
- RO Reducție
- FR Réduction
- IT Riduttore
- ES Reducción
- CN 转换头

3/8"
9.5 mm

DIN
3121

CrV
50BV30

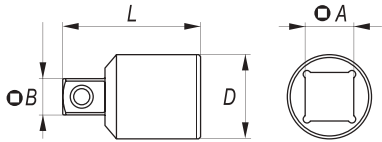



YATO	A	B	D [mm]	L [mm]	PCS PKG	
YT-3853	3/8" (9.5 mm) (F)	1/4" (6.3 mm) (M)	17	27	10	250/500
YT-3854	3/8" (9.5 mm) (F)	1/2" (12.7 mm) (M)	17	35	10	100/200

- EN Bit adapter
- PL Adapter do bitów
- DE Bithalter
- RU Держатель винтовёртовых наконечников
- CZ Držák na šroubovakové koncovky
- HU Szár a csavarhúzóvégekhez
- RO Adaptor biți
- FR Adapteur d'embouts
- IT Chiave esagonale a bussola
- ES Mandril para puntas
- CN 旋具头接头

3/8"
9.5 mm

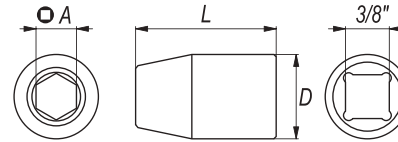
CrV
6140





YATO	A	D [mm]	L [mm]	PCS PKG	
YT-12961	3/8" (9.5 mm)	8	17.9	30	5/300

- EN Bit adapter
- PL Adapter do bitów
- DE Bithalter
- RU Держатель винтовёртовых наконечников
- CZ Držák na šroubovakové koncovky
- HU Szár a csavarhúzóvégekhez
- RO Adaptor biți
- FR Adapteur d'embouts
- IT Chiave esagonale a bussola
- ES Mandril para puntas
- CN 旋具头接头

3/8"
9.5 mm

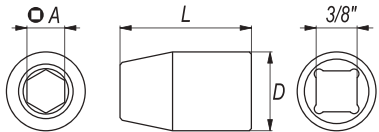
CrV
6140

YATO	A	D [mm]	L [mm]	PCS PKG		
YT-1296	3/8" (9.5 mm)	8	17.9	30	10	250/500

- EN Universal joint
- PL Przegub Cardana
- DE Kardangelenk
- RU Карданный шарнир
- CZ Kardanový kloub
- HU Kardán csukló
- RO Articulație Cardanică
- FR Cardan
- IT Snodo cardanico
- ES Articulación Cardan
- CN 万向接头

3/8"
9.5 mm

DIN
3121

CrV
50BV30

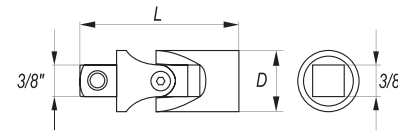
YATO	A	D [mm]	L [mm]	PCS PKG	
YT-3850	3/8" (9.5 mm)	18	49	10	50/200

- EN Sliding T-bar
- PL Pokrętko typu „T”
- DE Handgriff mit Gleitstück
- RU Вороток Т-образный
- CZ Otočná račka typ „T”
- HU „T” alakú hajtókar
- RO Antrenor culisabil tip „T”
- FR Barre type „T”
- IT Manopola „T” scorrevole
- ES Mango tipo „T”
- CN 滑行杆

3/8"
9.5 mm

CrV
50BV30

DIN
3121

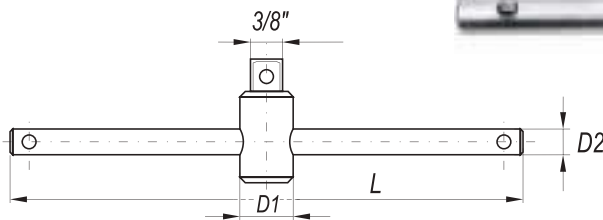
YATO	A	D1 [mm]	D2 [mm]	L [mm]	PCS PKG	
YT-3840	3/8" (9.5 mm)	20	10.7	198	10	50/100

- EN Flexible handle
- PL Pokrętko lamane
- DE Gelenkgriff
- RU Вороток шарнирный
- CZ Otočná lomená ráčka
- HU Dugókulcs hatszög hosszú
- RO Antrenor drept cu prindere flexibilă
- FR Barre pivotante
- IT Manopola a snodo
- ES Mango articulado
- CN 转向手柄

3/8"
9.5 mm

DIN
3121

CrV
50BV30

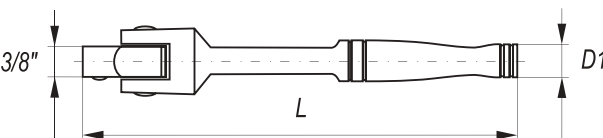
YATO	A	D [mm]	L [mm]	PCS PKG	
YT-3839	3/8" (9.5 mm)	16	215	8	24/48

EN Quick release ratchet handle
PL Grzechotka
DE Hebelumschaltknarre
RU Трещотка
CZ Ráčna
HU Racsnis hajtókar
RO Antrenor cu clichet
FR Clé à cliquet
IT Chiave a cricchetto
ES Llave de carraca
CN 快速脱落棘轮扳手

3/8" 9.5 mm
DIN 3122
QUICK RELEASE SZYBKO-ZŁĄCZE
72T
CrV 6140



YATO	Ø	T	L [mm]	PCS ROZB.	Box
YT-0308	3/8" (9.5 mm)	72	185	6	24/48



YATO	Ø	T	L [mm]	PCS ROZB.	Box
YT-0311	3/8" (9.5 mm)	72	200	6	18/36



YATO	Ø	T	L [mm]	PCS ROZB.	Box
YT-0314	3/8" (9.5 mm)	72	170	6	24/48



YATO	Ø	T	L [mm]	PCS ROZB.	Box
YT-0317	3/8" (9.5 mm)	72	200	6	24/48



YATO	Ø	T	L [mm]	PCS ROZB.	Box
YT-0323	3/8" (9.5 mm)	72	197	6	24/48

EN Quick release ratchet handle
PL Grzechotka
DE Hebelumschaltknarre
RU Трещотка
CZ Ráčna
HU Racsnis hajtókar
RO Antrenor cu clichet
FR Clé à cliquet
IT Chiave a cricchetto
ES Carraca
CN 快速脱落棘轮扳手

3/8" 9.5 mm
QUICK RELEASE SZYBKO-ZŁĄCZE
90T
CrV
CrMo



YATO	Ø	T	L [mm]	PCS ROZB.	Box
YT-03242	3/8" (9.5 mm)	90	210	6/36	

EN Flexible ratchet handle
PL Grzechotka z przegubem
DE Gelenk-Hebelumschaltknarre
RU Трещотка шарнирная
CZ Kloubová ráčna
HU Csuklós racsni
RO Antrenor cu clichet flexibil
FR Clé à cliquet articulée
IT Cricchetto articolato
ES Llave de carraca articulada
CN 棘轮扳手

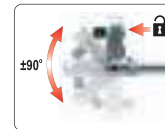

3/8" 9.5 mm
QUICK RELEASE SZYBKO-ZŁĄCZE
DIN 3122
72T
CrV 6140



YATO	Ø	T	L [mm]	PCS ROZB.	Box
YT-0326	3/8" (9.5 mm)	72	242	6	24/48

EN Composite ratchet handle
PL Grzechotka powlekana
DE Verbundwerkstoff-Ratsche
RU Трещотка композитная
CZ Ráčna kompozitní
HU Racsnis hajtókar
RO Antrenor cu clichet
FR Clé à cliquet
IT Cricchetto composito
ES Llave de carraca
CN 快速脱落棘轮扳手

3/8" 9.5 mm
DIN 3122
QUICK RELEASE SZYBKO-ZŁĄCZE
72T
CrV 6135



YATO	Ø	T	L [mm]	PCS ROZB.	Box
YT-0291	3/8" (9.5 mm)	72	202	6	24/48



YATO	Ø	T	L [mm]	PCS ROZB.	Box
YT-0294	3/8" (9.5 mm)	72	202	6	24/48

EN Quick release ratchet handle
PL Grzechotka
DE Hebelumschaltknarre
RU Трещотка
CZ Ráčna
HU Racsnis hajtókar
RO Antrenor cu clichet
FR Clé à cliquet
IT Chiave a cricchetto
ES Llave de carraca
CN 快速脱落棘轮扳手

3/8" 9.5 mm
QUICK RELEASE SZYBKO-ZŁĄCZE
72T
CrV 6140



YATO	Ø	T	L [mm]	PCS ROZB.	Box
YT-0731	3/8" (9.5 mm)	72	200	6	6/48

EN Telescopic ratchet handle
PL Grzechotka z przedłużanym uchwytem
DE Umschaltknarre ausziehbar
RU Трещотка телескопическая
CZ Ráčna teleskopická
HU Racsnis hajtókar teleszkópos
RO Antrenor cu clichet telescopic
FR Clé à cliquet télescopique
IT Chiave a cricchetto telescopico
ES Llave carraca telescópica
CN 可伸缩快速脱落棘轮扳手



3/8" 9.5 mm
QUICK RELEASE SZYBKO-ZŁĄCZE
72T
CrV 6135



YATO	Ø	T	L [mm]	PCS ROZB.	Box
YT-0298	3/8" (9.5 mm)	72	215-315	6	6/24

EN Swivel ratchet handle
PL Grzechotka z obrotową głowicą
DE Drehkopfratsche
RU Трещотка с шарниром
CZ Ráčna s otočnou hlavou
HU Forgófejes racsnis szár
RO Antrenor clichet cu articulație
FR Cliquet à tête pivotante
IT Cricchetto con testa rotante
ES Carraca con cabeza giratoria
CN 旋转头快速脱落棘轮扳手



3/8" 9.5 mm
DIN 3122
QUICK RELEASE SZYBKO-ZŁĄCZE
72T
CrV

YATO	Ø	T	L [mm]	PCS ROZB.	Box
YT-07201	3/8" (9.5 mm)	72	195	5/25	

EN Hexagonal socket
 PL Nasadka sześciokątna
 DE Sechskantenschlüssel
 RU Головка шестигранная короткая
 CZ Šestihranný nástavec
 HU Dugókulcs hatszög
 RO Cheie tubulară hexagonală
 FR Douille courte
 IT Chiave a bussola esagonale
 ES Boquilla hexagonal corta
 CN 六角套筒

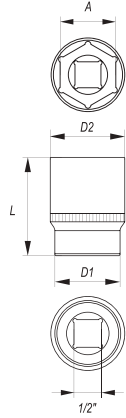

1/2"
12.7mm
DIN 3121
CrV 50BV30
AS-DRIVE

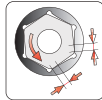

- Drive locks
- Surface finish: chromed, satin / mirror
- Zamki blokujące
- Wykończenie powierzchni: chromowana, satynowa / polerowana

YATO	∅ A [mm]	D1 [mm]	D2 [mm]	L [mm]	PCS PER PKG	
YT-1201	8	12	22	38	12	120/240
YT-1202	9	14	22	38	12	120/240
YT-1203	10	15	22	38	12	120/240
YT-1204	11	16	22	38	12	120/240
YT-1205	12	18	22	38	12	120/240
YT-1206	13	19	22	38	12	120/240
YT-1207	14	20	22	38	12	120/240
YT-1208	15	21	22	38	12	120/240
YT-1209	16	23	22	38	12	120/240
YT-1210	17	24	23	38	12	120/240
YT-1211	18	25	23	38	12	120/240
YT-1212	19	27	24	38	12	120/240
YT-1213	20	28	24	38	12	120/240
YT-1214	21	29	24	38	12	120/240
YT-1215	22	30	26	38	12	120/240
YT-1216	23	31	28	38	12	60/120
YT-1217	24	32	28	38	12	60/120
YT-1218	27	36	30	42	12	60/120
YT-1219	30	40	34	42	12	60/120
YT-1220	32	42	36	42	6	24/48

EN Spline socket
 PL Nasadka Spline
 DE Steckschlüssel Spline
 RU Головка Spline
 CZ Nástrčný klíč profil Spline
 HU Dugókulcs Spline
 RO Cheie tubulară Spline
 FR Douille
 IT Chiave a bussola Spline
 ES Boquilla Spline
 CN 花键型套筒

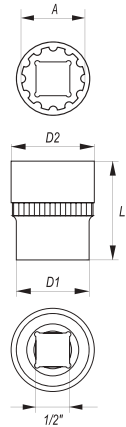

1/2"
12.7mm
DIN 3121
CrV 50BV30

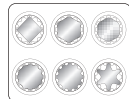

- Drive locks
- Enables to undo 5 types of screws
- Surface finish: chromed, satin / mirror
- Zamki blokujące
- Możliwość odkręcenia 5 rodzajów śrub
- Wykończenie powierzchni: chromowana, satynowa / polerowana

YATO	∅ A [mm]	D1 [mm]	D2 [mm]	L [mm]	PCS PER PKG	
YT-1460	8	13	22	38	12	120/240
YT-1461	9	15	22	38	12	120/240
YT-1462	10	16	22	38	12	120/240
YT-1463	11	17	22	38	12	120/240
YT-1464	12	18	22	38	12	120/240
YT-1465	13	19	22	38	12	120/240
YT-1466	14	20	22	38	12	120/240
YT-1467	15	22	23	38	12	120/240
YT-1468	16	23	22	38	12	120/240
YT-1469	17	25	23	38	12	120/240
YT-1470	18	26	23	38	12	120/240
YT-1471	19	27	24	38	12	120/240
YT-1472	20	28	24	38	12	120/240
YT-1473	21	30	24	38	12	120/240
YT-1474	22	31	26	38	12	120/240
YT-1475	23	32	28	38	12	60/120
YT-1476	24	34	28	38	12	60/120
YT-1478	27	37	30	42	12	60/120
YT-1480	30	41	34	42	6	60/120
YT-1481	32	44	36	42	6	60/120

EN Bi-hexagonal socket
 PL Nasadka dwunastokątna
 DE Zwölfkant-Steckschlüssel-Einsatz
 RU Головка 12-гранная
 CZ Nástrčný oheč dvanáctihranný
 HU Dugókulcs 12-szögű
 RO Cheie tubulară bihexagonală
 FR Douille courte
 IT Chiave a bussola bi-esagonale
 ES Boquilla de anillo
 CN 十二角套筒

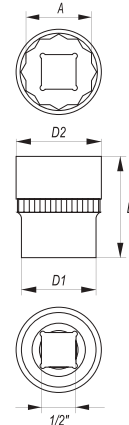

1/2"
12.7mm
DIN 3121
CrV 50BV30
AS-DRIVE

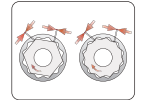

- Drive locks
- Surface finish: chromed, satin / mirror
- Zamki blokujące
- Wykończenie powierzchni: chromowana, satynowa / polerowana

YATO	∅ A [mm]	D1 [mm]	D2 [mm]	L [mm]	PCS PER PKG	
YT-1270	8	12	22	38	12	120/240
YT-1271	9	14	22	38	12	120/240
YT-1272	10	15	22	38	12	120/240
YT-1273	11	16	22	38	12	120/240
YT-1274	12	17	22	38	12	120/240
YT-1275	13	19	22	38	12	120/400
YT-1276	14	20	22	38	12	120/400
YT-1277	15	21	22	38	12	120/240
YT-1278	16	23	22	38	12	120/240
YT-1279	17	24	22	38	12	120/240
YT-1280	18	25	23	38	12	120/240
YT-1281	19	27	24	38	12	120/240
YT-1282	20	28	24	38	12	120/240
YT-1283	21	29	24	38	12	120/240
YT-1284	22	30	26	38	12	120/240
YT-1285	23	31	28	38	12	60/120
YT-1286	24	32	28	38	12	60/120
YT-1289	27	36	30	42	12	60/120
YT-1291	30	40	34	42	6	48/96
YT-1292	32	42	36	42	6	48/96

EN Spline socket
 PL Nasadka Spline
 DE Steckschlüssel Spline
 RU Головка Spline
 CZ Nástrčný klíč profil Spline
 HU Dugókulcs Spline
 RO Cheie tubulară Spline
 FR Douille
 IT Chiave a bussola Spline
 ES Boquilla Spline
 CN 花键型套筒

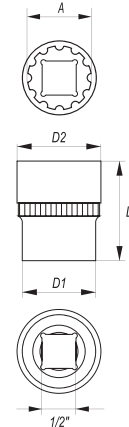

1/2"
12.7mm
CrV 50BV30

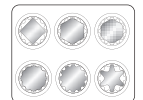

- Drive locks
- Enables to undo 5 types of screws
- Surface finish: chromed, satin / mirror
- Zamki blokujące
- Możliwość odkręcenia 5 rodzajów śrub
- Wykończenie powierzchni: chromowana, satynowa / polerowana

YATO	∅ A [mm]	D1 [mm]	D2 [mm]	L [mm]	PCS PER PKG	
YT-14820	8	13	22	38	10/200	
YT-14821	9	15	22	38	10/200	
YT-14822	10	16	22	38	10/200	
YT-14824	12	18	22	38	10/200	
YT-14825	13	19	22	38	10/200	
YT-14826	14	20	22	38	10/200	
YT-14827	15	22	22	38	10/200	
YT-14828	16	23	22	38	10/200	
YT-14829	17	25	23	38	10/200	
YT-14830	18	26	23	38	10/200	
YT-14831	19	27	24	38	10/200	
YT-14833	21	30	24	38	10/160	
YT-14834	22	31	26	38	10/160	
YT-14836	24	34	28	38	10/160	
YT-14838	30	41	34	42	5/60	
YT-14839	32	44	36	45	5/60	

EN Hexagonal deep socket
PL Nasadka sześciokątna długa
DE Sechskantenschlüssel, lange
RU Головка шестигранная длинная
CZ Šestihranný hluboký nástavec
HU Dugókulcs hatszög hosszú
RO Cheie tubulară hexagonală adâncă
FR Douille longue
IT Chiave a bussola esagonale
ES Boquilla hexagonal larga
CN 六角长套筒

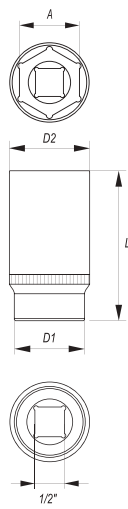

1/2"
12.7mm
DIN 3121
CrV 50BV30
AS-DRIVE

- Drive locks
- Surface finish: chromed, satin / mirror
- Zamki blokujące
- Wykończenie powierzchni: chromowana, satynowa / polerowana

YATO	o A [mm]	D1 [mm]	D2 [mm]	L [mm]	PCS FRONT	CS
YT-1221	8	13	22	76	12	60/120
YT-1222	9	14	22	76	12	60/120
YT-1223	10	15	22	76	12	60/120
YT-1224	11	17	22	76	12	60/120
YT-1225	12	18	22	76	12	60/120
YT-1226	13	19	22	76	12	60/120
YT-1227	14	20	22	76	12	60/120
YT-1228	15	21	22	76	12	60/120
YT-1229	16	24	22	76	12	60/120
YT-1230	17	24	22	76	12	60/120
YT-1231	18	25	23	76	12	60/120
YT-1232	19	27	24	76	12	60/120
YT-1233	20	28	24	76	12	60/120
YT-1234	21	29	24	76	12	60/120
YT-1235	22	30	26	76	12	60/120
YT-1236	23	31	28	76	12	60/120
YT-1237	24	32	28	76	12	60/120
YT-1238	27	36	30	76	12	36/72
YT-1239	30	40	36	76	12	24/48
YT-1240	32	42	38	76	6	24/48

EN Bi-hexagonal deep socket
PL Nasadka dwunastokątna długa
DE Zwölfkant-Steckschlüssel-Einsatz, lange
RU Головка 12-гранная длинная
CZ Dvanáctihřanný hluboký nástavec
HU Dugókulcs 12-szögű hosszú
RO Cheie tubulară bihexagonală adâncă
FR Douille longue
IT Chiave a bussola bi-esagonale
ES Boquilla de anillo larga
CN 十二角长套筒

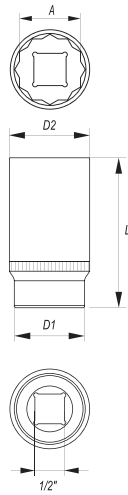

1/2"
12.7mm
DIN 3121
CrV 50BV30
AS-DRIVE

YATO	o A [mm]	D1 [mm]	D2 [mm]	L [mm]	PCS FRONT	CS
YT-12930	8	22	14	77	12	60/120
YT-12931	9	22	16	77	12	60/120
YT-12932	10	22	16	77	12	60/120
YT-12933	11	22	18	77	12	60/120
YT-12934	12	22	18	77	12	60/120
YT-12935	13	22	19	77	12	60/120
YT-12936	14	22	19	77	12	60/120
YT-12937	15	21	22	77	12	60/120
YT-12938	16	21	22	77	12	60/120
YT-12939	17	22	24	77	12	60/120
YT-12940	18	22	26	77	12	60/120
YT-12941	19	22	26	77	12	60/120
YT-12942	20	24	28	77	12	60/120
YT-12943	21	24	28	77	12	60/120
YT-12944	22	26	30	77	12	60/120
YT-12945	23	27	32	77	12	60/120
YT-12946	24	28	32	77	12	60/120
YT-12947	27	30	36	77	12	36/72
YT-12948	30	34	40	77	6	24/48
YT-12949	32	36	42	77	6	24/48

EN Extension bar
PL Przedłużka
DE Verlängerung
RU Удлинитель для воротка
CZ Prodlužovací přípravek
HU Toldalék

RO Prelungitor
FR Rallonge
IT Prolunga
ES Tubo de prolongación
CN 接杆

1/2"
12.7mm
DIN 3121
CrV 50BV30

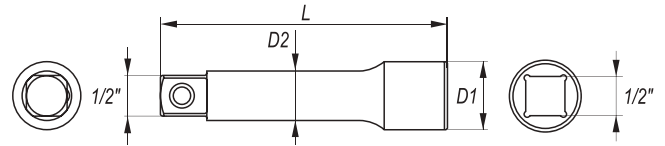

YATO	o	D1 [mm]	D2 [mm]	L [mm]	PCS FRONT	CS
YT-1246	1/2" (12.7 mm)	24	14.5	76	15	30/120
YT-1247	1/2" (12.7 mm)	24	14.5	127	5	20/80
YT-1248	1/2" (12.7 mm)	24	14.5	254	5	20/40

EN Extension bar with wobble
PL Przedłużka uchylina
DE Gelenkverlängerung
RU Удлинитель наклонный
CZ Odchylný prodlužovací přípravek
HU Csuklós toldalék

RO Prelungitor rabatabil
FR Rallonge angulaire
IT Prolunga
ES Tubo de prolongación desviado
CN 转向接杆

1/2"
12.7mm
DIN 3121
CrV 50BV30

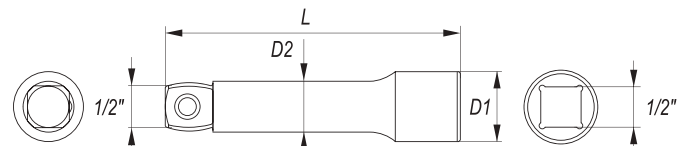

YATO	o	D1 [mm]	D2 [mm]	L [mm]	PCS FRONT	CS
YT-1249	1/2" (12.7 mm)	24	14.5	76	15	30/120
YT-1250	1/2" (12.7 mm)	24	14.5	127	5	20/80
YT-1251	1/2" (12.7 mm)	24	14.5	254	5	20/40

EN Adapter
PL Redukcja
DE Reduktion
RU Переходник
CZ Redukce
HU Redukció
RO Reducție
FR Réduction
IT Riduttore
ES Reducción
CN 转换头

1/2" 12.7mm 3/4" 19mm DIN 3121 CrV 50BV30

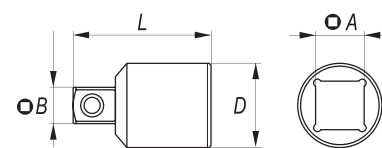

YATO	o A	o B	D [mm]	L [mm]	PCS FRONT	CS
YT-1255	1/2" (12.7 mm) (F)	3/8" (9.5 mm) (M)	22	34.0	10	100/200
YT-1258	1/2" (12.7 mm) (F)	3/4" (19.0 mm) (M)	27	45.5	10	50/100
YT-1259	3/4" (19.0 mm) (F)	1/2" (12.7 mm) (M)	35	51.0	5	50/100
YT-1356	1/2" (12.7 mm) (F)	3/4" (19.0 mm) (M)	26	48.0	12	48

- EN Bit adapter
- PL Adapter do bitów
- DE Bithalter
- RU Держатель винтовёртовых наконечников
- CZ Držák na šroubovakové koncovky
- HU Szár a csavarhúzóvégekhez
- RO Adaptor biți
- FR Adapteur d'embouts
- IT Chiave esagonale a bussola
- ES Mandril para puntas
- CN 旋具头接头

1/2"
12.7mm

CrV
6140

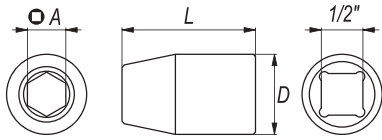
- EN Bit adapter
- PL Adapter do bitów
- DE Bithalter
- RU Держатель винтовёртовых наконечников
- CZ Držák na šroubovakové koncovky
- HU Szár a csavarhúzóvégekhez
- RO Adaptor biți
- FR Adapteur d'embouts
- IT Chiave esagonale a bussola
- ES Mandril para puntas
- CN 旋具头接头

1/2"
12.7mm

CrV
6140

YATO	Ø	Ø A [mm]	D [mm]	L [mm]	PCS PCBSE	Icon
YT-12951	1/2" (12.7 mm)	8	21.9	38	5/300	

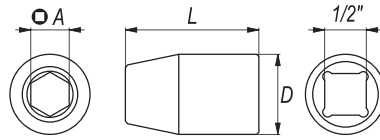
YATO	Ø	Ø A [mm]	D [mm]	L [mm]	PCS PCBSE	Icon
YT-1295	1/2" (12.7 mm)	8	21.9	38	10/150/300	

- EN Universal joint
- PL Przegub Cardana
- DE Kardangelenk
- RU Карданный шарнир
- CZ Kardanový kloub
- HU Kardán csukló
- RO Articulație Cardanică
- FR Cardan
- IT Snodo cardanico
- ES Articulación Cardan
- CN 万向接头



1/2"
12.7mm

DIN
3121

CrV
50BV30

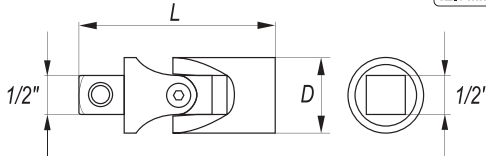
YATO	Ø	D [mm]	L [mm]	PCS PCBSE	Icon
YT-1252	1/2" (12.7 mm)	25	69	5/50/100	

- EN Sliding T-bar
- PL Pokreślto typu „T”
- DE Handgriff mit Gleitstück
- RU Вороток Т-образный
- CZ Otočná ráčká typ „T”
- HU „T” alakú hajtókár
- RO Antrenor culisabil tip „T”
- FR Barre type „T”
- IT Manopola „T” scorrevole
- ES Mango tipo „T”
- CN 滑行杆

1/2"
12.7mm

DIN
3121

CrV
50BV30

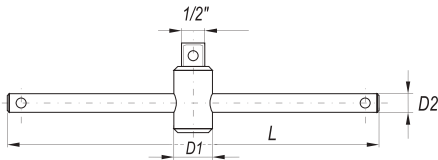
YATO	Ø	D1 [mm]	D2 [mm]	L [mm]	PCS PCBSE	Icon
YT-1243	1/2" (12.7 mm)	24	13.5	255	4/24/48	

- EN Flexible handle
- PL Pokreślto lamane
- DE Gelenkgriff
- RU Вороток шарнирный
- CZ Otočná lomená ráčka
- HU Hajlított hajtókár
- RO Antrenor drept cu prindere flexibilă
- FR Barre pivotante
- IT Manopola a snodo
- ES Mango articulado
- CN 转向手柄

1/2"
12.7mm

DIN
3121

CrV
50BV30

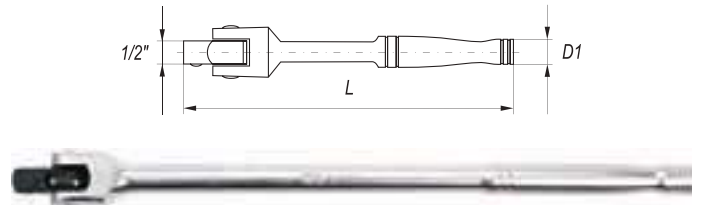
YATO	Ø	D [mm]	L [mm]	PCS PCBSE	Icon
YT-1241	1/2" (12.7 mm)	19	360	5/15/30	
YT-1242	1/2" (12.7 mm)	20	457	5/10/20	

- EN L-type handle
- PL Pokreślto typu „L”
- DE Admutterenschlüssel
- RU Вороток тип „L”
- CZ Páka zahnutá
- HU „L” alakú hajtókár
- RO Antrenor tip „L”
- FR Barre type „L”
- IT Leva tipo „L”
- ES Mango tipo „L”
- CN L型套筒扳手

1/2"
12.7mm

DIN
3121

CrV
50BV30

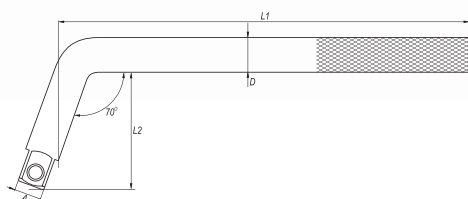
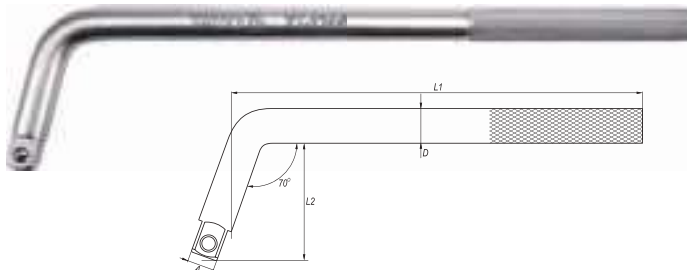
YATO	Ø	D [mm]	L1 [mm]	L2 [mm]	PCS PCBSE	Icon
YT-1244	1/2" (12.7 mm)	16	330	62	3/36	

- EN L-type handle
- PL Pokreślto typu „L”
- DE Admutterenschlüssel
- RU Вороток тип „L”
- CZ Páka zahnutá
- HU „L” alakú hajtókár
- RO Antrenor tip „L”
- FR Barre type „L”
- IT Leva tipo „L”
- ES Mango tipo „L”
- CN L型扳手

1/2"
12.7mm

DIN
3122

CrV
50BV30

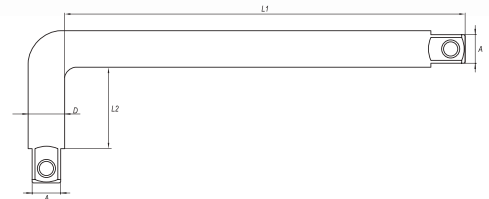
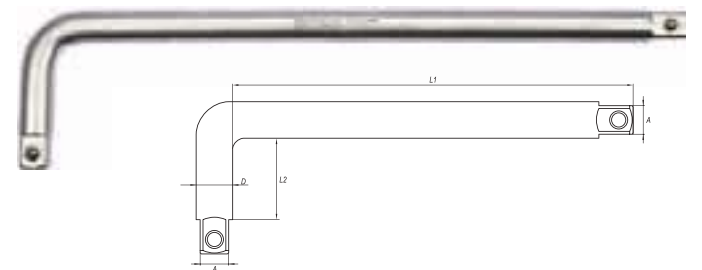
YATO	Ø	D [mm]	L1 [mm]	L2 [mm]	PCS PCBSE	Icon
YT-12439	1/2" (12.7 mm)	16	282	55	10/20	
YT-12445	1/2" (12.7 mm)	16	585	190	4/4/12	

EN Quick release ratchet handle
 PL Grzechotka
 DE Hebelumschaltknarre
 RU Трещотка
 CZ Ráčna
 HU Racsnis hajtókar

RO Antrenor cu clichet
 FR Clé à cliquet
 IT Chiave a cricchetto
 ES Llave de carraca
 CN 快速脱落棘轮扳手

1/2" 12.7mm
 DIN 3122
 QUICK RELEASE SZYBKO-ZŁĄCZE
 72T CrV 6140



YATO	Ø	T	L [mm]	PCS FRONT	
YT-0309	1/2" (12.7 mm)	72	278	6	24



YATO	Ø	T	L [mm]	PCS FRONT	
YT-0312	1/2" (12.7 mm)	72	250	6	12/24



YATO	Ø	T	L [mm]	PCS FRONT	
YT-0315	1/2" (12.7 mm)	72	250	6	24



YATO	Ø	T	L [mm]	PCS FRONT	
YT-0318	1/2" (12.7 mm)	72	250	6	24



YATO	Ø	T	L [mm]	PCS FRONT	
YT-0324	1/2" (12.7 mm)	72	265	6	24

EN Quick release ratchet handle
 PL Grzechotka
 DE Hebelumschaltknarre
 RU Трещотка
 CZ Ráčna
 HU Racsnis hajtókar

RO Antrenor cu clichet
 FR Clé à cliquet
 IT Chiave a cricchetto
 ES Llave de carraca
 CN 快速脱落棘轮扳手

1/2" 12.7mm
 QUICK RELEASE SZYBKO-ZŁĄCZE
 72T CrV 6140



YATO	Ø	T	L [mm]	PCS FRONT	
YT-0732	1/2" (12.7 mm)	72	255	6	24

EN Telescopic ratchet handle
 PL Grzechotka z przedłużonym uchwytem
 DE Umschaltknarre ausziehbar
 RU Трещотка телескопическая
 CZ Ráčna teleskopická
 HU Racsnis hajtókar teleszkópos
 RO Antrenor cu clichet telescopice
 FR Clé à cliquet télescopique
 IT Chiave a cricchetto telescopico
 ES Llave carraca telescópica
 CN 可伸缩快速脱落棘轮扳手



1/2" 12.7mm
 QUICK RELEASE SZYBKO-ZŁĄCZE
 72T CrV 6135



YATO	Ø	T	L [mm]	PCS FRONT	
YT-0299	1/2" (12.7 mm)	72	305-445	6	24

EN Quick release ratchet handle
 PL Grzechotka
 DE Hebelumschaltknarre
 RU Трещотка
 CZ Ráčna
 HU Racsnis hajtókar
 RO Antrenor cu clichet
 FR Clé à cliquet
 IT Chiave a cricchetto
 ES Carraca
 CN 快速脱落棘轮扳手

1/2" 12.7mm
 QUICK RELEASE SZYBKO-ZŁĄCZE
 90T CrV CrMo



YATO	Ø	T	L [mm]	
YT-03243	1/2" (12.7 mm)	90	255	4/24

EN Flexible ratchet handle
 PL Grzechotka z przegubem
 DE Gelenk-Hebelumschaltknarre
 RU Трещотка шарнирная
 CZ Kloubová ráčna
 HU Csuklós racsnis
 RO Antrenor cu clichet flexibil
 FR Clé à cliquet articulée
 IT Cricchetto articolato
 ES Llave de carraca articulada
 CN 棘轮扳手

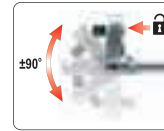

1/2" 12.7mm
 QUICK RELEASE SZYBKO-ZŁĄCZE
 DIN 3122
 72T CrV 6140



YATO	Ø	T	L [mm]	PCS FRONT	
YT-0327	1/2" (12.7 mm)	72	290	6	1/24

EN Composite ratchet handle
 PL Grzechotka powlekana
 DE Verbundwerkstoff-Ratsche
 RU Трещотка композитная
 CZ Ráčna kompozitní
 HU Racsnis hajtókar

RO Antrenor cu clichet
 FR Clé à cliquet
 IT Cricchetto composito
 ES Llave de carraca
 CN 快速脱落棘轮扳手

1/2" 12.7mm
 DIN 3122
 QUICK RELEASE SZYBKO-ZŁĄCZE
 72T CrV 6135



YATO	Ø	T	L [mm]	PCS FRONT	
YT-0292	1/2" (12.7 mm)	72	257	6	24



YATO	Ø	T	L [mm]	PCS FRONT	
YT-0295	1/2" (12.7 mm)	72	257	6	24

EN Quick release ratchet handle
 PL Grzechotka
 DE Hebelumschaltknarre
 RU Трещотка
 CZ Ráčna
 HU Racsnis hajtókar

RO Antrenor cu clichet
 FR Clé à cliquet
 IT Chiave a cricchetto
 ES Llave de carraca
 CN 快速脱落棘轮扳手

1/2" 12.7mm
 QUICK RELEASE SZYBKO-ZŁĄCZE
 72T CrV 6135



YATO	Ø	T	L [mm]	PCS FRONT	
YT-0735	1/2" (12.7 mm)	72	255	6	24

EN Swivel ratchet handle
 PL Grzechotka z obrotową głowicą
 DE Drehkopfratsche
 RU Трещотка с шарниром
 CZ Ráčna s otočnou hlavou
 HU Forgófejes racsnis szár
 RO Antrenor clichet cu articulație
 FR Cliquet à tête pivotante
 IT Cricchetto con testa rotante
 ES Carraca con cabeza giratoria
 CN 旋转头快速脱落棘轮扳手

1/2" 12.7mm
 DIN 3122
 QUICK RELEASE SZYBKO-ZŁĄCZE
 72T CrV



YATO	Ø	T	L [mm]	
YT-07202	1/2" (12.7 mm)	72	255	5/20

EN Deep socket set
 PL Zestaw nasadek długich
 DE Lange Steckschlüsselsatz
 RU Набор глубоких головок
 CZ Sada hlubokých nástavců
 HU Hosszú dugókulcs készlet
 RO Set tubulare adânci
 FR Jeu de douilles longues
 IT Set di chiavi a bussola lunghe
 ES Juego de vasos largos
 CN 套筒组套

8
PCS



1/4"
6.3mm

CrV
50BV30

AS-DRIVE



 1/4" (6.3 mm): 5.5, 6, 7, 8, 9, 10, 12, 13 mm (L=50 mm); CrV 50BV30

YATO 		
YT-14431	1/4" (6.3 mm)	10/20

EN Tool set
 PL Zestaw narzędziowy
 DE Werkzeug-Satz
 RU Набор инструментов

CZ Sada nářadí
 HU Szerszámkészlet
 RO Trusa de scule
 FR Jeu d'outils

IT Set di utensili
 ES Juego de herramientas
 CN 工具组套

20
PCS

1/4"
6.3mm

CrV
50BV30

CrMo
440

72T

AS-DRIVE



EN Tool set
 PL Zestaw narzędziowy
 DE Werkzeug-Satz
 RU Набор инструментов

CZ Sada nářadí
 HU Szerszámkészlet
 RO Trusa de scule
 FR Jeu d'outils

IT Set di utensili
 ES Juego de herramientas
 CN 工具组套

23
PCS

1/4"
6.3mm

CrV
50BV30

CrMo
440

72T

AS-DRIVE



EN Socket set and accessories
 PL Zestaw nasadek z akcesoriami
 DE Steckschlüsselsatz mit Zubehör
 RU Набор головок с принадлежностями
 CZ Sada nástavců s příslušenstvím
 HU Dugókulcs készlet tartozékokkal
 RO Trusă tubulară cu accesorii
 FR Jeu de douilles et accessoires
 IT Set di chiavi a bussola con accessori
 ES Juego de vasos y accesorios
 CN 套筒组套

12
PCS

1/4"
6.3mm



CrV
50BV30



CrV
6140







72T



AS-DRIVE











 1/4" (6.3 mm): 4, 5, 6, 7, 8, 9, 10, 11, 12, 13 mm (L=25 mm); CrV 50BV30;
 1/4" (6.3 mm); (101.6 mm); CrV 50BV30;
 1/4" (6.3 mm); (155 mm); 72T; CrV 6140

YATO 		
YT-14432	1/4" (6.3 mm)	5/20

 1/4" (6.3 mm): 3.5, 4, 4.5, 5, 5.5, 6, 7, 8, 9, 10, 11, 12, 13, 14 mm (L=25 mm); CrV 50BV30;
 1/4" (6.3 mm); (51.6, 151.5 mm); CrV 50BV30;
 1/4" (6.3 mm); CrV 50BV30;
 1/4" (6.3 mm); (152.8 mm); CrV 50BV30;
 1/4" (6.3 mm); (155 mm); 72T; CrMo 440;
 1/4" (6.3 mm); (150 mm); CrV 50BV30

YATO 		
YT-14491	1/4" (6.3 mm)	10

 1/4" (6.3 mm): 4, 5, 6, 7, 8, 9, 10, 12, 13 mm (L=25 mm); CrV 50BV30;
 1/4" (6.3 mm): 4, 5, 6, 7, 8, 9, 10, 12, 13 mm (L=50 mm); CrV 50BV30;
 1/4" (6.3 mm); (50.8, 152.4 mm); CrV 50BV30;
 1/4" (6.3 mm); CrV 50BV30;
 1/4" (6.3 mm); (155 mm); 72T; CrMo 440;
 1/4" (6.3 mm); (150 mm); CrV 50BV30

YATO 		
YT-14451	1/4" (6.3 mm)	10

EN Tool set
PL Zestaw narzędziowy
DE Werkzeug-Satz
RU Набор инструментов

CZ Sada nářadí
HU Szerszámkészlet
RO Trusa de scule
FR Jeu d'outils

IT Set di utensili
ES Juego de herramientas
CN 工具组套

25
PCS

1/4"
6.3mm

CrV
50BV30

CrMo
440

CrV
40

72T

AS-DRIVE



1/4" (6.3 mm): 3.5, 4, 4.5, 5, 5.5, 6, 7, 8, 9, 10, 11, 12, 13, 14 mm (L=25 mm); CrV 50BV30;
1/4" (6.3 mm): 8, 10, 11, 12, 13 mm (L=50 mm); CrV 50BV30;
1/4" (6.3 mm): (50.8, 101.6 mm); CrV 50BV30;
1/4" (6.3 mm); CrV 50BV30;
1/4" (6.3 mm); (152.4 mm); CrV 40;
1/4" (6.3 mm); (155 mm); 72T; CrMo 440;
1/4" (6.3 mm); (150 mm); CrV 50BV30

YATO	○	
YT-14461	1/4" (6.3 mm)	10

EN Socket set and accessories
PL Zestaw nasadek z akcesoriami
DE Steckschlüsselsatz mit Zubehör
RU Набор головок с принадлежностями
CZ Sada nástavců s příslušenstvím
HU Dugókulcs készlet tartozékokkal
RO Trusă tubulare cu accesorii
FR Jeu de douilles et accessoires
IT Set di chiavi a bussola con accessori
ES Juego de vasos y accesorios
CN 套筒组套

28
PCS

1/4"
6.3mm

CrV
50BV30

CrV
6150

CrV
6140

S2

72T

AS-DRIVE



1/4" (6.3 mm): 4, 4.5, 5, 5.5, 6, 7, 8, 9, 10, 11, 12, 13, 14 mm (L=25 mm); CrV 50BV30;
1/4" (6.3 mm); (101.6 mm); CrV 50BV30;
1/4" (6.3 mm); (155 mm); 72T; CrV 6140;
1/4" (6.3 mm): 5.5, 7 mm (L=37 mm); AISI S2 / CrV 6150;
1/4" (6.3 mm): PH1, PH2 (L=37 mm); AISI S2 / CrV 6150;
1/4" (6.3 mm): T10, T15, T20, T25, T30 (L=37 mm); AISI S2 / CrV 6150;
1/4" (6.3 mm): 3, 4, 5, 6 mm (L=37 mm); AISI S2 / CrV 6150

YATO	○	
YT-14433	1/4" (6.3 mm)	5/10

EN Tool set
PL Zestaw narzędziowy
DE Werkzeug-Satz
RU Набор инструментов

CZ Sada nářadí
HU Szerszámkészlet
RO Trusa de scule
FR Jeu d'outils

IT Set di utensili
ES Juego de herramientas
CN 工具组套

38
PCS

1/4"
6.3mm

CrV
50BV30

CrV
6150

CrV
40

CrMo
440

S2

72T

AS-DRIVE



1/4" (6.3 mm): 3.5, 4, 4.5, 5, 5.5, 6, 7, 8, 9, 10, 11, 12, 13, 14 mm (L=25 mm); CrV 50BV30;
1/4" (6.3 mm); (50.8, 101.6 mm); CrV 50BV30;
1/4" (6.3 mm); CrV 50BV30;
1/4" (6.3 mm); (152.4 mm); CrV 40;
1/4" (6.3 mm); (155 mm); 72T; CrMo 440;
1/4" (6.3 mm); (150 mm); CrV 50BV30;
1/4" (6.3 mm): 4, 5.5, 6.5 mm (L=37 mm); AISI S2 / CrV 6150;
1/4" (6.3 mm): PH1, PH2 (L=37 mm); AISI S2 / CrV 6150;
1/4" (6.3 mm): PZ1, PZ2 (L=37 mm); AISI S2 / CrV 6150;
1/4" (6.3 mm): T10, T15, T20, T25, T30, T40 (L=37 mm); AISI S2 / CrV 6150;
1/4" (6.3 mm): 3, 4, 5, 6, 8 mm (L=37 mm); AISI S2 / CrV 6150

YATO	○	
YT-14471	1/4" (6.3 mm)	10

EN Tool set RU Набор инструментов RO Trusa de scule ES Juego de herramientas
 PL Zestaw narzędziowy CZ Sada náradí FR Jeu d'outils CN 工具组套
 DE Werkzeug-Satz HU Szerszámkészlet IT Set di utensili

56
PCS

1/4"
6.3mm

CrV
50BV30

CrV
6150

CrV
40















CrMo
440

S2

72T

AS-DRIVE



-  1/4" (6.3 mm): 4, 4.5, 5, 5.5, 6, 7, 8, 9, 10, 11, 12, 13 mm (L=25 mm); CrV 50BV30;
-  1/4" (6.3 mm): 6, 7, 8, 9, 10, 11, 12, 13 mm (L=50 mm); CrV 50BV30;
-  1/4" (6.3 mm): E4, E5, E6, E7, E8, E10; CrV 6150;
-  1/4" (6.3 mm): (76, 152.4 mm); CrV 50BV30;
-  1/4" (6.3 mm): (150 mm); CrV 50BV30;
-  1/4" (6.3 mm); CrV 50BV30;
-  1/4" (6.3 mm); (152.4 mm); CrV 40;
-  1/4" (6.3 mm); (155 mm); 72T; CrMo 440;
-  1/4" (6.3 mm); (150 mm); CrV 50BV30;
-  1/4" (6.3 mm) (F) x 3/8" (9.5 mm) (M); CrV 50BV30;
-  1/4" (6.3 mm): 4, 5.5, 6.5 mm (L=37 mm); AISI S2 / CrV 6150;
-  1/4" (6.3 mm): PH1, PH2, PH3 (L=37 mm); AISI S2 / CrV 6150;
-  1/4" (6.3 mm): PZ1, PZ2, PZ3 (L=37 mm); AISI S2 / CrV 6150;
-  1/4" (6.3 mm): T8, T10, T15, T20, T25, T30, T40 (L=37 mm); AISI S2 / CrV 6150;
-  1/4" (6.3 mm): 3, 4, 5, 6, 7, 8 mm (L=37 mm); AISI S2 / CrV 6150

YATO	○	
YT-14501	1/4" (6.3 mm)	10

EN Socket set and accessories
 PL Zestaw nasadek z akcesoriami
 DE Steckschlüsselsatz mit Zubehör
 RU Набор головок с принадлежностями
 CZ Sada nástavců s příslušenstvím
 HU Dugókulcs készlet tartozékokkal
 RO Trusă tubulare cu accesorii
 FR Jeu de douilles et accessoires
 IT Set di chiavi a bussola con accessori
 ES Juego de vasos y accesorios
 CN 套筒组套

12
PCS

3/8"
9.5mm



CrV
50BV30

CrV
6140

72T

AS-DRIVE



-  3/8" (9.5 mm): 10, 11, 12, 13, 14, 15, 17, 19, 22, 24 mm (L=28 mm); CrV 50BV30;
-  3/8" (9.5 mm); (152.4 mm); CrV 50BV30;
-  3/8" (9.5 mm); (200 mm); 72T; CrV 6140

YATO	○	
YT-38683	3/8" (9.5 mm)	5/10

EN Tool set RU Набор инструментов RO Trusa de scule ES Juego de herramientas
 PL Zestaw narzędziowy CZ Sada náradí FR Jeu d'outils CN 工具组套
 DE Werkzeug-Satz HU Szerszámkészlet IT Set di utensili

22
PCS

3/8"
9.5mm

CrV
50BV30





CrV
40

CrMo
440

72T

AS-DRIVE



-  3/8" (9.5 mm): 6, 7, 8, 9, 10, 11, 12, 13, 14, 15, 16 mm (L=28 mm); 17, 18, 19, 20, 21, 22 mm (L=30 mm); CrV 50BV30;
-  3/8" (9.5 mm); (76, 152.4 mm); CrV 50BV30;
-  3/8" (9.5 mm); CrV 50BV30;
-  3/8" (9.5 mm); (198 mm); CrV 40;
-  3/8" (9.5 mm); (200 mm); 72T; CrMo 440

YATO	○	
YT-38561	3/8" (9.5 mm)	10

EN Deep socket set
PL Zestaw nasadek dlugich
DE Lange Steckschlüsselsatz
RU Набор глубоких головок
CZ Sada hlubokých nástavců
HU Hosszú dugókulcs készlet
RO Set tubulare adânci
FR Jeu de douilles longues
IT Set di chiavi a bussola lunghe
ES Juego de vasos largos
CN 套筒组套

10
PCS

1/2"
12,7mm

CrV
50BV30

AS-DRIVE



1/2" (12.7 mm): 10, 12, 13, 14, 15, 17, 19, 21, 22, 24 mm (L=76 mm); CrV 50BV30

YATO	○	
YT-38861	1/2" (12.7 mm)	5/10

EN Socket and ratchet set
PL Zestaw nasadek z grzechotką
DE Steckschlüsselsatz mit Hebelumschaltknarre
RU Набор головок с трещоткой
CZ Sada nástavců a ráčny
HU Dugókulcs készlet racsnis hajtókarral
RO Trusă tubulară și antrenor
FR Jeu de douilles et clé à cliquet
IT Set di chiavi a bussola con cricchetto
ES Juego de vasos y carraca
CN 套筒组套

19
PCS

1/2"
12,7mm

CrV
50BV30

CrMo
440

72T

AS-DRIVE



1/2" (12.7 mm): 8, 9, 10, 11, 12, 13, 14, 15, 16, 17, 19, 21, 22, 23, 24 mm (L=38 mm);
27, 30, 32 mm (L=42 mm); CrV 50BV30;
1/2" (12.7 mm); (255 mm); 72T; CrMo 440

YATO	○	
YT-38681	1/2" (12.7 mm)	3/6

EN Tool set
PL Zestaw narzędziowy
DE Werkzeug-Satz

RU Набор инструментов
CZ Sada nářadí
HU Szerszámkészlet

RO Trusa de scule
FR Jeu d'outils
IT Set di utensili

ES Juego de herramientas
CN 工具组套

25
PCS

1/2"
12,7mm

CrV
50BV30

CrV
6140

72T

AS-DRIVE



EN Socket set and accessories
PL Zestaw nasadek z akcesoriami
DE Steckschlüsselsatz mit Zubehör
RU Набор головок с принадлежностями
CZ Sada nástavců s příslušenstvím
HU Dugókulcs készlet tartozékokkal
RO Trusă tubulară cu accesorii
FR Jeu de douilles et accessoires
IT Set di chiavi a bussola con accessori
ES Juego de vasos y accesorios
CN 套筒组套

12
PCS

1/2"
12,7mm

CrV
50BV30

CrMo
440

72T

AS-DRIVE



1/2" (12.7 mm): 10, 11, 12, 13, 14, 15, 17, 19, 21, 24 mm (L=38 mm); CrV 50BV30;
1/2" (12.7 mm); (127 mm); CrV 50BV30;
1/2" (12.7 mm); (255 mm); 72T; CrMo 440

YATO	○	
YT-38821	1/2" (12.7 mm)	5/10

EN Tool set
PL Zestaw narzędziowy
DE Werkzeug-Satz
RU Набор инструментов
CZ Sada nářadí
HU Szerszámkészlet

RO Trusa de scule
FR Jeu d'outils
IT Set di utensili
ES Juego de herramientas
CN 工具组套

12
PCS

1/2"
12,7mm

CrV
50BV30

CrMo
440

72T

AS-DRIVE



1/2" (12.7 mm): 10, 11, 12, 13, 14, 15, 17, 19, 21, 24 mm (L=38 mm); CrV 50BV30;
1/2" (12.7 mm); (127 mm); CrV 50BV30;
1/2" (12.7 mm); (255 mm); 72T; CrMo 440

YATO	○	
YT-38671	1/2" (12.7 mm)	10

EN Tool set
PL Zestaw narzędziowy
DE Werkzeug-Satz

RU Набор инструментов
CZ Sada nářadí
HU Szerszámkészlet

RO Trusa de scule
FR Jeu d'outils
IT Set di utensili

ES Juego de herramientas
CN 工具组套

25
PCS

1/2"
12,7mm

CrV
50BV30

CrV
6140

72T

AS-DRIVE



1/2" (12.7 mm): 10, 11, 12, 13, 14, 15, 16, 17, 18, 19, 20, 21, 22, 23, 24 mm (L=38 mm); 27, 30, 32 mm (L=42 mm); CrV 50BV30;
1/2" (12.7 mm); (127 mm); CrV 50BV30;
1/2" (12.7 mm): 16, 21 mm; CrV 50BV30;
1/2" (12.7 mm); (255 mm); CrV 50BV30;
1/2" (12.7 mm); (255 mm); 72T; CrV 6140;
1/2" (12.7 mm); (317 mm); CrV 50BV30;
1/2" (12.7 mm) (F) x 3/8" (9.5 mm) (M); CrV 50BV30

YATO	○	
YT-38741	1/2" (12.7 mm)	2

EN Socket set and accessories
 PL Zestaw nasadek z akcesoriami
 DE Steckschlüsselsatz mit Zubehör
 RU Набор головок с принадлежностями
 CZ Sada nástavců s příslušenstvím
 HU Dugókulcs készlet tartozékokkal
 RO Trusă tubulare cu accesorii
 FR Jeu de douilles et accessoires
 IT Set di chiavi a bussola con accessori
 ES Juego de vasos y accesorios
 CN 套筒组套



51 PCS 1/2" 12.7mm 1/4" 6.3mm CrV 50BV30 CrV 6140 S2 72T AS-DRIVE

- 1/2" (12.7 mm): 10, 11, 12, 13, 14, 15, 17, 19, 22, 24 mm (L=38 mm);
- 1/4" (6.3 mm): 4, 4.5, 5, 5.5, 6, 7, 8, 9, 10, 11, 12, 13, 14 mm (L=25 mm); CrV 50BV30;
- 1/2" (12.7 mm): (127 mm); 1/4" (6.3 mm): (101.6 mm); CrV 50BV30;
- 1/2" (12.7 mm), 1/4" (6.3 mm); CrV 50BV30;
- 1/2" (12.7 mm); (255 mm), 1/4" (6.3 mm); (155 mm); 72T; CrV 6140;
- 1/4" (6.3 mm) x 1/4" (6.3 mm); CrV 50BV30;
- 1/2" (12.7 mm) (F) x 1/4" (6.3 mm) (M); CrV 50BV30;
- 1/4" (6.3 mm): 6-8, 8-10 x2, 10-12 (L=25 mm); AISI S2;
- 1/4" (6.3 mm): PH0, PH1, PH2, PH3 (L=25 mm); AISI S2;
- 1/4" (6.3 mm): PZ1, PZ2, PZ3 (L=25 mm); AISI S2;
- 1/4" (6.3 mm): T10, T15, T20, T25, T27, T30 (L=25 mm); AISI S2;
- 1/4" (6.3 mm): S1, S2, S3 (L=25 mm); AISI S2

YATO	○	5
YT-38680	1/4" (6.3 mm), 1/2" (12.7 mm)	

EN Tool set
 PL Zestaw narzędziowy
 DE Werkzeug-Satz
 RU Набор инструментов

CZ Sada nářadí
 HU Szerszámkészlet
 RO Trusa de scule
 FR Jeu d'outils

IT Set di utensili
 ES Juego de herramientas
 CN 工具组套

60 PCS 1/2" 12.7mm 1/4" 6.3mm CrV 50BV30 CrV 6150 CrV 6140 S2 72T AS-DRIVE



- 1/2" (12.7 mm): 10, 11, 12, 13, 14, 15, 16, 17, 18, 19, 20, 21, 22, 24 mm (L=38 mm); 27, 30, 32 mm (L=42 mm); CrV 50BV30;
- 1/2" (12.7 mm): (127 mm; 254 mm); CrV 50BV30;
- 1/2" (12.7 mm): 16, 21 mm; CrV 50BV30;
- 1/2" (12.7 mm): 10, 11, 12, 13, 14, 15, 16, 17, 18, 19 mm (L=76 mm); CrV 50BV30;
- 3/8" (9.5 mm) (F) x 1/2" (12.7 mm) (M); CrV 50BV30;
- 1/2" (12.7 mm); CrV 50BV30;
- 1/2" (12.7 mm); (255 mm); 72T; CrV 6140;
- 1/4" (6.3 mm); (150 mm); CrV 50BV30;
- 1/4" (6.3 mm) x 1/4" (6.3 mm); CrV 6140;
- 1/4" (6.3 mm): 2, 3, 4, 5, 6, 7, 8 mm (L=25 mm); AISI S2;
- 1/4" (6.3 mm); PZ1, PZ2, PZ3 (L=25 mm); AISI S2;
- 1/4" (6.3 mm); T8, T10, T15, T20, T25, T27, T30, T40 (L=25 mm); AISI S2;
- 1/4" (6.3 mm); 4, 5.5, 6.5 mm (L=37 mm); AISI S2 / CrV 6150;
- 1/4" (6.3 mm); PH1, PH2, PH3 (L=37 mm); AISI S2 / CrV 6150

YATO	○	4
YT-12660	1/4" (6.3 mm), 1/2" (12.7 mm)	

EN Tool set
 PL Zestaw narzędziowy
 DE Werkzeug-Satz
 RU Набор инструментов

CZ Sada nářadí
 HU Szerszámkészlet
 RO Trusa de scule
 FR Jeu d'outils

IT Set di utensili
 ES Juego de herramientas
 CN 工具组套

72 PCS 1/2" 12.7mm 1/4" 6.3mm CrV 50BV30 CrV 6150 CrV 6140 72T AS-DRIVE



- 1/2" (12.7 mm): 10, 11, 12, 13, 14, 15, 16, 17, 18, 19, 20, 21, 22, 23, 24 mm (L=38 mm); 27 mm (L=42 mm); 1/4" (6.3 mm): 4, 5, 6, 7, 8, 9, 10, 11, 12, 13 mm (L=25 mm); CrV 50BV30;
- 1/2" (12.7 mm): (127, 254 mm); 1/4" (6.3 mm): (152.4 mm); CrV 50BV30;
- 3/8" (9.5 mm) (F) x 1/2" (12.7 mm) (M); CrV 50BV30;
- 1/2" (12.7 mm); CrV 50BV30;
- 1/2" (12.7 mm): 21 mm; CrV 50BV30;
- 1/2" (12.7 mm); (255 mm), 1/4" (6.3 mm); (155 mm); 72T; CrV 6140;
- 1/4" (6.3 mm); (150 mm); CrV 50BV30;
- 1/4" (6.3 mm) x 1/4" (6.3 mm); CrV 6140;
- 1/4" (6.3 mm): 4, 5, 5.5, 6, 7 mm (L=25 mm); CrV 6150;
- 1/4" (6.3 mm): PH0, PH1, PH2, PH3 (L=25 mm); CrV 6150;
- 1/4" (6.3 mm): PZ0, PZ1, PZ2, PZ3 (L=25 mm); CrV 6150;
- 1/4" (6.3 mm): T8, T9, T10, T15, T20, T25, T27, T30, T40 (L=25 mm); CrV 6150;
- 1/4" (6.3 mm): 3, 4, 5, 6, 7, 8 mm (L=25 mm); CrV 6150;
- 1/4" (6.3 mm): S0, S1, S2, S3 (L=25 mm); CrV 6150;
- 1.25, 1.5, 2.5, 3 mm; CrV 6150

YATO	○	4
YT-38782	1/4" (6.3 mm), 1/2" (12.7 mm)	

EN Tool set
PL Zestaw narzędziowy
DE Werkzeug-Satz















RU Набор инструментов
CZ Sada nářadí
HU Szerszámkészlet



RO Trusa de scule
FR Jeu d'outils
IT Set di utensili

ES Juego de herramientas
CN 工具组套

77 PCS
1/2" 12.7mm
1/4" 6.3mm
CrV 50BV30
CrV 6150
CrMo 440
S2
72T
AS-DRIVE 



-  1/2" (12.7 mm): 10, 11, 12, 13, 14, 15, 17, 19, 22, 24 mm (L=38 mm); 27, 30, 32 mm (L=42 mm);
- 1/4" (6.3 mm): 4, 5, 6, 7, 8, 9, 10, 11, 12 mm (L=25 mm); CrV 50BV30;
-  1/2" (12.7 mm): (127, 254 mm), 1/4" (6.3 mm); (76, 101.6 mm); CrV 50BV30;
-  1/2" (12.7 mm), 1/4" (6.3 mm); CrV 50BV30;
-  1/2" (12.7 mm): 16, 21 mm; CrV 50BV30;
-  1/2" (12.7 mm); (255 mm), 1/4" (6.3 mm); (155 mm); 72T, CrMo 440;
-  1/4" (6.3 mm) x 1/4" (6.3 mm); CrV 50BV30;
-  1/4" (6.3 mm) x 1/4" (6.3 mm); CrV 50BV30;
-  1/4" (6.3 mm): 3, 4, 5, 5, 7 mm (L=25 mm); AISI S2;
-  1/4" (6.3 mm): PH0, PH1, PH2, PH3 (L=25 mm); AISI S2;
-  1/4" (6.3 mm): PZ1, PZ2, PZ3 (L=25 mm); AISI S2;
-  1/4" (6.3 mm): T10, T15, T20, T25, T30 (L=25 mm); AISI S2;
-  1/4" (6.3 mm): 2, 3, 4, 5, 6 mm (L=25 mm); AISI S2;
-  7, 8, 9, 10, 11, 12, 13, 14, 15, 17, 19 mm; CrV;
-  8x9, 10x11, 12x13, 14x15 mm; CrV 50BV30;
-  1.5, 2, 2.5, 5, 6, 8, 10 mm; CrV 6150

YATO 	○	
YT-38781	1/4" (6.3 mm), 1/2" (12.7 mm)	2

EN Tool set
PL Zestaw narzędziowy
DE Werkzeug-Satz

RU Набор инструментов
CZ Sada nářadí
HU Szerszámkészlet





















RO Trusa de scule
FR Jeu d'outils
IT Set di utensili



ES Juego de herramientas
CN 工具组套

79 PCS
1/2" 12.7mm
1/4" 6.3mm
CrV 50BV30
CrV 6140
CrV 60

CrMo
SK5
S2
72T
AS-DRIVE 



-  1/2" (12.7 mm): 10, 11, 12, 13, 14, 16, 17, 19, 22, 24, 26 mm (L=38 mm); 27, 30, 32 mm (L=42 mm);
- 1/4" (6.3 mm): 5, 6, 7, 8, 9, 10, 11, 12, 13 mm (L=25 mm); CrV 50BV30;
-  1/2" (12.7 mm): 10, 11, 12, 13, 14, 17, 19 mm (L=76 mm); CrV 50BV30;
-  1/2" (12.7 mm); (125 mm), 1/4" (6.3 mm); (50 mm); CrV 50BV30;
-  1/2" (12.7 mm); CrV 50BV30;
-  1/2" (12.7 mm): 16, 21 mm; CrV 50BV30;
-  1/2" (12.7 mm); (255 mm), 1/4" (6.3 mm); (155 mm); 72T, CrV 6140;
-  1/4" (6.3 mm); (150 mm); CrV 50BV30;
-  1/2" (12.7 mm); (457 mm);
-  6, 7, 8, 9, 10, 11, 12, 13, 14, 16, 17, 19, 22, 24 mm; CrV;
-  2.0x75, 2.4x75 mm, S2;
-  3.0x75, 4.0x100, 6.5x150, 8.0x150 mm; S2;
-  PH0x75 mm; S2;
-  PH1x75, PH2x100 mm; S2;
-  180 mm;
-  160 mm;
-  160, 200 mm;
-  250 mm;
-  300 g;
-  300 mm;
-  180 mm; CrMo;
-  120 mm; CrV 60;
- SK5;
- 2.5, 3, 4, 5, 6, 8, 10 mm; CrV

YATO 	○	
YT-38911	1/4" (6.3 mm), 1/2" (12.7 mm)	2

EN Tool set RU Набор инструментов RO Trusa de scule ES Juego de herramientas
 PL Zestaw narzędziowy CZ Sada náradí FR Jeu d'outils CN 工具组套
 DE Werkzeug-Satz HU Szerszámkészlet IT Set di utensili

82 PCS	1/2" 12.7mm	1/4" 6.3mm	CrV 50BV30	CrV 6150
CrV 40	CrMo 440	S2	72T	AS-DRIVE



2



- 1/2" (12.7 mm): 14, 15, 16, 17, 18, 19, 20, 22, 24 mm (L=38 mm); 27, 30, 32 mm (L=42 mm), 1/4" (6.3 mm): 4, 4.5, 5, 5.5, 6, 7, 8, 9, 10, 11, 12, 13, 14 mm (L=25 mm); CrV 50BV30;
- 1/2" (12.7 mm): (127, 254 mm), 1/4" (6.3 mm): (50.8, 101.6 mm); CrV 50BV30;
- 3/8" (9.5 mm) (F) x 1/2" (12.7 mm) (M); CrV 50BV30;
- 1/4" (6.3 mm): (150 mm); CrV 50BV30;
- 1/2" (12.7 mm), 1/4" (6.3 mm); CrV 50BV30;
- 1/2" (12.7 mm): 16, 21 mm; CrV 50BV30;
- 1/4" (6.3 mm): (152.4 mm); CrV 40;
- 1/2" (12.7 mm): (255 mm), 1/4" (6.3 mm): (155 mm); 72T; CrMo 440;
- 1/4" (6.3 mm): (150 mm); CrV 50BV30;
- 1/2" (12.7 mm) x 5/16" (7.9 mm); CrV 50BV30;
- 1/4" (6.3 mm) x 1/4" (6.3 mm); CrV 50BV30;
- 5/16" (7.9 mm): 8, 10, 12 mm (L=30 mm); AISI S2;
- 5/16" (7.9 mm): PH3, PH4 (L=30 mm); AISI S2;
- 5/16" (7.9 mm): PZ3, PZ4 (L=30 mm); AISI S2;
- 5/16" (7.9 mm): T40, T45, T50, T55 (L=30 mm); AISI S2;
- 5/16" (7.9 mm): 8, 10, 12, 14 mm (L=30 mm); AISI S2;
- 1/4" (6.3 mm): 4, 5.5, 7 mm (L=37 mm); AISI S2 / CrV 6150;
- 1/4" (6.3 mm): PH1, PH2 (L=37 mm); AISI S2 / CrV 6150;
- 1/4" (6.3 mm): PZ1, PZ2 (L=37 mm); AISI S2 / CrV 6150;
- 1/4" (6.3 mm): T8, T10, T15, T20, T25, T30 (L=37 mm); AISI S2 / CrV 6150;
- 1/4" (6.3 mm): 3, 4, 5, 6 mm (L=37 mm); AISI S2 / CrV 6150;
- 8, 10, 11, 12, 13, 14, 17, 19, 22 mm; CrV

YATO	○	2
YT-12691	1/4" (6.3 mm), 1/2" (12.7 mm)	2

EN Tool set RU Набор инструментов RO Trusa de scule ES Juego de herramientas
 PL Zestaw narzędziowy CZ Sada náradí FR Jeu d'outils CN 工具组套
 DE Werkzeug-Satz HU Szerszámkészlet IT Set di utensili

93 PCS	1/2" 12.7mm	1/4" 6.3mm	CrV 50BV30	CrV 6150
CrV 6140	S2	72T	AS-DRIVE	



- 1/2" (12.7 mm): 10, 11, 12, 13, 14, 15, 17, 19, 22, 24 mm (L=38 mm); 27, 30, 32 mm (L=42 mm), 1/4" (6.3 mm): 4, 4.5, 5, 5.5, 6, 7, 8, 9, 10, 11, 12, 13 mm (L=25 mm); CrV 50BV30;
- 1/4" (6.3 mm): 4, 5, 6, 7, 8, 9, 10, 11, 12, 13 mm (L=50 mm); CrV 50BV30;
- 1/2" (12.7 mm): (127, 254 mm), 1/4" (6.3 mm): (50.8, 101.6 mm); CrV 50BV30;
- 3/8" (9.5 mm) (F) x 1/2" (12.7 mm) (M); CrV 50BV30;
- 1/2" (12.7 mm), 1/4" (6.3 mm); CrV 50BV30;
- 1/2" (12.7 mm): 21 mm; CrV 50BV30;
- 1/4" (6.3 mm): (115 mm); CrV 50BV30;
- 1/2" (12.7 mm): (255 mm), 1/4" (6.3 mm): (155 mm); 72T; CrV 6140;
- 1/4" (6.3 mm): (150 mm); CrV 50BV30;
- 1/2" (12.7 mm) x 5/16" (7.9 mm); CrV 6140;
- 1/4" (6.3 mm) x 1/4" (6.3 mm); CrV 50BV30;
- 1/4" (6.3 mm): (60 mm);
- 5/16" (7.9 mm): T45, T50, T55 (L=30 mm); AISI S2;
- 1/4" (6.3 mm): 4, 5.5, 7 mm (L=25 mm); AISI S2;
- 1/4" (6.3 mm): PH0, PH1, PH2, PH3, PH4 (L=25 mm); AISI S2;
- 1/4" (6.3 mm): PZ1, PZ2, PZ3 (L=25 mm); AISI S2;
- 1/4" (6.3 mm): T8, T10, T15, T20, T25, T27, T30, T40 (L=25 mm); AISI S2;
- 1/4" (6.3 mm): 3, 4, 5, 6, 8, 10 mm (L=25 mm); AISI S2;
- 1/4" (6.3 mm) x 1/4" (6.3 mm) (L=25 mm); AISI S2;
- 8, 10, 12, 13, 14, 17 mm; CrV;
- 8x9, 10x11, 12x13, 14x15 mm; CrV 50BV30;
- 1.5, 2, 2.5 mm; CrV 6150

YATO	○	4
YT-38784	1/4" (6.3 mm), 1/2" (12.7 mm)	4

EN Tool set
 PL Zestaw narzędziowy
 DE Werkzeug-Satz

RU Набор инструментов
 CZ Sada nářadí
 HU Szerszámkészlet

RO Trusa de scule
 FR Jeu d'outils
 IT Set di utensili

ES Juego de herramientas
 CN 工具组套

94 PCS	1/2" 12.7mm	1/4" 6.3mm	CrV 50BV30	CrV 6150	CrV 40
CrMo 440	S2	72T	AS-DRIVE		

2



- 1/2" (12.7 mm): 10, 11, 12, 13, 14, 15, 16, 17, 18, 19, 20, 21, 22, 23, 24 mm (L=38 mm); 27, 30, 32 mm (L=42 mm), 1/4" (6.3 mm): 4, 4.5, 5, 5.5, 6, 7, 8, 9, 10, 11, 12, 13, 14 mm (L=25 mm); CrV 50BV30;
- 1/2" (12.7 mm): 14, 15, 17, 19 mm (L=76 mm), 1/4" (6.3 mm): 6, 7, 8, 9, 10, 11, 12, 13 mm (L=50 mm); CrV 50BV30;
- 1/2" (12.7 mm); (127, 254 mm), 1/4" (6.3 mm); (50.8, 101.6 mm); CrV 50BV30;
- 3/8" (9.5 mm) (F) x 1/2" (12.7 mm) (M); CrV 50BV30;
- 1/4" (6.3 mm); (150 mm); CrV 50BV30;
- 1/2" (12.7 mm), 1/4" (6.3 mm); CrV 50BV30;
- 1/2" (12.7 mm): 16, 21 mm; CrV 50BV30;
- 1/4" (6.3 mm); (152.4 mm); CrV 40;
- 1/2" (12.7 mm); (255 mm), 1/4" (6.3 mm); (155 mm); 72T; CrMo 440;
- 1/4" (6.3 mm); (150 mm); CrV 50BV30;
- 1/2" (12.7 mm) x 5/16" (7.9 mm); CrV 50BV30;
- 1/4" (6.3 mm) x 1/4" (6.3 mm); CrV 50BV30;
- 5/16" (7.9 mm): 8, 10, 12 mm (L=30 mm); AISI S2;
- 5/16" (7.9 mm): PH3, PH4 (L=30 mm); AISI S2;
- 5/16" (7.9 mm): PZ3, PZ4 (L=30 mm); AISI S2;
- 5/16" (7.9 mm): T40, T45, T50, T55 (L=30 mm); AISI S2;
- 5/16" (7.9 mm): 8, 10, 12, 14 mm (L=30 mm); AISI S2;
- 1/4" (6.3 mm): 4, 5.5, 7 mm (L=37 mm); AISI S2 / CrV 6150;
- 1/4" (6.3 mm): PH1, PH2 (L=37 mm); AISI S2 / CrV 6150;
- 1/4" (6.3 mm): PZ1, PZ2 (L=37 mm); AISI S2 / CrV 6150;
- 1/4" (6.3 mm): T8, T10, T15, T20, T25, T30 (L=37 mm); AISI S2 / CrV 6150;
- 1/4" (6.3 mm): 3, 4, 5, 6 mm (L=37 mm); AISI S2 / CrV 6150;
- 1.5, 2, 2.5 mm; CrV 6150

YATO	○	
YT-12681	1/4" (6.3 mm), 1/2" (12.7 mm)	2

EN Tool set
 PL Zestaw narzędziowy
 DE Werkzeug-Satz

RU Набор инструментов
 CZ Sada nářadí
 HU Szerszámkészlet

RO Trusa de scule
 FR Jeu d'outils
 IT Set di utensili

ES Juego de herramientas
 CN 工具组套

108 PCS	1/2" 12.7mm	1/4" 6.3mm	CrV 50BV30	CrV 6150	CrV 40
CrMo 440	S2	72T	AS-DRIVE		



- 1/2" (12.7 mm): 10, 11, 12, 13, 14, 15, 16, 17, 18, 19, 20, 21, 22, 24 mm (L=38 mm); 27, 30, 32 mm (L=42 mm), 1/4" (6.3 mm): 4, 4.5, 5, 5.5, 6, 7, 8, 9, 10, 11, 12, 13, 14 mm (L=25 mm); CrV 50BV30;
- 1/2" (12.7 mm): 14, 15, 17, 19, 22 mm (L=76 mm), 1/4" (6.3 mm): 6, 7, 8, 9, 10, 11, 12, 13 mm (L=50 mm); CrV 50BV30;
- 1/2" (12.7 mm): E10, E11, E12, E14, E16, E18, E20, E24, 1/4" (6.3 mm): E4, E5, E6, E7, E8; CrV 50BV30;
- 1/2" (12.7 mm); (127, 254 mm), 1/4" (6.3 mm); (50.8, 101.6 mm); CrV 50BV30;
- 3/8" (9.5 mm) (F) x 1/2" (12.7 mm) (M); CrV 50BV30;
- 1/2" (12.7 mm), 1/4" (6.3 mm); CrV 50BV30;
- 1/2" (12.7 mm): 16, 21 mm; CrV 50BV30;
- 1/4" (6.3 mm); (152.4 mm); CrV 40;
- 1/2" (12.7 mm); (255 mm), 1/4" (6.3 mm); (155 mm); 72T; CrMo 440;
- 1/4" (6.3 mm); (150 mm); CrV 50BV30;
- 1/2" (12.7 mm) x 5/16" (7.9 mm); CrV 50BV30;
- 5/16" (7.9 mm): 8, 10, 12 mm (L=30 mm); AISI S2;
- 5/16" (7.9 mm): PH3, PH4 (L=30 mm); AISI S2;
- 5/16" (7.9 mm): PZ3, PZ4 (L=30 mm); AISI S2;
- 5/16" (7.9 mm): T40, T45, T50, T55, T60 (L=30 mm); AISI S2;
- 5/16" (7.9 mm): 7, 8, 10, 12, 14 mm (L=30 mm); AISI S2;
- 1/4" (6.3 mm): 4, 5.5, 6.5 mm (L=37 mm); AISI S2 / CrV 50BV30;
- 1/4" (6.3 mm): PH1, PH2 (L=37 mm); AISI S2 / CrV 50BV30;
- 1/4" (6.3 mm): PZ1, PZ2 (L=37 mm); AISI S2 / CrV 50BV30;
- 1/4" (6.3 mm): T8, T10, T15, T20, T25, T27, T30 (L=37 mm); AISI S2 / CrV 50BV30;
- 1/4" (6.3 mm): 3, 4, 5, 6 mm (L=37 mm); AISI S2 / CrV 50BV30;
- 1.5, 2, 2.5 mm; CrV 6150

YATO	○	
YT-38791	1/4" (6.3 mm), 1/2" (12.7 mm)	2

EN Tool set
 PL Zestaw narzędziowy
 DE Werkzeug-Satz
 RU Набор инструментов

CZ Sada nářadí
 HU Szerszámkészlet
 RO Trusa de scule
 FR Jeu d'outils

IT Set di utensili
 ES Juego de herramientas
 CN 工具组套

109
PCS

1/2"
12.7mm

1/4"
6.3mm

CrV
50BV30

CrV
6150

CrV
6140

CrMo
440

S2

72T

AS-DRIVE



2



- 1/2" (12.7 mm): 12, 13, 14, 15, 16, 17, 18, 19, 20, 21, 22, 24 mm (L=38 mm); 27, 30, 32 mm (L=42 mm);
- 1/4" (6.3 mm): 4, 4.5, 5, 5.5, 6, 7, 8, 9, 10, 11, 12, 13, 14 mm (L=25 mm); CrV 50BV30;
- 1/2" (12.7 mm): 10, 12, 13, 14, 17, 19 mm (L=76 mm); 1/4" (6.3 mm): 4, 5, 6, 7, 8, 9 mm (L=50 mm); CrV 50BV30;
- 1/2" (12.7 mm): E10, E12, E14, E16, E18, E20, E22, E24; CrV 6150;
- 1/2" (12.7 mm); (254 mm), 1/4" (6.3 mm); (152.4 mm); CrV 50BV30;
- 3/8" (9.5 mm) (F) x 1/2" (12.7 mm) (M), 3/8" (9.5 mm) (F) x 1/4" (6.3 mm) (M); CrV 50BV30;
- 1/2" (12.7 mm), 1/4" (6.3 mm); CrV 50BV30;
- 1/2" (12.7 mm): 16, 21 mm; CrV 50BV30;
- 1/2" (12.7 mm); (255 mm), 1/4" (6.3 mm); (155 mm); 72T; CrMo 440;
- 1/4" (6.3 mm); (150 mm); CrV 50BV30;
- 1/4" (6.3 mm): 4, 5.5, 6.5 mm (L=37 mm); AISI S2 / CrV 6150;
- 1/4" (6.3 mm): PH1, PH2, PH3 (L=37 mm); AISI S2 / CrV 6150;
- 1/4" (6.3 mm): PZ2, PZ3 (L=37 mm); AISI S2 / CrV 6150;
- 1/4" (6.3 mm): T8, T10, T15, T20, T25 (L=37 mm); AISI S2 / CrV 6150;
- 1/4" (6.3 mm): T10, T15, T20, T25, T40 (L=37 mm); AISI S2 / CrV 6150;
- 1/4" (6.3 mm): 3, 4, 5, 6 mm (L=37 mm); AISI S2 / CrV 6150;
- 8, 9, 10, 11, 12, 13, 14, 15, 16, 17, 18, 19 mm; CrV;
- 8x9, 10x11, 12x13, 14x15 mm; CrV 50BV30;
- 8x10, 12x13, 17x19 mm; CrV 6140;
- 3x75, 4x100, 6x150, PH1x75, PH2x100, PH3x150 mm; S2;
- 180 mm;
- 160 mm;
- 300 g

YATO ®	○	
YT-38891	1/4" (6.3 mm), 1/2" (12.7 mm)	2

EN Tool set
 PL Zestaw narzędziowy
 DE Werkzeug-Satz
 RU Набор инструментов

CZ Sada nářadí
 HU Szerszámkészlet
 RO Trusa de scule
 FR Jeu d'outils

IT Set di utensili
 ES Juego de herramientas
 CN 工具组套

122
PCS

1/2"
12.7mm

1/4"
6.3mm

CrV
50BV30

CrV
6150

CrMo
440

S2

72T

AS-DRIVE



- 1/2" (12.7 mm): 12, 13, 14, 15, 16, 17, 18, 19, 20, 21, 22, 24 mm (L=38 mm); 27, 30, 32 mm (L=42 mm);
- 1/4" (6.3 mm): 4, 4.5, 5, 5.5, 6, 7, 8, 9, 10, 11, 12, 13, 14 mm (L=25 mm); CrV 50BV30;
- 1/2" (12.7 mm): 10, 12, 13, 14, 17, 19 mm (L=76 mm); 1/4" (6.3 mm): 4, 5, 6, 7, 8, 9 mm (L=50 mm); CrV 50BV30;
- 1/2" (12.7 mm): E10, E12, E14, E16, E18, E20, E22, E24; CrV 6150;
- 1/2" (12.7 mm); (254 mm), 1/4" (6.3 mm); (152.4 mm); CrV 50BV30;
- 3/8" (9.5 mm) (F) x 1/2" (12.7 mm) (M), 3/8" (9.5 mm) (F) x 1/4" (6.3 mm) (M); CrV 50BV30;
- 1/2" (12.7 mm), 1/4" (6.3 mm); CrV 50BV30;
- 1/2" (12.7 mm): 16, 21 mm; CrV 50BV30;
- 1/2" (12.7 mm); (255 mm), 1/4" (6.3 mm); (155 mm); 72T; CrMo 440;
- 1/4" (6.3 mm); (150 mm); CrV 50BV30;
- 1/4" (6.3 mm) x 1/4" (6.3 mm); CrV 50BV30;
- 1/4" (6.3 mm): 3, 4, 5, 6 mm (L=25 mm); AISI S2;
- 1/4" (6.3 mm): PH0, PH1, PH2 (L=25 mm); AISI S2;
- 1/4" (6.3 mm): PZ0, PZ1, PZ2 (L=25 mm); AISI S2;
- 1/4" (6.3 mm): 4, 5.5, 6.5 mm (L=37 mm); AISI S2 / CrV 6150;
- 1/4" (6.3 mm): PH1, PH2, PH3 (L=37 mm); AISI S2 / CrV 6150;
- 1/4" (6.3 mm): PZ2, PZ3 (L=37 mm); AISI S2 / CrV 6150;
- 1/4" (6.3 mm): T8, T10, T15, T20, T25 (L=37 mm); AISI S2 / CrV 6150;
- 1/4" (6.3 mm): T10, T15, T20, T25, T40 (L=37 mm); AISI S2 / CrV 6150;
- 1/4" (6.3 mm): 3, 4, 5, 6 mm (L=37 mm); AISI S2 / CrV 6150;
- 8, 9, 10, 11, 12, 13, 14, 15, 16, 17, 18, 19 mm; CrV;
- 4x100, 6x150, PH2x100, PH3x150 mm; S2;
- 180 mm;
- 160 mm;
- 160 mm;
- 250 mm; CrV;
- 300 g;
- 2, 2.5, 3, 4, 5, 6, 7, 8, 10 mm; CrV 6150

YATO ®	○	
YT-38901	1/4" (6.3 mm), 1/2" (12.7 mm)	2

EN Tool set
PL Zestaw narzędziowy
DE Werkzeug-Satz
RU Набор инструментов

CZ Sada náradí
HU Szerszámkészlet
RO Trusa de scule
FR Jeu d'outils

IT Set di utensili
ES Juego de herramientas
CN 工具组套

111 PCS	1/2" 12.7mm	3/8" 9.5mm	1/4" 6.3mm	CrV 50BV30	CrV 6150
CrMo 440	S2	72T	AS-DRIVE		



- 1/2" (12.7 mm): 14, 15, 16, 17, 18, 19, 20, 21, 22, 23, 24 mm (L=38 mm); 27, 30, 32 mm (L=42 mm);
- 3/8" (9.5 mm): 9, 10, 11, 12, 13, 14, 15, 16 mm (L=28 mm); 17, 18, 19 mm (L=30 mm);
- 1/4" (6.3 mm): 3.5, 4, 4.5, 5, 5.5, 6, 7, 8, 9, 10, 11, 12, 13 mm (L=25 mm); CrV 50BV30;
- 1/2" (12.7 mm); (127, 254 mm); 3/8" (9.5 mm); (76, 152.4 mm);
- 1/4" (6.3 mm); (50.8, 152.4 mm); CrV 50BV30;
- 3/8" (9.5 mm) (F) x 1/2" (12.7 mm) (M); 1/2" (12.7 mm) (F) x 3/8" (9.5 mm) (M);
- 3/8" (9.5 mm) (F) x 1/4" (6.3 mm) (M); CrV 50BV30;
- 1/2" (12.7 mm); 3/8" (9.5 mm); 1/4" (6.3 mm); CrV 50BV30;
- 1/2" (12.7 mm): 16, 21 mm; 3/8" (9.5 mm): 16, 21 mm; CrV 50BV30;
- 1/2" (12.7 mm); (255 mm); 3/8" (9.5 mm); (200 mm); 1/4" (6.3 mm); (155 mm); 72T; CrMo 440;
- 1/4" (6.3 mm); (150 mm); CrV 50BV30;
- 1/2" (12.7 mm) x 5/16" (7.9 mm); 3/8" (9.5 mm) x 5/16" (7.9 mm); CrV 50BV30;
- 5/16" (7.9 mm): 6, 6.5, 8 mm (L=30 mm); AISI S2;
- 5/16" (7.9 mm): PH2, PH3 (L=30 mm); AISI S2;
- 5/16" (7.9 mm): PZ2, PZ3 (L=30 mm); AISI S2;
- 5/16" (7.9 mm): T27, T30, T35, T40, T45 (L=30 mm); AISI S2;
- 5/16" (7.9 mm): 5.5, 6, 6.5 mm (L=30 mm); AISI S2;
- 1/4" (6.3 mm): 4, 5.5, 6.5 mm (L=37 mm); AISI S2 / CrV 6150;
- 1/4" (6.3 mm): PH1, PH2 (L=37 mm); AISI S2 / CrV 6150;
- 1/4" (6.3 mm): PZ1, PZ2 (L=37 mm); AISI S2 / CrV 6150;
- 1/4" (6.3 mm): T8, T10, T15, T20, T25 (L=37 mm); AISI S2 / CrV 6150;
- 1/4" (6.3 mm): T10, T15, T20, T25, T40 (L=37 mm); AISI S2 / CrV 6150;
- 1/4" (6.3 mm): 3, 4, 5, 6 mm (L=37 mm); AISI S2 / CrV 6150;
- 8, 9, 10, 11, 12, 13, 14, 15, 16, 17, 18, 19 mm; CrV;
- 1.5, 2, 2.5 mm; CrV 6150

YATO	O	
YT-38831	1/4" (6.3 mm), 3/8" (9.5 mm), 1/2" (12.7 mm)	2

EN Tool set
PL Zestaw narzędziowy
DE Werkzeug-Satz
RU Набор инструментов

CZ Sada náradí
HU Szerszámkészlet
RO Trusa de scule
FR Jeu d'outils

IT Set di utensili
ES Juego de herramientas
CN 工具组套

120 PCS	1/2" 12.7mm	3/8" 9.5mm	1/4" 6.3mm	METRIC SAE	CrV 50BV30
CrV 6150	CrMo 440	S2	72T	AS-DRIVE	



- 1/2" (12.7 mm): 20, 21, 22, 24 mm (L=38 mm); 27, 30, 32 mm (L=42 mm);
- 3/8" (9.5 mm): 9, 10, 11, 12, 13, 14, 15, 16 mm (L=28 mm); 17, 18, 19 mm (L=30 mm);
- 1/4" (6.3 mm): 4, 5, 6, 7, 8, 9, 10, 11, 12, 13 mm (L=25 mm); CrV 50BV30;
- 3/8" (9.5 mm): 13, 14, 15, 17 mm (L=63 mm); 1/4" (6.3 mm): 8, 9, 10, 12 mm (L=50 mm); CrV 50BV30;
- 1/2" (12.7 mm) x 15/16" (23.8 mm); 1/2" (12.7 mm) x 1" (25.4 mm); 1/2" (12.7 mm) x 1-1/16" (27.0 mm);
- 1/2" (12.7 mm) x 1-1/4" (31.8 mm); 3/8" (9.5 mm) x 3/8" (9.5 mm); 3/8" (9.5 mm) x 7/16" (11.1 mm);
- 3/8" (9.5 mm) x 1/2" (12.7 mm); 3/8" (9.5 mm) x 9/16" (14.3 mm); 3/8" (9.5 mm) x 5/8" (15.9 mm);
- 3/8" (9.5 mm) x 11/16" (17.5 mm); 3/8" (9.5 mm) x 3/4" (19.0 mm); 3/8" (9.5 mm) x 13/16" (20.6 mm);
- 3/8" (9.5 mm) x 7/8" (22.2 mm); 1/4" (6.3 mm) x 5/32" (4.0 mm); 1/4" (6.3 mm) x 3/16" (4.8 mm);
- 1/4" (6.3 mm) x 7/32" (5.6 mm); 1/4" (6.3 mm) x 1/4" (6.3 mm); 1/4" (6.3 mm) x 9/32" (7.1 mm);
- 1/4" (6.3 mm) x 5/16" (7.9 mm); 1/4" (6.3 mm) x 11/32" (8.7 mm); 1/4" (6.3 mm) x 3/8" (9.5 mm);
- 1/4" (6.3 mm) x 7/16" (11.1 mm); 1/4" (6.3 mm) x 1/2" (12.7 mm); CrV 50BV30;
- 1/2" (12.7 mm): 17, 19, 21, 23 mm; CrV 50BV30;
- 3/8" (9.5 mm): E8, E10, E11, E12, E14, E16, E18, E20; CrV 6150;
- 1/2" (12.7 mm); (127, 254 mm); 3/8" (9.5 mm); (76, 152.4 mm); 1/4" (6.3 mm); (50.8 mm); CrV 50BV30;
- 1/2" (12.7 mm); 3/8" (9.5 mm); 1/4" (6.3 mm); CrV 50BV30;
- 3/8" (9.5 mm): 16, 21 mm; CrV 50BV30;
- 1/2" (12.7 mm); (255 mm); 3/8" (9.5 mm); (200 mm); 1/4" (6.3 mm); (155 mm); 72T; CrMo 440;
- 1/4" (6.3 mm); (150 mm); CrV 50BV30;
- 1/4" (6.3 mm) x 1/4" (6.3 mm); CrV 50BV30;
- 1/4" (6.3 mm): T10, T15, T20, T25, T27, T30, T40 (L=25 mm); AISI S2;
- 3/8" (9.5 mm): 5.5, 6.5 mm (L=50 mm); AISI S2 / CrV 6150;
- 3/8" (9.5 mm): PH1, PH2 (L=50 mm); AISI S2 / CrV 6150;
- 3/8" (9.5 mm): PZ1, PZ2 (L=50 mm); AISI S2 / CrV 6150;
- 3/8" (9.5 mm): T20, T30, T40, T45, T50, T55, T60 (L=50 mm); AISI S2 / CrV 6150;
- 3/8" (9.5 mm): 3, 4, 5, 6 mm (L=50 mm); AISI S2 / CrV 6150;
- 8, 9, 10, 11, 12, 13, 14, 17, 18, 19 mm; CrV

YATO	O	
YT-38801	1/4" (6.3 mm), 3/8" (9.5 mm), 1/2" (12.7 mm)	2

EN Tool set
 PL Zestaw narzędziowy
 DE Werkzeug-Satz
 RU Набор инструментов

CZ Sada nářadí
 HU Szerszámkészlet
 RO Trusa de scule
 FR Jeu d'outils

IT Set di utensili
 ES Juego de herramientas
 CN 工具组套

126
PCS

1/2"
12.7mm

3/8"
9.5mm

1/4"
6.3mm

CrV
50BV30

CrV
6150

CrV
6140

S2

72T

AS-DRIVE



- 1/2" (12.7 mm): 20, 21, 22, 24 mm (L=38 mm); 27, 30, 32 mm (L=42 mm);
- 3/8" (9.5 mm): 9, 10, 11, 12, 13, 14, 15, 16 mm (L=28 mm); 17, 18, 19 mm (L=30 mm);
- 1/4" (6.3 mm): 4, 4.5, 5, 5.5, 6, 7, 8, 9, 10, 11, 12, 13 mm (L=25 mm); CrV 50BV30;
- 3/8" (9.5 mm): 13, 14, 15, 17 mm (L=63 mm), 1/4" (6.3 mm): 8, 9, 10, 12 (L=50 mm); CrV 50BV30;
- 3/8" (9.5 mm): E8, E10, E11, E12, E14, E16, E18, E20; CrV 6150;
- 1/2" (12.7 mm): (127, 254 mm), 3/8" (9.5 mm): (76, 152.4 mm), 1/4" (6.3 mm): (50.8 mm); CrV 50BV30;
- 3/8" (9.5 mm) (F) x 1/2" (12.7 mm) (M); CrV 50BV30; 1/2" (12.7 mm), 3/8" (9.5 mm), 1/4" (6.3 mm); CrV 50BV30;
- 3/8" (9.5 mm): 16, 21 mm; CrV 50BV30;
- 1/2" (12.7 mm): (255 mm), 3/8" (9.5 mm): (200 mm), 1/4" (6.3 mm): (155 mm); 72T; CrV 6140;
- 1/4" (6.3 mm): (150 mm); CrV 50BV30;
- 1/2" (12.7 mm) (F) x 3/8" (9.5 mm) (M), 3/8" (9.5 mm) (F) x 1/2" (12.7 mm) (M), 3/8" (9.5 mm) (F) x 1/4" (6.3 mm) (M); CrV 50BV30;
- 1/4" (6.3 mm) x 1/4" (6.3 mm); CrV 6140;
- 1/4" (6.3 mm): 4, 5, 6.5 mm (L=25 mm); AISI S2;
- 1/4" (6.3 mm): PH1, PH3 (L=25 mm); AISI S2;
- 1/4" (6.3 mm): PZ1, PZ2 (L=25 mm); AISI S2;
- 1/4" (6.3 mm): T10, T15, T20, T25, T27, T30, T40 (L=25 mm); AISI S2;
- 1/4" (6.3 mm): 3, 4, 5, 6 mm (L=25 mm); AISI S2;
- 3/8" (9.5 mm): 5.5, 6.5 mm (L=50 mm); AISI S2 / CrV 6150;
- 3/8" (9.5 mm): PH1, PH2 x2 (L=50 mm); AISI S2 / CrV 6150;
- 3/8" (9.5 mm): T20, T30, T40 (L=50 mm), 1/2" (12.7 mm): T52 (L=125 mm); AISI S2 / CrV 6150;
- 3/8" (9.5 mm): T45, T50, T55, T60 (L=50 mm); AISI S2 / CrV 6150;
- 3/8" (9.5 mm): 3, 4, 5, 6, 7 mm (L=50 mm); AISI S2 / CrV 6150;
- 8, 10, 12, 13, 14, 16, 17, 18, 19 mm; CrV;
- 8x10 mm, 11x12 mm; CrV 6140;
- 6x100 mm, PH2x100 mm; CrV 6150;
- 6-24 V;
- 150 mm;
- 1/2" (12.7 mm), 3/8" (9.5 mm): 63-120 mm; CrV;
- 1.5, 2, 2.5, 3, 4, 5, 6, 8, 10 mm; S2

YATO	○	☐
YT-38875	1/4" (6.3 mm), 3/8" (9.5 mm), 1/2" (12.7 mm)	2

EN Tool set
 PL Zestaw narzędziowy
 DE Werkzeug-Satz
 RU Набор инструментов

CZ Sada nářadí
 HU Szerszámkészlet
 RO Trusa de scule
 FR Jeu d'outils

IT Set di utensili
 ES Juego de herramientas
 CN 工具组套

128
PCS

1/2"
12.7mm

3/8"
9.5mm

5/16"
8mm

1/4"
6.3mm

CrV
50BV30

CrV
6150

CrMo
440

S2

72T

AS-DRIVE



- 1/2" (12.7 mm): 14, 15, 16, 17, 18, 19, 20, 21, 22, 24 mm (L=38 mm); 27, 30, 32 mm (L=42 mm);
- 3/8" (9.5 mm): 10, 11, 12, 13, 14, 15, 16 mm (L=28 mm); 17, 18 mm (L=30 mm);
- 1/4" (6.3 mm): 6, 7, 8, 9, 10, 11, 12, 13 mm (L=25 mm); CrV 50BV30;
- 1/2" (12.7 mm): 17, 18, 19, 22 mm (L=76 mm), 3/8" (9.5 mm): 8, 10, 12, 13, 14, 15 mm (L=63 mm), 1/4" (6.3 mm): 6, 7, 8, 10, 12, 13 mm (L=50 mm); CrV 50BV30;
- 1/2" (12.7 mm): 17, 19, 21, 22 mm; CrV 50BV30;
- 3/8" (9.5 mm): E8, E10, E11, E12, E14, E16; CrV 6150;
- 1/2" (12.7 mm): (127, 254 mm), 3/8" (9.5 mm): (152.4, 254 mm), 1/4" (6.3 mm): (50.8, 101.6 mm); CrV 50BV30;
- 3/8" (9.5 mm) (F) x 1/2" (12.7 mm) (M); CrV 50BV30;
- 1/2" (12.7 mm), 3/8" (9.5 mm), 1/4" (6.3 mm); CrV 50BV30;
- 1/2" (12.7 mm): 16, 21 mm; CrV 50BV30;
- 3/8" (9.5 mm): (198 mm), 1/4" (6.3 mm): (152.4 mm); CrV 50BV30;
- 1/2" (12.7 mm): (255 mm), 3/8" (9.5 mm): (200 mm), 1/4" (6.3 mm): (155 mm); 72T; CrMo 440;
- 1/4" (6.3 mm): (150 mm); CrV 50BV30;
- 1/2" (12.7 mm): (250 mm); CrV 50BV30;
- 3/8" (9.5 mm) x 5/16" (7.9 mm); CrV 50BV30;
- 1/2" (12.7 mm) x 3/8" (9.5 mm), 3/8" (9.5 mm) x 1/4" (6.3 mm); CrV 50BV30;
- 1/4" (6.3 mm) x 1/4" (6.3 mm); CrV 50BV30;
- 3/8" (9.5 mm): 4, 5, 5.5, 6.5 mm (L=70 mm); AISI S2;
- 3/8" (9.5 mm): PH1, PH2, PH3 (L=70 mm); AISI S2;
- 3/8" (9.5 mm): T20, T30, T40, T45, T50, T55 (L=70 mm); AISI S2;
- 3/8" (9.5 mm): 6, 7, 8, 10, 12 mm (L=70 mm); AISI S2;
- 1/4" (6.3 mm): PZ1, PZ2 (L=25 mm); AISI S2;
- 1/4" (6.3 mm): T8, T10 (L=25 mm); AISI S2;
- 1/4" (6.3 mm): 4, 5, 5.5, 6.5 mm (L=37 mm); AISI S2 / CrV 6150;
- 1/4" (6.3 mm): PH1, PH2 (L=37 mm); AISI S2 / CrV 6150;
- 1/4" (6.3 mm): T8, T10, T15, T20, T25, T30, T40 (L=37 mm); AISI S2 / CrV 6150;
- 1/4" (6.3 mm): 3, 4, 5, 6 mm (L=37 mm); AISI S2 / CrV 6150;
- 8, 10, 12, 13, 14, 15, 16, 17, 18, 19 mm; CrV;
- 1.5, 2, 2.5 mm; CrV 6150

YATO	○	☐
YT-38872	1/4" (6.3 mm), 3/8" (9.5 mm), 1/2" (12.7 mm)	2

EN Tool set
PL Zestaw narzędziowy
DE Werkzeug-Satz

RU Набор инструментов
CZ Sada náradí
HU Szerszámkészlet

RO Trusa de scule
FR Jeu d'outils
IT Set di utensili

ES Juego de herramientas
CN 工具组套

129
PCS

1/2"
12.7mm

3/8"
9.5mm

1/4"
6.3mm

CrV
50BV30

CrV
6150

CrMo
440

S2











72T











AS-DRIVE





2



-  1/2" (12.7 mm): 12, 13, 14, 15, 16, 17, 18, 19, 20, 21, 22, 24 mm (L=38 mm); 27, 30, 32 mm (L=42 mm),
- 3/8" (9.5 mm): 10, 11, 12, 13, 14, 15, 16 mm (L=28 mm); 17, 18, 19 mm (L=30 mm),
- 1/4" (6.3 mm): 4, 4.5, 5, 5.5, 6, 7, 8, 9, 10, 11, 12, 13, 14 mm (L=25 mm); CrV 50BV30;
-  1/2" (12.7 mm): 10, 12, 13, 14, 17, 19 mm (L=76 mm), 1/4" (6.3 mm): 4, 5, 6, 7, 8, 9 mm (L=50 mm); CrV 50BV30;
-  1/2" (12.7 mm): 17, 19, 21, 23 mm; CrV 50BV30;
-  3/8" (9.5 mm): E8, E10, E11, E12, E14, E16, E18, E20; CrV 6150;
-  1/2" (12.7 mm): (127, 254 mm), 3/8" (9.5 mm): (76, 152.4 mm), 1/4" (6.3 mm): (50.8 mm); CrV 50BV30;
-  1/2" (12.7 mm), 3/8" (9.5 mm), 1/4" (6.3 mm); CrV 50BV30;
-  3/8" (9.5 mm): 16, 21 mm; CrV 50BV30;
-  1/2" (12.7 mm); (255 mm), 3/8" (9.5 mm); (200 mm), 1/4" (6.3 mm); (155 mm); 72T; CrMo 440;
-  1/4" (6.3 mm); (150 mm); CrV 50BV30;
-  3/8" (9.5 mm): 4, 5.5, 6.5 mm (L=50 mm); AISI S2 / CrV 6150;









-  3/8" (9.5 mm): PH1, PH2, PH3 (L=50 mm); AISI S2 / CrV 6150;
-  3/8" (9.5 mm): PZ1, PZ2, PZ3 (L=50 mm); AISI S2 / CrV 6150;
-  3/8" (9.5 mm): T20, T30, T40, T45, T50, T55, T60 (L=50 mm); AISI S2 / CrV 6150;
-  3/8" (9.5 mm): 3, 4, 5, 6, 8, 10 mm (L=50 mm); AISI S2 / CrV 6150;
-  8, 10, 11, 12, 13, 14, 15, 16, 17, 18, 19, 22 mm; CrV;
-  3x75, 4x100, 6x150, PH1x75, PH2x100, PH3x150 mm; S2;
-  160 mm;
-  160 mm;
-  160 mm;
-  1.5, 2, 2.5, 3, 4, 5, 6, 7, 8, 10 mm; CrV 6150













YATO 	○	
YT-38881	1/4" (6.3 mm), 3/8" (9.5 mm), 1/2" (12.7 mm)	2



EN Tool set RU Набор инструментов RO Trusa de scule ES Juego de herramientas
 PL Zestaw narzędziowy CZ Sada náradí FR Jeu d'outils CN 工具组套
 DE Werkzeug-Satz HU Szerszámkészlet IT Set di utensili

150 PCS	1/2" 12.7mm	3/8" 9.5mm	1/4" 6.3mm
METRIC SAE	CrV 50BV30	CrV 6150	CrV 6140
CrMo 440	S2	72T	AS-DRIVE



-  1/2" (12.7 mm): 20, 21, 22, 24 mm (L=38 mm); 27, 30, 32 mm (L=42 mm),
- 3/8" (9.5 mm): 9, 10, 11, 12, 13, 14, 15, 16 mm (L=28 mm); 17, 18, 19 mm (L=30 mm),
- 1/4" (6.3 mm): 4, 5, 6, 7, 8, 9, 10, 11, 12, 13 mm (L=25 mm); CrV 50BV30;
-  1/2" (12.7 mm): 10, 12, 13, 14, 17, 19 mm (L=76 mm); 3/8" (9.5 mm): 10, 11, 12, 13, 14, 15 mm (L=63 mm),
- 1/4" (6.3 mm): 4, 5, 6, 7, 8, 9 mm (L=50 mm); CrV 50BV30;
-  1/2" (12.7 mm) x 15/16" (23.8 mm), 1/2" (12.7 mm) x 1" (25.4 mm), 1/2" (12.7 mm) x 1-1/16" (27.0 mm),
- 1/2" (12.7 mm) x 1-1/4" (31.8 mm), 3/8" (9.5 mm) x 3/8" (9.5 mm), 3/8" (9.5 mm) x 7/16" (11.1 mm),
- 3/8" (9.5 mm) x 1/2" (12.7 mm), 3/8" (9.5 mm) x 9/16" (14.3 mm), 3/8" (9.5 mm) x 5/8" (15.9 mm),
- 3/8" (9.5 mm) x 11/16" (17.5 mm), 3/8" (9.5 mm) x 3/4" (19.0 mm), 3/8" (9.5 mm) x 13/16" (20.6 mm),
- 3/8" (9.5 mm) x 7/8" (22.2 mm), 1/4" (6.3 mm) x 5/32" (4.0 mm), 1/4" (6.3 mm) x 3/16" (4.8 mm),
- 1/4" (6.3 mm) x 7/32" (5.6 mm), 1/4" (6.3 mm) x 1/4" (6.3 mm), 1/4" (6.3 mm) x 9/32" (7.1 mm),
- 1/4" (6.3 mm) x 5/16" (7.9 mm), 1/4" (6.3 mm) x 11/32" (8.7 mm), 1/4" (6.3 mm) x 3/8" (9.5 mm),
- 1/4" (6.3 mm) x 7/16" (11.1 mm), 1/4" (6.3 mm) x 1/2" (12.7 mm); CrV 50BV30;
-  1/2" (12.7 mm): 17, 19, 21, 23 mm; CrV 50BV30;
-  3/8" (9.5 mm): E8, E10, E11, E12, E14, E16, E18, E20; CrV 6150;
-  1/2" (12.7 mm): (127, 254 mm), 3/8" (9.5 mm): (76, 152.4 mm), 1/4" (6.3 mm): (50.8 mm); CrV 50BV30;
-  1/2" (12.7 mm), 3/8" (9.5 mm), 1/4" (6.3 mm); CrV 50BV30;
-  3/8" (9.5 mm): 16, 21 mm; CrV 50BV30;

-  1/2" (12.7 mm); (255 mm), 3/8" (9.5 mm); (200 mm), 1/4" (6.3 mm); (155 mm); 72T; CrMo 440;
-  1/4" (6.3 mm); (150 mm); CrV 50BV30;
-  1/4" (6.3 mm) x 1/4" (6.3 mm); CrV 50BV30;
-  1/4" (6.3 mm): T10, T15, T20, T25, T27, T30, T40 (L=25 mm); AISI S2;
-  3/8" (9.5 mm): 4, 5.5, 6.5 mm (L=50 mm); AISI S2 / CrV 6150;
-  3/8" (9.5 mm): PH1, PH2, PH3 (L=50 mm); AISI S2 / CrV 6150;
-  3/8" (9.5 mm): PZ1, PZ2, PZ3 (L=50 mm); AISI S2 / CrV 6150;
-  3/8" (9.5 mm): T20, T30, T40, T45, T50, T55, T60 (L=50 mm); AISI S2 / CrV 6150;
-  3/8" (9.5 mm): 3, 4, 5, 6, 8, 10 mm (L=50 mm); AISI S2 / CrV 6150;
-  8, 9, 10, 11, 12, 13, 14, 15, 16, 17, 18, 19 mm; CrV;
-  8x10, 12x13, 17x19 mm; CrV 6140;
-  1.5, 2, 2.5, 3, 4, 5, 6, 7, 8, 10 mm; CrV 6150

YATO 		
YT-38811	1/4" (6.3 mm), 3/8" (9.5 mm), 1/2" (12.7 mm)	2

EN Tool set
PL Zestaw narzędziowy
DE Werkzeug-Satz
RU Набор инструментов

CZ Sada nářadí
HU Szerszámkészlet
RO Trusa de scule
FR Jeu d'outils

IT Set di utensili
ES Juego de herramientas
CN 工具组套

173 PCS	1/2" 12.7mm	3/8" 9.5mm	1/4" 6.3mm
CrV 50BV30	CrV 6150	CrV 40	CrMo 440
S2	72T	AS-DRIVE	

2



- 1/2" (12.7 mm): 10, 11, 12, 13, 14, 15, 16, 17, 18, 19, 20, 21, 22, 23, 24 mm (L=38 mm); 27, 30, 32 mm (L=42 mm);
- 3/8" (9.5 mm): 10, 11, 12, 13, 14, 15, 16 mm (L=28 mm); 17, 18, 19 mm (L=30 mm);
- 1/4" (6.3 mm): 4, 4.5, 5, 5.5, 6, 7, 8, 9, 10, 11, 12, 13, 14 mm (L=25 mm); CrV 50BV30;
- 1/2" (12.7 mm): 16, 17, 18, 19, 22 mm (L=76 mm); 3/8" (9.5 mm): 10, 11, 12, 13, 14, 15 mm (L=63 mm);
- 1/4" (6.3 mm): 4, 5, 6, 7, 8, 9, 10 mm (L=50 mm); CrV 50BV30;
- 1/2" (12.7 mm): E18, E20, E24, 3/8" (9.5 mm): E10, E11, E12, E14, E16, 1/4" (6.3 mm): E4, E5, E6, E7, E8; CrV 6150;
- 1/2" (12.7 mm): (127, 254 mm), 3/8" (9.5 mm): (152.4 mm), 1/4" (6.3 mm): (50.8, 101.6 mm); CrV 50BV30;
- 3/8" (9.5 mm) (F) x 1/2" (12.7 mm); CrV 50BV30;
- 1/2" (12.7 mm), 3/8" (9.5 mm), 1/4" (6.3 mm); CrV 50BV30;
- 1/2" (12.7 mm): 16, 21 mm, 3/8" (9.5 mm): 18 mm; CrV 50BV30;
- 1/4" (6.3 mm): (152.4 mm); CrV 40;
- 1/2" (12.7 mm): (255 mm), 3/8" (9.5 mm): (200 mm), 1/4" (6.3 mm): (155 mm); 72T; CrMo 440;
- 1/4" (6.3 mm): (150 mm); CrV 50BV30;
- 1/2" (12.7 mm) x 5/16" (7.9 mm), 3/8" (9.5 mm) x 5/16" (7.9 mm); CrV 50BV30;
- 1/4" (6.3 mm) x 1/4" (6.3 mm); CrV 50BV30;
- 5/16" (7.9 mm): 8, 10, 12 mm (L=30 mm); AISI S2;
- 5/16" (7.9 mm): PH3, PH4 (L=30 mm); AISI S2;

- 5/16" (7.9 mm): PZ3, PZ4 (L=30 mm); AISI S2;
- 5/16" (7.9 mm): T40, T45, T50, T55, T60, T70 (L=30 mm); AISI S2;
- 5/16" (7.9 mm): T40, T45, T50, T55, T60, T70 (L=30 mm); AISI S2;
- 5/16" (7.9 mm): 7, 8, 10, 12, 14 mm (L=30 mm); AISI S2;
- 1/4" (6.3 mm): T5, T6, T7 (L=25 mm); AISI S2;
- 1/4" (6.3 mm): T7, T10, T15, T20, T25, T27, T30, T40, T45 (L=25 mm); AISI S2;
- 1/4" (6.3 mm): M5, M6, M8 (L=25 mm); AISI S2;
- 1/4" (6.3 mm): RM5, RM6, RM7, RM8, RM9 (L=25 mm); AISI S2;
- 1/4" (6.3 mm) 4, 5.5, 6.5, 7 mm (L=37 mm); AISI S2 / CrV 6150;
- 1/4" (6.3 mm): PH0, PH1, PH2 (L=37 mm); AISI S2 / CrV 6150;
- 1/4" (6.3 mm) PZ0, PZ1, PZ2 (L=37 mm); AISI S2 / CrV 6150;
- 1/4" (6.3 mm): T8, T9, T10, T15, T20, T25, T27, T30 (L=37 mm); AISI S2 / CrV 6150;
- 1/4" (6.3 mm): T8, T9, T10, T15, T20, T25, T27, T30 (L=37 mm); AISI S2 / CrV 6150;
- 1/4" (6.3 mm): 3, 4, 5, 6 mm (L=37 mm); AISI S2 / CrV 6150;
- 1.25, 1.5, 2, 2.5, 3, 4, 5 mm; CrV 6150

YATO		
YT-38931	1/4" (6.3 mm), 3/8" (9.5 mm), 1/2" (12.7 mm)	2

EN Tool set
 PL Zestaw narzędziowy
 DE Werkzeug-Satz
 RU Набор инструментов

CZ Sada nářadí
 HU Szerszámkészlet
 RO Trusa de scule
 FR Jeu d'outils

IT Set di utensili
 ES Juego de herramientas
 CN 工具组套

198 PCS	1/2" 12.7mm	3/8" 9.5mm	1/4" 6.3mm	CrV 50BV30
		CrV 6150	CrV 6140	CrMo 440
		S2	72T	AS-DRIVE



- 1/2" (12.7 mm): 10, 11, 12, 13, 14, 15, 16, 17, 18, 19, 20, 21, 22, 24 mm (L=38 mm); 27, 30, 32 mm (L=42 mm);
- 3/8" (9.5 mm): 10, 11, 12, 13, 14, 15, 16 mm (L=28 mm); 17, 18, 19 mm (L=30 mm);
- 1/4" (6.3 mm): 4, 4.5, 5, 5.5, 6, 7, 8, 9, 10, 11, 12, 13, 14 mm (L=25 mm); CrV 50BV30;
- 1/2" (12.7 mm): 16, 18 mm (L=76 mm); 3/8" (9.5 mm): 10, 11, 12, 13, 14, 15 mm (L=63 mm);
- 1/4" (6.3 mm): 4, 5, 6, 7, 8, 9, 10 mm (L=50 mm); CrV 50BV30;
- 1/2" (12.7 mm): E20, E24, 3/8" (9.5 mm): E10, E11, E12, E14, E16, E18, 1/4" (6.3 mm): E4, E5, E6, E7, E8; CrV 6150;
- 1/2" (12.7 mm): 17, 19, 21 mm (L=87 mm); CrMo;
- 1/2" (12.7 mm): (127, 254 mm), 3/8" (9.5 mm): (152.4 mm), 1/4" (6.3 mm): (50.8, 101.6 mm); CrV 50BV30;
- 3/8" (9.5 mm) (F) x 1/2" (12.7 mm) (M); CrV 50BV30;
- 1/2" (12.7 mm), 3/8" (9.5 mm), 1/4" (6.3 mm); CrV 50BV30;
- 1/2" (12.7 mm): 16, 21 mm, 3/8" (9.5 mm): 18 mm; CrV 50BV30;
- 1/4" (6.3 mm): (115 mm); CrV 50BV30;
- 1/2" (12.7 mm): (255 mm), 3/8" (9.5 mm): (200 mm), 1/4" (6.3 mm): (155 mm); 72T; CrV 6140;
- 1/4" (6.3 mm): (150 mm); CrV 50BV30;
- 1/2" (12.7 mm) x 3/8" (9.5 mm), 3/8" (9.5 mm) x 5/16" (7.9 mm); CrV 50BV30;
- 1/4" (6.3 mm) x 1/4" (6.3 mm); CrV 50BV30;
- 3/8" (9.5 mm): T55, T60, T70 (L=30 mm); AISI S2;
- 3/8" (9.5 mm), T55, T60, T70 (L=30 mm); AISI S2;
- 5/16" (7.9 mm): 8, 10, 12 mm (L=30 mm); AISI S2;
- 5/16" (7.9 mm): PH3, PH4 (L=30 mm); AISI S2;
- 5/16" (7.9 mm): PZ3, PZ4 (L=30 mm); AISI S2;

- 5/16" (7.9 mm): T40, T45, T50 (L=30 mm); AISI S2;
- 5/16" (7.9 mm): T40, T45, T50 (L=30 mm); AISI S2;
- 5/16" (7.9 mm): 7, 8, 10, 12, 14 mm (L=30 mm); AISI S2;
- 1/4" (6.3 mm): 6-8, 8-10 x2, 10-12 (L=25 mm); AISI S2;
- 1/4" (6.3 mm): PH0, PH1, PH2, PH3 (L=25 mm); AISI S2;
- 1/4" (6.3 mm): PZ1, PZ2, PZ3 (L=25 mm); AISI S2;
- 1/4" (6.3 mm): T10, T15, T20, T25, T27, T30 (L=25 mm); AISI S2;
- 1/4" (6.3 mm): S1, S2, S3 (L=25 mm); AISI S2;
- 1/4" (6.3 mm): 4, 5.5, 6.5, 7 mm (L=37 mm); AISI S2 / CrV 6150;
- 1/4" (6.3 mm): PH0, PH1, PH2 (L=37 mm); AISI S2 / CrV 6150;
- 1/4" (6.3 mm): PZ0, PZ1, PZ2 (L=37 mm); AISI S2 / CrV 6150;
- 1/4" (6.3 mm): T8, T9, T10, T15, T20, T25, T27, T30 (L=37 mm); AISI S2 / CrV 6150;
- 1/4" (6.3 mm): T8, T9, T10, T15, T20, T25, T27, T30 (L=37 mm); AISI S2 / CrV 6150;
- 1/4" (6.3 mm): 3, 4, 5, 6 mm (L=37 mm); AISI S2 / CrV 6150;
- 1/4" (6.3 mm): M8, M10, M12 (L=37 mm); AISI S2 / CrV 6150;
- 8, 9, 10, 11, 12, 13, 14, 15, 16, 17, 18, 19 mm; CrV;
- 1.5, 2, 2.5, 3, 4, 5, 6, 8, 10 mm, T10, T15, T20, T25, T27, T30, T40, T45, T50; CrV 6150

YATO	○	☐
YT-38850	1/4" (6.3 mm), 3/8" (9.5 mm), 1/2" (12.7 mm)	2

EN Tool set
PL Zestaw narzędziowy
DE Werkzeug-Satz
RU Набор инструментов

CZ Sada nafiadí
HU Szerszámkészlet
RO Trusa de scule
FR Jeu d'outils

IT Set di utensili
ES Juego de herramientas
CN 工具组套

216 PCS	1/2" 12.7mm	3/8" 9.5mm	1/4" 6.3mm	CrV 50BV30
CrV 6150	CrV 40	CrMo 440	S2	72T
		AS-DRIVE		



- 1/2" (12.7 mm): 10, 11, 12, 13, 14, 15, 17, 19, 20, 21, 22, 24 mm (L=38 mm); 27, 30, 32 mm (L=42 mm);
- 3/8" (9.5 mm): 10, 11, 12, 13, 14, 15, 16 mm (L=28 mm); 17, 18, 19 mm (L=30 mm);
- 1/4" (6.3 mm): 4, 4.5, 5, 5.5, 6, 7, 8, 9, 10, 11, 12, 13, 14 mm (L=25 mm); CrV 50BV30;
- 1/2" (12.7 mm): 16, 17, 18, 19, 22 mm (L=76 mm); 3/8" (9.5 mm): 10, 11, 12, 13, 14, 15 mm (L=63 mm);
- 1/4" (6.3 mm): 4, 5, 6, 7, 8, 9, 10 mm (L=50 mm); CrV 50BV30;
- 1/2" (12.7 mm): E20, E22, E24, 3/8" (9.5 mm): E10, E11, E12, E14, E16, E18,
- 1/4" (6.3 mm): E4, E5, E6, E7, E8; CrV 50BV30;
- 1/2" (12.7 mm): (127, 254 mm), 3/8" (9.5 mm): (125 mm), 1/4" (6.3 mm): (50.8, 101.6 mm); CrV 50BV30;
- 1/2" (12.7 mm), 3/8" (9.5 mm), 1/4" (6.3 mm); CrV 50BV30;
- 1/2" (12.7 mm): 16, 21 mm, 3/8" (9.5 mm): 18 mm; CrV 50BV30;
- 1/2" (12.7 mm): (255 mm), 1/4" (6.3 mm): (152.4 mm); CrV 40;
- 1/2" (12.7 mm): (255 mm), 3/8" (9.5 mm): (200 mm), 1/4" (6.3 mm): (155 mm); 72T; CrMo 440;
- 1/4" (6.3 mm): (150 mm); CrV 50BV30;
- 1/4" (6.3 mm): (200 mm);
- 1/2" (12.7 mm) x 5/16" (7.9 mm), 3/8" (9.5 mm) x 5/16" (7.9 mm); CrV 50BV30;
- 1/4" (6.3 mm) x 1/4" (6.3 mm); CrV 50BV30;
- 5/16" (7.9 mm): 6, 6.5, 8 mm (L=30 mm); AISI S2;
- 5/16" (7.9 mm): PH3, PH4 (L=30 mm); AISI S2;
- 5/16" (7.9 mm): PZ3, PZ4 (L=30 mm); AISI S2;
- 5/16" (7.9 mm): T25, T27, T30, T35, T40 x2, T45, T50 (L=30 mm); AISI S2;
- 5/16" (7.9 mm): T27, T30, T35, T40, T45, T50 (L=30 mm); AISI S2;
- 5/16" (7.9 mm): 5.5, 6, 6.5, 7, 8 mm (L=30 mm); AISI S2;
- 5/16" (7.9 mm): M5, M6, M8, M10 (L=30 mm); AISI S2;
- 1/4" (6.3 mm): 4, 5.5, 6.5 mm (L=25 mm); AISI S2;



- 1/4" (6.3 mm): PH1, PH2 (L=25 mm); AISI S2;
- 1/4" (6.3 mm): PZ1, PZ2 (L=25 mm); AISI S2;
- 1/4" (6.3 mm): T8, T10, T15, T20, T25 (L=25 mm); AISI S2;
- 1/4" (6.3 mm): T8, T10 x2, T15 x2, T20 x2, T25 x2, T40 (L=25 mm); AISI S2;
- 1/4" (6.3 mm): 3, 4, 5, 6 mm (L=25 mm); AISI S2;
- 1/4" (6.3 mm): 3, 4, 5, 6 mm (L=25 mm); AISI S2;
- 1/4" (6.3 mm): M5, M6, M8 (L=25 mm); AISI S2;
- 1/4" (6.3 mm): S1, S2 (L=25 mm); AISI S2;
- 1/4" (6.3 mm): 1, 2, 3 mm (L=25 mm); AISI S2;
- 1/4" (6.3 mm): 6, 8, 10 mm (L=25 mm); AISI S2;
- 1/4" (6.3 mm): 4, 6, 8 mm (L=25 mm); AISI S2;
- 1/2" (12.7 mm): T55, T60 (L=50 mm); AISI S2 / CrV 50BV30;
- 1/4" (6.3 mm): 6, 6.5, 8 mm (L=37 mm); AISI S2 / CrV 50BV30;
- 1/4" (6.3 mm): PH3, PH4 (L=37 mm); AISI S2 / CrV 50BV30;
- 1/4" (6.3 mm): PZ3, PZ4 (L=37 mm); AISI S2 / CrV 50BV30;
- 1/4" (6.3 mm): T25, T27, T30, T35, T40 x2, T45, T50 (L=37 mm); AISI S2 / CrV 50BV30;
- 1/4" (6.3 mm): T27, T30, T35, T40, T45, T50 (L=37 mm); AISI S2 / CrV 50BV30;
- 1/4" (6.3 mm): 5.5, 6, 6.5, 7, 8 mm (L=37 mm); AISI S2 / CrV 50BV30;
- 1/4" (6.3 mm): M5, M6, M8, M10 (L=37 mm); AISI S2 / CrV 50BV30;
- 8, 10, 11, 12, 13, 14, 15, 16, 17, 18, 19, 22 mm; CrV;
- 1.27, 1.5, 2, 2.5, 3, 4, 5 mm; CrV 6150

YATO		
YT-38841	1/4" (6.3 mm), 3/8" (9.5 mm), 1/2" (12.7 mm)	2















EN Tool set
 PL Zestaw narzędziowy
 DE Werkzeug-Satz
 RU Набор инструментов

















CZ Sada nářadí
 HU Szerszámkészlet
 RO Trusa de scule
 FR Jeu d'outils



IT Set di utensili
 ES Juego de herramientas
 CN 工具组套

225 PCS	1/2" 12.7mm	3/8" 9.5mm	1/4" 6.3mm
METRIC SAE	CrV 50BV30	CrV 6150	CrV 6140
CrV 40	CrMo 440	S2	72T
AS-DRIVE			



-  1/2" (12.7 mm): 10, 13, 15, 16, 17, 18, 19, 20, 21, 22, 23, 24 mm (L=38 mm); 27, 30, 32 mm (L=42 mm);
- 3/8" (9.5 mm): 10, 11, 12, 13, 14, 15, 16 mm (L=28 mm); 17, 18, 19 mm (L=30 mm);
- 1/4" (6.3 mm): 3.5, 4, 4.5, 5, 5.5, 6, 7, 8, 9, 10, 11, 12, 13, 14 mm (L=25 mm); CrV 50BV30;
-  1/2" (12.7 mm): 10, 11, 12, 13, 14, 15, 17, 19, 21 mm (L=76 mm);
- 3/8" (9.5 mm): 6, 7, 8, 9, 10 mm (L=63 mm); CrV 50BV30;
-  1/2" (12.7 mm) x 7/16" (11.1 mm), 1/2" (12.7 mm) x 1/2" (12.7 mm), 1/2" (12.7 mm) x 9/16" (14.3 mm),
- 1/2" (12.7 mm) x 5/8" (15.9 mm), 1/2" (12.7 mm) x 11/16" (17.5 mm), 1/2" (12.7 mm) x 3/4" (19.0 mm),
- 1/2" (12.7 mm) x 13/16" (20.6 mm), 1/2" (12.7 mm) x 7/8" (22.2 mm), 1/4" (6.3 mm) x 1/4" (6.3 mm),
- 1/4" (6.3 mm) x 9/32" (7.1 mm), 1/4" (6.3 mm) x 5/16" (7.9 mm), 1/4" (6.3 mm) x 11/32" (8.7 mm),
- 1/4" (6.3 mm) x 3/8" (9.5 mm); CrV 50BV30;
-  1/2" (12.7 mm): 17, 19, 21 mm; CrV 50BV30;
-  1/2" (12.7 mm): E16, E18, E20, E22, E24, 3/8" (9.5 mm): E10, E11, E12, E14,
- 1/4" (6.3 mm): E4, E5, E6, E7, E8; CrV 6150;
-  1/2" (12.7 mm): (127, 254 mm); 3/8" (9.5 mm): (76, 254 mm), 1/4" (6.3 mm): (50.8, 101.6 mm); CrV 50BV30;
-  3/8" (9.5 mm) (F) x 1/2" (12.7 mm) (M), 1/2" (12.7 mm) (F) x 3/8" (9.5 mm) (M); CrV 50BV30;
-  1/2" (12.7 mm), 3/8" (9.5 mm), 1/4" (6.3 mm); CrV 50BV30;
-  1/2" (12.7 mm): 16, 21 mm (L=64 mm); 3/8" (9.5 mm): 18 mm (L=63 mm); CrV 50BV30;
-  1/4" (6.3 mm): (152.4 mm); CrV 40;
-  1/2" (12.7 mm): (255 mm), 3/8" (9.5 mm): (200 mm), 1/4" (6.3 mm): (155 mm); 72T, CrMo 440;
-  1/4" (6.3 mm): (150 mm); CrV 50BV30;
-  1/4" (6.3 mm): (200 mm); CrV 6140;
-  1/2" (12.7 mm) x 5/16" (7.9 mm), 3/8" (9.5 mm) x 5/16" (7.9 mm), 3/8" (9.5 mm) x 1/4" (6.3 mm); CrV 50BV30;
- 1/4" (6.3 mm) x 1/4" (6.3 mm); CrV 50BV30;
- 1/4" (6.3 mm) x 3/8" (9.5 mm) (L=50 mm), 1/4" (6.3 mm) x 1/4" (6.3 mm) (L=50 mm),
- 1/4" (6.3 mm) x 1/4" (6.3 mm) (L=25 mm); CrV 50BV30;

-  1/4" (6.3 mm) (L=60 mm);
-  5/16" (7.9 mm): T20, T25, T27, T30, T40, T45, T50, T55 (L=75 mm); AISI S2;
-  5/16" (7.9 mm): 8, 10 mm (L=30 mm); AISI S2;
-  5/16" (7.9 mm): PH3, PH4 (L=30 mm); AISI S2;
-  5/16" (7.9 mm): PZ3, PZ4 (L=30 mm); AISI S2;
-  5/16" (7.9 mm): T40, T45, T50, T55, T60, T70 (L=30 mm); AISI S2;
-  5/16" (7.9 mm): T40, T45, T50, T55, T60, T70 (L=30 mm); AISI S2;
-  5/16" (7.9 mm): 10, 12, 14 mm (L=30 mm); AISI S2;
-  1/4" (6.3 mm): 3, 4, 5.5, 6.5, 7, 8, 9 mm (L=25 mm); AISI S2;
-  1/4" (6.3 mm): PH0, PH1, PH2, PH3 (L=25 mm); AISI S2;
-  1/4" (6.3 mm): PZ0, PZ1, PZ2, PZ3 (L=25 mm); AISI S2;
-  1/4" (6.3 mm): T8, T9, T10, T15, T20, T25, T27, T30 (L=25 mm); AISI S2;
-  1/4" (6.3 mm): T8, T9, T10, T15, T20, T25, T27, T30 (L=25 mm); AISI S2;
-  1/4" (6.3 mm): 3, 4, 5, 6, 7, 8 mm; (L=25 mm); AISI S2;
-  1/4" (6.3 mm): 3, 4, 5, 6, 7, 8 mm (L=25 mm); AISI S2;
-  1/4" (6.3 mm): 4, 5, 6, 7, 8 mm (L=25 mm); AISI S2;
- 1/4" (6.3 mm): 1, 2, 3, 4 (L=25 mm); AISI S2;
- 1/4" (6.3 mm): 6, 8, 10 (L=25 mm); AISI S2;
- 1/4" (6.3 mm): 4, 6, 8, 10 mm (L=25 mm); AISI S2;
- 8, 9, 10, 11, 12, 13, 14, 15, 17, 19, 22 mm; CrV;
- 6x38, PH2X38; S2;
- 180 mm;
- 250 mm; CrV;
- 2, 2.5, 3, 4, 5, 6, 7, 8, 10, 12 mm; CrV 6150

YATO 		
YT-38941	1/4" (6.3 mm), 3/8" (9.5 mm), 1/2" (12.7 mm)	2

EN Tool set
 PL Zestaw narzędziowy
 DE Werkzeug-Satz

RU Набор инструментов
 CZ Sada nářadí
 HU Szerszámkészlet

RO Trusa de scule
 FR Jeu d'outils
 IT Set di utensili

ES Juego de herramientas
 CN 工具组套



- 1/4" (6.3 mm): 4, 5, 6, 7, 8, 9, 10, 12, 13 mm (L=25 mm); CrV 50BV30;
- 1/4" (6.3 mm): 4, 5, 6, 7, 8, 9, 10, 12, 13 mm (L=50 mm); CrV 50BV30;
- 1/4" (6.3 mm): (50.8, 152.4 mm); CrV 50BV30;
- 1/4" (6.3 mm); CrV 50BV30;
- 1/4" (6.3 mm); (127 mm); 72T; CrV 6140;
- 1/4" (6.3 mm); (150 mm); CrV 50BV30

23 PCS	1/4" 6.3mm	CrV 50BV30
CrV 6140	72T	AS-DRIVE

YATO	○	
YT-14421	1/4" (6.3 mm)	10

EN Go through socket set
 PL Zestaw nasadek przelotowych z grzechotką
 DE Ratschensteckschlüsselsatz

RU Набор проходных головок с трещоткой
 CZ Sada násadových koncovek s ráčnou
 HU Dugókulcs készlet racsníval

RO Set tubulare pt. suruburi lungi
 FR Jeu de douilles traversantes avec cliquet
 IT Set di bussole con chiave a cricchetto

ES Juego de puntas de paso de trinquete
 CN 穿心套筒组套



- 4, 5, 5.5, 6, 7, 8, 9, 10, 11, 12, 13 mm; CrV 50BV30;
- 1/4" (6.3 mm); (L=100 mm); CrV 50BV30;
- 1/4" (6.3 mm); CrV 50BV30;
- (L=142 mm); 72T; CrV 50BV30;
- 1/4" (6.3 mm); CrV 50BV30;
- 1/4" (6.3 mm); CrV 50BV30;
- 1/4" (6.3 mm) x 1/4" (6.3 mm); CrV 50BV30;
- 1/4" (6.3 mm); CrV 50BV30;
- (L=50 mm); CrV 50BV30;
- 1/4" (6.3 mm); 4, 5, 7 mm; S2;
- 1/4" (6.3 mm); PH1, PH2; S2;
- 1/4" (6.3 mm); PZ1, PZ2; S2;
- 1/4" (6.3 mm); T10, T15, T20; S2

29 PCS	1/4" 6.3mm	
CrV 50BV30	S2	72T

QUICK RELEASE SZYBKO-ZŁĄCZE

YATO	○	
YT-38650	1/4" (6.3 mm)	20

EN Tool set
 PL Zestaw narzędziowy
 DE Werkzeug-Satz

RU Набор инструментов
 CZ Sada nářadí
 HU Szerszámkészlet

RO Trusa de scule
 FR Jeu d'outils
 IT Set di utensili

ES Juego de herramientas
 CN 工具组套



- 1/2" (12.7 mm): 10, 11, 12, 13, 14, 15, 16, 17, 18, 19, 20, 21, 22, 23, 24 mm (L=38 mm); 27, 30, 32 mm (L=42 mm); CrV 50BV30;
- 1/2" (12.7 mm); (50, 125 mm); CrV 50BV30;
- 1/2" (12.7 mm): 16, 21 mm; CrV 50BV30;
- 1/2" (12.7 mm); (250 mm); CrV 50BV30;
- 1/2" (12.7 mm); (250 mm); 72T; CrV 6140;
- 1/2" (12.7 mm); (317 mm); CrV 50BV30

25 PCS	1/2" 12.7mm	CrV 50BV30
CrV 6140	72T	AS-DRIVE

YATO	○	
YT-12671	1/2" (12.7 mm)	5

EN Go through socket set
 PL Zestaw nasadek przelotowych z grzechotką
 DE Ratschensteckschlüsselsatz

RU Набор проходных головок с трещоткой
 CZ Sada násadových koncovek s ráčnou
 HU Dugókulcs készlet racsníval

RO Set tubulare pt. suruburi lungi
 FR Jeu de douilles traversantes avec cliquet
 IT Set di bussole con chiave a cricchetto

ES Juego de puntas de paso de trinquete
 CN 穿心套筒组套



- 10, 11, 12, 13, 14, 15, 16, 17, 18, 19, 21, 22, 24 mm; CrV 50BV30;
- (L=195 mm); 72T; CrV 50BV30;
- (L=76 mm); CrV 50BV30;
- 1/2" (12.7 mm), 3/8" (9.5 mm); CrV 50BV30

17 PCS	1/2" 12.7mm	3/8" 9.5mm
	CrV 50BV30	72T

QUICK RELEASE SZYBKO-ZŁĄCZE

YATO	○	
YT-38653	3/8" (9.5 mm), 1/2" (12.7 mm)	10

- EN Tool set
- PL Zestaw narzędziowy
- DE Werkzeug-Satz
- RU Набор инструментов
- CZ Sada nářadí
- HU Szerszámkészlet
- RO Trusa de scule
- FR Jeu d'outils
- IT Set di utensili
- ES Juego de herramientas
- CN 工具组套

44 PCS 1/4" 6.3mm

 CrV S2 SK2



- 6x7, 8x9, 10x11, 12x13, 14x15 mm;
- 1/4" (6.3 mm): 3, 4, 5, 5.5, 6 mm (L=25 mm); AISI S2;
- 1/4" (6.3 mm): PH1, PH2, PH3 (L=25 mm); AISI S2;
- 1/4" (6.3 mm): T8, T10, T15, T20, T25, T27 (L=25 mm); AISI S2;
- 1/4" (6.3 mm): 2, 2.5, 3, 4, 5, 6 mm (L=25 mm); AISI S2;
- 160 mm;
- 160 mm;
- 200 mm;
- 300 g (L=300 mm);
- 3 m x 16 mm;
- 18 mm; SK2;
- 1/4" (6.3 mm); CrV;
- 5x75, 6x100, PH2x100 mm; S2;
- 1.5, 2, 2.5, 3, 4, 5, 6, 8, 10 mm; CrV 6150



YATO

YT-39280 1/4" (6.3 mm) 4

- EN Torx socket
- PL Nasadka Torx
- DE Torx-Steckschlüssel
- RU Голнока
- CZ Nástavec Torx
- HU Dugókulcs Torx
- RO Cheie tubulară Torx
- FR Douille Torx
- IT Bullone Torx
- ES Boquilla Torx
- CN 星型套筒

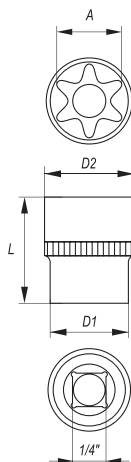

1/4" 6.3mm



CrV 50BV30



YATO	☆ A	D1 [mm]	D2 [mm]	L [mm]	PCS (BOX)	
YT-05211	E4	11.9	6.7	25	24	240/480
YT-05212	E5	11.9	7.2	25	24	240/480
YT-05213	E6	11.9	8.3	25	24	240/480
YT-05214	E7	11.9	9.4	25	24	240/480
YT-05215	E8	11.9	10	25	24	240/480

- EN Torx socket
- PL Nasadka Torx
- DE Torx-Steckschlüssel
- RU Голнока
- CZ Nástavec Torx
- HU Dugókulcs Torx
- RO Cheie tubulară Torx
- FR Douille Torx
- IT Bullone Torx
- ES Boquilla Torx
- CN 星型套筒

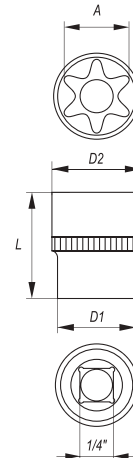

1/4" 6.3mm



E8

DIN 2124

CrV 50BV30



YATO ☆ A D1 [mm] D2 [mm] L [mm]

YT-05244 E8 11.9 10 25 6/360

EN Torx socket set
PL Zestaw nasadek Torx
DE Torx-Steckschlüsselsatz
RU Набор головок Torx
CZ Sada nástavců Torx
HU Dugókulcs készlet Torx

RO Trusă tubulare Torx
FR Jeu de douilles Torx
IT Set di chiavi a bussola Torx
ES Juego de vasos Torx
CN 星型套筒组套

9
PCS



3/8"
9.5 mm

1/4"
6.3 mm



CrV
50BV30



 1/4" (6.3 mm): E5, E6, E7, E8, 3/8" (9.5 mm): E10, E12, E14, E16;
 1/4" (6.3 mm) (M) x 3/8" (9.5 mm) (F)

YATO	○	
YT-0520	1/4" (6.3 mm)	10/40

EN Torx socket
PL Nasadka Torx
DE Torx-Steckschlüssel
RU Головка
CZ Nástavec Torx
HU Dugókulcs Torx
RO Cheie tubulară Torx
FR Douille Torx
IT Bullone Torx
ES Boquilla Torx
CN 星型套筒

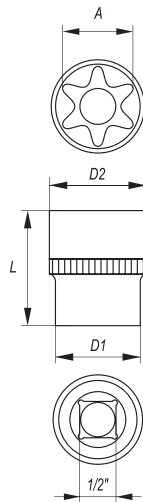

1/2"
12.7 mm



DIN
2124

CrV
50BV30



YATO	○ A	D1 [mm]	D2 [mm]	L [mm]	
YT-05245	E10	21.8	13.1	38	6/180
YT-05246	E11	21.8	13.9	38	6/180
YT-05247	E12	21.8	14.9	38	6/180
YT-05248	E14	21.8	16.3	38	6/180
YT-05249	E16	21.8	18.2	38	6/180
YT-05250	E18	23.8	19.4	38	6/180
YT-05251	E20	21.8	23.9	38	6/180

EN Hexagonal socket
PL Nasadka sześciokątna
DE Sechskantenschlüssel
RU Головка шестигранная короткая
CZ Šestihranný nástavec
HU Dugókulcs hatszög

RO Cheie tubulară hexagonală
FR Douille courte
IT Chiave a bussola esagonale
ES Boquilla hexagonal corta
CN 六角套筒

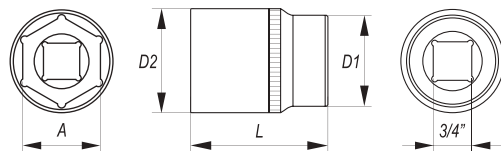

- Application: industry, car service stations and workshops
- For high loads
- Drive locks
- Surface finish: chromed, satin

- Przeznaczenie: przemysł, serwisy i warsztaty
- Do największych obciążeń
- Zamki blokujące
- Wykończenie powierzchni: chromowana, satynowa

YATO	○ A [mm]	D1 [mm]	D2 [mm]	L [mm]	PCS ROCK	
YT-1301	19	30	36	50	12	96
YT-1302	21	32	36	50	12	96
YT-1303	22	32	36	50	12	96
YT-1304	23	34	36	50	12	96
YT-1305	24	34	36	50	12	96
YT-1306	25	36	36	50	12	96
YT-1307	26	37	34	50	12	96
YT-1308	27	38	34	50	12	96
YT-1309	28	40	34	50	12	96
YT-1310	29	40	35	50	12	96
YT-1311	30	42	36	55	8	48
YT-1312	32	44	37	55	8	48
YT-1313	33	46	38	55	8	48

EN Torx socket
PL Nasadka Torx
DE Torx-Steckschlüssel
RU Головка
CZ Nástavec Torx
HU Dugókulcs Torx
RO Cheie tubulară Torx
FR Douille Torx
IT Bullone Torx
ES Boquilla Torx
CN 星型套筒

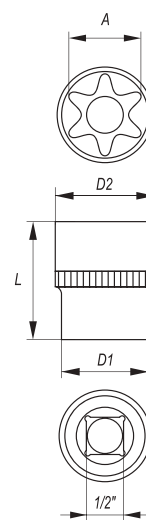

1/2"
12.7 mm



CrV
50BV30



YATO	○ A	D1 [mm]	D2 [mm]	L [mm]	PCS ROCK	
YT-05220	E10	21.8	13.1	38	12	120/240
YT-05221	E11	21.8	13.9	38	12	120/240
YT-05222	E12	21.8	14.9	38	12	120/240
YT-05223	E14	21.8	16.3	38	12	120/240
YT-05224	E16	21.8	18.2	38	12	120/240
YT-05225	E18	23.8	19.4	38	12	120/240
YT-05226	E20	21.8	23.9	38	12	120/240
YT-05227	E22	23.2	25.7	38	12	120/240
YT-05228	E24	23.8	27.8	38	12	60/120

EN Torx socket set
PL Zestaw nasadek Torx
DE Torx-Steckschlüsselsatz
RU Набор головок Torx
CZ Sada nástavců Torx
HU Dugókulcs készlet Torx

RO Trusă tubulare Torx
FR Jeu de douilles Torx
IT Set di chiavi a bussola Torx
ES Juego de vasos Torx
CN 星型套筒组套

9
PCS

1/2"
12.7 mm



CrV
50BV30



 1/2" (12.7 mm): E10, E11, E12, E14, E16, E18, E20, E22, E24

YATO	○	
YT-0521	1/2" (12.7 mm)	20

3/4"
19 mm

DIN
3121

CrV
50BV30

AS-DRIVE



YATO	○ A [mm]	D1 [mm]	D2 [mm]	L [mm]	PCS ROCK	
YT-1314	34	47	38	55	8	48
YT-1315	35	48	42	60	6	36
YT-1316	36	50	42	60	6	36
YT-1317	38	52	45	60	6	36
YT-1318	41	56	45	65	4	32
YT-1319	42	57	45	65	4	32
YT-1320	43	58	45	65	4	32
YT-1322	46	62	48	70	4	32
YT-1323	48	64	48	70	4	24
YT-1324	50	68	48	70	4	24
YT-1326	52	70	48	70	4	20
YT-1328	55	73	48	75	4	20
YT-1330	60	80	48	80	4	20

- EN Extension bar
- PL Przedłużka
- DE Verlängerung
- RU Удлинитель для воротка
- CZ Prodlužovací přípravek
- HU Toldalék
- RO Prelungitor
- FR Rallonge
- IT Prolunga
- ES Tubo de prolongación
- CN 接杆



3/4"
19mm **DIN 3121** **CrV 50BV30**

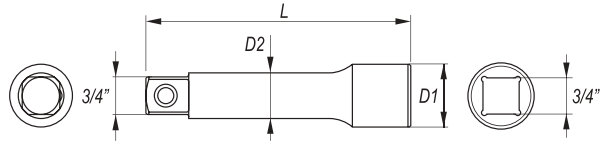

YATO	Ø	D1 [mm]	D2 [mm]	L [mm]	PCS ROBE	
YT-1340	3/4" (19.0 mm)	36	22	100	6	36
YT-1341	3/4" (19.0 mm)	36	22	200	5	20
YT-1342	3/4" (19.0 mm)	36	22	400	5	10

- EN Adapter
- PL Redukcja
- DE Reduktion
- RU Переходник
- CZ Redukce
- HU Redukció
- RO Reducție
- FR Réduction
- IT Riduttore
- ES Reducción
- CN 转换头

3/4"
19mm **DIN 3121** **CrV 50BV30**

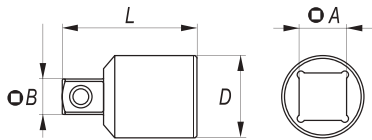

YATO	Ø A	Ø B	D [mm]	L [mm]	PCS ROBE	
YT-1355	3/4" (19.0 mm) (F)	1/2" (12.7 mm) (M)	36	53	12	48

- EN Universal joint
- PL Przegub Cardana
- DE Kardangelen
- RU Карданный шарнир
- CZ Kardanový kloub
- HU Kardán csukló
- RO Articulație Cardanică
- FR Cardan
- IT Snodo cardanico
- ES Articulación Cardan
- CN 万向接头

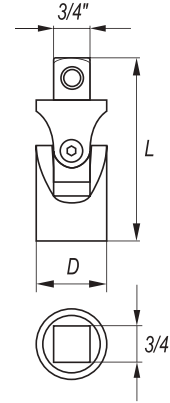

3/4"
19mm **DIN 3121** **CrV 50BV30**

YATO	Ø	D [mm]	L [mm]	PCS ROBE	
YT-1352	3/4" (19.0 mm)	40	106	12	36

- EN Sliding T-bar
- PL Pokrętko typu „T”
- DE Handgriff mit Gleitstück

- RU Вороток Т-образный
- CZ Otočná račka typ „T”
- HU „T” alakú hajtókar

- RO Antrenor culisabil tip „T”
- FR Barre type „T”
- IT Manopola „T” scorrevole

- ES Mango tipo „T”
- CN 滑杆

3/4"
19mm **DIN 3121** **CrV 50BV30**

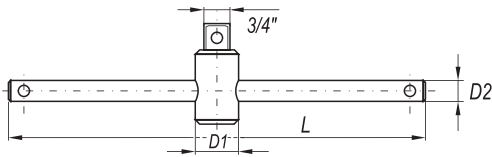

YATO	Ø	D1 [mm]	D2 [mm]	L [mm]	PCS ROBE	
YT-1350	3/4" (19.0 mm)	37	20	500	5	10

- EN Flexible handle
- PL Pokrętko lamane
- DE Gelenkgriff

- RU Вороток шарнирный
- CZ Otočná lomená ráčka
- HU Hajlított hajtókar

- RO Antrenor drept cu prindere flexibilă
- FR Barre pivotante
- IT Manopola a snodo

- ES Mango articulado
- CN 转向手柄

3/4"
19mm **DIN 3121** **CrV 50BV30**

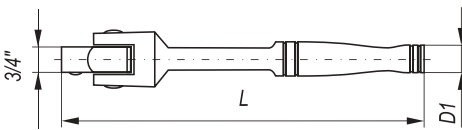

YATO	Ø	D [mm]	L [mm]	PCS ROBE	
YT-1345	3/4" (19.0 mm)	25	507	5	10

- EN L-type handle
- PL Pokrętko typu „L”
- DE Admutternschlüssel
- RU Вороток тип „L”
- CZ Páka zahnutá
- HU „L” alakú hajtókar

- RO Antrenor tip „L”
- FR Barre type „L”
- IT Leva tipo „L”
- ES Mango tipo „L”
- CN L型扳手

3/4"
19mm **DIN 3121** **CrV 50BV30**

- EN L-type handle
- PL Pokrętko typu „L”
- DE Admutternschlüssel
- RU Вороток тип „L”
- CZ Páka zahnutá
- HU „L” alakú hajtókar

- RO Antrenor tip „L”
- FR Barre type „L”
- IT Leva tipo „L”
- ES Mango tipo „L”
- CN L型扳手

3/4"
19mm **DIN 3122** **CrV 50BV30**

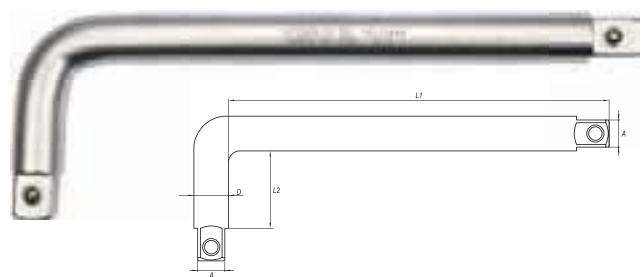
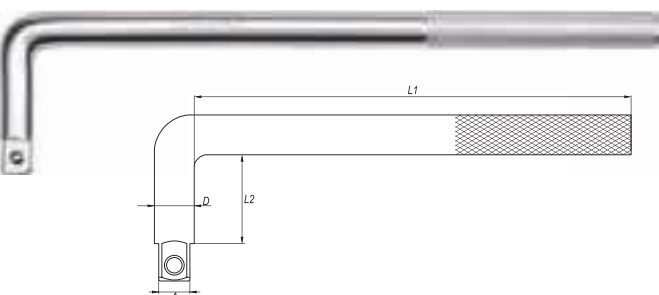



YATO	Ø	D [mm]	L1 [mm]	L2 [mm]	PCS ROBE	
YT-1347	3/4" (19.0 mm)	25	360	75	5	10
YT-1348	3/4" (19.0 mm)	25	410	75	5	10

YATO	Ø	D [mm]	L1 [mm]	L2 [mm]	PCS ROBE	
YT-13465	3/4" (19.0 mm)	25	300	100	2/12	
YT-13475	3/4" (19.0 mm)	25	400	100	2/8	
YT-13490	3/4" (19.0 mm)	25	600	100	2/8	

- EN Quick release ratchet handle
- PL Grzechotka
- DE Hebelumschaltknarre
- RU Трещотка
- CZ Ráčna
- HU Racsnis hajtókar
- RO Antrenor cu clichet
- FR Clé à cliquet
- IT Chiave a cricchetto
- ES Llave de carraca
- CN 快速脱落棘轮扳手







3/4" 19mm	DIN 3122	QUICK RELEASE SZYBKO-ZŁĄCZE
24T	CrV 6140	



YATO 	Ø	T	L [mm]	
YT-1360	3/4" (19.0 mm)	24	615	10

- EN Tool set
- PL Zestaw narzędziowy
- DE Werkzeug-Satz
- RU Набор инструментов
- CZ Sada nářadí
- HU Szerszámkészlet
- RO Trusa de scule
- FR Jeu d'outils
- IT Set di utensili
- ES Juego de herramientas
- CN 工具组套



15 PCS	3/4" 19mm
CrV 50BV30	CrV 6140
QUICK RELEASE SZYBKO-ZŁĄCZE	24T
AS-DRIVE	





-  3/4" (19.0 mm); 30, 32, 34 (L=55 mm); 36, 38 (L=60 mm); 41 (L=65 mm); 46, 50 (L=70 mm); 55 (L=75 mm); 60 mm (L=80 mm); CrV 50BV30;
-  3/4" (19.0 mm); (L=100, 200 mm); CrV 50BV30;
-  3/4" (19.0 mm); (L=106 mm); CrV 50BV30;
-  3/4" (19.0 mm); (L=500 mm); CrV 50BV30;
-  3/4" (19.0 mm); (L=500 mm); 24T; CrV 6140



YATO 	Ø	
YT-1334	3/4" (19.0 mm)	1

- EN Tool set
- PL Zestaw narzędziowy
- DE Werkzeug-Satz
- RU Набор инструментов
- CZ Sada nářadí
- HU Szerszámkészlet
- RO Trusa de scule
- FR Jeu d'outils
- IT Set di utensili
- ES Juego de herramientas
- CN 工具组套



20 PCS	3/4" 19mm
CrV 50BV30	CrV 6140
QUICK RELEASE SZYBKO-ZŁĄCZE	24T
AS-DRIVE	





-  3/4" (19.0 mm); 19, 21, 22, 24 mm (L=50 mm); 26, 27, 28 mm (L=52 mm); 30, 32 mm (L=53 mm); 33, 34 mm (L=56 mm); 36 mm (L=58 mm); 38 mm (L=60 mm); 41 mm (L=64 mm); 46 mm (L=68 mm); 50 mm (L=72mm); CrV 50BV30;
-  3/4" (19.0 mm); (L=100, 200 mm); CrV 50BV30;
-  3/4" (19.0 mm); (L=500 mm); CrV 50BV30;
-  3/4" (19.0 mm); (L=620 mm); CrV 6140



YATO 	Ø	
YT-1335	3/4" (19.0 mm)	1

- EN Tool set
- PL Zestaw narzędziowy
- DE Werkzeug-Satz
- RU Набор инструмента
- CZ Sada nářadí
- HU Szerszámkészlet
- RO Trusa de scule
- FR Jeu d'outils
- IT Set di utensili
- ES Juego de herramientas
- CN 工具组套



21 PCS	3/4" 19mm
CrV 50BV30	24T
AS-DRIVE	

-  3/4" (19.0 mm); 19, 21, 22, 23, 24, 26, 27, 29, 30, 32, 35, 36, 38, 41, 46, 50 mm; CrV 50BV30;
-  3/4" (19.0 mm); (L=100, 200, 400 mm); CrV 50BV30;
-  3/4" (19.0 mm); (L=450 mm); CrV 50BV30;
-  3/4" (19.0 mm); (L=500 mm); 24T; CrV

YATO 	Ø	
YT-13351	3/4" (19.0 mm)	1

EN Bit socket
 PL Klucz trzpieniowy
 DE Bit-Stecknuss
 RU Головка торцевая с вставкой
 CZ Hlavice s bitem
 HU Csapkulcs
 RO Bit cu adaptor
 FR Douille tournevis
 IT Chiavi a bussola a giravite
 ES Llave de mandril
 CN 星型旋具套筒

1/4"
6.3mm

AISI S2 **CrV 6150**

HRC 58-62 **DIN 3120**



EN Bit socket
 PL Klucz trzpieniowy
 DE Bit-Stecknuss
 RU Головка торцевая с вставкой
 CZ Hlavice s bitem
 HU Csapkulcs
 RO Bit cu adaptor
 FR Douille tournevis
 IT Chiavi a bussola a giravite
 ES Llave de mandril
 CN 六角旋具套筒

1/4"
6.3mm

AISI S2 **CrV 6150**

HRC 58-62 **DIN 3120**



YATO	⌀	⊕	L [mm]	[Nm]	
YT-04301	1/4" (6.3 mm)	T8	37	2.6	150/600
YT-04302	1/4" (6.3 mm)	T10	37	4.6	150/600
YT-04303	1/4" (6.3 mm)	T15	37	7.7	150/600
YT-04304	1/4" (6.3 mm)	T20	37	12.7	150/600
YT-04305	1/4" (6.3 mm)	T25	37	19.0	150/600
YT-04306	1/4" (6.3 mm)	T30	37	37.4	150/600
YT-04307	1/4" (6.3 mm)	T40	37	65.0	150/600

YATO	⌀	⊙ [mm]	L [mm]	[Nm]	
YT-04370	1/4" (6.3 mm)	3	37	6.6	150/600
YT-04371	1/4" (6.3 mm)	4	37	16.0	150/600
YT-04372	1/4" (6.3 mm)	5	37	30.0	150/600
YT-04373	1/4" (6.3 mm)	6	37	52.2	150/600
YT-04374	1/4" (6.3 mm)	7	37	78.0	150/600
YT-04375	1/4" (6.3 mm)	8	37	120.0	150/600

EN Bit socket
 PL Klucz trzpieniowy
 DE Bit-Stecknuss
 RU Головка торцевая с вставкой
 CZ Hlavice s bitem
 HU Csapkulcs
 RO Bit cu adaptor
 FR Douille tournevis
 IT Chiavi a bussola a giravite
 ES Llave de mandril
 CN 十字旋具套筒

1/4"
6.3mm

AISI S2 **CrV 6150**

HRC 58-62 **DIN 3120**



EN Bit socket
 PL Klucz trzpieniowy
 DE Bit-Stecknuss
 RU Головка торцевая с вставкой
 CZ Hlavice s bitem
 HU Csapkulcs
 RO Bit cu adaptor
 FR Douille tournevis
 IT Chiavi a bussola a giravite
 ES Llave de mandril
 CN 十字旋具套筒

1/4"
6.3mm

AISI S2 **CrV 6150**

HRC 58-62 **DIN 3120**



YATO	⌀	⊕	L [mm]	[Nm]	
YT-04411	1/4" (6.3 mm)	PH1	37	3.5	150/600
YT-04412	1/4" (6.3 mm)	PH2	37	8.2	150/600
YT-04413	1/4" (6.3 mm)	PH3	37	19.5	150/600

YATO	⌀	⊕	L [mm]	[Nm]	
YT-04417	1/4" (6.3 mm)	PZ1	37	3.5	150/600
YT-04418	1/4" (6.3 mm)	PZ2	37	8.2	150/600

EN Bit socket
PL Klucz trzpieniowy
DE Bit-Stecknuss
RU Головка торцевая с вставкой
CZ Hlavice s bitem
HU Csapkulcs
RO Bit cu adaptor
FR Douille tournevis
IT Chiavi a bussola a giravite
ES Llave de mandril
CN 六角旋具套筒



YATO	Ø	◎ [mm]	L [mm]	[Nm]	☒
YT-04381	1/2" (12.7 mm)	5	55	30	40/240
YT-04382	1/2" (12.7 mm)	6	55	52	40/240
YT-04383	1/2" (12.7 mm)	7	55	78	40/240
YT-04384	1/2" (12.7 mm)	8	55	120	40/240
YT-04385	1/2" (12.7 mm)	10	55	220	40/160
YT-04386	1/2" (12.7 mm)	12	55	370	40/160
YT-04387	1/2" (12.7 mm)	14	55	590	40/160
YT-04388	1/2" (12.7 mm)	17	55	1000	40/160

EN Bit socket
PL Klucz trzpieniowy
DE Bit-Stecknuss
RU Головка торцевая с вставкой
CZ Hlavice s bitem
HU Csapkulcs
RO Bit cu adaptor
FR Douille tournevis
IT Chiavi a bussola a giravite
ES Llave de mandril
CN 十二角旋具套筒



YATO	Ø	◎	L [mm]	[Nm]	☒
YT-04341	1/2" (12.7 mm)	M6	55	30	40/240
YT-04342	1/2" (12.7 mm)	M8	55	52	40/240
YT-04343	1/2" (12.7 mm)	M10	55	120	40/160
YT-04344	1/2" (12.7 mm)	M12	55	220	40/160
YT-04345	1/2" (12.7 mm)	M14	55	370	40/160
YT-04346	1/2" (12.7 mm)	M16	55	590	40/160

EN Bit socket
PL Klucz trzpieniowy
DE Bit-Stecknuss
RU Головка торцевая с вставкой
CZ Hlavice s bitem
HU Csapkulcs
RO Bit cu adaptor
FR Douille tournevis
IT Chiavi a bussola a giravite
ES Llave de mandril
CN 星型旋具套筒



YATO	Ø	◎	L [mm]	[Nm]	☒
YT-04310	1/2" (12.7 mm)	T20	55	12.7	40/240
YT-04311	1/2" (12.7 mm)	T25	55	19.0	40/240
YT-04312	1/2" (12.7 mm)	T27	55	27.0	40/240
YT-04313	1/2" (12.7 mm)	T30	55	37.4	40/240
YT-04314	1/2" (12.7 mm)	T40	55	65.0	40/240
YT-04315	1/2" (12.7 mm)	T45	55	103.5	40/240
YT-04316	1/2" (12.7 mm)	T50	55	159.0	40/240
YT-04317	1/2" (12.7 mm)	T55	55	257.0	40/240
YT-04318	1/2" (12.7 mm)	T60	55	445.0	40/160
YT-04319	1/2" (12.7 mm)	T70	55	700.0	40/160

EN Bit socket
PL Klucz trzpieniowy
DE Bit-Stecknuss
RU Головка торцевая с вставкой
CZ Hlavice s bitem
HU Csapkulcs
RO Bit cu adaptor
FR Douille tournevis
IT Chiavi a bussola a giravite
ES Llave de mandril
CN 六角旋具套筒

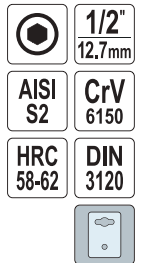

YATO	Ø	◎ [mm]	L [mm]	[Nm]	☒
YT-04390	1/2" (12.7 mm)	4	100	16	20/120
YT-04391	1/2" (12.7 mm)	5	100	30	20/120
YT-04392	1/2" (12.7 mm)	6	100	52	20/120
YT-04393	1/2" (12.7 mm)	7	100	78	20/120
YT-04394	1/2" (12.7 mm)	8	100	120	20/120
YT-04395	1/2" (12.7 mm)	10	100	220	20/120
YT-04396	1/2" (12.7 mm)	12	100	370	20/120
YT-04397	1/2" (12.7 mm)	14	100	590	20/120
YT-04398	1/2" (12.7 mm)	17	100	1000	20/120

EN Bit socket
 PL Klucz trzpieniowy
 DE Bit-Stecknuss
 RU Головка торцевая с вставкой
 CZ Hlavice s bitem
 HU Csapkulcs
 RO Bit cu adaptor
 FR Douille tournevis
 IT Chiavi a bussola a giravite
 ES Llave de mandril
 CN 星型旋具套筒

1/2" 12.7mm
 AISI S2
 CrV 6150
 HRC 58-62
 DIN 3120



EN Bit socket
 PL Klucz trzpieniowy
 DE Bit-Stecknuss
 RU Головка торцевая с вставкой
 CZ Hlavice s bitem
 HU Csapkulcs
 RO Bit cu adaptor
 FR Douille tournevis
 IT Chiavi a bussola a giravite
 ES Llave de mandril
 CN 十二角旋具套筒

1/2" 12.7mm
 AISI S2
 CrV 6150
 HRC 58-62
 DIN 3120



YATO	Ø	⊙	L [mm]	[Nm]	
YT-04320	1/2" (12.7 mm)	T20	100	12.7	20/120
YT-04321	1/2" (12.7 mm)	T25	100	19.0	20/120
YT-04322	1/2" (12.7 mm)	T27	100	27.0	20/120
YT-04323	1/2" (12.7 mm)	T30	100	37.4	20/120
YT-04324	1/2" (12.7 mm)	T40	100	65.0	20/120
YT-04325	1/2" (12.7 mm)	T45	100	103.5	20/120
YT-04326	1/2" (12.7 mm)	T50	100	159.0	20/120
YT-04327	1/2" (12.7 mm)	T55	100	257.0	20/120
YT-04328	1/2" (12.7 mm)	T60	100	445.0	20/120
YT-04329	1/2" (12.7 mm)	T70	100	700.0	20/120

YATO	Ø	⊙	L [mm]	[Nm]	
YT-04350	1/2" (12.7 mm)	M5	100	16	20/120
YT-04351	1/2" (12.7 mm)	M6	100	30	20/120
YT-04352	1/2" (12.7 mm)	M8	100	52	20/120
YT-04353	1/2" (12.7 mm)	M10	100	120	20/120
YT-04354	1/2" (12.7 mm)	M12	100	220	20/120
YT-04355	1/2" (12.7 mm)	M14	100	370	20/120
YT-04356	1/2" (12.7 mm)	M16	100	590	20/120
YT-04357	1/2" (12.7 mm)	M17	100	590	20/120

EN Key wrench ratchet handle
 PL Grzechotka Hex
 DE Ratsche Hex
 RU Трещотка Hex
 CZ Ráčna Hex
 HU Racsnis Hex
 RO Cheie hexagonală cu clichet
 FR Clé à cliquet Hex
 IT Cricchetto Hex
 ES Carraca Hex
 CN 双向棘轮内六角扳手

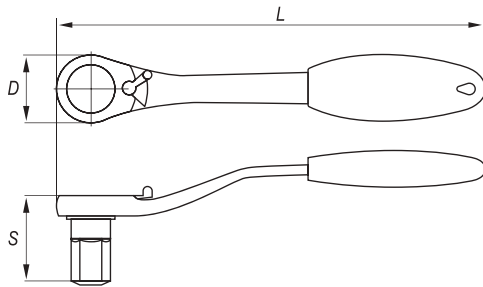

72T
 HRC 42-48
 CrV 50BV30

YATO	Ø [mm]	L [mm]	D [mm]	S [mm]	
YT-02390	4	135	18	29	8/160
YT-02391	5	135	18	29	8/160
YT-02392	6	145	23	32	6/120
YT-02394	10	190	31	35	6/60
YT-02395	12	190	31	35	6/60
YT-02396	14	225	36	36	5/40
YT-02397	17	225	36	36	5/40

EN Universal socket wrench
 PL Klucz z uniwersalną nasadką
 DE Universal-Steckschlüssel
 RU Универсальная торцевая головка с трещоткой
 CZ Univerzální klíč
 HU Univerzális csavar kulcs
 RO Antrenor cu clichet cu tubulara universala
 FR Clé à douille universelle
 IT Chiave con presa universale
 ES Llave de tubo universal
 CN 双向棘轮万能扳手

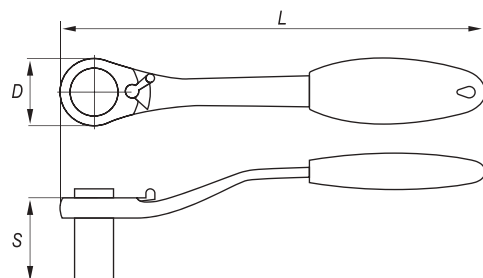

72T
 HRC 40
 CrV 50BV30



YATO	Ø [mm]	L [mm]	D [mm]	S [mm]	
YT-02400	8-19	225	36	54	5/40

EN Bit sockets
PL Klucze trzpieniowe
DE Bit-Stecknuss-Set
RU Набор головок со вставкой
CZ Sada nástrčných hlavíc s bitem
HU Dugókulcs készlet
RO Trusă biți cu adaptor
FR Douille tournevis
IT Serie di chiavi a bussola a giravite
ES Juego de llaves de mandril
CN 中孔星型旋具套筒组套

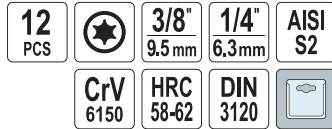

⊗ 1/4" (6.3 mm): T8, T10, T15, T20, T25, T27, T30 (L=37 mm);
⊗ 3/8" (9.5 mm): T40, T45, T47, T50, T55 (L=48 mm)

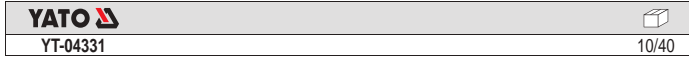
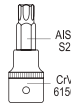

EN Bit sockets
PL Klucze trzpieniowe
DE Bit-Stecknuss-Set
RU Набор головок со вставкой
CZ Sada nástrčných hlavíc s bitem
HU Dugókulcs készlet
RO Trusă biți cu adaptor
FR Douille tournevis
IT Serie di chiavi a bussola a giravite
ES Juego de llaves de mandril
CN 中孔星型旋具套筒组套

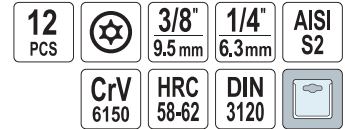

⊗ 1/4" (6.3 mm): T8, T10, T15, T20, T25, T27, T30 (L=37 mm);
⊗ 3/8" (9.5 mm): T40, T45, T47, T50, T55 (L=48 mm)

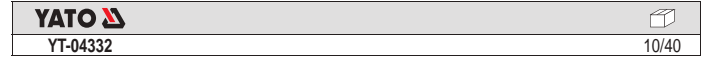
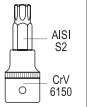

EN Bit sockets
PL Klucze trzpieniowe
DE Bit-Stecknuss-Set
RU Набор головок со вставкой
CZ Sada nástrčných hlavíc s bitem
HU Dugókulcs készlet
RO Trusă biți cu adaptor
FR Douille tournevis
IT Serie di chiavi a bussola a giravite
ES Juego de llaves de mandril
CN 中孔星型旋具套筒组套

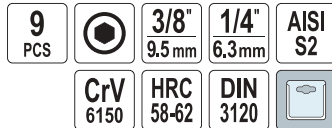

○ 1/4" (6.3 mm): 2, 3, 4, 5, 6 mm (L=37 mm);
○ 3/8" (9.5 mm): 7, 8, 10, 12 mm (L=48 mm)

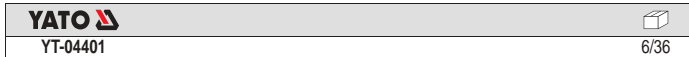
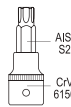

EN Bit sockets
PL Klucze trzpieniowe
DE Bit-Stecknuss-Set
RU Набор головок со вставкой
CZ Sada nástrčných hlavíc s bitem
HU Dugókulcs készlet
RO Trusă biți cu adaptor
FR Douille tournevis
IT Serie di chiavi a bussola a giravite
ES Juego de llaves de mandril
CN 中孔星型旋具套筒组套

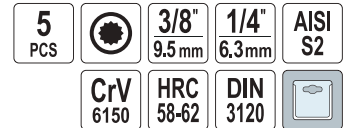

○ 1/4" (6.3 mm): M5, M6 (L=37 mm);
○ 3/8" (9.5 mm): M8, M10, M12 (L=48 mm)

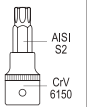

EN Bit sockets
PL Klucze trzpieniowe
DE Bit-Stecknuss-Set
RU Набор головок со вставкой
CZ Sada nástrčných hlavíc s bitem
HU Dugókulcs készlet
RO Trusă biți cu adaptor
FR Douille tournevis
IT Serie di chiavi a bussola a giravite
ES Juego de llaves de mandril
CN 中孔星型旋具套筒组套



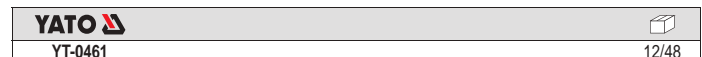
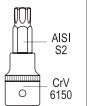

⊗ 1/4" (6.3 mm): T10, T15, T20, T25, T27, T30, T40 (L=35 mm)





- EN Bit socket set
- PL Zestaw kluczy trzpieniowych
- DE Aufsteckschlüssel-Satz
- RU Набор роненок-вставок
- CZ Čepové klíče
- HU Csapkulcs
- RO Trusă biți cu adaptor
- FR Set de douilles tournevis
- IT Chiavi a bussola a vite
- ES Juego de llaves de mandril
- CN 星型套筒批头组套

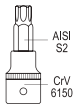

18 PCS		1/2" 12.7mm
1/4" 6.3mm	AISI S2	CrV 6150
DIN 3120	HRC 58-62	





1/2" (12.7 mm): T30, T40, T45, T50, T55, T60 (L=50 mm); T30, T40, T45, T50, T55, T60 (L=100 mm),
1/4" (6.3 mm): T10, T15, T20, T25, T30, T40 (L=37 mm); AISI S2 / CrV 6150



YATO 		
YT-7751	1/4" (6.3 mm), 1/2" (12.7 mm)	10

- EN Bit socket set
- PL Zestaw kluczy trzpieniowych
- DE Aufsteckschlüssel-Satz
- RU Набор роненок-вставок
- CZ Čepové klíče
- HU Csapkulcs
- RO Trusă biți cu adaptor
- FR Set de douilles tournevis
- IT Chiavi a bussola a vite
- ES Juego de llaves de mandril
- CN 批头组套





32 PCS		1/2" 12.7mm
S2	CrV	

1/2" (12.7 mm): T20, T25, T27, T30, T40, T45, T50, T55, T60, T70 (L=55 mm);
1/2" (12.7 mm): T20, T25, T27, T30, T40, T45, T50, T55, T60, T70 (L=100 mm);
1/2" (12.7 mm): T40, T45, T50, T55, T60, T70 (L=140 mm);
1/2" (12.7 mm): T40, T45, T50, T55, T60, T70 (L=200 mm); S2 / CrV

YATO 		
YT-7754	1/2" (12.7 mm)	3



- EN Bit socket set
- PL Zestaw kluczy trzpieniowych
- DE Aufsteckschlüssel-Satz
- RU Набор роненок-вставок
- CZ Čepové klíče
- HU Csapkulcs
- RO Trusă biți cu adaptor
- FR Set de douilles tournevis
- IT Chiavi a bussola a vite
- ES Juego de llaves de mandril
- CN 六角套筒批头组套

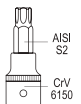

18 PCS		1/2" 12.7mm
1/4" 6.3mm	AISI S2	CrV 6150
DIN 3120	HRC 58-62	



1/2" (12.7 mm): 5, 6, 7, 8, 10, 12 mm (L=50 mm); 5, 6, 7, 8, 10, 12 mm (L=100 mm),
1/4" (6.3 mm): 3, 4, 5, 6, 7, 8 mm (L=37 mm); AISI S2 / CrV 6150

YATO 		
YT-7752	1/4" (6.3 mm), 1/2" (12.7 mm)	10

EN Bit socket set
PL Zestaw kluczy trzpieniowych
DE Aufsteckschlüssel-Satz
RU Набор роловок-вставок
CZ Čepové klíče
HU Csapkulcs
RO Trusă biți cu adaptor
FR Set de douilles tournevis
IT Chiavi a bussola a vite
ES Juego de llaves de mandril
CN 批头组套



30
PCS

1/2"
12.7mm

S2 CrV

1/2" (12.7 mm): 5, 6, 7, 8, 10, 12, 14, 17, 19 mm (L=55 mm);
1/2" (12.7 mm): 5, 6, 7, 8, 10, 11, 12, 13 mm (L=100 mm);
1/2" (12.7 mm): 5, 6, 7, 8, 10, 12, 14 mm (L=140 mm);
1/2" (12.7 mm): 5, 6, 7, 8, 10, 12 mm (L=200 mm); S2 / CrV

YATO	○	
YT-77540	1/2" (12.7 mm)	3

EN Bit socket set
PL Zestaw kluczy trzpieniowych
DE Aufsteckschlüssel-Satz
RU Набор роловок-вставок
CZ Čepové klíče
HU Csapkulcs
RO Trusă biți cu adaptor
FR Set de douilles tournevis
IT Chiavi a bussola a vite
ES Juego de llaves de mandril
CN 花型套筒批头组套



12
PCS

1/2"
12.7mm

AISI S2 CrV 6150 DIN 3120

HRC 58-62

1/2" (12.7 mm): M12, M17 (L=50 mm); M6 (L=70 mm); M7, M8 (L=100 mm);
M8, M10 (L=120 mm); M6, M10, M12 (L=140 mm); M5 (L=180 mm); M6 (L=250 mm); AISI S2 / CrV 6150

YATO	○	
YT-7753	1/2" (12.7 mm)	10

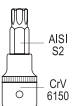

EN Bit socket set
PL Zestaw kluczy trzpieniowych
DE Aufsteckschlüssel-Satz
RU Набор роловок-вставок
CZ Čepové klíče
HU Csapkulcs
RO Trusă biți cu adaptor
FR Set de douilles tournevis
IT Chiavi a bussola a vite
ES Juego de llaves de mandril
CN 批头组套



26
PCS

1/2"
12.7mm

S2 CrV











1/2" (12.7 mm): M5, M6, M8, M9, M10, M12, M14, M16 (L=55 mm);
1/2" (12.7 mm): M5, M6, M8, M9, M10, M12, M14 (L=100 mm);
1/2" (12.7 mm): M5, M6, M8, M9, M10, M12, M14 (L=140 mm);
1/2" (12.7 mm): M6, M10, M12, M14 (L=200 mm); S2 / CrV

YATO	○	
YT-77542	1/2" (12.7 mm)	3

3

Impact sockets,
accessories & sets
Udarowe klucze nasadowe,
akcesoria i zestawy



Impact accessories 1/4" Akcesoria udarowe 1/4"		64	Impact accessories 3/4" Akcesoria udarowe 3/4"		67
Impact universal joints Przeguby kuliste udarowe		64	Impact extension bars Przedłużki udarowe		67
Impact accessories 3/8" Akcesoria udarowe 3/8"		64	Impact adapters Redukcje udarowe		67
Impact universal joints Przeguby kuliste udarowe		64	Impact universal joints Przeguby kuliste udarowe		67
Impact sockets 1/2" Klucze nasadowe udarowe 1/2"		64-65	Impact sockets 1" Udarowe klucze nasadowe 1"		68
Impact sockets & sets Klucze nasadowe udarowe i zestawy, krótkie		64	Impact sockets Klucze nasadowe udarowe, krótkie		68
Deep impact sockets & sets Klucze nasadowe udarowe i zestawy, długie		65	Deep impact sockets Klucze nasadowe udarowe, długie		68
Impact accessories 1/2" Akcesoria udarowe 1/2"		65-66	Impact accessories 1" Akcesoria udarowe 1"		68
Impact extension bars Przedłużki udarowe		65	Impact extension bars with adapter Przedłużki udarowe z redukcją		68
Impact adapters Redukcje udarowe		65	Impact universal joints Przeguby kuliste udarowe		68
Impact universal joints Przeguby kuliste udarowe		66	Impact accessories sets Zestawy akcesoriów udarowych		68-69
Impact sockets 3/4" Udarowe klucze nasadowe 3/4"		66-67	Impact sockets for front hub nuts Nasadki udarowe do piast		69
Impact sockets & sets Klucze nasadowe udarowe i zestawy, krótkie		66	Impact bit sets & accessories Zestawy bitów udarowych i akcesoria		69-71
Deep impact sockets & sets Klucze nasadowe udarowe i zestawy, długie		66			

- EN Impact universal joint
- PL Przegub kulisty udarowy
- DE Kraft-Kugelgelenk
- RU Ударный шаровой шарнир
- CZ Kulový rázový kloub
- HU Csuklós csatlakozó gépi
- RO Articulație universală de impact
- FR Joint universel à impact
- IT Giunto universale a impatto
- ES Articulación universal de impacto
- CN 风动万向接头

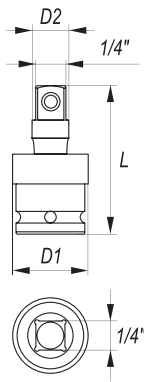

1/4"
6.3mm
CrMo
SCM440
FOR IMPACT TOOLS
DO NARZĘDZI UDAROWYCH

- EN Impact universal joint
- PL Przegub kulisty udarowy
- DE Kraft-Kugelgelenk
- RU Ударный шаровой шарнир
- CZ Kulový rázový kloub
- HU Csuklós csatlakozó gépi
- RO Articulație universală de impact
- FR Joint universel à impact
- IT Giunto universale a impatto
- ES Articulación universal de impacto
- CN 风动万向接头

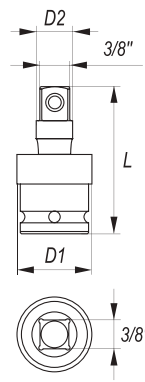

3/8"
9.5mm
CrMo
SCM440
FOR IMPACT TOOLS
DO NARZĘDZI UDAROWYCH

YATO	Ø	D1 [mm]	D2 [mm]	L [mm]	PCS
YT-10630	1/4" (6.3 mm)	17	8.3	34.5	20/100

YATO	Ø	D1 [mm]	D2 [mm]	L [mm]	PCS
YT-10632	3/8" (9.5 mm)	24.6	12.8	48	20/100

- EN Hexagonal impact socket
- PL Nasadka udarowa sześciokątna
- DE Kraftschrauber-Einsatz
- RU Головка ударная 6-гранная
- CZ Šestihranný nástavec
- HU Gépi dugókulcs hatszög
- RO Cheie tubulară hexagonală de impact
- FR Douille à choc
- IT Chiave a bussola esagonale per percussione
- ES Boquilla de percusión
- CN 风动套筒

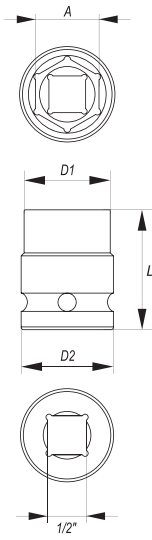

1/2"
12.7mm
CrMo
SCM440
AS-DRIVE

YATO	Ø A [mm]	D1 [mm]	D2 [mm]	L [mm]	PCS	PCS
YT-1000	10	17.5	25	39	60	240
YT-1001	11	18.5	25	39	60	240
YT-1002	12	20.0	25	39	60	240
YT-1003	13	21.0	25	39	60	240
YT-1004	14	22.5	25	39	60	240
YT-1005	15	23.5	30	39	40	160
YT-1006	16	24.0	30	39	40	160
YT-1007	17	26.0	30	39	40	160
YT-1008	18	27.5	30	39	40	160
YT-1009	19	28.0	30	39	40	160
YT-1010	20	30.0	30	39	40	160
YT-1011	21	30.0	30	39	40	160
YT-1012	22	32.0	30	39	30	120
YT-1013	23	32.0	30	39	30	120
YT-1014	24	34.0	30	43	30	120
YT-1015	25	35.0	30	43	30	120
YT-1016	26	38.0	30	43	24	96
YT-1017	27	38.0	30	43	24	96
YT-1018	28	40.0	30	48	24	96
YT-1019	29	41.0	30	48	22	88
YT-1020	30	42.0	30	48	24	96
YT-1022	32	44.0	30	48	20	80

- EN Impact socket set
- PL Zestaw nasadek udarowych
- DE Kraftschrauber-Einsätze
- RU Набор торцевых ударных головок
- CZ Sada úderových nástrčných hlavic
- HU Gépi dugókulcs készlet
- RO Set chei tubulare pt. impact
- FR Jeu de douilles à choc
- IT Set di chiavi a bussola a percussione
- ES Juego de vasos de impacto
- CN 风动套筒组套



10
PCS
1/2"
12.7mm
CrMo
SCM440
AS-DRIVE

1/2" (12.7 mm): 10, 12, 13, 14, 15, 16, 17, 18, 19, 22 mm (L=39 mm)

YATO	Ø	PCS
YT-1025	1/2" (12.7 mm)	20

- EN Impact socket set
- PL Zestaw nasadek udarowych
- DE Kraftschrauber-Einsätze
- RU Набор торцевых ударных головок
- CZ Sada úderových nástrčných hlavic
- HU Gépi dugókulcs készlet
- RO Set chei tubulare pt. impact
- FR Jeu de douilles à choc
- IT Set di chiavi a bussola a percussione
- ES Juego de vasos de impacto
- CN 风动套筒组套



13
PCS
1/2"
12.7mm
CrMo
AS-DRIVE

1/2" (12.7 mm): 10, 11, 12, 13, 14, 15, 16, 17, 18, 19, 21, 22, 24 mm (L=38 mm); CrMo

YATO	Ø	PCS
YT-10251	1/2" (12.7 mm)	10

- EN Hexagonal deep impact socket
PL Nasadka udarowa sześciokątna długa
DE Kraftschrauber-Einsatz, lang
RU Головка ударная 6-гранная глубокая
CZ Šestihranný hluboký nástavec
HU Gépi dugókulcs hatszög hosszú
- RO Cheie tubulară hexagonală de impact adâncă
FR Douille profonde à choc
IT Chiave a bussola esagonale per percussione
ES Boquilla de percusión profunda
CN 风动套筒



YATO	∅ A [mm]	D1 [mm]	D2 [mm]	L [mm]	PCS POZICE	
YT-1030	10	17.5	24	78	30	120
YT-1031	11	18.5	24	78	30	120
YT-1032	12	20.0	24	78	30	120
YT-1033	13	21.0	24	78	30	120
YT-1034	14	22.0	24	78	30	120
YT-1035	15	23.7	24	78	30	120
YT-1036	16	24.0	24	78	30	120
YT-1037	17	26.0	26	78	25	100
YT-1038	18	28.0	28	78	24	96
YT-1039	19	28.0	28	78	24	96
YT-1040	20	30.0	30	78	20	80
YT-1041	21	30.0	30	78	20	80
YT-1042	22	32.0	30	78	18	72
YT-1043	23	32.0	30	78	15	60
YT-1044	24	34.0	30	78	15	60
YT-1045	25	35.0	30	78	15	60
YT-1046	26	38.0	30	78	12	48
YT-1047	27	38.0	30	78	12	48
YT-1048	28	40.0	30	78	12	48
YT-1049	29	41.0	30	78	10	40
YT-1050	30	42.0	30	78	10	40
YT-1052	32	44.0	30	78	10	40

- EN Impact socket set
PL Zestaw nasadek udarowych
DE Kraftschrauber-Einsätze
RU Набор торцевых ударных головок
CZ Sada úderových nástrčných hlavic
HU Gépi dugókulcs készlet
RO Set chei tubulare pt. impact
FR Jeu de douilles à choc
IT Set di chiavi a bussola a percussione
ES Juego de vasos de impacto
CN 风动套筒组套

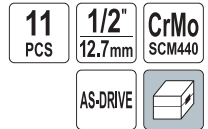

1/2" (12.7 mm): 10, 12, 13, 14, 15, 16, 17, 18, 19, 22, 24 mm (L=78 mm)

YATO	∅	
YT-1054	1/2" (12.7 mm)	10

- EN Impact socket set
PL Zestaw nasadek udarowych
DE Kraftschrauber-Einsätze
RU Набор торцевых ударных головок
CZ Sada úderových nástrčných hlavic
HU Gépi dugókulcs készlet
RO Set chei tubulare pt. impact
FR Jeu de douilles à choc
IT Set di chiavi a bussola a percussione
ES Juego de vasos de impacto
CN 风动套筒组套

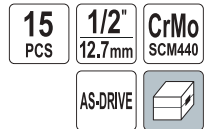

1/2" (12.7 mm): 10, 12, 13, 14, 15, 16, 17, 18, 19, 21, 22, 24, 27, 30, 32 mm (L=78 mm)

YATO	∅	
YT-1055	1/2" (12.7 mm)	4

- EN Impact extension bar
PL Przedłużka udarowa
DE Verlängerung
RU Удлинитель ударный
CZ Prodlužovací přípravek
HU Toldalék
RO Prelungitor
FR Rallonge
IT Prolunga per percussione
ES Tubo de prolongación
CN 风动接杆

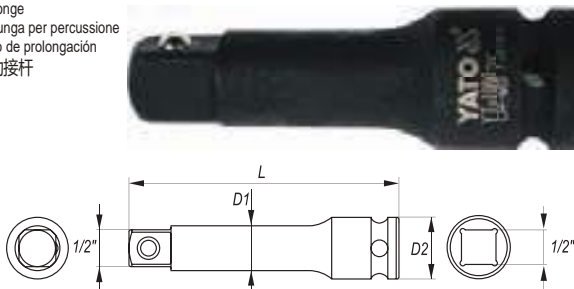

YATO	∅	D1 [mm]	D2 [mm]	L [mm]	PCS POZICE	
YT-1060	1/2" (12.7 mm)	17.5	25	75	40	160
YT-1061	1/2" (12.7 mm)	18.5	25	125	28	112
YT-1062	1/2" (12.7 mm)	20.0	25	250	30	60

- EN Impact adapter
PL Redukcja udarowa
DE Reduktion
RU Переходник
CZ Redukce
HU Redukció
RO Reducție
FR Réduction
IT Prolunga per percussione
ES Reducción
CN 风动转换头

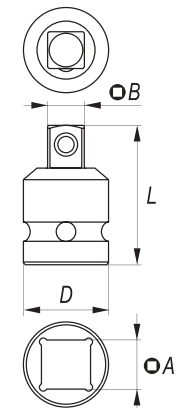

YATO	∅	∅	D [mm]	L [mm]	PCS POZICE	
YT-1067	1/2" (12.7 mm) (F)	3/4" (19.0 mm) (M)	30	48	40	160

EN Impact universal joint
 PL Przegub kulisty udarowy
 DE Kraft-Kugelgelenk
 RU Ударный шаровой шарнир
 CZ Kulový rázový kloub
 HU Csuiklós csatlakozó gépi
 RO Articulație universală de impact
 FR Joint universel à impact
 IT Giunto universale a impatto
 ES Articulación universal de impacto
 CN 风动万向接头

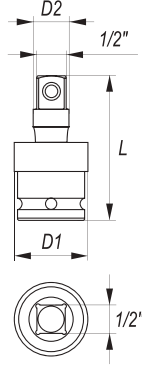

1/2"
12.7mm
CrMo
SCM440

EN Impact universal joint
 PL Przegub kulisty udarowy
 DE Kraft-Kugelgelenk
 RU Ударный шаровой шарнир
 CZ Kulový rázový kloub
 HU Csuiklós csatlakozó gépi
 RO Articulație universală de impact
 FR Joint universel à impact
 IT Giunto universale a impatto
 ES Articulación universal de impacto
 CN 风动万向接头

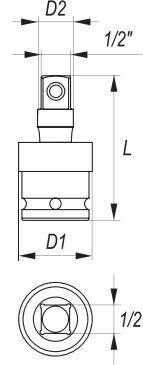

1/2"
12.7mm
CrMo
SCM440
FOR IMPACT TOOLS
DO NARZĘDZI
UDAROWYCH

YATO	Ø	D1 [mm]	D2 [mm]	L [mm]	PCS PIECES	
YT-1064	1/2" (12.7 mm)	31	17	63	25	100

YATO	Ø	D1 [mm]	D2 [mm]	L [mm]	PCS PIECES	
YT-10640	1/2" (12.7 mm)	31.2	16.7	63	10/100	

EN Hexagonal impact socket
 PL Nasadka udarowa sześciokątna
 DE Kraftschrauber-Einsatz
 RU Головка ударная 6-гранная
 CZ Šestihranný nástavec
 HU Gépi dugókulcs hatszög

RO Cheie tubulară hexagonală de impact
 FR Douille à choc
 IT Chiave a bussola esagonale per percussione
 ES Boquilla de percusión
 CN 风动套筒

3/4"
19mm
CrMo
SCM440
AS-DRIVE

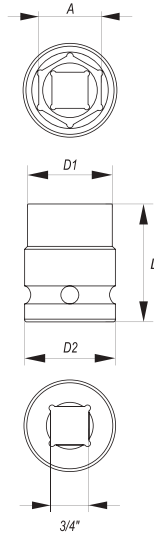

EN Hexagonal deep impact socket
 PL Nasadka udarowa sześciokątna długa
 DE Kraftschrauber-Einsatz, lang
 RU Головка ударная 6-гранная глубокая
 CZ Šestihranný hluboký nástavec
 HU Gépi dugókulcs hatszög hosszú

RO Cheie tubulară hexagonală de impact adâncă
 FR Douille profonde à choc
 IT Chiave a bussola esagonale per percussione
 ES Boquilla de percusión profunda
 CN 风动长套筒

3/4"
19mm
CrMo
SCM440
AS-DRIVE

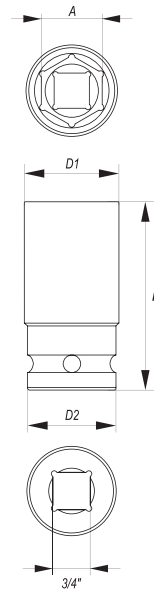

YATO	Ø A [mm]	D1 [mm]	D2 [mm]	L [mm]	PCS PIECES	
YT-1070	19	32	40	50	16	64
YT-1071	21	35	40	50	16	64
YT-1072	22	38	40	50	16	64
YT-1073	23	38	40	50	16	64
YT-1074	24	40	40	50	16	64
YT-1075	25	40	40	50	16	64
YT-1076	26	40	40	50	16	64
YT-1077	27	42	42	53	16	64
YT-1078	28	44	44	53	16	64
YT-1079	29	46	44	53	12	48
YT-1080	30	46	44	53	12	48
YT-1082	32	48	44	56	12	48
YT-1083	33	48	44	56	8	32
YT-1084	34	50	44	56	8	32
YT-1085	35	50	44	56	6	24
YT-1086	36	52	44	56	6	24
YT-1088	38	56	44	57	6	24
YT-1091	41	60	44	57	5	20
YT-1092	42	61	44	57	4	16
YT-1093	43	63	44	57	4	16
YT-1096	46	66	44	62	3	12
YT-1100	50	71	54	72	3	12
YT-1102	52	74	54	72	2	8
YT-1105	55	78	54	74	2	8
YT-1110	60	84	54	74	2	8

YATO	Ø A [mm]	D1 [mm]	D2 [mm]	L [mm]	PCS PIECES	
YT-1119	19	32	44	90	9	36
YT-1121	21	35	44	90	9	36
YT-1122	22	38	44	90	9	36
YT-1124	24	40	44	90	9	36
YT-1127	27	42	44	90	9	36
YT-1128	28	44	44	90	8	32
YT-1129	29	44	44	90	8	32
YT-1130	30	46	44	90	7	28
YT-1132	32	48	44	90	7	28
YT-1133	33	50	44	90	6	24
YT-1134	34	51	44	90	6	24
YT-1135	35	52	44	90	6	24
YT-1136	36	54	44	90	6	24
YT-1138	38	56	44	90	6	24
YT-1141	41	60	44	90	5	20
YT-1142	42	61	44	90	4	16
YT-1143	43	63	44	90	3	12
YT-1146	46	66	44	90	3	12
YT-1148	48	68	44	90	2	8
YT-1150	50	71	54	90	2	8

EN Impact socket set
PL Zestaw nasadek udarowych
DE Kraftschrauber-Einsätze
RU Набор торцевых ударных головок
CZ Sada úderových nástrčných hlavíc
HU Gépi dugókulcs készlet

RO Set chei tubulare pt. impact
FR Jeu de douilles à choc
IT Set di chiavi a bussola a percussione
ES Juego de vasos de impacto
CN 风动套筒组套

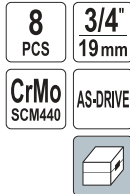

3/4" (19.0 mm): 22, 24 mm (L=50 mm); 27, 30 mm (L=53 mm); 32, 36 mm (L=55 mm); 38, 41 mm (L=57 mm)

YATO	○	3/4" (19.0 mm)	6
YT-1115			

EN Impact extension bar
PL Przedłużka udarowa
DE Verlängerung
RU Удлинитель ударный
CZ Prodlužovací přípravek
HU Toldalék

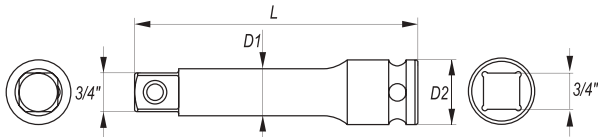

YATO	○	D1 [mm]	D2 [mm]	L [mm]	PCS BÚVÉRE	☐
YT-1160	3/4" (19.0 mm)	44	24	100	8	32
YT-1161	3/4" (19.0 mm)	44	24	175	10	20
YT-1162	3/4" (19.0 mm)	44	24	250	8	16
YT-1163	3/4" (19.0 mm)	44	24	330	6	12

EN Impact adapter
PL Redukcja udarowa
DE Reduktion
RU Переходник
CZ Redukce
HU Redukció
RO Reducție
FR Réduction
IT Prolunga per percussione
ES Reducción
CN 风动转换头

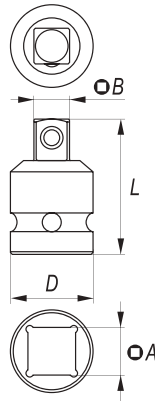

YATO	○	○	D [mm]	L [mm]	PCS BÚVÉRE	☐
YT-1168	3/4" (19.0 mm) (F)	1" (25.4 mm) (M)	44	63	12	48

EN Impact universal joint
PL Przegub kulisty udarowy
DE Kraft-Kugelgelenk
RU Ударный шаровой шарнир
CZ Kulový rázový kloub
HU Csuklós csatlakozó gépi
RO Articulație universală de impact
FR Joint universel à impact
IT Giunto universale a impatto
ES Articulación universal de impacto
CN 风动万向接头

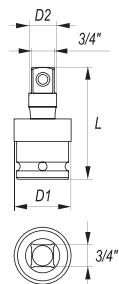

EN Impact socket set
PL Zestaw nasadek udarowych
DE Kraftschrauber-Einsätze
RU Набор торцевых ударных головок
CZ Sada úderových nástrčných hlavíc
HU Gépi dugókulcs készlet

RO Set chei tubulare pt. impact
FR Jeu de douilles à choc
IT Set di chiavi a bussola a percussione
ES Juego de vasos de impacto
CN 风动套筒组套

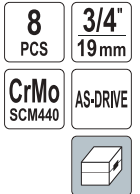

3/4" (19.0 mm): 22, 24, 27, 30, 32, 36, 38, 41 mm (L=90 mm)

YATO	○	3/4" (19.0 mm)	4
YT-1155			

EN Impact adapter
PL Redukcja udarowa
DE Reduktion
RU Переходник
CZ Redukce
HU Redukció
RO Reducție
FR Réduction
IT Prolunga per percussione
ES Reducción
CN 转接头

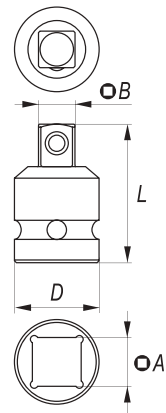

YATO	○	○	D [mm]	L [mm]	PCS BÚVÉRE	☐
YT-11671	3/4" (19.0 mm) (F)	1/2" (12.7 mm) (M)	44	55	12	48

EN Impact universal joint
PL Przegub kulisty udarowy
DE Kraft-Kugelgelenk
RU Ударный шаровой шарнир
CZ Kulový rázový kloub
HU Csuklós csatlakozó gépi

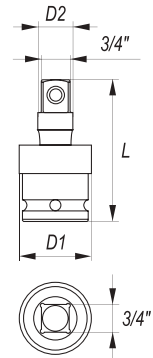

YATO	○	D1 [mm]	D2 [mm]	L [mm]	PCS BÚVÉRE	☐
YT-1164	3/4" (19.0 mm)	31	44	102	8	32



YATO	○	D1 [mm]	D2 [mm]	L [mm]	☐
YT-11641	3/4" (19.0 mm)	45.6	25.3	93.3	5/20

EN Hexagonal impact socket
 PL Nasadka uderowa sześciokątna
 DE Kraftschrauber-Einsatz
 RU Головка ударная 6-гранная
 CZ Šestihřanný nástavec
 HU Gépi dugúklucs hatszög

RO Cheie tubulară hexagonală de impact
 FR Douille à choc
 IT Chiave a bussola esagonale per percussione
 ES Boquilla de percusión
 CN 风动套筒

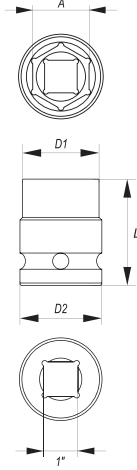

1"
25 mm
CrMo
SCM440
AS-DRIVE

EN Hexagonal deep impact socket
 PL Nasadka uderowa sześciokątna długa
 DE Kraftschrauber-Einsatz, lang
 RU Головка ударная 6-гранная глубокая
 CZ Šestihřanný hluboký nástavec
 HU Gépi dugúklucs hatszög hosszú

RO Cheie tubulară hexagonală de impact adâncă
 FR Douille profonde à choc
 IT Chiave a bussola esagonale per percussione
 ES Boquilla de percusión profunda
 CN 风动长套筒

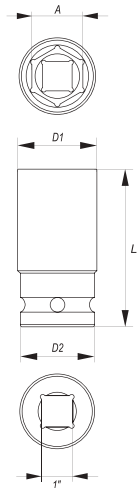

1"
25 mm
CrMo
SCM440
AS-DRIVE

YATO	∅ A [mm]	D1 [mm]	D2 [mm]	L [mm]	PCS PIECE	
YT-1180	24	42	54	59	6	24
YT-1183	27	46	54	59	6	24
YT-1184	28	47	54	59	6	24
YT-1185	29	48	54	60	6	24
YT-1186	30	49	54	60	6	24
YT-1187	32	52	54	61	6	24
YT-1188	33	53	54	61	6	24
YT-1189	34	54	54	61	6	24
YT-1191	36	57	54	65	6	24
YT-1193	38	60	54	65	5	20
YT-1194	41	63	54	65	4	16
YT-1196	46	69	54	73	3	12
YT-1197	48	72	54	73	2	8
YT-1198	50	75	54	73	2	8

YATO	∅ A [mm]	D1 [mm]	D2 [mm]	L [mm]	PCS PIECE	
YT-1175	27	46	54	90	6	24
YT-1176	30	50	54	90	6	24
YT-1177	32	52	54	90	6	24
YT-1178	33	54	54	90	6	24
YT-1179	36	57	54	90	6	24

EN Impact extension bar with adapter
 PL Przedłużka uderowa z redukcją
 DE Verlängerung mit Adapter
 RU Удлинитель с редукцией
 CZ Prodloužení s redukcí
 HU Hosszabbító szár adapterrel

RO Bara extensie cu adaptor
 FR Rallonge avec reduction
 IT Prolunga per percussionecon riduttore
 ES Tubo de prolongación con reductor
 CN 风动转换接头



1"
25 mm
CrMo
SCM440

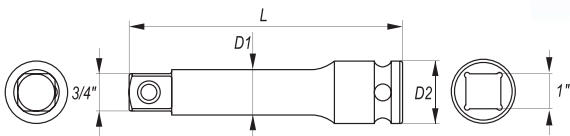

YATO	∅ A	∅ B	D1 [mm]	D2 [mm]	L [mm]	PCS PIECE	
YT-1169	1" (25.4 mm) (F)	3/4" (19.0 mm) (M)	53	33	250	6	12

EN Impact universal joint
 PL Przegub kulisty uderowy
 DE Kraft-Kugelgelenk
 RU Ударный шаровой шарнир
 CZ Kulový rázový kloub
 HU Csuklós csatlakozó gépi
 RO Articulație universală de impact
 FR Joint universel à impact
 IT Giunto universale a impatto
 ES Articulación universal de impacto
 CN 风动方向接头

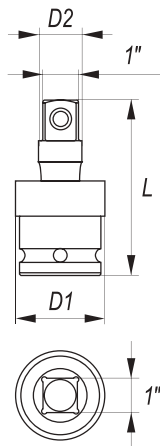

1"
25 mm
CrMo
SCM440
FOR IMPACT
TOOLS
DO NARZĘDZI
UDAROWYCH

EN Adaptor set
 PL Zestaw redukcji
 DE Adapter-Satz
 RU Редукционный комплект
 CZ Sada adaptérů
 HU Adapter készlet

RO Set adaptatoare
 FR Jeu de adaptateurs
 IT Set di adattatori
 ES Juego de adaptadores
 CN 气动转换接头组套

6
PCS
CrV



3/8" (9.5 mm) (M) x 1/4" (6.3 mm) (F), 1/4" (6.3 mm) (M) x 3/8" (9.5 mm) (F), 3/8" (9.5 mm) (F) x 1/2" (12.7 mm) (M), 1/2" (12.7 mm) (F) x 3/8" (9.5 mm) (M), 3/4" (19.0 mm) (M) x 1/2" (12.7 mm) (F), 1/2" (12.7 mm) (M) x 3/4" (19.0 mm) (F)

YATO	∅	D1 [mm]	D2 [mm]	L [mm]	
YT-11999	1" (25.4 mm)	54.3	33.9	110	3/12

YATO	
YT-10671	20

EN Impact universal joint set
PL Zestaw przegubów udarowych
DE Kraft-Kugelgelenk-Satz
RU Набор ударных шаровых шарниров
CZ Sada kulových rázových kloubů
HU Gépi csuklós csatlakozó készlet
RO Set articulatii universale de impact
FR Jeu de joints à impact
IT Kit di giunti universali a impatto
ES Juego articulaciones de impacto
CN 重型气动万向接头组套

3 PCS
1/2" 12.7mm
3/8" 9.5mm
1/4" 6.3mm
CrMo



YATO	○	
YT-10643	1/4" (6.3 mm), 3/8" (9.5 mm), 1/2" (12.7 mm)	10/60

EN Impact universal joint set
PL Zestaw przegubów udarowych
DE Kraft-Kugelgelenk-Satz
RU Набор ударных шаровых шарниров
CZ Sada kulových rázových kloubů
HU Gépi csuklós csatlakozó készlet
RO Set articulatii universale de impact
FR Jeu de joints à impact
IT Kit di giunti universali a impatto
ES Juego articulaciones de impacto
CN 重型气动万向接头组套

3 PCS
1/2" 12.7mm
3/8" 9.5mm
1/4" 6.3mm
CrMo
SCM440
FOR IMPACT TCCLLS DC NÁRZEDÍ UDAROVÝCH



YATO	○	
YT-10642	1/4" (6.3 mm), 3/8" (9.5 mm), 1/2" (12.7 mm)	5/20

EN Hexagonal impact socket
PL Nasadka udarowa sześciokątna
DE Kraftschrauber-Einsatz
RU Головка ударная 6-гранная
CZ Šestihranný nástavec
HU Gépi dugókulcs hatszög
RO Cheie tubulară hexagonală de impact
FR Douille à choc
IT Chiave a bussola esagonale per percussione
ES Boquilla de percusión
CN 风动套筒

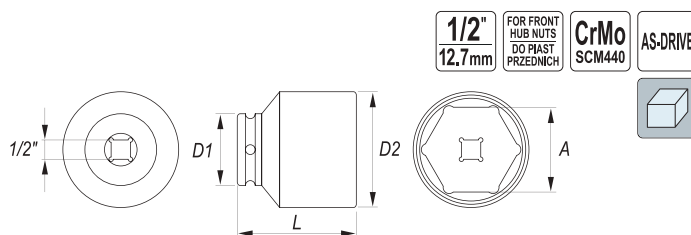

YATO	○ A [mm]	D1 [mm]	D2 [mm]	L [mm]	PCS PER	
YT-1029	52	44	71	72	3	12

EN Bi-hexagonal impact socket
PL Nasadka udarowa dwunastokątna
DE Zwölfkant-Kraftschrauber-Einsatz
RU Головка ударная 12-гранная
CZ Vanáctíhranný nástavec
HU Gépi dugókulcs 12-szögű
RO Cheie tubulară bihexagonală de impact
FR Douille à choc
IT Chiave a bussola esagonale per percussione
ES Boquilla bihexagonal de percusión
CN 风动套筒

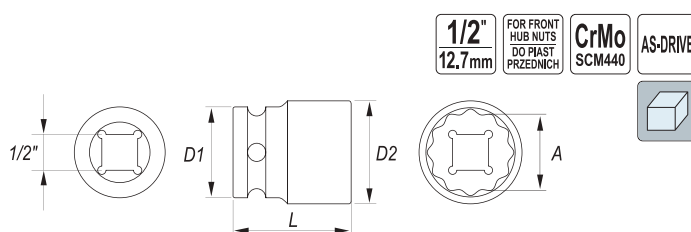

YATO	○ A [mm]	D1 [mm]	D2 [mm]	L [mm]	PCS PER	
YT-1027	24	30	34	39	10	120

EN Bi-hexagonal impact socket
PL Nasadka udarowa dwunastokątna
DE Zwölfkant-Kraftschrauber-Einsatz
RU Головка ударная 12-гранная
CZ Vanáctíhranný nástavec
HU Gépi dugókulcs 12-szögű
RO Cheie tubulară bihexagonală de impact
FR Douille à choc
IT Chiave a bussola esagonale per percussione
ES Boquilla bihexagonal de percusión
CN 风动套筒

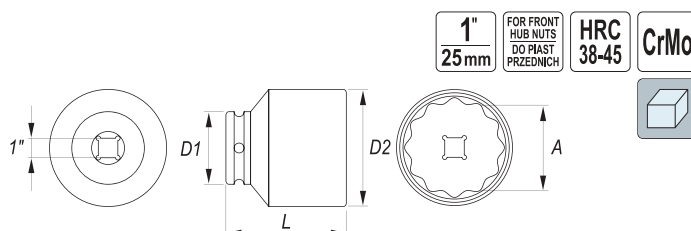

YATO	○ A [mm]	D1 [mm]	D2 [mm]	L [mm]	
YT-11990	65	54	93	93	4
YT-11995	80	86	112	100	4
YT-11998	85	86	118	102	4

EN Impact bit socket set
PL Zestaw udarowych kluczy trzpieniowych
DE Schlagsteckschlüsselsatz
RU Набор ударных торцовых ключей
CZ Sada rázových zástrčných klíčů
HU Üthető bit dugókulcs készlet
RO Set biți de impact cu adaptor
FR Jeu de douilles à impact
IT Set di chiavi a bussola per percussione
ES Juego de llaves de mandril de impacto
CN 风动套筒批头组套

6 PCS
1/2" 12.7mm
CrMo



○ 1/2" (12.7 mm): M14, M16, M18 (L=43 mm); M14, M16, M18 (L=78 mm)

YATO	○	
YT-10652	1/2" (12.7 mm)	20

EN Impact bit socket set
PL Zestaw udarowych kluczy trzpieniowych
DE Schlagsteckschlüsselsatz
RU Набор ударных торцовых ключей
CZ Sada rázových zástrčných klíčů
HU Üthető bit dugókulcs készlet

RO Set biți de impact cu adaptor
FR Jeu de douilles à impact
IT Set di chiavi a bussola per percussione
ES Juego de llaves de mandril de impacto
CN 风动套筒批头组套

9 PCS
1/2" 12.7mm
CrMo



○ 1/2" (12.7 mm): T20, T25, T30, T40, T45, T50, T55, T60, T70

YATO	○	
YT-10654	1/2" (12.7 mm)	10

EN Impact bit socket set
 PL Zestaw uderowych kluczy trzpieniowych
 DE Schlagsteckschlüsselsatz
 RU Набор ударных торцовых ключей
 CZ Sada rázových zástrčných klíčů
 HU Üthető bit dugókulcs készlet

RO Set biți de impact cu adaptor
 FR Jeu de douilles à impact
 IT Set di chiavi a bussola per percussione
 ES Juego de llaves de mandril de impacto
 CN 风动套筒批头组套

9
PCS





1/2"
12.7mm

CrMo



 1/2" (12.7 mm): RM5, RM6, RM7, RM8, RM9, RM10, RM12, RM13, RM14

YATO 		
YT-10681	1/2" (12.7 mm)	10

EN Impact bit socket set
 PL Zestaw uderowych kluczy trzpieniowych
 DE Schlagsteckschlüsselsatz
 RU Набор ударных торцовых ключей
 CZ Sada rázových zástrčných klíčů
 HU Üthető bit dugókulcs készlet
 RO Set biți de impact cu adaptor
 FR Jeu de douilles à impact
 IT Set di chiavi a bussola per percussione
 ES Juego de llaves de mandril de impacto
 CN 风动套筒批头组套



8
PCS

1/2"
12.7mm

HRC 54



CrMo







  1/2" (12.7 mm): T30, T40, T45, T50, T55, T60, T70, T80



YATO 		
YT-1065	1/2" (12.7 mm)	15



  1/2" (12.7 mm): 6, 7, 8, 10, 12, 14, 17, 19 mm



YATO 		
YT-1066	1/2" (12.7 mm)	10



  1/2" (12.7 mm): RM5, RM6, RM7, RM8, RM10, RM11, RM12, RM13

YATO 		
YT-1068	1/2" (12.7 mm)	15



  1/2" (12.7 mm): M5, M6, M8, M10, M12, M14, M16, M18

YATO 		
YT-1069	1/2" (12.7 mm)	15

EN Impact bit socket set
 PL Zestaw uderowych kluczy trzpieniowych
 DE Schlagsteckschlüsselsatz
 RU Набор ударных торцовых ключей
 CZ Sada rázových zástrčných klíčů
 HU Üthető bit dugókulcs készlet

RO Set biți de impact cu adaptor
 FR Jeu de douilles à impact
 IT Set di chiavi a bussola per percussione
 ES Juego de llaves de mandril de impacto
 CN 风动套筒批头组套

9
PCS





1/2"
12.7mm

CrMo



 1/2" (12.7 mm): M4, M5, M6, M8, M9, M10, M12, M14, M16

YATO 		
YT-10691	1/2" (12.7 mm)	10

EN Impact bit with holder set
 PL Zestaw uderowych kluczy trzpieniowych z nasadką
 DE Schlagschrauber-Steckschlüsselsatz mit Schutzkappe
 RU Набор ударных ключей с торцевыми головками
 CZ Sada imbusových nástrčných klíčů
 HU Gépi hatlapú dugókulcs készlet
 RO Set biți de impact cu adaptor
 FR Jeu de clés à choc avec douille
 IT Set di chiavi a brugola con punta
 ES Juego de llaves de vaso de impacto
 CN 冲击批头组套



9
PCS



1/2"
12.7mm

CrMo



S2







  1/2" (12.7 mm): T30, T40, T45, T47, T50, T55, T60, T70;
 (L=35 mm)

YATO 		
YT-10664	1/2" (12.7 mm)	6/36





  1/2" (12.7 mm): 6, 7, 8, 10, 12, 14, 17, 19 mm;
 (L=35 mm)

YATO 		
YT-10662	1/2" (12.7 mm)	6/36



  1/2" (12.7 mm): M6, M8, M9, M10, M12, M14, M16, M18;
 (L=35 mm)

YATO 		
YT-10663	1/2" (12.7 mm)	6/36

- EN Spline impact bit set
- PL Zestaw bitów udarowych Spline
- DE Schlagwerkzeugsatz Spline
- RU Набор ударных битов Spline
- CZ Souprava bitů pro rázové utahováky Spline
- HU Útő bit készlet Spline
- RO Set tubulare de impact
- FR Set d'embouts à choc
- IT Set di chiavi a bussola per percussione Spline
- ES Juego de las piezas de precisión Spline
- CN 风动花键批头组套



6 PCS 3/4" 19mm CrMo

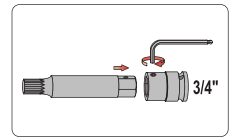

M12, M14, M16, M18 x 22 mm; (L=107 mm); CrMo;
 3/4" (19 mm) x 22 mm; CrMo;

- EN Impact bit socket set
- PL Zestaw udarowych kluczy trzpieniowych
- DE Schlagsteckschlüsselsatz
- RU Набор ударных торцевых ключей
- CZ Sada rázových zástrčných klíčů
- HU Úthető bit dugókulcs készlet
- RO Set biți de impact cu adaptor
- FR Jeu de douilles à impact
- IT Set di chiavi a bussola per percussione
- ES Juego de llaves de mandril de impacto
- CN 风动套筒批头组套

6 PCS 3/4" 19mm CrMo



3/4" (19.0 mm): M16, M18;
 3/4" (19.0 mm): T70, T80, T90, T100

YATO		
YT-10653	3/4" (19.0 mm)	10

- EN Impact socket set
- PL Zestaw nasadek udarowych
- DE Kraftschrauber-Einsätze
- RU Набор торцевых ударных головок
- CZ Sada úderových nástrčných hlavíc
- HU Gépi dugókulcs készlet
- RO Set chei tubulare pt. impact
- FR Jeu de douilles à choc
- IT Set di chiavi a bussola a percussione
- ES Juego de vasos de impacto
- CN 风动套筒批头组套

40 PCS 1/2" 12.7mm CrMo AS-DRIVE



1/2" (12.7 mm): 9, 10, 11, 12, 13, 14, 15, 16, 17, 18, 19, 20, 21, 22, 23, 24, 26, 27, 30 mm (L=38 mm); CrMo;
 1/2" (12.7 mm): 9, 10, 11, 12, 13, 14, 15, 16, 17, 18, 19, 20, 21, 22, 23, 24, 26, 27, 30 mm (L=78 mm); CrMo;
 1/2" (12.7 mm); (L=125 mm); CrMo;
 1/2" (12.7 mm) x 1/2" (12.7 mm); (L=60 mm); CrMo

YATO		
YT-10555	1/2" (12.7 mm)	2

YATO		
YT-1157	3/4" (19.0 mm)	8

- EN Impact socket set
- PL Zestaw nasadek udarowych
- DE Kraftschrauber-Einsätze
- RU Набор торцевых ударных головок
- CZ Sada úderových nástrčných hlavíc
- HU Gépi dugókulcs készlet
- RO Set chei tubulare pt. impact
- FR Jeu de douilles à choc
- IT Set di chiavi a bussola a percussione
- ES Juego de vasos de impacto
- CN 风动套筒组套

11 PCS 1/2" 12.7mm CrMo AS-DRIVE



1/2" (12.7 mm): 10, 13, 14, 17, 19, 21, 22, 24, 27 mm (L=38 mm); CrMo;
 1/2" (12.7 mm); (L=125 mm); CrMo;
 1/2" (12.7 mm) x 1/2" (12.7 mm); (L=60 mm); CrMo

YATO		
YT-10255	1/2" (12.7 mm)	10

- EN Impact bit socket set
- PL Zestaw udarowych kluczy trzpieniowych
- DE Schlagsteckschlüsselsatz
- RU Набор ударных торцевых ключей
- CZ Sada rázových zástrčných klíčů
- HU Úthető bit dugókulcs készlet
- RO Set biți de impact cu adaptor
- FR Jeu de douilles à impact
- IT Set di chiavi a bussola per percussione
- ES Juego de llaves de mandril de impacto
- CN 风动套筒批头组套

12 PCS 3/4" 19mm 1/2" 12.7mm CrMo FOR TRUCKS DO AUTÓZSARONYOK



3/4" (19 mm) (F); CrMo;
 1/2" (12.7 mm) (M); CrMo;
 3/4" (19 mm) (M) (L=200 mm); CrMo;
 T70, T80, T90, T100 (L=67 mm); CrMo;
 14, 17, 19, 21, 22 mm (L=67 mm); CrMo;
 3 mm

YATO		
YT-10655	1/2" (12.7 mm), 3/4" (19.0 mm)	5

4

Torque wrenches
& torque multipliers
Klucze dynamometryczne
i wzmacniacze momentu



Torque wrenches
Klucze dynamometryczne



74-76

Torque multipliers
Wzmacniacze momentu



76

Beam torque wrenches

Klucze dynamometryczne wychylne 74

Torque wrenches with metal handle

Klucze dynamometryczne z metalową rączką 74

Torque wrenches with plastic handle

Klucze dynamometryczne z plastikową rączką 74

Dial torque wrenches

Klucze dynamometryczne zegarowe 76

EN Beam torque wrench RU Ключ динамометрический стрелочный RO Cheie dinamometrică ES Llave dinamométrica de aguja
 PL Klucz dynamometryczny wychylny CZ Dynamometrický klíč FR Clé dynamométrique à aiguille CN 扭力扳手
 DE Beam-Typ-Drehmomentschlüssel HU Nyomatékkulcs IT Chiave dinamometrica a misurazione continua

1/2" 12.7mm 3/4" 19mm CrV 6140



YATO	Ø	[Nm]	
YT-07641	1/2" (12.7 mm)	0-300	16
YT-07642	3/4" (19.0 mm)	0-500	9

4

EN Torque wrench RU Ключ динамометрический RO Cheie dinamometrică ES Llave dinamométrica
 PL Klucz dynamometryczny CZ Dynamometrický klíč FR Clé dynamométrique CN 扭力扳手
 DE Drehmomentschlüssel HU Nyomatékkulcs IT Chiave dinamometrica

3/8" 9.5mm 1/2" 12.7mm CrV 6140



YATO	Ø	[Nm]	L [mm]	
YT-0750	3/8" (9.5 mm)	20-110	342-360	20
YT-0760	1/2" (12.7 mm)	42-210	445-465	12

EN Torque wrench RU Ключ динамометрический RO Cheie dinamometrică ES Llave dinamométrica
 PL Klucz dynamometryczny CZ Dynamometrický klíč FR Clé dynamométrique CN 扭力扳手
 DE Drehmomentschlüssel HU Nyomatékkulcs IT Chiave dinamometrica

3/8" 9.5mm 10-60 Nm 378-400 mm +/- CW 4% CCW 4% ALLOY STEEL STAL STOPOWA



YATO	Ø	[Nm]	L [mm]	
YT-07500	3/8" (9.5 mm)	10-60	378-400	12

EN Torque wrench RU Ключ динамометрический RO Cheie dinamometrică ES Llave dinamométrica
 PL Klucz dynamometryczny CZ Dynamometrický klíč FR Clé dynamométrique CN 扭力扳手
 DE Drehmomentschlüssel HU Nyomatékkulcs IT Chiave dinamometrica

1/4" 6.3mm 1/2" 12.7mm 3/4" 19mm +/- 4% ALLOY STEEL STAL STOPOWA



YATO	Ø	[Nm]	L [mm]	
YT-07511	1/4" (6.3 mm)	2.5-20	240-250	16
YT-07611	1/2" (12.7 mm)	10-60	378-400	12
YT-07601	1/2" (12.7 mm)	65-335	518-540	10
YT-07712	3/4" (19.0 mm)	80-400	676-697	4

EN Torque wrench RU Ключ динамометрический RO Cheie dinamometrică ES Llave dinamométrica
 PL Klucz dynamometryczny CZ Dynamometrický klíč FR Clé dynamométrique CN 扭力扳手
 DE Drehmomentschlüssel HU Nyomatékkulcs IT Chiave dinamometrica

3/8" 9.5mm 1/2" 12.7mm SETTINGS WINDOW OKNO USTAWIEN +/- CW 4% CCW 4% CrMo 42



YATO	Ø	[Nm]	L [mm]	
YT-07735	3/8" (9.5 mm)	10-60	415	10
YT-07736	3/8" (9.5 mm)	10-100	470	10
YT-07612	1/2" (12.7 mm)	10-60	415	12
YT-07607	1/2" (12.7 mm)	10-100	470	10
YT-07605	1/2" (12.7 mm)	20-220	481	10
YT-07609	1/2" (12.7 mm)	65-350	550	10

EN Torque wrench RU Ключ динамометрический RO Cheie dinamometrică ES Llave dinamométrica
 PL Klucz dynamometryczny CZ Dynamometrický klíč FR Clé dynamométrique CN 扭力扳手
 DE Drehmomentschlüssel HU Nyomatékkulcs IT Chiave dinamometrica

1/4" 6.3mm CrV 6140



YATO	Ø	[Nm]	L [mm]	
YT-0751	1/4" (6.3 mm)	2-10	268-278	24

EN Torque wrench RU Ключ динамометрический RO Cheie dinamometrică ES Llave dinamométrica
 PL Klucz dynamometryczny CZ Dynamometrický klíč FR Clé dynamométrique CN 扭力扳手
 DE Drehmomentschlüssel HU Nyomatékkulcs IT Chiave dinamometrica

3/8" 9.5mm +/- CW 3% CCW 3% CrMo 3042





YATO	Ø	[Nm]	L [mm]	
YT-07730	3/8" (9.5 mm)	6-30	295-316	12
YT-07731	3/8" (9.5 mm)	10-60	362-385	12

EN Torque wrench RU Ключ динамометрический RO Cheie dinamometrică ES Llave dinamométrica
 PL Klucz dynamometryczny CZ Dynamometrický klíč FR Clé dynamométrique CN 扭力扳手
 DE Drehmomentschlüssel HU Nyomatékkulcs IT Chiave dinamometrica

1/2"
12.7mm +/-
CW 3%
CCW 3% CrMo
3042 





YATO 	Ø	[Nm]	L [mm]	
YT-07740	1/2" (12.7 mm)	10-60	360-385	12
YT-07741	1/2" (12.7 mm)	20-100	420-440	12
YT-07743	1/2" (12.7 mm)	40-200	445-465	12

EN Torque wrench RU Ключ динамометрический RO Cheie dinamometrică ES Llave dinamométrica
 PL Klucz dynamometryczny CZ Dynamometrický klíč FR Clé dynamométrique CN 扭力扳手
 DE Drehmomentschlüssel HU Nyomatékkulcs IT Chiave dinamometrica

3/4"
19mm 1030
x1050
mm ≤500 Nm
+/- 3%
CW CCW >500 Nm
+/- 4%
CW CCW CrMo
3042 



YATO 	Ø	[Nm]	L [mm]	
YT-07752	3/4" (19.0 mm)	160-800	1030-1050	2
YT-07753	3/4" (19.0 mm)	200-1000	1030-1050	2

EN Torque wrench CZ Dynamometrický klíč IT Chiave dinamometrica
 PL Klucz dynamometryczny HU Nyomatékkulcs ES Llave dinamométrica
 DE Drehmomentschlüssel RO Cheie dinamometrică CN 扭力扳手
 RU Ключ динамометрический FR Clé dynamométrique

1"
25mm 300-1500
Nm 2160-2190
mm ≤500 Nm
+/- 3%
CW CCW >500 Nm
+/- 4%
CW CCW CrMo
3042 





YATO 	Ø	[Nm]	L [mm]	
YT-07762	1" (25.4 mm)	300-1500	2160-2190	1

EN Torque wrench RU Ключ динамометрический RO Cheie dinamometrică ES Llave dinamométrica
 PL Klucz dynamometryczny CZ Dynamometrický klíč FR Clé dynamométrique CN 扭力扳手
 DE Drehmomentschlüssel HU Nyomatékkulcs IT Chiave dinamometrica

3/4"
19mm **1/2"**
12.7mm CrV
6140 





YATO 	Ø	[Nm]	L [mm]	
YT-0761	1/2" (12.7 mm)	40-210	516-534	10
YT-0770	3/4" (19.0 mm)	100-500	845-860	4
YT-0771	3/4" (19.0 mm)	140-980	1215-1230	2

EN Torque wrench RU Ключ динамометрический RO Cheie dinamometrică ES Llave dinamométrica
 PL Klucz dynamometryczny CZ Dynamometrický klíč FR Clé dynamométrique CN 扭力扳手
 DE Drehmomentschlüssel HU Nyomatékkulcs IT Chiave dinamometrica

1/2"
12.7mm CrV
6140 





YATO 	Ø	[Nm]	L [mm]	
YT-0754	1/2" (12.7 mm)	60-340	592-613	10

EN Torque wrench RU Ключ динамометрический RO Cheie dinamometrică ES Llave dinamométrica
 PL Klucz dynamometryczny CZ Dynamometrický klíč FR Clé dynamométrique CN 扭力扳手
 DE Drehmomentschlüssel HU Nyomatékkulcs IT Chiave dinamometrica

3/4"
19mm 150-800
Nm +/-
CW 3%
CCW 5% HRC
48-52 CrV
6140 





YATO 	Ø	[Nm]	L [mm]	
YT-07711	3/4" (19.0 mm)	150-800	1155-1175	2

- EN Dial torque wrench
 PL Zegarowy klucz dynamometryczny
 DE Drehmomentschlüssel mit Skalenmessuhr
 RU Стрелочный динамометрический ключ
- CZ Momentový klíč s kruhovou stupnicí
 HU Mérőtárcsás nyomatékkulcs
 RO Cheie dinamometrică cu ceas
 FR Clé dynamométrique avec horloge
- IT Chiave dinamometrica a orologio
 ES Llave dinamométrica con reloj
 CN 扭力扳手

1/4" 3/8" 1/2"
 6.3mm 9.5mm 12.7mm

+/- 3%







YATO 	Ø	[Nm]	L [mm]	
YT-07830	1/4" (6.3 mm)	0.5-5	335	12
YT-07831	1/4" (6.3 mm)	1-10	335	12
YT-07832	3/8" (9.5 mm)	3-30	335	12

4

- EN Dial torque wrench
 PL Zegarowy klucz dynamometryczny
 DE Drehmomentschlüssel mit Skalenmessuhr
 RU Стрелочный динамометрический ключ
- CZ Momentový klíč s kruhovou stupnicí
 HU Mérőtárcsás nyomatékkulcs
 RO Cheie dinamometrică cu ceas
 FR Clé dynamométrique avec horloge
- IT Chiave dinamometrica a orologio
 ES Llave dinamométrica con reloj
 CN 扭力扳手

1/2" +/- 3%
 12.7mm





YATO 	Ø	[Nm]	L [mm]	
YT-07835	1/2" (12.7 mm)	20-200	490	10
YT-07836	1/2" (12.7 mm)	30-300	590	10



- EN Torque multiplier
 PL Mechaniczny wzmacniacz momentu
 DE Drehmomentverstärker
 RU Мультипликатор крутящего момента
 CZ Mechanický posilovač momentu
 HU Nyomaték sokszorozó
 RO Antrenor cu amplificator de forță
 FR Amplificateur de couple mécanique
 IT Moltiplicatore di coppia
 ES Mecanismo de reforzar el momento
 CN 扭力倍增器

1" 330 mm
 25 mm

4200 Nm (max.) I-1:3.8 II-1:5.8

CrV 



YATO 	Ø	Tmax. [Nm]	L [mm]	
YT-0782	1" (25.4 mm)	4200	330	1



- EN Torque multiplier
 PL Mechaniczny wzmacniacz momentu
 DE Drehmomentverstärker
 RU Мультипликатор крутящего момента
 CZ Mechanický posilovač momentu
 HU Nyomaték sokszorozó
 RO Antrenor cu amplificator de forță
 FR Amplificateur de couple mécanique
 IT Moltiplicatore di coppia
 ES Mecanismo de reforzar el momento
 CN 扭矩倍增器

1" 380 mm
 25 mm

5800 Nm (max.) I-1:6.6

CrV 



YATO 	Ø	Tmax. [Nm]	L [mm]	
YT-07822	1" (25.4 mm)	5800	380	1

Memo



5

Screwdrivers
& screwdriver bits
Wkr taki i ko cówki
wkr takowe



Screwdrivers, 3 color handle
Wkręta, trójkolorowa rączka

80-82



Slotted screwdrivers

Wkręta płaskie

80

Phillips screwdrivers

Wkręta krzyżakowe

80

Pozidrive screwdrivers

Wkręta „Pozidrive”

80

Torx screwdrivers

Wkręta „Torx”

80

Torx Security screwdrivers

Wkręta „Torx Security”

80

Go-through screwdrivers

Wkręta do pobijania

80

Screwdriver sets

Komplety wkręta

81

Screwdrivers, 3 color handle
Wkręta, trójkolorowa rączka

82



Screwdriver sets

Komplety wkręta

82

Screwdrivers

Wkręta

83



Slotted screwdrivers

Wkręta płaskie

83

Phillips screwdrivers

Wkręta krzyżakowe

83

Precision screwdrivers, 3 color handle
Wkręta precyzyjne, trójkolorowa rączka

83-84



Precision slotted screwdrivers

Wkręta precyzyjne płaskie

83

Precision phillips screwdrivers

Wkręta precyzyjne krzyżakowe

83

Precision Torx screwdrivers

Wkręta precyzyjne „Torx”

83

Precision screwdriver sets

Zestawy wkręta precyzyjnych

83

Special screwdrivers & impact screwdrivers
Wkręta specjalne i udarowe

84-85



Ratchet screwdriver sets

Wkręta z grzechotką

84

Impact screwdrivers

Wkręta udarowe

85

Screwdriver bits

Końcówki wkręta

86-95



Phillips screwdriver bits

Końcówki wkręta krzyżakowe

86

Torx screwdriver bits

Końcówki wkręta „Torx”

86

YATO NON-SLIP SYSTEM screwdriver bits

Końcówki wkręta „YATO NON-SLIP SYSTEM”

88

Screwdriver bit sets

Zestawy końcówek wkręta

91

Nut setters

Nasadki magnetyczne do wkręta

95



Screwdriver bit holders

Uchwyty do końcówek wkręta

95-98



Hex & Torx keys & sets

Klucze imbusowe i zestawy

99-105



T-handle keys & sets

Klucze imbusowe typu „T” i zestawy

99

Hex keys & sets

Klucze imbusowe i zestawy

100

Torx & Torx Security keys & sets

Klucze „Torx”, „Torx Security” i zestawy

101



Plastic covered hex & Torx Security keys

Klucze imbusowe powlekane



104

EN Screwdriver CZ Šroubovák IT Cacciavite
 PL Wkrętarz HU Csavarhúzó ES Destornillador
 DE Schraubendreher RO Șurubelniță CN 螺丝批
 RU Отвёртка FR Tournevis





YATO 	⊖ [mm]	L [mm]	PCS PKG	
YT-25900	2	75	12	96/384
YT-25901	3	75	12	96/384
YT-25902	3	100	12	96/384
YT-25903	3	150	12	60/240
YT-25904	4	100	12	96/384
YT-25905	4	150	12	96/384
YT-25906	4	200	12	96/384
YT-25907	5	75	12	60/240
YT-25908	5	100	12	60/240
YT-25909	5	150	12	60/240
YT-25910	6	38	12	60/240
YT-25911	6	100	12	36/144
YT-25912	6	150	12	36/144
YT-25913	6	200	12	36/144
YT-25914	8	150	6	24/96





YATO 	⊕	L [mm]	PCS PKG	
YT-25920	PH0	75	12	96/384
YT-25921	PH0	100	12	96/384
YT-25922	PH1	38	12	60/240
YT-25923	PH1	75	12	60/240
YT-25924	PH1	100	12	60/240
YT-25925	PH1	150	12	60/240
YT-25926	PH1	200	12	36/144
YT-25927	PH1	300	6	24/96
YT-25928	PH2	38	12	60/240
YT-25929	PH2	100	12	36/144
YT-25930	PH2	150	12	36/144
YT-25931	PH2	200	12	36/144
YT-25932	PH2	300	6	24/96
YT-25933	PH3	150	6	24/96
YT-25934	PH3	200	6	24/96





YATO 	⊕	L [mm]	PCS PKG	
YT-25940	PZ1	75	12	60/240
YT-25941	PZ1	100	12	60/240
YT-25942	PZ2	100	12	36/144
YT-25943	PZ2	150	12	36/144





YATO 	⊗	L [mm]	PCS PKG	
YT-25950	T5	75	12	96/384
YT-25951	T6	75	12	96/384



YATO 	⊗	L [mm]	PCS PKG	
YT-25952	T7	75	12	96/384
YT-25953	T8	75	12	96/384
YT-25954	T9	75	12	96/384
YT-25955	T10	100	12	60/240
YT-25956	T15	100	12	60/240
YT-25957	T20	100	12	60/240
YT-25958	T25	100	12	36/144
YT-25959	T27	100	12	36/144
YT-25960	T30	100	12	36/144
YT-25961	T40	100	6	24/96

EN Go-through screwdriver RU Отвёртка ударная RO Șurubelniță mecanică ES Destornillador de golpe
 PL Wkrętarz do pobijania CZ Šroubovák s úderným koncem FR Tournevis à frapper CN 螺丝批
 DE Schlag-Schraubendreher HU Üthető csavarhúzó IT Cacciavite a percussione



YATO 	⊕	L [mm]	PCS PKG	
YT-25993	PH2	100	6	24/96
YT-25994	PH2	150	6	24/96
YT-25995	PH3	150	6	24/72
YT-25996	PH3	200	6	24/72
YT-25997	PH3	250	6	24/72



YATO 	⊖ [mm]	L [mm]	PCS PKG	
YT-25985	6	100	6	24/96
YT-25986	6	150	6	24/96
YT-25987	6	200	6	24/96
YT-25988	6	250	6	24/96
YT-25989	8	150	6	24/72
YT-25990	8	200	6	24/72
YT-25991	8	250	6	24/72
YT-25992	8	300	6	24/72

EN Screwdriver set
PL Zestaw wkrętek
DE Schraubendreher-Satz
RU Набор отвёрток
CZ Sada šroubováků
HU Csavarhúzó készlet
RO Set șurubelnițe
FR Jeu de tournevis
IT Set di cacciaviti
ES Juego de destornilladores
CN 螺丝批组套



2
PCS

⊖ ⊕

HRC 52 CrV 6150

⊖ 6.0 mm (L=150 mm);
⊕ PH2 (L=150 mm)

YATO
YT-25998 6/36

EN Screwdriver set
PL Zestaw wkrętek
DE Schraubendreher-Satz
RU Набор отвёрток
CZ Sada šroubováků
HU Csavarhúzó készlet
RO Set șurubelnițe
FR Jeu de tournevis
IT Set di cacciaviti
ES Juego de destornilladores
CN 螺丝批组套



6
PCS



⊖ 3.0 mm (L=75 mm), 5.0, 6.0 mm (L=100 mm);
⊕ PH0 (L=75 mm), PH1, PH2 (L=100 mm)

YATO
YT-25965 6/24



8
PCS



⊖ 2.0, 2.4 mm (L=50 mm), 6.0 mm (L=38 mm), 6.0 mm (L=100 mm);
⊕ PH0, PH1 (L=50 mm), PH2 (L=38 mm), PH2 (L=100 mm)

YATO
YT-25980 6/24



8
PCS



⊖ 5.0, 6.0 mm (L=100 mm), 8.0 mm (L=150 mm);
⊕ PH0 (L=75 mm), PH1, PH2 (L=100 mm), PH2 (L=38 mm), PH3 (L=150 mm)

YATO
YT-25966 6/12



12
PCS



⊖ 3.0, 5.0 mm (L=75 mm), 6.0 mm (L=38 mm), 6.0, 8.0 mm (L=150 mm);
⊕ PH0, PH1 (L=75 mm), PH2 (L=38 mm), PH2 (L=100 mm), PH3 (L=150 mm);
□ SQ1, SQ2 (L=100 mm)

YATO
YT-25967 6/12

EN Screwdriver set
PL Zestaw wkrętek
DE Schraubendreher-Satz
RU Набор отвёрток
CZ Sada šroubováků
HU Csavarhúzó készlet
RO Set șurubelnițe
FR Jeu de tournevis
IT Set di cacciaviti
ES Juego de destornilladores
CN 螺丝批组套



15
PCS



HRC 58

S2



⊖ 1.5, 2.0 mm (L=50 mm), 5.0 mm (L=75 mm), 6.0 mm (L=38 mm), 6.0 mm (L=100 mm), 6.0 mm (L=125 mm);
⊕ PH00, PH0 (L=50 mm), PH1 (L=75 mm), PH2 (L=38 mm), PH2 (L=100 mm);
★ T5, T6, T7, T8 (L=50 mm)

YATO
YT-25981 6/24

EN Screwdriver set
PL Zestaw wkrętek
DE Schraubendreher-Satz
RU Набор отвёрток
CZ Sada šroubováků
HU Csavarhúzó készlet
RO Set șurubelnițe
FR Jeu de tournevis
IT Set di cacciaviti
ES Juego de destornilladores
CN 螺丝批组套



9
PCS



HRC 58

S2



⊖ 3.0, 5.0 mm (L=75 mm), 6.0 mm (L=100 mm), 6.0, 8.0 mm (L=150 mm);
⊕ PH0, PH1 (L=75 mm), PH2 (L=100 mm), PH2 (L=150 mm)

YATO
YT-25968 6/12

EN 6 in 1 interchangeable screwdriver set
 PL Wkrętarz z końcówkami dwustronnymi
 DE Umsteckschraubendreher
 RU Отвёртка с двухсторонними насадками
 CZ Šroubovák lanecr z dvoustrannou koncovkou
 HU Csavarhúzó kétfélgű szárral

RO Şurubelniță cu capăt dublu
 FR Tournevis embouts réversibles
 IT Cacciavite reversibile
 ES Destornillador con punta de dos caras
 CN 螺丝批

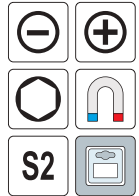

⌀ 5.0 mm x PH1, 6.0 mm x PH2;
 ⌀ 1/4" (6.3 mm) x 5/16" (8 mm)

YATO
 YT-25971

12/96

5

EN Screwdriver set
 PL Zestaw wkrętarzów
 DE Schraubendreher-Satz
 RU Набор отвёрток
 CZ Sada šroubováků
 HU Csavarhúzó készlet
 RO Set şurubelnițe
 FR Jeu de tournevis
 IT Set di cacciaviti
 ES Juego de destornilladores
 CN 螺丝批组套



⌀ 2.4, 3.0 mm (L=50 mm), 5.0 mm (L=75 mm), 6.0 mm (L=38 mm), 6.0 mm (L=100 mm), 8.0 mm (L=150 mm);
 ⌀ PH00, PH0 (L=50 mm), PH1 (L=75 mm), PH2 (L=38 mm), PH2 (L=100 mm), PH3 (L=150 mm);
 ⌀ T5, T6, T7, T8, T9, T10 (L=50 mm)

YATO
 YT-25982

6/12

EN Screwdriver set
 PL Zestaw wkrętarzów
 DE Schraubendreher-Satz
 RU Набор отвёрток
 CZ Sada šroubováků
 HU Csavarhúzó készlet

RO Set şurubelnițe
 FR Jeu de tournevis
 IT Set di cacciaviti
 ES Juego de destornilladores
 CN 螺丝批组套

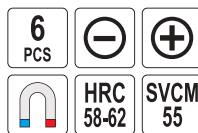

⌀ 5.5, 6.5 mm (L=100 mm), 8.0 mm (L=150 mm);
 ⌀ PH1, PH2 (L=100 mm), PH3 (L=150 mm)

YATO
 YT-2668

6/24

EN Mini pick & hook set
 PL Zestaw haczyków z rękojeścią
 DE Mini Hacken Set
 RU Набор ключков с рукоятками
 CZ Sada háčkových mini páčidel
 HU Mini ár és kampó készlet
 RO Mini-set pt. extras garnituri
 FR Set de crochets
 IT Set ganci con maniglia
 ES Juego de palancas de hierro
 CN 迷你拉拔器组套



YATO
 YT-0843

12/72

EN Screwdriver set
 PL Zestaw wkrętarzów
 DE Schraubendreher-Satz
 RU Набор отвёрток
 CZ Sada šroubováků
 HU Csavarhúzó készlet

RO Set şurubelnițe
 FR Jeu de tournevis
 IT Set di cacciaviti
 ES Juego de destornilladores
 CN 螺丝批组套

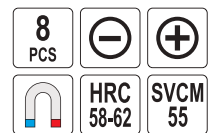

⌀ 4.0, 5.5, 6.5 mm (L=100 mm), 6.5 mm (L=38 mm);
 ⌀ PH0 (L=75 mm), PH1, PH2 (L=100 mm), PH2 (L=38 mm)

YATO
 YT-2670

4/16

EN Screwdriver CZ Šroubovák IT Cacciavite
PL Wkrętkak HU Csavarhúzó ES Destornillador
DE Schraubendreher RO Șurubelniță CN 螺丝批
RU Отвёртка FR Tournevis



YATO	⊖ [mm]	L [mm]	☐
YT-25652	3	75	24/288
YT-25650	3	100	24/288
YT-25651	3	150	24/288
YT-25656	5	75	12/180
YT-25653	5	100	12/180
YT-25654	5	150	12/180
YT-25655	5	200	12/180
YT-25657	6	100	12/180
YT-25658	6	125	12/180
YT-25659	6	150	12/180
YT-25660	6	200	12/180
YT-25661	6	250	12/108
YT-25663	8	150	12/108
YT-25664	8	200	12/108
YT-25665	8	250	12/108

YATO	⊕	L [mm]	☐
YT-25672	PH0	75	24/288
YT-25670	PH0	100	24/288
YT-25671	PH0	150	24/288
YT-25676	PH1	75	12/180
YT-25673	PH1	100	12/180
YT-25674	PH1	150	12/180
YT-25675	PH1	200	12/180
YT-25677	PH2	100	12/180
YT-25678	PH2	125	12/180
YT-25679	PH2	150	12/180
YT-25680	PH2	200	12/180
YT-25681	PH2	250	12/108
YT-25683	PH3	150	12/108
YT-25684	PH3	200	12/108
YT-25685	PH3	250	12/108

EN Precision screwdriver CZ Šroubovák pro jemnou mechaniku IT Cacciavite di precisione
PL Wkrętkak precyzyjny HU Műszerész csavarhúzó ES Destornillador de precisión
DE Präzisions-Schraubendreher RO Șurubelniță de precizie CN 钟表螺丝批
RU Отвёртка для точных работ FR Tournevis de précision



YATO	⊖ [mm]	L [mm]	☐
YT-25802	1.4	50	50/400
YT-25803	1.6	50	50/400
YT-25804	1.8	50	50/400
YT-25805	2.0	50	50/400
YT-25806	2.0	75	50/400
YT-25807	2.4	50	50/400
YT-25808	2.4	75	50/400
YT-25809	3.0	50	50/400
YT-25810	3.0	75	50/400
YT-25811	3.0	100	50/400



YATO	⊕	L [mm]	☐
YT-25831	PH000	50	50/400
YT-25832	PH000	75	50/400
YT-25833	PH00	50	50/400
YT-25834	PH00	75	50/400
YT-25835	PH0	50	50/400
YT-25836	PH0	75	50/400
YT-25837	PH0	100	50/400
YT-25838	PH1	50	50/400
YT-25839	PH1	100	50/400
YT-25840	PH1	150	50/400



YATO	☼	L [mm]	☐
YT-25852	T5	50	50/400
YT-25853	T6	50	50/400
YT-25854	T7	50	50/400
YT-25855	T8	50	50/400
YT-25856	T9	50	50/400
YT-25857	T10	50	50/400

EN Precision screwdriver set CZ Sada šroubováků pro jemnou mechaniku IT Set cacciavite di precisione
PL Zestaw wkrętek precyzyjnych HU Órás csavarhúzó készlet ES Juego destornilladores de precisión
DE Präzisions-Schraubendreher-Satz RO Set șurubelnițe de precizie CN 钟表螺丝批组套
RU Набор прецизионных отвёрток FR Jeu de tournevis de précision



6
PCS



⊖ 1.4, 2.0, 2.4 mm (L=50 mm);
⊕ PH00, PH0, PH1 (L=50 mm)

6
PCS



☼ T5, T6, T7, T8, T9, T10 (L=50 mm)

7
PCS



⊖ 2.0, 3.0 mm (L=50 mm);
⊕ PH00, PH0 (L=50 mm);
☼ T5, T6, T7 (L=50 mm)

YATO	☐
YT-25861	6/36

YATO	☐
YT-25862	6/36

YATO	☐
YT-25863	6/36

EN Mobile phone repair tools set
 PL Zestaw do naprawy telefonów komórkowych
 DE Mobiltelefon Reparatur Satz
 RU Набор инструмента для ремонта мобильных телефонов
 CZ Nástroje na opravu mobilních telefonů
 HU Mobiltelefon-javítás szerszámkészlet

RO Set surubelnite service telefoane mobile
 FR Outils de réparation de téléphone mobil
 IT Set di riparazione del telefono cellulare
 ES Herramientas de la reparación del teléfono móvil fijadas
 CN 精密批维修套装

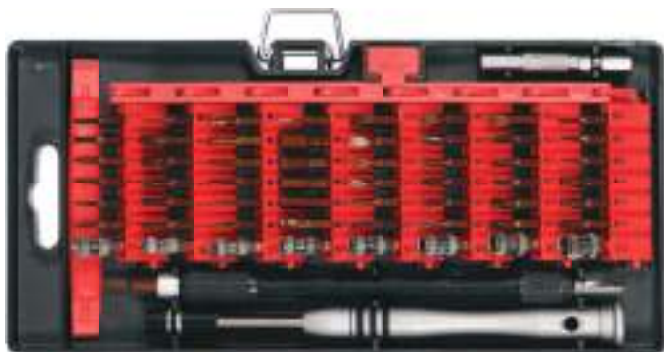

61 PCS	5/32" 4.0 mm	+	+
☆	☆	☆	☆
□	△	△	△
○	○	S2	📦

- ⌘ (L=100 mm);
- ⌘ (L=145 mm);
- ⌘ 1/4" (6.3 mm); (L=46 mm); S2;
- ⌘ (L=60 mm);
- ⌘ (L=85 mm);
- ⌘ 2.5, 3.0, 3.5, 4.0, 4.5, 5.0, 5.5 mm; PH2 (magnetic); S2;
- ⌘ 1.0, 1.5, 2.0, 2.5, 3.0, 3.5, 4.0 mm (L=25 mm); S2;
- ⌘ PH000, PH00, PH0, PH1, PH2 (L=25 mm); S2;
- ⌘ T2, T3, T4, T5, T6, T7 (L=25 mm); S2;
- ⌘ T8, T9, T10, T15, T20 (L=25 mm); S2;
- ⌘ 0.7, 0.9, 1.3, 1.5, 2.0, 2.5, 3.0, 4.0, 4.5, 5.0, 6.0 mm (L=25 mm); S2;
- ⌘ S0, S1, S2 (L=25 mm); S2;
- ☆ 0.8, 1.2, 1.5 mm (L=25 mm); S2;
- ⌘ 0.6, 2.0, 2.5 mm (L=25 mm); S2;
- △ 2.0, 3.0 mm (L=25 mm); S2;
- ⌘ 2.6, 3.0 mm (L=25 mm); S2;
- 0.8 mm (L=25 mm); S2

YATO	📦
YT-25760	25/50

EN 22 in 1 interchangeable screwdriver set
 PL Wkrętek z końcówkami dwustronnymi
 DE Umsteckschraubendreher
 RU Отвёртка - двухсторонние насадки
 CZ Šroubovák s oboustrannými nástavci
 HU Csavarhúzó kétvégű szárral

RO Set șurubelnițe cu dublu capăt
 FR Tournevis avec embouts double face
 IT Set cacciavite con punte reversibile
 ES Destornillador con punta dos caras
 CN 螺丝批组套



12 PCS
22in1 22w1
+
+
☆
☆
SVCN
📦

- ⌘ 4 mm x 5.5 mm (L=175/115 mm)
- ⌘ 6.5 mm x PH3 (L=175/115 mm)
- ⌘ PH1 x PH2 (L=175/115 mm)
- ⌘ PZ1 x PZ2 (L=175/115 mm)
- ⌘ 3 mm x 3 mm (L=175/115 mm)
- ⌘ 4 mm x 4 mm (L=175/115 mm)
- ⌘ 5 mm x 5 mm (L=175/115 mm)
- ⌘ 6 mm x 6 mm (L=175/115 mm)
- ☆ T10 x T15 (L=175/115 mm)
- ☆ T20 x T25 (L=175/115 mm)
- ☆ T30 x T40 (L=175/115 mm)

YATO	📦
YT-2797	6/12

EN Screwdriver set with bits
 PL Zestaw - wkrętek z końcówkami
 DE Schraubendreher- und Bit-Set
 RU Набор - отвёртка с битами
 CZ Sada - šroubovák s koncovkami
 HU Készlet - csavarhúzó bitfejekkel

RO Set surubelnita cu bitii
 FR Ensemble tournevis avec embout
 IT Set - avvitatrice con punte
 ES Juego de atornillador con puntas
 CN 螺丝批组套



28 PCS	+	+	☆
☆	□	S2	CrV
📦			

EN Ratchet screwdriver with bits
 PL Wkrętek z grzechołką i bitami
 DE Schraubendreher mit Ratche
 RU Отвёртка с трещоткой
 CZ Šroubovák z řehlačkou
 HU Racsnis csavarbehajtó
 RO Antrenor cu clichet + set biti
 FR Coffret tournevis a cliquet réversible porte-embouts
 IT Set di inserti con chiave a cricchetto
 ES Juego con destornillador y carraca
 CN 螺丝批组套

11 PCS	1/4" 6.3 mm	+
+	□	72T
CrV 6150	S2	📦



- ⌘ 1/4" (6.3 mm); 4, 5, 6 mm; S2;
- ⌘ 1/4" (6.3 mm); PH0, PH1, PH2; S2;
- ⌘ 1/4" (6.3 mm); S1, S2, S3; S2;
- ⌘

YATO	○	📦
YT-14390	1/4" (6.3 mm)	25/50

- ⌘ 6, 7, 8, 10, 12 mm; CrV;
- ⌘ 1.5 mm x PH000, 2.0 mm x PH00, 2.5 mm x PH0, 3.0 mm x PH1 (L=75 mm);
- 1.5 mm x PH000, 2.0 mm x PH00, 2.5 mm x PH0 (L=115 mm); S2;
- ☆ T6 x T7, T8 x T9 (L=75 mm); T6 x T7, T8 x T9 (L=115 mm); S2;
- ⌘ 2 x 3 mm (L=75 mm); S2;
- ⌘ 5 x 6 mm (L=75 mm); 5 x 6 mm (L=115 mm); S2;
- ⌘ PH1 x PH2, PH2 x PH3 (L=75 mm); PH1 x PH2, PH2 x PH3 (L=115 mm); S2;
- ⌘ S1 x S2 (L=75 mm); S1 x S3 (L=115 mm); S2;
- ⌘ 5 x 6 mm (L=75 mm); S2;
- ☆ T10 x T15 (L=115 mm); S2

YATO	📦
YT-27940	6/12

EN Precision screwdriver with bits
PL Wkrętkak elastyczny z wymiennymi bitami
DE Schraubendreher- und Bit-Satz
RU Отвёртка с прецизионными битами
CZ Šroubovák ráčňový se sadou bitů
HU Órás csavarahúzó-bit készlet

RO Set șurubelniță flexibilă cu biți
FR Tournevis élastique
IT Cacciavite flessibile con punte intercambiabili
ES Juego de pizas terminales para destornillador + mango
CN 可弯曲批头组套



31 PCS
215 mm
1/4" 6.3mm
CrV 6150
S2

- 1/4" (6.3 mm): 3.0, 3.5, 4.0, 5.5, 6.5 mm (L=25 mm);
- ⊕ 1/4" (6.3 mm): PH0, PH1, PH2, PH3 (L=25 mm);
- ⊕ 1/4" (6.3 mm): PZ0, PZ1, PZ2, PZ3 (L=25 mm);
- ⊙ 1/4" (6.3 mm): T10, T15 (L=25 mm);
- 1/4" (6.3 mm): 2, 3, 4, 5, 6 mm (L=25 mm);
- 1/4" (6.3 mm): 5, 6, 7, 8 x2, 9, 10, 11, 12, 13 mm

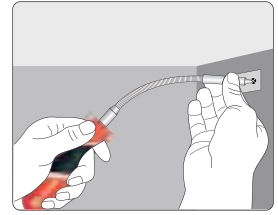

YATO
YT-25972 6/24

5

EN Impact screwdriver
PL Wkrętkak uderowoy
DE Schlagschrauber
RU Отвёртка ударная
CZ Narazový šroubovák kovový
HU Kézi ütvecsavarhúzó

RO Șurubelniță metalică cu percutor
FR Tournevis à choc
IT Cacciavite percussione
ES Destornillador de percusión
CN 冲击螺丝批组套



7 PCS
1/2" 12.7 mm
5/16" 8 mm
CrV 6150

- 5/16" (7.9 mm) x 1/2" (12.7 mm);
- 7, 8 mm (L=35 mm); 8 mm (L=75 mm);
- ⊕ PH2, PH3 (L=35 mm); PH2 (L=75 mm)

YATO
YT-2801 5/20

EN Impact screwdriver
PL Wkrętkak uderowoy
DE Schlagschrauber
RU Отвёртка ударная
CZ Narazový šroubovák kovový
HU Kézi ütvecsavarhúzó

RO Șurubelniță metalică cu percutor
FR Tournevis à choc
IT Cacciavite percussione
ES Destornillador de percusión
CN 冲击螺丝批

7 PCS 175 mm 1/2" 12.7 mm 5/16" 8 mm



- 5/16" (7.9 mm) x 1/2" (12.7 mm);
- 7, 8 mm (L=35 mm); 8 mm (L=75 mm);
- ⊕ PH2, PH3 (L=35 mm); PH3 (L=75 mm)

YATO
YT-2803 8/16

EN Impact screwdriver
PL Wkrętkak uderowoy
DE Schlagschrauber
RU Отвёртка ударная
CZ Narazový šroubovák kovový
HU Kézi ütvecsavarhúzó

RO Șurubelniță metalică cu percutor
FR Tournevis à choc
IT Cacciavite percussione
ES Destornillador de percusión
CN 冲击螺丝批

7 PCS 160 mm 1/2" 12.7 mm 5/16" 8 mm



- 5/16" (7.9 mm) x 1/2" (12.7 mm);
- 8 mm (L=35 mm); 8 mm (L=75 mm);
- ⊕ PH3 (L=35 mm); PH1, PH2, PH3 (L=75 mm)

YATO
YT-2802 20

EN Impact screwdriver
PL Wkrętkak uderowoy
DE Schlagschrauber
RU Отвёртка ударная
CZ Narazový šroubovák kovový
HU Kézi ütvecsavarhúzó

RO Șurubelniță metalică cu percutor
FR Tournevis à choc
IT Cacciavite percussione
ES Destornillador de percusión
CN 冲击螺丝批组套

15 PCS 160 mm 1/2" 12.7 mm 5/16" 8 mm
CrV 6150 S2

32 PCS 168 mm 1/2" 12.7 mm
CrV 6150 S2



- 5/16" (7.9 mm) x 1/2" (12.7 mm);
- 4, 5, 6, 8, 9 mm (L=35 mm); S2;
- ⊕ PH1, PH2, PH3, PH4 (L=35 mm); S2;
- 4, 5, 6, 8 (L=35 mm); S2

YATO
YT-28015 16

EN Impact screwdriver
PL Wkrętkak uderowoy
DE Schlagschrauber
RU Отвёртка ударная
CZ Narazový šroubovák kovový
HU Kézi ütvecsavarhúzó

RO Șurubelniță metalică cu percutor
FR Tournevis à choc
IT Cacciavite percussione
ES Destornillador de percusión
CN 冲击螺丝批组套



- 1/2" (12.7 mm): 10, 13, 15 mm; CrV 6150;
- 0.8x5.5, 1.2x6.5, 1.2x8, 1.6x10, 2x12, 2.5x14 mm (L=35 mm); S2;
- ⊕ PH1, PH2, PH3, PH4 (L=35 mm); PH2, PH3 (L=75 mm); S2;
- ⊙ T25, T27, T30, T40, T45, T50, T55 (L=35 mm); S2;
- 4, 5, 6, 7, 8, 10, 12 mm (L=35 mm); S2;
- ⊕ #3, #4

YATO
YT-28000 10

EN Screwdriver bit set
 PL Zestaw bitów do wkrętek uderowych
 DE Schraubendreherbitsatz
 RU Набор бит крестовых
 CZ Sada bitů
 HU Bitkészlet
 RO Set biți
 FR Embouts à choc
 IT Set punte cacciavite
 ES Puntas de destornilladora
 CN 冲击批头组套



EN Screwdriver bit set
 PL Zestaw bitów do wkrętek uderowych
 DE Schraubendreherbitsatz
 RU Набор бит крестовых
 CZ Sada bitů
 HU Bitkészlet
 RO Set biți
 FR Embouts à choc
 IT Set punte cacciavite
 ES Puntas de destornilladora
 CN 冲击批头组套



YATO	⊕	L [mm]	⊖	pcs / szt.	📦
YT-2810	PH2	36	5/16" (7.9 mm)	5	10/100
YT-2811	PH3	36	5/16" (7.9 mm)	5	10/100

YATO	⊖ [mm]	⊕	L [mm]	⊖	pcs / szt.	📦
YT-2812	8, 10	PH2, PH3	36	5/16" (7.9 mm)	4	10/100

EN Screwdriver bit
 PL Końcówka śrubokrętowa
 DE Schraubendreherbit
 RU Вставка-бита
 CZ Šroubovací bit
 HU Csavarbit

RO Biți
 FR Embout de tournevis
 IT Punta per cacciavite
 ES Punta de destornillador
 CN 旋具头



YATO	⊗	L [mm]	⊖ [mm]	📦
YT-0404	T25	30	10	10/100
YT-0405	T25	75	10	10/100
YT-04051	T30	30	10	10/100
YT-04052	T30	75	10	10/100

YATO	⊗	L [mm]	⊖ [mm]	📦
YT-0406	T40	30	10	10/100
YT-0407	T40	75	10	10/100
YT-0408	T45	30	10	10/100
YT-0409	T45	75	10	10/100

EN Screwdriver bit
 PL Końcówka śrubokrętowa
 DE Schraubendreherbit
 RU Вставка-бита
 CZ Šroubovací bit
 HU Csavarbit
 RO Biți
 FR Embout de tournevis
 IT Punta per cacciavite
 ES Punta de destornillador
 CN 旋具头

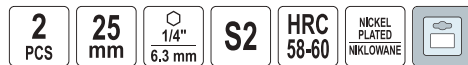

YATO	⊕	L [mm]	⊖	pcs / szt.	📦
YT-78000	PH1	25	1/4" (6.3 mm)	2	10/200
YT-78001	PH2	25	1/4" (6.3 mm)	2	10/200
YT-78002	PH3	25	1/4" (6.3 mm)	2	10/200



YATO	⊕	L [mm]	⊖	pcs / szt.	📦
YT-78003	PZ1	25	1/4" (6.3 mm)	2	10/200
YT-78004	PZ2	25	1/4" (6.3 mm)	2	10/200
YT-78005	PZ3	25	1/4" (6.3 mm)	2	10/200





YATO	⊗	L [mm]	⊖	pcs / szt.	📦
YT-78010	T8	25	1/4" (6.3 mm)	2	10/200
YT-78011	T10	25	1/4" (6.3 mm)	2	10/200
YT-78012	T15	25	1/4" (6.3 mm)	2	10/200
YT-78013	T20	25	1/4" (6.3 mm)	2	10/200
YT-78014	T25	25	1/4" (6.3 mm)	2	10/200
YT-78015	T30	25	1/4" (6.3 mm)	2	10/200
YT-78016	T40	25	1/4" (6.3 mm)	2	10/200

EN Screwdriver bit
PL Końcówka śrubokrętowa
DE Schraubendreherbit
RU Вставка-бита
CZ Šroubovací bit
HU Csavarbit
RO Bit
FR Embout de tournevis
IT Punta per cacciavite
ES Punta de destornillador
CN 旋具头





2 PCS 50 mm 1/4" (6.3 mm) S2 HRC 58-60 NICKEL PLATED NIKLOWANE 





YATO 	+	L [mm]	⬡	pcs / szt.	
YT-78020	PH1	50	1/4" (6.3 mm)	2	10/200
YT-78021	PH2	50	1/4" (6.3 mm)	2	10/200
YT-78022	PH3	50	1/4" (6.3 mm)	2	10/200



YATO 	+	L [mm]	⬡	pcs / szt.	
YT-78023	PZ1	50	1/4" (6.3 mm)	2	10/200
YT-78024	PZ2	50	1/4" (6.3 mm)	2	10/200
YT-78025	PZ3	50	1/4" (6.3 mm)	2	10/200





YATO 	⊗	L [mm]	⬡	pcs / szt.	
YT-78030	T8	50	1/4" (6.3 mm)	2	10/200
YT-78031	T10	50	1/4" (6.3 mm)	2	10/200
YT-78032	T15	50	1/4" (6.3 mm)	2	10/200
YT-78033	T20	50	1/4" (6.3 mm)	2	10/200
YT-78034	T25	50	1/4" (6.3 mm)	2	10/200
YT-78035	T30	50	1/4" (6.3 mm)	2	10/200
YT-78036	T40	50	1/4" (6.3 mm)	2	10/200

EN Screwdriver bit
PL Końcówka śrubokrętowa
DE Schraubendreherbit
RU Вставка-бита
CZ Šroubovací bit
HU Csavarbit
RO Bit
FR Embout de tournevis
IT Punta per cacciavite
ES Punta de destornillador
CN 旋具头





2 PCS 50 mm 1/4" (6.3 mm) S2 HRC 58-60 





YATO 	+	L [mm]	⬡	pcs / szt.	
YT-78040	PH1	50	1/4" (6.3 mm)	2	10/200
YT-78041	PH2	50	1/4" (6.3 mm)	2	10/200
YT-78042	PH3	50	1/4" (6.3 mm)	2	10/200



YATO 	+	L [mm]	⬡	pcs / szt.	
YT-78043	PZ1	50	1/4" (6.3 mm)	2	10/200
YT-78044	PZ2	50	1/4" (6.3 mm)	2	10/200
YT-78045	PZ3	50	1/4" (6.3 mm)	2	10/200



YATO 	⊗	L [mm]	⬡	pcs / szt.	
YT-78050	T8	50	1/4" (6.3 mm)	2	10/200
YT-78051	T10	50	1/4" (6.3 mm)	2	10/200
YT-78052	T15	50	1/4" (6.3 mm)	2	10/200
YT-78053	T20	50	1/4" (6.3 mm)	2	10/200
YT-78054	T25	50	1/4" (6.3 mm)	2	10/200
YT-78055	T27	50	1/4" (6.3 mm)	2	10/200
YT-78056	T30	50	1/4" (6.3 mm)	2	10/200
YT-78057	T40	50	1/4" (6.3 mm)	2	10/200

EN Screwdriver bit
 PL Końcówka śrubokrętowa
 DE Schraubendreherbit
 RU Вставка-бита
 CZ Šroubovací bit
 HU Csavarbit
 RO Biji
 IT Punta per cacciavite
 ES Punta de destornillador
 CN 旋具头

⊕ 21.8 Nm (max.) HRC 58-62 AISI S2 COLD FORGED KUTE NA ZIMNO



YATO	⊕	L [mm]	⊖	📦
YT-0485	PH2	100	1/4" (6.3 mm)	25/100
YT-0486	PH2	150	1/4" (6.3 mm)	25/100
YT-0487	PH2	200	1/4" (6.3 mm)	25/100



EN Screwdriver bit
 PL Końcówka śrubokrętowa
 DE Schraubendreherbit
 RU Вставка-бита
 CZ Šroubovací bit
 HU Csavarbit
 RO Biji
 FR Embout de tournevis
 IT Punta per cacciavite
 ES Punta de destornillador
 CN 旋具头

10 PCS ⊕ 1/4" 6.3 mm HRC 58-61 AISI S2 COLD FORGED KUTE NA ZIMNO

EN Screwdriver bit
 PL Końcówka śrubokrętowa
 DE Schraubendreherbit
 RU Вставка-бита
 CZ Šroubovací bit
 HU Csavarbit
 RO Biji
 FR Embout de tournevis
 IT Punta per cacciavite
 ES Punta de destornillador
 CN 旋具头

10 PCS ⊕ 1/4" 6.3 mm HRC 58-61 AISI S2 COLD FORGED KUTE NA ZIMNO



YATO	⊕	L [mm]	⊖	[Nm]	pcs / szt.	📦
YT-04702	PZ1	25	1/4" (6.3 mm)	6.4	10	25/200
YT-04712	PZ2	25	1/4" (6.3 mm)	19.6	10	25/200
YT-04722	PZ3	25	1/4" (6.3 mm)	45.1	10	25/200

YATO	⊕	L [mm]	⊖	[Nm]	pcs / szt.	📦
YT-04742	PH1	25	1/4" (6.3 mm)	6.4	10	25/200
YT-04752	PH2	25	1/4" (6.3 mm)	19.6	10	25/200
YT-04762	PH3	25	1/4" (6.3 mm)	45.1	10	25/200

EN Screwdriver bit
 PL Końcówka śrubokrętowa
 DE Schraubendreherbit
 RU Вставка-бита
 CZ Šroubovací bit
 HU Csavarbit
 RO Biji
 FR Embout de tournevis
 IT Punta per cacciavite
 ES Punta de destornillador
 CN 旋具头

10 PCS ⊕ 1/4" 6.3 mm HRC 58-61 AISI S2 COLD FORGED KUTE NA ZIMNO



YATO	⊕	L [mm]	⊖	[Nm]	pcs / szt.	📦
YT-04772	PH1	50	1/4" (6.3 mm)	6.4	10	25/100
YT-04782	PH2	50	1/4" (6.3 mm)	19.6	10	25/100
YT-04792	PH3	50	1/4" (6.3 mm)	45.1	10	25/100

EN Screwdriver bit
 PL Końcówka śrubokrętowa
 DE Schraubendreherbit
 RU Вставка-бита
 CZ Šroubovací bit
 HU Csavarbit
 RO Biji
 FR Embout de tournevis
 IT Punta per cacciavite
 ES Punta de destornillador
 CN 旋具头

10 PCS ⊕ PH2xPH2 x65mm 1/4" 6.3 mm 19.6 Nm (max.) HRC 58-61 AISI S2 COLD FORGED KUTE NA ZIMNO



YATO	⊕	L [mm]	⊖	[Nm]	pcs / szt.	📦
YT-04812	PH2xPH2	65	1/4" (6.3 mm)	19.6 / 19.6	10	25/100

EN Screwdriver bit set
PL Zestaw końcówek śrubokrętowych
DE Schraubendreherbitsatz
RU Набор битов
CZ Sada šroubovacích bitů
HU Csavarbit készlet
RO Set biți
FR Jeu d'embouts de tournevis
IT Set punte per cacciavite
ES Juego de puntas para atornillar
CN 旋具头组套

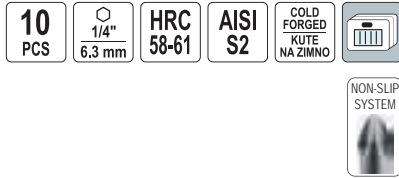

□ 5, 6 mm;
⊕ PH1, PH1, PH2, PH2;
⊕ PZ1, PZ1, PZ2, PZ2

YATO	L [mm]	□	pcs / szt.	📦
YT-04822	25	1/4" (6.3 mm)	10	25/200

EN Screwdriver bit
PL Końcówka śrubokrętowa
DE Schraubendreherbit
RU Вставка-бита
CZ Šroubovací bit
HU Csavarbit
RO Biți
FR Embout de tournevis
IT Punta per cacciavite
ES Punta de destornillador
CN 旋具头



EN Screwdriver bit
PL Końcówka śrubokrętowa
DE Schraubendreherbit
RU Вставка-бита
CZ Šroubovací bit
HU Csavarbit
RO Biți
FR Embout de tournevis
IT Punta per cacciavite
ES Punta de destornillador
CN 旋具头



EN Screwdriver bit set
PL Zestaw końcówek śrubokrętowych
DE Schraubendreherbitsatz
RU Набор битов
CZ Sada šroubovacích bitů
HU Csavarbit készlet
RO Set biți
FR Jeu d'embouts de tournevis
IT Set punte per cacciavite
ES Juego de puntas para atornillar
CN 旋具头组套

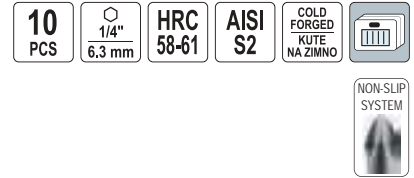

□ 5, 6 mm;
⊕ PH1, PH1, PH2, PH2;
⊕ PZ1, PZ1, PZ2, PZ2

YATO	L [mm]	□	pcs / szt.	📦
YT-04832	50	1/4" (6.3 mm)	10	25/100



YATO	⊕	L [mm]	□	[Nm]	pcs / szt.	📦
YT-78130	PH0	25	1/4" (6.3 mm)	2.1	10	20/100
YT-78131	PH1	25	1/4" (6.3 mm)	7.8	10	20/100
YT-78132	PH2	25	1/4" (6.3 mm)	19.6	10	20/100
YT-78133	PH3	25	1/4" (6.3 mm)	45.6	10	20/100



YATO	⊕	L [mm]	□	[Nm]	pcs / szt.	📦
YT-78134	PZ1	25	1/4" (6.3 mm)	6.4	10	20/100
YT-78135	PZ2	25	1/4" (6.3 mm)	19.6	10	20/100
YT-78136	PZ3	25	1/4" (6.3 mm)	45.1	10	20/100



YATO	⊕	L [mm]	□	[Nm]	pcs / szt.	📦
YT-78141	T10	25	1/4" (6.3 mm)	5.9	10	20/100
YT-78142	T15	25	1/4" (6.3 mm)	8.4	10	20/100
YT-78143	T20	25	1/4" (6.3 mm)	14.7	10	20/100
YT-78144	T25	25	1/4" (6.3 mm)	21.6	10	20/100
YT-78145	T27	25	1/4" (6.3 mm)	29.4	10	20/100
YT-78146	T30	25	1/4" (6.3 mm)	45.1	10	20/100
YT-78147	T40	25	1/4" (6.3 mm)	76.5	10	20/100



YATO	⊕	L [mm]	□	[Nm]	pcs / szt.	📦
YT-78151	PH1	50	1/4" (6.3 mm)	6.4	10	20/100
YT-78152	PH2	50	1/4" (6.3 mm)	19.6	10	20/100
YT-78153	PH3	50	1/4" (6.3 mm)	45.1	10	20/100



YATO	⊕	L [mm]	□	[Nm]	pcs / szt.	📦
YT-78154	PZ1	50	1/4" (6.3 mm)	6.4	10	20/100
YT-78155	PZ2	50	1/4" (6.3 mm)	19.6	10	20/100
YT-78156	PZ3	50	1/4" (6.3 mm)	45.1	10	20/100

EN Screwdriver bit set
 PL Zestaw końcówek śrubokrętowych
 DE Schraubendreherbitsatz
 RU Набор битов

CZ Sada šroubovacích bitů
 HU Csavarbit készlet
 RO Set biți
 FR Jeu d'embouts de tournevis

IT Set punte per cacciavite
 ES Juego de puntas para atornillar
 CN 旋具头组套



10 PCS 1/4" 6.3 mm 21.8 Nm (max.) HRC 58-62 AISI S2 COLD FORGED KŮTE NA ZIMNO



YATO	⊕	L [mm]	⊖	📦
YT-0470	PZ1	25	1/4" (6.3 mm)	25/200
YT-0471	PZ2	25	1/4" (6.3 mm)	25/200
YT-0472	PZ3	25	1/4" (6.3 mm)	25/200

YATO	⊕	L [mm]	⊖	📦
YT-0477	PH1	50	1/4" (6.3 mm)	25/100
YT-0478	PH2	50	1/4" (6.3 mm)	25/100
YT-0480	PH2	75	1/4" (6.3 mm)	25/100



YATO	⊕	L [mm]	⊖	📦
YT-0474	PH1	25	1/4" (6.3 mm)	25/200
YT-0475	PH2	25	1/4" (6.3 mm)	25/200
YT-0476	PH3	25	1/4" (6.3 mm)	25/200

YATO	⊕	L [mm]	⊖	📦
YT-0481	PH2xPH2	65	1/4" (6.3 mm)	25/100

EN Screwdriver bit set
 PL Zestaw końcówek śrubokrętowych
 DE Schraubendreherbitsatz
 RU Набор битов

CZ Sada šroubovacích bitů
 HU Csavarbit készlet
 RO Set biți
 FR Jeu d'embouts de tournevis

IT Set punte per cacciavite
 ES Juego de puntas para atornillar
 CN 旋具头组套



10 PCS 1/4" 6.3 mm 21.8 Nm (max.) HRC 58-62 AISI S2 COLD FORGED KŮTE NA ZIMNO



1/4" (6.3 mm); 5, 6 mm (L=25 mm); AISI S2;
 1/4" (6.3 mm); PH1 x2, PH2 x2 (L=25 mm); AISI S2;
 1/4" (6.3 mm); PZ1 x2, PZ2 x2 (L=25 mm); AISI S2



1/4" (6.3 mm); 5, 6 mm (L=50 mm); AISI S2;
 1/4" (6.3 mm); PH1 x2, PH2 x2 (L=50 mm); AISI S2;
 1/4" (6.3 mm); PZ1 x2, PZ2 x2 (L=50 mm); AISI S2

YATO	L [mm]	⊖	📦
YT-0482	25	1/4" (6.3 mm)	25/200

YATO	L [mm]	⊖	📦
YT-0483	25	1/4" (6.3 mm)	25/100

EN Screwdriver bit
 PL Końcówka śrubokrętowa
 DE Schraubendreherbit

RU Вставка-бита
 CZ Šroubovací bit
 HU Csavarbit

RO Biți
 FR Embout de tournevis
 IT Punta per cacciavite

ES Punta de destornillador
 CN 旋具头



1/4" 6.3 mm HRC 58-62 AISI S2 COLD FORGED KŮTE NA ZIMNO



YATO	⊕	L [mm]	⊖	pcs / szt.	📦
YT-7807	PH1	25	1/4" (6.3 mm)	50	20/40
YT-7808	PH2	25	1/4" (6.3 mm)	50	20/40
YT-7809	PH3	25	1/4" (6.3 mm)	50	20/40

YATO	⊕	L [mm]	⊖	pcs / szt.	📦
YT-7810	PZ1	25	1/4" (6.3 mm)	50	20/40
YT-7811	PZ2	25	1/4" (6.3 mm)	50	20/40
YT-7812	PZ3	25	1/4" (6.3 mm)	50	20/40

EN Screwdriver bit
 PL Końcówka śrubokrętowa
 DE Schraubendreherbit
 RU Вставка-бита
 CZ Šroubovací bit
 HU Csavarbit
 RO Biți pt. rigips
 FR Embout de tournevis
 IT Punta per cacciavite
 ES Punta de destornillador
 CN 旋具头



20 PCS 1/4" 6.3 mm 25 mm

• With limiter
 • Z ogranicznikiem

YATO	L [mm]	⊖	pcs / szt.	📦
YT-7980	25	1/4" (6.3 mm)	20	20/40

EN Screwdriver bit
PL Końcówka śrubokrętowa
DE Schraubendreherbit
RU Вставка-бита
CZ Šroubováč bit
HU Csavarbit
RO Biji
FR Embout de tournevis
IT Punta per cacciavite
ES Punta de destornillador
CN 旋具头

2 PCS
1/4"
6.3 mm
S2



Technical drawing showing dimensions: 100 mm length, 5 mm diameter, 6 mm diameter, and 1/4" (6.3 mm) width.

YATO	Symbol	L [mm]	Width [mm]	Pcs
YT-0484	⊖	100	1/4" (6.3 mm)	25/100

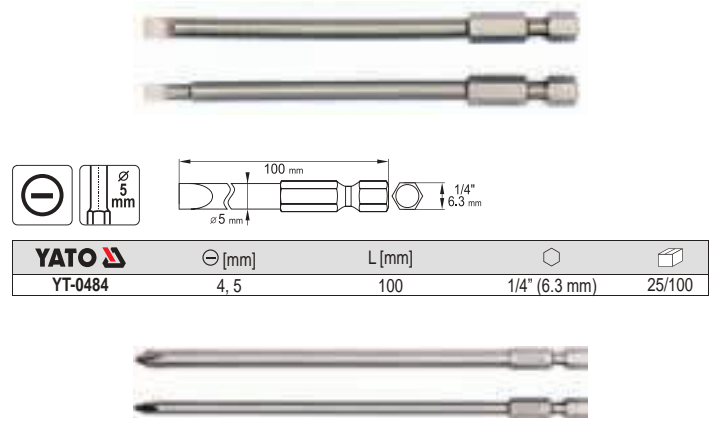

Technical drawing showing dimensions: 150 mm length, 5 mm diameter, 6 mm diameter, and 1/4" (6.3 mm) width.

YATO	Symbol	L [mm]	Width [mm]	Pcs
YT-0488	⊕	100	1/4" (6.3 mm)	25/100
YT-0489	⊕	150	1/4" (6.3 mm)	25/100

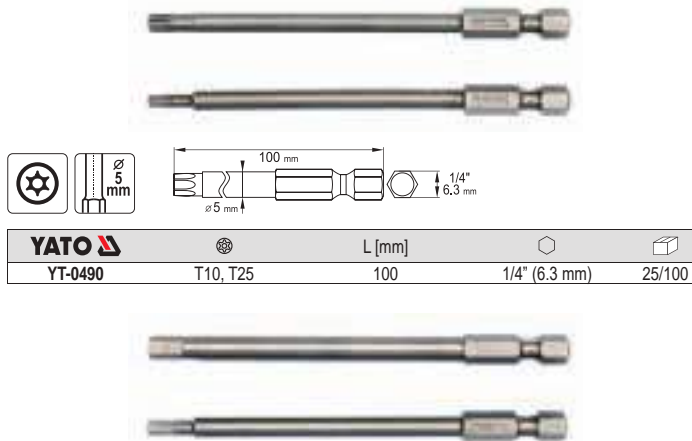

Technical drawing showing dimensions: 100 mm length, 5 mm diameter, 6 mm diameter, and 1/4" (6.3 mm) width.

YATO	Symbol	L [mm]	Width [mm]	Pcs
YT-0490	⊗	100	1/4" (6.3 mm)	25/100



Technical drawing showing dimensions: 100 mm length, 5 mm diameter, 6 mm diameter, and 1/4" (6.3 mm) width.

YATO	Symbol	L [mm]	Width [mm]	Pcs
YT-0491	⊗	100	1/4" (6.3 mm)	25/100
YT-0492	⊗	100	1/4" (6.3 mm)	25/100

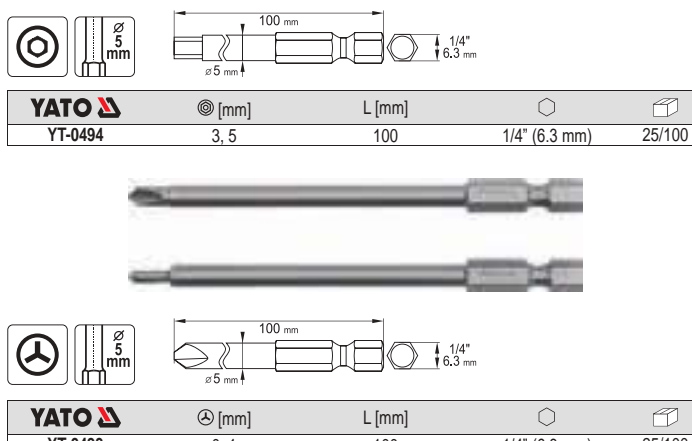

Technical drawing showing dimensions: 100 mm length, 5 mm diameter, 6 mm diameter, and 1/4" (6.3 mm) width.

YATO	Symbol	L [mm]	Width [mm]	Pcs
YT-0494	⊙	100	1/4" (6.3 mm)	25/100

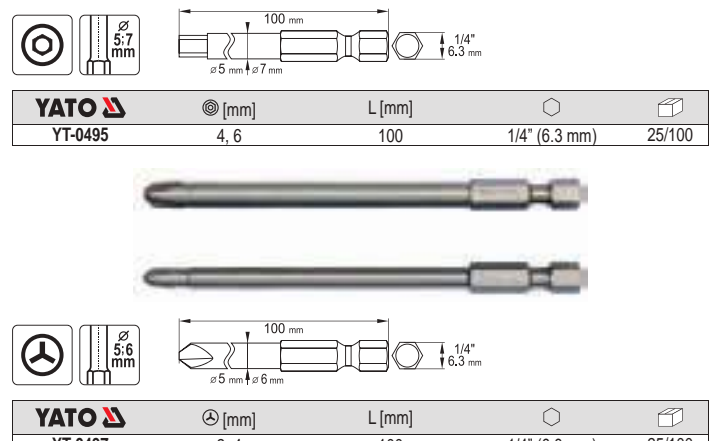

Technical drawing showing dimensions: 100 mm length, 5 mm diameter, 6 mm diameter, and 1/4" (6.3 mm) width.

YATO	Symbol	L [mm]	Width [mm]	Pcs
YT-0495	⊙	100	1/4" (6.3 mm)	25/100

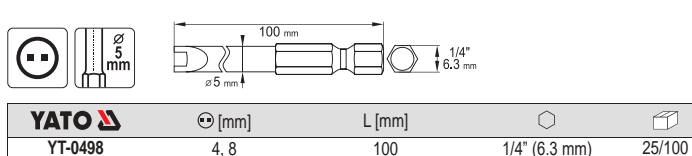

Technical drawing showing dimensions: 100 mm length, 5 mm diameter, 6 mm diameter, and 1/4" (6.3 mm) width.

YATO	Symbol	L [mm]	Width [mm]	Pcs
YT-0493	⊗	100	1/4" (6.3 mm)	25/100
YT-0496	⊗	100	1/4" (6.3 mm)	25/100

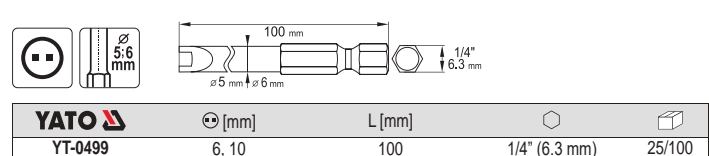

Technical drawing showing dimensions: 100 mm length, 5 mm diameter, 6 mm diameter, and 1/4" (6.3 mm) width.

YATO	Symbol	L [mm]	Width [mm]	Pcs
YT-0497	⊗	100	1/4" (6.3 mm)	25/100
YT-0498	⊕	100	1/4" (6.3 mm)	25/100
YT-0499	⊕	100	1/4" (6.3 mm)	25/100

5

EN Screwdriver bit set
 PL Zestaw końcówek śrubokrętowych
 DE Schraubendreherbitsatz
 RU Набор битов
 CZ Sada šroubovacích bitů
 HU Csavarbit készlet

RO Set biți
 FR Jeu d'embouts de tournevis
 IT Set punte per cacciavite
 ES Juego de puntas para atornillar
 CN 旋具头组套

40
PCS













21.8
Nm
(max.)

HRC
58-62

AISI
S2



  3/8" (9.5 mm): T20, T25, T30, T40, T45, T50, T55 (L=30 mm); T20, T25, T30, T40, T45, T50, T55 (L=75 mm); AISI S2;
  3/8" (9.5 mm): 4, 5, 6, 7, 8, 10, 12 mm (L=30 mm); 4, 5, 6, 7, 8, 10, 12 mm (L=75 mm); AISI S2;
  3/8" (9.5 mm): M5, M6, M8, M10, M12 (L=30 mm); M5, M6, M8, M10, M12 (L=75 mm); AISI S2;
 1/2" (12.7 mm) x 3/8" (9.5 mm), 3/8" (9.5 mm) x 3/8" (9.5 mm); CrV 6150

YATO 

YT-0400  10

EN Screwdriver bit set
 PL Zestaw końcówek śrubokrętowych
 DE Schraubendreherbitsatz
 RU Набор битов
 CZ Sada šroubovacích bitů
 HU Csavarbit készlet

RO Set biți
 FR Jeu d'embouts de tournevis
 IT Set punte per cacciavite
 ES Juego de puntas para atornillar
 CN 旋具头组套

7
PCS







21.8
Nm
(max.)

HRC
58-62

AISI
S2



  3/8" (9.5 mm): T25, T30, T40, T45, T50, T55 (L=30 mm); AISI S2;
 1/2" (12.7 mm) x 3/8" (9.5 mm); CrV 6150

YATO 

YT-0410  24/72

EN Screwdriver bit set
 PL Zestaw końcówek śrubokrętowych
 DE Schraubendreherbitsatz
 RU Набор битов
 CZ Sada šroubovacích bitů
 HU Csavarbit készlet

RO Set biți
 FR Jeu d'embouts de tournevis
 IT Set punte per cacciavite
 ES Juego de puntas para atornillar
 CN 旋具头组套

15
PCS







21.8
Nm
(max.)

HRC
58-62

AISI
S2



  3/8" (9.5 mm): T20, T25, T30, T40, T45, T50, T55 (L=30 mm); T20, T25, T30, T40, T45, T50, T55 (L=75 mm); AISI S2;
 1/2" (12.7 mm) x 3/8" (9.5 mm); CrV 6150

YATO 

YT-0411  20

EN Screwdriver bit set
 PL Zestaw końcówek śrubokrętowych
 DE Schraubendreherbitsatz
 RU Набор битов
 CZ Sada šroubovacích bitů
 HU Csavarbit készlet

RO Set biți
 FR Jeu d'embouts de tournevis
 IT Set punte per cacciavite
 ES Juego de puntas para atornillar
 CN 旋具头组套

7
PCS







21.8
Nm
(max.)

HRC
58-62

AISI
S2



  3/8" (9.5 mm): 4, 5, 6, 8, 10, 12 mm (L=30 mm); AISI S2;
 1/2" (12.7 mm) x 3/8" (9.5 mm); CrV 6150

YATO 

YT-0412  24/72

EN Screwdriver bit set
 PL Zestaw końcówek śrubokrętowych
 DE Schraubendreherbitsatz
 RU Набор битов
 CZ Sada šroubovacích bitů
 HU Csavarbit készlet

RO Set biți
 FR Jeu d'embouts de tournevis
 IT Set punte per cacciavite
 ES Juego de puntas para atornillar
 CN 旋具头组套

15
PCS







21.8
Nm
(max.)

HRC
58-62

AISI
S2



  3/8" (9.5 mm): 4, 5, 6, 7, 8, 10, 12 (L=30 mm); 4, 5, 6, 7, 8, 10, 12 (L=75 mm); AISI S2;
 1/2" (12.7 mm) x 3/8" (9.5 mm); CrV 6150

YATO 

YT-0413  20

EN Screwdriver bit set
 PL Zestaw końcówek śrubokrętowych
 DE Schraubendreherbitsatz
 RU Набор битов
 CZ Sada šroubovacích bitů
 HU Csavarbit készlet

RO Set biți
 FR Jeu d'embouts de tournevis
 IT Set punte per cacciavite
 ES Juego de puntas para atornillar
 CN 旋具头组套

6
PCS







21.8
Nm
(max.)

HRC
58-62

AISI
S2



  3/8" (9.5 mm): M5, M6, M8, M10, M12 (L=30 mm); AISI S2;
 1/2" (12.7 mm) x 3/8" (9.5 mm); CrV 6150

YATO 

YT-0414  24/72

EN Screwdriver bit set
PL Zestaw końcówek śrubokrętowych
DE Schraubendreherbitsatz
RU Набор битов
CZ Sada šroubovacích bitů
HU Csavarbit készlet

RO Set biți
FR Jeu d'embouts de tournevis
IT Set punte per cacciavite
ES Juego de puntas para atornillar
CN 旋具头组套

11
PCS



21.8
Nm
(max.)

HRC
58-62

AISI
S2



3/8" (9.5 mm); M5, M6, M8, M10, M12 (L=30 mm); M5, M6, M8, M10, M12 (L=75 mm); AISI S2;
1/2" (12.7 mm) x 3/8" (9.5 mm); CrV 6150

YATO
YT-0415 20

EN Screwdriver bit set
PL Zestaw końcówek śrubokrętowych
DE Schraubendreherbitsatz
RU Набор битов
CZ Sada šroubovacích bitů
HU Csavarbit készlet

RO Set biți
FR Jeu d'embouts de tournevis
IT Set punte per cacciavite
ES Juego de puntas para atornillar
CN 旋具头组套

15
PCS



21.8
Nm
(max.)

HRC
58-62

AISI
S2



3/8" (9.5 mm); T20, T25, T30, T40, T45, T50, T55 (L=30 mm);
T20, T25, T30, T40, T45, T50, T55 (L=75 mm); AISI S2;
1/2" (12.7 mm) x 3/8" (9.5 mm); CrV 6150

YATO
YT-0417 20

EN Screwdriver bit set
PL Zestaw końcówek śrubokrętowych
DE Schraubendreherbitsatz
RU Набор битов
CZ Sada šroubovacích bitů
HU Csavarbit készlet

RO Set biți
FR Jeu d'embouts de tournevis
IT Set punte per cacciavite
ES Juego de puntas para atornillar
CN 旋具头组套

15
PCS



21.8
Nm
(max.)

HRC
58-62

AISI
S2



3/8" (9.5 mm); M6, M7, M8, M9, M10, M12, M14 (L=30 mm);
M6, M7, M8, M9, M10, M12, M14 (L=75 mm); AISI S2;
1/2" (12.7 mm) x 3/8" (9.5 mm); CrV 6150

YATO
YT-0419 20

EN Screwdriver bit set
PL Zestaw końcówek śrubokrętowych
DE Schraubendreherbitsatz
RU Набор битов
CZ Sada šroubovacích bitů
HU Csavarbit készlet

RO Set biți
FR Jeu d'embouts de tournevis
IT Set punte per cacciavite
ES Juego de puntas para atornillar
CN 旋具头组套

7
PCS



21.8
Nm
(max.)

HRC
58-62

AISI
S2



3/8" (9.5 mm); T25, T30, T40, T45, T50, T55 (L=30 mm); AISI S2;
1/2" (12.7 mm) x 3/8" (9.5 mm); CrV 6150

YATO
YT-0416 24/72

EN Screwdriver bit set
PL Zestaw końcówek śrubokrętowych
DE Schraubendreherbitsatz
RU Набор битов
CZ Sada šroubovacích bitů
HU Csavarbit készlet

RO Set biți
FR Jeu d'embouts de tournevis
IT Set punte per cacciavite
ES Juego de puntas para atornillar
CN 旋具头组套

8
PCS



21.8
Nm
(max.)

HRC
58-62

AISI
S2



3/8" (9.5 mm); M5, M6, M7, M8, M10, M12, M14 (L=30 mm); AISI S2;
1/2" (12.7 mm) x 3/8" (9.5 mm); CrV 6150

YATO
YT-0418 24/72

EN Screwdriver bit set
PL Zestaw końcówek śrubokrętowych
DE Schraubendreherbitsatz
RU Набор битов
CZ Sada šroubovacích bitů
HU Csavarbit készlet

RO Set biți
FR Jeu d'embouts de tournevis
IT Set punte per cacciavite
ES Juego de puntas para atornillar
CN 旋具头组套

42
PCS



21.8
Nm
(max.)

HRC
58-62

AISI
S2



3/8" (9.5 mm); T20, T25, T30, T40, T45, T50, T55, T60, T70 (L=30 mm);
T20, T25, T30, T40, T45, T50, T55, T60, T70 (L=75 mm); AISI S2;
3/8" (9.5 mm); M4, M5, M6, M7, M8, M9, M10, M11, M12, M13, M14 (L=30 mm);
M4, M5, M6, M7, M8, M9, M10, M11, M12, M13, M14 (L=75 mm); AISI S2;
1/2" (12.7 mm) x 3/8" (9.5 mm), 3/8" (9.5 mm) x 3/8" (9.5 mm); CrV 6150

YATO
YT-0420 10

EN Screwdriver bit set
 PL Zestaw końcówek śrubokrętowych
 DE Schraubendreherbitsatz
 RU Набор битов

CZ Sada šroubovacích bitů
 HU Csavarbit készlet
 RO Set biți
 FR Jeu d'embouts de tournevis

IT Set punte per cacciavite
 ES Juego de puntas para atornillar
 CN 旋具头组套



23 PCS 1/4" 6.3mm

S2

- PH 1/4" (6.3 mm): PH0, PH2 x2, PH3 (L=25 mm); PH2 (L=50 mm); S2;
- PZ 1/4" (6.3 mm): PZ0, PZ2 x2, PZ3 (L=25 mm); PZ2 (L=50 mm); S2;
- T 1/4" (6.3 mm): T20 x2, T25 x2, T30 x2, T40 (L=25 mm); T20, T30 (L=50 mm); S2;
- CRV 1/4" (6.3 mm): 4, 5, 6 mm (L=25 mm); S2;
- CRV 1/4" (6.3 mm); (L=60 mm); CrV

YATO YT-04621 20

EN Screwdriver bit set
 PL Zestaw końcówek śrubokrętowych
 DE Schraubendreherbitsatz
 RU Набор битов

CZ Sada šroubovacích bitů
 HU Csavarbit készlet
 RO Set biți
 FR Jeu d'embouts de tournevis

IT Set punte per cacciavite
 ES Juego de puntas para atornillar
 CN 旋具头组套



32 PCS 1/4" 6.3mm

S2

- PH 1/4" (6.3 mm): 3, 4, 5, 6 mm (L=25 mm); S2;
- PH 1/4" (6.3 mm): PH1, PH2 x2, PH3 (L=25 mm); S2;
- PZ 1/4" (6.3 mm): PZ1, PZ2 x2, PZ3 (L=25 mm); S2;
- T 1/4" (6.3 mm): T10, T15, T20, T25, T27, T30, T40 (L=25 mm); S2;
- T 1/4" (6.3 mm): T10, T15, T20, T25, T27, T30, T40 (L=25 mm); S2;
- CRV 1/4" (6.3 mm): 3, 4, 5, 6 mm (L=25 mm); S2;
- CRV 1/4" (6.3 mm); (L=70 mm); CrV;
- CRV 1/4" (6.3 mm); (L=25 mm); S2

YATO YT-04622 20

EN Screwdriver bit set
 PL Zestaw końcówek śrubokrętowych
 DE Schraubendreherbitsatz
 RU Набор битов

CZ Sada šroubovacích bitů
 HU Csavarbit készlet
 RO Set biți
 FR Jeu d'embouts de tournevis

IT Set punte per cacciavite
 ES Juego de puntas para atornillar
 CN 旋具头组套



34 PCS 1/4" 6.3mm

S2

- PH 1/4" (6.3 mm): 5, 6, 7, 8, 9, 10, 11, 12 mm (L=25 mm);
- PH 1/4" (6.3 mm); (L=75 mm);
- PH 1/4" (6.3 mm): 3, 4, 5.5 x2, 6.5 x2 mm (L=25 mm); S2;
- PH 1/4" (6.3 mm): PH1 x2, PH2 x2, PH3 x2 (L=25 mm); S2;
- PZ 1/4" (6.3 mm): PZ1 x2, PZ2 x2, PZ3 x2 (L=25 mm); S2;
- T 1/4" (6.3 mm): T10, T15, T20, T25, T27, T30 (L=25 mm); S2;
- CRV 1/4" (6.3 mm); (L=60 mm); CrV

YATO YT-04623 20

EN Screwdriver bit set
 PL Zestaw końcówek śrubokrętowych
 DE Schraubendreherbitsatz
 RU Набор битов
 CZ Sada šroubovacích bitů
 HU Csavarbit készlet

RO Set biți
 FR Jeu d'embouts de tournevis
 IT Set punte per cacciavite
 ES Juego de puntas para atornillar
 CN 旋具头组套



45 PCS 1/4" 6.3mm

S2

- PH 1/4" (6.3 mm): 3, 4, 5, 6, 7 mm (L=25 mm); S2;
- PH 1/4" (6.3 mm): PH0, PH1, PH2, PH3 (L=25 mm); PH1, PH2 (L=50 mm); S2;
- PZ 1/4" (6.3 mm): PZ0, PZ1, PZ2, PZ3 (L=25 mm); PZ1, PZ2 (L=50 mm); S2;
- T 1/4" (6.3 mm): T8, T10, T15, T20, T25, T27, T30, T40 (L=25 mm); S2;
- CRV 1/4" (6.3 mm): 2, 2.5, 3, 4, 5, 5.5, 6 x2 mm (L=25 mm); S2;
- CRV 1/4" (6.3 mm): S1, S2, S3 (L=25 mm); S2;
- PH 1/4" (6.3 mm): 5 mm x PH1, 6 mm x PH2, 6 mm x PH3 (L=65 mm); S2;
- PH 1/4" (6.3 mm): PH2 x PH2, PH2 x PH3 (L=65 mm); S2;
- PZ 1/4" (6.3 mm): PZ1 x PZ1, PZ2 x PZ2, PZ3 x PZ3 (L=65 mm); S2;
- CRV 1/4" (6.3 mm); (L=60 mm); S2

YATO YT-04620 20

EN Screwdriver bit set
PL Zestaw końcówek śrubokrętowych
DE Schraubendreherbitsatz
RU Набор битов

CZ Sada šroubovacích bitů
HU Csavarbit készlet
RO Set biți
FR Jeu d'embouts de tournevis

IT Set punte per cacciavite
ES Juego de puntas para atomillar
CN 旋具头组套

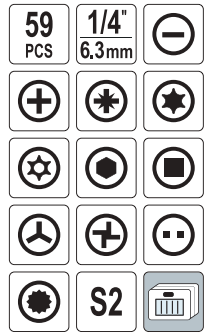

- ▯ 1/4" (6.3 mm): 2, 4, 6, 5 mm (L=25 mm); S2;
- ✦ 1/4" (6.3 mm): PH0, PH1 x2, PH2 x2, PH3 (L=25 mm); S2;
- ✦ 1/4" (6.3 mm): PZ1 x2, PZ2 x2, PZ3 (L=25 mm); S2;
- ✦ 1/4" (6.3 mm): T10, T15, T20, T25, T30, T40 (L=25 mm); S2;
- ✦ 1/4" (6.3 mm): T8, T9, T10, T15, T20, T25, T27, T30, T40 (L=25 mm); S2;
- 1/4" (6.3 mm): 2, 2.5, 3, 4, 5, 6, 8 mm (L=25 mm); S2;
- 1/4" (6.3 mm): 0, 1, 2, 3 mm (L=25 mm); S2;
- ✦ 1/4" (6.3 mm): 1, 2, 3, 4 mm (L=25 mm); S2;
- ✦ 1/4" (6.3 mm): 6, 8, 10 mm (L=25 mm); S2;
- ⋮ 1/4" (6.3 mm): 4, 6, 8, 10 mm (L=25 mm); S2;
- 1/4" (6.3 mm): M5, M6, M8 (L=25 mm); S2;
- ⌘ 1/4" (6.3 mm): C1, C2, C3 (L=25 mm); S2;
- ▯ 1/4" (6.3 mm): (L=70 mm); CrV;
- ◁ 1/4" (6.3 mm); CrV

YATO	
YT-04624	20

EN Nut setter
PL Nasadka magnetyczna do wkrętarki
DE Magnet-Steckschlüssel mit Adapter
RU Магнитная головка для винтовёрта
CZ Nástrčný kľúč magnetický do vrtačky
HU Csavarbehajtó
RO Cheie tubulara cu prindere tip mandrina
FR Douille tournevis magnétique
IT Cappuccio magnetico la vite
ES Boquilla magnética de destornilladora
CN 磁性套筒

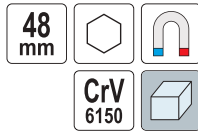

YATO	ø [mm]	
YT-1501	6	200/600
YT-1502	7	200/600
YT-1503	8	200/600
YT-1505	10	200/600
YT-1507	12	200/600
YT-1508	13	200/600

EN Nut setter
PL Nasadka magnetyczna do wkrętarki
DE Magnet-Steckschlüssel mit Adapter
RU Магнитная головка для винтовёрта
CZ Nástrčný kľúč magnetický do vrtačky
HU Csavarbehajtó
RO Cheie tubulara cu prindere tip mandrina
FR Douille tournevis magnétique
IT Cappuccio magnetico la vite
ES Boquilla magnética de destornilladora
CN 磁性套筒

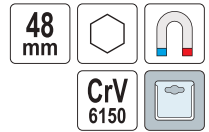

YATO	ø [mm]	
YT-1511	6	100/200
YT-1512	7	100/200
YT-1513	8	100/200
YT-1515	10	100/200
YT-1517	12	100/200
YT-1518	13	100/200

EN Screwdriver bit holder
PL Uchwyt do końcówek śrubokrętowych
DE Bithalter

RU Адаптер для бит
CZ Držák bitů
HU Bit befogó

RO Adaptor biți
FR Porte-embout
IT Portapunte

ES Soporte para puntas
CN 螺丝批头接杆

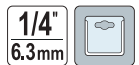

YATO	ø [mm]	L [mm]	
YT-0465	1/4" (6.3 mm)	60	20/200

YATO	ø [mm]	L [mm]	
YT-0466	1/4" (6.3 mm)	60	20/200

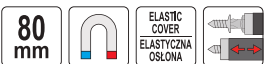

YATO	ø [mm]	L [mm]	
YT-0467	1/4" (6.3 mm)	80	20/200

YATO	ø [mm]	L [mm]	
YT-04671	1/4" (6.3 mm)	120	100

EN Screwdriver bit holder
 PL Uchwyt do końcówek śrubokrętowych
 DE Bithalter
 RU Адаптер для бит
 CZ Držák bitů
 HU Bit befogó
 RO Adaptor biți
 FR Porte-embout
 IT Portapunte
 ES Soplete para puntas
 CN 螺丝批头接杆

1/4"
6.3 mm

60 mm

QUICK RELEASE SZYBKO-ZŁĄCZE

SS
STAINLESS STEEL STAŁA NIERDZEWNA



YATO		L [mm]	
YT-0468	1/4" (6.3 mm)	60	20/200

EN Screwdriver bit holder
 PL Uchwyt do końcówek śrubokrętowych
 DE Bithalter
 RU Адаптер для бит
 CZ Držák bitů
 HU Bit befogó
 RO Adaptor biți
 FR Porte-embout
 IT Portapunte
 ES Soplete para puntas
 CN 螺丝批头接杆

1/4"
6.3 mm

150 mm

CrV



YATO		L [mm]	
YT-04695	1/4" (6.3 mm)	150	100

EN Swivel bit holder
 PL Adapter kątowy do bitów
 DE Gelenk-Bit-Adapter
 RU Адаптер для бит шарнирный
 CZ Držák na bity s jističím
 HU Csuklós bit befogó
 RO Adaptor pt. biți pivotant
 FR Porte embout pivotant
 IT Adattatore angolare per punte
 ES Adaptador articulado para puntas
 CN 万向接杆

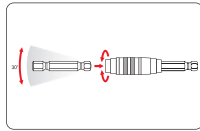

1/4"
6.3 mm

100 mm

CrV



YATO		
YT-04635	1/4" (6.3 mm)	60/120

EN Keyless chuck snap-out
 PL Uchwyt wiertarski bezkluczowy
 DE Schnellspan-Bohrfutter
 RU Патрон для дрели быстрозажимной
 CZ Sklíčidlo
 HU Bitbefogású gyorsostómány
 RO Mandrină rapidă cu prindere hexagonală
 FR Mandrin sans clé
 IT Mandrino portapunte autoserrante
 ES Adaptador portabrocas
 CN 夹头

1/4"
6.3 mm

0.5-3.0 mm

50 mm



YATO		
YT-04644	1/4" (6.3 mm)	50/150

EN Keyless chuck snap-out
 PL Uchwyt wiertarski bezkluczowy
 DE Schnellspan-Bohrfutter
 RU Патрон для дрели быстрозажимной
 CZ Sklíčidlo
 HU Bitbefogású gyorsostómány
 RO Mandrină rapidă cu prindere hexagonală
 FR Adaptador portabrocas
 IT Mandrino portapunte autoserrante
 ES Mandrin sans clé
 CN 夹头

1/4"
6.3 mm

0.5-6.5 mm

75 mm



YATO		
YT-04645	1/4" (6.3 mm)	10/60

EN Screwdriver bit holder
 PL Uchwyt do końcówek śrubokrętowych
 DE Bithalter
 RU Адаптер для бит
 CZ Držák bitů
 HU Bit befogó

RO Adaptor biți
 FR Porte-embout
 IT Portapunte
 ES Soplete para puntas
 CN 螺丝批头接杆

1/4"
6.3 mm



YATO		L [mm]	
YT-04681	1/4" (6.3 mm)	150	50/100
YT-04682	1/4" (6.3 mm)	200	50/100
YT-04683	1/4" (6.3 mm)	250	50/100
YT-04684	1/4" (6.3 mm)	300	50/100

EN Screwdriver bit holder set
 PL Zestaw uchwytów do bitów
 DE Bithalter-Set
 RU Набор держателей бит
 CZ Sada prodlžovacích úchytů pro bity
 HU Bitbefogó készlet
 RO Set adaptoare biți
 FR Jeu de porte-embouts
 IT Kit portainserti
 ES Juego de portaherramientas
 CN 延长杆组套

3 PCS

1/4"
6.3 mm



1/4" (6.3 mm): 75, 100, 150 mm

YATO		
YT-04699	1/4" (6.3 mm)	20/120

EN Adapter
 PL Adapter
 DE Adapter
 RU Адаптер

CZ Adaptér
 HU Adapter
 RO Adaptor
 FR Adaptateur

IT Adattatore
 ES Adaptador
 CN 转接杆

1/4"
6.3 mm

1/4"
6.3 mm

65 mm



YATO		L [mm]	
YT-04625	1/4" (6.3 mm)	65	40/120

EN Adapter
 PL Adapter
 DE Adapter
 RU Адаптер

CZ Adaptér
 HU Adapter
 RO Adaptor
 FR Adaptateur

IT Adattatore
 ES Adaptador
 CN 转接杆

1/4"
6.3 mm

3/8"
9.5 mm

65 mm



YATO		L [mm]	
YT-04626	1/4" (6.3 mm)	65	40/120

EN Adapter
 PL Adapter
 DE Adapter
 RU Адаптер

CZ Adaptér
 HU Adapter
 RO Adaptor
 FR Adaptateur

IT Adattatore
 ES Adaptador
 CN 转接杆

1/4"
6.3 mm

1/2"
12.7 mm

70 mm



YATO		L [mm]	
YT-04627	1/4" (6.3 mm)	70	40/120

EN Adapter CZ Adaptér IT Adattatore
PL Adapter HU Adapter ES Adaptador
DE Adapter RO Adaptor CN 转接杆
RU Адаптер FR Adaptateur

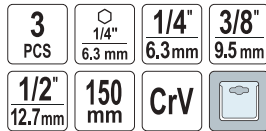

YATO		L [mm]	
YT-04628	1/4" (6.3 mm)	150	24

EN Adapter CZ Adaptér IT Adattatore
PL Adapter HU Adapter ES Adaptador
DE Adapter RO Set adaptoare CN 转接杆
RU Адаптер FR Adaptateur

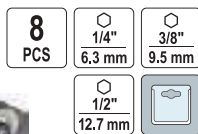

1/2" (12.7 mm): 50, 72 mm; 3/8" (9.5 mm): 50, 65 mm; 1/4" (6.3 mm): 25, 30, 50, 65 mm

YATO		
YT-04639	1/4" (6.3 mm), 3/8" (9.5 mm), 1/2" (12.7 mm)	20/100

EN Adapter CZ Adaptér IT Adattatore
PL Adapter HU Adapter ES Adaptador
DE Adapter RO Adaptor CN 接杆组套
RU Адаптер FR Adaptateur

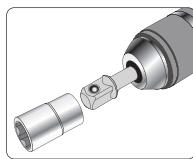
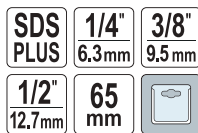

YATO	
YT-04686	20/100

EN Adapter CZ Adaptér IT Adattatore
PL Adapter HU Adapter ES Adaptador
DE Adapter RO Adaptor CN 接杆
RU Адаптер FR Adaptateur

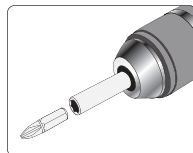
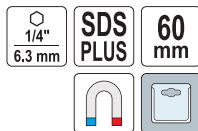

YATO	L [mm]	
YT-04690	60	50/100

EN Adapter CZ Adaptér IT Adattatore
PL Adapter HU Adapter ES Adaptador
DE Adapter RO Adaptor CN 转接杆
RU Адаптер FR Adaptateur



YATO		L [mm]	
YT-04629	1/4" (6.3 mm)	50, 150	24

EN Adapter CZ Adaptér IT Adattatore
PL Adapter HU Adapter ES Adaptador
DE Adapter RO Adaptor CN 六角柄接杆组套
RU Адаптер FR Adaptateur

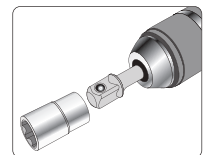
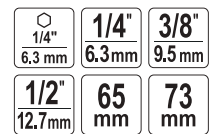

YATO		
YT-04685	1/4" (6.3 mm)	20/100

EN Universal joint bit adapter set
PL Zestaw adapterów z przegubem
DE Kreuzgelenk-Adapter-Set
RU Набор переходников с шарниром
CZ Sada adaptérů s kloubem
HU Csuklós csavarhúzófej-adapter
RO Set de adaptare cardanice
FR Jeu d'adaptateurs avec joint
IT Kit adattatori con giunto
ES Conjunto de adaptadores con junta articulada
CN 万向接杆

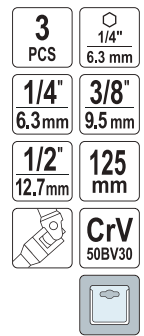

YATO		
YT-04641	1/4" (6.3 mm)	12/36

EN Flexible bit extension
PL Elastyczna przedłużka do bitów
DE Elastische Bitverlängerung
RU Гибкий удлинитель для бит
CZ Flexibilní nástavec pro šroubování
HU Rugalmas bit hosszabbító

RO Prelungitor flexibil pt. biti
FR Rallonge d'embout flexible
IT Prolunga flessibile per punte
ES Adaptador flexible para puntas
CN 柔性螺丝批头接杆

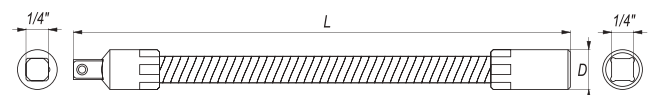
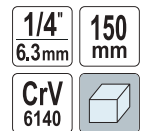

YATO			D [mm]	L [mm]	PCS ROSE	
YT-1400	1/4" (6.3 mm)	1/4" (6.3 mm)	11.6	150	25	250/500

EN Flexible bit extension RU Гибкий удлинитель для бит RO Prelungitor flexibil pt. biti ES Adaptador flexible para puntas
 PL Elastyczna przedłużka do bitów CZ Flexibilní nástavec pro šroubování FR Rallonge d'embout flexible CN 柔性螺丝批头接杆
 DE Elastische Bitverlängerung HU Rugalmas bit hosszabbító IT Prolunga flessibile per punte

1/4" 300 CrV 6140

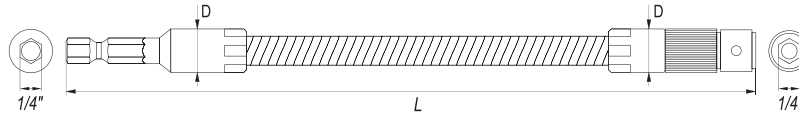

YATO	Hex	Hex	D [mm]	L [mm]	Box
YT-14001	1/4" (6.3 mm)	1/4" (6.3 mm)	11.7	300	100

5

EN Angled screwdriver bit holder
 PL Wkrętek kątowy do końcówek śrubokrętowych
 DE Winkelschrauber
 RU Г-образный держатель для бит
 CZ Šroubovák
 HU Csavarhúzó
 RO Prelungitor pt. biti, 90 grade
 FR Mandrin magnétique
 IT Cacciavite ad angolo per punte
 ES Porta puntas magnético
 CN 直角螺丝批接头

1/4" 105 90°



YATO	Hex	L [mm]	Box
YT-04630	1/4" (6.3 mm)	105	60/240

EN Angle adapter
 PL Adapter kątowy
 DE Winkelschrauber
 RU Адаптер угловой для бит
 CZ Úhel elektrická vrtačka připojení adaptéru
 HU Sarokcsavarozó adapter
 RO Adaptor unghiular
 FR Renvoi d'angle perceuse visseuse
 IT Adattatore
 ES Ángulo magnético bit driver adaptador
 CN 拐带柔性接杆

1/4" 37 105° 12 Nm
 1200 min⁻¹ SS STAINLESS STEEL STAL NERDZEWA



YATO	Hex	L [mm]	Box
YT-04632	1/4" (6.3 mm)	37	100



EN Angle adapter
 PL Adapter kątowy
 DE Winkelschrauber
 RU Адаптер угловой для бит
 CZ Úhel elektrická vrtačka připojení adaptéru
 HU Sarokcsavarozó adapter
 RO Adaptor unghiular
 FR Renvoi d'angle perceuse visseuse
 IT Adattatore
 ES Ángulo magnético bit driver adaptador
 CN 带手柄拐螺丝批接头

1/4" 155 400 90° 13 Nm



YATO	Hex	L [mm]	Box
YT-04631	1/4" (6.3 mm)	155	50

EN Impact adapter
 PL Adapter udarowy do bitów
 DE Schlag-Bit-Adapter
 RU Ударный адаптер для бит
 CZ Nárazový adaptér pro bity
 HU Útvéfűző adapter bitejekhez
 RO Adaptor impact
 FR Adapateur de percussion pour embouts
 IT Adattatore a impatto per punte
 ES Adaptador de impacto para bites
 CN 转接头

1/4" 325 400 90° 13 Nm



YATO	Hex	L [mm]	Box
YT-04691	1/4" (6.3 mm)	50	10/60

EN T-handle key
PL Klucz typu „T”
DE Stiftschlüssel mit T-Griff
RU Ключ с T-образной рукояткой

CZ Klíč s T-rukojetí
HU Imbuszkulcs T-markolattal
RO Cheie tip „T”
FR Clé avec poignée en T

IT Chiave a „T”
ES Llave con mango en T
CN T型内六角扳手

S2

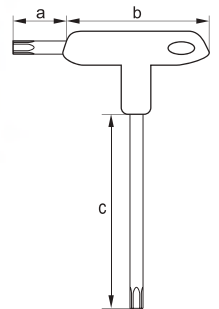
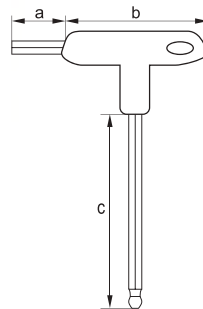
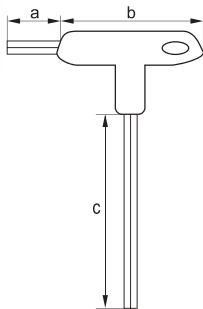

YATO	⌀ [mm]	a [mm]	b [mm]	c [mm]	
YT-05571	2.5	13	76	100	12/240
YT-05572	3.0	13	76	100	12/240
YT-05574	4.0	13	76	140	12/240
YT-05576	5.0	17	92	140	12/144
YT-05577	6.0	17	92	170	12/144
YT-05578	7.0	17	92	170	12/144
YT-05579	8.0	22	102	200	12/96
YT-05581	10.0	22	102	200	12/96

YATO	⌀ [mm]	a [mm]	b [mm]	c [mm]	
YT-05585	2.5	13	76	100	12/240
YT-05586	3.0	13	76	100	12/240
YT-05588	4.0	13	76	140	12/240
YT-05590	5.0	17	92	140	12/144
YT-05591	6.0	17	92	170	12/144
YT-05592	7.0	17	92	170	12/144
YT-05593	8.0	22	102	200	12/96
YT-05594	10.0	22	102	200	12/96

YATO	⌀	a [mm]	b [mm]	c [mm]	
YT-05601	T8	13	76	100	12/240
YT-05602	T9	13	76	100	12/240
YT-05603	T10	13	76	100	12/240
YT-05604	T15	13	76	100	12/240
YT-05605	T20	13	76	130	12/240
YT-05606	T25	13	76	130	12/240
YT-05607	T27	17	92	140	12/144
YT-05608	T30	17	92	170	12/144
YT-05609	T40	17	92	170	12/144
YT-05610	T45	22	102	200	12/96
YT-05611	T50	22	102	200	12/96

EN T-handle key set
PL Zestaw kluczy typu „T”
DE Stiftschlüssel-Satz mit T-Griff
RU Набор ключей с T-образной рукояткой

CZ Sada klíčů s T-rukojetí
HU Imbuszkulcs készlet T-markolattal
RO Set chei tip „T”
FR Jeu de clés avec poignée en T

IT Set chiavi a „T”
ES Juego llaves con mango en T
CN T型内六角扳手组套

8
PCS



S2

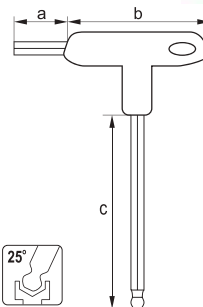
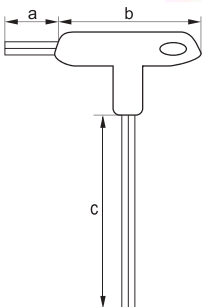

YATO	⌀ [mm]	a [mm]	b [mm]	c [mm]	
YT-05583	2.5, 3, 4, 5, 6, 7, 8, 10	13, 13, 13, 17, 17, 17, 22, 22	76, 76, 76, 92, 92, 92, 102, 102	100, 100, 140, 140, 170, 170, 200, 200	12/24

YATO	⌀ [mm]	a [mm]	b [mm]	c [mm]	
YT-05597	2.5, 3, 4, 5, 6, 7, 8, 10	13, 13, 13, 17, 17, 17, 22, 22	76, 76, 76, 92, 92, 92, 102, 102	100, 100, 140, 140, 170, 170, 200, 200	12/24

EN T-handle Torx key set
 PL Zestaw kluczy Torx typu „T”
 DE T-Griff-Torx-Schlüssel-Satz
 RU Набор ключей Torx с T-образной рукояткой
 CZ Sada klíčů Torx s T-rukojetí
 HU T-nyelű Torx kulcs készlet
 RO Set chei Torx tip „T”
 FR Jeu de clés Torx avec poignée en T
 IT Set di chiavi Torx a „T”
 ES Juego llaves Torx con mango en T
 CN T型星型内六角扳手组套

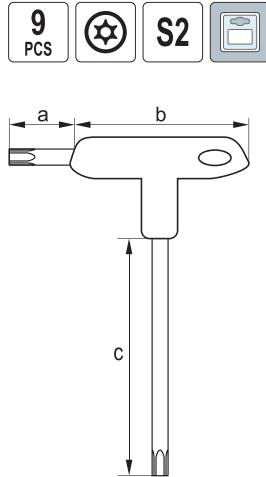

YATO	⊙	a [mm]	b [mm]	c [mm]	📦
YT-05615	T10, T15, T20, T25, T27, T30, T40, T45, T50	13, 13, 13, 13, 17, 17, 17, 22, 22	76, 76, 76, 76, 92, 92, 92, 102, 102	100, 100, 100, 140, 140, 170, 170, 200, 200	12/24

EN Hex and Torx key set
 PL Zestaw kluczy trzpieniowych
 DE Sechskant und Torx Stiftschlüsselsatz
 RU Набор ключей Hex и Torx
 CZ Sada klíčů imbusových a Torx
 HU Imbusz- és Torx kulcskészlet
 RO Set de chei imbus și Torx
 FR Jeu de clés hexagonales et Torx
 IT Set di chiavi a brugola e Torx
 ES Juego de llaves hexagonales y Torx
 CN 内六角组套

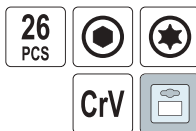

⊙ 1.5, 2, 2.5, 3, 4, 4.5, 5, 5.5, 6 mm; 5/64" (2.0 mm), 3/32" (2.4 mm), 7/64" (2.8 mm), 1/8" (3.2 mm), 9/64" (3.6 mm), 5/32" (4.0 mm), 3/16" (4.8 mm), 7/32" (5.6 mm), 1/4" (6.3 mm); CrV;
 ⚙️ T9, T10, T15, T20, T25, T27, T30, T40; CrV

YATO	📦
YT-05644	6/20

EN Hex and Torx key set
 PL Zestaw kluczy trzpieniowych
 DE Sechskant und Torx Stiftschlüsselsatz
 RU Набор ключей Hex и Torx
 CZ Sada klíčů imbusových a Torx
 HU Imbusz- és Torx kulcskészlet
 RO Set de chei imbus și Torx
 FR Jeu de clés hexagonales et Torx
 IT Set di chiavi a brugola e Torx
 ES Juego de llaves hexagonales y Torx
 CN 内六角组套



⊙ 1.5, 2, 2.5, 3, 4, 5, 6, 8 mm; 1/16" (1.6 mm), 5/64" (2.0 mm), 3/32" (2.4 mm), 1/8" (3.2 mm), 9/64" (3.6 mm), 5/32" (4.0 mm), 3/16" (4.8 mm), 1/4" (6.3 mm); CrV;
 ⚙️ T6, T7, T8, T9, T10, T15, T20, T25; CrV

YATO	📦
YT-05640	10/40

EN Hex key
 PL Klucz imbusowy
 DE Sechskant-Stiftschlüssel
 RU Шестигранный ключ
 CZ Imbusový klíč
 HU Imbusz kulcs
 RO Cheie imbus
 FR Clé hexagonale
 IT Chiave a brugola
 ES Llave hexagonal
 CN 内六角扳手

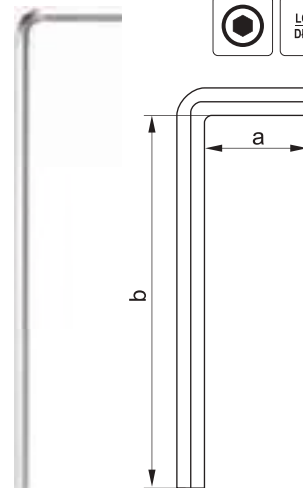

YATO	⊙ [mm]	a [mm]	b [mm]	📦
YT-05430	1.5	14	78	250/500
YT-05431	2.0	16	83	250/2000
YT-05432	2.5	18	90	250/1500
YT-05433	3.0	20	100	250/1500
YT-05434	4.0	25	105	250/1000
YT-05436	5.0	27	116	100/600
YT-05438	6.0	32	137	100/500
YT-05439	7.0	34	150	100/300
YT-05440	8.0	36	155	50/200
YT-05441	9.0	38	165	25/125
YT-05442	10.0	40	170	25/125
YT-05443	12.0	47	210	25/75
YT-05444	14.0	57	236	25/50
YT-05445	17.0	63	250	15/30
YT-05446	19.0	70	280	10/20

EN Hex key
PL Klucz imbusowy
DE Sechskant-Stiftschlüssel
RU Шестигранный ключ
CZ Imbusový klíč
HU Imbusz kulcs
RO Cheie imbus
FR Clé hexagonale
IT Chiave a brugola
ES Llave hexagonal
CN 内六角扳手

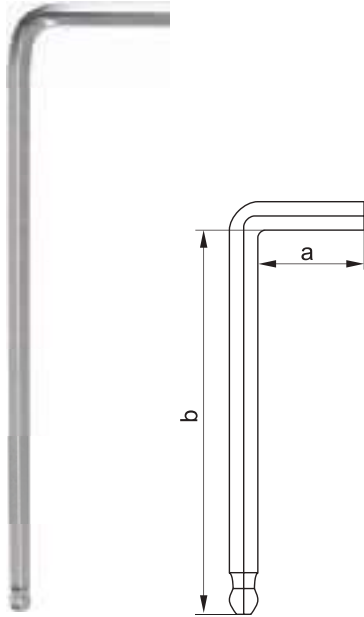

YATO	⊙ [mm]	a [mm]	b [mm]	📦
YT-05450	1.5	14	78	250/2000
YT-05451	2.0	16	83	250/500
YT-05452	2.5	18	90	250/500
YT-05453	3.0	20	100	250/500
YT-05454	4.0	25	105	250/1000
YT-05456	5.0	27	116	100/600
YT-05458	6.0	32	137	100/500
YT-05459	7.0	34	150	100/300
YT-05460	8.0	36	155	50/200
YT-05461	9.0	38	165	25/125
YT-05462	10.0	40	170	25/125
YT-05463	12.0	47	210	25/75
YT-05464	14.0	57	236	25/50
YT-05465	17.0	63	250	15/30
YT-05466	19.0	70	280	10/20

EN Torx key
PL Klucz Torx
DE Torx-Stiftschlüssel
RU Ключ Torx
CZ Klíč Torx
HU Kulcs Torx
RO Cheie Torx
FR Clé Torx
IT Chiave Torx
ES Llave Torx
CN 内六角螺丝批

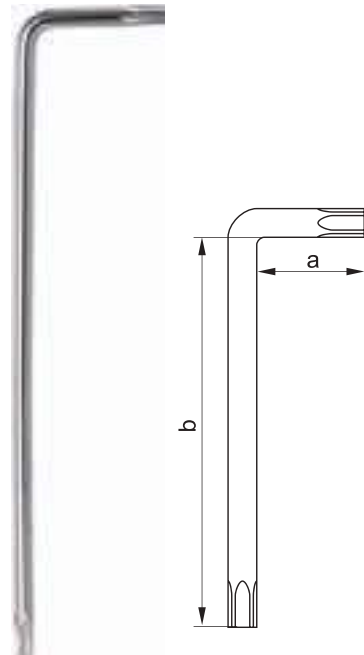

YATO	⊙	a [mm]	b [mm]	📦
YT-05514	T10	17	86	250/500
YT-05515	T15	17	90	250/500
YT-05516	T20	19	95	250/500
YT-05517	T25	20	100	250/500
YT-05518	T27	21	105	250/1000
YT-05519	T30	24	114	50/600
YT-05520	T40	28	121	50/400

EN Torx key
PL Klucz Torx
DE Torx-Stiftschlüssel
RU Ключ Torx
CZ Klíč Torx
HU Kulcs Torx
RO Cheie Torx
FR Clé Torx
IT Chiave Torx
ES Llave Torx
CN 内六角螺丝批

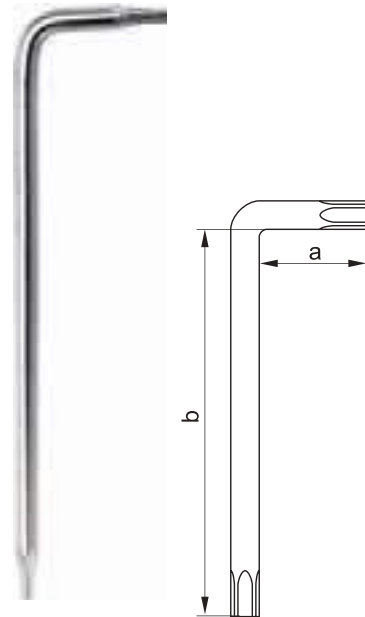

YATO	⊙	a [mm]	b [mm]	📦
YT-05490	T6	16	66	250/500
YT-05491	T7	16	71	250/500
YT-05492	T8	16	80	250/500
YT-05493	T9	16	80	250/500
YT-05494	T10	17	86	250/500
YT-05495	T15	17	90	250/2000
YT-05496	T20	19	95	100/1000
YT-05497	T25	20	100	250/500
YT-05498	T27	21	105	100/1000
YT-05499	T30	24	114	50/600
YT-05501	T40	28	121	50/400

EN Torx key set
PL Zestaw kluczy Torx
DE Torx-Stiftschlüsselsatz
RU Набор ключей Torx
CZ Sada klíčů Torx
HU Torx kulcskészlet
RO Set de chei Torx
FR Jeu de clés Torx
IT Set di chiavi Torx
ES Juego de llaves Torx
CN 内六角扳手组套

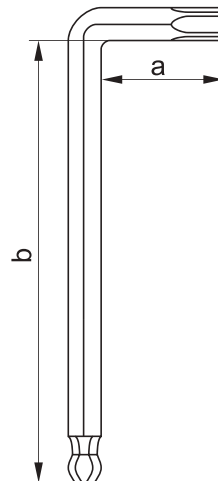

YATO	⊙	a [mm]	b [mm]	📦
YT-05123	T9, T10, T15, T20, T25, T27, T30, T40	18, 18, 19, 20, 21, 23, 25, 27	85, 90, 95, 100, 107, 115, 123, 132	10/100

EN Hex key set
 PL Zestaw kluczy imbusowych
 DE Sechskant-Stiftschlüsselsatz
 RU Набор шестигранных ключей

CZ Sada imbusových klíčů
 HU Imbuskulcs készlet
 RO Set chei imbus
 FR Jeu de clés hexagonales

IT Set di chiavi a brugola
 ES Juego de llaves hexagonales
 CN 内六角扳手组套

12 PCS SAE CrV 6150

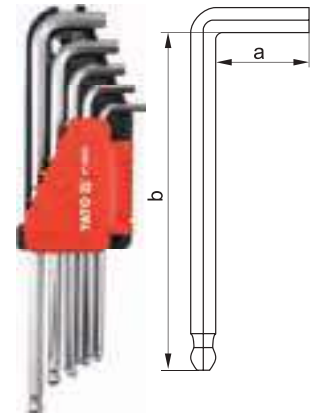
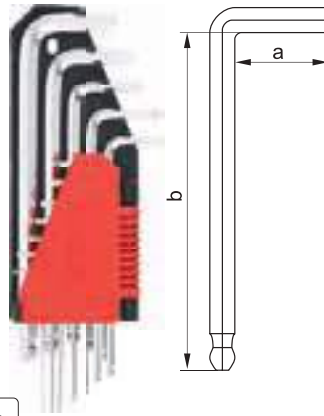
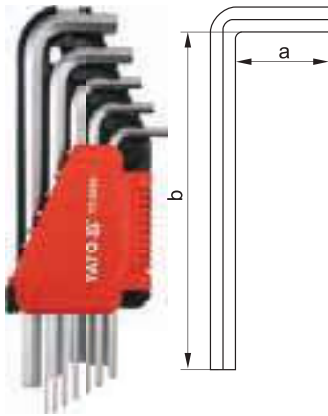

LONG DEUGI



LONG DEUGI



EXTRA LONG EKSTRA-DŁUGI

YATO	⊙	a [mm]	b [mm]	
YT-5835	1/16" (1.6 mm),			6/36
	5/64" (2.0 mm),			
	3/32" (2.4 mm),			
	7/64" (2.8 mm),			
	1/8" (3.2 mm),	14, 16, 17,	74, 79, 83,	
	9/64" (3.6 mm),	18, 19, 20,	88, 93, 99,	
	5/32" (4.0 mm),	21, 24, 25,	105, 113,	
	3/16" (4.8 mm),	28, 32, 35	122, 132,	
	7/32" (5.6 mm),		150, 170	
	1/4" (6.3 mm),			
	5/16" (7.9 mm),			
3/8" (9.5 mm)				

YATO	⊙	a [mm]	b [mm]	
YT-5837	1/16" (1.6 mm),			6/36
	5/64" (2.0 mm),			
	3/32" (2.4 mm),			
	7/64" (2.8 mm),			
	1/8" (3.2 mm),	14, 16, 17,	74, 79, 83,	
	9/64" (3.6 mm),	18, 19, 20,	88, 93, 99,	
	5/32" (4.0 mm),	21, 24, 25,	105, 113,	
	3/16" (4.8 mm),	28, 32, 35	122, 132,	
	7/32" (5.6 mm),		150, 170	
	1/4" (6.3 mm),			
	5/16" (7.9 mm),			
3/8" (9.5 mm)				

YATO	⊙	a [mm]	b [mm]	
YT-5838	1/16" (1.6 mm),			6/36
	5/64" (2.0 mm),			
	3/32" (2.4 mm),			
	7/64" (2.8 mm),		91, 100,	
	1/8" (3.2 mm),	14, 16, 17,	110, 116,	
	9/64" (3.6 mm),	18, 19, 20,	123, 130,	
	5/32" (4.0 mm),	21, 24, 25,	132, 150,	
	3/16" (4.8 mm),	28, 32, 35	165, 185,	
	7/32" (5.6 mm),		200, 233	
	1/4" (6.3 mm),			
	5/16" (7.9 mm),			
3/8" (9.5 mm)				

EN Hex key set
 PL Zestaw kluczy imbusowych
 DE Sechskant-Stiftschlüsselsatz

RU Набор шестигранных ключей
 CZ Sada imbusových klíčů
 HU Imbuskulcs készlet

RO Set chei imbus
 FR Jeu de clés hexagonales
 IT Set di chiavi a brugola

ES Juego de llaves hexagonales
 CN 内六角扳手组套

HRC 52-56 CrV 6150

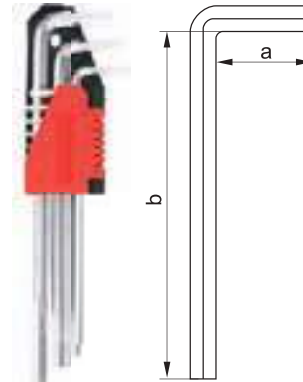
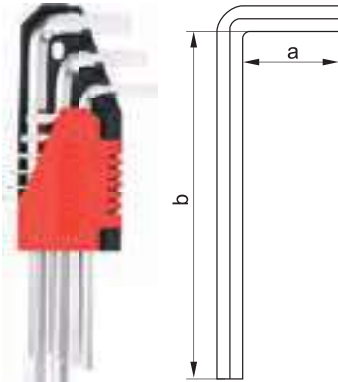

9 PCS

YATO	⊙ [mm]	a [mm]	b [mm]	
YT-0500	1.5, 2, 2.5, 3, 4, 5, 6, 8, 10	15, 16, 18, 21, 23, 28, 31, 35, 39	74, 81, 88, 95, 109, 121, 135, 157, 174	6/36

9 PCS

YATO	⊙ [mm]	a [mm]	b [mm]	
YT-0501	1.5, 2, 2.5, 3, 4, 5, 6, 8, 10	15, 16, 18, 21, 23, 28, 31, 35, 39	90, 96, 112, 125, 142, 157, 180, 201, 225	6/36

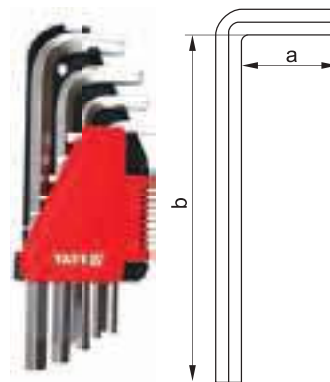
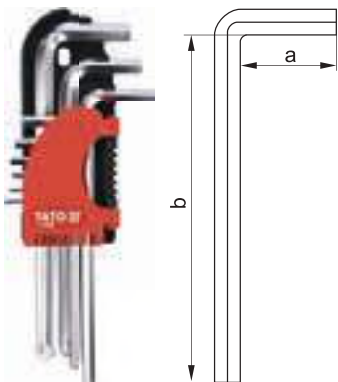

9 PCS

YATO	⊙ [mm]	a [mm]	b [mm]	
YT-0502	2, 2.5, 3, 4, 5, 6, 7, 8, 10	16, 18, 21, 23, 28, 31, 33, 35, 39	81, 88, 95, 109, 121, 135, 145, 157, 174	6/36

10 PCS

YATO	⊙ [mm]	a [mm]	b [mm]	
YT-0508	2, 2.5, 3, 4, 5, 6, 7, 8, 10, 12	16, 18, 21, 23, 28, 31, 33, 35, 39, 42	81, 88, 95, 109, 121, 135, 145, 157, 174, 180	6/36

EN Hex key set
PL Zestaw kluczy imbusowych
DE Sechskant-Stiftschlüsselsatz
RU Набор шестигранных ключей
CZ Sada imbusových klíčů
HU Imbuskulcs készlet
RO Set chei imbus
FR Jeu de clés hexagonales
IT Set di chiavi a brugola
ES Juego de llaves hexagonales
CN 内六角扳手组套



HRC
52-56

CrV
6150

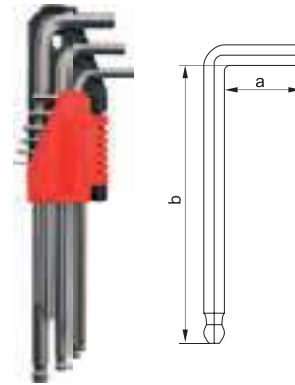
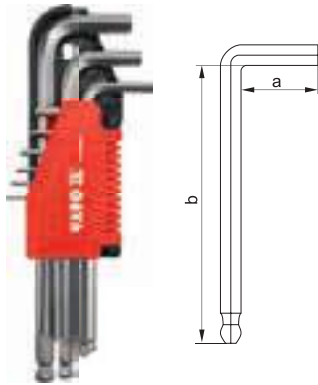

9
PCS



9
PCS

YATO	© [mm]	a [mm]	b [mm]	
YT-0505	1.5, 2, 2.5, 3, 4, 5, 6, 8, 10	15, 16, 18, 21, 23, 28, 31, 35, 39	74, 81, 88, 95, 109, 121, 135, 157, 174	6/36

YATO	© [mm]	a [mm]	b [mm]	
YT-0506	1.5, 2, 2.5, 3, 4, 5, 6, 8, 10	15, 16, 18, 21, 23, 28, 31, 35, 39	90, 96, 112, 125, 142, 157, 180, 201, 225	6/36

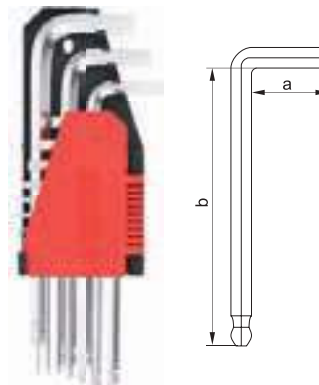
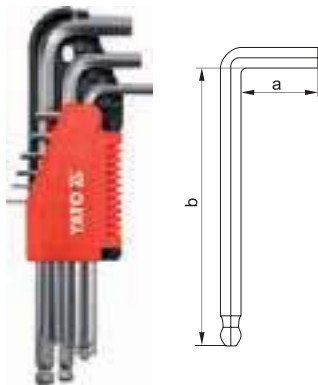

9
PCS

10
PCS

YATO	© [mm]	a [mm]	b [mm]	
YT-0507	2, 2.5, 3, 4, 5, 6, 7, 8, 10	16, 18, 21, 23, 28, 31, 33, 35, 39	81, 88, 95, 109, 121, 135, 145, 157, 174	6/36

YATO	© [mm]	a [mm]	b [mm]	
YT-0509	2, 2.5, 3, 4, 5, 6, 7, 8, 10, 12	16, 18, 21, 23, 28, 31, 33, 35, 39, 42	81, 88, 95, 109, 121, 135, 145, 157, 174, 180	6/36

EN Hex key set
PL Zestaw kluczy imbusowych
DE Sechskant-Stiftschlüsselsatz
RU Набор шестигранных ключей
CZ Sada imbusových klíčů
HU Imbuskulcs készlet
RO Set chei imbus
FR Jeu de clés hexagonales
IT Set di chiavi a brugola
ES Juego de llaves hexagonales
CN 内六角扳手组套



CrV
6150



8
PCS

10
PCS

YATO	© [mm]	a [mm]	b [mm]	
YT-0503	2, 2.5, 3, 4, 5, 6, 8, 10	14, 16, 17, 21, 22, 27, 32, 38	50, 53, 60, 66, 74, 81, 93, 104	12/72

YATO	© [mm]	a [mm]	b [mm]	
YT-0504	1.5, 2, 2.5, 3, 4, 5, 6, 7, 8, 10	12, 14, 16, 17, 21, 22, 27, 31, 32, 38	43, 50, 53, 60, 66, 74, 81, 86, 93, 104	12/72

EN Hex key set
PL Zestaw kluczy imbusowych
DE Sechskant-Stiftschlüsselsatz
RU Набор шестигранных ключей
CZ Sada imbusových klíčů
HU Imbuskulcs készlet
RO Set chei imbus
FR Jeu de clés hexagonales
IT Set di chiavi a brugola
ES Juego de llaves hexagonales
CN 内六角扳手组套

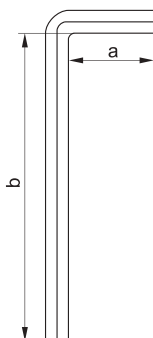

10
PCS



HRC
52-55

CrV
6150



YATO	© [mm]	a [mm]	b [mm]	
YT-0519	3, 4, 5, 5.5, 6, 8, 10, 12, 14, 17	20, 25, 28, 30, 32, 35, 42, 49, 57, 65	125, 140, 160, 170, 180, 200, 220, 250, 285, 320	5

EN Torx key set
 PL Zestaw kluczy Torx
 DE Torx-Stiftschlüsselsatz
 RU Набор ключей Torx

CZ Sada klíčů Torx
 HU Torx kulcskészlet
 RO Set de chei Torx
 FR Jeu de clés Torx

IT Set di chiavi Torx
 ES Juego de llaves Torx
 CN 内六角扳手组套

9 PCS  HRC 52-56 CrV 6150 

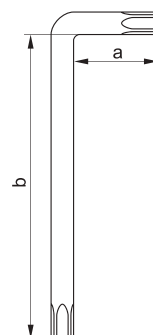
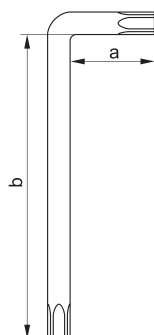



YATO	⊙	a [mm]	b [mm]	
YT-0511	T10, T15, T20, T25, T27, T30, T40, T45, T50	15, 16, 17, 21, 24, 27, 32, 36, 38	72, 79, 86, 94, 107, 122, 133, 155, 174	6/36

YATO	⊙	a [mm]	b [mm]	
YT-0512	T10, T15, T20, T25, T27, T30, T40, T45, T50	15, 16, 19, 23, 26, 27, 32, 36, 41	78, 95, 109, 124, 143, 153, 180, 200, 222	6/36

EN Hex key set
 PL Zestaw kluczy imbusowych
 DE Sechskant-Stiftschlüsselsatz
 RU Набор шестигранных ключей

CZ Sada imbusových klíčů
 HU Imbuskulcs készlet
 RO Set chei imbus
 FR Jeu de clés hexagonales

IT Set di chiavi a brugola
 ES Juego de llaves hexagonales
 CN 内六角扳手组套

10 PCS  25°  S2 

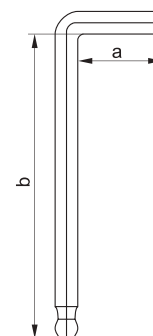
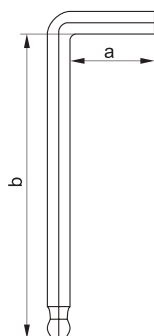

YATO	⊙ [mm]	a [mm]	b [mm]	
YT-0560	1.27, 1.5, 2, 2.5, 3, 4, 5, 6, 8, 10	12, 14, 16, 18, 18, 21, 27, 32, 35, 38	73, 76, 82, 89, 99, 104, 115, 138, 161, 179	12/48

YATO	⊙ [mm]	a [mm]	b [mm]	
YT-0561	1.27, 1.5, 2, 2.5, 3, 4, 5, 6, 8, 10	10, 12, 15, 17, 19, 23, 28, 32, 36, 50	78, 89, 98, 110, 124, 140, 159, 179, 198, 232	12/48

EN Torx key set
 PL Zestaw kluczy Torx
 DE Torx-Stiftschlüsselsatz
 RU Набор ключей Torx

CZ Sada klíčů Torx
 HU Torx kulcskészlet
 RO Set de chei Torx
 FR Jeu de clés Torx

IT Set di chiavi Torx
 ES Juego de llaves Torx
 CN 内六角扳手组套

 S2 

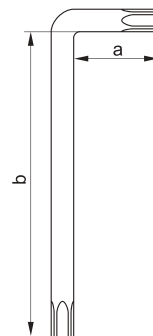
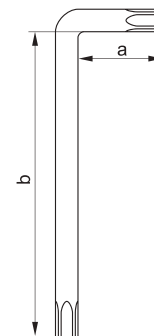

7 PCS

YATO	⊙	a [mm]	b [mm]	
YT-0562	T9, T10, T15, T20, T25, T27, T30	18, 19, 19, 19, 22, 24, 26	78, 85, 93, 103, 113, 123, 132	12/48

9 PCS

YATO	⊙	a [mm]	b [mm]	
YT-0563	T10, T15, T20, T25, T27, T30, T40, T45, T50	14, 14, 16, 18, 23, 27, 30, 35, 41	87, 97, 108, 123, 137, 158, 177, 197, 216	12/48

EN Hex key set
PL Zestaw kluczy imbusowych
DE Sechskant-Stiftschlüsselsatz
RU Набор шестигранных ключей

CZ Sada imbusových klíčů
HU Imbuskulcs készlet
RO Set chei imbus
FR Jeu de clés hexagonales

IT Set di chiavi a brugola
ES Juego de llaves hexagonales
CN 内六角扳手组套

9 PCS
HRC 58-62
S2

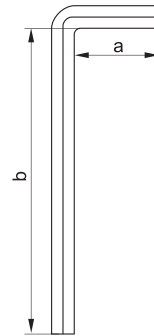
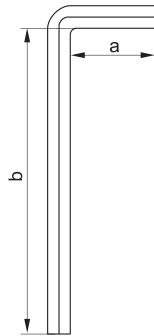

YATO	⊙ [mm]	a [mm]	b [mm]	
YT-05631	1.5, 2, 2.5, 3, 4, 5, 6, 8, 10	14.5, 16, 17.5, 21, 23, 27, 30, 33, 38	78.5, 83, 90.5, 99, 110, 122, 138, 152, 166	10/50

YATO	⊙ [mm]	a [mm]	b [mm]	
YT-05634	1.5, 2, 2.5, 3, 4, 5, 6, 8, 10	16, 18, 21, 25, 28, 34, 36, 42, 50	97, 106, 116, 128, 142, 157, 175, 198, 225	10/50

EN Hex key set
PL Zestaw kluczy imbusowych
DE Sechskant-Stiftschlüsselsatz
RU Набор шестигранных ключей

CZ Sada imbusových klíčů
HU Imbuskulcs készlet
RO Set chei imbus
FR Jeu de clés hexagonales

IT Set di chiavi a brugola
ES Juego de llaves hexagonales
CN 内六角扳手组套

9 PCS
25°
HRC 58-62
S2

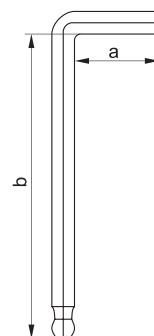
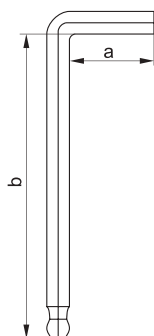

YATO	⊙ [mm]	a [mm]	b [mm]	
YT-05632	1.5, 2, 2.5, 3, 4, 5, 6, 8, 10	14.5, 16, 17.5, 21, 23, 27, 30, 33, 38	78.5, 83, 90.5, 99, 110, 122, 138, 152, 166	10/50

YATO	⊙ [mm]	a [mm]	b [mm]	
YT-05635	1.5, 2, 2.5, 3, 4, 5, 6, 8, 10	16, 18, 21, 25, 28, 34, 36, 42, 50	97, 106, 116, 128, 142, 157, 175, 198, 225	10/50

EN Torx key set
PL Zestaw kluczy Torx
DE Torx-Stiftschlüsselsatz
RU Набор ключей Torx

CZ Sada klíčů Torx
HU Torx kulcskészlet
RO Set de chei Torx
FR Jeu de clés Torx

IT Set di chiavi Torx
ES Juego de llaves Torx
CN 内六角扳手组套

9 PCS
HRC 58-62
S2

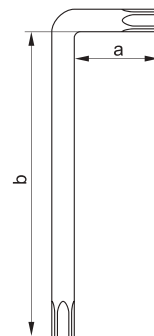
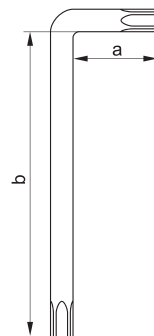

YATO	⊙	a [mm]	b [mm]	
YT-05633	T10, T15, T20, T25, T27, T30, T40, T45, T50	15, 17.7, 19.2, 20.75, 23.25, 25.5, 28.2, 34.2, 36.2	83, 90.7, 98.2, 106.75, 113.25, 129.5, 139.2, 149.2, 161.2	10/50

YATO	⊙	a [mm]	b [mm]	
YT-05636	T10, T15, T20, T25, T27, T30, T40, T45, T50	19, 21, 24, 27, 30, 32, 36, 42, 50	97, 101, 116, 130, 142, 161, 178, 199, 224	10/50

6

Pliers
Szczypce





Pliers, CrV Szczypce, CrV		
	108	
Combination pliers Szczypce uniwersalne	108	
Side cutting pliers Szczypce tnące, boczne	108	
Long nose pliers Szczypce wydłużone, proste	108	
Bent nose pliers Szczypce wydłużone, wygięte	108	

Long nose pliers Szczypce wydłużone, proste	110
Bent nose pliers Szczypce wydłużone, wygięte	110
Flat nose pliers Szczypce płaskie	110
Round nose pliers Szczypce okrągłe	110
End cutting pliers Szczypce tnące, czołowe	110



Pliers Szczypce		
	108-109	
Combination pliers Szczypce uniwersalne	108	
Side cutting pliers Szczypce tnące, boczne	108	
Long nose pliers Szczypce wydłużone, proste	108	
Bent nose pliers Szczypce wydłużone, wygięte	108	
Flat nose pliers Szczypce płaskie	108	
Round nose pliers Szczypce okrągłe	108	
Wire stripping pliers Szczypce do ściągania izolacji	109	
End cutting pliers Szczypce tnące, czołowe	109	



Plastics & cables cutting pliers Szczypce do cięcia plastiku i kabli		
	111	
Side cutting pliers Szczypce tnące, boczne	111	
Long nose pliers Szczypce wydłużone, proste	111	

Carpenter's pliers & tower pincers Obcęgi i szczypce		
	112	
Carpenter's pliers Obcęgi	112	
Tower pincers Szczypce tynkarskie	112	

Pliers, CrV Szczypce, CrV		
	109	
Combination pliers Szczypce uniwersalne	109	
Side cutting pliers Szczypce tnące, boczne	109	

Heavy duty side cutting pliers Szczypce tnące, boczne		
	112	
End cutting pliers Szczypce tnące czołowe	112	

Pliers Szczypce		
	109	
Combination pliers Szczypce uniwersalne	109	
Side cutting pliers Szczypce tnące, boczne	109	
Double joint pliers Szczypce przegubowe		
	109	
Double joint long nose pliers Szczypce wydłużone proste przegubowe	109	
Double joint bent nose pliers Szczypce wydłużone wygięte przegubowe	109	

Circlip pliers Szczypce Segera		
	112-115	
Lock grip pliers Szczypce zaciskowe		
	115-117	

Lock grip pliers Szczypce zaciskowe, uniwersalne	115
Welding locking pliers Szczypce zaciskowe, spawalnicze	115
Flat locking pliers Szczypce zaciskowe o szerokich szczękach	117
C-type welding locking pliers Szczypce zaciskowe, kłamrowe typu „C”	117
Chain locking pliers Szczypce zaciskowe z łańcuchem	117

Mini pliers Szczypce „Mini”		
	110	
Combination pliers Szczypce uniwersalne	110	
Side cutting pliers Szczypce tnące, boczne	110	

Profile connection & forming pliers Szczypce do łączenia i kształtowania profili		
	117-118	

EN Combination pliers
 PL Szczypce uniwersalne
 DE Kombinationszange
 RU Плоскогубцы универсальные
 CZ Kleště kombinované
 HU Kombináltfogó

RO Patent universal
 FR Pince universelle
 IT Pinze universali
 ES Alicates universales
 CN 钢丝钳

DIN 5746 **HRC 58-62** **HRC 44-50** **CrV 55**



• Application: industry
 • Induction hardening
 • Przeznaczenie: przemysł
 • Hartowane indukcyjnie

YATO	L [mm]	
YT-1940	160	6/60
YT-1941	180	6/60
YT-1942	200	6/36

EN Long nose pliers
 PL Szczypce wydłużone proste
 DE Radiozange gebogen
 RU Тонкогубцы удлиненные прямые
 CZ Prodloužené kleště rovné
 HU Rádiófogó egyenes

RO Clește cu vârf lung ascuțit
 FR Pince à bec long
 IT Pinza lunga dritta
 ES Alicates de punta rectos
 CN 尖嘴钳

DIN 5746 **HRC 44-50** **HRC 58-62**

CrV 55



• Application: industry
 • Induction hardening
 • Przeznaczenie: przemysł
 • Hartowane indukcyjnie

YATO	L [mm]	
YT-1943	160	6/60
YT-1944	200	6/60

EN Combination pliers
 PL Szczypce uniwersalne
 DE Kombinationszange
 RU Плоскогубцы универсальные

CZ Kleště kombinované
 HU Kombináltfogó
 RO Patent universal
 FR Pince universelle

IT Pinze universali
 ES Alicates universales
 CN 钢丝钳

DIN 5746 **NICKEL PLATED NIKLOWANE**



YATO	L [mm]	
YT-2006	160	6/60
YT-2007	180	6/60
YT-2008	200	6/36

EN Long nose pliers
 PL Szczypce wydłużone proste
 DE Radiozange gebogen
 RU Тонкогубцы удлиненные прямые
 CZ Prodloužené kleště rovné
 HU Rádiófogó egyenes

RO Clește cu vârf lung ascuțit
 FR Pince à bec long
 IT Pinza lunga dritta
 ES Alicates de punta rectos
 CN 尖嘴钳

DIN 5746 **NICKEL PLATED NIKLOWANE**



YATO	L [mm]	
YT-2016	160	6/60
YT-2018	200	6/60

EN Flat nose pliers
 PL Szczypce płaskie
 DE Flachzange
 RU Плоскогубцы удлиненные
 CZ Kleště ploché
 HU Rádiófogó, egyenes

RO Clește cu vârf ascuțit
 FR Pince plate
 IT Pinze piate
 ES Alicates de bocas planas
 CN 平嘴钳

160 mm **DIN 5745** **NICKEL PLATED NIKLOWANE**



YATO	L [mm]	
YT-2029	160	6/60

EN Diagonal side cutting pliers
 PL Szczypce tnące boczne
 DE Seitenschneider
 RU Бокорезы
 CZ Řezací kleště boční
 HU Oldal csípőfogó

RO Clește pt. tăiat lateral
 FR Pince à coupe latérale
 IT Pinze taglienti laterali
 ES Alicates corte lateral
 CN 斜嘴钳

DIN 5746 **HRC 44-50** **HRC 58-62** **CrV 55**



• Application: industry
 • Induction hardening
 • Przeznaczenie: przemysł
 • Hartowane indukcyjnie

YATO	L [mm]	
YT-1947	160	6/60
YT-1948	190	6/60

EN Bent nose pliers
 PL Szczypce wydłużone wygięte
 DE Radiozange gerade
 RU Тонкогубцы удлиненные изогнутые
 CZ Prodloužené kleště ohnuté
 HU Rádiófogó hajlított

RO Patent cu vârf ascuțit indoit
 FR Pince à bec coudé
 IT Pinza lunga piegata
 ES Alicates de punta curva
 CN 弯嘴钳

DIN 5746 **HRC 44-50** **HRC 58-62**

CrV 55



• Application: industry
 • Induction hardening
 • Przeznaczenie: przemysł
 • Hartowane indukcyjnie

YATO	L [mm]	
YT-1945	160	6/60
YT-1946	200	6/60

EN Diagonal side cutting pliers
 PL Szczypce tnące boczne
 DE Seitenschneider
 RU Бокорезы

CZ Řezací kleště boční
 HU Oldal csípőfogó
 RO Clește pt. tăiat lateral
 FR Pince à coupe latérale

IT Pinze taglienti laterali
 ES Alicates corte lateral
 CN 斜嘴钳

DIN 5746 **NICKEL PLATED NIKLOWANE**



YATO	L [mm]	
YT-2036	160	6/60
YT-2037	180	6/60

EN Bent nose pliers
 PL Szczypce wydłużone wygięte
 DE Radiozange gerade
 RU Тонкогубцы удлиненные изогнутые
 CZ Prodloužené kleště ohnuté
 HU Rádiófogó hajlított

RO Patent cu vârf ascuțit indoit
 FR Pince à bec coudé
 IT Pinza lunga piegata
 ES Alicates de punta curva
 CN 弯嘴钳

DIN 5746 **NICKEL PLATED NIKLOWANE**



YATO	L [mm]	
YT-2026	160	6/60
YT-2028	200	6/60

EN Round nose pliers
 PL Szczypce okrągłe
 DE Rundzange
 RU Круглогубцы
 CZ Kleště kulaté
 HU Kerekcsőrű fogó

RO Clește rotund
 FR Pince ronde
 IT Pinze tonde
 ES Alicates de punta redonda
 CN 圆嘴钳

160 mm **DIN 5745** **NICKEL PLATED NIKLOWANE**



YATO	L [mm]	
YT-2030	160	6/60

EN Wire stripping pliers
PL Szczypce do ściągania izolacji
DE Abisolierzange
RU Пасатики для зачистки проводов
CZ Kleště odizolovací na drát
HU Blankoló fogó
RO Decablator
FR Pince à l'isolation
IT Pinze spelafili
ES Pinzas pelacables
CN 剥线钳



160
mm

DIN
5745

NICKEL
PLATED
NIKLOWANE



YATO	L [mm]	
YT-2031	160	6/60

EN Combination pliers
PL Szczypce uniwersalne
DE Kombinationszange
RU Плоскогубцы универсальные
CZ Kleště kombinované
HU Kombináltfogó

RO Patent universal
FR Pince universelle
IT Pinze universali
ES Alicates universales
CN 钢丝钳

HRC
55-62

CrV



YATO	L [mm]	
YT-6600	160	6/60
YT-6601	180	6/60
YT-6602	200	6/36

EN Diagonal side cutting pliers
PL Szczypce tnące boczne
DE Seitenschneider
RU Бокорезы
CZ Řezací kleště boční
HU Oldal csipőfogó
RO Clește pt. tăiat lateral
FR Pince à coupe latérale
IT Pinze taglianti laterali
ES Alicates corte lateral
CN 重型斜嘴钳



180
mm

HRC
55-62

CrV



YATO	L [mm]	
YT-6612	180	6/60

EN Diagonal side cutting pliers
PL Szczypce tnące boczne
DE Seitenschneider
RU Бокорезы
CZ Řezací kleště boční
HU Oldal csipőfogó

RO Clește pt. tăiat lateral
FR Pince à coupe latérale
IT Pinze taglianti laterali
ES Alicates corte lateral
CN 省力斜嘴钳

160
mm

HIGH
LEVERAGE
ZWIĘKSZONA
SIŁA NACISKU



YATO	L [mm]	
YT-6583	160	6/60

EN Double joint bent nose pliers
PL Szczypce wydłużone wygięte przegubowe
DE Kneifzange verlängert gebogen 2 Gelenke
RU Плоскогубцы изогнутые 2 шарнира
CZ Prodloužené kleště zahnuté se zdvojeným kloubem
HU Hosszú hajlított 2 csuklós fogó

RO Clește cu vârf scutit curbat
FR Pince allongée coude à 2 articulations
IT Pinza lunga piegata con 2 giunti
ES Alicates de pinzas largas curvadas 2 articulaciones
CN 弯嘴钳

330
mm

45°

HRC
50

CrV



YATO	L [mm]	
YT-20401	330	5/50

EN End cutting pliers
PL Szczypce tnące czolowe
DE Vornscheider
RU Кусачки торцевые
CZ Kleště štípačí čelní
HU Homlokcsipő fogó
RO Clește pt. retezat
FR Coupe avant
IT Pinza a taglio laterale
ES Cortacables frontales
CN 顶切钳



DIN
5748

NICKEL
PLATED
NIKLOWANE



YATO	L [mm]	
YT-2066	160	6/60
YT-2067	180	6/60

EN Diagonal side cutting pliers
PL Szczypce tnące boczne
DE Seitenschneider
RU Бокорезы
CZ Řezací kleště boční
HU Oldal csipőfogó

RO Clește pt. tăiat lateral
FR Pince à coupe latérale
IT Pinze taglianti laterali
ES Alicates corte lateral
CN 斜嘴钳

HRC
55-62

CrV



YATO	L [mm]	
YT-6610	160	6/60
YT-6611	180	6/60

EN Combination pliers
PL Szczypce uniwersalne
DE Kombinationszange
RU Плоскогубцы универсальные
CZ Kleště kombinované
HU Kombináltfogó

RO Patent universal
FR Pince universelle
IT Pinze universali
ES Alicates universales
CN 省力钢丝钳

HIGH
LEVERAGE
ZWIĘKSZONA
SIŁA NACISKU



YATO	L [mm]	
YT-6581	160	6/60
YT-6582	200	6/36

EN Double joint long nose pliers
PL Szczypce wydłużone proste przegubowe
DE Kneifzange verlängert gerade 2 Gelenke
RU Плоскогубцы прямые 2 шарнира
CZ Prodloužené kleště rovné se zdvojeným kloubem
HU Hosszú egyenes 2 csuklós fogó

RO Clește cu falci lungi
FR Pince allongée droite à 2 articulations
IT Pinza lunga dritta con 2 giunti
ES Alicates de pinzas largas rectas 2 articulaciones
CN 尖嘴钳

340
mm

HRC
50

CrV



YATO	L [mm]	
YT-20400	340	5/50

EN Double joint bent nose pliers
PL Szczypce wydłużone wygięte przegubowe
DE Kneifzange verlängert gebogen 2 Gelenke
RU Плоскогубцы изогнутые 2 шарнира
CZ Prodloužené kleště zahnuté se zdvojeným kloubem
HU Hosszú hajlított 2 csuklós fogó

RO Clește cu vârf scutit curbat
FR Pince allongée coude à 2 articulations
IT Pinza lunga piegata con 2 giunti
ES Alicates de pinzas largas curvadas 2 articulaciones
CN 弯嘴钳

330
mm

90°

HRC
50

CrV





YATO	L [mm]	
YT-20402	330	5/50

EN Combination pliers
 PL Szczypce uniwersalne
 DE Kombinationszange
 RU Плоскогубцы универсальные
 CZ Kleště kombinované
 HU Kombináltfogó
 RO Patent universal
 FR Pince universelle
 IT Pinze universali
 ES Alicates universales
 CN 迷你钢丝钳

115 mm
 NICKEL PLATED
 NIKLOWANE 



YATO  L [mm] 
 YT-2080 115 6/120

EN Diagonal side cutting pliers
 PL Szczypce tnące boczne
 DE Seitenschneider
 RU Бокорезы
 CZ Řezací kleště boční
 HU Oldal csípőfogó
 RO Clește pt. tăiat lateral
 FR Pince à coupe latérale
 IT Pinze taglianti laterali
 ES Alicates corte lateral
 CN 迷你斜口钳

115 mm
 NICKEL PLATED
 NIKLOWANE 



YATO  L [mm] 
 YT-2081 115 6/120

EN Long nose pliers
 PL Szczypce wydłużone proste
 DE Radiozange gebogen
 RU Тонкогубцы удлиненные прямые
 CZ Prodloužené kleště rovné
 HU Rádiófogó egyenes
 RO Clește cu vârf lung ascuțit
 FR Pince à bec long
 IT Pinza lunga dritta
 ES Alicates de punta rectos
 CN 尖嘴钳

115 mm
 NICKEL PLATED
 NIKLOWANE 



YATO  L [mm] 
 YT-2083 115 6/120

EN Bent nose pliers
 PL Szczypce wydłużone wygięte
 DE Radiozange gerade
 RU Тонкогубцы удлиненные изогнутые
 CZ Prodloužené kleště ohnuté
 HU Rádiófogó hajlított
 RO Patent cu vârf ascuțit indoit
 FR Pince à bec coudé
 IT Pinza lunga piegata
 ES Alicates de punta curva
 CN 弯嘴钳

115 mm
 NICKEL PLATED
 NIKLOWANE 





YATO  L [mm] 
 YT-2084 115 6/120

EN Flat nose pliers
 PL Szczypce płaskie
 DE Flachzange
 RU Плоскогубцы удлиненные
 CZ Kleště ploché
 HU Rádiófogó, egyenes
 RO Clește cu vârf ascuțit
 FR Pince plate
 IT Pinze piatte
 ES Alicates de bocas planas
 CN 迷你平口钳

115 mm
 NICKEL PLATED
 NIKLOWANE 



YATO  L [mm] 
 YT-2085 115 6/120

EN Round nose pliers
 PL Szczypce okrągłe
 DE Rundzange
 RU Круглогубцы
 CZ Kleště kulaté
 HU Kerekcsőrű fogó
 RO Clește rotund
 FR Pince ronde
 IT Pinze tonde
 ES Alicates de punta redonda
 CN 迷你圆嘴钳

115 mm
 NICKEL PLATED
 NIKLOWANE 



YATO  L [mm] 
 YT-2086 115 6/120

EN End cutting pliers
 PL Szczypce tnące czolowe
 DE Vornsneider
 RU Кусачки торцевые
 CZ Kleště štípací čelní
 HU Homlokcsípő fogó
 RO Clește pt. retezat
 FR Coupe devant
 IT Pinza a taglio laterale
 ES Cortacables frontales
 CN 迷你顶切钳

115 mm
 NICKEL PLATED
 NIKLOWANE 



YATO  L [mm] 
 YT-2082 115 6/120

EN Diagonal side cutting pliers
PL Szczypce tnące boczne
DE Seitenschneider
RU Бокорезы
CZ Řezací kleště boční
HU Oldal csípőfogó
RO Clește pt. tăiat lateral
FR Pince à coupe latérale
IT Pinze taglianti laterali
ES Alicates corte lateral
CN 塑料水口钳



125 mm



max \varnothing 3.0 mm

HRC 56-62

HRC 43-48

CrV 60



YATO 	L [mm]	
YT-1950	125	6/120

EN Diagonal side cutting pliers
PL Szczypce tnące boczne
DE Seitenschneider
RU Бокорезы
CZ Řezací kleště boční
HU Oldal csípőfogó
RO Clește pt. tăiat lateral
FR Pince à coupe latérale
IT Pinze taglianti laterali
ES Alicates corte lateral
CN 塑料水口钳



150 mm



max \varnothing 5.0 mm

HRC 56-62

HRC 43-48

CrV 60



YATO 	L [mm]	
YT-1951	150	6/120

EN Diagonal side cutting pliers
PL Szczypce tnące boczne
DE Seitenschneider
RU Бокорезы
CZ Řezací kleště boční
HU Oldal csípőfogó
RO Clește pt. tăiat lateral
FR Pince à coupe latérale
IT Pinze taglianti laterali
ES Alicates corte lateral
CN 塑料水口钳



180 mm



max \varnothing 6.0 mm

HRC 56-62

HRC 43-48

CrV 60



YATO 	L [mm]	
YT-1952	180	6/60

EN Diagonal side cutting pliers
PL Szczypce tnące boczne
DE Seitenschneider
RU Бокорезы
CZ Řezací kleště boční
HU Oldal csípőfogó
RO Clește pt. tăiat lateral
FR Pince à coupe latérale
IT Pinze taglianti laterali
ES Alicates corte lateral
CN 电子斜嘴钳



100 mm

max \varnothing 1.0 mm
STEEL
STAL



max \varnothing 1.8 mm
Cu

HRC 56-62

HRC 43-48

CrV 60



YATO 	L [mm]	
YT-1953	100	6/120

EN Diagonal side cutting pliers
PL Szczypce tnące boczne
DE Seitenschneider
RU Бокорезы
CZ Řezací kleště boční
HU Oldal csípőfogó
RO Clește pt. tăiat lateral
FR Pince à coupe latérale
IT Pinze taglianti laterali
ES Alicates corte lateral
CN 电子斜嘴钳



125 mm

max \varnothing 1.2 mm
STEEL
STAL

max \varnothing 2.0 mm
Cu

HRC 56-62

HRC 43-48

CrV 60



YATO 	L [mm]	
YT-1954	125	6/120

EN Long nose pliers
PL Szczypce wydłużone proste
DE Radiozange gebogen
RU Тонкогубцы удлиненные прямые
CZ Prodloužené kleště rovné
HU Rádiófogó egyenes
RO Clește cu vârf lung ascuțit
FR Pince à bec long
IT Pinza lunga dritta
ES Alicates de punta rectos
CN 尖嘴钳



150 mm

max \varnothing 1.5 mm
STEEL
STAL

max \varnothing 2.6 mm
Cu

HRC 56-62

HRC 43-48

CrV 60



YATO 	L [mm]	
YT-1956	150	6/120

EN Carpenter's pliers
 PL Obcegi
 DE Kneifzange
 RU Клещи строительные
 CZ Kleště
 HU Harapófogó
 RO Cleste cuie
 FR Tenailles
 IT Tenaglie
 ES Tenazas
 CN 胡桃钳

DIN 5748 **NICKEL PLATED NIKLOWANE**



YATO	L [mm]	
YT-2046	160	6/60
YT-2047	180	6/60
YT-2048	200	6/60

EN Tower pincers
 PL Obcegi tynkarskie
 DE Beisszange
 RU Клещи штукатурные
 CZ Kleště štrpáci čelní
 HU Rabitzfogó
 RO Cleste pt. cuie
 FR Tenaille russe
 IT Tenaglie tronchesi
 ES Tenazas de enlucido
 CN 扎线钳

DIN 5748 **NICKEL PLATED NIKLOWANE**



YATO	L [mm]	
YT-2058	200	6/60
YT-2060	250	6/36
YT-2061	275	6/36

6

EN Tower pincers
 PL Obcegi tynkarskie
 DE Beisszange
 RU Клещи штукатурные
 CZ Kleště štrpáci čelní
 HU Rabitzfogó
 RO Cleste pt. cuie
 FR Tenaille russe
 IT Tenaglie tronchesi
 ES Tenazas de enlucido
 CN 木工铅笔

250 mm **DIN 5746** **HRC 44-50** **HRC 58-62** **CrV 55**



YATO	L [mm]	
YT-1949	250	6/36

EN Heavy duty side cutting pliers
 PL Szczypce tnące boczne
 DE Seitenschneider, Schwer Typ
 RU Бокорезы усиленные
 CZ Řezací kleště boční
 HU Oldal csípőfogó
 RO Clește tăietor
 FR Pince à coupe latérale
 IT Pinze taglianti laterali
 ES Alicates de corte lateral tipo pesado
 CN 重型斜口钳

180 mm **DIN 5749** **NICKEL PLATED NIKLOWANE**



YATO	L [mm]	
YT-2039	180	6/60

EN Carpenter's pliers
 PL Obcegi
 DE Kneifzange
 RU Клещи строительные
 CZ Kleště
 HU Harapófogó
 RO Cleste cuie
 FR Tenailles
 IT Tenaglie
 ES Tenazas
 CN 胡桃钳

HRC 55-60 **CrV 50**



YATO	L [mm]	Max. cutting capacity in cold rolled steel / Maks. grubość cięcia w stali walcowanej na zimno [mm]	
YT-2050	150	1.5	6/60
YT-2051	175	1.8	6/60
YT-2052	200	2.0	6/48

EN Tower pincers
 PL Obcegi tynkarskie
 DE Beisszange
 RU Клещи штукатурные
 CZ Kleště štrpáci čelní
 HU Rabitzfogó
 RO Cleste pt. cuie
 FR Tenaille russe
 IT Tenaglie tronchesi
 ES Tenazas de enlucido
 CN 扎线钳

HRC 55-62 **CrV 50**



YATO	L [mm]	Max. cutting capacity in cold rolled steel / Maks. grubość cięcia w stali walcowanej na zimno [mm]	
YT-2055	225	1.8	6/60
YT-2056	250	2.0	6/48
YT-2057	275	2.2	6/24

EN End cutting pliers
 PL Szczypce tnące czolowe
 DE Vornschneider
 RU Кусачки торцевые
 CZ Kleště štrpáci čelní
 HU Homlokcsípő fogó
 RO Clește pt. relezat
 FR Coupe devant
 IT Pinza a taglio laterale
 ES Cortacables frontales
 CN 顶切钳

HRC 55-60 **CrV 50**



YATO	L [mm]	Max. cutting capacity in cold rolled steel / Maks. grubość cięcia w stali walcowanej na zimno [mm]	
YT-2063	175	1.5	6/48
YT-2064	200	1.8	6/48

EN Circlip pliers
 PL Szczypce Seegera
 DE Seegering-Zange
 RU Съёмник стопорных колец
 CZ Kleště na pojistné kroužky
 HU Seegerfogó

RO Clește Seger
 FR Pince à anneau Seeger
 IT Pinza per anelli Seeger
 ES Alicates Seger
 CN 挡圈钳

5 PCS

160 mm **10-50 mm**



	23 mm max.	20 mm max.
	28 mm max.	23 mm max.
	30 mm max.	27 mm max.

YATO	L [mm]	
YT-2130	160	20/60

EN Circlip pliers
PL Szczypce Segera
DE Seegering-Zange
RU Съёмник стопорных колец
CZ Kleště na pojistné kroužky
HU Seegerfogó

RO Clește Seger
FR Pince à anneau Seeger
IT Pinza per anelli Seeger
ES Alicata Seger
CN 挡圈钳

180
mm



HRC
42-48

CrV
50



YATO	L [mm]	
YT-2136	180	6/24

EN Circlip pliers
PL Szczypce Segera
DE Seegering-Zange
RU Съёмник стопорных колец
CZ Kleště na pojistné kroužky
HU Seegerfogó

RO Clește Seger
FR Pince à anneau Seeger
IT Pinza per anelli Seeger
ES Alicata Seger
CN 挡圈钳

180
mm



HRC
42-48

CrV
50



YATO	L [mm]	
YT-2137	180	6/24

EN Circlip pliers
PL Szczypce Segera
DE Seegering-Zange
RU Съёмник стопорных колец
CZ Kleště na pojistné kroužky
HU Seegerfogó

RO Clește Seger
FR Pince à anneau Seeger
IT Pinza per anelli Seeger
ES Alicata Seger
CN 挡圈钳



CrV



NICKEL
PLATED
NIKLOWANE



YATO	L [mm]	
YT-2140	150	6/120
YT-2144	200	6/60

EN Circlip pliers
PL Szczypce Segera
DE Seegering-Zange
RU Съёмник стопорных колец
CZ Kleště na pojistné kroužky
HU Seegerfogó

RO Clește Seger
FR Pince à anneau Seeger
IT Pinza per anelli Seeger
ES Alicata Seger
CN 挡圈钳



CrV



NICKEL
PLATED
NIKLOWANE



YATO	L [mm]	
YT-2142	150	6/60
YT-2146	200	6/60

EN Circlip pliers
PL Szczypce Segera
DE Seegering-Zange
RU Съёмник стопорных колец
CZ Kleště na pojistné kroužky
HU Seegerfogó

RO Clește Seger
FR Pince à anneau Seeger
IT Pinza per anelli Seeger
ES Alicata Seger
CN 挡圈钳

180
mm



HRC
42-48

CrV
50



YATO	L [mm]	
YT-2138	180	6/24

EN Circlip pliers
PL Szczypce Segera
DE Seegering-Zange
RU Съёмник стопорных колец
CZ Kleště na pojistné kroužky
HU Seegerfogó

RO Clește Seger
FR Pince à anneau Seeger
IT Pinza per anelli Seeger
ES Alicata Seger
CN 挡圈钳

180
mm



HRC
42-48

CrV
50



YATO	L [mm]	
YT-2139	180	6/24

EN Circlip pliers
PL Szczypce Segera
DE Seegering-Zange
RU Съёмник стопорных колец
CZ Kleště na pojistné kroužky
HU Seegerfogó

RO Clește Seger
FR Pince à anneau Seeger
IT Pinza per anelli Seeger
ES Alicata Seger
CN 挡圈钳



CrV



NICKEL
PLATED
NIKLOWANE



YATO	L [mm]	
YT-2141	150	6/120
YT-2145	200	6/60

EN Circlip pliers
PL Szczypce Segera
DE Seegering-Zange
RU Съёмник стопорных колец
CZ Kleště na pojistné kroužky
HU Seegerfogó

RO Clește Seger
FR Pince à anneau Seeger
IT Pinza per anelli Seeger
ES Alicata Seger
CN 挡圈钳



CrV



NICKEL
PLATED
NIKLOWANE



YATO	L [mm]	
YT-2143	150	6/120
YT-2147	200	6/60

EN Circlip pliers
 PL Szczypce Segeera
 DE Seegering-Zange
 RU Съёмник стопорных колец
 CZ Kleště na pojistné kroužky
 HU Segeerfogó

RO Clește Seger
 FR Pince à anneau Seeger
 IT Pinza per anelli Seeger
 ES Alicata Seger
 CN 挡圈钳



YATO	L [mm]	
YT-1988	225	6/60
YT-1992	325	6/48

EN Circlip pliers
 PL Szczypce Segeera
 DE Seegering-Zange
 RU Съёмник стопорных колец
 CZ Kleště na pojistné kroužky
 HU Segeerfogó

RO Clește Seger
 FR Pince à anneau Seeger
 IT Pinza per anelli Seeger
 ES Alicata Seger
 CN 挡圈钳



YATO	L [mm]	
YT-1990	225	6/60
YT-1994	325	6/48

EN Circlip pliers
 PL Szczypce Segeera
 DE Seegering-Zange
 RU Съёмник стопорных колец
 CZ Kleště na pojistné kroužky
 HU Segeerfogó

RO Clește Seger
 FR Pince à anneau Seeger
 IT Pinza per anelli Seeger
 ES Alicata Seger
 CN 挡圈钳

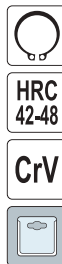

YATO	Working capacity / Zakres pracy [mm]	L [mm]	
YT-19951	3-9	140	6/48
YT-19952	10-25	140	6/48
YT-19953	19-60	180	6/48
YT-19954	40-100	230	6/24
YT-19955	85-200	320	4/24

EN Circlip pliers
 PL Szczypce Segeera
 DE Seegering-Zange
 RU Съёмник стопорных колец
 CZ Kleště na pojistné kroužky
 HU Segeerfogó

RO Clește Seger
 FR Pince à anneau Seeger
 IT Pinza per anelli Seeger
 ES Alicata Seger
 CN 挡圈钳



YATO	Working capacity / Zakres pracy [mm]	L [mm]	
YT-19965	3-9	130	6/48
YT-19966	10-25	130	6/48
YT-19971	19-60	160	6/48
YT-19972	40-100	210	4/24
YT-19973	85-200	300	4/24

EN Circlip pliers
 PL Szczypce Segeera
 DE Seegering-Zange
 RU Съёмник стопорных колец
 CZ Kleště na pojistné kroužky
 HU Segeerfogó

RO Clește Seger
 FR Pince à anneau Seeger
 IT Pinza per anelli Seeger
 ES Alicata Seger
 CN 挡圈钳



YATO	L [mm]	
YT-1989	225	6/60
YT-1993	325	6/48

EN Circlip pliers
 PL Szczypce Segeera
 DE Seegering-Zange
 RU Съёмник стопорных колец
 CZ Kleště na pojistné kroužky
 HU Segeerfogó

RO Clește Seger
 FR Pince à anneau Seeger
 IT Pinza per anelli Seeger
 ES Alicata Seger
 CN 挡圈钳



YATO	L [mm]	
YT-1991	225	6/60
YT-1995	325	6/48

EN Circlip pliers
 PL Szczypce Segeera
 DE Seegering-Zange
 RU Съёмник стопорных колец
 CZ Kleště na pojistné kroužky
 HU Segeerfogó

RO Clește Seger
 FR Pince à anneau Seeger
 IT Pinza per anelli Seeger
 ES Alicata Seger
 CN 挡圈钳



YATO	Working capacity / Zakres pracy [mm]	L [mm]	
YT-19961	3-10	140	6/48
YT-19962	10-25	140	6/48
YT-19963	19-60	175	6/48
YT-19964	40-100	225	4/24

EN Circlip pliers
 PL Szczypce Segeera
 DE Seegering-Zange
 RU Съёмник стопорных колец
 CZ Kleště na pojistné kroužky
 HU Segeerfogó

RO Clește Seger
 FR Pince à anneau Seeger
 IT Pinza per anelli Seeger
 ES Alicata Seger
 CN 挡圈钳

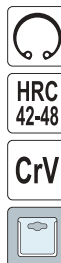



YATO	Working capacity / Zakres pracy [mm]	L [mm]	
YT-19974	8-13	145	6/48
YT-19975	12-25	145	6/48
YT-19976	19-60	185	6/48
YT-19977	40-100	235	6/24
YT-19979	85-200	325	4/24

EN Circlip pliers
PL Szczypce Segera
DE Seegering-Zange
RU Съёмник стопорных колец
CZ Kleště na pojistné kroužky
HU Seegerfogó

RO Clește Seger
FR Pince à anneau Seeger
IT Pinza per anelli Seeger
ES Alicata Seger
CN 挡圈钳





YATO 	Working capacity / Zakres pracy [mm]	L [mm]	
YT-19981	8-13	140	6/48
YT-19982	12-25	140	6/48
YT-19983	19-60	180	6/48
YT-19984	40-100	230	4/24

EN Circlip pliers
PL Szczypce Segera
DE Seegering-Zange
RU Съёмник стопорных колец
CZ Kleště na pojistné kroužky
HU Seegerfogó

RO Clește Seger
FR Pince à anneau Seeger
IT Pinza per anelli Seeger
ES Alicata Seger
CN 挡圈钳





YATO 	Working capacity / Zakres pracy [mm]	L [mm]	
YT-19991	8-13	130	6/48
YT-19992	12-25	130	6/48
YT-19993	19-60	170	6/48
YT-19994	40-100	220	4/24
YT-19995	85-200	305	4/24

EN Lock grip pliers
PL Szczypce Morse'a
DE Gripzange
RU Зажим ручной

CZ Kleště Morse'a
HU Morse fogó
RO Clește autoblocant
FR Pincés de serrage Morse

IT Pinze Morse
ES Alicates Morse
CN 圆口大力钳





YATO 	L [mm]	
YT-2151	140	6/48
YT-2152	180	6/36
YT-2153	240	6/36

EN Locking pliers
PL Szczypce zaciskowe
DE Klemmzange
RU Клещи давяльные

CZ Kleště samosvorné
HU Patentfogó
RO Clește autoblocant
FR Pincés de serrage Morse

IT Pinze Morse
ES Pinzas de tornillo (de apriete)
CN 圆口大力钳



YATO 	L [mm]	
YT-2449	125	6/24

EN Locking pliers
PL Szczypce zaciskowe
DE Klemmzange
RU Клещи давяльные
CZ Kleště samosvorné
HU Patentfogó

RO Clește autoblocant
FR Pincés de serrage Morse
IT Pinze Morse
ES Pinzas de tornillo (de apriete)
CN 圆口大力钳





YATO 	L [mm]	
YT-2450	180	6/24

EN Lock grip pliers
PL Clește autoblocant
DE Gripzange
RU Зажим ручной

CZ Kleště Morse'a
HU Morse fogó
RO Clește Morse
FR Pincés de serrage Morse

IT Pinze Morse
ES Alicates Morse
CN 尖嘴大力钳





YATO 	L [mm]	
YT-2155	165	6/48
YT-2156	220	6/36

EN Locking pliers
PL Szczypce zaciskowe
DE Klemmzange
RU Клещи давяльные

CZ Kleště samosvorné
HU Patentfogó
RO Clește autoblocant
FR Pincés de serrage Morse

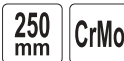
IT Pinze Morse
ES Pinzas de tornillo (de apriete)
CN 直口大力钳



YATO 	L [mm]	
YT-2453	250	6/24

EN Locking pliers
PL Szczypce zaciskowe
DE Klemmzange
RU Клещи давяльные
CZ Kleště samosvorné
HU Patentfogó

RO Clește autoblocant
FR Pincés de serrage Morse
IT Pinze Morse
ES Pinzas de tornillo (de apriete)
CN 圆口大力钳

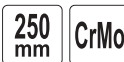

YATO 	L [mm]	
YT-2451	250	6/24

EN Locking pliers
 PL Szczypce zaciskowe
 DE Klemmzange
 RU Клещи давяльные
 CZ Kleště samosvorné
 HU Patentfogó

RO Clește autoblocant
 FR Pincés de serrage Morse
 IT Pinze Morse
 ES Pinzas de tornillo (de apriete)
 CN 尖嘴大力钳

150 mm CrMo



YATO	L [mm]	
YT-2459	150	6/24

EN Locking pliers
 PL Szczypce zaciskowe
 DE Klemmzange
 RU Клещи давяльные
 CZ Kleště samosvorné
 HU Patentfogó

RO Clește autoblocant
 FR Pincés de serrage Morse
 IT Pinze Morse
 ES Pinzas de tornillo (de apriete)
 CN 直口大力钳

180 mm CrMo



YATO	L [mm]	
YT-2452	180	6/24

EN Locking pliers
 PL Szczypce zaciskowe
 DE Klemmzange
 RU Клещи давяльные
 CZ Kleště samosvorné
 HU Patentfogó

RO Clește autoblocant
 FR Pincés de serrage Morse
 IT Pinze Morse
 ES Pinzas de tornillo (de apriete)
 CN 大力钳

250 mm 0-42 mm

CrMo



YATO	L [mm]	
YT-2476	250	6/24

EN Locking pliers
 PL Szczypce zaciskowe
 DE Klemmzange
 RU Клещи давяльные
 CZ Kleště samosvorné
 HU Patentfogó

RO Clește autoblocant
 FR Pincés de serrage Morse
 IT Pinze Morse
 ES Pinzas de tornillo (de apriete)
 CN 尖嘴大力钳

225 mm CrMo



YATO	L [mm]	
YT-2460	225	6/24

EN Locking pliers
 PL Szczypce zaciskowe
 DE Klemmzange
 RU Клещи давяльные
 CZ Kleště samosvorné
 HU Patentfogó

RO Clește autoblocant
 FR Pincés de serrage Morse
 IT Pinze Morse
 ES Pinzas de tornillo (de apriete)
 CN 大力钳

250 mm 0-42 mm

CrMo



YATO	L [mm]	
YT-2473	250	6/24

EN Sliding arm welding locking pliers
 PL Szybkonastawne szczypce spawalnicze
 DE Parallel-gripzange
 RU Образная струбцина с захватом
 CZ Paralelné samosvorné kleště
 HU Szorítórúdas önzáró fogó
 RO Clește autoblocant cu picior
 FR Pince-étai - serre-joint coulissant
 IT Pinze regolabili autobloccanti
 ES Pinzas de presión tipo sargento
 CN 大力钳

260 mm 0-150 mm

QUICK ADJUSTMENT SZYBKĄ REGULACJĄ



YATO	L [mm]	
YT-21570	260	2/16

EN Welding locking pliers
PL Szczypce zaciskowe spawalnicze
DE Klemmzange zum Schweißen
RU Клещи давяльные сварочные
CZ Kleště samosvorné svářečské
HU Hegesztő fogó

RO Clește autoblocant pt. sudură
FR Pincés de serrage pour soudeur
IT Pinze di bloccaggio per saldatura
ES Pinzas de tornillo (de apriete) para soldar
CN 焊接用大力钳

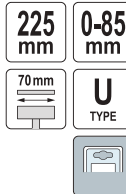

YATO	L [mm]	
YT-2461	225	6/24

EN C-type welding locking pliers
PL Szczypce zaciskowe kłamrowe typu „C”
DE Klemm- und Klammerzange vom Typ „C”
RU Клещи давяльные типа „C”
CZ Kleště samosvorné upínací typu „C”
HU „C” fogó

RO Clește autoblocant cu clemă tip „C”
FR Pince de serrage type „C”
IT Pinze di bloccaggio tipo „C”
ES Pinzas de tornillo (de apriete) de grapa tipo „C”
CN C型大力钳

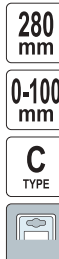

YATO	L [mm]	
YT-2466	280	6/24

EN Chain locking pliers
PL Szczypce zaciskowe z łańcuchem
DE Klemmzange mit Kette
RU Клещи давяльные с цепью
CZ Kleště samosvorné s řetězem
HU Láncos csőfogó

RO Clește autoblocant cu lanț
FR Pince de serrage avec une chaîne
IT Pinze di bloccaggio con la catena
ES Pinzas de tornillo (de apriete) con cadena
CN 链条大力钳

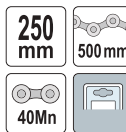

YATO	L [mm]	
YT-2469	250	6/24

EN Flat locking pliers
PL Szczypce zaciskowe o szerokich szczękach
DE Klemmzange mit breiten Backen
RU Клещи давяльные с широкими губками
CZ Kleště samosvorné se širokými čelistmi
HU Lapos fogó

RO Clește autoblocant
FR Pince de serrage large
IT Pinze con ganasce piane e palette
ES Pinzas de tornillo (de apriete) con mordazas anchas
CN 铁皮大力钳



YATO	L [mm]	
YT-2463	200	6/24

EN C-type welding locking pliers
PL Szczypce zaciskowe kłamrowe typu „C”
DE Klemm- und Klammerzange vom Typ „C”
RU Клещи давяльные типа „C”
CZ Kleště samosvorné upínací typu „C”
HU „C” fogó

RO Clește autoblocant cu clemă tip „C”
FR Pince de serrage type „C”
IT Pinze di bloccaggio tipo „C”
ES Pinzas de tornillo (de apriete) de grapa tipo „C”
CN C型大力钳

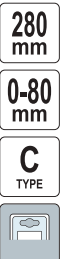

YATO	L [mm]	
YT-2468	280	6/24

EN Stud crimper
PL Szczypce do łączenia profili
DE Profil-Verbundzange
RU Щипцы для соединения профилей
CZ Kleště na spojování profilů
HU Profilösszekítő fogó

RO Clește pt. îmbinare profile
FR Pince à sertir les profilés
IT Pinza per assemblaggio profili
ES Pinzas para unir perfiles
CN 龙骨钳



YATO	L [mm]	
YT-5130	275	6/24

EN Stud crimper
 PL Szczypce do łączenia profili
 DE Profil-Verbundzange
 RU Щипцы для соединения профилей
 CZ Kleště na spojování profilů
 HU Profilösszekítő fogó

RO Clește pt. îmbinare profile
 FR Pince à sertir les profilés
 IT Pinza per assemblaggio profili
 ES Pinzas para unir perfiles
 CN 龙骨钳

345 mm
 0.5-0.8 mm SECTION THICKNESS GRUBOSC PROFILU
65Mn
 PUNCH PUNCTAX



YATO	L [mm]	
YT-5131	345	6/24

EN Stud crimper
 PL Szczypce do łączenia profili
 DE Profil-Verbundzange
 RU Щипцы для соединения профилей
 CZ Kleště na spojování profilů
 HU Profilösszekítő fogó

RO Clește pt. îmbinare profile
 FR Pince à sertir les profilés
 IT Pinza per assemblaggio profili
 ES Pinzas para unir perfiles
 CN 龙骨钳

260 mm
 0.5-0.8 mm SECTION THICKNESS GRUBOSC PROFILU
ST12
65Mn
 PUNCH PUNCTAX



YATO	L [mm]	
YT-51312	260	6/24

EN Stud crimper
 PL Szczypce do łączenia profili
 DE Profil-Verbundzange
 RU Щипцы для соединения профилей
 CZ Kleště na spojování profilů
 HU Profilösszekítő fogó

RO Clește pt. îmbinare profile
 FR Pince à sertir les profilés
 IT Pinza per assemblaggio profili
 ES Pinzas para unir perfiles
 CN 龙骨钳

280 mm
 0.5-0.8 mm SECTION THICKNESS GRUBOSC PROFILU
A380
AITi
 HEAD GLOWICA
GR15
 PUNCH PUNCTAX



YATO	L [mm]	
YT-51311	280	6/24

EN Stud crimper
 PL Szczypce do łączenia profili
 DE Profil-Verbundzange
 RU Щипцы для соединения профилей
 CZ Kleště na spojování profilů
 HU Profilösszekítő fogó

320 mm
HRC 50
40Cr

320 mm
HRC 50
40Cr



YATO	L [mm]	
YT-51303	320	6/24

EN Punch pliers
 PL Szczypce do dziurkowania blach
 DE Blech Lochzange
 RU Просекатель круглых отверстий
 CZ Děrovačí kleště
 HU Fogó peremező lyukasztó

RO Clește pt. perforat
 FR Trou pincés feuilles
 IT Pinza per forare lamiera
 ES Punzonadora una mano perfiles
 CN 打孔钳

240 mm
3.2 mm
GR15
 PUNCH PUNCTAX



YATO	L [mm]	
YT-51320	240	5/30

EN Punch kit
 PL Ręczny dziurkacz do blach
 DE Handlochstanze für Blech
 RU Ручной перфоратор для листового металла
 CZ Ruční děrovač plechů
 HU Kézi fémlemez lyukasztó
 RO Set cleste perforat
 FR Perforateur à main pour tôle
 IT Punzonatrice manuale per lamiera
 ES Perforadora manual para chapas
 CN 打孔钳

16 PCS
 max **1.0 mm**
 PLATE BLAGRA

16 PCS
 max **1.0 mm**
 PLATE BLAGRA



Ø 2, 3, 4, 4.5, 5.5, 6, 7 mm

YATO	
YT-18973	12

EN Profile forming pliers
 PL Szczypce do kształtowania profili
 DE Zange zur Formgebung der Profile
 RU Щипцы для формовки профилей

CZ Kleště k tvarování profilů
 HU Profilformázó fogó
 RO Clește pt. modelarea profilelor
 FR Pince pour former les profiles

IT Pinze per la formazione di profili
 ES Pinzas para formar perfiles
 CN 龙骨钳

210 mm



80x35 mm

YATO	L [mm]	
YT-5140	210	2/12



80x35 mm

YATO	L [mm]	
YT-5141	210	2/12



150x35 mm

YATO	L [mm]	
YT-5142	210	2/12

Memo



7

Electrician tools
Narzędzia
dla elektryków





Insulated screwdrivers Wkrętki izolowane		122-123
--	---	---------

Insulated slotted screwdrivers Wkrętki izolowane płaskie	122
Insulated phillips screwdrivers Wkrętki izolowane krzyżakowe	122
Insulated Pozidrive screwdrivers Wkrętki izolowane „Pozidrive”	122
Insulated screwdriver sets Komplety wkrętek izolowanych	122

Insulated pliers Szczypce izolowane		123-124
---	---	---------

Combination pliers Szczypce uniwersalne	123
Side cutting pliers Szczypce tnące, boczne	123
Long nose pliers Szczypce wydłużone, proste	123
Wire stripping pliers Szczypce do ściągania izolacji	123
Water pump pliers Szczypce nastawne	124
Insulated flat nose pliers Klucze płaskie izolowane	124

Insulated open end wrenches Klucze płaskie izolowane		124
--	--	-----

Insulated T-handle wrenches Rękojeści typu „T” z zabierakiem izolowane		124
--	---	-----

Insulated adjustable wrenches Klucze nastawne izolowane		124
---	---	-----

Insulated sockets & accessories Klucze nasadowe izolowane i akcesoria		124
---	---	-----

Insulated ratchet handles 1/2” Grzechotki izolowane 1/2”	124
--	-----

Insulated clamps Ściski izolowane		124
---	---	-----

Crimping pliers & sets Szczypce do zaciskania konektorów i zestawy		125-128
--	---	---------

Hydraulic pliers & accessories Ręczne praski hydrauliczne i akcesoria		128
---	---	-----

Wire strippers Ściągacze izolacji		128-130
---	---	---------

Electrical cutters Obcinaki elektryczne		130-132
---	---	---------

Cable cutters Nożyce do kabli		133-134
---	---	---------

Electric meters & voltage testers Mierniki elektryczne i próbniki napięcia		134-136
--	---	---------

Multimeters Mierniki		136-138
--------------------------------	--	---------

Tweezers Pęsety		139
---------------------------	---	-----

Tapes & sets Taśmy i zestawy		139-140
--	---	---------

Tool sets Zestawy narzędziowe		140
---	---	-----

Cable access & accessories Przepychacze przewodów i akcesoria		141
---	---	-----

EN Insulated screwdriver
 PL Wkrętkak izolowany
 DE Isolierte Schraubendreher
 RU Изолированная отвёртка
 CZ Izolovaný šroubovák
 HU Szigetelt csavarhúzó
 RO Şurubelniţă izolată
 FR Tournevis isolé
 IT Cacciavite isolato
 ES Destornillador aislado
 CN 绝缘螺丝批

HRC 56-60 S2 1000 V



YATO	⊖ [mm]	L [mm]	📦
YT-28150	2.5	75	12/360
YT-28153	3.0	100	12/360
YT-28174	3.5	100	12/360
YT-2817	4.0	100	12/120
YT-2818	5.5	125	12/120
YT-2819	6.5	150	12/120
YT-2820	8.0	175	12/120

YATO	⊕	L [mm]	📦
YT-2821	PH0	60	12/120
YT-2822	PH1	80	12/120
YT-2823	PH2	100	12/120
YT-2824	PH3	150	12/120

YATO	⊕	L [mm]	📦
YT-28245	PZ0	60	12/360
YT-2825	PZ1	80	12/120
YT-2826	PZ2	100	12/120
YT-28263	PZ3	150	12/96

EN Insulated screwdriver set
 PL Zestaw wkrętek z wymiennymi końcówkami izolowanymi
 DE Isolierte Schraubendreher-Satz
 RU Набор изолированных отвёрток
 CZ Sada izolovaných šroubováků
 HU Szigetelt csavarhúzó készlet
 RO Set şurubelniţa izolată
 FR Jeu de tournevis isolés
 IT Set cacciaviti isolati
 ES Juego de destornilladores aislados
 CN 绝缘螺丝批组套

HRC 56-60 S2 1000 V



5 PCS
 ⊖
 ⊕

⊖ 3.0, 4.0 mm (L=100 mm), 5.5 mm (L=125 mm);
 ⊕ PH1 (L=80 mm), PH2 (L=100 mm)



7 PCS
 ⊖
 ⊕
 *

⊖ 3.0, 4.0 mm (L=100 mm), 5.5 mm (L=125 mm);
 ⊕ PH1 (L=80 mm), PH2 (L=100 mm);
 * PZ1 (L=80 mm), PZ2 (L=100 mm)

YATO	📦
YT-2827	10/40

YATO	📦
YT-2828	10/40

EN Insulated changeable screwdriver set
 PL Zestaw wkrętek z wymiennymi końcówkami izolowanymi
 DE Isolierte Schraubendreher-Satz
 RU Набор изолированных отвёрток
 CZ Sada izolovaných šroubováků
 HU Szigetelt csavarhúzó készlet
 RO Set şurubelniţă izolată
 FR Jeu de tournevis isolés
 IT Set cacciaviti isolati
 ES Juego de destornilladores aislado
 CN 绝缘可换头螺丝批组套

12 PCS
 ⊖ ⊕
 HRC 54-61 S2 1000 V



⊖ 2.0, 2.5, 3.0, 3.5, 4.0, 5.5, 6.5 mm (L=100 mm); S2;
 ⊕ PH0, PH1, PH2 (L=100 mm); S2;
 4x150 mm; 250 V

1000 V
 VDE CERTIFICATE
 EN 60900:2012

YATO	📦
YT-28290	24

EN Insulated changeable screwdriver set
 PL Zestaw wkrętek z wymiennymi końcówkami izolowanymi
 DE Isolierte Schraubendreher-Satz
 RU Набор изолированных отвёрток
 CZ Sada izolovaných šroubováků
 HU Szigetelt csavarhúzó készlet
 RO Set şurubelniţă izolată
 FR Jeu de tournevis isolés
 IT Set cacciaviti isolati
 ES Juego de destornilladores aislado
 CN 绝缘可换头螺丝批组套

50 PCS
 ⊖ ⊕ *



⊖ 2.0, 2.5, 3.0, 3.5, 4.0, 5.5, 6.5 mm (L=100 mm); S2;
 ⊕ PH0, PH1, PH2 (L=100 mm); S2;
 * PZ0, PZ1, PZ2 (L=100 mm); S2;
 T6, T8, T9, T10, T15, T20, T25, T27, T30 (L=100 mm); S2;
 2.5, 3, 4, 5, 6 mm (L=100 mm); S2;
 R1, R2 (L=100 mm); S2;

1, 2, 3, 4 mm (L=100 mm); S2;
 4, 6, 8, 10 mm (L=100 mm); S2;
 4, 6, 8, 10 mm (L=100 mm); S2;
 M4, M5, M6 (L=100 mm); S2;
 4x150 mm; 250 V

HRC 54-61 S2 1000 V



1000 V
 VDE CERTIFICATE
 EN 60900:2012

YATO	📦
YT-28293	10

EN Insulated screwdriver set
PL Zestaw wkrętek izolowanych
DE Isolierte Schraubendreher-Satz
RU Набор изолированных отвёрток
CZ Sada izolovaných šroubováků
HU Szigetelt csavarhúzó készlet
RO Set șurubelniță izolată
FR Jeu de tournevis isolés
IT Set cacciaviti isolati
ES Juego de destornilladores aislados
CN 绝缘螺丝批组套



1.8, 2.0 mm (L=50 mm), 2.5, 3.0 mm (L=65 mm); S2
PH00, PH0 (L=65 mm); S2

YATO		
YT-28283		6/48

EN Insulated changeable screwdriver set
PL Zestaw wkrętek z wymiennymi końcówkami izolowanymi
DE Isolierte Schraubendreher-Satz
RU Набор изолированных отвёрток
CZ Sada izolovaných šroubováků
HU Szigetelt csavarhúzó készlet
RO Set șurubelniță izolată
FR Jeu de tournevis isolés
IT Set cacciaviti isolati
ES Juego de destornilladores aislado
CN 绝缘可换头螺丝批组套

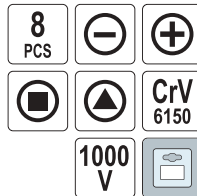

3.0, 4.0, 5.5 mm (L=100 mm); CrV 6150;
PH1 (L=80 mm), PH2 (L=100 mm); CrV 6150;
Square lock key / Klucz kwadratowy;
Triangle lock key / Klucz trójkątny

1000 V
VDE CERTIFICATE
EN 60900:2012

YATO		
YT-28294		6/24

EN Insulated changeable screwdriver set
PL Zestaw wkrętek z wymiennymi końcówkami izolowanymi
DE Isolierte Schraubendreher-Satz
RU Набор изолированных отвёрток
CZ Sada izolovaných šroubováků
HU Szigetelt csavarhúzó készlet
RO Set șurubelniță izolată
FR Jeu de tournevis isolés
IT Set cacciaviti isolati
ES Juego de destornilladores aislado
CN 绝缘可换头螺丝批组套

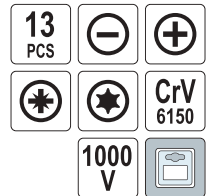

3.0, 4.0, 5.5, 6.5 mm (L=100 mm); CrV 6150;
PH1 (L=80 mm), PH2 (L=100 mm); CrV 6150;
PZ1 (L=80 mm), PZ2 (L=100 mm); CrV 6150;
T10, T15, T20 (L=100 mm); CrV 6150;
3x140 mm; 250 V

1000 V
VDE CERTIFICATE
EN 60900:2012

YATO		
YT-28295		6/12

EN Combination pliers
PL Szczypce uniwersalne
DE Kombinationszange
RU Плоскогубцы универсальные
CZ Kleště kombinované
HU Kombináltfogó
RO Patent universal
FR Pince universelle
IT Pinze universali
ES Alicates universales
CN 绝缘钢丝钳



1000 V
VDE CERTIFICATE
EN 60900:2012

YATO	L [mm]	
YT-21151	160	6/36
YT-21152	180	6/36
YT-21153	200	6/36

EN Diagonal side cutting pliers
PL Szczypce tnące boczne
DE Seitenschneider
RU Бокорезы
CZ Rezací kleště boční
HU Oldal csípőfogó
RO Clește pt. tăiat lateral
FR Pince à coupe latérale
IT Pinze taglianti laterali
ES Alicates corte lateral
CN 绝缘斜嘴钳



1000 V
VDE CERTIFICATE
EN 60900:2012

YATO	L [mm]	
YT-21158	160	6/36
YT-21159	180	6/36

EN Long nose pliers
PL Szczypce wydłużone proste
DE Radiozange gebogen
RU Тонкогубцы удлиненные прямые
CZ Prodloužené kleště rovné
HU Rádiófogó egyenes
RO Clește cu vârf lung ascuțit
FR Pince à bec long
IT Pinza lunga dritta
ES Alicates de punta rectos
CN 绝缘尖嘴钳



1000 V
VDE CERTIFICATE
EN 60900:2012

YATO	L [mm]	
YT-21154	160	6/36
YT-21155	200	6/36

EN Insulated wire stripper
PL Szczypce do ściągania izolacji, izolowane
DE Abisolier-Zange, isoliert
RU Изолированные клещи для снятия изоляции
CZ Kleště pro stahování izolace, izolované
HU Szigetelés lehúzó fogó, szigetelt
RO Decablator VDE
FR Pince à dénuder isolée
IT Pinza spelafili isolata
ES Alicates para quitar aislamiento, aislados
CN 绝缘剥线钳

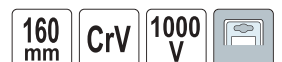

1000 V
VDE CERTIFICATE
EN 60900:2012

YATO	L [mm]	
YT-21160	160	6/36

EN Insulated water pump pliers
 PL Szczypce nastawne hydrauliczne, izolowane
 DE Hydraulik-Rohrzange, isoliert
 RU Изолированные переставные клещи
 CZ Nastavitelné kleště izolované
 HU Vízpumpa fogó szigetelt
 RO Cleste papagal VDE
 FR Pince réglable multiprises isolée
 IT Pinza regolabile isolata per idraulici
 ES Alicates hidráulicos ajustables, aislados
 CN 绝缘水泵钳

250 mm CrV 1000 V



1000 V
 VDE CERTIFICATE
 EN 60900:2012

YATO	L [mm]	
YT-21161	250	6/24

EN Insulated open end wrench
 PL Klucz płaski izolowany
 DE Doppelmaulschlüssel isoliert
 RU Ключ рожковый односторонний изолированный

CZ Otevřený klíč izolovaný
 HU Villáskulcs
 RO Cheie fixă izolată
 FR Clé plate isolée

IT Chiave piatta isolato
 ES Llave fija aislante
 CN 双色柄绝缘开口扳手



1000 V
 VDE CERTIFICATE
 EN 60900:2012

YATO	Ø [mm]	L [mm]	B [mm]	S [mm]	
YT-20954	10	110	31	8.0	6/108
YT-20957	13	135	39	10.5	6/72

EN Insulated T-handle wrench
 PL Rekojęść typu „T” izolowana
 DE Steckschlüssel T-griff vollisoliert
 RU Ручка Т-образная изолированная
 CZ Klíč nástrčný typ „T” izolovaný
 HU „T” típusú dugókulcs
 RO Măner tip „T” izolat
 FR Clé à tube en „T” isolée
 IT Chiave a bussola tipo „T” isolati
 ES Llave en T aislada
 CN 绝缘T型套筒扳手



1000 V
 VDE CERTIFICATE
 EN 60900:2012

EN Insulated adjustable wrench
 PL Klucz nastawny izolowany
 DE Rollgabelschlüssel isoliert
 RU Ключ разводной изолированный
 CZ Izolovaný stavitelný klíč
 HU Állítható svédkulcs

RO Cheie reglabilă izolată
 FR Clé à molette isolée
 IT Isolati chiave regolabile
 ES Llave ajustable aislante
 CN 双色柄绝缘活络扳手

CrV 1000 V



1000 V
 VDE CERTIFICATE
 EN 60900:2012

YATO	L [mm]	
YT-20940	200	6/48

EN Insulated spring clamp
 PL Ścisk sprężynowy izolowany
 DE Federklemme vollisoliert
 RU Струбицина изолированная
 CZ Pružinová svěrka
 HU Rugós szorító
 RO Cleste presa pt. lemn izolat
 FR Pince à ressort isolée
 IT Morsetto a molla isolato
 ES Pinza aislante
 CN 绝缘塑料圆头线夹



1000 V
 VDE CERTIFICATE
 EN 60900:2012

YATO	Working capacity / Zakres pracy [mm]	L [mm]	
YT-21190	2-20	150	5/40

EN Insulated flat nose pliers
 PL Szczypce płaskie izolowane
 DE Greifzange vollisoliert
 RU Плоскогубцы изолированные
 CZ Izolované kleště ploché
 HU Laposfogó szigetelt
 RO Patent izolat
 FR Pince plate isolée
 IT Pinza piatta isolata
 ES Alicates punta plana aislantes
 CN 绝缘塑料圆头线夹

200 mm CrV 1000 V



1000 V
 VDE CERTIFICATE
 EN 60900:2012

YATO	L [mm]	
YT-21191	200	6/48

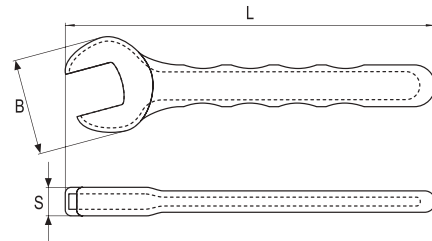

CrV 1000 V

YATO	Ø [mm]	L [mm]	B [mm]	S [mm]	
YT-20961	17	160	47	12.5	6/72
YT-20963	19	175	53	14.0	6/72

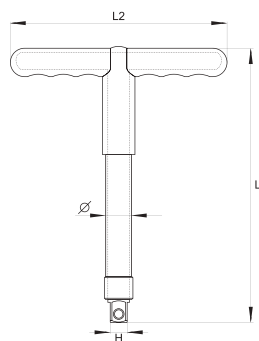

1/2" 12.7 mm CrV 1000 V

YATO	Ø H	L1 [mm]	L2 [mm]	Ø [mm]	
YT-21096	1/2" (12.7 mm)	207	160	19.3	4/32

EN Insulated ratchet handle
 PL Grzechotka izolowana
 DE Hebelumschaltknarre vollisoliert
 RU Трещотка диэлектрическая
 CZ Ráčna izolovaná
 HU Racsnis hajtókar

RO Antrenor cu clichet izolat
 FR Clé à cliquet isolée
 IT Cricchetto bussola isolato
 ES Carraca aislante
 CN 双色柄绝缘双向棘轮扳手

1/2" 12.7 mm CrV 1000 V



1000 V
 VDE CERTIFICATE
 EN 60900:2012









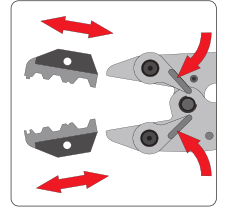
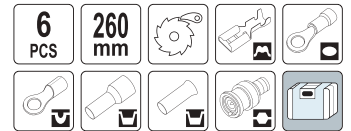

YATO	Ø	T	L [mm]	
YT-21072	1/2" (12.7 mm)	36	250	6/36

150 mm CrV 1000 V

YATO	Working capacity / Zakres pracy [mm]	L [mm]	
YT-21190	2-20	150	5/40



- EN Quick interchangeable ratchet crimper set
PL Zestaw do zaciskania konektorów
DE Kabelschuhzange-Satz
RU Набор для опрессовки наконечников
CZ Krimpovací kleště se sadou výměnných čelistí
HU Krimpelő fogó készlet
RO Set clește sertizat conectori
FR Jeu de pinces à sertir pour connecteurs
IT Set pinze per crimpare a connettori
ES Juego de pinzas críper
CN 压线钳组套

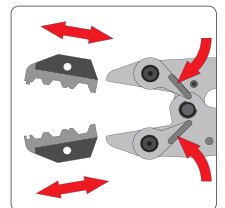
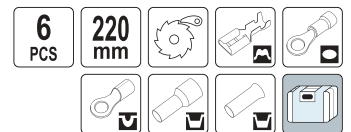
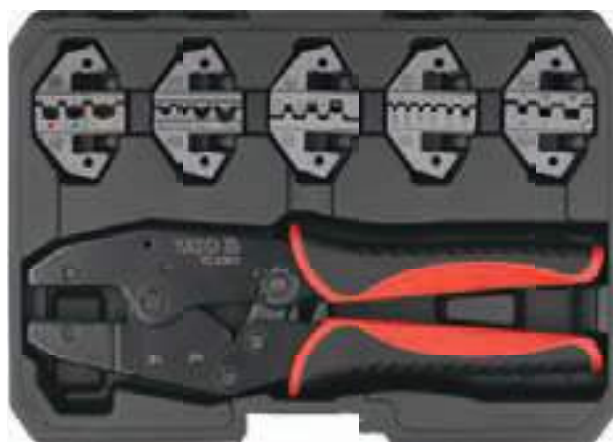

YATO 										
YT-2245	0.5-6	20-10	0.5-6	22-10	1.5-10	20-8	0.5-4	22-12	RG6, RG58, RG59, RG62	10

- EN Quick interchangeable ratchet crimper set
PL Zestaw do zaciskania konektorów
DE Kabelschuhzange-Satz
RU Набор для опрессовки наконечников
CZ Krimpovací kleště se sadou výměnných čelistí
HU Krimpelő fogó készlet
RO Set clește sertizat conectori
FR Jeu de pinces à sertir pour connecteurs
IT Set pinze per crimpare a connettori
ES Juego de pinzas críper
CN 压线钳组套



YATO 									
YT-22451	0.5-6	20-10	0.5-10	20-8	0.5-6	20-10	0.5-6, 6-16	20-10, 10-6	10

- EN Ratchet crimping pliers
PL Szczypce do zaciskania konektorów
DE Kabelschuhzange
RU Клещи для опрессовки наконечников
CZ Lisovací kleště na konektory
HU Krimpelő fogó

- RO Clește sertizat conectori
FR Pince à sertir pour connecteurs
IT Pinza crimpatrice per connettori
ES Pinza crimpadora para conectores
CN 压线钳

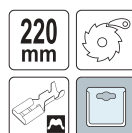







YATO 			
YT-2250	0.5-6	20-10	5/30

- EN Ratchet crimping pliers
PL Szczypce do zaciskania konektorów
DE Kabelschuhzange
RU Клещи для опрессовки наконечников
CZ Lisovací kleště na konektory
HU Krimpelő fogó

- RO Clește sertizat conectori
FR Pince à sertir pour connecteurs
IT Pinza crimpatrice per connettori
ES Pinza crimpadora para conectores
CN 压线钳





YATO 					
YT-2255	0.08-2	28-14	0.12-0.3	26-22	12/72

- EN Ratchet crimping pliers
PL Szczypce do zaciskania konektorów
DE Kabelschuhzange
RU Клещи для опрессовки наконечников
CZ Lisovací kleště na konektory
HU Krimpelő fogó

- RO Clește sertizat conectori
FR Pince à sertir pour connecteurs
IT Pinza crimpatrice per connettori
ES Pinza crimpadora para conectores
CN 压线钳



YATO 			
YT-2300	0.5-6	20-10	5/30

- EN Ratchet crimping pliers
PL Szczypce do zaciskania konektorów
DE Kabelschuhzange
RU Клещи для опрессовки наконечников
CZ Lisovací kleště na konektory
HU Krimpelő fogó

- RO Clește sertizat conectori
FR Pince à sertir pour connecteurs
IT Pinza crimpatrice per connettori
ES Pinza crimpadora para conectores
CN 压线钳



YATO 							
YT-2256	0.08-2	28-14	0.3-6	22-10	0.12-0.3	26-22	12/72

EN Ratchet crimping pliers
 PL Szczypce do zaciskania konektorów
 DE Kabelschuhzange
 RU Клещи для опрессовки наконечников
 CZ Lisovací kleště na konektory
 HU Krimpelő fogó

RO Clește sertizat conectori
 FR Pince à sertir pour connecteurs
 IT Pinza crimpatrice per connettori
 ES Pinza crimpadora para conectores
 CN 压线钳

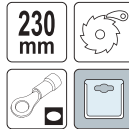

YATO	mm ²	AWG	
YT-2296	0.5-6	22-10	5/30

EN Ratchet crimping pliers
 PL Szczypce do zaciskania konektorów
 DE Kabelschuhzange
 RU Клещи для опрессовки наконечников
 CZ Lisovací kleště na konektory
 HU Krimpelő fogó

RO Clește sertizat conectori
 FR Pince à sertir pour connecteurs
 IT Pinza crimpatrice per connettori
 ES Pinza crimpadora para conectores
 CN 压线钳



YATO		
YT-2298	RG6, RG58, RG59, RG62	5/30

EN Ratchet crimping pliers
 PL Szczypce do zaciskania konektorów
 DE Kabelschuhzange
 RU Клещи для опрессовки наконечников
 CZ Lisovací kleště na konektory
 HU Krimpelő fogó

RO Clește sertizat conectori
 FR Pince à sertir pour connecteurs
 IT Pinza crimpatrice per connettori
 ES Pinza crimpadora para conectores
 CN 压线钳



YATO	mm ²	AWG	
YT-2297	1.5-10	20-8	5/30

EN Ratchet crimping pliers
 PL Szczypce do zaciskania konektorów
 DE Kabelschuhzange
 RU Клещи для опрессовки наконечников
 CZ Lisovací kleště na konektory
 HU Krimpelő fogó

RO Clește sertizat conectori
 FR Pince à sertir pour connecteurs
 IT Pinza crimpatrice per connettori
 ES Pinza crimpadora para conectores
 CN 压线钳



YATO	mm ²	AWG	
YT-2299	0.5-4	22-12	5/30

EN Ratchet crimping pliers
 PL Szczypce do zaciskania konektorów
 DE Kabelschuhzange
 RU Клещи для опрессовки наконечников
 HU Krimpelő fogó

RO Clește sertizat conectori
 FR Pince à sertir pour connecteurs
 IT Pinza crimpatrice per connettori
 ES Pinza crimpadora para conectores
 CN 压线钳

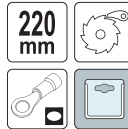

YATO	mm ²	AWG	
YT-2246	0.5-6	22-10	5/30

EN Ratchet crimping pliers
 PL Szczypce do zaciskania konektorów
 DE Kabelschuhzange
 RU Механический ручной пресс для наконечников
 CZ Lisovací kleště na konektory
 HU Krimpelő fogó

RO Clește sertizat conectori
 FR Pince à sertir pour connecteurs
 IT Pinza crimpatrice per connettori
 ES Prensa mecánica para terminales de cables
 CN 压线钳

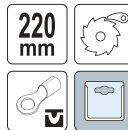

YATO	mm ²	AWG	
YT-2247	1.5-10	20-8	5/30

EN Cable lug crimping pliers
 PL Praska mechaniczna do końcówek kablowych
 DE Crimpzange für Kabelschuhe
 RU Механический ручной пресс для наконечников
 CZ Krimpovací kleště na kabelová oka
 HU Mechanikus kábeláru prés

RO Clește pt. sertizare cabluri
 FR Pince à sertir les cosses de câble
 IT Pinza crimpatrice manuale
 ES Prensa mecánica para terminales de cables
 CN 压线钳

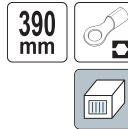

For crimping: 6, 10, 16, 25, 35, 50 mm²
 Zaciska: 6, 10, 16, 25, 35, 50 mm²

YATO	mm ²	
YT-22857	6, 10, 16, 25, 35, 50	10

EN Ratchet crimping pliers
 PL Szczypce do zaciskania konektorów
 DE Kabelschuhzange
 RU Клещи для опрессовки наконечников
 CZ Lisovací kleště na konektory
 HU Krimpelő fogó

RO Clește sertizat conectori
 FR Pince à sertir pour connecteurs
 IT Pinza crimpatrice per connettori
 ES Pinza crimpadora para conectores
 CN 压线钳



For crimping: 6, 10, 16 mm²
 Zaciska: 6, 10, 16 mm²

YATO	mm ²	AWG	
YT-23001	6, 10, 16	10, 8, 6	10/30

EN Ratchet crimping pliers
PL Szczypce do zaciskania konektorów
DE Kabelschuhzange
RU Клещи для опрессовки наконечников
CZ Lisovací kleště na konektory
HU Krimpelő fogó
RO Clește sertizat conectori
FR Pince à sertir pour connecteurs
IT Pinza crimpatrice per connettori
ES Pinza crimpadora para conectores
CN 压线钳

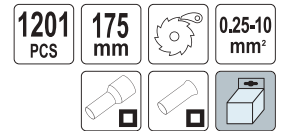

0.5 mm² x 8 mm (250 PCS),
0.75 mm² x 8 mm (210 PCS),
1.0 mm² x 8 mm (200 PCS),
1.5 mm² x 8 mm (240 PCS),
2.5 mm² x 8 mm (215 PCS),
4.0 mm² x 9 mm (40 PCS),
6.0 mm² x 12 mm (30 PCS),
10.0 mm² x 12 mm (15 PCS)

EN Ratchet crimping pliers
PL Szczypce do zaciskania konektorów
DE Kabelschuhzange
RU Клещи для опрессовки наконечников
CZ Lisovací kleště na konektory
HU Krimpelő fogó

RO Clește sertizat conectori
FR Pince à sertir pour connecteurs
IT Pinza crimpatrice per connettori
ES Pinza crimpadora para conectores
CN 压线钳



YATO 	 [mm ²]	
YT-2240	0.2-6	6/36

EN Ratchet crimping pliers
PL Szczypce do zaciskania konektorów
DE Kabelschuhzange
RU Клещи для опрессовки наконечников
CZ Lisovací kleště na konektory
HU Krimpelő fogó

RO Clește sertizat conectori
FR Pince à sertir pour connecteurs
IT Pinza crimpatrice per connettori
ES Pinza crimpadora para conectores
CN 压线钳

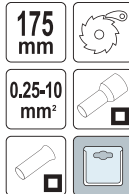



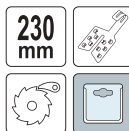

YATO 	 [mm ²]	
YT-23051	0.25-10	10/40

EN Crimping tool for heating film connectors
PL Zaciskarka do konektorów folii grzewczej
DE Foliensteckverbinder-Crimpzange
RU Пресс для клипс-коннекторов для подключения инфракрасной пленки
CZ Lisovací kleště na konektory pro topné folie
HU Fűtőfólia csatlakozó-krimpelő fogó

RO Clește pt. sertizat conectori ecofilm
FR Outils de sertissage pour connecteurs à film
ES Crimpadora para conectores de película calefactora
CN 棘轮压线钳



YATO 	L [mm]	
YT-22570	230	10/40

YATO 	 [mm ²]	
YT-23052	0.25-10	12

EN Ratchet crimping pliers
PL Szczypce do zaciskania konektorów
DE Kabelschuhzange
RU Клещи для опрессовки наконечников
CZ Lisovací kleště na konektory
HU Krimpelő fogó

RO Clește sertizat conectori
FR Pince à sertir pour connecteurs
IT Pinza crimpatrice per connettori
ES Pinza crimpadora para conectores
CN 压线钳

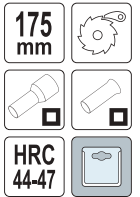

YATO 	 [mm ²]	
YT-2305	0.2-6	6/36

EN Ratchet crimping pliers
PL Szczypce do zaciskania konektorów
DE Kabelschuhzange
RU Клещи для опрессовки наконечников
CZ Lisovací kleště na konektory
HU Krimpelő fogó

RO Clește sertizat conectori
FR Pince à sertir pour connecteurs
IT Pinza crimpatrice per connettori
ES Pinza crimpadora para conectores
CN 压线钳

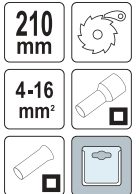

YATO 	 [mm ²]	
YT-23054	4-16	10/30

EN Ratchet crimping pliers
PL Szczypce do zaciskania konektorów
DE Kabelschuhzange
RU Клещи для опрессовки наконечников
CZ Lisovací kleště na konektory
HU Krimpelő fogó

RO Clește sertizat conectori
FR Pince à sertir pour connecteurs
IT Pinza crimpatrice per connettori
ES Pinza crimpadora para conectores
CN 压线钳

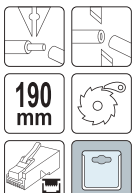

YATO 		
YT-22442	RJ45, RJ11, 8P, 6P	10/50

EN Ratchet crimping pliers
 PL Szczypce do zaciskania konektorów
 DE Kabelschuhzange
 RU Клещи для опрессовки наконечников
 CZ Lisovací kleště na konektory
 HU Krimpelő fogó

RO Clește sertizat conectori
 FR Pince à sertir pour connecteurs
 IT Pinza crimpatrice per connettori
 ES Pinza crimpadora para conectores
 CN 压线钳

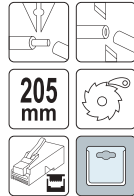

205 mm



YATO		
YT-22443	RJ45, RJ11, RJ10, 8P, 6P, 4P	10/30

EN Ratchet crimping pliers
 PL Szczypce do zaciskania konektorów
 DE Kabelschuhzange
 RU Клещи для опрессовки наконечников
 CZ Lisovací kleště na konektory
 HU Krimpelő fogó

RO Clește sertizat conectori
 FR Pince à sertir pour connecteurs
 IT Pinza crimpatrice per connettori
 ES Pinza crimpadora para conectores
 CN 压线钳

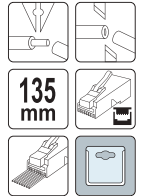

135 mm



YATO		
YT-22440	RJ45, RJ45 przelotowy	10/50

EN Hydraulic crimping tool
 PL Ręczna praska hydrauliczna
 DE Manuelle Hydraulikpresse
 RU Ручной гидравлический пресс
 CZ Ruční hydraulický lis
 HU Kézi hidraulikus prés

RO Presă hidraulică manuală
 FR Pince à sertir hydraulique
 IT Pressa idraulica manuale
 ES Prensa hidráulica manual
 CN 液压钳



YATO	□ [mm²]	L [mm]	Force pressure / Siła nacisku [t]	Al [mm²]	Cu [mm²]	
YT-22860	10, 16, 25, 35, 50, 70, 95, 120	415	8	10-95	10-120	4
YT-22861	16, 25, 35, 50, 70, 95, 120, 150, 185, 240	470	12	16-185	16-240	3
YT-22862	16, 25, 35, 50, 70, 95, 120, 150, 185, 240, 300	470	18-20	16-240	16-300	3

EN Spare dies for crimping tool
 PL Wymienne matryce do praski
 DE Ersatz-Matrizen für manuelle Hydraulikpresse
 RU Набор матриц для ручного гидравлического пресса
 CZ Vyměnitelné matrice pro ruční hydraulický lis
 HU Cserélhető présfej
 RO Capete sertizat pt. presa hidraulica
 FR Jeux de mâchoires pour pince à sertir hydraulique
 IT Matrici sostituibili per pressa idraulica manuale
 ES Matrices de recambio para prensa
 CN 液压压接钳备用压接头



YATO	□ [mm²]	pcs / szt.	For / Dla	
YT-22863	10, 16, 25, 35, 50, 70, 95, 120	8	YT-22860	10
YT-22864	16, 25, 35, 50, 70, 95, 120, 150, 185, 240	10	YT-22861	10
YT-22865	16, 25, 35, 50, 70, 95, 120, 150, 185, 240, 300	11	YT-22862	10

EN Pliers for crimping lines
 PL Szczypce do zaciskania lin stalowych
 DE Zangen für Crimp-Linien
 RU Клещи для опрессовки канатов
 CZ Ruční lisovací kleště
 HU Krimpelő fogó

RO Clește pt. sertizat cabluri
 FR Pincettes pour lignes de sertissage
 IT Pinze per crimpare cavi metallici
 ES Alicates para líneas de engaste
 CN 多功能压接钳

600 mm

DROP FORGED KUTE



YATO	∅ [mm]	L [mm]	
YT-22851	4.8, 6.6, 8.7, 9.5, 11.3	600	6

EN Multifunctional pliers
 PL Szczypce wielofunkcyjne
 DE Multifunktionszange
 RU Клещи многофункциональные для снятия изоляции
 CZ Multifunkční kleště
 HU Multifunkciós fogó

RO Clește multifuncțional
 FR Pince multifonction
 IT Pinze multifunzione
 ES Alicates multifuncionales
 CN 多功能剥线钳

6 in 1

6 w 1

250 mm



M2.6-M5



YATO									
YT-2254	mm²	AWG	mm²	AWG	mm²	AWG	mm²	AWG	12/48
	0.5-5	20-10	0.5-5	20-10	0.5-5.5	20-10	0.5-5	20-10	

EN Multifunctional pliers
PL Szczypce wielofunkcyjne
DE Multifunktionszange
RU Клещи многофункциональные
CZ Multifunkční kleště
HU Multifunkciós fogó

RO Clește multifuncțional
FR Pinces multifonction
IT Pinze multifunzione
ES Alicates
multifuncionales
CN 多功能剥线钳

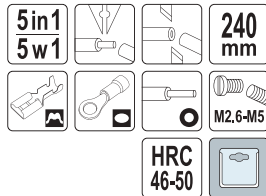

YATO	mm ²	AWG	mm ²	AWG	mm ²	AWG	PCS
YT-22930	1.5-6	22-10	1.5-6	22-10	0.75-6	22-10	12/48

EN Wire stripper
PL Ściągacz izolacji
DE Abisolierzange
RU Съёмник изоляции
CZ Odstraňovač izolace
HU Blankoló fogó

RO Decablator
FR Décapant d'isolant
IT Spellafili per cavi
ES Pelacables
CN 剥线钳

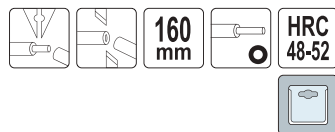

YATO	mm ²	AWG	PCS
YT-2319	0.8-2.6	20-10	10/60

EN Universal wire stripper
PL Uniwersalny ściągacz izolacji
DE Universal Abisolierzange
RU Универсальный съёмник изоляции

CZ Univerzální odizolovací kleště
HU Blankoló fogó
RO Decablator universal
FR Extracteur d'isolation multifonction

IT Pinze per scaricare isolamento
ES Extractor de aislado universal
CN 万用剥线钳



EN Universal wire stripper & ratchet crimping pliers
PL Uniwersalny ściągacz izolacji i szczypce do zaciskania konektorów
DE Multifunktion Abisolierzange & Kabelschuhklemmzange
RU Инструмент для снятия изоляции и зажима проводов
CZ Kleště odizolovací a konektorové univerzální
HU Blankoló fogó & krimpelő fogó
RO Decablator universal & clește sertizat conectori
FR Extracteur d'isolation multifonction
IT Pinze per scaricare isolamento
ES Extractor de aislado multifunción
CN 万用剥线钳

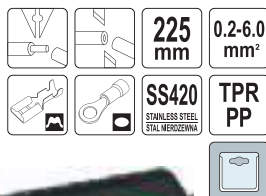

YATO	mm ²	AWG	mm ²	AWG	PCS
YT-22703	0.2-6	24-10	0.2-6	24-10	10/40

EN Multifunctional pliers
PL Szczypce wielofunkcyjne
DE Multifunktionszange
RU Клещи многофункциональные
CZ Multifunkční kleště
HU Multifunkciós fogó

RO Clește multifuncțional
FR Pinces multifonction
IT Pinze multifunzione
ES Alicates
multifuncionales
CN 多功能剥线钳

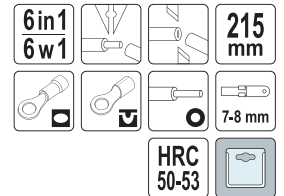

YATO	mm ²	AWG	mm ²	AWG	PCS
YT-2293	1.25-2.5	8-12	1	8	12

EN Wire stripper
PL Ściągacz izolacji
DE Abisolierzange
RU Съёмник изоляции
CZ Odstraňovač izolace
HU Blankoló fogó

RO Decablator
FR Décapant d'isolant
IT Spellafili per cavi
ES Pelacables
CN 剥线钳

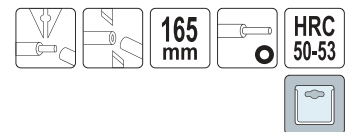

YATO	mm ²	AWG	PCS
YT-2294	0.64-2.6	22-10	12/120

EN Universal wire stripper & ratchet crimping pliers
PL Uniwersalny ściągacz izolacji i szczypce do zaciskania konektorów
DE Multifunktion Abisolierzange & Kabelschuhklemmzange
RU Инструмент для снятия изоляции и зажима проводов
CZ Kleště odizolovací a konektorové univerzální
HU Blankoló fogó & krimpelő fogó
RO Decablator universal & clește sertizat conectori
FR Extracteur d'isolation multifonction
IT Pinze per scaricare isolamento
ES Extractor de aislado multifunción
CN 万用剥线钳

- 0.5 - 1.5 mm² (20 PCS), 1.5 - 2.5 mm² (20 PCS);
- 0.5 - 1.5 mm² (20 PCS), 1.5 - 2.5 mm² (20 PCS);
- 0.5 - 1.5 mm² (20 PCS), 1.5 - 2.5 mm² (20 PCS);
- 0.5 - 1.5 mm² (20 PCS), 1.5 - 2.5 mm² (20 PCS);
- 0.5 - 1.5 mm² (10 PCS), 1.5 - 2.5 mm² (10 PCS);
- 0.5 - 1.5 mm² (10 PCS)

YATO	mm ²	AWG	mm ²	AWG	mm ²	AWG	PCS
YT-23133	0.5-6	22-10	0.5-6	22-10	0.5-6	22-10	0.2-6

EN Universal wire stripper & ratchet crimping pliers
PL Uniwersalny ściągacz izolacji i szczypce do zaciskania konektorów
DE Multifunktion Abisolierzange & Kabelschuhklemmzange
RU Инструмент для снятия изоляции и зажима проводов
CZ Kleště odizolovací a konektorové univerzální
HU Blankoló fogó & krimpelő fogó
RO Decablator universal & clește sertizat conectori
FR Extracteur d'isolation multifonction
IT Pinze per scaricare isolamento
ES Extractor de aislado multifunción
CN 万用剥线钳



YATO	mm ²	AWG	mm ²	AWG	mm ²	AWG	PCS
YT-2270	0.5-6	22-10	1.5-6	22-10	0.2-6	24-10	5/30

EN Universal wire stripper & ratchet crimping pliers
 PL Uniwersalny ściągacz izolacji i szczytce do zaciskania konektorów
 DE Multifunktion Abisolierzange & Kabelschuhklemmzange
 RU Инструмент для снятия изоляции и зажима проводов
 CZ Kleště odizolovací a konektorové univerzální
 HU Blankoló fogó & krimpelő fogó
 RO Decablator universal & clește sertizat conectori
 FR Extracteur d'isolation multifonction
 IT Pinze per scaricare isolamento
 ES Extractor de aislado multifunción
 CN 万用剥线钳



YATO							
YT-2313	0.5-6	22-10	1.5-6	22-10	0.2-6	24-10	5/30

EN Universal wire stripper & ratchet crimping pliers
 PL Uniwersalny ściągacz izolacji i szczytce do zaciskania konektorów
 DE Multifunktion Abisolierzange & Kabelschuhklemmzange
 RU Инструмент для снятия изоляции и зажима проводов
 CZ Kleště odizolovací a konektorové univerzální
 HU Blankoló fogó & krimpelő fogó
 RO Decablator universal & clește sertizat conectori
 FR Extracteur d'isolation multifonction
 IT Pinze per scaricare isolamento
 ES Extractor de aislado multifunción
 CN 剥线钳

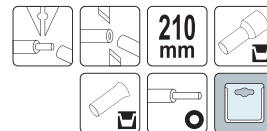

YATO					
YT-2278	0.5-6	22-10	0.2-6	24-10	10/60

EN Automatic wire stripper
 PL Automatemyczny ściągacz izolacji
 DE Automatische Abisolierzange
 RU Клещи для удаления изоляции
 CZ Automatický stahovač izolace
 HU Automatikus szigeteléselhúzó

RO Clește decablator automat
 FR Extracteur d'isolation automatique
 IT Pinze per scaricare isolamento
 ES Pelacables automatico
 CN 万用剥线钳

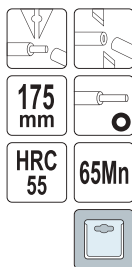

YATO			
YT-2268	0.5-6	20-10	10/60

EN Wire stripper
 PL Ściągacz izolacji
 DE Abisolierzange
 RU Съёмник изоляции
 CZ Odstraňovač izolace
 HU Blankoló fogó

RO Decablator
 FR Décapant d'isolant
 IT Spellafili per cavi
 ES Pelacables
 CN 剥线钳



YATO			
YT-2274	RG9, RG59	0.5-6	20-10

EN Wire stripper
 PL Ściągacz izolacji
 DE Abisolierzange
 RU Съёмник изоляции
 CZ Odstraňovač izolace
 HU Blankoló fogó
 RO Decablator
 FR Décapant d'isolant
 IT Spellafili per cavi
 ES Pelacables
 CN 剥线钳



YATO		Ethernet cables / Kable sieciowe	
YT-22760	RG59, RG6, RG7, RG11	CAT. 5-7 (UTP/STP)	6/48

EN Automatic wire stripper
 PL Automatemyczny ściągacz izolacji
 DE Automatische Abisolierzange
 RU Клещи для удаления изоляции
 CZ Automatický stahovač izolace
 HU Automatikus szigeteléselhúzó

RO Clește decablator automat
 FR Extracteur d'isolation automatique
 IT Pinze per scaricare isolamento
 ES Pelacables automatico
 CN 万用剥线钳



YATO			
YT-2275	0.5-6	20-10	10/60

EN Wire stripper
 PL Ściągacz izolacji
 DE Abisolierzange
 RU Съёмник изоляции
 CZ Odstraňovač izolace
 HU Blankoló fogó
 RO Decablator
 FR Décapant d'isolant
 IT Spellafili per cavi
 ES Pelacables
 CN 剥线钳

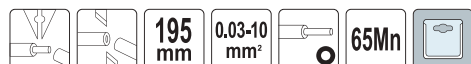

YATO			
YT-22753	0.03-10	32-8	10/40

EN Electrical cutter
 PL Obcinak elektryczny
 DE Seitenschneider
 RU Диэлектрические бокорезы
 CZ Kleště elektrikařské
 HU Műszerész oldalcsípő fogó
 RO Clește tăietor pt. electroniști
 FR Pince coupante pour électricien
 IT Pinza per elettronica
 ES Alicata de corte para electrónica
 CN 电子斜嘴钳

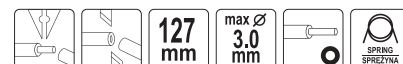

YATO	max. Ø [mm]			L [mm]	
YT-2260	3	0.14-0.34	26-22	125	15/150

EN Electrical cutter
PL Obcinak elektryczny
DE Seitenschneider
RU Диэлектрические бокорезы
CZ Kleště elektrikařské
HU Műszerész oldalcsípő fogó
RO Clește tăietor pt. electroniști
FR Pince coupante pour électricien
IT Pinza per elettronica
ES Alicata de corte para electrónica
CN 电子斜嘴钳



YATO	max. Ø [mm]	L [mm]	
YT-2261	3	125	15/150

EN Electrical cutter
PL Obcinak elektryczny
DE Seitenschneider
RU Диэлектрические бокорезы
CZ Kleště elektrikařské
HU Műszerész oldalcsípő fogó
RO Clește tăietor pt. electroniști
FR Pince coupante pour électricien
IT Pinza per elettronica
ES Alicata de corte para electrónica
CN 电子斜嘴钳



YATO	max. Ø [mm]	L [mm]	
YT-2262	3	125	20/120

EN Electrical cutter
PL Obcinak elektryczny
DE Seitenschneider
RU Диэлектрические бокорезы
CZ Kleště elektrikařské
HU Műszerész oldalcsípő fogó
RO Clește tăietor pt. electroniști
FR Pince coupante pour électricien
IT Pinza per elettronica
ES Alicata de corte para electrónica
CN 电子斜嘴钳



YATO	mm ²	AWG	L [mm]	
YT-19695	0.8-2.6	20-10	160	10/100

EN Cable cutter
PL Szczypce do cięcia przewodów
DE Kabelschere
RU Кабелерезы
CZ Štípači kleště na kabely
HU Kábelvágó
RO Clește tăiat cabluri
FR Pince à couper les fils
IT Cesioia per cavi elettrici
ES Alicata cortacables
CN 电缆剪



YATO	max. Ø [mm]	L [mm]	
YT-19682	10.5	200	10/100

EN Automatic wire stripper
PL Automacyjny ściągacz izolacji
DE Automatische Abisolierzange
RU Клещи для удаления изоляции
CZ Automatický stahovač izolace
HU Automatikus szigeteléslehúzó

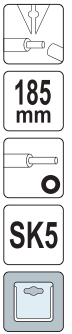

YATO	mm ²	AWG	
YT-2316	1-3.2	18-12	8/48

EN Electrical cutter
PL Obcinak elektryczny
DE Seitenschneider
RU Диэлектрические бокорезы
CZ Kleště elektrikařské
HU Műszerész oldalcsípő fogó
RO Clește tăietor pt. electroniști
FR Pince coupante pour électricien
IT Pinza per elettronica
ES Alicata de corte para electrónica
CN 电子斜嘴钳

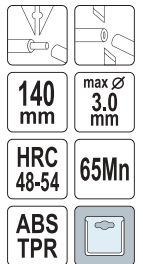

YATO	mm ²	AWG	L [mm]	
YT-22640	0.8-2.6	20-10	140	12/120

EN Electrical cutter
PL Obcinak elektryczny
DE Seitenschneider
RU Диэлектрические бокорезы
CZ Kleště elektrikařské
HU Műszerész oldalcsípő fogó
RO Clește tăietor pt. electroniști
FR Pince coupante pour électricien
IT Pinza per elettronica
ES Alicata de corte para electrónica
CN 电子斜嘴钳



YATO	max. Ø [mm]	L [mm]	
YT-2263	3	130	12/120





EN Cable cutter
PL Szczypce do cięcia przewodów
DE Kabelschere
RU Кабелерезы
CZ Štípači kleště na kabely
HU Kábelvágó







YATO	max. Ø [mm]	L [mm]	
YT-2279	10.5	170	10/60

- EN Universal wire stripper
- PL Uniwersalny ściągacz izolacji
- DE Universal Abisolierzange
- RU Универсальный съёмник изоляции
- CZ Univerzální odizolovací klešče
- HU Blankoló fogó
- RO Decablator universal
- FR Extracteur d'isolation multifonction
- IT Pinze per scaricare isolamento
- ES Extractor de aislado universal
- CN 万用剥线钳





		170 mm	max Ø 10.5 mm
	M3	LOCK BLOKADA	
			

YATO 	 mm²	 AWG	L [mm]	
YT-19691	1.6-3.2	14-8	170	6/24

- EN Multifunctional pliers
- PL Szczypce wielofunkcyjne
- DE Multifunktionszange
- RU Многофункциональные плоскогубцы
- CZ Multifunkční kleště
- HU Kombinált fogó
- RO Clește multifuncțional
- FR Pince multifonctionnelle
- IT Pinza universale
- ES Alicates universales
- CN 多功能钢丝钳





220 mm			HRC 40-50
HRC 58-62	CrV		

YATO 	 mm²	 AWG	 mm²	 AWG	L [mm]	
YT-20430	1.5	16-14	1-6	18-8	220	5/50

- EN Multifunctional pliers
- PL Szczypce wielofunkcyjne
- DE Multifunktionszange
- RU Многофункциональные плоскогубцы
- CZ Multifunkční kleště
- HU Kombinált fogó
- RO Clește multifuncțional
- FR Pince multifonctionnelle
- IT Pinza universale
- ES Alicates universales
- CN 多功能钢丝钳











205 mm			HRC 40-50
HRC 58-62	CrV		

YATO 	 mm²	 AWG	 mm²	 AWG	L [mm]	
YT-20433	1.5	16-14	1-6	18-8	205	5/50

- EN Multifunctional pliers
- PL Szczypce wielofunkcyjne
- DE Multifunktionszange
- RU Многофункциональные плоскогубцы
- CZ Multifunkční kleště
- HU Kombinált fogó
- RO Clește multifuncțional
- FR Pince multifonctionnelle
- IT Pinza universale
- ES Alicates universales
- CN 多功能钢丝钳

















240 mm			HRC 40-50
HRC 58-62	CrV		

YATO 	 mm²	 AWG	 mm²	 AWG	L [mm]	
YT-20435	1.5	16-14	1-6	18-8	240	5/50

- EN 5 in 1 pliers set for electricians
- PL Zestaw szczypiec dla elektryków 5 w 1
- DE Zangenset für Elektriker 5 in 1
- RU Многофункциональные клещи электрика 5 в 1
- CZ Sada elektrikařských kleští 5 v 1
- HU Villányeszerelő fogókészlet 5 az 1-ben
- RO Clește multifuncțional pt. electricieni 5 în 1
- FR Jeu de pinces pour électriciens 5 en 1
- IT Set di pinze per elettricisti 5 in 1
- ES Juego de alicates para electricistas 5 en 1
- CN 5合1钳子



5 in 1			200 mm
5 w 1			
CrV			

YATO 	 mm²	 AWG	 mm²	 AWG	 mm²	 AWG	L [mm]	
YT-19697	1.5-6	22-10	1.5-6	22-10	1.5-6	22-10	4/16	



EN Cable cutter
PL Nożyce do kabli
DE Kabelschere
RU Кабелерезы

CZ Elektrické upichovací
HU Kábelvágó
RO Clește tăiat cabluri
FR Cisailles à câbles

IT Cesoie per cavi
ES Tijeras para cables
CN 电缆剪

HRC 50 65Mn



YATO	Max. cutting range / Maks. przekrój cięcia [mm ²]	max. Ø [mm]	L [mm]	
YT-18610	125	12.5	370	20
YT-18611	250	18.0	580	10
YT-18612	500	25.0	770	5

EN Cable cutter
PL Nożyce do kabli
DE Kabelschere
RU Кабелерезы

CZ Kleště pákové na kabely
HU Kábelvágó
RO Clește tăiat cabluri
FR Cisailles à câbles

IT Cesoie per cavi
ES Tijeras para cables
CN 电缆剪

HRC 52-58 CrMo 55



YATO	Max. cutting range / Maks. przekrój cięcia [mm ²]	max. Ø [mm]	L [mm]	
YT-18615	150	13.5	450	12
YT-18616	240	17.5	600	10
YT-18617	450	23.5	910	5

EN Cable stripper
PL Nożyk do kabli
DE Kabelmesser
RU Нож кабельный
CZ Nůž na kabele
HU Kábelkés

RO Cuijt pt. cabluri
FR Couteau aux câbles
IT Coltello per cavi
ES Cuchillo
CN 电缆剥线钳



Ø 8-28 mm



YATO	Ø [mm]	
YT-2280	8-28	10/100

EN Insulated electrician's scissors
PL Nożyczki dla elektryków izolowane
DE Isolierte Elektriker-Schere
RU Ножницы электрика изолированные
CZ Izolované elektrikařské nůžky
HU Szigetelt olló villanyszerelőknék
RO Foarfecă pt. electricieni izolată
FR Ciseaux électricien isolés
IT Forbici da elettricista isolate
ES Tijera electricista aislante
CN 双色柄绝缘电工剪刀

160 mm CrV 1000 V



1000 V VDE CERTIFICATE EN 60900:2012

YATO	L [mm]	
YT-21200	160	6/48

EN Insulated cable knife
PL Nóż dla elektryków izolowany
DE Isoliertes Kabelmesser

RU Нож кабельный изолированный
CZ Izolovaný nůž elektrikařský
HU Kés-villanyszerelő szigetelt

RO Cutit pt. cabluri izolat
FR Couteau d'électricien
IT Coltello per elettricisti isolato

ES Cuchillo electricista aislado
CN 式绝缘电工刀

65Mn

1000 V



50/180 mm

YATO	L [mm]	
YT-21210	180	6/72



38/155 mm

YATO	L [mm]	
YT-21211	155	6/72

65Mn

1000 V

65Mn

65Mn

EN Cable cutter
 PL Szczypce do cięcia przewodów
 DE Kabelschere
 RU Кабелнепезы
 CZ Štípací kleště na kabely
 HU Kábelvágó
 RO Clește tăiat cabluri
 FR Pince à couper les fils
 IT Cesoia per cavi elettrici
 ES Alicata cortacables
 CN 电缆剪



HRC 55-60 **CrV 50**

• Application: for copper and aluminium electric cables
 • Przeznaczenie: do cięcia miedzianych i aluminiumowych kabli

YATO	max. Ø [mm]	L [mm]	
YT-1966	6	160	6/60
YT-1967	7	210	6/60
YT-1968	8	240	6/48

EN Insulated cable cutter
 PL Szczypce do cięcia przewodów izolowane
 DE Kabelschere
 RU Кабелнепезы
 CZ Izolované kleště na kabely
 HU Kábelvágó
 RO Clește tăiat cabluri izolat
 FR Pince renforcée isolée
 IT Cesoia per cavi isolata
 ES Alicata cortacables aislado
 CN 双色绝缘电缆剪



250 mm **max Ø 8.0 mm**
CrV 1000 V

1000 V
 VDE CERTIFICATE
 EN 60900:2012

YATO	max. Ø [mm]	L [mm]	
YT-21141	8	250	6/36

EN Heavy duty cable cutter
 PL Wzmocnione nożyce do cięcia przewodów
 DE Schwere Drahtschere
 RU Кабелнепезы
 CZ Štípací kleště na kabely
 HU Kábelvágó
 RO Clește tăietor pt. cabluri
 FR Pince renforcée à couper les fils
 IT Cesoia per cavi elettrici
 ES Alicata cortacables
 CN 电缆剪



240 mm **max Ø 9.0 mm** **HRC 55-60**
CrV 50

• Application: for copper and aluminium electric cables
 • Przeznaczenie: do cięcia miedzianych i aluminiumowych kabli

YATO	max. Ø [mm]	L [mm]	
YT-1969	9	240	6/48

EN Ratchet cable cutter
 PL Nożyce zapadkowe do kabli
 DE Ratschenkabelschneider
 RU Кабелнепез секторный
 CZ Kleště na kabely, rohátka se západkou
 HU Racsnis kábelvágó
 RO Cleste pt. taiat cablu cu clichet
 FR Cisailles à câbles
 IT Cricchetto taglia cavo
 ES Cortacables de carraca
 CN 棘轮电缆剪

Cu/Al **CABLE KABEL** **HRC 50** **60Si2Mn**



300 mm **max Ø 17.5 mm**

YATO	Max. cutting range / Maks. przekrój cięcia [mm ²]	max. Ø [mm]	L [mm]	
YT-18600	240	17.5	300	10



380 mm **max Ø 22 mm**

YATO	Max. cutting range / Maks. przekrój cięcia [mm ²]	max. Ø [mm]	L [mm]	
YT-18602	380	22	380	10

EN Voltage tester
 PL Próbnik napięcia
 DE Spannungsprüfer
 RU Тестер напряжения
 CZ Zkoušečka napětí
 HU Fáziskereső
 RO Tester pt. tensiune
 FR Testeur de tension
 IT Cercafase
 ES Probador de corriente
 CN 测电笔

190 mm **125-250 V~**



In accordance with polish standard PN-E 08509:1988
 Zgodność z polską normą PN-E 08509:1988

YATO	⊖ [mm]	L [mm]	
YT-28300	3	190	12/144

EN Voltage tester
 PL Próbnik napięcia
 DE Spannungsprüfer
 RU Тестер напряжения
 CZ Zkoušečka napětí
 HU Fáziskereső
 RO Tester pt. tensiune
 FR Testeur de tension
 IT Cercafase
 ES Probador de corriente
 CN 测电笔

140 mm **70-250V A.C.** **70-600V A.C.**
50-500 Hz **CONTINUITY TEST TEST CÍAGÓCSÍ**
1.5V 9V BATTERY TEST TEST BATERII **LED LIGHT DIODA** **2x LR41**



LED

YATO	⊖ [mm]	L [mm]	
YT-2864	3.5	140	6/120

EN Voltage tester
PL Próbnik napięcia
DE Spannungsprüfer
RU Тестер напряжения
CZ Zkoušečka napětí
HU Fáziskereső

RO Tester pt. tensiune
FR Testeur de tension
IT Cercafase
ES Probador de corriente
CN 测电笔

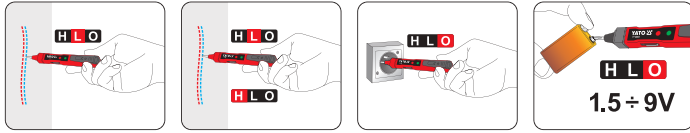
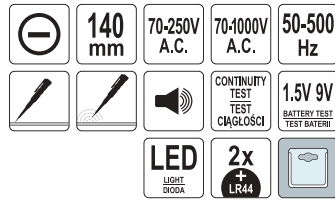

YATO	L [mm]	
YT-28631	140	6/120

EN Voltage tester
PL Próbnik napięcia
DE Spannungsprüfer
RU Тестер напряжения
CZ Zkoušečka napětí
HU Fáziskereső

RO Tester pt. tensiune
FR Testeur de tension
IT Cercafase
ES Probador de corriente
CN 测电笔

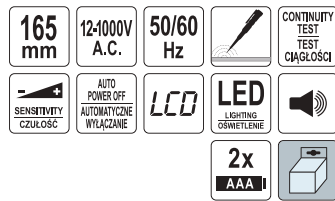

YATO	L [mm]	
YT-28320	165	100

EN Voltage tester
PL Próbnik napięcia
DE Spannungsprüfer
RU Тестер напряжения

CZ Zkoušečka napětí
HU Fáziskereső
RO Tester pt. tensiune
FR Testeur de tension

IT Cercafase
ES Probador de corriente
CN 测电笔



YATO	L [mm]	
YT-2861	130	20/500



YATO	L [mm]	
YT-2862	130	20/500



YATO	L [mm]	
YT-28630	145	6/120

EN Wire tracker (transmitter and receiver)
PL Lokalizator przewodów (nadajnik i odbiornik)
DE Kabelsuchgerät (Sender und Empfänger)
RU Детектор скрытой проводки (тестер-сканер)
CZ Lokátor kabelů (vysílač a přijímač)
HU Vezeték detektor (jeladó és vevőegység)
RO Detector cabluri de rețea (emițător și receptor)
FR Localisateur de câbles (émetteur et récepteur)
IT Localizzatore di cavi (trasmettitore e ricevitore)
ES Localizador de cables (emisor y receptor)
CN 寻线仪

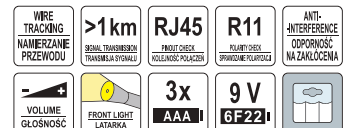

YATO		
YT-73137		10/20

EN Voltage tester
PL Próbnik napięcia
DE Spannungsprüfer
RU Тестер напряжения
CZ Zkoušečka napětí
HU Fáziskereső

RO Tester pt. tensiune
FR Testeur de tension
IT Cercafase
ES Probador de corriente
CN 测电笔

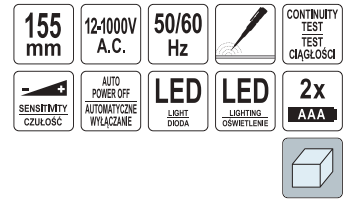

YATO	L [mm]	
YT-28313	155	120

EN Voltage tester
PL Próbnik napięcia
DE Spannungsprüfer
RU Тестер напряжения
CZ Zkoušečka napětí
HU Fáziskereső

RO Tester pt. tensiune
FR Testeur de tension
IT Cercafase
ES Probador de corriente
CN 测电笔



YATO	⌀ [mm]	
YT-28312	4.5	12/240

EN Digital detector with moisture test
 PL Cyfrowy detektor oraz wilgotnościomierz
 DE Digitaler Detektor mit Feuchtigkeitstest
 RU Цифровой детектор и измеритель влажности
 CZ Digitální detektor s testem vlhkosti
 HU Digitális detektor nedvességvizsgálattal
 RO Detector digital cabluri si umiditate
 FR Détecteur numérique avec test d'humidité
 IT Rivelatore digitale con test di umidità
 ES Detector digital con prueba de humedad
 CN 墙体探测仪



- 4 in 1
4 w 1
- LCD
- 6h
- 5-50%
- 1.5-33%
- max 8 mm
- AUTO POWER OFF
AUTOMATYCZNE WYŁĄCZANIE
- 9 V
6F22I

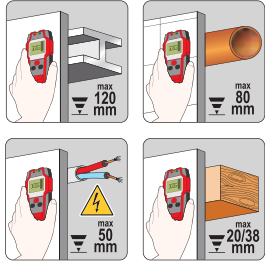

YATO YT-73138 40

EN Stud finder
 PL Wykrywacz profili i przewodów
 DE Entfernungsmesser
 RU Цифровой детектор
 CZ Digitální detektor
 HU Digitális kereső műszer
 RO Detector profile și cabluri electrice
 FR Détecteur de métaux et de câbles électriques
 IT Detector digitale
 ES Escáner de pared
 CN 多功能探测仪



- 3 in 1
3 w 1
- LCD
- 6h
- 9 V
6F22I

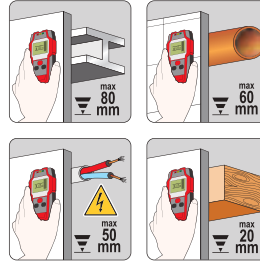

YATO YT-73131 40

EN Infrared thermometer
 PL Pirometr
 DE Pyrometer
 RU Пирометр
 CZ Pyrometr
 HU Pirométer
 RO Termometru cu infrarosu
 FR Pyromètre
 IT Termometro a infrarossi
 ES Pirómetro
 CN 红外测温仪



- 0.10-1
EMISSIVITY
EMISYJNOŚĆ
- °C -50
+600
- MAX
MIN
- °C
°F
- AUTO POWER OFF
AUTOMATYCZNE WYŁĄCZANIE
- 2x
AAA



YATO YT-73200 10/60

EN Infrared thermometer
 PL Pirometr
 DE Pyrometer
 RU Пирометр
 CZ Pyrometr
 HU Pirométer
 RO Termometru cu infrarosu
 FR Pyromètre
 IT Termometro a infrarossi
 ES Pirómetro
 CN 红外测温仪



- 0.10-1
EMISSIVITY
EMISYJNOŚĆ
- °C -50
+650
- MAX
MIN
- °C
°F
- x100
MEMORY
PAMIĘĆ
- UV
LED
- AUTO POWER OFF
AUTOMATYCZNE WYŁĄCZANIE
- 2x
AAA

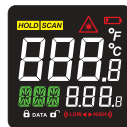

YATO YT-73201 10/60

EN Digital universal multimeter
 PL Cyfrowy miernik uniwersalny
 DE Digital-Multimeter
 RU Универсальный цифровой измеритель
 CZ Digitální multimetr univerzální
 HU Digitális multiméter
 RO Multimetru digital universal
 FR Multimètre numérique universel
 IT Multimetro digitale universale
 ES Multimetro digital universal
 CN 数字万用表



- LCD
1999
- 0-500V
D.C.
- 0-500V
A.C.
- 0-5 A
D.C.
- 0-2
MΩ
- 5V_{P-P}
- hFE
PNP
NPN
- 9 V
6F22I

YATO YT-73080 50

EN Digital universal multimeter
 PL Cyfrowy miernik uniwersalny
 DE Digital-Multimeter
 RU Универсальный цифровой измеритель
 CZ Digitální multimetr univerzální
 HU Digitális multiméter
 RO Multimetru digital universal
 FR Multimètre numérique universel
 IT Multimetro digitale universale
 ES Multimetro digital universal
 CN 数字万用表



- LCD
1999
- 0-600V
D.C.
- 0-600V
A.C.
- 0-10 A
D.C.
- 0-2
MΩ
- hFE
PNP
NPN
- 1.5V 9V
BATTERY TEST
TEST BATERII
- LED
BACKLIGHT
POSDWIELENIE
- 2x
AAA

YATO YT-73081 50

EN Digital universal multimeter
PL Cyfrowy miernik uniwersalny
DE Digital-Multimeter
RU Универсальный цифровой измеритель
CZ Digitální multimetr univerzální
HU Digitális multiméter
RO Multimetru digital universal
FR Multimètre numérique universel
IT Multimetro digitale universale
ES Multimetro digital universal
CN 数字万用表



TRUE RMS	LCD 6000	0-750V A.C.
0-1000V D.C.	0-10 A A.C.	0-10 A D.C.
0-60 MΩ	0-9.999 mF	0-9.999 MHz
1±99%	⚡	📶
AUTO RANGE AUTO ZAKRES	DATA HOLD	LED BACKLIGHT POSSWIETLENIE
AUTO POWER OFF AUTOMATYCZNE WYŁĄCZANIE	2x AAA	📦

EN Digital universal multimeter
PL Cyfrowy miernik uniwersalny
DE Digital-Multimeter
RU Универсальный цифровой измеритель
CZ Digitální multimetr univerzální
HU Digitális multiméter
RO Multimetru digital universal
FR Multimètre numérique universel
IT Multimetro digitale universale
ES Multimetro digital universal
CN 数字万用表



TRUE RMS	LCD 9999	0-750V A.C.
0-999.9V D.C.	0-9.999A A.C.	0-9.999A D.C.
0-9.999 MΩ	0-9.999 mF	0-9.999 MHz
1±99%	⚡	📶
📶	AUTO RANGE AUTO ZAKRES	DATA HOLD
LED BACKLIGHT POSSWIETLENIE	AUTO POWER OFF AUTOMATYCZNE WYŁĄCZANIE	2x AAA
		📦

YATO

YT-73096

100

YATO

YT-73089

100

EN Digital universal multimeter
PL Cyfrowy miernik uniwersalny
DE Digital-Multimeter
RU Универсальный цифровой измеритель
CZ Digitální multimetr univerzální
HU Digitális multiméter
RO Multimetru digital universal
FR Multimètre numérique universel
IT Multimetro digitale universale
ES Multimetro digital universal
CN 数字万用表



TRUE RMS	LCD 9999	0-600V A.C.
0-600V D.C.	0-10 A A.C.	0-10 A D.C.
0-99 MΩ	0-99 mF	0.01-60 kHz
⚡	📶	🔪
NCV	V A.C. VFC	1.5V 9V BATTERY TEST TEST BATERII
CONTINUITY TEST TEST CIĄGŁOŚCI	AUTO RANGE AUTO ZAKRES	DATA HOLD
LED BACKLIGHT POSSWIETLENIE	FRONT LIGHT LATARKA	AUTO POWER OFF AUTOMATYCZNE WYŁĄCZANIE
	2x AAA	📦

EN Digital universal multimeter
PL Cyfrowy miernik uniwersalny
DE Digital-Multimeter
RU Универсальный цифровой измеритель
CZ Digitální multimetr univerzální
HU Digitális multiméter
RO Multimetru digital universal
FR Multimètre numérique universel
IT Multimetro digitale universale
ES Multimetro digital universal
CN 数字万用表



TRUE RMS	LCD 1999	0-600V A.C.
0-600V D.C.	0-20 A A.C.	0-20 A D.C.
0-20 MΩ	0-20 mF	°C -40 +1000
0-60 MHz	h _{FE} PNP NPN	⚡
📶	DATA HOLD	LED BACKLIGHT POSSWIETLENIE
AUTO POWER OFF AUTOMATYCZNE WYŁĄCZANIE	9 V 6F22	📦

YATO

YT-73094

40

YATO

YT-73083

20

EN Digital universal multimeter
PL Cyfrowy miernik uniwersalny
DE Digital-Multimeter
RU Универсальный цифровой измеритель
CZ Digitální multimetr univerzální
HU Digitális multiméter
RO Multimetru digital universal
FR Multimètre numérique universel
IT Multimetro digitale universale
ES Multimetro digital universal
CN 数字万用表



TRUE RMS	LCD 5999	0-600V A.C.
0-600V D.C.	0-10 A A.C.	0-10 A D.C.
0-60 MΩ	0-60 mF	0-60 MHz
°C -40 +1370	1±99%	h _{FE} PNP NPN
⚡	📶	AUTO RANGE AUTO ZAKRES
DATA HOLD	MAX HOLD	MIN HOLD
LED BACKLIGHT POSSWIETLENIE	AUTO POWER OFF AUTOMATYCZNE WYŁĄCZANIE	🔪
	9 V 6F22	📦

EN Digital universal multimeter
PL Cyfrowy miernik uniwersalny
DE Digital-Multimeter
RU Универсальный цифровой измеритель
CZ Digitální multimetr univerzální
HU Digitális multiméter
RO Multimetru digital universal
FR Multimètre numérique universel
IT Multimetro digitale universale
ES Multimetro digital universal
CN 数字万用表



TRUE RMS	LCD 19999	0-750V A.C.
0-999.9V D.C.	0-19.999 A A.C.	0-19.999 A D.C.
0-199.99 MΩ	0-9.999 mF	0-9.999 MHz
°C -20 +1000	1±99%	⚡
📶	NCV	CONTINUITY TEST TEST CIĄGŁOŚCI
AUTO RANGE AUTO ZAKRES	DATA HOLD	MAX MIN
REL RELATIVE VALUE WARTOŚĆ WZGLĘDNA	LED BACKLIGHT POSSWIETLENIE	AUTO POWER OFF AUTOMATYCZNE WYŁĄCZANIE
	2x AA	📦

EN Digital universal multimeter
PL Cyfrowy miernik uniwersalny
DE Digital-Multimeter
RU Универсальный цифровой измеритель
CZ Digitální multimetr univerzální
HU Digitális multiméter
RO Multimetru digital universal
FR Multimètre numérique universel
IT Multimetro digitale universale
ES Multimetro digital universal
CN 数字万用表



TRUE RMS	LCD 9999	0-1000V A.C.
0-750V A.C.	0-1000V D.C.	0-10 A A.C.
0-10 A D.C.	0-99.99 MΩ	0-99.99 mF
0-9.999 MHz	°C -20 +1000	1±99%
⚡	📶	🔪
NCV	V A.C. VFC	CONTINUITY TEST TEST CIĄGŁOŚCI
AUTO & MANUAL MODE TRYB REZYM AUTOMATYCZNY	DATA HOLD	FRONT LIGHT LATARKA
AUTO POWER OFF AUTOMATYCZNE WYŁĄCZANIE	2x AA	📦

For YT-73090
Dla YT-73090

YATO

YT-73085

20

YATO

YT-730893

50

YATO

YT-73097

30

EN Digital universal multimeter
PL Cyfrowy miernik uniwersalny
DE Digital-Multimeter
RU Универсальный цифровой измеритель
CZ Digitální multimetr univerzální
HU Digitális multiméter
RO Multimetru digital universal
FR Multimètre numérique universel
IT Multimetro digitale universale
ES Multimetro digital universal
CN 数字万用表

- 5 in 1
5 w 1
- LCD
3999
- 0-300V A.C.
- 0-300V D.C.
- 0-10 A A.C.
- 0-10 A D.C.
- 0-40 MΩ
- 0-100 µF
- 0.01-200 kHz
- °C 20 + 1000
- 5+95%
- RH 30+99%
- 3.5-100dB
- 40000 lx
- AUTO RANGE AUTO ZAKRES
- DATA HOLD
- REL RELATIVE VALUE WARTOŚĆ RELACYJNA
- LED BACKLIGHT PODSWIETLENIE
- AUTO POWER OFF AUTOMATYCZNE WYŁĄCZANIE
- 9 V 6F22 I



YATO

YT-73087



24

EN Clamp universal multimeter
PL Cęgowy miernik uniwersalny
DE Universal Zangenamperemeter
RU Универсальные токоизмерительные клещи
CZ Univerzální klešťový multimetr
HU Univerzáls bilincs multiméter
RO Multimetru universal cu clemă
FR Pince multimètre universel
IT Multimetro a pinza universale
ES Multimetro de pinza universal
CN 钳形万用表

- LCD
1999
- 0-600V A.C.
- 0-600V D.C.
- 0-600A A.C.
- 0-200 MΩ
- °C - 20 + 1000
- DATA HOLD
- MAX HOLD
- LED BACKLIGHT PODSWIETLENIE
- AUTO POWER OFF AUTOMATYCZNE WYŁĄCZANIE
- 2x AA I



YATO

YT-73091



20

EN Clamp universal multimeter
PL Cęgowy miernik uniwersalny
DE Universal Zangenamperemeter
RU Универсальные токоизмерительные клещи
CZ Univerzální klešťový multimetr
HU Univerzáls bilincs multiméter
RO Multimetru universal cu clemă
FR Pince multimètre universel
IT Multimetro a pinza universale
ES Multimetro de pinza universal
CN 钳形万用表

- 0-600A A.C.



For YT-73085
Dla YT-73085

YATO

YT-73090



50

EN Clamp universal multimeter
PL Cęgowy miernik uniwersalny
DE Universal Zangenamperemeter
RU Универсальные токоизмерительные клещи
CZ Univerzální klešťový multimetr
HU Univerzáls bilincs multiméter
RO Multimetru universal cu clemă
FR Pince multimètre universel
IT Multimetro a pinza universale
ES Multimetro de pinza universal
CN 钳形万用表

- TRUE RMS
- LCD
6000
- 0-600V A.C.
- 0-600V D.C.
- 0-600A A.C.
- 0-600A D.C.
- 0-60 MΩ
- 0-60 mF
- 0-10 MHz
- °C - 30 + 1000
- DATA HOLD
- PEAK HOLD
- LED BACKLIGHT PODSWIETLENIE
- NCV
- AUTO RANGE AUTO ZAKRES
- FRONT LIGHT LATARKA
- AUTO POWER OFF AUTOMATYCZNE WYŁĄCZANIE
- 2x AAA I



YATO

YT-73093



50

EN Clamp universal multimeter
PL Cęgowy miernik uniwersalny
DE Universal Zangenamperemeter
RU Универсальные токоизмерительные клещи
CZ Univerzální klešťový multimetr
HU Univerzáls bilincs multiméter
RO Multimetru universal cu clemă
FR Pince multimètre universel
IT Multimetro a pinza universale
ES Multimetro de pinza universal
CN 钳形万用表

- TRUE RMS
- LCD
5999
- 0-600V A.C.
- 0-600V D.C.
- 0-600A A.C.
- 0-60 MΩ
- NCV
- LOW IMPEDANCE MODE TRYB NISKIEJ IMPEDANCIJ
- V A.C. VFC
- CONTINUITY TEST TEST CIĄGŁOŚCI
- AUTO RANGE AUTO ZAKRES
- DATA HOLD
- LED BACKLIGHT PODSWIETLENIE
- FRONT LIGHT LATARKA
- AUTO POWER OFF AUTOMATYCZNE WYŁĄCZANIE
- 2x AAA I



YATO

YT-73092



40

EN Clamp universal multimeter
PL Cęgowy miernik uniwersalny
DE Universal Zangenamperemeter
RU Универсальные токоизмерительные клещи
CZ Univerzální klešťový multimetr
HU Univerzáls bilincs multiméter
RO Multimetru universal cu clemă
FR Pince multimètre universel
IT Multimetro a pinza universale
ES Multimetro de pinza universal
CN 钳形万用表

- TRUE RMS
- LCD
6000
- 0-750V A.C.
- 0-1000V D.C.
- 0-1000A A.C.
- 0-1000A D.C.
- 0-60 MΩ
- 0-100 mF
- 0-10 MHz
- °C - 30 + 1000
- DATA HOLD
- PEAK HOLD
- LED BACKLIGHT PODSWIETLENIE
- NCV
- AUTO RANGE AUTO ZAKRES
- FRONT LIGHT LATARKA
- AUTO POWER OFF AUTOMATYCZNE WYŁĄCZANIE
- 3x AAA I



YATO

YT-730933



30

EN Probe set for multimeters
PL Zestaw sond pomiarowych do mierników
DE Sondensatz für Multimeter
RU Набор зонд для тестеров
CZ Měřicí šňůry k multimetru
HU Mérőszinór pár digitális multiméterekhez
RO Set sonde pt. multimetru
FR Jeu de cordons de test multimètre
IT Kit di puntali per misuratori
ES Juego de sondas de medición para medidores
CN 表笔

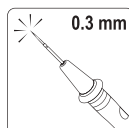

- 1000 V
- 120 cm
- CAT. III
- SILICONE INSULATION IZOLACJA SILIKONOWA
- 80 AWG COPPER WIRES DRUTY MIEDZIANE OCYNOWANE



YATO

YT-73077



50/100

EN Probe set for multimeters
PL Zestaw sond pomiarowych do mierników
DE Sondensatz für Multimeter
RU Набор зонд для тестеров
CZ Měřicí šňůry k multimetru
HU Mérőszinór pár digitális multiméterekhez
RO Set sonde pt. multimetru
FR Jeu de cordons de test multimètre
IT Kit di puntali per misuratori
ES Juego de sondas de medición para medidores
CN 表笔



YATO



YT-73078



50/100



EN Tweezer RO Pensetă
PL Pęseta FR Pince
DE Pinzette IT Pinza
RU Пинцет ES Pinzas
CZ Pinzeta CN 尖头镊子
HU Csipesz



YATO 	L [mm]	
YT-6903	140	20/240



EN Tweezer RO Pensetă
PL Pęseta FR Pince
DE Pinzette IT Pinza
RU Пинцет ES Pinzas
CZ Pinzeta CN 弯头镊子
HU Csipesz



YATO 	L [mm]	
YT-6907	115	20/240

EN Tweezer RO Pensetă
PL Pęseta FR Pince
DE Pinzette IT Pinza
RU Пинцет ES Pinzas
CZ Pinzeta CN 防静电镊子
HU Csipesz





YATO 	L [mm]	
YT-6916	140	20/240

EN Electrical insulation tape
PL Taśma elektroizolacyjna
DE Elektro-Isolierband
RU Изолянта
CZ Elektroizolační páska
HU Elektromos szigetelőszalag
RO Bandă izolatoare electricieni
FR Ruban isolant électrique
IT Nastro isolante elettrico
ES Cinta aislante eléctrica
CN 电工绝缘胶带



- In accordance with standard EN 60454-3-1-1/F-PVC/60/R-Tp
- Dielectric strength: >40 Kv/mm
- Elongation: >125%
- Flame test: Store temperature: 10-40°C
- Using temperature: 5-50°C

- Zgodność z normą EN 60454-3-1-1/F-PVC/60/R-Tp
- Wytrzymałość dielektryczna: >40 Kv/mm
- Wydłużenie: >125%
- Test ogniowy: Temperatura składowania: 10-40°C
- Temperatura użytkowania: 5-50°C



YATO 	W [mm]	L [m]	± [mm]	
YT-8152	12	10	0.13	96/384
YT-8159	15	20	0.13	72/288
YT-8165	19	20	0.13	72/288
YT-8174	25	20	0.19	48/192
YT-8177	50	33	0.19	48

EN Electrical insulation tape
PL Taśma elektroizolacyjna
DE Elektro-Isolierband
RU Изолянта
CZ Elektroizolační páska
HU Elektromos szigetelőszalag
RO Bandă izolatoare electricieni
FR Ruban isolant électrique
IT Nastro isolante elettrico
ES Cinta aislante eléctrica
CN 电工绝缘胶带



- In accordance with standard EN 60454-3-1-1/F-PVC/60/R-Tp
- Dielectric strength: >40 Kv/mm
- Elongation: >125%
- Flame test: Store temperature: 10-40°C
- Using temperature: 5-50°C

- Zgodność z normą EN 60454-3-1-1/F-PVC/60/R-Tp
- Wytrzymałość dielektryczna: >40 Kv/mm
- Wydłużenie: >125%
- Test ogniowy: Temperatura składowania: 10-40°C
- Temperatura użytkowania: 5-50°C



YATO 	W [mm]	L [m]	± [mm]	
YT-81592	15	20	0.13	72/288
YT-8166	19	20	0.13	72/288

EN Electrical insulation tape
PL Taśma elektroizolacyjna
DE Elektro-Isolierband
RU Изолянта
CZ Elektroizolační páska
HU Elektromos szigetelőszalag
RO Bandă izolatoare electricieni
FR Ruban isolant électrique
IT Nastro isolante elettrico
ES Cinta aislante eléctrica
CN 电工绝缘胶带



- In accordance with standard EN 60454-3-1-1/F-PVC/60/R-Tp
- Dielectric strength: >40 Kv/mm
- Elongation: >125%
- Flame test: Store temperature: 10-40°C
- Using temperature: 5-50°C

- Zgodność z normą EN 60454-3-1-1/F-PVC/60/R-Tp
- Wytrzymałość dielektryczna: >40 Kv/mm
- Wydłużenie: >125%
- Test ogniowy: Temperatura składowania: 10-40°C
- Temperatura użytkowania: 5-50°C



YATO 	W [mm]	L [m]	± [mm]	
YT-81594	15	20	0.13	72/288
YT-81654	19	20	0.13	72/288

EN Electrical insulation tape
PL Taśma elektroizolacyjna
DE Elektro-Isolierband
RU Изолянта
CZ Elektroizolační páska
HU Elektromos szigetelőszalag
RO Bandă izolatoare electricieni
FR Ruban isolant électrique
IT Nastro isolante elettrico
ES Cinta aislante eléctrica
CN 电工绝缘胶带



- In accordance with standard EN 60454-3-1-1/F-PVC/60/R-Tp
- Dielectric strength: >40 Kv/mm
- Elongation: >125%
- Flame test: Store temperature: 10-40°C
- Using temperature: 5-50°C

- Zgodność z normą EN 60454-3-1-1/F-PVC/60/R-Tp
- Wytrzymałość dielektryczna: >40 Kv/mm
- Wydłużenie: >125%
- Test ogniowy: Temperatura składowania: 10-40°C
- Temperatura użytkowania: 5-50°C



YATO 	W [mm]	L [m]	± [mm]	
YT-81596	15	20	0.13	72/288
YT-81656	19	20	0.13	72/288

EN Electrical insulation tape
PL Taśma elektroizolacyjna
DE Elektro-Isolierband
RU Изолянта
CZ Elektroizolační páska
HU Elektromos szigetelőszalag
RO Bandă izolatoare electricieni
FR Ruban isolant électrique
IT Nastro isolante elettrico
ES Cinta aislante eléctrica
CN 电工绝缘胶带



- In accordance with standard EN 60454-3-1-1/F-PVC/60/R-Tp
- Dielectric strength: >40 Kv/mm
- Elongation: >125%
- Flame test: Store temperature: 10-40°C
- Using temperature: 5-50°C

- Zgodność z normą EN 60454-3-1-1/F-PVC/60/R-Tp
- Wytrzymałość dielektryczna: >40 Kv/mm
- Wydłużenie: >125%
- Test ogniowy: Temperatura składowania: 10-40°C
- Temperatura użytkowania: 5-50°C



YATO 	W [mm]	L [m]	± [mm]	
YT-81591	15	20	0.13	72/288
YT-81651	19	20	0.13	72/288

EN Electrical insulation tape
PL Taśma elektroizolacyjna
DE Elektro-Isolierband
RU Изолянта
CZ Elektroizolační páska
HU Elektromos szigetelőszalag
RO Bandă izolatoare electricieni
FR Ruban isolant électrique
IT Nastro isolante elettrico
ES Cinta aislante eléctrica
CN 电工绝缘胶带



- In accordance with standard EN 60454-3-1-1/F-PVC/60/R-Tp
- Dielectric strength: >40 Kv/mm
- Elongation: >125%
- Flame test: Store temperature: 10-40°C
- Using temperature: 5-50°C

- Zgodność z normą EN 60454-3-1-1/F-PVC/60/R-Tp
- Wytrzymałość dielektryczna: >40 Kv/mm
- Wydłużenie: >125%
- Test ogniowy: Temperatura składowania: 10-40°C
- Temperatura użytkowania: 5-50°C

YATO 	W [mm]	L [m]	± [mm]	
YT-81593	15	20	0.13	72/288
YT-81655	19	20	0.13	72/288

EN Electrical insulation tape
 PL Taśma elektroizolacyjna
 DE Elektro-Isolierband
 RU Изолянта
 CZ Elektroizolační páska
 HU Elektromos szigetelőszalag
 RO Bandă izolatoare electricieni
 FR Ruban isolant électrique
 IT Nastro isolante elettrico
 ES Cinta aislante eléctrica
 CN 电工绝缘胶带



EN Electrical insulation tape
 PL Taśma elektroizolacyjna
 DE Elektro-Isolierband
 RU Изолянта
 CZ Elektroizolační páska
 HU Elektromos szigetelőszalag
 RO Bandă izolatoare electricieni
 FR Ruban isolant électrique
 IT Nastro isolante elettrico
 ES Cinta aislante eléctrica
 CN 电工绝缘胶带



10
PCS



- In accordance with standard EN 60454-3-1-1/F-PVC/60/R-Tp
- Dielectric strength: >40 Kv/mm
- Elongation: >125%
- Flame test: Store temperature: 10-40°C
- Using temperature: 5-50°C
- Zgodność z normą EN 60454-3-1-1/F-PVC/60/R-Tp
- Wytrzymałość dielektryczna: >40 Kv/mm
- Wydłużenie: >125%
- Test ogniowy: Temperatura składowania: 10-40°C
- Temperatura użytkowania: 5-50°C

- In accordance with standard EN 60454-3-1-1/F-PVC/60/R-Tp
- Dielectric strength: >40 Kv/mm
- Elongation: >125%
- Flame test: Store temperature: 10-40°C
- Using temperature: 5-50°C
- Zgodność z normą EN 60454-3-1-1/F-PVC/60/R-Tp
- Wytrzymałość dielektryczna: >40 Kv/mm
- Wydłużenie: >125%
- Test ogniowy: Temperatura składowania: 10-40°C
- Temperatura użytkowania: 5-50°C

YATO	W [mm]	L [m]	± [mm]	
YT-81595	15	20	0.13	72/288
YT-81652	19	20	0.13	72/288

YATO	W [mm]	L [m]	± [mm]	
YT-8156	12	10	0.13	10/40
YT-8173	19	20	0.13	6/24

EN Tool set for electricians
 PL Zestaw narzędziowy dla elektryków
 DE Werkzeug-Set für Elektriker
 RU Набор инструментов для электриков
 CZ Sada nářadí pro elektrikáře
 HU Szerszámkészlet villanyszerelők

RO Trusa electrician
 FR Ensemble d'outils pour les électriciens
 IT Set per l'elettricista
 ES Conjunto de herramientas para electricistas
 CN 高档电讯组套

68 PCS 1/4" 6.3mm 1000 V CrV 50BV30 CrV 6150 S2



- 1/4" (6.3 mm): 4, 4.5, 5, 5.5, 6, 7, 8, 9, 10, 11, 12, 13 mm (L=25 mm); CrV 50BV30;
- 140 mm;
- 190 mm; 3CRB;
- 150 mm;
- 160 mm; 1000 V; CrV;
- 160 mm; 1000 V; CrV;
- 3 m x 16 mm;
- 175 mm;
- 19.5 x 190 mm;
- 1.5 V; 9 LED;
- 9 mm;
- 19 mm x 20 mm;
- 1/4" (6.3 mm); (150 mm); CrV 50BV30;
- 1/4" (6.3 mm) x 1/4" (6.3 mm); CrV 6140;
- 10 g;
- 1.4, 2.0, 2.4 mm; PH00, PH0, PH1; S2;
- 4x100, 5.5x125, PH1x80, PH2x100 mm; 1000V; S2;
- 1/4" (6.3 mm): 3, 4, 5, 5.5, 6 mm (L=25 mm); AISI S2;
- 1/4" (6.3 mm): PH1, PH2, PH3 (L=25 mm); AISI S2;
- 1/4" (6.3 mm): T8, T10, T15, T20, T25, T27 (L=25 mm); AISI S2;
- 1/4" (6.3 mm): 2, 2.5, 3, 4, 5, 6 (L=25 mm); AISI S2;
- 1.5, 2, 2.5, 3, 4, 5, 6, 7, 8, 10 mm; CrV 6150



YATO	
YT-39009	2

- EN Cable access
PL Przepychacz przewodów
DE Kabel Einziehhilfe
RU Устройство для протяжки кабеля
CZ Pero protahovací
HU Kábelhúzó szalag
RO Dispozitiv de tragere a cablurilor
FR Les baguettes tire fil
IT Dispositivo tiracavi
ES Guía de fibra de vidrio
CN 玻璃纤维杆

14
PCS

10x1
m

BRASS
MOSIĄDZ

FIBERGLASS
WŁÓKNO
SZKLANE



YATO	
YT-23200	12/36

- EN Cable access accessories
PL Akcesoria do przepychacza do przewodów
DE Kabel Einziehhilfe Accessoires
RU Устройство для протяжки кабеля - аксессуары
CZ Pero protahovací příslušenství
HU Kábelhúzó szalag kiegészítők
RO Accesorii pt. dispozitiv de tragere a cablurilor
FR Les baguettes tire fil accessoires
IT Accessori per il dispositivo tiracavi
ES Guía de fibra de vidrio accesorios
CN 铜接头



5
PCS



BRASS
MOSIĄDZ



YATO	
YT-23201	24/144

- EN Cable access
PL Przepychacz przewodów
DE Kabel Einziehhilfe
RU Устройство для протяжки кабеля
CZ Pero protahovací
HU Kábelhúzó szalag
RO Dispozitiv de tragere a cablurilor
FR Les baguettes tire fil
IT Dispositivo tiracavi
ES Guía de fibra de vidrio
CN 穿线器

15.3
m

3x1.5
mm

STEEL
STAL

ABS

BRAKE
HAMULEC



YATO	L [m]	
YT-25010	15.3	6/12

- EN Cable access
PL Przepychacz przewodów
DE Kabel Einziehhilfe
RU Устройство для протяжки кабеля
CZ Pero protahovací
HU Kábelhúzó szalag
RO Dispozitiv de tragere a cablurilor
FR Les baguettes tire fil
IT Dispositivo tiracavi
ES Guía de fibra de vidrio
CN 穿线器

30m

∅
4.0
mm

FIBERGLASS
WŁÓKNO
SZKLANE



YATO	L [m]	∅ [mm]	
YT-25015	30	4	10

Memo

8

Hammers, chisels,
punches & axes
Młotki, dłuta,
przecinaki i siekiery



Machinist hammers Młotki ślusarskie	
144	

Ball pein hammers & sets Młotki blacharskie i zestawy	
147	

Stoning hammers Młotki kamieniarskie	
144	

Geological hammers Młotki geologiczne	
147	

Hammers with tubular steel handle Młotki z trzonkiem rurowym	
144-145	

Chisels, cold chisels & punches Dłuta, przecinaki i przebijaki	
148-152	

Claw hammers Młotki szewskie	144
Roofing hammers Młotki ciesielskie	144
Mason's hammers Młotki murarskie	145
Plasterer's hatchets Toporki tynkarskie	145

Wood chisels & sets Dłuta stolarskie i zestawy	148
Cold chisels Przecinaki	149
Pin punches Wybijaki	150
Punches Punktaki	150
Cold chisel & punch sets Zestawy przecinaków i punktaków	150

Fully drop forged hammers Młotki monolityczne kute	
145	

Wrecking bars Łomy	
152-153	

Claw hammers Młotki szewskie	145
Roofing hammers Młotki ciesielskie	145
Mason's hammers Młotki murarskie	145

Axes Siekiery	
153-154	

Rubber mallets Młotki gumowe	
146	

Adzes Ciosła	
154	

Dead blow hammers Młotki bezodrzutowe	
146	

Forestry tools Narzędzia leśne	
154-155	

Paving hammers & accessories Młotki brukarskie i akcesoria	
147	

EN Machinist hammer CZ Zámečnické kladivo IT Martello da fabbro
 PL Młotek ślusarski HU Lakatos kalapács ES Martillo de cerrajero
 DE Schlosserhammer RO Ciocan de lăcătușerie CN 钳工锤
 RU Молоток слесарный FR Marteau de serrurier

DIN 1041 **DROP FORGED KUTE**

- High quality wooden handle
- Forged carbon steel head
- Safety protection steel ring
- Drewniany trzonek wysokiej jakości
- Kuty obuch ze stali węglowej
- Klin pierścieniowy zapewniający bezpieczeństwo

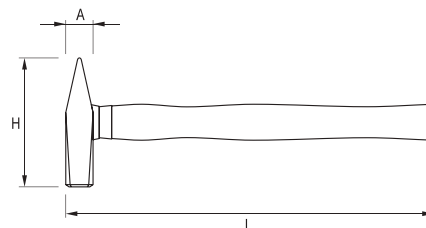

YATO	m [g]	L [mm]	A [mm]	H [mm]	
YT-4491	100	260	15	80	12/120
YT-4492	200	280	20	93	6/60
YT-4493	300	300	21	103	6/60
YT-4494	400	310	23	111	6/48
YT-4495	500	320	26	118	6/36

YATO	m [g]	L [mm]	A [mm]	H [mm]	
YT-4496	600	330	28	119	6/36
YT-4497	800	350	31	125	6/24
YT-4498	1000	360	35	132	6/24
YT-4499	1500	380	40	143	6/12
YT-4500	2000	400	45	153	6/12

EN Machinist hammer CZ Zámečnické kladivo IT Martello da fabbro
 PL Młotek ślusarski HU Lakatos kalapács ES Martillo de cerrajero
 DE Schlosserhammer RO Ciocan de lăcătușerie CN 钳工锤
 RU Молоток слесарный FR Marteau de serrurier

DIN 1041 **DROP FORGED KUTE**

- High quality wooden handle
- Forged carbon steel head
- Safety protection steel ring
- Drewniany trzonek wysokiej jakości
- Kuty obuch ze stali węglowej
- Klin pierścieniowy zapewniający bezpieczeństwo

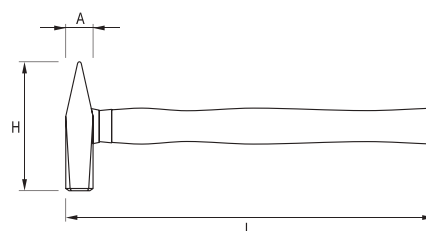

YATO	m [g]	L [mm]	A [mm]	H [mm]	
YT-4501	100	260	15	82	12/120
YT-4502	200	280	19	95	6/60
YT-4503	300	300	23	105	6/60
YT-4504	400	310	25	112	6/48
YT-4505	500	320	27	118	6/36

YATO	m [g]	L [mm]	A [mm]	H [mm]	
YT-4506	600	330	29	122	6/36
YT-4507	800	350	33	135	6/24
YT-4508	1000	360	36	135	6/24
YT-4509	1500	380	42	145	6/12
YT-4510	2000	400	47	155	6/12

EN Stoning hammer CZ Palička kovová IT Martello spaccapietra
 PL Młotek kamieniarski HU Kőtörő kalapács ES Martillo de piedra
 DE Fäustel RO Ciocan pt. zidărie CN 石工锤
 RU Молот двухобуховый FR Massette tailleur de pierre

DIN 6475 **DROP FORGED KUTE**

- High quality wooden handle
- Forged carbon steel head
- Safety protection steel ring
- Drewniany trzonek wysokiej jakości
- Kuty obuch ze stali węglowej
- Klin pierścieniowy zapewniający bezpieczeństwo

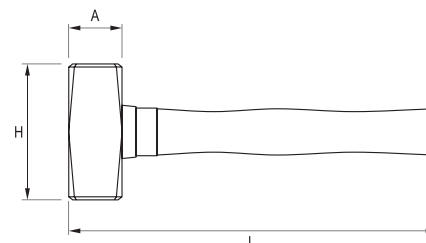

YATO	m [g]	L [mm]	A [mm]	H [mm]	
YT-4550	1000	260	40	95	6/24
YT-4551	1250	260	43	100	6/24

YATO	m [g]	L [mm]	A [mm]	H [mm]	
YT-4552	1500	280	45	110	6/12
YT-4553	2000	300	50	120	6/12

EN Claw hammer CZ Tesařské kladivo
 PL Młotek stolarski HU Szegehűző kalapács
 DE Klauenhammer RO Ciocan pt. cizmărie
 RU Молоток гвоздодеп FR Marteau à panne fendue
 IT Martello da carpentiere ES Martillo carpintero
 CN 羊角锤



- High quality steel handle
- Forged carbon steel head hardened and tempered
- Stalowy trzonek
- Bijak ze stali węglowej, kuty, ulepszony cieplnie

YATO	m [g]	L [mm]	A [mm]	H [mm]	
YT-4560	450	318	30	130	6/24

EN Roofing hammer CZ Tesařské kladivo
 PL Młotek ciesielski HU Ácskalapács
 DE Lattenhammer RO Ciocan de dulgherie
 RU Молоток кровельщика FR Marteau de charpentier
 IT Martello da carpentiere ES Martillo para techos
 CN 独角锤



- High quality steel handle
- Forged carbon steel head hardened and tempered
- Stalowy trzonek
- Bijak ze stali węglowej, kuty, ulepszony cieplnie

YATO	m [g]	L [mm]	A [mm]	H [mm]	
YT-4561	600	318	25x25	165	6/24

EN Masonry hammer, type B
PL Młotek murarski berliński
DE Maurehammer, Berliner Form
RU Молоток каменщика берлинский
CZ Kladivo zednické berlínské
HU Kőműves kalapács Berliáni típusú
RO Ciocan de zidărie tip Berlin
FR Marteau du maçon berlinois
IT Martello da muratore, tipo Berlino
ES Martillo de albañil de Berlín
CN 泥工锤

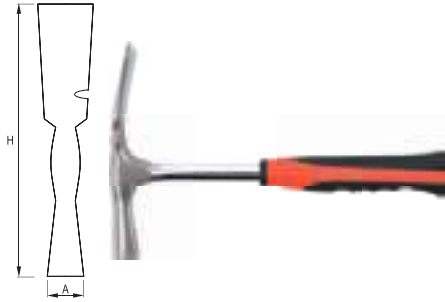

- High quality steel handle
- Forged carbon steel head hardened and tempered
- Stalowy trzonek
- Bijał ze stali węglowej, kut, ulepszonej cieplnie

YATO	m [g]	L [mm]	A [mm]	H [mm]	
YT-4562	600	315	24x23	200	6/24

EN Masonry hammer, type R
PL Młotek murarski reński
DE Maurerhammer, Rheinische Form
RU Молоток каменщика рейнский
CZ Kladivo zednické rýnské
HU Kőműves kalapács Rajnai típusú
RO Ciocan de zidărie tip Rin
FR Marteau de maçon, modèle Rhin
IT Martello da muratore, tipo Reno
ES Martillo de albañil de Rin
CN 泥工锤



- High quality steel handle
- Forged carbon steel head hardened and tempered
- Stalowy trzonek
- Bijał ze stali węglowej, kut, ulepszonej cieplnie

YATO	m [g]	L [mm]	A [mm]	H [mm]	
YT-4563	600	315	23x23	170	6/24

EN Plasterer's hatchet
PL Toperek tynkarski
DE Gipserbeil
RU Топор штукатурный
CZ Omláčací sekýrka
HU Kőműves szekerce
RO Ciocan pt. tencuie
FR Hachette de plâtrier
IT Martello con accetta
ES Hacha enlucido
CN 多用斧



- High quality steel handle
- Forged carbon steel head hardened and tempered
- Stalowy trzonek
- Bijał ze stali węglowej, kut, ulepszonej cieplnie

YATO	m [g]	L [mm]	A [mm]	H [mm]	
YT-4564	600	315	25x20	175	6/24

EN Claw hammer
PL Młotek stolarski
DE Klauenhammer
RU Молоток-гвоздодеп
CZ Tesafské kladivo
HU Szeghűző kalapács
RO Ciocan pt. cizmărie
FR Marteau à panne fendue
IT Martello da carpentiere
ES Martillo carpintero
CN 羊角锤



- High quality steel handle
- Forged carbon steel head hardened and tempered
- Stalowy trzonek
- Bijał ze stali węglowej, kut, ulepszonej cieplnie

YATO	m [g]	L [mm]	A [mm]	H [mm]	
YT-4570	450	315	30	130	6/24

EN Roofing hammer
PL Młotek ciesielski
DE Lattenhammer
RU Молоток кровельщика
CZ Tesafské kladivo
HU Ácskalapács
RO Ciocan de dulgherie
FR Marteau de charpentier
IT Martello da carpentiere
ES Martillo para techos
CN 独角锤



- High quality steel handle
- Forged carbon steel head hardened and tempered
- Stalowy trzonek
- Bijał ze stali węglowej, kut, ulepszonej cieplnie

YATO	m [g]	L [mm]	A [mm]	H [mm]	
YT-4571	600	331	25x25	165	6/24

EN Masonry hammer, type R
PL Młotek murarski reński
DE Maurerhammer, Rheinische Form
RU Молоток каменщика рейнский
CZ Kladivo zednické rýnské
HU Kőműves kalapács Rajnai típusú
RO Ciocan de zidărie tip Rin
FR Marteau de maçon, modèle Rhin
IT Martello da muratore, tipo Reno
ES Martillo de albañil de Rin
CN 泥工锤



- High quality steel handle
- Forged carbon steel head hardened and tempered
- Stalowy trzonek
- Bijał ze stali węglowej, kut, ulepszonej cieplnie

YATO	m [g]	L [mm]	A [mm]	H [mm]	
YT-4573	600	382	25x24	158	6/24

EN Claw hammer
PL Młotek stolarski
DE Klauenhammer
RU Молоток-гвоздодеп
CZ Tesafské kladivo
HU Szeghűző kalapács
RO Ciocan pt. cizmărie
FR Marteau à panne fendue
IT Martello da carpentiere
ES Martillo carpintero
CN 羊角锤



450 g 340 mm #45

YATO	m [g]	L [mm]	A [mm]	H [mm]	
YT-45660	450	340	30	130	6/24

EN Rubber mallet
 PL Miotek gumowy
 DE Gummihammer
 RU Киянка резиновая
 CZ Pryžové kladivo
 HU Gumikalapács
 RO Ciocan de cauciuc
 FR Marteau en caoutchouc
 IT Martello di gomma
 ES Mazo de goma
 CN 橡胶锤



YATO	m [g]	L [mm]	Ø [mm]	H [mm]	
YT-4594	440	340	50	87.5	6/36

EN Rubber mallet
 PL Miotek gumowy
 DE Gummihammer
 RU Киянка резиновая
 CZ Pryžové kladivo
 HU Gumikalapács
 RO Ciocan de cauciuc
 FR Marteau en caoutchouc
 IT Martello di gomma
 ES Mazo de goma
 CN 橡胶锤



YATO	m [g]	L [mm]	Ø [mm]	H [mm]	
YT-4601	340	291	49	79.5	12/48
YT-4602	370	300	50	87.5	6/36
YT-4603	580	341	58	96	6/36
YT-4604	780	341	63	117	6/24
YT-4605	980	345	72	122	6/24

EN Dead blow mallet
 PL Miotek bezodrzutowy
 DE Rückschlagsfreier Schonhammer
 RU Молоток безинерционный
 CZ Palička nárazová plněná celogumová
 HU Visszarúgás mentes gumikalapács
 RO Ciocan cu absorbție
 FR Maillet sans recul
 IT Martello morto colpo
 ES Martillo sin reacción
 CN 防震无回弹橡胶锤



YATO	m [g]	L [mm]	Ø [mm]	H [mm]	
YT-4620	740	300	44.5	100	4/24
YT-4622	900	336	53.5	100	4/24
YT-4623	1300	350	59	118.5	3/12

8

EN Dead blow mallet
 PL Miotek bezodrzutowy
 DE Rückschlagsfreier Schonhammer
 RU Молоток безинерционный
 CZ Palička nárazová plněná celogumová
 HU Visszarúgás mentes gumikalapács
 RO Ciocan cu absorbție
 FR Maillet sans recul
 IT Martello morto colpo
 ES Martillo sin reacción
 CN 橡胶锤



YATO	m [g]	L [mm]	[mm]	
YT-46270	2400	490	70x70x140	2/6
YT-46273	5500	900	105x105x180	2

EN Dead blow mallet
 PL Miotek bezodrzutowy
 DE Rückschlagsfreier Schonhammer
 RU Молоток безинерционный
 CZ Palička nárazová plněná celogumová
 HU Visszarúgás mentes gumikalapács
 RO Ciocan cu absorbție
 FR Maillet sans recul
 IT Martello morto colpo
 ES Martillo sin reacción
 CN 尼龙安装锤



YATO	m [g]	L [mm]	Ø [mm]	H [mm]	
YT-4624	265	318	30	94	10/40
YT-4625	430	350	40	100	6/36
YT-4626	490	348	45	110	6/36

EN Dead blow mallet
 PL Miotek bezodrzutowy
 DE Rückschlagsfreier Schonhammer
 RU Молоток безинерционный
 CZ Palička nárazová plněná celogumová
 HU Visszarúgás mentes gumikalapács
 RO Ciocan cu absorbție
 FR Maillet sans recul
 IT Martello morto colpo
 ES Martillo sin reacción
 CN 铜头无弹力锤



YATO	m [g]	L [mm]	Ø [mm]	H [mm]	
YT-46190	300	225	20	75	6/36
YT-46191	700	330	32	110	6/24

EN Soft face hammer
 PL Miotek blacharski
 DE Schonhammer
 RU Молоток рихтовочный
 CZ Palička klempářská
 HU Bádógos kalapács
 RO Ciocan pt. tablă
 FR Marteau de carrossier
 IT Martello da battilastra
 ES Martillo chapista
 CN 安装锤



YATO	m [g]	L [mm]	Ø [mm]	H [mm]	
YT-4630	150	250	22	75	6/48
YT-4631	250	280	28	85	6/36
YT-4632	340	315	35	95	6/36
YT-4633	660	350	45	105	6/24
YT-4634	1340	380	60	132	4/16

EN Aluminum hammer
 PL Miotek aluminiowy
 DE Aluminium-Hammer
 RU Алюминиевый молоток
 CZ Hliníkové kladivo
 HU Alumínium kalapács
 RO Ciocan aluminiu
 FR Marteau en aluminium
 IT Martello in alluminio
 ES Martillo de aluminio
 CN 铝锤



YATO	m [g]	L [mm]	Ø [mm]	H [mm]	
YT-45280	150	280	30	80	6/36
YT-45281	300	300	40	98	6/36
YT-45282	580	320	50	105	6/24

EN Mounting hammer
 PL Miotek montażowy z wymiennymi końcówkami
 DE Montagehammer
 RU Установка молоток
 CZ Montážní kladivo
 HU Szerelő kalapács
 RO Ciocan cu vârfuri interschimbabile
 FR Marteau de montage
 IT Martello di montaggio con punte intercambiabili
 ES Martillo de montaje
 CN 铝合金多用安装锤



	HRC: 65 +/-5
	HRC: 72 +/-5
	HRC: 73 +/-5
	HRC: 80 +/-5
	HRC: 95 +/-5

YATO	
YT-45905	8

EN Paving hammer
PL Młotek brukarski
DE Pflasterhammer
RU Молоток для укладки брусчатки
CZ Dlažební kladivo
HU Burkoló kalapács
RO Ciocan aliniere pavaj
FR Marteau de pavage
IT Martello per pavimentazione
ES Martillo de pavimentación
CN 安装锤



YATO	m [g]	L [mm]	Ø [mm]	H [mm]	
YT-45480	522	300	30	85	6/24
YT-45481	630	330	40	105	6/24
YT-45482	830	385	50	115	4/16
YT-45483	1390	430	60	145	4/16
YT-45484	2870	550	80	180	2/4

EN Paving hammer replacement handle
PL Trzonek do młotka brukarskiego
DE Pflasterhammer-Stiel
RU Ручка молотка для укладки брусчатки
CZ Náhradní rukojeť dlažební kladiva
HU Burkoló kalapács nyél
RO Măner pt. ciocan aliniere pavaj
FR Manche de rechange pour marteau de pavage
IT Manico per martello per pavimentazione
ES Mango para martillo de pavimentación
CN 木柄



YATO	L [mm]	For / Dla	
YT-45485	255	YT-45480	100
YT-45486	280	YT-45481	100
YT-45487	320	YT-45482	100
YT-45488	360	YT-45483	50
YT-45489	450	YT-45484	25

EN Paving hammer tip
PL Końcówka do młotka brukarskiego
DE Aufsatz für Pflasterhammer
RU Насадка на рихтовочный молоток твердая
CZ Obuch pro dlažební kladivo
HU Burkoló kalapács fej
RO Cap de schimb pt. ciocan de pavaj
FR Tête pour marteau de pavage
IT Testa per martello da pavimentazione
ES Cabezera para martillo de pavimentación
CN 备用锤头



YATO	Ø [mm]	For / Dla	
YT-45490	30	YT-45480	100
YT-45491	40	YT-45481	50
YT-45492	50	YT-45482	50
YT-45493	60	YT-45483	50
YT-45494	80	YT-45484	20

EN Auto body fender set
PL Zestaw młotków blacharskich
DE Karosserie-Ausbeulsatz
RU Молотки рихтовочные
CZ Sada klempířských kladiv
HU Bádógos kalapács készlet
RO Set de ciocane pt. tablă
FR Jeu de marteau à panne ronde
IT Kit martelli per carrozriere
ES Juego de mazos de hojalatero
CN 钣金工具组套



YATO	m [g]	
YT-4590	4900	4

EN Ball pein hammer
PL Młotek blacharski
DE Ausbeulhammer
RU Молоток рихтовочный

CZ Kladivo klempířské
HU Bádógos kalapács
RO Ciocan pt. tablă
FR Marteau à panne ronde

IT Martello per carrozriere
ES Martillo de hojalatero
CN 圆头锤



YATO	m [g]	L [mm]	A [mm]	H [mm]	
YT-4515	225	280	26	80	6/36
YT-4516	450	315	34	100	6/24
YT-4518	900	380	40	125	6/12

EN Ball pein hammer
PL Młotek blacharski
DE Ausbeulhammer
RU Молоток рихтовочный

CZ Kladivo klempířské
HU Bádógos kalapács
RO Ciocan pt. tablă
FR Marteau à panne ronde

IT Martello per carrozriere
ES Martillo de hojalatero
CN 圆头锤



YATO	m [g]	L [mm]	A [mm]	H [mm]	
YT-4519	225	295	26	80	6/36
YT-4520	450	335	35	100	6/24
YT-4521	680	360	36	115	6/12
YT-4522	900	380	40	125	6/12

EN Geological hammer
PL Młotek geologiczny
DE Geologenhammer
RU Геологический молоток
CZ Geologické kladivo
HU Geológuskalapács
RO Ciocan geologic
FR Marteau de géologue
IT Martello da geologo
ES Martillo de geólogo
CN 地质锤

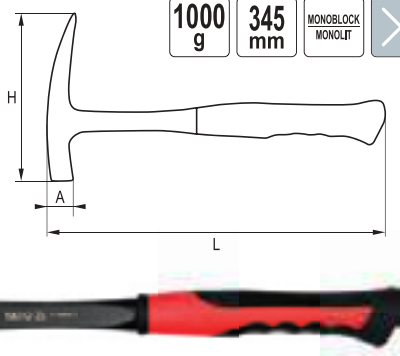

YATO	m [g]	L [mm]	A [mm]	H [mm]	
YT-45650	1000	345	20x20	180	6/18

EN Geological hammer
PL Młotek geologiczny
DE Geologenhammer
RU Геологический молоток
CZ Geologické kladivo
HU Geológuskalapács
RO Ciocan geologic
FR Marteau de géologue
IT Martello da geologo
ES Martillo de geólogo
CN 地质锤

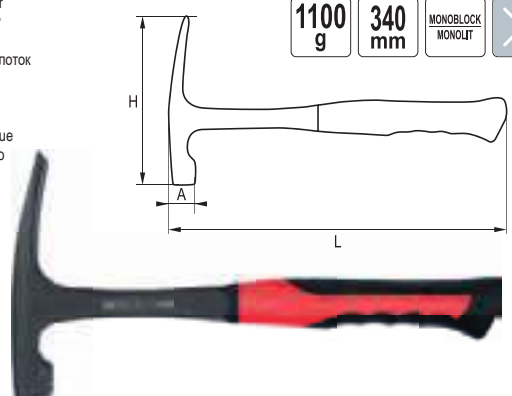

YATO	m [g]	L [mm]	A [mm]	H [mm]	
YT-45655	1010	340	23x23	190	6/18



EN Wood chisel
 PL Dłuto stolarskie
 DE Stechbeitel
 RU Стамеска по дереву



CZ Dláto tesařské
 HU Asztalos véső
 RO Daltă de tâmplărie
 FR Ciseaux à bois

IT Scalpello per falegname
 ES Cíncel para madera
 CN 木工凿

HRC 58-60
 CrV 60



YATO 	Size / Rozmiar [mm]	
YT-6241	8	10/60
YT-6242	10	10/60
YT-6243	12	10/60
YT-6244	14	10/60
YT-6245	15	10/60
YT-6246	16	10/60
YT-6247	18	10/60

YATO 	Size / Rozmiar [mm]	
YT-6248	20	10/60
YT-6249	22	10/60
YT-6251	25	10/60
YT-6253	28	10/60
YT-6256	35	10/60
YT-6258	38	10/60



EN Half-round wood chisel
 PL Dłuto półokrągłe do drewna
 DE Meißel für Holz halbrund
 RU Полукруглое зубило по дереву



CZ Půlkulaté dláto do dřeva
 HU Félkör alakú fávésző
 RO Dalta semicirculară
 FR Ciseau à bois semi-circulaire

IT Scalpello semicircolare per legno
 ES Cíncel semicircular para madera
 CN 半圆木凿

 #55



YATO 	Size / Rozmiar [mm]	
YT-62821	10	12/48
YT-62822	12	12/48
YT-62823	14	12/48
YT-62824	16	12/48

YATO 	Size / Rozmiar [mm]	
YT-62825	19	12/48
YT-62826	25	12/48
YT-62827	32	12/48
YT-62828	38	12/48

EN Wood chisel set
 PL Zestaw dłut stolarskich
 DE Stechbeitelsatz
 RU Набор стамесок по дереву

CZ Sada tesařských dlát
 HU Asztalos véső készlet
 RO Set daltji de tâmplărie
 FR Jeu de ciseaux à bois

IT Set scalpelli da falegname
 ES Juego de cinceles para madera
 CN 木凿组套

4 PCS
 10 mm
 16 mm
 20 mm
 25 mm
 HRC 58-60
 CrV 60





EN Wood chisel set
 PL Zestaw dłut stolarskich
 DE Stechbeitelsatz
 RU Набор стамесок по дереву
 CZ Sada tesařských dlát
 HU Asztalos véső készlet

RO Set daltji de tâmplărie
 FR Jeu de ciseaux à bois
 IT Set scalpelli da falegname
 ES Juego de cinceles para madera
 CN 木凿组套

3 PCS
 16 mm
 25 mm
 32 mm
 CrV





YATO 	Size / Rozmiar [mm]	
YT-6280	16, 25, 32	10/30

EN Wood chisel set
 PL Zestaw dłut stolarskich
 DE Stechbeitelsatz
 RU Набор стамесок по дереву
 CZ Sada tesařských dlát
 HU Asztalos véső készlet

RO Set daltji de tâmplărie
 FR Jeu de ciseaux à bois
 IT Set scalpelli da falegname
 ES Juego de cinceles para madera
 CN 木凿组套

4 PCS
 10, 12, 16, 20 mm
 CrV



YATO 	Size / Rozmiar [mm]	
YT-6281	10, 12, 16, 20	6/24

- EN Woodturning tool set
 PL Zestaw noży tokarskich do drewna
 DE Drechselmesser-Set
 RU Набор токарных резцов по дереву
 CZ Sada soustružnických dlát na dřevo
 HU Faeszterga késkészlet
 RO Set dalti pt. prelucrarea lemnului
 FR Jeu de ciseaux pour tournage à bois
 IT Set di coltelli per tornitura del legno
 ES Juego de cuchillas para torno madera
 CN 车木刀



- 8, 19, 25 mm (L=435 mm);
- 16 mm (L=435 mm);
- 16 mm (L=435 mm);
- 16 mm (L=435 mm);
- 15, 25 mm (L=435 mm)

YATO		
YT-62780		5

- EN Cold chisel with protection
 PL Przecinak z osłoną
 DE Schlitzmeißel mit Handschutz
 RU Зубило с протектором
 CZ Plochý sekáč (z krytem)
 HU Hidegvágó, lapos (védőfejjel)
 RO Dalta zidărie cu aparatoare
 FR Burin
 IT Scalpello con protezione
 ES Cincel plano (con protector)
 CN 石工凿

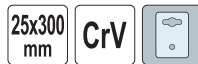

YATO	L [mm]	
YT-4700	300	4/24

- EN Cold chisel
 PL Przecinak płaski
 DE Flachmeißel
 RU Зубило плоское
 CZ Sekáč plochý
 HU Laposvágó

- RO Dalta lata
 FR Burin plat
 IT Scalpello piatto
 ES Tajadera en frío
 CN 扁铲



YATO	L [mm]	Chisel width / Szerokość przecinaka [mm]	
YT-47147	142	10.0	20/120
YT-47148	152	12.5	20/120
YT-47149	172	16.0	20/120

- EN Corner chisel
 PL Dłuto kątowe
 DE Eckmeißel
 RU Угловая стамеска
 CZ Rohové dláto
 HU Sarokvéső
 RO Dalta pt. colturi
 FR Ciseau d'angle
 IT Scalpello angolare
 ES Cincel de esquina
 CN 铤链定位器



YATO	Size / Rozmiar [mm]	
YT-62840	9x9	10/100

- EN Chisel and punch set
 PL Zestaw przecinaków i punktaków
 DE Trennmeißel- und Durchtreiber-Satz
 RU Зубила и пробойники с протектором
 CZ Sekáče a průbojníky
 HU Véső és lyukasztó készlet
 RO Set dalti de impact
 FR Kit de burins et perçoirs
 IT Scalpelli e bulino
 ES Juego de cinceles de acero templado y punzones
 CN 冲凿组套



- 12, 16, 19 mm;
- Ø 3, 4 mm;
- Ø 3 mm

YATO	L [mm]	
YT-4710	180	4/16

- EN Cold chisel
 PL Przecinak płaski
 DE Flachmeißel
 RU Зубило плоское
 CZ Sekáč plochý
 HU Laposvágó

- RO Dalta lata
 FR Burin plat
 IT Scalpello piatto
 ES Tajadera en frío
 CN 扁铲



YATO	L [mm]	Chisel width / Szerokość przecinaka [mm]	
YT-47020	200	20	10/40
YT-47021	250	22	10/40
YT-47022	300	25	10/40

EN Taper punch
 PL Wybijak równoległy
 DE Durchtreiber
 RU Пробойник конусный

CZ Průbojník
 HU Lyukasztó
 RO Dorn conic
 FR Percuteur

IT Scalpello a punta
 ES Retacador de cono
 CN 锥形冲子



150 mm

CrV 6150



YATO	L [mm]	Pin diameter / Średnica grotu [mm]	
YT-47141	150	1.5	20/120
YT-47142	150	3.0	20/120
YT-47143	150	4.0	20/120
YT-47144	150	5.0	20/120
YT-47145	150	6.0	20/120
YT-47146	150	8.0	20/120

EN Center punch
 PL Punktak
 DE Körner
 RU Керн
 CZ Důlčák
 HU Pontozó

RO Punctator
 FR Pointeau
 IT Punzoni
 ES Punzón centrador
 CN 冲子



CrV 6150



YATO	L [mm]	Center punch / Średnica punktaka [mm]	
YT-47150	100	6	20/120
YT-47151	112	8	20/120

EN Nail punch set
 PL Zestaw wybijańców do gwoździ
 DE Nagelstanzer-Set
 RU Дбойники для гвоздей
 CZ Sada děrovačů hřebíků
 HU Szögbeverő készlet
 RO Set dornuri ascutite
 FR Ensemble de chasse-clous
 IT Set di punzoni per chiodi
 ES Juego de retacadores para puntillas
 CN 钉子冲



3 PCS

125 mm

CrV 6150



Ø 0.8, 1.6, 2.4 mm

YATO		
YT-47155		10/60

EN Brass pin punch set
 PL Zestaw wybijańców równoległych mosiężnych
 DE Splintentreiber Satz aus Messing
 RU Набор выколоток латунных
 CZ Sada děrovačů rovnoběžných mosazných
 HU Párhuzamos tűskéjú réz csapszegkiütő készlet
 RO Set poanson din alama
 FR Ensemble de poinçons parallèles en laiton
 IT Set di punzoni a spillo tondi
 ES Juego de punzones de latón
 CN 冲苗



8 PCS

BRASS MOSIADZ



Ø 1.5, 2.3, 3.2, 3.9, 4.7, 5.5, 6.3, 7.8 mm (L=90 mm)

YATO	L [mm]	
YT-47124	90	50

EN Taper punch
 PL Dobijak stożkowy
 DE Durchtreiber
 RU Пробойник конусный
 CZ Průbojník
 HU Szögbeverő

RO Dorn conic
 FR Chasse-clous conique
 IT Scalpello a punta
 ES Retacador de cono
 CN 冲子

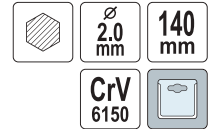

2.0 mm

140 mm

CrV 6150



YATO	L [mm]	Taper punch / Średnica wybijańki stożkowej [mm]	
YT-47152	140	2	20/120

EN Center punch set
 PL Zestaw punktaków
 DE Zentrierkörner Satz
 RU Набор кернов
 CZ Sada důlčáků
 HU Pontozó készlet
 RO Set punctatoare
 FR Ensemble de poinçons
 IT Set di punzoni
 ES Juego de punzones centradores
 CN 冲苗



7 PCS

CrV 6150

HARDENED STEEL STAL HARTOWANA



Ø 1.5 x 100 mm,
 Ø 2 x 100 mm,
 Ø 2.5 x 100 mm,
 Ø 3 x 106 mm,
 Ø 4 x 110 mm,
 Ø 5 x 125 mm,
 Ø 6 x 140 mm

YATO		
YT-47170		60

EN Pin punch set
 PL Zestaw wybijańców
 DE Splintentreiber Satz
 RU Пробойник булавочный - набор
 CZ Sada vyražeců
 HU Csapszegkiütő készlet
 RO Set de dornuri
 FR Set de perceuteurs
 IT Set di punzoni
 ES Juego de punzones
 CN 销式冲子组套



6 PCS



150 mm

CrV 6150



Ø 1.5, 3.0, 4.0, 5.0, 6.0, 8.0 mm

YATO	L [mm]	
YT-47121	150	6/24

EN Roll pin punch set
 PL Zestaw wybijańców równoległych kulistych
 DE Splintentreiber Satz
 RU Набор выколоток
 CZ Sada děrovačů rovnoběžných kulatých
 HU Párhuzamos tűskéjú, kerek csapszegkiütő készlet
 RO Set dornuri
 FR Ensemble de poinçons parallèles à billes
 IT Set di punzoni a spillo tondi
 ES Juego de punzones redondos
 CN 冲苗

9 PCS



STEEL STAL



Ø 1.7 x 70 mm, 2.0 x 82 mm, 2.5 x 92 mm, 3.2 x 100 mm,
 3.9 x 115 mm, 5.0 x 120 mm, 5.8 x 128 mm, 6.6 x 140 mm, 8.0 x 160 mm

YATO		
YT-47123		6/36

- EN Pin punch set
- PL Zestaw wybijaków
- DE Splintentreiber Satz
- RU Пробойник булавочный - набор
- CZ Sada vyražeců
- HU Csapszegkiütő készlet
- RO Set de dornuri
- FR Set de perceuteurs
- IT Set di punzoni
- ES Juego de punzones
- CN 销式冲子组套



21
PCS

BRASS
MOSIĄDZ

STEEL
STAL



Ø 1.6, 2.4 x 78 mm; 40 CrV;
Ø 1.6, 2.0, 3.2, 4.0 x 69 mm; 40 CrV (with hole / z otworem);
Ø 3.2, 3.6, 4.0 x 82 mm; 40 CrV;
Ø 4.8, 5.6, 6.4, 7.2, 8.0 x 82 mm; brass / mosiądz; Ø 6.0, 9.6 x 91 mm; PP;
Ø 1.6, 2.4 x 78 mm; 40 CrV;
20 mm, 250 g (L=190 mm)

YATO
YT-47122 20

- EN Chisel set
- PL Zestaw przecinaków
- DE Flachmeisselsatz
- RU Зубила в наборе
- CZ Sekáče
- HU Hídegvágó
- RO Set dalti zidařie
- FR Set de burins
- IT Set scalpelli
- ES Cinceles
- CN 冲凿组套

3
PCS CrV



10x142 mm, 12x152 mm, 16x172 mm

YATO
YT-4711 6/24

- EN Mini cold chisel and punch set
- PL Zestaw wybijaków i przecinak
- DE Trennmeissel- und Durchtreiber-Satz
- RU Зубила и керны в наборе
- CZ Sekáče a průbojníky
- HU Véső és lyukasztó készlet
- RO Set dalti de impact
- FR Set de burins et perceuteurs mini
- IT Set scalpelli e bulini
- ES Juego de cinceles de acero templado y punzones
- CN 迷你冲凿组套

3
PCS 125
mm CrV



10 mm;
Ø 3 mm;
Ø 3 mm

YATO
YT-4713 10/60

- EN Pin punch
- PL Wybijał
- DE Splintentreiber
- RU Пробойник булавочный
- CZ Vyražec
- HU Csapszegkiütő
- RO Dorn cilindric
- FR Percuteur
- IT Punzoni
- ES Punzón expulsador
- CN 销式冲子

3.8
mm 150
mm CrV
60



YATO L [mm] 20/120
YT-4690 150

- EN Chisel and punch set
- PL Zestaw przecinaków i punktaków
- DE Trennmeissel- und Durchtreiber-Satz
- RU Зубила, керны и пробойники в наборе
- CZ Sekáče a průbojníky
- HU Véső és lyukasztó készlet
- RO Set dalti de impact
- FR Set de burins et pointeaux
- IT Set scalpelli
- ES Juego de cinceles de acero templado y punzones
- CN 冲凿组套

6
PCS

CrV



10x142, 12x152 mm;
Ø 3x152, 6x152 mm;
Ø 2x140 mm;
Ø 8x115 mm

YATO
YT-4712 6/24

- EN Chisel and punch set
- PL Zestaw przecinaków i punktaków
- DE Trennmeissel- und Durchtreiber-Satz
- RU Зубила, керны и пробойники в наборе
- CZ Sekáče a průbojníky
- HU Véső és lyukasztó készlet
- RO Set dalti de impact
- FR Set de burins et pointeaux
- IT Set scalpelli
- ES Juego de cinceles de acero templado y punzones
- CN 冲凿组套

12
PCS

CrV



10x140, 12x150, 16x170 mm;
Ø 1.5x150, Ø 3x150, Ø 4x150, Ø 5x150, Ø 6x150, Ø 8x150 mm;
Ø 2x140 mm;
Ø 6x100, Ø 8x110 mm

YATO
YT-4714 10/20

- EN Taper punch
- PL Dobijał stożkowy
- DE Durchtreiber
- RU Пробойник конусный
- CZ Průbojník
- HU Szögbeverő
- RO Dorn conic
- FR Chasse-clous conique
- IT Punzoni
- ES Retacador de cono
- CN 冲孔器

3.3
mm 120
mm CrV
60



YATO L [mm] 20/120
YT-4691 120

EN Center punch RO Punctator
 PL Punktak FR Pointeau
 DE Körner IT Punzoni
 RU Керн ES Punzón centrador
 CZ Důlčák CN 冲子
 HU Pontozó

3.8 mm 120 mm CrV 60



Ø 3.8 mm

YATO	L [mm]	
YT-4692	120	20/120

EN Cold chisel RO Dalta lata
 PL Przecinak płaski FR Burin plat
 DE Flach Meissel IT Scalpello piatto
 RU Зубило плоское ES Tajadera en frío
 CZ Sekáč plochý CN 扁铲
 HU Laposvágó

12 mm 130 mm CrV 60



12 mm

YATO	L [mm]	
YT-4693	130	20/120

EN Cape chisel RO Dalta ascutita
 PL Przecinak krzyżowy FR Burin
 DE Kreuzmeissel IT Scalpello rettangolare
 RU Зубило „пика” ES Tajadera rectangular
 CZ Sekáč křížový CN 钎头
 HU Keresztvágó

5.5 mm 130 mm CrV 60



5.5 mm

YATO	L [mm]	
YT-4694	130	20/120

EN Hexagonal wrecking bar RO Rangă
 PL Łom sześciokątny FR Pied-de-biche manche hexagonal
 DE Brechstange IT Mazza di ferro
 RU Лом-гвоздодёр шестигранный ES Palanca hexagonal
 CZ Šestiúhelný páčidlo CN 撬棒
 HU Hatszögű feszítővas

DROP FORGED KUTE



YATO	L [mm]	W [mm]	
YT-46800	400	18	6/12
YT-46801	450	18	6/12
YT-46802	600	18	6/12
YT-46803	750	18	6/12
YT-46804	900	18	5/10

EN Profiled wrecking bar RO Rangă
 PL Łom profilowany FR Pied-de-biche profilé
 DE Nageleisen IT Mazza di ferro
 RU Лом-гвоздодёр ES Palanca perfilada
 CZ Páčidlo CN 撬棒
 HU Szögkihúzó

DROP FORGED KUTE



YATO	L [mm]	W [mm]	+/- [mm]	
YT-46810	350	22	13	1/12
YT-46811	450	30	17	6/12
YT-46812	600	30	17	4/8
YT-46813	750	30	17	8
YT-46814	900	30	17	3/6

EN Chisel and punch set
 PL Zestaw przecinaków i punktaków
 DE Trennmeissel- und Durchtreiber-Satz
 RU Зубила и пробойники с протектором
 CZ Sekáče a průbojníky
 HU Véső és lyukasztó készlet
 RO Set dalte de impact
 FR Kit de burins et perceurs
 IT Scalpelli e bulino
 ES Juego de cinceles de acero templado y punzones
 CN 样冲组套

5 PCS CrV 60



12x130 mm;
 5.5x130 mm;
 Ø 3.8x150 mm;
 Ø 3.3x120 mm;
 3.8x120 mm

YATO		
YT-4695		6/24

EN Hexagonal wrecking bar RO Rangă
 PL Łom sześciokątny FR Pied-de-biche manche hexagonal
 DE Brechstange IT Mazza di ferro
 RU Лом-гвоздодёр шестигранный ES Palanca hexagonal
 CZ Šestiúhelný páčidlo CN 六角撬棒
 HU Hatszögű feszítővas

DROP FORGED KUTE



YATO	L [mm]	W [mm]	
YT-46831	400	16	6/24
YT-46832	600	20	12
YT-46833	800	22	1/12
YT-46834	1000	22	6
YT-46835	1200	25	6
YT-46836	1500	25	6

EN Flat wrecking bar RO Rangă plată
 PL Łom płaski FR Pied-de-biche plat
 DE Nageleisen spitze IT Mazza di ferro
 RU Лом плоский ES Palanca plana
 CZ Páčidlo ploché CN 撬棒
 HU Lapos feszítővas

DROP FORGED KUTE



YATO	L [mm]	W [mm]	+/- [mm]	
YT-46820	300	35	6	10/30
YT-46821	380	35	6	10/20
YT-46822	450	35	6	10/20
YT-46823	600	35	6	10/20

EN Precision claw bar
 PL Lom wąski
 DE Brecheisen
 RU Лом
 CZ Páčidlo
 HU Emelőőrúd
 RO Levier cu cioc
 FR Pied de biche
 IT Piede di porco
 ES Palanca estrecha
 CN 撬棒



YATO	L [mm]	W [mm]	→ [mm]	
YT-46750	300	16	13	6/24

EN Pry bar set
 PL Zestaw łomów
 DE Brechstangensatz
 RU Набор ломов
 CZ Sada páčidel
 HU Feszítővas készlet

RO Set leviere
 FR Jeu de barres à clous
 IT Set di piedi di porco
 ES Juego de palancas
 CN 撬棒



YATO	
YT-47303	6

EN Removal tool set
 PL Zestaw łomów
 DE Brechstangensatz
 RU Набор ломов
 CZ Sada páčidel
 HU Feszítővas készlet
 RO Set leviere
 FR Jeu de barres à clous
 IT Set di piedi di porco
 ES Juego de palancas
 CN 撬棒组套

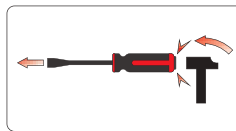

205x10x11 mm, 140 g; 310x15x16 mm, 295 g; 400x15x21 mm, 400 g

YATO	
YT-47301	4/16

EN Axe
 PL Siekiera
 DE Axt
 RU Топор

CZ Sekera
 HU Fejsze
 RO Topor
 FR Hache



YATO	m [g]	L [mm]	DIN	
YT-8001	600	360	5131	24
YT-8002	800	380	5131	20
YT-8003	1000	400	5131	12
YT-8004	1250	710	7294	12
YT-8005	1400	710	7294	12
YT-8006	1600	810	7294	12

EN Pry bar set
 PL Zestaw łomów
 DE Brechstangensatz
 RU Набор ломов
 CZ Sada páčidel
 HU Feszítővas készlet

RO Set leviere
 FR Jeu de barres à clous
 IT Set di piedi di porco
 ES Juego de palancas
 CN 撬棒



YATO	
YT-47304	6/12

EN Go-through pry bar set
 PL Zestaw łomów
 DE Nagel eisensatz
 RU Набор ломов
 CZ Sada mini páčidel
 HU Szóghúzó készlet

RO Set leviere
 FR Set de pieds-de-biche
 IT Set mazza di ferro
 ES Juego de palancas de hierro
 CN 穿心撬棒组套

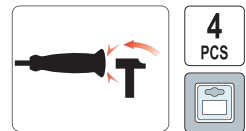

198x6x6 mm, 110 g; 304x10x10 mm, 292 g; 456x10x10 mm, 479 g; 608x12x12 mm, 745 g

YATO	
YT-4730	3/6

EN Splitting axe
 PL Siekiera rozłupująca
 DE Spaltaxt
 RU Топор-колуш

CZ Štípačí sekera
 HU Hasítőfejsze
 RO Topor pi. despicat lemne
 FR Hache à fendre

IT Ascia spaccalegna
 ES Hacha de corte
 CN 把斧



YATO	m [g]	L [mm]	
YT-8011	1000	430	6
YT-8012	2000	820	6

EN Axe
PL Siekiera
DE Axt
RU Топор
CZ Sekera
HU Fejsze

RO Topor
FR Hache
IT Ascìa
ES Hacha
CN 把斧

500 g
230 mm
DIN 7287
HRC 47-55
NYLON



YATO	m [g]	L [mm]	
YT-80070	500	230	6/24

EN Axe
PL Siekiera
DE Axt
RU Топор
CZ Sekera
HU Fejsze

RO Topor
FR Hache
IT Ascìa
ES Hacha
CN 把斧

DIN 7287
HRC 47-55
NYLON



YATO	m [g]	L [mm]	
YT-80071	700	360	6/24
YT-80072	900	450	6/12
YT-80073	1400	600	6

EN Splitting axe
PL Siekiera rozłupująca
DE Spaltaxt
RU Топор-колуш
CZ Štípačí sekera
HU Hasítófejsze

RO Topor pt. despalcat lemne
FR Hache à fendre
IT Ascìa spaccalegna
ES Hacha de corte
CN 把斧

DIN 7287
HRC 47-55
NYLON



YATO	m [g]	L [mm]	
YT-80080	900	450	6/12
YT-80081	1600	600	6
YT-80082	1800	720	6

EN Adze flat type
PL Ciosło płaskie
DE Flachdaxel
RU Тесло плоское

CZ Sekyrka
HU Szekeerce
RO Tesla
FR Hache d'artisans

IT Ascìa tipo piatto
ES Destral de artesanos
CN 扁斧



YATO	
YT-80130	4/24

EN Long breaking bar with hook
PL Dźwignia z hakiem do odwracania pni
DE Fällheber
RU Рычаг для рубки
CZ Obrabeč kmenè
HU A törzs csokolója

RO Cârlig pt. transport lemne
FR Tourne-bille métal
IT Leva giratronchi
ES Palanca de tala
CN 翻木器

830 mm
DROPPED FORGED KUTE



YATO	L [mm]	
YT-79901	830	2/8

EN Lifting tongs
PL Kleszcze do drewna
DE Handpackzange
RU Ручной клещевой захват для бревен
CZ Souběžné vynášecí kleště na dřevo
HU Emelőfogó
RO Cleste pt. ridicare lemn
FR Pince de levage combinée
IT Pinza spostatronchi
ES Madera gancho de elevación
CN 抓钩

450 mm
300 mm



YATO	L [mm]	
YT-79904	450	6/24

EN Lifting tongs
PL Kleszcze do drewna
DE Handpackzange
RU Ручной клещевой захват для бревен
CZ Souběžné vynášecí kleště na dřevo
HU Emelőfogó
RO Cleste pt. ridicare lemn
FR Pince de levage combinée
IT Pinza spostatronchi
ES Madera gancho de elevación
CN 抓钩

330 mm
180 mm



YATO	L [mm]	
YT-79905	330	20

EN Lifting tongs
PL Kleszcze do drewna
DE Handpackzange
RU Ручной клещевой захват для бревен
CZ Souběžné vynášecí kleště na dřevo
HU Emelőfogó
RO Cleste pt. ridicare lemn
FR Pince de levage combinée
IT Pinza spostatronchi
ES Madera gancho de elevación
CN 长柄伐木钩

770 mm
275 mm



YATO	L [mm]	
YT-79907	770	6/12

EN Lifting hook
PL Hak z uchwytem do drewna
DE Holz-Hebehaken
RU Захватный крюк для бревен
CZ Hák na dřevo
HU Emelőhorog

RO Carlig pt. ridicare lemn
FR Pince de levage
IT Alzatronchi manuale
ES Madera gancho de elevación
CN 抓钩

265 mm



YATO	L [mm]	
YT-79910	265	30

EN Log lifting pick
PL Hak do wyciągania pni
DE Handsaprie
RU Большой зацеп для бревен
CZ Sapie dřevorubecká - hák na klády
HU Fa mozgató csákány

RO Tapina usoara din aluminiu
FR Sappie à main en aluminium avec lame
IT Piccone spostatronchi
ES Zapa de aluminio
CN 铝柄抓钩

AI
ANTI-SLIP HANDLE UCHWYT ANTY-POŚLIZGOWY



YATO	L [mm]	
YT-79915	580	12
YT-79916	720	12

EN Sawhorse
PL Kozioł do pilowania drewna
DE Sägebock für Kettensägen
RU Стенд для распиловки бревен
CZ Stojan na řezání dřeva
HU Favágó állvány
RO Suport pt. tăiat bușteni
FR Chevalet pour couper le bois
IT Cavalletto per taglio legna
ES Caballete para cortar madera
CN 锯齿锯架



920
x1020
mm

max
150kg

ZINC
PLATED
OCYNKO-
WANA



YATO

YT-79925



1

EN Plastic felling wedge
PL Klin do drewna z tworzywa
DE Kunststoffkeil für Holz
RU Клиn для дерева пластиковый
CZ Plastový klín na dřevo
HU Hasító ék műanyag fához

RO Pană de plastic pt. lemn
FR Cale plastique pour bois
IT Cuneo abbattimento in plastica
ES Cuña de plástico para madera
CN 楔子



YATO	Dimensions / Wymiary [mm]	m [g]	
YT-79883	136x65x25	95	50/100
YT-79882	205x72x30	220	20/40
YT-79881	245x85x30	315	20/40
YT-79880	300x85x35	430	20/40

EN Felling wedges set
PL Zestaw klinów
DE Keile-Satz
RU Набор клиньев
HU Ékkészlet

RO Set pene
FR Jeu de cales
IT Set di cunei
ES Juego de cuñas
CN 楔子

4
PCS



YATO

L [mm]

YT-79884

136, 205, 245, 300



20

EN Wood splitter (knife)
PL Ręczna łuparka do drewna
DE Hand-Holzspalter
RU Механический дровокол
CZ Štěpačka na dřevo
HU Fahasító

RO Dispozitiv pt. crăpat lemn
FR Splitter outil pour fendre le petit bois
IT Spaccalegna manuale
ES Astilladora cortadora de lena manual
CN 劈柴器



355x40
mm

680x8 mm



YATO

YT-79940



4

EN Foot-operated log splitter
PL Nożna łuparka do drewna
DE Fuß-Holzspalter
RU Механический дровокол
CZ Štěpačka na dřevo
HU Fahasító

RO Dispozitiv pt. spart lemne, acționare picior
FR Splitter outil pour fendre e petit bois
IT Spaccalegna con azionamento a pedale
ES Astilladora cortadora de lena
CN 脚踏劈柴机



max
430x180
mm

1.2t



YATO

YT-79943



2

9

Clamps, vices & holders
ciski, imadła i wsporniki

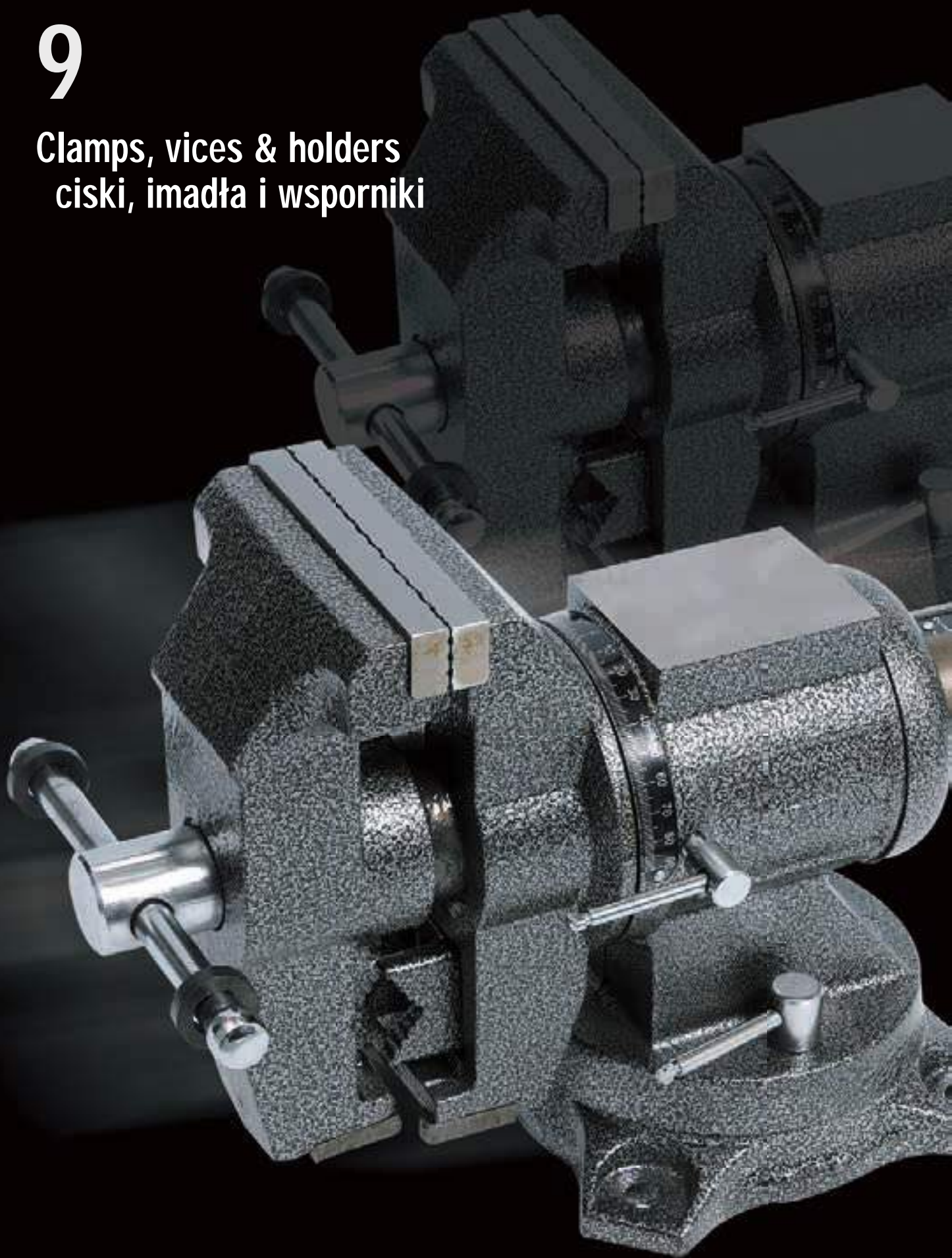

Clamps
Ściski



158-159

Vices
Imadła



160-161

- EN F-clamp
 PL Ścisk stolarski
 DE Schraubzwinge
 RU Струбцина столярная
- CZ Truhlářská svěrka
 HU Asztalos szorító
 RO Menghină pt. tâmplărie
 FR Serre-joint à vis pour menuisier

- IT Morsetto da falegname
 ES Sargento de carpintería
 CN 夹具



YATO	[mm]	
YT-6401	160x80	10/30
YT-6402	200x80	10/30
YT-6403	250x80	10/30
YT-6404	300x80	10/30
YT-6405	450x80	10/20
YT-6406	600x80	10/20
YT-6407	400x120	10
YT-6408	500x120	10
YT-6409	600x120	10
YT-6410	900x120	5

YATO	[mm]	
YT-64111	250x80	4/24
YT-64112	300x80	4/24
YT-64113	450x80	4/24
YT-6412	300x120	10
YT-6413	400x120	10
YT-6414	500x120	5
YT-6415	600x120	5
YT-6416	900x120	5
YT-6417	1050x120	5

YATO	[mm]	
YT-6440	100x50	12/60
YT-6441	150x50	12/48
YT-6442	200x50	12/48
YT-6443	250x50	12/48
YT-6444	300x50	12/48
YT-6445	200x80	10/20
YT-6446	250x80	10/20
YT-6447	300x80	10/20
YT-6448	500x80	10/20
YT-6449	300x120	10
YT-6450	500x120	10
YT-6451	800x120	6
YT-6452	1000x120	6
YT-6453	1200x120	6
YT-6454	1500x120	6

- EN Bar clamp ratchet
 PL Ścisk stolarski zapadkowy
 DE Lenkerklemmung Ratsche
 RU Струбцина быстрофиксируемая
 CZ Svěrka s ráčnou
 HU Bőr bilincs racsnis
 RO Presă tip „F” cu clichet
 FR Bar pince à cliquet
 IT Bar morsetto a cricchetto
 ES Barra de mordaza de trinquete
 CN 夹具



YATO	[mm]	
YT-63951	200x100	2/12
YT-63952	250x100	2/12
YT-63953	300x100	2/12
YT-63954	400x100	2/6

YATO	[mm]	
YT-63955	500x120	2/4
YT-63956	600x120	2/4
YT-63957	800x120	2/4
YT-63958	1000x120	2

- EN Spring clamp
 PL Ścisk sprężynowy
 DE Federklemme
 RU Струбцина пружинная
 CZ Pružinová svěrka
 HU Rugós szorító
- RO Clește presă
 FR Pince à ressort
 IT Morsetto a molla
 ES Pinza de resorte
 CN 弹簧夹

- EN Spring clamp
 PL Ścisk sprężynowy
 DE Federklemme
 RU Струбцина пружинная
 CZ Pružinová svěrka
 HU Rugós szorító
- RO Clește presă
 FR Pince à ressort
 IT Morsetto a molla
 ES Pinza de resorte
 CN 弹簧夹



YATO	L [mm]	Max. jaws range / Maks. rozwarcie szczęk [mm]	Max. jaws depth / Maks. głębokość szczęk [mm]	
YT-64270	100	42	44	24/240
YT-64271	150	55	68	12/120
YT-64272	200	79	91	10/100

YATO	L [mm]	Max. jaws range / Maks. rozwarcie szczęk [mm]	Max. jaws depth / Maks. głębokość szczęk [mm]	
YT-64275	55	20	20	500/1000
YT-64276	100	25	25	48/96
YT-64277	150	50	50	24/48
YT-64278	230	90	90	8/16

- EN Corner clamp set
 PL Zestaw ścisków kątowych sprężynowych
 DE Federbelastete Eckklemmen
 RU Набор струбцин угловых
 CZ Pružinové úhlové svorky
 HU Rugós sarokszorító
 RO Set de cleme de colț
 FR Pincés d'angle à ressort
 IT Set di morsetti angolari a molla
 ES Abrazaderas de ángulo con muelle
 CN 木工夹



YATO	
YT-64300	6/24

- EN Adjustable corner clamp
 PL Ścisk kątowy regulowany
 DE Einstellbare Winkelklemme
 RU Регулируемый угловой зажим
 CZ Nastavitelná rohová svorka
 HU Állítható sarokszorító
 RO Clemă unghi reglabil
 FR Pince à angle réglable
 IT Morsetto angolare regolabile
 ES Abrazadera de ángulo ajustable
 CN 角度固定夹



YATO	
YT-64307	20/40

EN Guide rail clamp
PL Ścisłko do szyn i prowadnic
DE Klemmzwinde für Führungsschiene
RU Зажим для рельсов и направляющих
CZ Svěrka pro vodící lišty
HU Vezetősín szorító
RO Clemă pt. șină de ghidare
FR Pince pour rails de guidage
IT Morsetto per binario guida
ES Sargento para railes y guías
CN 轨道夹



70x300
mm

11,5
mm

QUICK
ADJUSTMENT
SZYBKA
REGULACJA



YATO	Size / Rozmiar [mm]	
YT-64320	300x70	6/36

EN C-clamp
PL Ścisłko typu „C”
DE C-Schraubzwinde
RU Струбцина C-образная
CZ Svěrka šroubová tvar “C”
HU “C” típusú szorító
RO Clemă tip “C”
FR Serre-joint en “C”
IT Morsetto tipo “C”
ES Prensa tipo “C”
CN C型夹



YATO	Jaws range / Rozstaw szczęk [mm]	Force pressure / Siła nacisku [kg]	
YT-64250	25	120	20/100
YT-64251	50	200	10/50
YT-64252	75	280	10/30
YT-64253	100	350	5/30
YT-64254	127	390	18
YT-64255	150	450	12
YT-64256	200	500	12
YT-64257	250	540	5
YT-64258	300	600	5

EN Quick release C-clamp
PL Ścisłko typu „C” z szybkim przesuwem śruby
DE C-Schraubzwinde mit schnellem Vorschub
RU Струбцина C-образная с быстрым винтом
CZ Svěrka “C” s rychlým posunem šroubu
HU “C” típusú szorító gyors csavareltolással
RO Clemă tip “C” cu eliberare rapidă
FR Serre-joint en “C” à vis d'action rapide
IT Morsetto a rilascio rapido di tipo “C”
ES Prensa tipo “C” con desplazamiento rápido de tornillo
CN 快速C型夹

150x85
mm

6
kN

QUICK
ADJUSTMENT
SZYBKA
REGULACJA



YATO	[mm]	Force pressure / Siła nacisku [kN]	
YT-64263	150x85	6	4/16

EN 3-way C-clamp
PL Ścisłko śrubowy potrójny
DE Dreiwegschraubzwinde
RU Струбцина тройная C-образная
CZ Šroubová svěrka trojitá
HU Tripla csavaros szorító
RO Clemă tip “C” cu 3 prinderi
FR Serre-joint en “C” triple
IT Morsetto a vite triplo
ES Prensa tipo “C” triple
CN 三头C型夹



62x62
mm

x3



YATO	[mm]	
YT-64242	62x62	10/60

EN C-clamp
PL Ścisłko typu „C”
DE C-Schraubzwinde
RU Струбцина C-образная
CZ Svěrka šroubová tvar “C”
HU “C” típusú szorító
RO Clemă tip “C”
FR Serre-joint en “C”
IT Morsetto tipo “C”
ES Prensa tipo “C”
CN C型夹



DROP
FORGED
KUTE



YATO	Jaws range / Rozstaw szczęk [mm]	Force pressure / Siła nacisku [kg]	
YT-6420	50	1500	6/30
YT-6421	75	1950	6/18
YT-6422	100	2980	6/12
YT-6423	150	3200	6/12
YT-6424	200	3600	6

EN Quick release C-clamp
PL Ścisłko typu „C” z szybkim przesuwem śruby
DE C-Schraubzwinde mit schnellem Vorschub
RU Струбцина C-образная с быстрым винтом
CZ Svěrka “C” s rychlým posunem šroubu
HU “C” típusú szorító gyors csavareltolással
RO Clemă tip “C” cu eliberare rapidă
FR Serre-joint en “C” à vis d'action rapide
IT Morsetto a rilascio rapido di tipo “C”
ES Prensa tipo “C” con desplazamiento rápido de tornillo
CN 快速C型夹

100x50
mm

5
kN

QUICK
ADJUSTMENT
SZYBKA
REGULACJA



YATO	[mm]	Force pressure / Siła nacisku [kN]	
YT-64262	100x50	5	6/24

EN C-clamp deep
PL Ścisłko typu „C” głęboki
DE C-Schraubzwinde tiefe
RU Струбцина C-образная глубокая
CZ Svěrka tvar “C” hluboká
HU “C” típusú mély szorító
RO Clemă tip “C” adâncă
FR Serre-joint en “C” à gorge profonde
IT Morsetto profondo di tipo “C”
ES Prensa tipo “C” profunda
CN C型夹



YATO	[mm]	Force pressure / Siła nacisku [kN]	
YT-64190	63x130	3	6/36
YT-64191	76x203	3	6/24
YT-64192	101x304	3	6/12

EN Nylon C-clamp
PL Ścisłko typu „C” nylonowy
DE C-Schraubzwinde aus Nylon
RU Струбцина C-образная нейлоновая
CZ Nylonová svěrka tvar “C”
HU “C” típusú nylon asztalos szorító
RO Clemă plastic tip “C”
FR Serre-joint en “C” en nylon
IT Morsetto di tipo “C” in nylon
ES Prensa tipo “C” de nylon
CN 快速夹

NYLON

QUICK
ADJUSTMENT
SZYBKA
REGULACJA



YATO	Jaws range / Rozstaw szczęk [mm]	
YT-64183	50	12/72
YT-64184	75	12/48

EN Bench vice with swivel base
 PL Imadło ślusarskie obrotowe
 DE Schlosserschraubstock drehbar
 RU Тиски слесарные поворотные
 CZ Zámečnický svěrák otočný
 HU Forgatható lakatos satu
 RO Menghină de lăcătușerie rotativă
 FR Etau d'établi pivotant
 IT Morsa da banco girevole
 ES Tornillo de banco giratorio
 CN 台钳





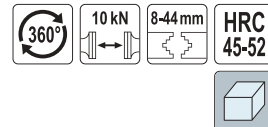

EN Bench vice with swivel base
 PL Imadło ślusarskie obrotowe
 DE Schlosserschraubstock drehbar
 RU Тиски слесарные поворотные
 CZ Zámečnický svěrák otočný
 HU Forgatható lakatos satu
 RO Menghină de lăcătușerie rotativă
 FR Etau d'établi pivotant
 IT Morsa da banco girevole
 ES Tornillo de banco giratorio
 CN 台钳



• Anvil and changeable jaws made of hardened steel
 • Kowadefko i wymienne szczęki z hartowanej stali

• Anvil and changeable jaws made of hardened steel
 • Kowadefko i wymienne szczęki z hartowanej stali

YATO 	Jaws width / Szerokość szczęk [mm]	m [kg]	
YT-6501	100	7	2
YT-6502	125	10	2
YT-6503	150	15	1
YT-65048	150	19	1
YT-6504	200	21	1
YT-65049	200	29.5	1

YATO 	Jaws width / Szerokość szczęk [mm]	Jaws range / Rozstaw szczęk [mm]	m [kg]	
YT-6505	100	100	10	1

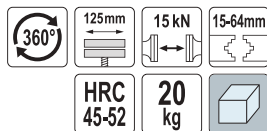

EN Bench vice with swivel base
 PL Imadło ślusarskie obrotowe
 DE Schlosserschraubstock drehbar
 RU Тиски слесарные поворотные
 CZ Zámečnický svěrák otočný
 HU Forgatható lakatos satu
 RO Menghină de lăcătușerie rotativă
 FR Etau d'établi pivotant
 IT Morsa da banco girevole
 ES Tornillo de banco giratorio
 CN 台钳





EN Hand vice
 PL Imadło ręczne
 DE Handschraubstock
 RU Ручные тиски
 CZ Ruční svěrák
 HU Kézi satu
 RO Menghină manuală
 FR Étau à main
 IT Morsa a mano
 ES Tornillo manual
 CN 手用台钳



• Anvil and changeable jaws made of hardened steel
 • Kowadefko i wymienne szczęki z hartowanej stali

YATO 	Jaws width / Szerokość szczęk [mm]	Jaws range / Rozstaw szczęk [mm]	m [kg]	
YT-6506	125	125	20	1

YATO 	Jaws range / Rozstaw szczęk [mm]	Jaws width / Szerokość szczęk [mm]	
YT-65080	25	25	8/48
YT-65081	27	40	6/36
YT-65082	32	50	4/24

EN Drill press vice
PL Imadło wiertarskie
DE Bohrmaschinen-Schraubstock
RU Тиски станочные неповоротные
CZ Vrtací strojní svěrák
HU Gépsatu

RO Menghină pt. găurit
FR Étau pour perceuse
IT Morsa per trapano
ES Tornillo de banco para taladro
CN 钻床虎钳

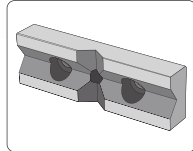

YATO	Jaws width / Szerokość szczęk [mm]	
YT-65071	50	10
YT-65072	100	6
YT-65073	150	2

EN Angle vice
PL Imadło kątowe
DE Winkelschraubstock
RU Угловые тиски
CZ Úhlový svěrák
HU Sarokszorító
RO Menghină pt. colțuri
FR Étau d'angle
IT Morsa angolare
ES Mordaza de ángulo
CN 木工角夹

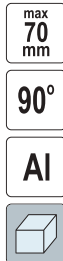

YATO	Jaws range / Rozstaw szczęk [mm]	
YT-65136	70	20

EN Hand vice
PL Imadło ręczne
DE Handschraubstock
RU Ручные тиски
CZ Ruční svěrák
HU Kézi satu
RO Menghina manuala
FR Étau à main
IT Morsa a mano
ES Tornillo manual
CN 手用台钳

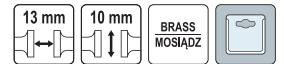

EN Soft vice jaws
PL Miękkie szczęki wymienne do imadła
DE Weiche austauschbare Schraubstock-Schutzbacken
RU Мягкие сменные губки для тисков
CZ Měkké čelisti do svěráku
HU Puha csere pófák satuhoz
RO Bacuri menghină
FR Mors de protection souples remplaçables pour étaux
IT Ganascce morbide intercambiabili per morsa
ES Mordazas blandas sustituibles para el tornillo de banco
CN 磁性钳口保护套



YATO	Dimensions / Wymiary [mm]	
YT-65000	75x30x10	20/60
YT-65001	100x30x10	20/60
YT-65002	125x30x10	20/60
YT-65003	150x30x10	20/60

EN Portable clamping system
PL Przenośne imadło nożne
DE Tragbares Spannsystem
RU Ножные тиски кобылка зажимные
CZ Přenosný nožní svěrák
HU Hordozható állványos satu
RO Suport portabil cu menghină
FR Étau portatif à pied
IT Morsa da lavoro portatile
ES Estación de soporte de material portátil
CN 虎钳

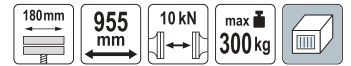

YATO	Jaws width / Szerokość szczęk [mm]	Jaws range / Rozstaw szczęk [mm]	m [kg]	
YT-64970	180	0-955	15	1

YATO	Jaws range / Rozstaw szczęk [mm]	Jaws width / Szerokość szczęk [mm]	
YT-65085	13	10	12/48

EN Exchangeable vice jaws set
PL Szczęki wymienne do imadła
DE Backen für Schraubstöcke
RU Сменные губки для тисков
CZ Výměnné čelisti do svěráku
HU Satu póf befogó pófák
RO Bacuri de protecție din aluminiu pt. menghină
FR Mâchoires remplaçables pour vices
IT Ganascce intercambiabili per morsa
ES Mordazas sustituibles para el tornillo de banco
CN 台钳保护夹

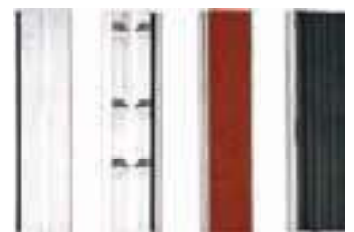







YATO	L [mm]	
YT-65006	100	20
YT-65007	125	20
YT-65008	150	20

10

Cutting tools
Narzędzia tnące



Drills Wiertła		Hand taps & sets Gwintowniki i zestawy	185
.....	165-177	Circular dies Narzynki	186
Twist drill bits HSS & sets Wiertła do metalu HSS i zestawy	165	Step drills Wiertła stopniowe	187
Double end metal twist drills Wiertła do metalu dwustronne	166	Taper drill sets Zestawy wiertel stożkowych	187
Twist drill bits HSS-E Co & sets Wiertła do metalu HSS-E Co i zestawy	166	Countersinks & sets Pogłębiacze i zestawy	187
Twist drill bits HSS-TiN & sets Wiertła do metalu HSS-TiN i zestawy	167	Tap wrenches & die holders Pokręta do gwintowników i narzynek	188
Universal drills & sets Wiertła uniwersalne i zestawy	170	Plug and forstner cutters & sets Flekowniki-sękowniki do drewna i zestawy	188
SDS masonry drill bits X-TIP Wiertła do betonu SDS, z grotem krzyżowym	171	Router bits, rotary rasps & sets Frezy do drewna, metalu i zestawy	189-195
SDS masonry drill bits Wiertła do betonu SDS	172	Diamond tools Narzędzia diamentowe	196-197
Masonry drill bits with cylindrical shank & sets Wiertła do betonu z uchwytem cylindrycznym i zestawy	173	Diamond blades for cutting construction materials Tarcze diamentowe do cięcia materiałów budowlanych	196
Flat wood drill bits & sets Wiertła łopatkowe do drewna i zestawy	173	Diamond grinding cup wheels Diamentowe talerze szlifierskie do betonu i kamienia	197
Spur wood drill bits Wiertła do drewna spiralne	174	Diamond core drill bits Diamentowe wiertła koronowe	197
Auger wood drill bits & sets Świdry do drewna i zestawy	175	Tungsten carbide tipped tools Narzędzia z ostrzem z węglika wolframu	198-199
Confirmat screw drill bits Wiertła do konfirmatów	176	Tungsten carbide saws for wood Tarcze z węglikiem do drewna	198
Drills for glass, ceramic tiles & sets Wiertła do szkła, ceramiki, gresu i zestawy	176	Tungsten carbide saws for steel & aluminium Tarcze z węglikiem do stali i aluminium	199
Drilling accessories Akcesoria do wiercenia	176	PVC cutting discs Tarcze do cięcia PCV	199
Adjustable hand reamers Rozwiertaki nastawne		Cutting & grinding discs Tarcze do cięcia i szlifowania	200-202
.....	177	Stainless steel cutting discs Tarcze do cięcia stali nierdzewnej	200
Tools for dowel joints Narzędzia do połączeń kołkowych		Metal cutting discs Tarcze do cięcia metalu	200
.....	177-178	Metal grinding discs Tarcze do szlifowania metalu	200
SDS Chisels Przecinaki i dłuta SDS		Stone cutting discs Tarcze do cięcia kamienia	201
.....	179-181	Stone grinding discs Tarcze do szlifowania kamienia	201
Hollow drill sets Wiertła koronowe do betonu		Plate discs with hook fastener Tarcze z rzepem	201
.....	182	Cutting & grinding rasp discs Tarcze tarkowe do cięcia i szlifowania	201
Hole saws Otwornice			
.....	182-184		
Universal hole saws Otwornice uniwersalne	182		
Bi-metal hole saws Otwornice bimetalowe	182		
Arbors for hole saws Uchwyty do otwornic	183		
Hole saw kits Zestawy otwornic	184		
Taps & dies Narzędzia do gwintowania			
.....	185-188		



Shears

Nożyce

203-208



Tin snips

Nożyce do blachy 203

Steel strap cutters

Nożyce do cięcia taśm stalowych 206

Bolt cutters

Nożyce do prętów 206

Hydraulic cutters & accessories

Nożyce z silownikiem hydraulicznym i akcesoria 207

Multifunctional scissors

Nożyce wielofunkcyjne 208

Saws & blades

Piły i brzeszczoty

208-218



Hand saws

Piły do drewna 208

Back saws for PVC

Piły do PCV 208

Drywall saws

Piły do płyt gipsowo-kartonowych 209

Bow saws

Piły kabłąkowe 209

Blades

Brzeszczoty 210

Hacksaw frames

Piły do metalu 210

Blades

Brzeszczoty 210

Jig saw blades

Brzeszczoty do wyrzynarek 212

Accessories for multi-purpose oscillating tools

Akcesoria do wielofunkcyjnych narzędzi oscylacyjnych 214

Brushes, knives & files

Szczotki, noże i pilniki

219-235



Wire brushes & sets

Szczotki druciane i zestawy 219

Cup brushes

Szczotki tarczowe 220

Electric screwdriver accessories

Akcesoria do wkrętarek 223

Knives & blades

Noże i ostrza 224

Squeegees

Rakle 227

Scissors

Nożyczki 227

Marking out tools

Narzędzia traserskie 227

Punch sets

Przebijaki do skóry 229

Scrapers

Skrobaki i cykliny 230

Planes

Strugi 231

Steel files & sets

Pilniki do metalu i zestawy 232

Needle file sets

Zestawy pilników iglaków 233

Diamond needle files & sets

Pilniki iglaki diamentowe i zestawy 234

Diamond whetstones

Osełki diamentowe 235

Rasps & sets

Tarniki do drewna i zestawy 235

Rasps for plaster

Tarniki do gipsu 235

Abrasive products

Artykuły ściernie

236-242



Sand papers

Papiery ściernie 236

Waterproof sand papers

Papiery ściernie wodoodporne 236

Abrasive clothes

Płótna ściernie 237

Abrasive meshes

Siatki ściernie 237

No end abrasive bands

Taśmy ściernie bezkońcowe 237

Abrasive sponges

Kostki ściernie 238

Abrasive sheets and discs

Arkusze i krążki ściernie 239

Back pads for drywall sander

Głowice do szlifierki do gipsu 242

Polishing products

Artykuły polerskie

242-245



EN Twist drill HSS
PL Wiertło do metalu HSS
DE Metallspiralbohrer HSS
RU Цeпно no мeтaлнy HSS
CZ Vrták na kov HSS
HU Fúrészár fémhez HSS

RO Burghiu pt. metal HSS
FR Foret métal HSS
IT Punta per metallo HSS
ES Broca para metal HSS
CN 轧制麻花钻

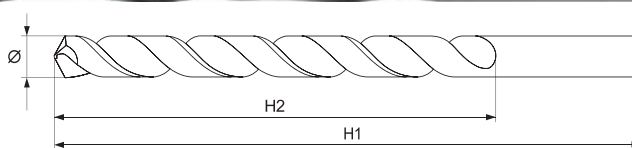
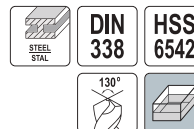

• Application: industry
• For precise drilling in steels, cast steels, non-ferrous metals, plastics

• Przeznaczenie: przemysł
• Do precyzyjnych wierceń w stalach, żeliwach, metalach nieżelaznych, tworzywach sztucznych

YATO	Ø [mm]	H1 [mm]	H2 [mm]	c [min ⁻¹]	pcs / szt.	
YT-4430	1.0	34	23	3800	10	80/320
YT-4431	1.5	43	20	3800	10	80/320
YT-4432	2.0	49	24	4000	10	80/320
YT-4433	2.5	57	30	3200	10	80/320
YT-4434	2.8	61	33	2800	10	80/320
YT-4435	3.0	61	33	2600	10	80/320
YT-4436	3.2	65	36	2500	10	80/320
YT-4437	3.5	70	39	2300	10	80/320
YT-4438	4.0	75	43	2000	10	20/80
YT-4439	4.2	75	43	1900	10	20/80

YATO	Ø [mm]	H1 [mm]	H2 [mm]	c [min ⁻¹]	pcs / szt.	
YT-4440	4.5	80	47	1800	10	20/80
YT-4441	4.8	86	52	1600	10	20/80
YT-4442	5.0	86	52	1600	10	20/80
YT-4443	5.2	86	52	1500	10	20/80
YT-4444	5.5	93	57	1500	10	20/80
YT-4445	6.0	93	57	1300	10	20/80
YT-4446	6.5	101	63	1200	10	10/40
YT-4447	7.0	109	69	1100	10	10/40
YT-4448	7.5	109	69	1100	10	10/40
YT-4449	8.0	117	75	1000	10	10/40

YATO	Ø [mm]	H1 [mm]	H2 [mm]	c [min ⁻¹]	pcs / szt.	
YT-4450	8.5	117	75	900	5	10/40
YT-4451	9.0	125	81	900	5	10/40
YT-4452	9.5	125	81	800	5	10/40
YT-4453	10.0	133	87	800	5	10/40
YT-4454	10.5	133	87	800	3	10/40
YT-4455	11.0	142	94	700	3	10/40
YT-4456	12.0	151	101	700	3	10/40
YT-4457	12.5	151	101	600	3	10/40
YT-4458	13.0	151	101	600	3	10/40

EN Twist drill set
PL Zestaw wiertel do metalu
DE Metall-Spiralbohrer-Satz

RU Haбop цeпнo no мeтaлнy
CZ Sada vrtáků na kov
HU Fúrészár készlet fémhez

RO Set de burghie pt. metal
FR Set de forets métal
IT Set punte per metallo

ES Juego de brocas para metal
CN 麻花钻组套



6
PCS
Ø
2.0-8.0
mm



10
PCS
Ø
1.0-10
mm



19
PCS
Ø
1.0-10
mm

YATO	Ø [mm]	
YT-4460	2, 3, 4, 5, 6, 8	15/60

YATO	Ø [mm]	
YT-4461	1, 2, 3, 4, 5, 6, 7, 8, 9, 10	20/40

YATO	Ø [mm]	
YT-4462	1, 1.5, 2, 2.5, 3, 3.5, 4, 4.5, 5, 5.5, 6, 6.5, 7, 7.5, 8, 8.5, 9, 9.5, 10	15/30

EN Twist drill HSS
PL Wiertło do metalu HSS
DE Metallspiralbohrer HSS
RU Цeпно no мeтaлнy HSS
CZ Vrták na kov HSS
HU Fúrészár fémhez HSS

RO Burghiu pt. metal HSS
FR Foret métal HSS
IT Punta per metallo HSS
ES Broca para metal HSS
CN 磨制麻花钻

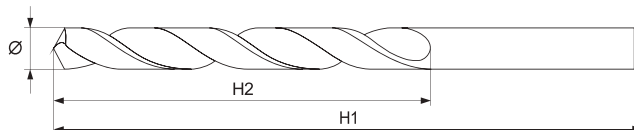

YATO	Ø [mm]	H1 [mm]	H2 [mm]	pcs / szt.	
YT-44200	0.5	22	6	5	100/400
YT-44201	0.8	30	10	5	100/400
YT-44202	1.0	34	11	5	100/400
YT-44203	1.5	40	18	5	100/400
YT-44204	2.0	48	22	5	100/400
YT-44205	2.2	53	28	5	50/400
YT-44206	2.4	56	30	5	100/400
YT-44207	2.5	57	30	5	100/400
YT-44208	2.8	62	30	5	100/400
YT-44209	3.0	61	34	1	100/400
YT-44210	3.1	65	35	1	100/400
YT-44211	3.2	65	35	1	100/400
YT-44212	3.5	70	40	1	100/400
YT-44213	3.8	77	48	1	100/400

YATO	Ø [mm]	H1 [mm]	H2 [mm]	pcs / szt.	
YT-44214	4.0	74	44	1	100/400
YT-44215	4.1	75	44	1	100/400
YT-44216	4.2	75	45	1	100/400
YT-44217	4.5	79	45	1	100/400
YT-44218	4.8	85	51	1	100/400
YT-44219	5.0	86	52	1	100/400
YT-44220	5.2	86	52	1	100/400
YT-44221	5.5	92	56	1	100/400
YT-44222	6.0	93	56	1	100/400
YT-44223	6.5	100	63	1	100/400
YT-44224	7.0	103	64	1	50/300
YT-44225	7.5	108	70	1	50/300
YT-44226	8.0	115	75	1	50/300
YT-44227	8.5	115	73	1	50/300

YATO	Ø [mm]	H1 [mm]	H2 [mm]	pcs / szt.	
YT-44228	9.0	125	81	1	50/300
YT-44229	9.5	125	82	1	50/300
YT-44230	10.0	133	87	1	50/200
YT-44231	10.2	130	85	1	50/200
YT-44232	10.5	132	82	1	50/200
YT-44233	11.0	142	95	1	50/200
YT-44234	11.5	142	95	1	50/150
YT-44235	12.0	150	100	1	50/150
YT-44236	12.5	150	100	1	50/150
YT-44237	13.0	150	100	1	50/150
YT-44238	14.0	160	110	1	25/100
YT-44239	16.0	176	122	1	25/100
YT-44240	20.0	205	140	1	25/50

- EN Double end metal twist drill
- PL Wiertło do metalu dwustronne
- DE Doppelend-Metalbohrer
- RU Двухстороннее сверло по металлу
- CZ Vrták do kovu dvoustranný
- HU Kétoldalas fém fúrószár
- RO Burghiu metal cu cap dublu
- FR Foret pour métal à double extrémité
- IT Punta doppia per metallo
- ES Broca para metal doble
- CN 双头全磨制麻花钻

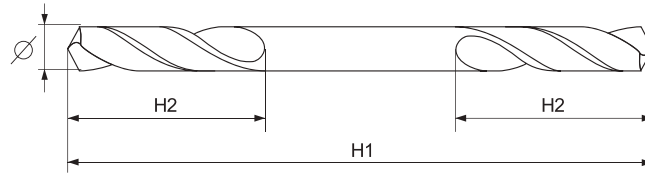

YATO	Ø [mm]	H1 [mm]	H2 [mm]	
YT-40010	3.0	46	9.5	100/500
YT-40011	3.2	49	9.5	100/500
YT-40012	3.5	52	13	100/500
YT-40013	4.0	55	13	100/500

YATO	Ø [mm]	H1 [mm]	H2 [mm]	
YT-40014	4.2	55	13	100/500
YT-40016	5.0	62	16	100/400
YT-40019	6.0	66	16	50/500

- EN Double end metal twist drill set
- PL Zestaw dwustronnych wiertel do metalu
- DE Satz von doppelseitigen Bohrern für Metall
- RU Набор двухсторонних сверл по металлу
- CZ Sada oboustranných vrtáků do kovu
- HU Kétoldalas fémfúró szár készlet
- RO Set burghie metal cu cap dublu
- FR Ensemble de forets pour métaux à deux côtés
- IT Set di punte a doppia estremità per metallo
- ES Juego de brocas de doble punta para metal
- CN 双头钻组套



YATO	Ø [mm]	
YT-40025	3.0, 3.2, 3.5, 4.0, 4.2, 4.5, 5.0, 5.2, 5.5, 6.0	10/240

- EN Twist drill HSS-Cobalt
- PL Wiertło do metalu HSS-Cobalt
- DE Metallspiralbohrer HSS-Cobalt
- RU Сверло по металлу HSS-Cobalt
- CZ Vrták na kov HSS-Cobalt
- HU Fúrószár fémhez HSS-Cobalt
- RO Burghiu pt. metal HSS-Cobalt
- FR Foret métal HSS-Cobalt
- IT Punta per metallo HSS-Cobalt
- ES Broca para metal HSS-Cobalt
- CN 全磨制含钴麻花钻

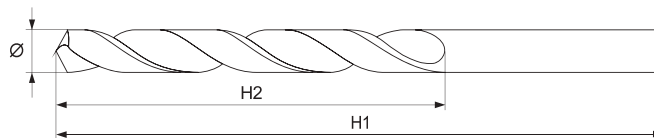

- Application: industry
- For precise drilling in hard steels, non-ferrous metals, plastics, stainless steel and acid resistant steel
- Resistant to high temperatures

- Przeznaczenie: przemysł
- Do precyzyjnych wierceń w trudnych materiałach, np. stalach szlachetnych, metalach kolorowych, tworzywach, stalach nierdzewnych i kwasoodpornych
- Odporne na działanie wysokiej temperatury

YATO	Ø [mm]	H1 [mm]	H2 [mm]	pcs / szt.	
YT-4020	2.0	49	24	2	125/500
YT-4025	2.5	57	30	2	125/500
YT-4030	3.0	61	33	2	125/500
YT-4032	3.2	65	36	1	100/400
YT-4035	3.5	70	39	1	100/400
YT-4040	4.0	75	43	1	100/400
YT-4042	4.2	75	43	1	100/400
YT-4045	4.5	80	47	1	100/400
YT-4048	4.8	86	52	1	100/400
YT-4050	5.0	86	52	1	100/400
YT-4052	5.2	86	52	1	100/400
YT-4055	5.5	93	57	1	100/400

YATO	Ø [mm]	H1 [mm]	H2 [mm]	pcs / szt.	
YT-4060	6.0	93	57	1	100/400
YT-4065	6.5	101	63	1	75/300
YT-4070	7.0	109	69	1	75/300
YT-4075	7.5	109	69	1	75/300
YT-4080	8.0	117	75	1	75/300
YT-4085	8.5	117	75	1	75/300
YT-4090	9.0	125	81	1	75/300
YT-4100	10.0	133	87	1	75/300
YT-4110	11.0	142	94	1	75/300
YT-4120	12.0	151	101	1	75/300
YT-4140	14.0	160	108	1	25/100
YT-4160	16.0	178	120	1	25/100

EN Twist drill set
PL Zestaw wiertel do metalu
DE Metall-Spiralbohrer-Satz
RU Набор сверл по металлу

CZ Sada vrtáků na kov
HU Fúrószer készlet fémhez
RO Set de burghie pt. metal
FR Set de forets métal

IT Set punte per metallo
ES Juego de brocas para metal
CN 麻花钻组套



6 PCS
∅ 2.0-8.0 mm

10 PCS
∅ 1.0-10 mm

YATO	∅ [mm]	
YT-41602	2, 3, 4, 5, 6, 8	15/60

YATO	∅ [mm]	
YT-41603	1, 2, 3, 4, 5, 6, 7, 8, 9, 10	20/40



19 PCS
∅ 1.0-10 mm

25 PCS
∅ 1.0-13 mm

YATO	∅ [mm]	
YT-41604	1, 1.5, 2, 2.5, 3, 3.5, 4, 4.5, 5, 5.5, 6, 6.5, 7, 7.5, 8, 8.5, 9, 9.5, 10	15/30

YATO	∅ [mm]	
YT-41605	1, 1.5, 2, 2.5, 3, 3.5, 4, 4.5, 5, 5.5, 6, 6.5, 7, 7.5, 8, 8.5, 9, 9.5, 10, 10.5, 11, 11.5, 12, 12.5, 13	10

EN Twist drill
PL Wiertło do metalu
DE Metallspiralbohrer
RU Сверло по металлу
CZ Vrták na kov
HU Fúrószer fémhez

RO Burghiu pt. metal
FR Foret métal
IT Punte per metallo
ES Broca para metal
CN 全磨制麻花钻

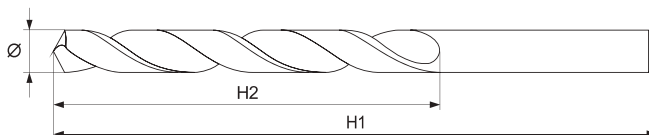

YATO	∅ [mm]	H1 [mm]	H2 [mm]	pcs / szt.	
YT-44630	1.0	34	12	2	50/500
YT-44631	1.5	40	18	2	50/500
YT-44632	2.0	49	24	2	50/500
YT-44633	2.5	57	30	2	50/500
YT-44634	2.8	61	33	2	50/500
YT-44635	3.0	61	33	2	50/500
YT-44637	3.2	65	36	1	50/500
YT-44639	3.5	70	39	1	50/500
YT-44640	4.0	75	43	1	50/500
YT-44642	4.2	75	43	1	50/500

YATO	∅ [mm]	H1 [mm]	H2 [mm]	pcs / szt.	
YT-44643	4.5	80	47	1	50/500
YT-44645	4.8	86	52	1	50/500
YT-44650	5.0	86	52	1	50/500
YT-44652	5.2	86	52	1	50/500
YT-44653	5.5	93	57	1	50/500
YT-44654	6.0	93	57	1	50/500
YT-44655	6.5	101	63	1	50/250
YT-44656	7.0	109	69	1	50/250
YT-44657	7.5	109	69	1	50/250
YT-44658	8.0	117	75	1	50/250

YATO	∅ [mm]	H1 [mm]	H2 [mm]	pcs / szt.	
YT-44659	8.5	117	75	1	50/250
YT-44660	9.0	125	81	1	50/250
YT-44661	9.5	125	81	1	50/250
YT-44662	10.0	133	87	1	50/200
YT-44663	10.5	133	87	1	50/200
YT-44664	11.0	142	94	1	50/200
YT-44666	12.0	151	101	1	50/100
YT-44667	12.5	151	101	1	50/100
YT-44668	13.0	151	101	1	50/100

- EN Twist drill set
 PL Zestaw wiertel do metalu
 DE Metall-Spiralbohrer-Satz
 RU Набор сверел по металлу
 CZ Sada vrtáků na kov
 HU Fúrósár készlet fémhez
- RO Set de burghie pt. metal
 FR Set de forets métal
 IT Set punte per metallo
 ES Juego de brocas para metal
 CN 麻花钻组套

190
PCS

DIN 338

HSS 4241

1.0-13 mm

TITANIUM COATED POWŁOKA TYTANOWA

135°



YATO	Ø [mm]	pcs
YT-44677	1, 1.5, 2, 2.5, 3, 3.2, 3.5, 4, 4.2, 4.5, 5, 5.5, 6, 6.5, 7, 7.5, 8, 8.5, 9, 9.5, 10, 10.5, 11, 11.5, 12, 12.5, 13	5

- EN Long metal drills
 PL Długie wiertła do metalu
 DE Lange Bohrer für Metall
 RU Длинные сверла по металлу
 CZ Dlouhé vrtáky do kovu
 HU Hosszú fémfúrósárak
- RO Burghie lungi pt. metal
 FR Longs forets à métaux
 IT Punte lunghe per metallo
 ES Brocas largas para metal
 CN 加长麻花钻组套

5
PCS

DIN 1869

HSS 4341

FULLY GROUND WIERTEL SZUFOWANE

118°



YATO	Ø [mm]	pcs
YT-39820	3, 4, 5, 6, 8	20/80

- EN Twist drill
 PL Wiertło do metalu
 DE Metallschraubbohrer
 RU Сверло по металлу
 CZ Vrták na kov
 HU Fúrósár fémhez
- RO Burghiu pt. metal
 FR Foret métal
 IT Punte per metallo
 ES Broca para metal
 CN 全磨制含钴麻花钻



DIN 338

HSS 4241

1/4"

6.3 mm

TITANIUM COATED POWŁOKA TYTANOWA

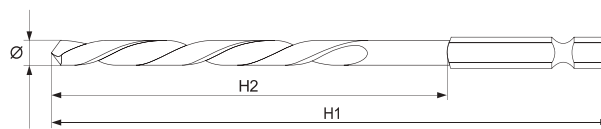

YATO	Ø [mm]	H1 [mm]	H2 [mm]	pcs / szt.	pcs
YT-44750	1.5	63	18	1	150/600
YT-44751	2.0	72	24	1	150/600
YT-44752	2.5	80	30	1	150/600
YT-44754	3.0	81	33	1	150/600
YT-44755	3.2	85	36	1	150/600
YT-44756	3.5	90	39	1	150/600
YT-44757	4.0	95	43	1	150/600
YT-44758	4.2	95	43	1	150/600

YATO	Ø [mm]	H1 [mm]	H2 [mm]	pcs / szt.	pcs
YT-44759	4.5	100	47	1	150/600
YT-44760	4.8	106	52	1	100/400
YT-44761	5.0	106	52	1	100/400
YT-44763	5.5	113	57	1	100/400
YT-44764	6.0	113	57	1	100/400
YT-44765	6.5	121	63	1	100/400
YT-44766	7.0	109	69	1	100/400
YT-44767	7.5	109	69	1	100/400

YATO	Ø [mm]	H1 [mm]	H2 [mm]	pcs / szt.	pcs
YT-44768	8.0	117	75	1	100/400
YT-44769	8.5	117	75	1	100/400
YT-44770	9.0	125	81	1	50/200
YT-44772	10.0	133	87	1	50/200
YT-44773	11.0	142	94	1	50/200
YT-44774	12.0	151	101	1	50/200
YT-44776	13.0	151	101	1	50/200

- EN Twist drill
 PL Wiertło do metalu
 DE Spiralbohrer
 RU Сверло по металлу
 CZ Vrták na kov
 HU Fúrósár fémhez
- RO Burghiu pt. metal
 FR Foret hélicoïdal
 IT Punte per metallo
 ES Broca espiral
 CN 整体六角柄全磨钻



DIN 338

HSS 6542

1/4"

6.3 mm

FULLY GROUND WIERTEL SZUFOWANE

135°

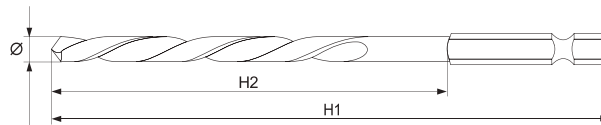

YATO	Ø [mm]	H1 [mm]	H2 [mm]	pcs / szt.	pcs
YT-44860	1.5	57	26	1	100/500
YT-44861	2.0	57	26	1	100/500
YT-44863	3.0	61	31	1	100/500
YT-44865	3.5	70	38	1	100/500
YT-44866	4.0	75	43	1	100/500
YT-44867	4.2	75	43	1	50/300
YT-44868	4.5	80	47	1	50/200
YT-44869	4.8	86	52	1	50/200

YATO	Ø [mm]	H1 [mm]	H2 [mm]	pcs / szt.	pcs
YT-44870	5.0	86	52	1	50/200
YT-44871	5.5	93	57	1	50/200
YT-44872	6.0	93	57	1	50/200
YT-44874	7.0	109	69	1	50/200
YT-44875	7.5	109	69	1	50/200
YT-44876	8.0	117	75	1	50/200
YT-44877	8.5	117	75	1	50/200
YT-44878	9.0	125	81	1	50/200

YATO	Ø [mm]	H1 [mm]	H2 [mm]	pcs / szt.	pcs
YT-44879	9.5	125	81	1	50/200
YT-44880	10.0	133	87	1	50/200
YT-44881	10.5	133	87	1	50/100
YT-44882	11.0	142	94	1	50/100
YT-44883	12.0	151	101	1	50/100
YT-44884	13.0	151	101	1	50/100

- EN Saw drill
 PL Wiertło frezujące do metalu
 DE Metall-Fräsböhrer
 RU Сверло фрезервальное по металлу
 CZ Vrták frézovací
 HU Marófúró fémhez
- RO Burghiu freza
 FR Foret de fraisage
 IT Punta per fresatura metalli
 ES Broca de sierra
 CN 整体六角柄锯钻



HRC 58-62

HSS 4241

1/4"

6.3 mm

118°

TITANIUM COATED POWŁOKA TYTANOWA

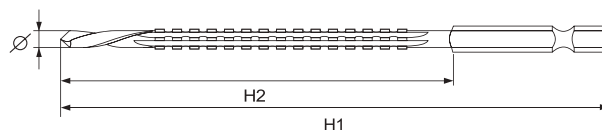

YATO	Ø [mm]	H1 [mm]	H2 [mm]	pcs / szt.	pcs
YT-44820	3.0	70	35	1	150/600
YT-44821	4.0	78	43	1	100/300
YT-44822	5.0	81	46	1	100/400
YT-44823	6.0	89	54	1	100/400

YATO	Ø [mm]	H1 [mm]	H2 [mm]	pcs / szt.	pcs
YT-44824	6.5	89	54	1	100/400
YT-44826	8.0	99	64	1	100/400
YT-44827	9.0	102	67	1	50/200
YT-44828	10.0	105	70	1	50/200

YATO	Ø [mm]	H1 [mm]	H2 [mm]	pcs / szt.	pcs
YT-44829	11.0	110	75	1	50/200
YT-44830	12.0	115	80	1	50/200
YT-44831	13.0	120	85	1	50/200

EN Twist drill set
PL Zestaw wiertel do metalu
DE Metall-Spiralbohrer-Satz
RU Набор сверл по металлу
CZ Sada vrtáků na kov
HU Fúrószár készlet fémhez
RO Set de burghie pt. metal
FR Set de forets métal
IT Set punte per metallo
ES Juego de brocas para metal
CN 麻花钻组套

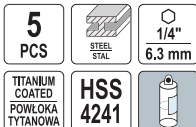

YATO	Ø [mm]	
YT-44700	4, 5, 6, 8, 10	30/60

EN Twist drill set
PL Zestaw wiertel do metalu
DE Metall-Spiralbohrer-Satz
RU Набор сверл по металлу
CZ Sada vrtáků na kov
HU Fúrószár készlet fémhez
RO Set de burghie pt. metal
FR Set de forets métal
IT Set punte per metallo
ES Juego de brocas para metal
CN 麻花钻组套

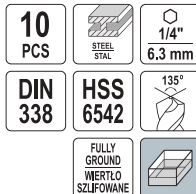

YATO	Ø [mm]	
YT-44888	1.5, 2.0, 2.5, 3.0, 3.5, 4.0, 4.5, 5.0, 5.5, 6.0	10/20

EN Twist drill set
PL Zestaw wiertel do metalu
DE Metall-Spiralbohrer-Satz
RU Набор сверл по металлу
CZ Sada vrtáků na kov
HU Fúrószár készlet fémhez
RO Set de burghie pt. metal
FR Set de forets métal
IT Set punte per metallo
ES Juego de brocas para metal
CN 麻花钻组套

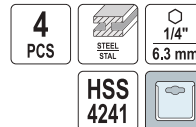

YATO	Ø [mm]	
YT-44705		12/24

EN Twist drill set
PL Zestaw wiertel do metalu
DE Metall-Spiralbohrer-Satz
RU Набор сверл по металлу

CZ Sada vrtáků na kov
HU Fúrószár készlet fémhez
RO Set de burghie pt. metal
FR Set de forets métal

IT Set punte per metallo
ES Juego de brocas para metal
CN 麻花钻组套

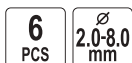

YATO	Ø [mm]	
YT-44673	2, 3, 4, 5, 6, 8	50/100



YATO	Ø [mm]	
YT-44674	1, 2, 3, 4, 5, 6, 7, 8, 9, 10	25/100

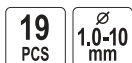

YATO	Ø [mm]	
YT-44675	1, 1.5, 2, 2.5, 3, 3.5, 4, 4.5, 5, 5.5, 6, 6.5, 7, 7.5, 8, 8.5, 9, 9.5, 10	6/30

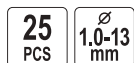

YATO	Ø [mm]	
YT-44676	1, 1.5, 2, 2.5, 3, 3.5, 4, 4.5, 5, 5.5, 6, 6.5, 7, 7.5, 8, 8.5, 9, 9.5, 10, 10.5, 11, 11.5, 12, 12.5, 13	5/20

EN Twist drill set
 PL Zestaw wiertel do metalu
 DE Metall-Spiralbohrer-Satz
 RU Набор сверл по металлу
 CZ Sada vrtáků na kov
 HU Fúrószár készlet fémhez
 RO Set de burghie pt. metal
 FR Set de forets métal
 IT Set punte per metallo
 ES Juego de brocas para metal
 CN 麻花钻组套



2 PCS
 ∅ 26, 28 mm

3 PCS
 ∅ 22-25 mm

YATO	∅ [mm]	
YT-44627	26, 28	10

YATO	∅ [mm]	
YT-44626	22, 24, 25	10



4 PCS
 ∅ 14-20 mm

5 PCS
 ∅ 10-15 mm

YATO	∅ [mm]	
YT-44625	14, 16, 18, 20	10

YATO	∅ [mm]	
YT-44622	10, 11, 12, 13, 15	10

EN Twist drill set
 PL Zestaw wiertel do metalu
 DE Metall-Spiralbohrer-Satz
 RU Набор сверл по металлу
 CZ Sada vrtáků na kov
 HU Fúrószár készlet fémhez
 RO Set de burghie pt. metal
 FR Set de forets métal
 IT Set punte per metallo
 ES Juego de brocas para metal
 CN 麻花钻组套

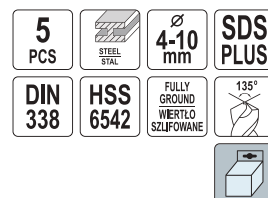

YATO	∅ [mm]	
YT-40050	4, 5, 6, 8, 10	24

EN Universal drill
 PL Wiertło uniwersalne
 DE Universalbohrer
 RU Универсальное сверло
 CZ Všeúčelový vrták
 HU Kőzet és többcélú fúró
 RO Burghiu universal
 FR Forets polyvalents
 IT Punta universale
 ES Broca multimaterial
 CN 多功能冲击钻

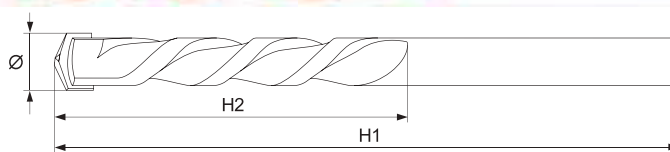
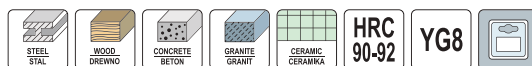

YATO	∅ [mm]	H1 [mm]	H2 [mm]	pcs / szt.	
YT-43940	3	60	35	1	100/600
YT-43941	4	75	40	1	100/600
YT-43942	5	85	50	1	100/600
YT-43943	6	100	60	1	100/400
YT-43960	6	400	240	1	25/100
YT-43944	7	100	60	1	100/400
YT-43945	8	120	70	1	50/400
YT-43962	8	400	240	1	25/100
YT-43946	10	150	90	1	50/200

YATO	∅ [mm]	H1 [mm]	H2 [mm]	pcs / szt.	
YT-43963	10	400	240	1	25/100
YT-43947	12	150	90	1	50/200
YT-43964	12	400	240	1	25/100
YT-43948	14	150	90	1	50/100
YT-43965	14	400	240	1	25/50
YT-43949	16	150	90	1	50/100
YT-43966	16	400	240	1	25/50
YT-43967	18	400	240	1	25
YT-43968	20	400	240	1	25

EN Universal drill
PL Wiertło uniwersalne
DE Universalbohrer
RU Универсальное сверло
CZ Víceúčelový vrták
HU Kőzet és többcéľű fűró
RO Burghiu universal
FR Forets polyvalents
IT Punta universale
ES Broca multimatierial
CN 六角柄多功能钻

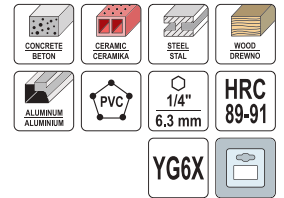
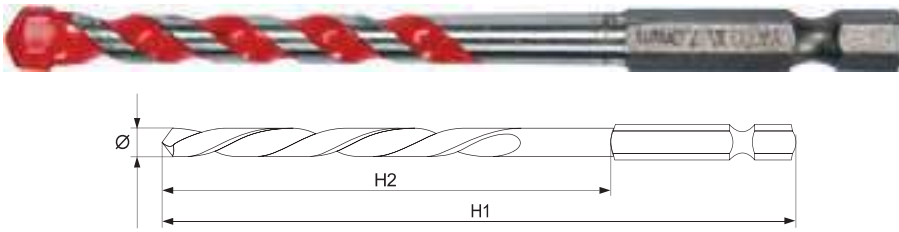

YATO	Ø [mm]	H1 [mm]	H2 [mm]	pcs / szt.	
YT-44780	3	85	30	1	125/250
YT-44781	4	85	30	1	125/250
YT-44782	5	85	30	1	125/250
YT-44783	6	85	30	1	125/250

YATO	Ø [mm]	H1 [mm]	H2 [mm]	pcs / szt.	
YT-44784	7	85	30	1	125/250
YT-44785	8	100	45	1	50/200
YT-44786	10	120	70	1	50/200
YT-44787	12	120	70	1	100/200

EN Universal drills
PL Zestaw wiertel uniwersalnych
DE Universalbohrer-Set
RU Набор универсальных сверл
CZ Sada víceúčelový vrtáky
HU Keményfém többcéľű fűró készlet
RO Set burghie universale
FR Jeu de forets universel
IT Set di punte universali
ES Juego de brocas universales
CN 六角柄多功能钻组套

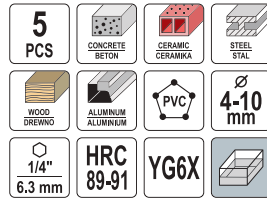

YATO	Ø [mm]	
YT-44789	4, 5, 6, 8, 10	25/100

EN Universal drill bit set
PL Zestaw wiertel uniwersalnych
DE Universalbohrer-Set
RU Набор универсальных сверл
CZ Sada víceúčelový vrtáky
HU Keményfém többcéľű fűró készlet
RO Set burghie universale
FR Jeu de forets universel
IT Set di punte universali
ES Juego de brocas universales
CN 混合钻组套



YATO	Ø [mm]	
YT-43490	3, 4, 5, 6, 8, 10	20

EN Masonry drill bit X-TIP
PL Wiertło do betonu X-TIP
DE Betonspiralbohrer X-TIP
RU Сверло по бетону X-TIP
CZ Vrták na beton X-TIP
HU Fűrószár betonhoz X-TIP
RO Burghiu pt. beton vârf X
FR Foret béton à pointe en croix
IT Punta per cemento X-TIP
ES Broca para hormigón X-TIP
CN 十字头电锤钻

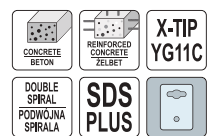
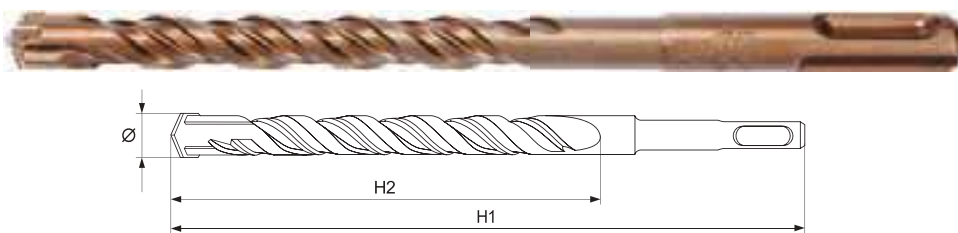

YATO	Ø [mm]	H1 [mm]	H2 [mm]	PCS ROZM.	
YT-4200	5	110	45	10	300
YT-4201	6	110	45	10	300
YT-4202	6	160	95	10	200
YT-4203	6	210	135	10	150
YT-42033	6	300	220	-	10/100
YT-4204	8	110	45	10	300
YT-4205	8	160	95	10	200
YT-4206	8	210	140	10	150
YT-42063	8	300	220	-	10/100
YT-4207	8	460	370	10	50
YT-4208	8	600	500	10	50
YT-4209	10	160	95	10	150
YT-4210	10	210	140	10	150
YT-4211	10	300	220	10	100
YT-4212	10	460	370	10	50
YT-4213	10	600	500	10	50
YT-4214	12	160	95	10	150

YATO	Ø [mm]	H1 [mm]	H2 [mm]	PCS ROZM.	
YT-4215	12	260	185	10	100
YT-42153	12	300	220	-	10/100
YT-4216	12	460	360	10	50
YT-4217	12	600	490	10	40
YT-4218	14	260	180	10	80
YT-4219	14	460	360	10	40
YT-4220	16	200	125	10	60
YT-4221	16	460	360	10	20
YT-4222	16	600	490	10	20
YT-4223	18	460	360	10	20
YT-4224	18	600	490	10	20
YT-4225	20	460	360	5	20
YT-4226	20	600	490	5	20
YT-4227	22	460	360	5	20
YT-4228	22	600	490	5	20
YT-4229	25	460	360	5	20
YT-4230	25	600	490	5	10

EN Masonry drill bit
 PL Wiertło do betonu
 DE Betonspiralbohrer
 RU Цебно no бетону
 CZ Vrták na beton
 HU Fúrósár betonhoz
 RO Burghiu pt. beton
 FR Foret béton
 IT Punta per cemento
 ES Broca para hormigón
 CN 三尖电锤钻

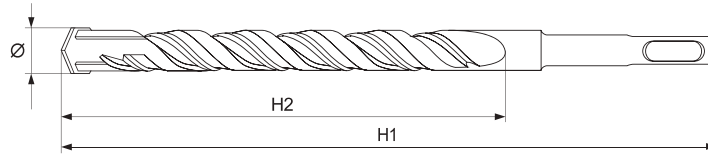

YATO	Ø [mm]	H1 [mm]	H2 [mm]	PCS PER BOX	Box
YT-4161	5	110	45	10	300
YT-4162	6	110	45	10	300
YT-4163	6	160	95	10	200
YT-4164	6	210	140	10	150
YT-4165	8	110	45	10	300
YT-4166	8	160	90	10	200
YT-4167	8	210	140	10	150
YT-4168	8	460	370	10	50
YT-4169	8	600	500	10	50
YT-4170	10	160	95	10	150
YT-4171	10	210	140	10	150
YT-4172	10	300	220	10	100
YT-4173	10	460	370	10	50
YT-4174	10	600	500	10	50
YT-4175	12	160	85	10	150
YT-4176	12	260	180	10	100

YATO	Ø [mm]	H1 [mm]	H2 [mm]	PCS PER BOX	Box
YT-4177	12	460	360	10	50
YT-4178	12	600	490	10	40
YT-4179	14	260	180	10	80
YT-4180	14	460	360	10	40
YT-4181	16	200	125	10	60
YT-4182	16	300	220	10	50
YT-4183	16	460	360	10	20
YT-4184	16	600	490	10	20
YT-4185	18	460	360	10	20
YT-4186	18	600	490	10	20
YT-4187	20	460	360	5	20
YT-4188	20	600	490	5	20
YT-4189	22	460	360	5	20
YT-4190	22	600	490	5	20
YT-4191	25	460	360	5	20
YT-4192	25	600	490	5	10

EN Masonry drill bit
 PL Wiertło do betonu
 DE Betonspiralbohrer
 RU Цебно no бетону
 CZ Vrták na beton
 HU Fúrósár betonhoz
 RO Burghiu pt. beton
 FR Foret béton
 IT Punta per cemento
 ES Broca para hormigón
 CN 三尖电锤钻

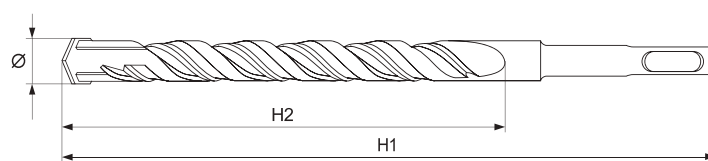

- For windows assembly
- Without necessity of using screw anchors
- Do montażu okien
- Bez użycia kółków rozporowych

YATO	Ø [mm]	H1 [mm]	H2 [mm]	PCS PER BOX	Box
YT-41641	6.5	200	130	10	10/150
YT-41642	6.5	260	183	10	10/150

EN Masonry drill bit
 PL Wiertło do betonu
 DE Betonspiralbohrer
 RU Цебно no бетону
 CZ Vrták na beton
 HU Fúrósár betonhoz
 RO Burghiu pt. beton
 FR Foret béton
 IT Punta per cemento
 ES Broca para hormigón
 CN 十字刀头电锤钻

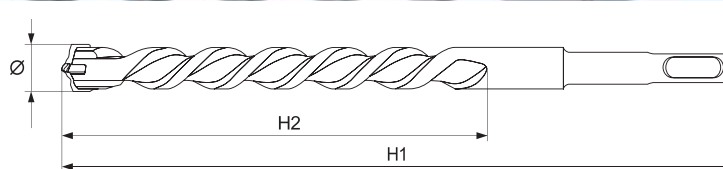

- Resistant for stack in SDS chuck
- DD carbide tip
- Automatic soldering
- Odporne na zakleszczenie w uchwycie SDS
- Widia DD carbide
- Automatische lutowanie

YATO	Ø [mm]	H1 [mm]	H2 [mm]	Box
YT-41930	5	110	50	40/160
YT-41935	5	160	100	40/160
YT-41931	6	110	50	40/160
YT-41936	6	160	100	40/160
YT-41942	6	210	150	40/160
YT-419503	6	300	250	40/160
YT-41951	6	460	375	30/120
YT-41960	6	600	525	25/100
YT-41932	7	110	50	40/160
YT-41937	7	160	100	40/160
YT-41933	8	110	50	40/160
YT-41938	8	160	100	40/160
YT-41943	8	210	150	40/160
YT-419504	8	300	250	20/160
YT-41952	8	460	375	30/120
YT-41961	8	600	525	20/80
YT-41939	9	160	100	40/160

YATO	Ø [mm]	H1 [mm]	H2 [mm]	Box
YT-41944	9	210	150	40/160
YT-41934	10	110	50	40/160
YT-41940	10	160	100	40/160
YT-41945	10	210	150	30/120
YT-419505	10	300	250	20/160
YT-41953	10	460	375	30/120
YT-41962	10	600	525	20/80
YT-41941	12	160	100	40/160
YT-41946	12	210	150	30/120
YT-419506	12	300	245	20/160
YT-41954	12	460	375	20/80
YT-41963	12	600	525	15/60
YT-41969	12	1000	930	25
YT-41947	14	210	150	20/80
YT-41955	14	460	375	20/80
YT-41964	14	600	525	15/60
YT-41970	14	1000	930	20

YATO	Ø [mm]	H1 [mm]	H2 [mm]	Box
YT-41948	16	210	150	20/80
YT-41956	16	460	375	15/60
YT-41965	16	600	525	10/40
YT-41971	16	1000	930	20
YT-41949	18	210	150	20/80
YT-41957	18	460	375	10/40
YT-41966	18	600	525	5/20
YT-41972	18	1000	930	15
YT-41950	22	210	150	20/80
YT-41958	22	460	375	8/32
YT-41967	22	600	525	5/20
YT-41973	22	1000	930	15
YT-41959	25	460	375	8/32
YT-41968	25	600	525	5/20
YT-41974	25	1000	930	15

EN Masonry drill bit
PL Wiertło do betonu
DE Betonspiralbohrer
RU Сверло по бетону
CZ Vrták na beton
HU Fúrészár betonhoz

RO Burghiu pt. beton
FR Foret béton
IT Punta per cemento
ES Broca para hormigón
CN 建工钻

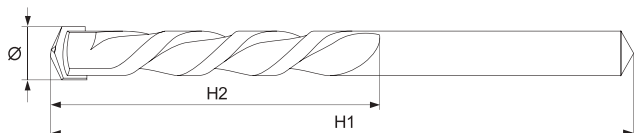
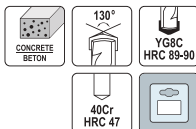

YATO	Ø [mm]	H1 [mm]	H2 [mm]	
YT-4361	4	70	35	100/400
YT-4362	5	90	50	100/400
YT-4363	6	100	60	100/400
YT-4364	6	150	100	100/400
YT-4367	7	100	60	75/300
YT-4369	8	120	80	75/300
YT-4370	8	200	140	50/150

YATO	Ø [mm]	H1 [mm]	H2 [mm]	
YT-4375	10	120	80	75/300
YT-4376	10	200	140	50/150
YT-4379	12	150	100	50/150
YT-4380	12	200	140	50/150
YT-4383	14	180	120	25/100
YT-4385	16	180	120	25/100

EN Masonry drill bit set
PL Zestaw wiertel do betonu
DE Betonbohrer-Satz
RU Набор сверл по бетону
CZ Sada vrtáků do betonu
HU Fúrőkészlet betonhoz
RO Set de burghie pt. beton
FR Jeu de forets à béton
IT Set punte per calcestruzzo
ES Juego brocas para hormigón
CN 建工钻组套

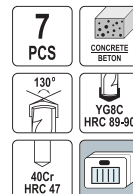

YATO	Ø [mm]	
YT-4390	4, 5, 6, 8, 9, 10, 12	10/80

EN Flat wood drill bit
PL Wiertło łopatkowe do drewna
DE Schaufelbohrer
RU Перовые сверло
CZ Plochý vrták
HU Homlokmarós fúró
RO Burghiu plat pt. lemn
FR Mèche à bois plate
IT Punta per legno piatta
ES Broca de aletas
CN 木工扁钻

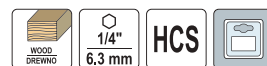
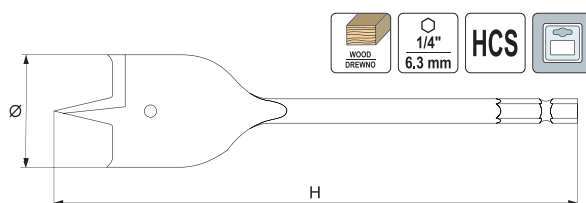

YATO	Ø [mm]	H [mm]	
YT-3236	6	152	50/400
YT-3237	8	152	50/400
YT-3238	10	152	50/300
YT-3239	12	152	50/300
YT-3240	13	152	50/300
YT-3241	14	152	50/300
YT-3242	16	152	50/300

YATO	Ø [mm]	H [mm]	
YT-3243	18	152	50/300
YT-3244	20	152	50/300
YT-3245	22	152	50/300
YT-3246	24	152	50/300
YT-3247	25	152	50/300
YT-3248	26	152	50/300
YT-3249	28	152	50/300

YATO	Ø [mm]	H [mm]	
YT-3250	30	152	50/200
YT-3251	32	152	50/200
YT-3252	34	152	50/200
YT-3253	35	152	50/200
YT-3254	38	152	50/200
YT-3255	40	152	50/200

EN Extension for flat wood drill bits
PL Przedłużka do wiertel łopatkowych, bitów i wiertel
DE Verlängerung für Schaufelbohrer
RU Удлинитель для перовых сверл
CZ Nástavec pro ploché vrtáky
HU Hosszabbító homlokmarós fafúrókhoz
RO Prelungitor pt. burghie plate
FR Rallonge pour mèches à bois
IT Prolunga per punta fresatrice
ES Extensión para brocas de aletas
CN 木工扁钻延长杆

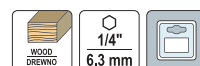
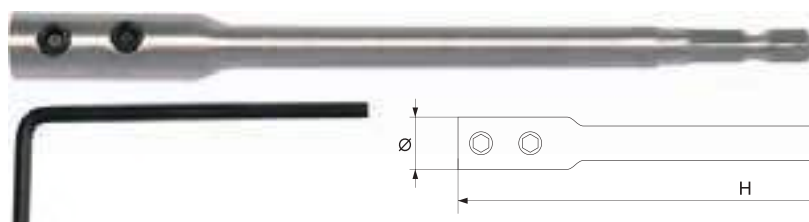

YATO	Ø [mm]	H [mm]	
YT-3256	12.2	150	60/120
YT-3257	13.5	300	30/60

EN Flat wood drill bit set
PL Zestaw wiertel łopatkowych
DE Schaufelbohrersatz
RU Набор перовых сверл
CZ Sada plochých vrtáků
HU Homlokmarós fafúró készlet
RO Set burghie plate pt. lemn
FR Set de mèches à bois
IT Set di punte per legno piatta
ES Juego de brocas de aletas
CN 木工扁钻组套

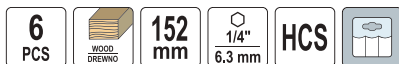

YATO	Ø [mm]	H [mm]	
YT-3258	10, 12, 16, 18, 20, 25	152	25/50

EN Flat wood drill bit set
PL Zestaw wiertel łopatkowych
DE Schaufelbohrersatz
RU Набор перовых сверл
CZ Sada plochých vrtáků
HU Homlokmarós fafúró készlet



YATO	Ø [mm]	H [mm]	
YT-3259	12, 16, 18, 20, 22, 25, 28, 32	152	5/20

- EN Spur wood drill bit
- PL Wiertło do drewna spiralne
- DE Spiralbohrer für Holz
- RU Спиральное сверло по дереву
- CZ Vrták do dřeva spirálový
- HU Csigafúró fához
- RO Burghiu pt. lemn
- FR Méches hélicoïdales à bois
- IT Punta per legno spirale
- ES Barrena para madera espiral
- CN 木工钻

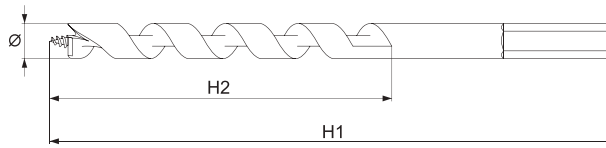
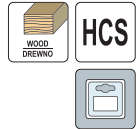

YATO	Ø [mm]	H1 [mm]	H2 [mm]	
YT-4350	3	60	35	30/300
YT-4351	4	75	44	30/300
YT-4352	5	85	52	30/300
YT-4353	6	90	57	30/300

YATO	Ø [mm]	H1 [mm]	H2 [mm]	
YT-4354	7	100	67	30/300
YT-4355	8	110	75	30/300
YT-4356	10	120	77	30/300
YT-4357	12	150	97	15/120

YATO	Ø [mm]	H1 [mm]	H2 [mm]	
YT-4358	13	150	102	15/120
YT-4359	16	160	120	15/120

- EN Spur wood drill bit
- PL Wiertło do drewna spiralne
- DE Spiralbohrer für Holz
- RU Спиральное сверло по дереву
- CZ Vrták do dřeva spirálový
- HU Csigafúró fához
- RO Burghiu pt. lemn
- FR Méches hélicoïdales à bois
- IT Punta per legno spirale
- ES Barrena para madera espiral
- CN 木工钻

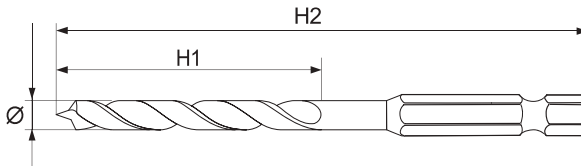
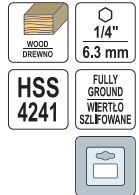

YATO	Ø [mm]	H1 [mm]	H2 [mm]	
YT-33861	4	75	43	125/500
YT-33862	5	86	52	75/300
YT-33863	6	93	57	75/300
YT-33864	7	109	69	75/300

YATO	Ø [mm]	H1 [mm]	H2 [mm]	
YT-33865	8	117	75	75/300
YT-33866	10	133	87	75/300
YT-33867	12	151	101	75/300
YT-33868	13	151	101	50/200

YATO	Ø [mm]	H1 [mm]	H2 [mm]	
YT-33869	14	160	108	50/200
YT-33870	16	178	120	50/200

- EN Spur wood drill set
- PL Zestaw wiertel spiralnych do drewna
- DE Holzspiralbohrer-Set
- RU Набор спиральных сверел по дереву
- CZ Sada spirálových vrtáků do dřeva
- HU Spirál fafúrószár készlet
- RO Set burghie pt. lemn
- FR Jeu de forets à spirale pour bois
- IT Set di punte spirali per legno
- ES Juego de brocas espirales para la madera
- CN 高速钢整体木工钻组套

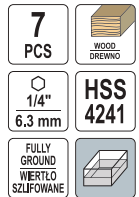

YATO	Ø [mm]	
YT-33873	3, 4, 5, 6, 7, 8, 10	20/80

- EN Auger drill bit hex
- PL Wiertło do drewna 4-ostrzowe Hex
- DE 4-flöte Schlangenbohrer
- RU Сверло по дереву Hex с 4 режущими кромками
- CZ Vrták do dřeva
- HU Auger fafúrószár bit befogással
- RO Burghiu sfredel
- FR 4 diamètre ébénisterie bois foret
- IT Punta esagonale per legno
- ES Broca espiral de madera Hex
- CN 四槽木工钻

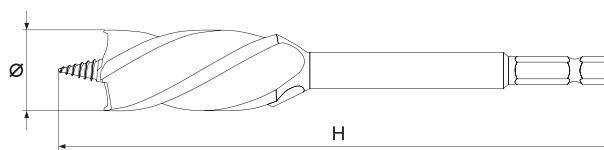

YATO	Ø [mm]	H [mm]	
YT-44680	10	165	100/200
YT-44681	12	165	100/200
YT-44682	14	165	100/200
YT-44683	16	165	100/200

YATO	Ø [mm]	H [mm]	
YT-44684	18	165	75/150
YT-44685	20	165	75/150
YT-44686	22	165	50/100
YT-44687	25	165	50/100

YATO	Ø [mm]	H [mm]	
YT-44688	28	165	50/100
YT-44689	30	165	50/100
YT-44690	32	165	50/100

EN Auger drill bit set
PL Zestaw wiertel do drewna 4-ostrzowych Hex
DE Schlangenbohrer 4-flöte Set
RU Набор сверл по дереву с 4 режущими кромками
CZ Sada vrtáky do dřeva
HU Auger fűrésztár bit befogással készlet
RO Set burghiu sfredel
FR Coffret 4 diamètre ébénisterie bois foret
IT Set di punte esagonali per legno
ES Juego de brocas espiral de madera Hex
CN 木工钻

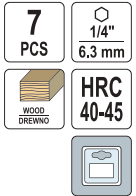

1/4" (6.3 mm); 16, 18, 20, 22, 25 mm (L=165 mm);
 1/4" (6.3 mm); (300 mm);

YATO	YT-44693	
		10/20

EN Auger wood drill bit
PL Świder do drewna
DE Holzbohrer
RU Бур по дереву
CZ Vrták do dřeva hadovitý
HU Fafűrő
RO Burghiu elicoidal pt. lemn
FR Foret spirale à bois
IT Punta a torciglione per legno
ES Barrena para madera
CN 螺旋木工钻

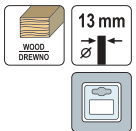
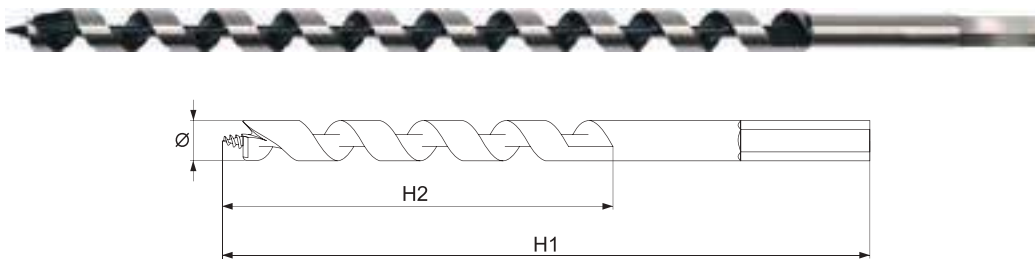

YATO	Ø [mm]	H1 [mm]	H2 [mm]	
YT-3261	6	230	150	150/300
YT-3262	8	230	150	140/280
YT-3263	8	460	360	60/120
YT-3264	10	230	150	100/200
YT-3265	10	460	360	50/100
YT-3266	12	190	150	75/150
YT-3267	12	460	360	30/60
YT-3268	13	230	150	50/100
YT-3269	13	400	310	30/60
YT-3270	14	191	150	50/100
YT-3271	14	460	360	30/60
YT-3272	16	230	150	50/100
YT-3273	16	460	360	20/40

YATO	Ø [mm]	H1 [mm]	H2 [mm]	
YT-3274	18	230	150	40/80
YT-3275	18	460	360	20/40
YT-3276	20	230	150	30/60
YT-3277	20	460	360	20/40
YT-3278	22	230	150	20/60
YT-3279	22	460	360	15/30
YT-3280	24	230	150	30/60
YT-3281	24	460	360	15/30
YT-3282	25	230	150	20/40
YT-3283	25	460	360	15/30
YT-3284	26	230	150	20/40
YT-3285	26	460	360	10/20
YT-3286	28	230	150	10/20

YATO	Ø [mm]	H1 [mm]	H2 [mm]	
YT-3287	28	460	360	10/20
YT-3288	30	230	150	10/20
YT-3289	30	460	360	5/10
YT-3290	32	230	150	10/20
YT-3291	32	460	360	5/10
YT-3292	35	230	150	10/20
YT-3293	35	460	360	5/10
YT-3294	36	230	150	10/20
YT-3295	36	460	360	5/10
YT-3296	38	230	150	10/20
YT-3297	40	230	360	10/20

EN Auger wood drill bit set
PL Zestaw świderów do drewna
DE Holzbohrersatz
RU Набор буров по дереву
CZ Sada hadovitých vrtáků do dřeva
HU Fafűrő készlet

RO Set de burghie elicoidale pt. lemn
FR Set de forets spirales à bois
IT Set di punte a torciglione
ES Juego de barrenas para madera
CN 螺旋木工钻组套



13 mm

460 mm

YATO	Ø [mm]	H [mm]	
YT-3299	10, 12, 14, 16, 18, 20	460	8



13 mm

230 mm

YATO	Ø [mm]	H [mm]	
YT-3298	10, 12, 14, 16, 18, 20	230	15



SDS PLUS
230 mm

YATO	Ø [mm]	H [mm]	
YT-3300	10, 12, 14, 16, 18, 20	230	20

EN Confirmat screw drill bit
 PL Wiertło do konfirmatów
 DE Konfirmatbohrer
 RU Сверло под конфирмат
 CZ Vrták na konfirmáty
 HU Konfirmátor csavar előfűró

RO Burghiu reglaj adâncime
 FR Foret à vis confirmat
 IT Avvitatore per viti di assemblaggio mobili
 ES Broca para tornillos confirmat
 CN 倒角器木工钻

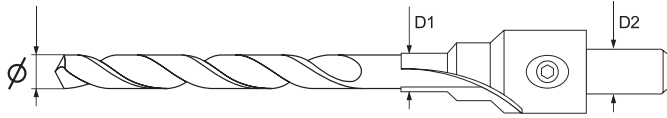

YATO	Ø [mm]	D1 [mm]	D2 [mm]	
YT-33021	4	6	8	25/250
YT-33022	5	7	8	25/250
YT-33023	7	10	8	25/250

EN Drill for ceramic tiles
 PL Wiertło do ceramiki i gresu
 DE Keramik und Fliesen Bohr

RU Бурильные плитки и керамики
 CZ Vrtací tašek a keramických výrobků
 HU Fűrő cserép és kerámia

RO Burghiu pt. ceramica si sticla
 FR Tuiles de forage et de la céramique
 IT Piastrelle e ceramiche trapano

ES Azulejos y cerámicas de perforación
 CN 玻璃钻



YATO	Ø [mm]	
YT-3725	4	100/400
YT-3726	6	100/400

EN Diamond tile drill bit
 PL Koronka diamentowa
 DE Diamantbohrkrone
 RU Алмазная коронка
 CZ Diamantová korunka
 HU Gyémánt koronafűró
 RO Burghiu diamant
 FR Trépan diamant
 IT Punta a corona diamantata
 ES Broca diamante
 CN 钎焊打孔钻

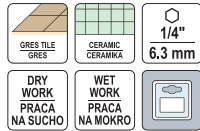

YATO	Ø [mm]	ω [min ⁻¹]	
YT-60401	6	1500	50/200
YT-60402	8	1500	50/200
YT-60403	10	1500	50/200

EN Diamond tile drill bit
 PL Koronka diamentowa
 DE Diamantbohrkrone
 RU Алмазная коронка
 CZ Diamantová korunka
 HU Gyémánt koronafűró
 RO Carotă diamantată
 FR Trépan diamant
 IT Punta a corona diamantata
 ES Broca diamante
 CN 金刚石电镀薄壁钻



YATO	Ø [mm]	
YT-3727	8	100/400
YT-3728	10	50/200

EN Diamond tile drill bit
 PL Koronka diamentowa
 DE Diamantbohrkrone
 RU Алмазная коронка
 CZ Diamantová korunka
 HU Gyémánt koronafűró
 RO Burghiu diamant
 FR Trépan diamant
 IT Punta a corona diamantata
 ES Broca diamante
 CN 钎焊打孔钻



YATO	Ø [mm]	ω [min ⁻¹]	
YT-60409	6, 8, 10	1500	20/80

YATO	Ø [mm]	ω [min ⁻¹]	
YT-60421	5	600	50/400
YT-60422	6	600	50/400
YT-60423	8	600	50/400
YT-60424	10	600	50/500
YT-60425	12	600	50/200
YT-60426	14	600	50/200
YT-60427	16	600	50/200
YT-60428	20	500	25/100
YT-60429	25	500	25/100
YT-60430	30	500	25/100
YT-60431	40	500	15/60
YT-60432	50	400	15/60
YT-60433	68	400	8/40
YT-60434	80	400	5/25
YT-60435	105	400	4/20
YT-60436	125	400	4/20

- EN Diamond tile drill bit
- PL Koronka diamentowa
- DE Diamantbohrkrone
- RU Алмазная коронка
- CZ Diamantová korunka
- HU Gyémánt koronafúró
- RO Carotă diamentată
- FR Trépan diamant
- IT Punta a corona diamentata
- ES Broca diamante
- CN 钎焊薄壁钻



YATO	Ø [mm]	c [min ⁻¹]	
YT-60441	6	12200	100/200
YT-60442	8	12200	100/200
YT-60443	10	12200	100/200
YT-60444	20	12200	100/200
YT-60445	30	12200	50/100
YT-60446	51	12200	40/80
YT-60447	68	12200	50

- EN Adjustable hand reamer
- PL Rozwiertak nastawny
- DE Verstellbare Reibahle
- RU Регулируемая развертка
- CZ Nastavitelný výstružník
- HU Állítható dörzsár
- RO Alezor reglabil
- FR Alesoir à main réglable
- IT Alesatore regolabile
- ES Escariador ajustable
- CN 可调式手用铰刀



YATO	Working diameter / Średnica robocza [mm²]	L [mm]	Arbor diameter / Średnica trzpienia [mm²]	
YT-28950	7.75-8.5	107	4.5	50/200
YT-28951	8.5-9.25	112	4.5	50/200
YT-28952	9.25-10	116	5.0	50/200
YT-28953	10-10.75	125	5.5	50/200
YT-28954	10.75-11.75	130	6.5	50/200
YT-28955	11.75-12.75	135	7.5	50/150
YT-28956	12.75-13.75	140	7.5	50/150
YT-28957	13.75-15.25	158	8.0	20/60
YT-28958	15.25-17	165	9.0	20/60

YATO	Working diameter / Średnica robocza [mm²]	L [mm]	Arbor diameter / Średnica trzpienia [mm²]	
YT-28959	17-19	175	10.0	20/60
YT-28960	19-21	180	11.5	20/60
YT-28961	21-23	193	13.5	20/60
YT-28962	23-26	210	15.4	4/20
YT-28963	26-29.5	245	17.0	4/20
YT-28964	29.5-33.5	270	19.0	4/20
YT-28965	33.5-38	310	21.0	2/10
YT-28966	38-44	345	24.0	2/10
YT-28967	44-54	400	30.0	5

- EN Straight hole doweling jig kit
- PL Uchwyt do wiercenia prostopadłego
- DE Bohrschablone zum senkrechten Vorbohren
- RU Ручка для перпендикулярного сверления
- CZ Rukojeť pro kolmé vrtání
- HU Fúrósablon merőleges fúráshoz
- RO Șablon pt. găuri perpendiculare
- FR Guide de perçage mobile
- IT Mandrino per foratura verticale
- ES Soporte para perforación perpendicular
- CN 打孔定位器



- EN Depth collars for drills
- PL Ogranicznik głębokości wiercenia
- DE Bohrtiefenbegrenzer
- RU Ограничитель глубины для сверл
- CZ Omezovač hloubky vrtáku
- HU Mélységűtköző
- RO Limitator adancime pt. burghiu
- FR Butées de profondeur
- IT Arresto di profondità
- ES Tope de profundidad para brocas
- CN 木工定位器



YATO	Ø [mm]	
YT-44100	6, 8, 10	250/500

YATO	Ø [mm]	
YT-39700	4, 5, 6, 8, 10, 12	40

- EN Dowelling centre points
- PL Znaczniki do wyznaczenia otworów
- DE Holzdübel-Markierspitzen
- RU Набор кернов для мебельных шкантов
- CZ Značící hroty pro kolíkování
- HU Típlí jelölő
- RO Punctatoare pt. dibluri
- FR Centreurs
- IT Set centrorori per spine
- ES Centradores
- CN 木工顶尖



YATO	Ø [mm]	
YT-44104	6	25/100
YT-44105	8	25/100
YT-44106	10	25/100

EN Dowel set
 PL Zestaw do połączeń kolkowych
 DE Holzdübeln-Werkzeugsatz
 RU Набор для соединения на шкантах
 CZ Kollkovačí sada
 HU Facsapozó készlet
 RO Set pt. imbinari cu dibluri lemni
 FR Kit d'assemblage bois en mains libres
 IT Set di spinatura in legno
 ES Juego para ensamblaje de madera
 CN 木工定位器组套

17 PCS
 Ø 6.0 mm



6x40 mm (10 PCS);
 6 mm (4 PCS);
 6 mm;
 2.5 mm;
 6x100 mm

YATO	Ø [mm]	
YT-44112	6	4/100

EN Dowel set
 PL Zestaw do połączeń kolkowych
 DE Holzdübeln-Werkzeugsatz
 RU Набор для соединения на шкантах
 CZ Kollkovačí sada
 HU Facsapozó készlet
 RO Set pt. imbinari cu dibluri lemni
 FR Kit d'assemblage bois en mains libres
 IT Set di spinatura in legno
 ES Juego para ensamblaje de madera
 CN 木工定位器组套

17 PCS
 Ø 8.0 mm



8x40 mm (10 PCS);
 8 mm (4 PCS);
 8 mm;
 2.5 mm;
 8x100 mm

YATO	Ø [mm]	
YT-44111	8	4/100

EN Dowel set
 PL Zestaw do połączeń kolkowych
 DE Holzdübeln-Werkzeugsatz
 RU Набор для соединения на шкантах
 CZ Kollkovačí sada
 HU Facsapozó készlet
 RO Set pt. imbinari cu dibluri lemni
 FR Kit d'assemblage bois en mains libres
 IT Set di spinatura in legno
 ES Juego para ensamblaje de madera
 CN 木工定位器组套

17 PCS
 Ø 10 mm



10x40 mm (10 PCS);
 10 mm (4 PCS);
 10 mm;
 2.5 mm;
 10x100 mm

YATO	Ø [mm]	
YT-44113	10	4/100

EN Dowel set
 PL Zestaw do połączeń kolkowych
 DE Holzdübeln-Werkzeugsatz
 RU Набор для соединения на шкантах
 CZ Kollkovačí sada
 HU Facsapozó készlet
 RO Set pt. imbinari cu dibluri lemni
 FR Kit d'assemblage bois en mains libres
 IT Set di spinatura in legno
 ES Juego para ensamblaje de madera
 CN 木工定位木销组套

154 PCS
 Ø 6, 8, 10 mm

METAL TEMPLATE
 SZABLON METALOWY

GUIDE
 PROWADNICA

ANGLE STOP
 OGRANICZNIK KĄTOWY



Doweling jig / Prowadnica do nawiercania otworów: Ø 3, 3.3, 4, 4.2, 5, 6, 6.8, 8, 10, 12 mm
 6x30 mm (50 PCS), 8x40 mm (50 PCS), 10x40 mm (50 PCS);
 6, 8, 10 mm

YATO	Ø [mm]	
YT-44122	6, 8, 10	2/10

EN Drill gauge and depth stop set
 PL Sprawdzian do średnic i ograniczniki głębokości
 DE Durchmesserlehre und Tiefenanschlag
 RU Измеритель диаметра и ограничитель глубины
 CZ Měřidla průměru a hloubkové dorazy
 HU Átmérőellenőrző és mélységátároló
 RO Set sablon gaurire cu opritor
 FR Jauges de diamètre et butées de profondeur
 IT Calibro per diametri e limitatori di profondità
 ES Calibre de diámetros y limitador de brocas
 CN 钻头量规

10 PCS
 1/16"-1/2"
 1.0-13mm



3, 4, 5, 6, 8, 10, 12 mm;
 1.5 mm

YATO	Ø	
YT-44095	1/16"-1/2" / 1.0-13 mm	20/60

EN Drill guider with handle
 PL Przyrząd do połączeń kolkowych
 DE Dübel Bohrschablone
 RU Кондуктор для сверления отверстий
 CZ Kollkovačí přípravek
 HU Típliző fúrósablon
 RO Sablon pt. dibluri lemni
 FR Guide de perçage pour assemblage par tourillons
 IT Dima per spinatura legno
 ES Guía de perforación
 CN 摆臂斜孔定位器

Ø 6, 8, 10 mm

AI



YATO	Ø [mm]	
YT-44120	6, 8, 10	10

EN Tool drill guide
 PL Szablon do wyznaczania otworów
 DE Schablone zur Markierung von Löchern
 RU Шаблон для разметки отверстий
 CZ Šablona pro značení otvorů
 HU Nyílássablon

RO Șablon pt. marcarea găurilor
 FR Gabarit pour le marquage des trous
 IT Sagoma per fori
 ES Plantilla para determinar perforaciones
 CN 打孔定位工具

250 mm

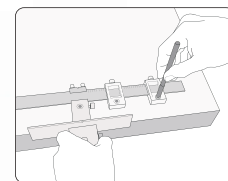



YATO		
YT-44130		20

EN Point chisel SDS Plus RU Зубило SDS Plus RO Spit SDS Plus ES Cíncel puntiaguado SDS Plus
PL Przecinak SDS Plus CZ Sekáč špičák SDS Plus FR Perçoir SDS Plus CN 尖凿
DE Spitzmeißel SDS Plus HU Hegyes véső SDS Plus IT Scalpello a punta SDS Plus

4x14
x250
mm **SDS
PLUS** **CrV** 





YATO 	L [mm]	
YT-4720	250	6/48

EN Wood chisel SDS Plus RU Долото столярски SDS Plus RO Daltă de tâmplărie SDS Plus ES Cíncel para madera SDS Plus
PL Dłuto do drewna SDS Plus CZ Řezbářské dláto SDS Plus FR Ciseau SDS Plus CN 木工凿
DE Stechbeitel SDS Plus HU Aszталos véső SDS Plus IT Scalpello SDS Plus

 **12x180
mm** **SDS
PLUS** **CrMo** 





YATO 	L [mm]	
YT-4720	180	10/80

EN Flat chisel SDS Plus RU Долото узкое SDS Plus RO Daltă plată SDS Plus ES Cíncel plano estrecho SDS Plus
PL Dłuto wąskie SDS Plus CZ Sekáč plochý SDS Plus FR Ciseau SDS Plus CN 平凿
DE Flachmeißel SDS Plus HU Lapos véső SDS Plus IT Scalpello piatto SDS Plus, punta stretta

20x14
x250
mm **SDS
PLUS** **CrV** 





YATO 	L [mm]	
YT-4721	250	6/48

EN Hollow chisel SDS Plus RU Бороzдник SDS Plus RO Punctator pt. adancit SDS Plus ES Cíncel acanalado SDS Plus
PL Bruzdownik SDS Plus CZ Sekáč drážkovací SDS Plus FR Burin à entailler SDS Plus CN 空心凿
DE Nutenmeißel SDS Plus HU Horonyvéső SDS Plus IT Scalpello per scanalature SDS Plus

22x18
x250
mm **SDS
PLUS** **CrV** 





YATO 	L [mm]	
YT-4722	250	6/48

EN Flat chisel SDS Plus RO Daltă lată SDS Plus
PL Dłuto płaskie SDS Plus FR Ciseau SDS Plus
DE Spatmeißel SDS Plus IT Scalpello piatto SDS Plus
RU Долото плоское SDS Plus ES Cíncel plano SDS Plus
CZ Sekáč plochý SDS Plus CN 平凿
HU Széles lapos véső SDS Plus

40x14
x250
mm **SDS
PLUS** **CrV** 



YATO 	L [mm]	
YT-4723	250	6/48

EN Flat chisel SDS Plus RO Daltă lată SDS Plus
PL Dłuto płaskie SDS Plus FR Ciseau SDS Plus
DE Spatmeißel SDS Plus IT Scalpello piatto SDS Plus
RU Долото плоское SDS Plus ES Cíncel plano SDS Plus
CZ Sekáč plochý SDS Plus CN 扁凿
HU Széles lapos véső SDS Plus

80x250
mm **SDS
PLUS** **CrMo** 





YATO 	L [mm]	
YT-47212	250	10/20

EN Groove chisel RO Dalta canal
PL Bruzdownik FR Burin à entailler
DE Nutenmeißel IT Scalpello per scanalature
RU Зубило канавочное ES Cíncel acanalado
CZ Sekáč drážkovací CN 五坑蝴蝶凿
HU Horonyvéső



 **26x300
mm** **SDS
MAX** 



YATO 	L [mm]	
YT-47331	300	10/30



- EN Groove chisel
 PL Bruzdownik
 DE Nutenmeißel
 RU Зубило канавочное
 CZ Sekáč drážkovací
 HU Horonyvész
- RO Dalta canal
 FR Burin a entailler
 IT Scalpello per scanalature
 ES Cíncel acanalado
 CN 五坑蝴蝶凿



YATO 	L [mm]	
YT-47330	380	10/20



- EN Spade chisel
 PL Dłuto szerokie
 DE Spatmeißel
 RU Лопатка
 CZ Sekáč plochý
 HU Széles vész
- RO Daltă lată
 FR Burin plat large
 IT Scalpello largo
 ES Cíncel pala
 CN 五坑扁凿



YATO 	L [mm]	
YT-47336	400	10/20



- EN Spade chisel
 PL Dłuto szerokie
 DE Spatmeißel
 RU Лопатка
 CZ Sekáč plochý
 HU Széles vész
- RO Daltă lată
 FR Burin plat large
 IT Scalpello largo
 ES Cíncel pala
 CN 五坑扁凿



YATO 	L [mm]	
YT-47335	300	10/20



- EN Flat chisel
 PL Dłuto płaskie
 DE Spatmeißel
 RU Лопатка
 CZ Sekáč plochý
 HU Széles vész
- RO Daltă plată
 FR Burin plat large
 IT Scalpello piatto
 ES Cíncel pala
 CN 五坑扁凿



YATO 	L [mm]	
YT-47341	280	10/40



- EN Flat chisel
 PL Dłuto płaskie
 DE Spatmeißel
 RU Лопатка
 CZ Sekáč plochý
 HU Széles vész
- RO Daltă plată
 FR Burin plat large
 IT Scalpello piatto
 ES Cíncel pala
 CN 五坑扁凿



YATO 	L [mm]	
YT-47340	400	10/20



- EN Point chisel
 PL Dłuto szpicak
 DE Spitzmeißel
 RU Зубило пиковое
 CZ Špičák
 HU Hegyes vész
- RO Spit
 FR Burin pointu
 IT Scalpello a punta
 ES Cíncel punta
 CN 五坑尖凿



YATO 	L [mm]	
YT-47345	280	10/40

- EN Point chisel
 PL Dłuto szpicak
 DE Spitzmeißel
 RU Зубило пиковое
 CZ Špičák
 HU Hegyes vész
- RO Spit
 FR Burin pointu
 IT Scalpello a punta
 ES Cíncel punta
 CN 五坑尖凿



YATO 	L [mm]	
YT-47344	400	10/20

- EN Bushing tool
 PL Groszkownik
 DE Stockerplatte
 RU Отбойные пластины
 CZ Zdršňovací deska
 HU Szemcsészőlap
- RO Ciocan pt. degrosare
 FR Boucharde
 IT Bocciarda per martello
 ES Placa de abujardar
 CN 五坑花锥



YATO 	L [mm]	
YT-47348	240	5/10

EN Spade chisel
PL Dłuto szerokie
DE Spatmeißel
RU Широкое долото
CZ Sekáč plochý
HU Széles véső

RO Daltă lată
FR Burin plat large
IT Scalpello largo
ES Cincel pala
CN 六角扁凿

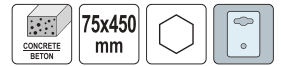

YATO 	L [mm]	
YT-47370	450	5/10

EN Spade chisel
PL Dłuto szerokie
DE Spatmeißel
RU Широкое долото
CZ Sekáč plochý
HU Széles véső

RO Daltă lată
FR Burin plat large
IT Scalpello largo
ES Cincel pala
CN 六角宽凿

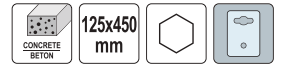



YATO 	L [mm]	
YT-47372	450	5

EN Point chisel
PL Dłuto szpiczak
DE Spitzmeißel
RU Зубило пиковое
CZ Špičák
HU Hegyes véső

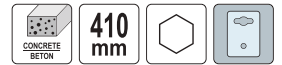
RO Spit
FR Burin pointu
IT Scalpello a punta
ES Cincel punta
CN 五坑尖凿





YATO 	L [mm]	
YT-47375	410	5/10

EN Flat chisel
PL Dłuto płaskie
DE Spatmeißel
RU Лопатка
CZ Sekáč plochý
HU Széles véső

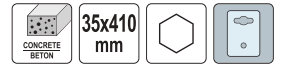
RO Daltă plată
FR Burin plat large
IT Scalpello piatto
ES Cincel pala
CN 五坑扁凿





YATO 	L [mm]	
YT-47377	410	5/10

EN Point chisel
PL Dłuto samoostrzące
DE Spitzmeißel
RU Зубило пиковое
CZ Špičák
HU Hegyes véső

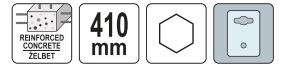
RO Spit
FR Burin pointu
IT Scalpello a punta autoaffilante
ES Cincel punta
CN 四刃凿子





YATO 	L [mm]	
YT-47380	410	5/10

EN Adapter
PL Adapter
DE Adapter
RU Адаптер

CZ Adaptér
HU Adapter
RO Adaptor
FR Adaptateur

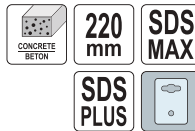
IT Adattatore
ES Adaptador
CN 五坑转换器



YATO 	L [mm]	
YT-41926	220	10/30

EN Ground rod chisel
PL Pobijak do uziomów i gwoździ
DE Erdstab-Treiber-Bit
RU Добойник для гвоздей
CZ Zatloukač uzemňovacích tyčí a hřebíků
HU Rudazatbeütő

RO Ciocan pt. bătut electrod împământare
FR Enfonceur de piquet de terre
IT Piantapicchetti per piantare chiodi e picchetti
ES Adaptador de varilla de tierra
CN 电镐圆孔凿





YATO 	L [mm]	
YT-47195	250	4/24

EN Plate compactor with hex shank
PL Ubijak do gruntu z uchwytem Hex
DE Stampfüsse Hex
RU Трамбовочная пластина
CZ Pěchovací deska Hex
HU Szerszámtartós tömörítőlap Hex

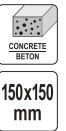
RO Compactor hexagonal
FR Plateau de damage Hex
IT Costipatore Hex per la compattazione di terra
ES Placa de apisonar Hex
CN 六角夯锤





YATO 	L [mm]	
YT-47385	150	2

EN Ground rod chisel
PL Pobijak do uziomów i gwoździ
DE Erdstab-Treiber-Bit
RU Добойник для гвоздей
CZ Zatloukač uzemňovacích tyčí a hřebíků
HU Rudazatbeütő

RO Ciocan pt. bătut electrod împământare
FR Enfonceur de piquet de terre
IT Piantapicchetti per piantare chiodi e picchetti
ES Adaptador de varilla de tierra
CN 电镐圆孔凿



YATO 	L [mm]	
YT-47197	400	4

- EN Hollow drill set
 PL Wiertło koronowe do betonu
 DE Bohrkronen
 RU Сверло корончатое по бетону
- CZ Korunový vrták na zeď
 HU Koronafúró falhoz
 RO Carotă pt. beton
 FR Trépiéd à mur
- IT Punta a corona per calcestruzzo
 ES Broca de corona para muro
 CN 扩孔钻

CONCRETE
 BETON

50 mm

M16

TCT
 YG11C

Cr50



YATO	Ø [mm]	Pilot drill diameter / Średnica wiertła pilota [mm]	
YT-4400	65	6	24
YT-4401	80	8	20

YATO	Ø [mm]	Pilot drill diameter / Średnica wiertła pilota [mm]	
YT-4402	65	6	24
YT-4403	80	8	20

- EN Masonry drill bit
 PL Wiertło do betonu
 DE Betonspiralbohrer
 RU Сверло по бетону
 CZ Vrták na beton
 HU Fúrósár betonhoz
- RO Burghiu pt. beton
 FR Foret béton
 IT Punta per cemento
 ES Broca para hormigón
 CN 四坑开孔器



CONCRETE
 BETON

55 mm

600 mm

SDS
 MAX

YATO	Ø [mm]	L [mm]	
YT-44045	55	600	2/8

- EN Hole saw
 PL Otwornica
 DE Lochsäge
 RU Универсальная коронка
 CZ Vrtací korunka
 HU Koronafúró
- RO Carotă
 FR Scie à trou
 IT Sega a tazza
 ES Sierra de corona universal
 CN TCT开孔器



PLYWOOD
 SKŁĘPKA

WOOD
 DREWNO

PVC

CERAMIC
 CERAMIKA

SAND-LIME BRICK
 SILIKAT

60 mm

YG6X

YATO	Ø [mm]	Thread size / Rozmiar gwintu	
YT-43970	16	1/2" (12.5 mm) 20UNF	6/90
YT-43971	19	1/2" (12.5 mm) 20UNF	6/90
YT-43972	22	1/2" (12.5 mm) 20UNF	6/90
YT-43973	25	1/2" (12.5 mm) 20UNF	6/90
YT-43974	32	5/8" (16.0 mm) 18UNF	6/72
YT-43975	38	5/8" (16.0 mm) 18UNF	6/72

YATO	Ø [mm]	Thread size / Rozmiar gwintu	
YT-43976	51	5/8" (16.0 mm) 18UNF	6/72
YT-43977	60	5/8" (16.0 mm) 18UNF	6/72
YT-43978	64	5/8" (16.0 mm) 18UNF	3/36
YT-43979	68	5/8" (16.0 mm) 18UNF	3/36
YT-43980	76	5/8" (16.0 mm) 18UNF	3/36
YT-43981	83	5/8" (16.0 mm) 18UNF	3/36

YATO	Ø [mm]	Thread size / Rozmiar gwintu	
YT-43982	92	5/8" (16.0 mm) 18UNF	2/36
YT-43983	102	5/8" (16.0 mm) 18UNF	2/36
YT-43984	105	5/8" (16.0 mm) 18UNF	2/36
YT-43985	127	5/8" (16.0 mm) 18UNF	2/20
YT-43986	152	5/8" (16.0 mm) 18UNF	2/20

- EN Bi-metal hole saw
 PL Otwornica bimetalowa
 DE Bimetall-Lochsäge
 RU Коронка биметаллическая
 CZ Vrtací korunka bimetalová
 HU Bi-metál koronafúró
 RO Carotă bimetalică
 FR Scie-trépan bimétal
 IT Sega a tazza bimetallica
 ES Sierra de corona bimetalica
 CN 双金属孔锯



CONCRETE
 BETON

BI-METAL

4-6
 TPI

40 mm

HSS
 M3



- Application: industry
- To drill holes in stainless steels, cast steels, aluminium, wood, plastics
- Cutting depth: 40 mm
- Przeznaczenie: przemysł
- Do wycinania otworów w stalach nierdzewnych, żeliwie, aluminium, drewnie, tworzywach sztucznych
- Głębokość cięcia: 40 mm

YATO	Ø [mm]	Thread size / Rozmiar gwintu	
YT-3303	19	1/2" (12.5 mm) 20UNF	25/100
YT-3304	20	1/2" (12.5 mm) 20UNF	25/100
YT-3306	22	1/2" (12.5 mm) 20UNF	25/100
YT-3308	25	1/2" (12.5 mm) 20UNF	25/100
YT-3311	29	1/2" (12.5 mm) 20UNF	25/100
YT-3313	32	5/8" (16.0 mm) 18UNF	25/100
YT-3315	35	5/8" (16.0 mm) 18UNF	25/100
YT-3317	38	5/8" (16.0 mm) 18UNF	25/100
YT-3318	40	5/8" (16.0 mm) 18UNF	25/100
YT-3321	44	5/8" (16.0 mm) 18UNF	25/100

YATO	Ø [mm]	Thread size / Rozmiar gwintu	
YT-3322	46	5/8" (16.0 mm) 18UNF	25/100
YT-3323	48	5/8" (16.0 mm) 18UNF	25/100
YT-3324	51	5/8" (16.0 mm) 18UNF	25/100
YT-3327	57	5/8" (16.0 mm) 18UNF	25/50
YT-3329	60	5/8" (16.0 mm) 18UNF	25/50
YT-3330	64	5/8" (16.0 mm) 18UNF	25/50
YT-3332	67	5/8" (16.0 mm) 18UNF	25/50
YT-3333	68	5/8" (16.0 mm) 18UNF	25/50
YT-3334	70	5/8" (16.0 mm) 18UNF	25/50
YT-3336	76	5/8" (16.0 mm) 18UNF	25/50

YATO	Ø [mm]	Thread size / Rozmiar gwintu	
YT-3338	83	5/8" (16.0 mm) 18UNF	25/50
YT-3343	95	5/8" (16.0 mm) 18UNF	25/50
YT-3345	102	5/8" (16.0 mm) 18UNF	10/20
YT-3346	105	5/8" (16.0 mm) 18UNF	10/20
YT-3349	114	5/8" (16.0 mm) 18UNF	10/20
YT-3350	121	5/8" (16.0 mm) 18UNF	10/20
YT-3351	127	5/8" (16.0 mm) 18UNF	10/20
YT-3353	140	5/8" (16.0 mm) 18UNF	10/20

- EN TCT hole saw for metal
PL Otwornica TCT do metalu
DE TCT Lochsäge für Metall
RU Кольцевая пила TCT по металлу
CZ Kruhový vrták TCT do kovu
HU TCT körkivágó fémhez
- RO Carota TCT pt. metal
FR Scie-trépan TCT pour le métal
IT Sega a tazza TCT per metallo
ES Sierra de corona TCT para metal
CN TCT金属开孔器

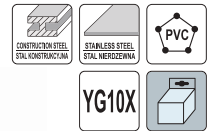

YATO	Ø [mm]	Hex	Box
YT-44050	16	1/4" (6.3 mm)	10/100
YT-44051	18	1/4" (6.3 mm)	10/100
YT-44052	19	1/4" (6.3 mm)	10/100
YT-44053	20	1/4" (6.3 mm)	10/100
YT-44054	22	1/4" (6.3 mm)	10/100
YT-44055	24	1/4" (6.3 mm)	10/100
YT-44056	25	1/4" (6.3 mm)	10/100
YT-44057	29	1/4" (6.3 mm)	10/100
YT-44058	30	1/4" (6.3 mm)	10/100

YATO	Ø [mm]	Hex	Box
YT-44059	32	1/4" (6.3 mm)	10/100
YT-44060	35	1/4" (6.3 mm)	10/100
YT-44061	38	1/4" (6.3 mm)	10/100
YT-44062	40	1/4" (6.3 mm)	10/100
YT-44063	44	3/8" (10.0 mm)	6/60
YT-44064	45	3/8" (10.0 mm)	6/60
YT-44065	50	3/8" (10.0 mm)	6/60
YT-44066	51	3/8" (10.0 mm)	6/60
YT-44067	54	3/8" (10.0 mm)	6/60

YATO	Ø [mm]	Hex	Box
YT-44068	55	3/8" (10.0 mm)	6/60
YT-44069	60	3/8" (10.0 mm)	6/60
YT-44070	65	3/8" (10.0 mm)	6/48
YT-44071	70	3/8" (10.0 mm)	6/48
YT-44072	80	3/8" (10.0 mm)	4/24
YT-44073	90	3/8" (10.0 mm)	4/24
YT-44074	102	3/8" (10.0 mm)	4/24

- EN Arbor for hole saw
PL Uchwyt do otwornic
DE Halterung für Lochsagen
RU Держатель универсальных коронок
CZ Sroubový unášec pro vrtací korunky
HU Befogószer a koronafúróhoz

- RO Burghiu de ghidare pt. carote bimetalice
FR Mandrin aux scies-trépan
IT Alberino per seghe a tazza
ES Adaptador para sierra de corona
CN 孔锯柄轴

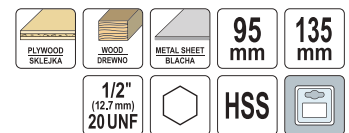

YATO	Ø [mm]	Toolholder type / Rodzaj uchwytu narzędziowego	Thread size / Rozmiar gwintu	Box
YT-43992	6	HEX	1/2" (12.5 mm) 20UNF	20/100

- EN Arbor for hole saw
PL Uchwyt do otwornic
DE Halterung für Lochsagen
RU Держатель универсальных коронок
CZ Sroubový unášec pro vrtací korunky
HU Befogószer a koronafúróhoz

- RO Burghiu de ghidare pt. carote bimetalice
FR Mandrin aux scies-trépan
IT Alberino per seghe a tazza
ES Adaptador para sierra de corona
CN 孔锯柄轴

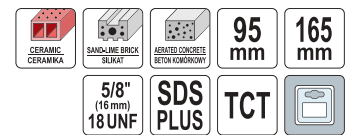

YATO	Ø [mm]	Toolholder type / Rodzaj uchwytu narzędziowego	Thread size / Rozmiar gwintu	Box
YT-43990	8	SDS-Plus	5/8" (16.0 mm) 18UNF	10/90

- EN Arbor for hole saw
PL Uchwyt do otwornic
DE Halterung für Lochsagen
RU Держатель универсальных коронок
CZ Sroubový unášec pro vrtací korunky
HU Befogószer a koronafúróhoz

- RO Burghiu de ghidare pt. carote bimetalice
FR Mandrin aux scies-trépan
IT Alberino per seghe a tazza
ES Adaptador para sierra de corona
CN 孔锯柄轴

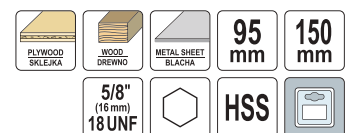

YATO	Ø [mm]	Toolholder type / Rodzaj uchwytu narzędziowego	Thread size / Rozmiar gwintu	Box
YT-43991	6	HEX	5/8" (16.0 mm) 18UNF	10/90

- EN Extension bar
PL Przedłużka
DE Verlängerung
RU Удлинитель для воротка
CZ Prodlužovací příravek
HU Toldalék
- RO Prelungitor
FR Rallonge
IT Prolunga
ES Tubo de prolongación
CN 延长接杆

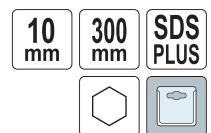

YATO	Toolholder type / Rodzaj uchwytu narzędziowego	H [mm]	Box
YT-43993	sześciokątny, SDS-Plus	300	10/50

- EN Pilot drill
PL Wiertło pilot
DE Pilotbohrer
RU Сверло пилот
CZ Středící vrták
HU Központfúró
- RO Burghiu pilot
FR Foret - pilot
IT Punta pilota
ES Broca piloto
CN 导向钻



YATO	Ø [mm]	H [mm]	Box
YT-43994	6	95	50/250

- EN Pilot drill
PL Wiertło pilot
DE Pilotbohrer
RU Сверло пилот
CZ Středící vrták
HU Központfúró
- RO Burghiu pilot
FR Foret - pilot
IT Punta pilota
ES Broca piloto
CN 导向钻

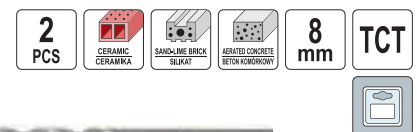

YATO	Ø [mm]	H [mm]	Box
YT-43995	8	95	50/250

EN Arbor for hole saw
 PL Uchwyt do otwornic
 DE Halterung für Lochsägen
 RU Держатель коронок
 CZ Šroubový unášec pro vrtací korunky
 HU Befogószer a koronafúróhoz
 RO Burghiu de ghidare pt. carote bimetalice
 FR Mandrin aux scies-trépan
 IT Alberino per seghe a tazza
 ES Adaptador para sierra de corona
 CN 孔锯柄轴



YATO	Toolholder type / Rodzaj uchwytu narzędziowego	
YT-3370	sześciokątny	25/100
YT-3373	SDS-Plus	25/100

EN Arbor for hole saw
 PL Uchwyt do otwornic
 DE Halterung für Lochsägen
 RU Держатель коронок
 CZ Šroubový unášec pro vrtací korunky
 HU Befogószer a koronafúróhoz
 RO Burghiu de ghidare pt. carote bimetalice
 FR Mandrin aux scies-trépan
 IT Alberino per seghe a tazza
 ES Adaptador para sierra de corona
 CN 孔锯柄轴

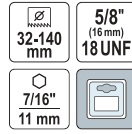

YATO	Toolholder type / Rodzaj uchwytu narzędziowego	
YT-3371	sześciokątny	25/100

EN Arbor for hole saw
 PL Uchwyt do otwornic
 DE Halterung für Lochsägen
 RU Держатель коронок
 CZ Šroubový unášec pro vrtací korunky
 HU Befogószer a koronafúróhoz
 RO Burghiu de ghidare pt. carote bimetalice
 FR Mandrin aux scies-trépan
 IT Alberino per seghe a tazza
 ES Adaptador para sierra de corona
 CN 孔锯柄轴



YATO	Toolholder type / Rodzaj uchwytu narzędziowego	
YT-3372	sześciokątny	25/50
YT-3374	SDS-Plus	25/50

EN Pilot drill
 PL Wiertło pilot
 DE Pilotbohrer
 RU Сверло пилот

CZ Středící vrták
 HU Központfúró
 RO Burghiu pilot

IT Punta pilota
 ES Broca piloto
 CN 导向钻
 FR Foret - pilot



EN Electrician's hole saw kit
 PL Zestaw otwornic dla elektryków
 DE Lochsägensatz für Elektriker
 RU Набор ножовок к отверстиям для электриков
 CZ Sada vrtacích korunek pro elektřikáře
 HU Koronafúró készlet villanyszerelőknél
 RO Set freze bimetalice
 FR Set de scies-trépan aux électriciens
 IT Set universale a tazza fresa con strumenti
 ES Juego de sierras de marquetería para electricistas
 CN 双金属开孔器组套

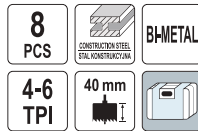

YATO	Ø [mm]	
YT-3380	22, 29, 35, 44, 67, 73	10

EN Combination hole saw kit
 PL Uniwersalny zestaw otwornic
 DE Universal-Lochsägensatz
 RU Универсальный набор ножовок к отверстиям
 CZ Univerzální sada vrtacích korunek
 HU Univerzális koronafúró készlet
 RO Set freze bimetalice
 FR Set de scies-trépan universelles
 IT Set universale a tazza fresa con strumenti
 ES Juego universal de sierras de marquetería
 CN 双金属开孔器组套

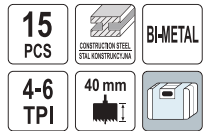

YATO	Ø [mm]	
YT-3377	6	25/100

EN TCT hole saw set
 PL Zestaw otwornic TCT do metalu
 DE TCT Lochsägeset für Metall
 RU Набор кольцевых пил TCT по металлу
 CZ Sada korunkových vrtáků TCT do kovu
 HU TCT körkivágó készlet fémhez
 RO Set carote TCT
 FR Ensemble de scies-trépan TCT pour le métal
 IT Kit di seghe a tazza TCT per metallo
 ES Juego de sierras de corona TCT para metal
 CN TCT金属开孔器组套



YATO	Ø [mm]	
YT-44077	22, 30, 35, 45, 50, 65	12

EN Combined drill tap
PL Wiertło-gwintownik
DE Gewindebohrer Bit
RU Сверло метчик
CZ Bitový kombinovaný závitník
HU Fűrő-menetfűrő bit befogású

RO Burghiu tarod Hex
FR Fraise à tarauds combinés
IT Punta madreviti
ES Broca roscadora Hex
HU Fűrő-menetfűrő bit befogású

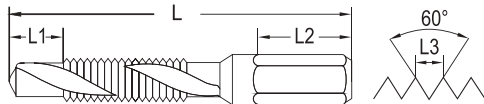
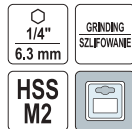

YATO	Size / Rozmiar	L [mm]	L1 [mm]	L2 [mm]	L3 [mm]	
YT-44840	M3	36	5	14	0.5	20/200
YT-44841	M4	39	6	14	0.7	20/200
YT-44842	M5	41	7	14	0.8	20/200
YT-44843	M6	44	8	14	1.0	20/200
YT-44845	M8	51	11	14	1.3	20/200
YT-44847	M10	59	15	14	1.5	20/200

EN Hand tap
PL Gwintownik ręczny
DE Handgewindebohrer
RU Ручный метчик
CZ Závitník
HU Menetfűrő

RO Tarozii
FR Tarauds à main
IT Maschi filettatura a mano
ES Machos de roscar
CN 三件套手用丝锥

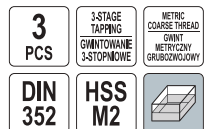

YATO	Size / Rozmiar	Thread pitch / Skok gwintu [mm]	Thread length / Długość gwintu [mm]	L [mm]	Shank diameter / Średnica trzonu [mm]	pcs / szt.	m [g]	
YT-2930	M3	0.5	11	40	3.5	3	25	50/200
YT-2931	M4	0.7	13	45	4.5	3	35	50/200
YT-2932	M5	0.8	16	50	6.0	3	45	60/240
YT-2933	M6	1.0	19	50	6.0	3	45	60/240
YT-2934	M7	1.0	19	50	6.0	3	55	75/300
YT-2935	M8	1.3	22	56	6.0	3	60	50/200
YT-2937	M10	1.5	24	70	7.0	3	85	50/200
YT-2939	M12	1.8	29	75	9.0	3	125	50/200
YT-2940	M14	2.0	30	80	10.5	3	200	20/80
YT-2941	M16	2.0	32	80	11.0	3	235	20/80
YT-2942	M18	2.5	40	95	12.0	3	345	20/80
YT-2943	M20	2.5	40	95	14.0	3	445	10/40

EN Machine tap
PL Gwintownik maszynowy
DE Maschinengewindebohrer
RU Машинный метчик
CZ Strojní závitník
HU Gépi menetfűrő

RO Tarod
FR Tarauds machine
IT Maschi filettatura
ES Macho mecanico
CN 机用丝锥

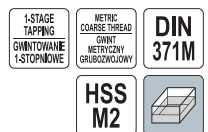

YATO	Size / Rozmiar	Thread pitch / Skok gwintu [mm]	Thread length / Długość gwintu [mm]	L [mm]	Shank diameter / Średnica trzonu [mm]	m [g]	
YT-2950	M3	0.5	11	56	3.5	15	100/400
YT-2951	M4	0.7	13	63	4.5	20	60/240
YT-2952	M5	0.8	16	70	6.0	25	60/240
YT-2953	M6	1.0	19	80	6.0	30	50/200
YT-2954	M7	1.0	19	80	7.1	35	30/120
YT-2955	M8	1.3	22	90	8.0	45	50/200
YT-2956	M10	1.5	24	100	10.0	65	50/200

EN Machine tap
PL Gwintownik maszynowy
DE Maschinengewindebohrer
RU Машинный метчик
CZ Strojní závitník
HU Gépi menetfűrő

RO Tarod
FR Tarauds machine
IT Maschi filettatura
ES Macho mecanico
CN 机用丝锥



YATO	Size / Rozmiar	Thread pitch / Skok gwintu [mm]	Thread length / Długość gwintu [mm]	L [mm]	Shank diameter / Średnica trzonu [mm]	m [g]	
YT-2944	M12	1.8	29	110	9	70	25/100
YT-2945	M14	2.0	30	110	11	110	25/100
YT-2946	M16	2.0	32	110	12	120	25/100



1/4" (6.3 mm)

YATO	Size / Rozmiar	
YT-44849	M3, M4, M5, M6, M8, M10	5/60

EN Tap and die set
 PL Zestaw narzynek i gwintowników
 DE Gewindeschneidwerkzeug-Satz
 RU Набор плашек и метчиков
 CZ Sada závitníků a závitových oček
 HU Menefűrő és menetmetsző készlet
 RO Set de tarozi și filiere
 FR Jeu de tarauds et filières
 IT Set di maschi e filiere
 ES Juego de machos de roscar y cojinetes
 CN 丝锥板牙组套

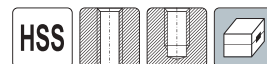

32
PCS

DIN
223
352

YATO	Size / Rozmiar	
YT-2975	M3, M4, M5, M6, M8, M10, M12	10



44
PCS

DIN
223
225
338
352
1814



YATO	Size / Rozmiar	
YT-2978	M3, M4, M5, M6, M8, M10, M12	4



56
PCS

DIN
223
225
352
1814

YATO	Size / Rozmiar	
YT-2979	M3, M4, M5, M6, M8, M10, M12, M14, M16, M18, M20	2

EN Tap set
 PL Zestaw gwintowników
 DE Gewindeschneidwerkzeug-Satz
 RU Набор метчиков

CZ Souprava závitníků
 HU Menefűrő készlet
 RO Set de tarozi
 FR Jeu de tarauds

IT Set di maschi
 ES Juego de machos de roscar
 CN 公制丝锥组套

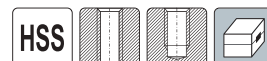

21
PCS

DIN
352

YATO	Size / Rozmiar	
YT-2976	M3, M4, M5, M6, M8, M10, M12	20



29
PCS

DIN
338
352
1814



YATO	Size / Rozmiar	
YT-2977	M3, M4, M5, M6, M8, M10, M12	12

EN Circular die
 PL Narzynka
 DE Schneideisen
 RU Плашка

CZ Kruhová závitová čelist
 HU Menetvágó
 RO Filieră
 FR Filière

IT Filiere tonde filettatura
 ES Cojinete de roscar
 CN 圆板牙

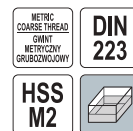

YATO	Size / Rozmiar	Thread pitch / Skok gwintu [mm]	External diameter / Średnica zewnętrzna [mm]	Thickness / Grubość [mm]	m [g]	
YT-2961	M4	0.7	20	5	20	125/500
YT-2962	M5	0.8	20	7	20	100/200
YT-2963	M6	1.0	20	7	20	100/400
YT-2964	M7	1.0	25	9	35	100/200
YT-2965	M8	1.3	25	9	35	100/400
YT-2967	M10	1.5	30	11	50	70/280
YT-2969	M12	1.8	38	14	90	60/240
YT-2970	M14	2.0	38	14	95	63/252
YT-2971	M16	2.0	45	18	160	50/200
YT-2973	M20	2.5	45	18	150	50/200
YT-2966	M24	3.0	55	22	300	20/80

EN Step drill
PL Wiertło stopniowe
DE Stufenbohrer
RU Сверло ступенчатое
CZ Stupňovitý vrták
HU Lépcsős fúró

RO Burghiu in trepte
FR Foret étagé
IT Punta a gradini
ES Broca cónica escalonada
CN 阶梯钻

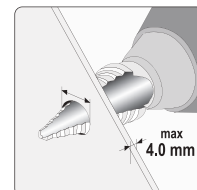

YATO	Steps quantity / Liczba stopni	Ø [mm]	L [mm]	Working length / Długość robocza [mm]	
YT-44743	7	14, 16, 18, 20, 22, 24, 26	70	40	100
YT-44742	8	10, 15, 20, 25, 30, 35, 40, 45	100	75	40
YT-44741	10	4, 6, 8, 10, 12, 14, 16, 18, 20, 22	75	52	25/50
YT-44739	10	6, 10, 13, 16, 19, 22, 25, 29, 32, 35	75	45	10/80
YT-44744	10	6, 12, 13, 14, 15, 16, 17, 18, 19, 20	75	55	20/200
YT-44745	11	10, 11, 12, 13, 14, 15, 16, 17, 18, 19, 20	75	52	20/200
YT-44747	11	20, 21, 22, 23, 24, 25, 26, 27, 28, 29, 30	75	54	12/96
YT-44746	12	10, 20, 21, 22, 23, 24, 25, 26, 27, 28, 29, 30	87	60	12/96
YT-44740	12	6, 8, 11, 14, 17, 20, 23, 26, 29, 32, 35, 38	105	78	10/60

EN Step drill set
PL Zestaw wiertel stopniowych
DE Stufenbohrer Set
RU Набор ступенчатых сверл
CZ Sada stupňovitých vrtáků
HU Lépcsős fúró készlet
RO Set burghie in trepte
FR Jeu de forets étagés
IT Set di punte a gradino
ES Juego de brocas cónicas escalonadas
CN 阶梯钻组套

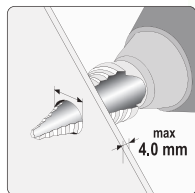

YATO	Ø [mm]	
YT-44731	3-12 (3, 4, 5, 6, 7, 8, 9, 10, 11, 12 mm), 4-12 (4, 6, 8, 10, 12 mm), 4-20 (4, 6, 8, 10, 12, 14, 16, 18, 20 mm)	40

EN Taper drill set
PL Zestaw wiertel stożkowych
DE Blechschräbbohrer-Satz
RU Набор ступенчатых сверл
CZ Sada kuželových vrtáků do plechu
HU Rézsés lemezfúró készlet
RO Set alezoare
FR Set de perceuse taper
IT Set di punte coniche
ES Conjunto brocas cónicas
CN 薄板钻

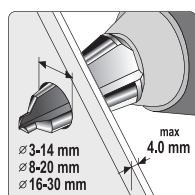
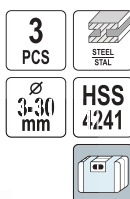

YATO	Ø [mm]	
YT-44730	3-14, 8-20, 16-30	10/30

EN Step drill set
PL Zestaw wiertel stopniowych
DE Stufenbohrer Set
RU Набор ступенчатых сверл
CZ Sada stupňovitých vrtáků
HU Lépcsős fúró készlet
RO Set burghie in trepte
FR Jeu de forets étagés
IT Set di punte a gradino
ES Juego de brocas cónicas escalonadas
CN 阶梯钻组套

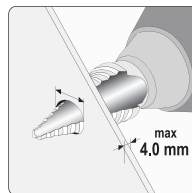

YATO	Ø [mm]	
YT-44732	4-12 (4, 6, 8, 10, 12 mm), 4-22 (4, 6, 8, 10, 12, 14, 16, 18, 20, 22 mm), 6-38 (6, 8, 11, 14, 17, 20, 23, 26, 29, 32, 35, 38 mm)	6/24

EN Countersink
PL Pogłębiacz
DE Kegelsenker
RU Конусный зенкер
CZ Kuželový záhlubník
HU Kúpos süllyesztő

RO Zencuitor
FR Fraise conique
IT Accetatoio
ES Avellanador cónico
CN 倒角器

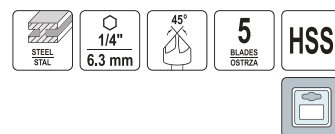

YATO	Ø [mm]	L [mm]	
YT-44721	6.3	40	50/200
YT-44722	8.3	40	50/200
YT-44723	10.4	40	50/200
YT-44724	12.4	40	50/200
YT-44725	16.5	45	25/100
YT-44726	20.5	45	25/100

- EN Countersink set
- PL Zestaw pogłębiaczy do metalu
- DE Kegelsenker-Satz
- RU Конусный зенкер
- CZ Kuželový záhlubník
- HU Kúpos süllyesztő
- RO Zencuitor
- FR Fraise conique
- IT Set di svasatori per metallo
- ES Avellanador cónico
- CN 倒角器组套



6 PCS

1/4" 6.3 mm

5 BLADES OSTRZA **HSS**

- EN T-handle tap wrench
- PL Pokręto typu „T” do gwintowników
- DE Gewinde-Werkzeughalter
- RU Рукотка типа „Т” к гаечному ключу
- CZ Vratidlo na závitníky typ „T”
- HU Menetfűró befogó T-nyelű
- RO Port tarod cu maner
- FR Porte-taraud type „T”
- IT Chiave giramaschio tipo „T” per maschi
- ES Llave giramachos „T”
- CN 丝锥扳手



YATO	Size / Rozmiar	L [mm]	
YT-2986	M3-M8	70	20/80
YT-2987	M5-M10	80	20/80
YT-2988	M6-M12	90	20/80

- EN Ratchet tap wrench
- PL Grzechotka do gwintownika
- DE Gewinde-Werkzeughalter
- RU Трещетка для метчика
- CZ Ráčnové vratidlo pro závitníky
- HU Racsnis hajtószer menetfűróhoz
- RO Port tarod cu clichet
- FR Porte-taraud à cliquet
- IT Chiave giramaschi a cricchetto
- ES Carraca para macho de roscar
- CN 棘轮丝锥扳手



- EN Die handle
- PL Oprawa do narzynek
- DE Schneisenhalter
- RU Пляшкодержатель
- CZ Závitová objímka
- HU Menetvágó tartó
- RO Port filieră
- FR Porte-filière
- IT Porta filiere
- ES Portacojinete
- CN 板牙扳手

DIN 225



YATO	Size / Rozmiar	External diameter / Średnica zewnętrzna [mm]	Thickness / Grubość [mm]	L [mm]	
YT-2980	M3-M4	20	5	200	25/100
YT-2981	M4.5-M6	20	7	200	25/100
YT-2982	M7-M9	25	9	224	25/100
YT-2983	M10-M11	30	11	280	25/50
YT-2984	M12-M14	38	14	315	15/30
YT-2985	M16-M20	45	18	450	10/20

- EN Tap wrench
- PL Pokręto do gwintowników
- DE Gewinde-Werkzeughalter
- RU Вороток для метчиков
- CZ Ovládací kolečko na závitník
- HU Hajtószer menetfűróhoz
- RO Port tarod
- FR Porte-taraud
- IT Manopola per il maschio
- ES Llave giramachos
- CN 一型丝锥扳手



DIN 1814



YATO	Size / Rozmiar	L [mm]	
YT-2995	M1-M8	125	50/200
YT-2996	M3-M10	180	25/100
YT-2992	M3-M12	200	25/100
YT-2993	M4-M12	280	25/100
YT-2994	M5-M20	375	20/40

- EN Forstner drill bit and plug cutter
- PL Flekownik-sekownik do drewna
- DE Zapfenschneider und Forstnerbohrer für Holz
- RU Сверло и пробочник по дереву
- CZ Kotočový vykrajovač-sukovník do dřeva
- HU Csapmaró-fűró szerszám fához
- RO Set freze pt. cepuri lemn
- FR Ensemble pour réparation des nœuds dans le bois
- IT Punta forstner per legno
- ES Broca fresadora para madera
- CN 木塞钻和平翼钻组套

2 PCS

HRC 45-48

- EN Forstner drill bit and plug cutter set
- PL Zestaw flekowników-sekowników do drewna
- DE Zapfenschneider und Forstnerbohrer-Set für Holz
- RU Комплект пробочников и сверл по дереву
- CZ Sada kotočových vykrajovačů-sukovníků do dřeva
- HU Csapmaró-fűró szerszámkészlet fához
- RO Set freze pt. cepuri lemn
- FR Ensemble pour réparation des nœuds dans le bois
- IT Set di punte forstner per legno
- ES Juego de brocas fresadoras para madera
- CN 木塞钻和平翼钻组套

10 PCS

8,10 mm 10,12 mm

HRC 45-48

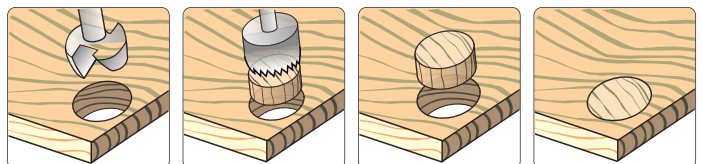

YATO	Ø [mm]	
YT-33837	15, 20, 25, 30, 35	20

EN Rotary rasp
PL Tarnik trzpieniowy
DE Profilraspel

RU Фреза-рашпиль
CZ Rotační rašple
HU Csiszolófej

RO Freză
FR Râpe rotative
IT Raspa rotativa

ES Escofina
CN 旋转锉

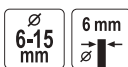
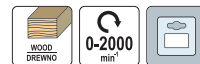

YATO	Ø [mm]	
YT-61703	6-15	10/120

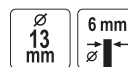

YATO	Ø [mm]	
YT-61704	13	10/120

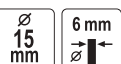

YATO	Ø [mm]	
YT-61705	15	10/120

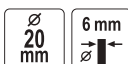

YATO	Ø [mm]	
YT-61706	20	10/120



YATO	Ø [mm]	
YT-61707	25	10/120

EN Rotary rasp for wood
PL Tarnik trzpieniowy do drewna
DE Holzraspel

RU Фреза-рашпиль по дереву
CZ Rotační rašple na dřevu
HU Fagmunkáló csiszolófej

RO Freză pt. lemn
FR Râpe à bois
IT Raspa rotativa per legno

ES Escofina para madera
CN 木工旋转锉

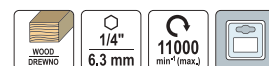

YATO	Ø [mm]	
YT-61740	15	100/200



YATO	Ø [mm]	
YT-61741	16	100/200



YATO	Ø [mm]	
YT-61742	16	100/200



YATO	Ø [mm]	
YT-61743	16	100/200

EN Rotary file for metal
PL Frez trzpieniowy do metalu
DE Metall-Fräser
RU Фрез по металлу

CZ Hrotová rašple na kov
HU Rotációs maró fémhez
RO Freză pt. metal
FR Fraise rotative à métal

IT Fresa rotativa per metallo
ES Fresa rotativa para metal
CN 金属旋转锉

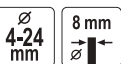

YATO	Ø [mm]	
YT-61700	4-24	10/120

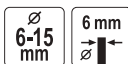

YATO	Ø [mm]	
YT-61701	6-15	10/120

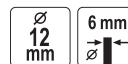

YATO	Ø [mm]	
YT-61702	12	10/120

EN Rotary file for metal
PL Frez trzpieniowy do metalu
DE Metall-Fräser
RU Фрез по металлу

CZ Hrotová rašple na kov
HU Rotációs maró fémhez
RO Freză pt. metal
FR Fraise rotative à métal

IT Fresa rotativa per metallo
ES Fresa rotativa para metal
CN 金属旋转锉

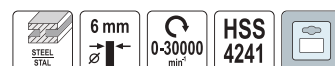

YATO	Ø [mm]	
YT-61714	13	80



YATO	Ø [mm]	
YT-61715	13	80



YATO	Ø [mm]	
YT-61716	13	80



YATO	Ø [mm]	
YT-61717	13	80





YATO	Ø [mm]	
YT-61718	13	80





YATO	Ø [mm]	
YT-61719	6	80



EN Rotary file set
 PL Zestaw frezów trzpieniowych
 DE Fräser Satz
 RU Набор фрез
 CZ Hrotové rašple
 HU Rotációs maró készlet
 RO Set freze
 FR Jeu de fraises rotatives
 IT Set di frese rotative
 ES Juego de fresas
 CN 旋转锉







6 PCS	 STEEL STEEL	\varnothing 3-12 mm
6 mm \varnothing	 0-30000 min ¹	HSS 4241
		

YATO 	\varnothing [mm]	
YT-61711	3-15	12/48





EN Rotary file for metal
 PL Frez trzpieniowy do metalu
 DE Metall-Fräser
 RU Фрез по металлу
 CZ Hrotová rašple na kov
 HU Rotációs maró fémhez
 RO Freză pt. metal
 FR Fraise rotative à métal
 IT Fresa rotativa per metallo
 ES Fresa rotativa para metal
 CN 金属旋转锉

 STEEL STEEL	\varnothing 1/4" 6.3 mm	 11000 min ¹ (max.)	
--	------------------------------	--	---









\varnothing 15 mm	YATO 	\varnothing [mm]		YATO 	\varnothing [mm]	
	YT-61750	15	100/200	YT-61751	11	100/200







EN Rotary file for metal
 PL Frez trzpieniowy do metalu
 DE Metall-Fräser
 RU Фрез по металлу
 CZ Hrotová rašple na kov
 HU Rotációs maró fémhez
 RO Freză pt. metal
 FR Fraise rotative à métal
 IT Fresa rotativa per metallo
 ES Fresa rotativa para metal
 CN 金属旋转锉

 STEEL STEEL	\varnothing 10 mm	6 mm \varnothing	
 0-30000 min ¹	TUNGSTEN CARBIDE WEGLIK WOLFRAMU		





\varnothing 56 mm	YATO 	\varnothing [mm]		YATO 	\varnothing [mm]		YATO 	\varnothing [mm]	
	YT-61722	10	40/80	YT-61723	10	40/80	YT-61724	10	40/80





\varnothing 45 mm	YATO 	\varnothing [mm]		YATO 	\varnothing [mm]		YATO 	\varnothing [mm]	
	YT-61725	10	40/80	YT-61726	10	40/80	YT-61727	10	40/80

EN Rotary file set for metal premium
 PL Zestaw frezów trzpieniowych do metalu premium
 DE Metall-Fräser Premium
 RU Набор фрез по металлу премиум
 CZ Hrotové rašple na kov premium
 HU Rotációs maró készlet fémhez prémium
 RO Set freze pt. metal
 FR Jeu de fraises rotatives pour métal premium
 IT Set di frese rotative per metallo premium
 ES Fresas para metal premium
 CN 硬质合金旋转锉



6 PCS	 STEEL STEEL	\varnothing 10 mm
6 mm \varnothing	 0-30000 min ¹	TUNGSTEN CARBIDE WEGLIK WOLFRAMU
		

YATO 	\varnothing [mm]	L [mm]	
YT-61729	10	45, 50, 56, 58, 58	20/40

- EN Rotary rasp set
PL Zestaw tarników trzpieniowych
DE Profiliraspel-Satz
RU Набор борфрез
CZ Sada rotačních rašplí
HU Csiszolófej készlet
RO Set freze
FR Jeu de râpes
IT Set di raspe rotative
ES Juego de escofinas
CN 旋转锉组套

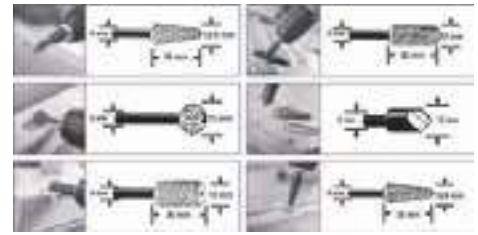

YATO	Ø [mm]	
YT-61712	6-15	10/60

- EN Rotary rasp set for wood
PL Zestaw tarników do drewna
DE Holzraspel-Set
RU Набор фрез-рашпиль по дереву
CZ Sada rotačních rašplí na dřevo
HU Famegmunkáló csiszolófej készlet
RO Set freze pt. lemn
FR Jeu de râpes à bois
IT Set di raspe rotative per legno
ES Juego de escofinas para madera
CN 旋转锉组套

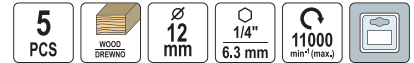

YATO	Ø [mm]	
YT-61747	12	50/100

- EN Spherical rotary rasp
PL Tarnik kulisty
DE Kugelraspel
RU Фреза-рашпиль шаровый
CZ Kulová rotační rašple
HU Gómb alakú csiszolófej
RO Freză sferică
FR Râpe sphérique
IT Raspa sferica
ES Escofina esférica
CN 旋转锉

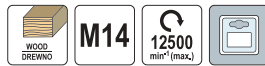

YATO	Ø [mm]	
YT-61770	20	24/48
YT-61771	40	20/40

- EN Cylindrical rotary rasp
PL Tarnik cylindryczny
DE Zylinderraspel
RU Фреза-рашпиль цилиндрический
CZ Válcová rotační rašple
HU Henger alakú csiszolófej
RO Freză cilindrică
FR Râpe cylindrique
IT Raspa cilindrica
ES Escofina cilíndrica
CN 旋转锉

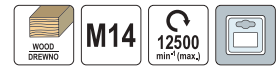

YATO	Ø [mm]	
YT-61772	20	50/100
YT-61773	30	50/100

- EN Forstner drill bit
PL Wiertło do drewna pod zawiasy
DE Forstnerbohrer
RU Сверло форстнера по дереву
CZ Karbidový vrták na vrtání otvorů pro závěsy
HU Forstner fúrószár fához
RO Freza pt. lemn
FR Mèche de perceuse à bois
IT Punta per legno per cerniere
ES Broca para bisagras
CN 木工开孔器



YATO	Ø [mm]	
YT-33010	26	10/100
YT-33011	35	10/100

- EN Forstner drill bit set
PL Zestaw wiertła do drewna pod zawiasy
DE Forstnerbohrer Set
RU Набор сверл форстнера по дереву
CZ Sada karbidový vrták na vrtání otvorů pro závěsy
HU Forstner fúrószár készlet fához
RO Set freze pt. lemn
FR Mèches de perceuse à bois
IT Set di punte per legno per cerniere
ES Juego de brocas para bisagras
CN 木工开孔器组套



YATO	Ø [mm]	
YT-33015	15, 20, 26, 30, 35	20

EN Mini rotary file set
 PL Zestaw frezów do miniszlifierek
 DE Fräseset für Minischleifmaschine
 RU Набор фрез для гравера
 CZ Sada fréz pro mini brusky
 HU Mini köszörű felsőmaró készlet
 RO Set freze pt. mini freză
 FR Jeu de fraises pour mini meuleuse
 IT Kit di frese per mini smerigliatrici
 ES Juego de fresas para miniamoladoras
 CN 旋转锉组套

10 PCS
 METAL
 WOOD DRESSING
 PVC
 3.2 mm
 0-12000 min⁻¹
 HSS 4241
 TITANIUM COATED POWŁOKA TYTANOWA



YATO
 YT-61730 30/120

EN Accessories for mini grinders
 PL Zestaw akcesoriów do miniszlifierek
 DE Zubehör-Set für Minischleifmaschine
 RU Набор аксессуаров для гравера
 CZ Sada příslušenství pro mini brusky
 HU Mini köszörű tartozék készlet
 RO Set accesorii de șlefuit pt. mini freză
 FR Accessoires pour mini meuleuse
 IT Kit di accessori per mini smerigliatrici
 ES Juego de accesorios para miniamoladoras
 CN 电磨附件组套

157 PCS
 3.2 mm
 2.3 mm
 3.2 mm



YATO
 YT-34670 16

EN Router bit set
 PL Zestaw frezów do drewna
 DE Oberfräsersatz
 RU Набор фрез по дереву
 CZ Sada fréz do dřeva
 HU Faipari marókész készlet
 RO Set de freze pt. lemn
 FR Jeu de fraises à bois
 IT Set di frese per legno
 ES Juego de fresas para madera
 CN 木工铣刀组套

6 PCS
 +/- 0.08 mm
 6 mm
 YG6X

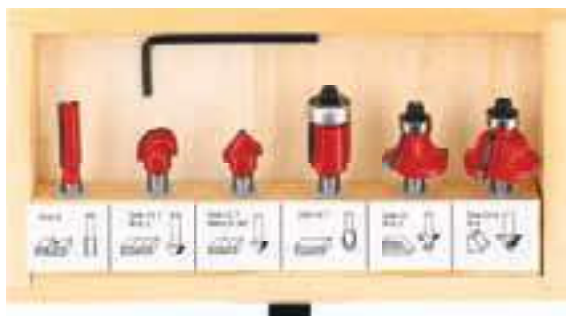

YATO
 YT-68000 50

EN Mini rotary file set
 PL Zestaw frezów do miniszlifierek
 DE Fräseset für Minischleifmaschine
 RU Набор фрез для гравера
 CZ Sada fréz pro mini brusky
 HU Mini köszörű felsőmaró készlet
 RO Set freze pt. mini freză
 FR Jeu de fraises pour mini meuleuse
 IT Kit di frese per mini smerigliatrici
 ES Juego de fresas para miniamoladoras
 CN 旋转锉组套

10 PCS
 METAL
 3.2 mm
 0-12000 min⁻¹
 HSS 4241



YATO
 YT-61731 30/120

EN Accessories for mini grinders
 PL Zestaw akcesoriów do miniszlifierek
 DE Zubehör-Set für Minischleifmaschine
 RU Набор аксессуаров для гравера
 CZ Sada příslušenství pro mini brusky
 HU Mini köszörű tartozék készlet
 RO Set accesorii de șlefuit pt. mini freză
 FR Accessoires pour mini meuleuse
 IT Kit di accessori per mini smerigliatrici
 ES Juego de accesorios para miniamoladoras
 CN 电磨附件组套

201 PCS
 3.2 mm
 2.3 mm
 3.2 mm



YATO
 YT-34671 10

EN Router bit set
 PL Zestaw frezów do drewna
 DE Oberfräsersatz
 RU Набор фрез по дереву
 CZ Sada fréz do dřeva
 HU Faipari marókész készlet
 RO Set de freze pt. lemn
 FR Jeu de fraises à bois
 IT Set di frese per legno
 ES Juego de fresas para madera
 CN 木工铣刀组套

6 PCS
 +/- 0.08 mm
 8 mm
 YG6X

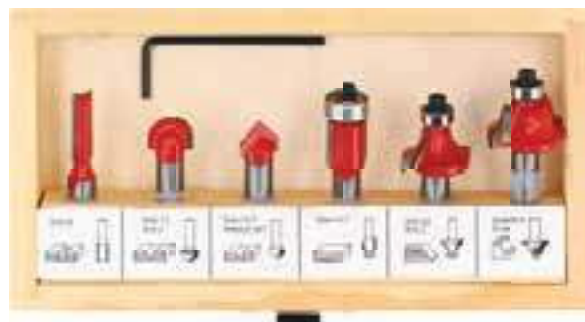

YATO
 YT-68001 50

EN Router bit set
PL Zestaw frezów do drewna
DE Oberfrärsersatz
RU Набор фрез по дереву

CZ Sada fréz do dřeva
HU Faipari marókés készlet
RO Set de freze pt. lemn
FR Jeu de fraises à bois

IT Set di frese per legno
ES Juego de fresas para madera
CN 木工铣刀组套



Router bit parameter												
shank diameter / średnica uchwyty [mm]	6.0	6.0	6.0	6.0	6.0	6.0	6.0	6.0	6.0	6.0	6.0	6.0
length / długość [mm]	51.0	49.0	51.0	45.0	48.0	48	50.0	53.0	50.0	52.0	38.0	39.0
router bit diameter / średnica frezu [mm]	6.0	12.0	16.0	12.7	32.0	22.0	25.4	28.6	22.0	12.7	13.0	12.7
cutting edge length / długość krawędzi tnącej [mm]	20.0	20.0	20.0	12.7	12.7	10.5	11.5	16.0	12.0	13.0	9.5	6.35
curvature radius / promień krzywizny [mm]	-	-	-	-	-	12.7	3.175	9.5	6.35	-	-	-
bearing diameter / średnica łożyska [mm]	-	-	-	-	9.0	9.0	9.0	9.0	9.0	9.0	-	-
angle / kąt [°]	-	-	-	10.0	45.0	-	-	-	-	-	90.0	-



YATO
YT-68006 20

10

EN Router bit set
PL Zestaw frezów do drewna
DE Oberfrärsersatz
RU Набор фрез по дереву

CZ Sada fréz do dřeva
HU Faipari marókés készlet
RO Set de freze pt. lemn
FR Jeu de fraises à bois

IT Set di frese per legno
ES Juego de fresas para madera
CN 木工铣刀组套

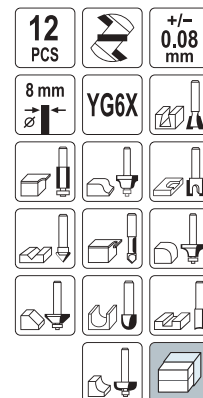
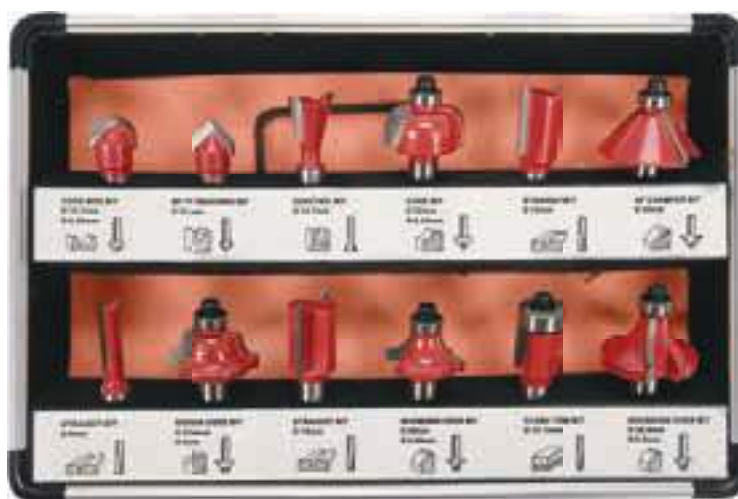

Router bit parameter												
shank diameter / średnica uchwyty [mm]	8.0	8.0	8.0	8.0	8.0	8.0	8.0	8.0	8.0	8.0	8.0	8.0
length / długość [mm]	51.0	49.0	51.0	45.0	48.0	48	50.0	53.0	50.0	52.0	38.0	39.0
router bit diameter / średnica frezu [mm]	6.0	12.0	16.0	12.7	32.0	22.0	25.4	28.6	22.0	12.7	13.0	12.7
cutting edge length / długość krawędzi tnącej [mm]	20.0	20.0	20.0	12.7	12.7	10.5	11.5	16.0	12.0	13.0	9.5	6.35
curvature radius / promień krzywizny [mm]	-	-	-	-	-	12.7	3.175	9.5	6.35	-	-	-
bearing diameter / średnica łożyska [mm]	-	-	-	-	9.0	9.0	9.0	9.0	9.0	9.0	-	-
angle / kąt [°]	-	-	-	10.0	45.0	-	-	-	-	-	90.0	-



YATO
YT-68005 20

EN Router bit set
 PL Zestaw frezów do drewna
 DE Oberfräsersatz
 RU Набор фрез по дереву

CZ Sada fréz do dřeva
 HU Faipari marókés készlet
 RO Set de freze pt. lemn
 FR Jeu de fraises à bois

IT Set di frese per legno
 ES Juego de fresas para madera
 CN 木工铣刀组套

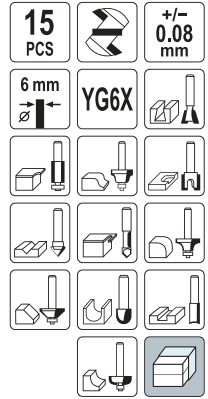

Router bit parameter															
shank diameter / średnica uchwyty [mm]	6.0	6.0	6.0	6.0	6.0	6.0	6.0	6.0	6.0	6.0	6.0	6.0	6.0	6.0	6.0
length / długość [mm]	43.0	49.0	51.0	45.0	48.0	51.0	50.0	53.0	50.0	52.0	38.0	39.0	49.0	60.0	43.0
router bit diameter / średnica frezu [mm]	12.7	12.0	16.0	12.7	32.0	6.0	25.4	28.6	22.0	12.7	12.7	12.7	3.0	6.35	6.35
cutting edge length / długość krawędzi tnącej [mm]	12.7	20.0	20.0	12.7	12.7	20.0	11.5	16.0	12.0	13.0	9.5	6.35	13.0	19.50	6.0
curvature radius / promień krzywizny [mm]	-	-	-	-	-	-	3.175	9.5	6.35	-	-	-	-	-	3.2
bearing diameter / średnica łożyska [mm]	-	-	-	-	9.0	-	9.0	9.0	9.0	9.0	-	-	-	-	-
angle / kąt [°]	-	-	-	10.0	45.0	-	-	-	-	-	90	-	-	-	-



YATO

YT-68007

20

EN Router bit set
 PL Zestaw frezów do drewna
 DE Oberfräsersatz
 RU Набор фрез по дереву

CZ Sada fréz do dřeva
 HU Faipari marókés készlet
 RO Set de freze pt. lemn
 FR Jeu de fraises à bois

IT Set di frese per legno
 ES Juego de fresas para madera
 CN 木工铣刀组套

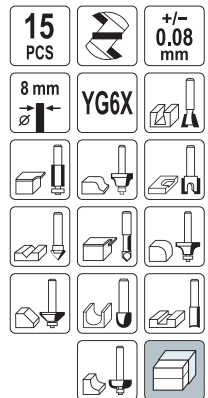
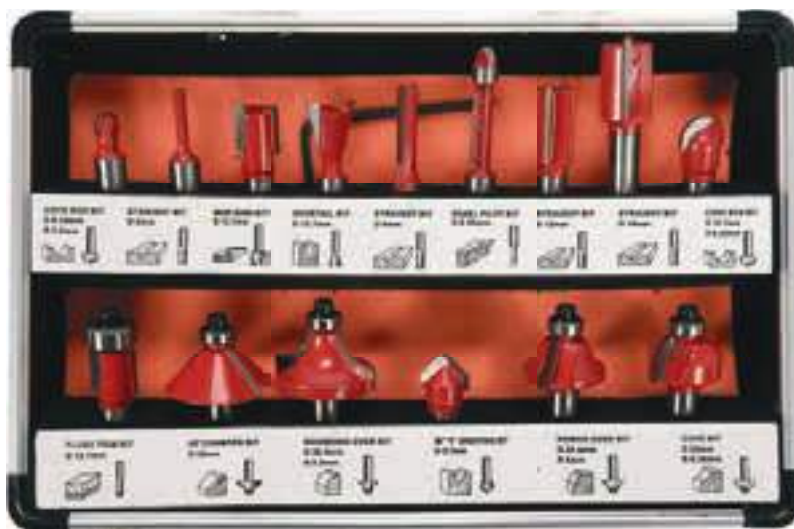

Router bit parameter															
shank diameter / średnica uchwyty [mm]	8.0	8.0	8.0	8.0	8.0	8.0	8.0	8.0	8.0	8.0	8.0	8.0	8.0	8.0	8.0
length / długość [mm]	43.0	49.0	51.0	45.0	48.0	51.0	50.0	53.0	50.0	52.0	38.0	39.0	49.0	60.0	43.0
router bit diameter / średnica frezu [mm]	12.7	12.0	16.0	12.7	32.0	6.0	25.4	28.6	22.0	12.7	12.7	12.7	3.0	6.35	6.35
cutting edge length / długość krawędzi tnącej [mm]	12.7	20.0	20.0	12.7	12.7	20.0	11.5	16.0	12.0	13.0	9.5	6.35	13.0	19.50	6.0
curvature radius / promień krzywizny [mm]	-	-	-	-	-	-	3.175	9.5	6.35	-	-	-	-	-	3.2
bearing diameter / średnica łożyska [mm]	-	-	-	-	9.0	-	9.0	9.0	9.0	9.0	-	-	-	-	-
angle / kąt [°]	-	-	-	10.0	45.0	-	-	-	-	-	90	-	-	-	-



YATO

YT-68002

20

10

EN Router bit set
PL Zestaw frezów do drewna
DE Oberfräsersatz
RU Набор фрез по дереву
CZ Sada fréz do dřeva
HU Faipari marókés készlet
RO Set de freze pt. lemn
FR Jeu de fraises à bois
IT Set di frese per legno
ES Juego de fresas para madera
CN 木工铣刀组套

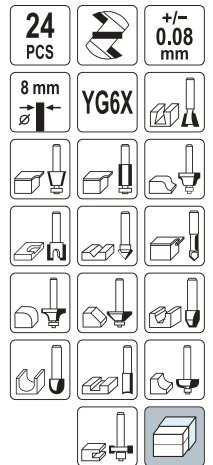

Router bit parameter												
Shank diameter [mm]	8	8	8	8	8	8	8	8	8	8	8	8
Length [mm]	42.0	47.0	47.0	43.5	50.0	51.5	51.0	52.0	58.0	51.5	58.0	56.5
Router bit diameter [mm]	12.7	12.7	9.5	12.7	12.7	9.5	12.7	16.0	6.35	6.35	9.5	12.7
Cutting edge length [mm]	12.7	14.8	11.6	13.0	12.5	20.0	20.0	9.5	19.5	20.0	24.5	25.0
Curvature radius [mm]	-	-	-	-	-	4.75	6.35	-	-	-	-	-
Bearing diameter [mm]	-	-	-	-	-	-	-	12.7	-	-	-	-
Angle [°]	-	15	10	-	45	-	-	15	-	-	-	-

Router bit parameter												
Shank diameter [mm]	8	8	8	8	8	8	8	8	8	8	8	8
Length [mm]	52.0	65.0	51.0	51.5	53.5	57.5	50.5	53.5	52.0	55.0	50.0	54.0
Router bit diameter [mm]	19.0	12.7	19.0	22.0	26.0	32.0	22.0	28.5	27.0	30.0	32.0	32.0
Cutting edge length [mm]	20.4	25.0	9.5	10.0	11.5	16.5	9.72	13.5	12.3	14.0	6.35	12.7
Curvature radius [mm]	-	-	3.2	4.76	6.35	9.5	6.35	9.5	4.0	-	-	-
Bearing diameter [mm]	-	12.7	-	12.7	12.7	12.7	9.5	9.5	9.5	12.7	12.7	12.7
Angle [°]	-	-	-	-	-	-	-	-	-	45	-	-



YATO
YT-6801 10

10

EN Router bit set
PL Zestaw frezów do drewna
DE Oberfräsersatz
RU Набор фрез по дереву
CZ Sada fréz do dřeva
HU Faipari marókés készlet
RO Set de freze pt. lemn
FR Jeu de fraises à bois
IT Set di frese per legno
ES Juego de fresas para madera
CN 木工铣刀组套

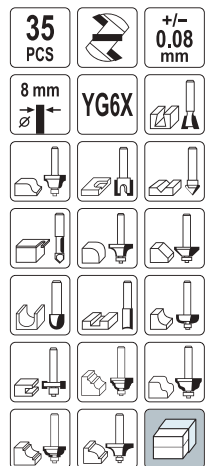

Router bit parameter																									
Shank diameter [mm]	8	8	8	8	8	8	8	8	8	8	8	8	8	8	8	8	8	8	8	8	8	8	8	8	8
Length [mm]	43.0	38.0	38.0	50.5	42.0	43.5	51.5	49.5	51.5	58.0	58.5	56.5	52.0	58.0	53.5	66.0	53.0	65.0							
Router bit diameter [mm]	6.35	12.7	12.7	12.7	12.7	12.7	14.3	3.175	6.35	9.5	12.7	12.7	19.0	6.35	9.5	9.5	12.7	12.7							
Cutting edge length [mm]	6.0	9.5	9.5	18.0	12.7	13.0	12.3	13.0	20.0	24.5	20.3	25.0	20.4	19.5	15.0	26.0	15.0	25.0							
Curvature radius [mm]	3.175	6.35	-	6.35	-	-	-	-	-	-	-	-	-	-	-	-	-	-							
Bearing diameter [mm]	-	-	-	-	-	-	-	-	-	-	-	-	-	-	9.5	9.5	12.7	12.7							
Angle [°]	-	-	45	-	-	10	14	-	-	-	-	-	-	-	-	-	-	-							

Router bit parameter																									
Shank diameter [mm]	8	8	8	8	8	8	8	8	8	8	8	8	8	8	8	8	8	8	8	8	8	8	8	8	8
Length [mm]	65.5	55.0	51.0	55.0	50.0	52.5	54.0	55.5	60.0	60.0	56.0	60.0	52.5	58.0	53.5	57.5	61.0	-							
Router bit diameter [mm]	19.0	30.0	26.0	32.0	32.0	32.0	32.0	32.0	38.0	32.0	38.0	26.0	38.0	26.0	32.0	38.0	-								
Cutting edge length [mm]	26.0	14.0	9.7	13.3	6.35	8.0	9.5	15.0	18.5	20.0	16.0	19.0	12.5	17.8	11.5	16.5	20.8	-							
Curvature radius [mm]	-	-	6.35	9.5	-	-	-	8.0	4.76	12.7	4.76	6.35	3.175	6.35	6.35	9.5	12.7	-							
Bearing diameter [mm]	19.0	12.7	12.7	12.7	12.7	12.7	9.5	12.7	9.5	9.5	9.5	9.5	9.5	9.5	12.7	12.7	12.7	-							
Angle [°]	-	45	-	-	-	-	-	-	-	-	-	-	-	-	-	-	-	-							



YATO
YT-6803 10

195

EN Diamond blade
 PL Tarcza diamentowa
 DE Diamant-Trennscheibe
 RU Отрезной алмазный диск
 CZ Diamantový kotouč
 HU Gyémántkorong
 RO Disc diamantat
 FR Disque diamant
 IT Disco diamantato
 ES Disco de diamante
 CN 金刚石切片



• Application: concrete, brick, tile, masonry, stone, sandstone, refractory materials, limestone
 • Przeznaczenie: beton utwardzony, cegła, granit, mur, kamień, piaskowiec, materiały ogniotwale, silikaty

YATO	ØA [mm]	Ød [mm]	max C [min ⁻¹]	D [mm]	H [mm]	
YT-59961	115	22.2	12000	1.8	10	20/200
YT-59962	125	22.2	12000	2.0	10	20/100
YT-59965	230	22.2	6500	2.2	10	25
YT-60003	350	25.4	4400	3.4	10	10
YT-60004	400	25.4	3850	3.6	10	5

EN Diamond blade
 PL Tarcza diamentowa
 DE Diamant-Trennscheibe
 RU Отрезной алмазный диск
 CZ Diamantový kotouč
 HU Gyémántkorong
 RO Disc diamantat
 FR Disque diamant
 IT Disco diamantato
 ES Disco de diamante
 CN 热压湿片

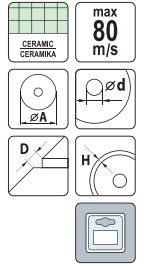

• Application: ceramic, glaze
 • Przeznaczenie: płytki ceramiczne, glazura, płytki kamienne

YATO	ØA [mm]	Ød [mm]	max C [min ⁻¹]	D [mm]	H [mm]	
YT-59951	115	22.2	12000	1.6	10	20/200
YT-59952	125	22.2	12000	1.6	10	20/100
YT-59955	230	22.2	6500	2.2	10	25

EN Diamond blade
 PL Tarcza diamentowa
 DE Diamant-Trennscheibe
 RU Отрезной алмазный диск
 CZ Diamantový kotouč
 HU Gyémántkorong
 RO Disc diamantat
 FR Disque diamant
 IT Disco diamantato
 ES Disco de diamante
 CN 热压X形金刚石锯片

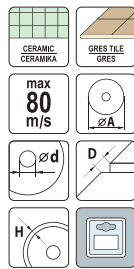

• Application: ceramic, glaze, glass, porcelain, ceramic tiles, composite hardest tiles, roof tiles
 • Przeznaczenie: płytki ceramiczne, glazura, płytki kamienne, szkło, porcelana, ceramika, gres, dachówki

YATO	ØA [mm]	Ød [mm]	max C [min ⁻¹]	D [mm]	H [mm]	
YT-59971	115	22.2	12000	1.6	10	20/120
YT-59972	125	22.2	12000	1.6	10	20/100
YT-59975	230	22.2	6500	2.0	10	25

EN Diamond blade
 PL Tarcza diamentowa
 DE Diamant-Trennscheibe
 RU Отрезной алмазный диск
 CZ Diamantový kotouč
 HU Gyémántkorong
 RO Disc diamantat
 FR Disque diamant
 IT Disco diamantato
 ES Disco de diamante
 CN 热压超薄波纹片



• Application: reinforced concrete, glaze, clinker, brick, limestone
 • Przeznaczenie: beton zbrojony, granit, klinkier, silikaty

YATO	ØA [mm]	Ød [mm]	max C [min ⁻¹]	D [mm]	H [mm]	
YT-59981	115	22.2	12000	1.3	10	20/200
YT-59982	125	22.2	12000	1.3	10	20/100
YT-59985	230	22.2	6500	2.0	10	25

EN Diamond blade
 PL Tarcza diamentowa
 DE Diamant-Trennscheibe
 RU Отрезной алмазный диск
 CZ Diamantový kotouč
 HU Gyémántkorong

RO Disc diamantat
 FR Disque diamant
 IT Disco diamantato
 ES Disco de diamante
 CN 金刚石切片



• Application: concrete, brick, calcium-silicate brick, tile, masonry, stone
 • Przeznaczenie: beton utwardzony, cegła, cegła silikatowa, granit, mur, kamień

YATO	ØA [mm]	Ød [mm]	max C [min ⁻¹]	D [mm]	H [mm]	
YT-6002	115	22.2	12000	2.1	8	20/200
YT-6003	125	22.2	11000	2.2	8	20/160
YT-6004	180	22.2	8000	2.5	8	15/60
YT-6005	230	22.2	6500	2.7	8	10/40

EN Diamond blade
 PL Tarcza diamentowa
 DE Diamant-Trennscheibe
 RU Отрезной алмазный диск
 CZ Diamantový kotouč
 HU Gyémántkorong

RO Disc diamantat
 FR Disque diamant
 IT Disco diamantato
 ES Disco de diamante
 CN 金刚石切片



• Application: ceramic, gres, glaze, glass, porcelain
 • Przeznaczenie: płytki ceramiczne, gres, glazura, płytki kamienne, szkło, porcelana

YATO	ØA [mm]	Ød [mm]	max C [min ⁻¹]	D [mm]	H [mm]	
YT-6012	115	22.2	12000	2.1	5.3	20/200
YT-6013	125	22.2	11000	2.2	5.3	20/160
YT-6014	180	22.2	8000	2.5	5.3	15/60
YT-6015	230	22.2	6500	2.7	5.3	10/40
YT-6016	180	25.4	8000	2.2	5.3	15/60
YT-6017	200	25.4	8000	2.2	5.3	10/40

EN Diamond blade
 PL Tarcza diamentowa
 DE Diamant-Trennscheibe
 RU Отрезной алмазный диск
 CZ Diamantový kotouč
 HU Gyémántkorong

RO Disc diamantat
 FR Disque diamant
 IT Disco diamantato
 ES Disco de diamante
 CN 金刚石切片



• Application: concrete, reinforced concrete, brick, tile, masonry, stone, sandstone
 • Przeznaczenie: beton utwardzony, beton zbrojony, cegła, granit, mur, kamień, piaskowiec

YATO	ØA [mm]	Ød [mm]	max C [min ⁻¹]	D [mm]	H [mm]	
YT-6022	115	22.2	12000	2.4	8	20/200
YT-6023	125	22.2	11000	2.6	8	20/160
YT-6024	180	22.2	8000	2.8	8	15/60
YT-6025	230	22.2	6500	3.1	8	10/40

- EN Diamond polishing disc for stoneware
PL Tarcza diamentowa do szlifowania gresu
DE Diamant-Schleifpad für Steinzeug
RU Алмазный диск для шлифования керамогранита
CZ Kotouč leštící diamentový na keramiku
HU Gyémánt csiszoló polírozó korong
RO Disc diamentat pt. șlefuit
FR Disque de polissage diamant pour grès
IT Disco lucidante diamentato per piastrelle
ES Disco de diamante para pulir gres
CN 金刚石软磨片



- Application: gres tile, granite, stone, concrete
• Przeznaczenie: gres, granit, kamień, beton

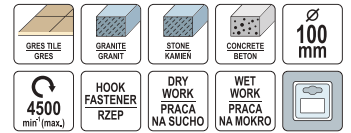

For YT-82161
Dla YT-82161

YATO	Grit / Ziarnistość	Ø [mm]	max ω [min ⁻¹]	
YT-48200	D50	100	4500	50/300
YT-48201	D100	100	4500	50/300
YT-48202	D200	100	4500	50/300
YT-48203	D400	100	4500	50/300
YT-48204	D800	100	4500	50/300
YT-48205	D1500	100	4500	50/300
YT-48206	D3000	100	4500	50/300

- EN Diamond grinding cup wheel
PL Tarcza szlifierska diamentowa
DE Diamant Schleiftopf Schleifteller
RU Алмазный диск шлифовальный
CZ Diamantový brusný kotouč
HU Gyémánt csiszoló kúpos
RO Disc cupa diamentat pt. șlefuit
FR Disque diamant
IT Disco diamentato
ES Disco diamante de lijar
CN 金刚石杯型磨轮



- Application: concrete, clinkier, natural stone, screed
• Przeznaczenie: beton utwardzony, klinkier, kamień naturalny, jastrych

YATO	ØA [mm]	Ød [mm]	max ω [min ⁻¹]	Segment size / Rozmiar segmentu [mm]	
YT-6030	125	22.2	12200	5x7.5	20
YT-6032	125	22.2	12200	4.5x20	20

- EN Diamond core bit drilling holes for sockets
PL Diamentowe wiertło koronowe
DE Diamant-Bohrkrone
RU Алмазное сверло корончатое
CZ Diamantový korunkový vrták
HU Gyémánt fúrókorona
RO Carota diamentata pt. beton
FR Trépiéd à mur diamantées
IT Corona diamentata per calcestruzzo
ES Broca corona de diamante
CN 金刚石薄壁钻



- Application: concrete, calcium-silicate brick, porous ceramics
• Przeznaczenie: beton utwardzony, cegła silikatowa, ceramika poryzowana

YATO	Ø [mm]	max ω [min ⁻¹]	Segment size / Rozmiar segmentu [mm]	
YT-6045	68	1030	3.5x10x24	24
YT-6046	82	850	3.5x10x24	20

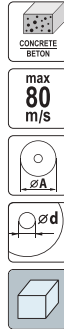

- EN Diamond grinding cup wheel
PL Tarcza szlifierska diamentowa
DE Diamant Schleiftopf Schleifteller
RU Алмазный диск шлифовальный
CZ Diamantový brusný kotouč
HU Gyémánt csiszoló kúpos
RO Disc cupa diamentat pt. șlefuit
FR Disque diamant
IT Disco diamentato
ES Disco diamante de lijar
CN 金刚石磨轮



- Application: concrete, screed
• Przeznaczenie: beton, jastrych

YATO	ØA [mm]	Ød [mm]	max ω [min ⁻¹]	Segment size / Rozmiar segmentu [mm]	For / Dla	
YT-60322	125	22.2	12200	5x9	YT-82110, YT-82101	30
YT-60323	180	22.2	6600	5x9	YT-82341, YT-82110	10

- EN Diamond core bit drilling holes for sockets
PL Diamentowe wiertło koronowe
DE Diamant-Bohrkrone
RU Алмазное сверло корончатое
CZ Diamantový korunkový vrták
HU Gyémánt fúrókorona
RO Carota diamentata pt. beton
FR Trépiéd à mur diamantées
IT Corona diamentata per calcestruzzo
ES Broca corona de diamante
CN 激光薄壁钻



For YT-81980
Dla YT-81980

YATO	Ø [mm]	Segment size / Rozmiar segmentu [mm]	
YT-60371	32	4x8x20	10
YT-60372	42	4x8x20	10
YT-60373	52	4x8x24	10
YT-60374	68	4x8x24	8
YT-60375	82	4x8x24	4
YT-60376	102	4x8x24	4
YT-60377	122	4x8x24	4
YT-60378	152	4x8x24	2
YT-60379	182	4x8x24	2



EN TCT circular saw blade for wood
 PL Pila tarczowa do drewna z węglikiem wolframu
 DE Kreissägeblatt HM-Bestückt
 RU Диск пильный с карбидом вольфрама
 CZ Kotoučová pila na dřevo z karbidem wolframu
 HU Wolframkarbidos körfűrész fához
 RO Disc circular cu dinți din wolfram pt. lemn
 FR Lame de scie circulaire carburée
 IT Lama troncatrice taglio legno
 ES Disco de sierra con carbono de tungsteno
 CN 木工圆锯片



• Application: for cutting wood and plastics

• Przeznaczenie: do cięcia drewna, płyt drewnopochodnych, tworzyw sztucznych

YATO	Ø [mm]	Ød [mm]	max. ω [min ⁻¹]	D [mm]	s [mm]	T	For / Dla	
YT-6050	130	16.0	10000	2.8	2.0	24	-	25/50
YT-6052	140	20.0	10000	2.8	2.0	16	-	25/50
YT-60522	140	20.0	11000	2.8	2.0	30	-	25/50
YT-6053	140	16.0	10000	2.8	2.0	30	-	25/50
YT-60533	150	20.0	10000	2.8	2.0	30	-	25/50
YT-6055	160	20.0	9500	2.8	2.0	18	79254	25/50
YT-6056	160	30.0	9500	2.8	2.0	24	79254	25/50
YT-6057	160	30.0	9500	2.8	2.0	36	-	25/50
YT-60577	160	20.0	9500	2.2	1.5	36	79254	25/50
YT-6058	160	20.0	9500	2.8	2.0	48	79254	25/50
YT-60581	160	20.0	9500	2.2	1.5	60	-	25/50
YT-60590	165	16.0	9500	2.2	1.5	24	YT-82810, YT-82811	25/50
YT-60591	165	16.0	9500	2.2	1.5	36	YT-82810, YT-82811	25/50
YT-60582	170	16.0	9500	3.2	2.2	12	-	25/50
YT-60583	170	16.0	9500	3.2	2.2	40	-	25/50
YT-6060	184	30.0	9000	3.2	2.2	24	YT-82172	25/50
YT-6061	184	30.0	9000	3.2	2.2	40	YT-82172	25/50
YT-6062	184	30.0	9000	3.2	2.2	50	YT-82172	25/50
YT-6063	185	20.0	9000	2.4	1.4	18	YT-82151	10/20
YT-60621	185	20.0	9000	2.2	1.5	24	YT-82151	25/50
YT-60622	185	20.0	9000	2.2	1.5	36	YT-82151	25/50
YT-60633	190	16.0	8500	3.2	2.2	40	YT-82150	10/20
YT-60634	190	20.0	8500	2.2	1.5	24	YT-82150	10/20
YT-60635	190	20.0	8500	2.2	1.5	36	YT-82150	10/20
YT-60636	190	20.0	8500	2.2	1.5	60	-	10/20
YT-60488	190	30.0	8500	3.2	2.2	20	-	10/20
YT-60489	190	30.0	8500	3.2	2.2	40	-	10/20
YT-6065	200	30.0	8000	3.2	2.2	24	-	10/20
YT-60652	200	30.0	8000	3.2	2.2	40	-	10/20
YT-6066	205	18.0	6000	3.2	2.0	24	-	10/20
YT-60665	210	30.0	7500	3.2	2.2	20	-	10/20

YATO	Ø [mm]	Ød [mm]	max. ω [min ⁻¹]	D [mm]	s [mm]	T	For / Dla	
YT-6067	210	30.0	8000	3.2	2.2	40	-	10/20
YT-6068	210	30.0	8000	3.2	2.2	60	-	10/20
YT-60682	216	30.0	7500	3.2	2.2	48	-	10/20
YT-60685	235	25.4	7000	2.8	1.8	24	YT-82153	10/20
YT-60686	235	25.4	7000	2.8	1.8	36	YT-82153	10/20
YT-60687	235	25.4	7000	2.8	1.8	60	YT-82153	10/20
YT-6070	250	30.0	6000	3.2	2.2	24	YT-82165	10/20
YT-6071	250	30.0	6000	3.2	2.2	40	YT-82165	10/20
YT-6072	250	30.0	6000	3.2	2.2	60	YT-82165	10/20
YT-60731	255	30.0	6000	3.0	2.0	24	YT-82171, YT-82173, YT-82165	10/20
YT-60732	255	30.0	6000	3.0	2.0	36	YT-82173	10/20
YT-60733	255	30.0	6000	3.0	2.0	60	YT-82173	10/20
YT-6075	300	30.0	6000	3.2	2.2	24	YT-82175	10
YT-6076	300	30.0	5000	3.2	2.2	40	YT-82175	10
YT-6077	300	30.0	5000	3.2	2.2	60	YT-82175	10
YT-6078	300	30.0	5000	3.2	2.2	96	YT-82175	10
YT-60782	305	30.0	5000	3.2	2.2	24	YT-82175	10
YT-60783	305	30.0	5000	3.2	2.2	40	YT-82175	10
YT-60784	305	30.0	5000	3.2	2.2	60	YT-82175	10
YT-60785	305	30.0	5000	3.2	2.2	96	YT-82175	10
YT-60791	315	30.0	4900	3.2	2.2	40	-	10
YT-60792	315	30.0	4500	3.5	2.5	48	-	10
YT-60794	315	30.0	4500	3.5	2.5	80	-	10
YT-60795	315	30.0	4900	3.2	2.2	96	-	10
YT-6080	350	30.0	4500	3.5	2.5	28	-	10
YT-6081	350	30.0	4500	3.5	2.5	40	-	10
YT-6082	350	30.0	4500	3.5	2.5	54	-	10
YT-6083	350	30.0	4500	3.5	2.5	84	-	10
YT-6085	400	30.0	4000	3.8	2.8	32	-	10
YT-6086	400	30.0	4000	3.8	2.8	60	-	10

EN Circular saw blade for wood
 PL Pila tarczowa do drewna
 DE Kreissägeblatt
 RU Диск пильный по дереву
 CZ Kotoučová pila na dřevo
 HU Körfűrész fához
 RO Disc circular pt. lemn
 FR Lame de scie pour bois
 IT Lama taglio legno
 ES Disco de sierra
 CN 木工尖齿片



YATO	Ø [mm]	Ød [mm]	max. ω [min ⁻¹]	D [mm]	s [mm]	T	
YT-60871	500	32	3000	4.5	2.9	60	4
YT-60872	500	32	3000	4.5	2.9	80	4

EN TCT circular saw blade for structural wood
 PL Pila tarczowa z węglikiem wolframu do cięcia drewna konstrukcyjnego
 DE Kreissägeblatt HM-Bestückt von Holzkonstruktionen
 RU Диск пильный твердого сплава для резы строительной конструкционной древесины
 CZ Kotoúčová pila s karbidem wolframu k řezání konstrukčního dřeva
 HU Wolfram-karbid szegmens fűrészárca szerkezeti fához
 RO Disc circular cu dinți din wolfram pt. lemn
 FR Lame de scie circulaire carbure pour construction bois
 IT Lama al tungsteno da legno
 ES Disco de sierra con carbono de tungsteno para corte de madera estructural
 CN 木工圆锯片

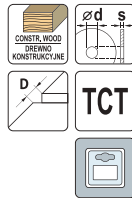

YATO	Ø [mm]	Ød [mm]	max. c [min ⁻¹]	D [mm]	s [mm]	T	
YT-60480	160	20	9500	2.2	1.5	24	25/50
YT-60482	180	20	9000	2.4	1.8	36	20/40
YT-60484	250	30	6000	2.4	1.8	48	10/20

EN TCT circular saw blade for structural wood
 PL Pila tarczowa z węglikiem wolframu do cięcia drewna konstrukcyjnego
 DE Kreissägeblatt HM-Bestückt von Holzkonstruktionen
 RU Диск пильный твердого сплава для резы строительной конструкционной древесины
 CZ Kotoúčová pila s karbidem wolframu k řezání konstrukčního dřeva
 HU Wolfram-karbid szegmens fűrészárca szerkezeti fához
 RO Disc circular cu dinți din wolfram pt. lemn
 FR Lame de scie circulaire carbure pour construction bois
 IT Lama al tungsteno da legno
 ES Disco de sierra con carbono de tungsteno para corte de madera estructural
 CN 锯钉片

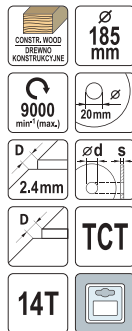

YATO	Ø [mm]	Ød [mm]	max. c [min ⁻¹]	D [mm]	s [mm]	T	
YT-60628	185	20	9000	2.4	1.8	14	25/50

EN PVC cutting blade
 PL Pila tarczowa do cięcia PVC
 DE PVC-Trennscheibe
 RU Режущий диск ПВХ
 CZ PVC řezný disk
 HU Kőrfűrészárca
 RO Pânză de fierăstrău circular PVC
 FR Disque de coupe en PVC
 IT Disco da taglio per PVC
 ES Sierra circular CMT para corte PVC
 CN 锯塑片



EN TCT circular saw blade for aluminium
 PL Pila tarczowa do aluminium z węglikiem wolframu
 DE Hartmetallbestückt Kreissägeblatt für Aluminium
 RU Диск пильный по алюминию
 CZ Kotoúčová pila na hliník s karbidem wolframu
 HU Wolframkarbidos kőrfűrészlap, alumíniumhoz
 RO Disc circular pt. aluminiu
 FR Lame de scie circulaire pour aluminium
 IT Lama troncatrice alluminio
 ES Disco de sierra con carbono
 CN 圆锯片

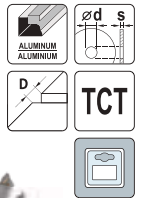

• Application: for cutting aluminium profiles, laminates, plexi, corian and other plastics
 • Negative angle of teeth

• Przeznaczenie: do cięcia profili aluminiowych, laminatów, pleksi, korianu, tworzyw sztucznych
 • Negatywny kąt natarcia zębów

YATO	Ø [mm]	Ød [mm]	max. c [min ⁻¹]	D [mm]	s [mm]	T	
YT-60905	160	20	9500	2.2	1.5	52	25/50
YT-60907	180	20	9000	2.2	1.5	60	20/40
YT-6091	200	30	8000	3.0	2.2	60	10/20
YT-6093	210	30	8000	3.0	2.2	72	10/20
YT-6095	250	30	6000	3.0	2.2	100	10/20
YT-6097	300	30	5000	3.0	2.2	100	10
YT-6099	350	30	4500	3.2	2.5	100	10

EN Blade for cutting laminate and plywood
 PL Pila tarczowa do cięcia paneli i płyt meblowych
 DE Kreissägeplatte für Laminatböden
 RU Ламинированный режущий диск
 CZ Laminátový řezací kotouč
 HU Kőrfűrészlap
 RO Disc de tăiere laminat
 FR Disque de coupe en stratifié
 IT Disco da taglio per pannelli e pannelli per mobili
 ES Disco de corte laminado
 CN 普通木工件

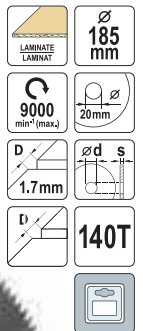

YATO	Ø [mm]	Ød [mm]	max. c [min ⁻¹]	D [mm]	s [mm]	T	
YT-60631	185	20	9000	1.7	1.4	140	25/50

EN PVC cutting blade
 PL Pila tarczowa do cięcia PVC
 DE PVC-Trennscheibe
 RU Режущий диск ПВХ
 CZ PVC řezný disk
 HU Kőrfűrészárca
 RO Pânză de fierăstrău circular PVC
 FR Disque de coupe en PVC
 IT Disco da taglio per PVC
 ES Sierra circular CMT para corte PVC
 CN 锯塑片

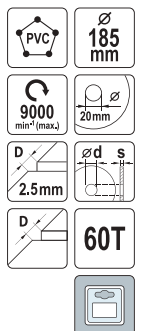

YATO	Ø [mm]	Ød [mm]	max. c [min ⁻¹]	D [mm]	s [mm]	T	
YT-60627	185	20	9000	2.5	1.5	60	25/50

EN Metal cutting disc
 PL Tarcza do cięcia metalu
 DE Trennscheibe für Metall
 RU Диск отрезной по металлу
 CZ Kotouč pro řezání kovu
 HU Vágókorong fémhez
 RO Disc debitat metal
 FR Disque à tronçonner pour métal
 IT Disco per taglio metallo
 ES Disco cortador para metal
 CN 金属切割片



STEEL STAL

METAL SHEET BLACHA

INOX

max 80 m/s

ØA

Ød

D

YATO	ØA [mm]	Ød [mm]	D [mm]	max c [min ⁻¹]	
YT-6101	115	22	1.2	13200	25/200
YT-61025	125	22.23	1.0	12200	50/400
YT-6103	125	22	1.2	12200	25/200
YT-6104	125	22	2.5	12200	25/200
YT-6105	180	22	1.5	8600	25/50
YT-6107	230	22	2.0	6500	25/50

EN Metal cutting disc
 PL Tarcza do cięcia metalu
 DE Trennscheibe für Metall
 RU Диск отрезной по металлу
 CZ Kotouč pro řezání kovu
 HU Vágókorong fémhez
 RO Disc debitat metal
 FR Disque à tronçonner pour métal
 IT Disco per taglio metallo
 ES Disco cortador para metal
 CN 金属切割片



STEEL STAL

max 80 m/s

ØA

Ød

D

YATO	ØA [mm]	Ød [mm]	D [mm]	max c [min ⁻¹]	
YT-5920	115	22	1.2	13200	25/200
YT-5923	125	22	1.2	12200	25/200
YT-5924	125	22	2.5	12200	25/200
YT-6110	125	22	3.2	12200	25/200
YT-5925	180	22	1.5	8600	25/50
YT-5927	230	22	2.0	6500	25/50
YT-6112	230	22	3.2	6500	25/50
YT-6113	300	32	3.2	5100	25
YT-6136	350	32	3.5	4400	25
YT-6137	400	32	4.0	3800	25

EN Metal cutting disc
 PL Tarcza do cięcia metalu
 DE Trennscheibe für Metall
 RU Диск отрезной по металлу
 CZ Kotouč pro řezání kovu
 HU Vágókorong fémhez
 RO Disc debitat metal
 FR Disque à tronçonner pour métal
 IT Disco per taglio metallo
 ES Disco cortador para metal
 CN 金属切割片



STEEL STAL

Ø 355 mm

25.4mm

3.2mm

4400 min⁻¹ (max.)

max 80 m/s

For YT-82180
 Dla YT-82180

YATO	ØA [mm]	Ød [mm]	D [mm]	max c [min ⁻¹]	
YT-61132	355	25.4	3.2	4400	25

EN Metal cutting disc
 PL Tarcza do cięcia metalu
 DE Trennscheibe für Metall
 RU Диск отрезной по металлу
 CZ Kotouč pro řezání kovu
 HU Vágókorong fémhez
 RO Disc debitat metal
 FR Disque à tronçonner pour métal
 IT Disco per taglio metallo
 ES Disco cortador para metal
 CN 金属切割片



STEEL STAL

max 80 m/s

ØA

Ød

D

• Depressed center

• Wypukła

YATO	ØA [mm]	Ød [mm]	D [mm]	max c [min ⁻¹]	pcs / szt.	
YT-6116	125	22	2.5	12200	5	25/200
YT-6120	230	22	3.2	6500	5	25/50

EN Metal grinding disc
 PL Tarcza do szlifowania metalu
 DE Metall-Schleif-scheibe
 RU Круги для шлифования по металлу
 CZ Kotouč pro broušení kovu
 HU Vágókorong fémhez
 RO Disc pt. șlefuit metal
 FR Disque de polissage pour métaux
 IT Disco per rettifica metallo
 ES Disco cortador para metal
 CN 树脂切片



STEEL STAL

max 80 m/s

ØA

Ød

D

• Depressed center

• Wypukła

YATO	ØA [mm]	Ød [mm]	D [mm]	max c [min ⁻¹]	
YT-6121	115	22	6.0	13200	25/100
YT-6124	125	22	6.0	12200	30/120
YT-6126	125	22	8.0	12200	25/100
YT-6125	230	22	6.0	6500	5/30

EN Metal grinding disc
 PL Tarcza do szlifowania metalu
 DE Metall-Schleif-scheibe
 RU Круги для шлифования по металлу
 CZ Kotouč pro broušení kovu
 HU Vágókorong fémhez
 RO Disc pt. șlefuit metal
 FR Disque de polissage pour métaux
 IT Disco per rettifica metallo
 ES Disco cortador para metal
 CN 树脂切片



STEEL STAL

INOX

Ø 125 mm

22mm

6.8mm

12200 min⁻¹ (max.)

max 80 m/s

• Depressed center

• Wypukła

YATO	ØA [mm]	Ød [mm]	D [mm]	max c [min ⁻¹]	
YT-5947	125	22	6.8	12200	25/100

EN Stone cutting disc
PL Tarcza do cięcia kamienia
DE Stein-Trennscheibe
RU Диск отрезной по камню
CZ Kotouč pro řezání kamene
HU Vágókorong kőhöz
RO Disc pt. tăiat piatră
FR Disque de coupe pour granit
IT Disco per taglio pietra
ES Disco cortador de piedra
CN 树脂切片

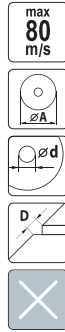

EN Stone grinding disc
PL Tarcza do szlifowania kamienia
DE Stein-Schleifscheibe
RU Диск для шлифования по камню
CZ Kotouč pro broušení kamene
HU Csiszolókorong kőhöz
RO Disc pt. șlefuit piatră
FR Disque de polissage pour granit
IT Disco per rettifica pietra
ES Disco cortador de piedra
CN 树脂切片



• Depressed center

• Wypukła

YATO	ØA [mm]	Ød [mm]	max c [min ⁻¹]	D [mm]	
YT-5930	115	22	13200	1.5	25/200
YT-5932	125	22	12200	1.5	25/200
YT-5933	125	22	12200	3.2	25/200
YT-5935	230	22	6500	3.2	25/50

YATO	ØA [mm]	Ød [mm]	D [mm]	max c [min ⁻¹]	
YT-6132	115	22	6.0	13200	25/100
YT-6133	125	22	6.8	12200	25/100

EN Universal grinding disc
PL Tarcza szlifierska uniwersalna
DE Universelle Schleifscheibe
RU Диск шлифовальный универсальный
CZ Brusný kotouč univerzální
HU Univerzális csiszolókorong
RO Disc universal pt. șlefuit
FR Disque de ponçage universel
IT Disco di molatura
ES Muela abrasiva universal
CN 塑基砂盘

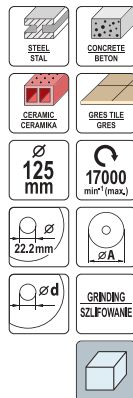

EN Rubber disc for angle grinder
PL Przystawka do szlifierek kątowych
DE Klett-Gummihafstüzteller mit Gewindeflansch
RU Диск резиновый с липучкой для шлифмашины
CZ Euro disk do úhelníků ze zipem
HU Csiszolókorong kőhöz
RO Suport disc pt. polizor unghiular
FR Disque caoutchouc avec velcro
IT Disco con velcro e accessori
ES Disco de goma para angul con velcro
CN 抛光盘



YATO	Grit / Ziarnistość	ØA [mm]	Ød [mm]	max c [min ⁻¹]	
YT-83260	P8	125	22.2	17000	100
YT-83261	P16	125	22.2	17000	100
YT-83262	P24	125	22.2	17000	100
YT-83263	P36	125	22.2	17000	100
YT-83264	P60	125	22.2	17000	100
YT-83265	P80	125	22.2	17000	100
YT-83266	P120	125	22.2	17000	100

YATO	Ø [mm]	max c [min ⁻¹]	
YT-4770	230	6600	25

EN Tapered rasp disc
PL Tarnik skośny
DE Raspelscheibe schräge Oberfläche
RU Диск фреза универсальный по дереву для УШМ
CZ Rotační rašple
HU Rotációs rászpoly
RO Disc raspel
FR Disque râpe
IT Disco raspa obliquo
ES Disco escofina
CN 圆锥锉刀盘

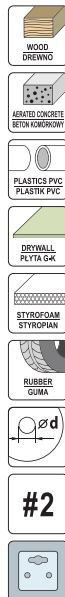

• Grinding, milling
• Wood, cellular concrete, plastics, gypsum, drywall
• Szlifowanie, frezowanie
• Drewno, beton komórkowy, tworzywa sztuczne, gips, płyty gipsowo-kartonowe

YATO	Ø [mm]	Ød [mm]	max c [min ⁻¹]	[#]	
YT-59164	115	22.2	13000	2	10
YT-59165	125	22.2	13000	2	10

EN Tapered rasp disc
PL Tarnik skośny
DE Raspelscheibe schräge Oberfläche
RU Диск фреза универсальный по дереву для УШМ
CZ Rotační rašple
HU Rotációs rászpoly
RO Disc raspel
FR Disque râpe
IT Disco raspa obliquo
ES Disco escofina
CN 圆锥锉刀盘

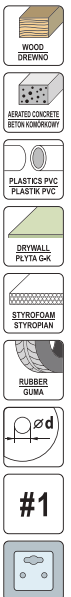

• Grinding, milling
• Wood, cellular concrete, plastics, gypsum, drywall
• Szlifowanie, frezowanie
• Drewno, beton komórkowy, tworzywa sztuczne, gips, płyty gipsowo-kartonowe

YATO	Ø [mm]	Ød [mm]	max c [min ⁻¹]	[#]	
YT-59166	115	22.2	13000	1	10
YT-59167	125	22.2	13000	1	10

EN Carving rasp disc
 PL Tarnik promieniowy
 DE Rundraspelfräscheibe
 RU Диск-фреза закругленный для УШМ
 CZ Rašple rotační oblá
 HU Ívelt ráspolykorong
 RO Disc raspe
 FR Disque de sculpture
 IT Disco a raspa stondato
 ES Disco escofina curvo para tallado
 CN 雕刻锉刀盘

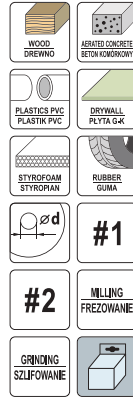

- Grinding, milling
- Wood, cellular concrete, plastics, gypsum, drywall
- Szlifowanie, frezowanie
- Drewno, beton komórkowy, tworzywa sztuczne, gips, płyty gipsowo-kartonowe

YATO	Ø [mm]	Ød [mm]	H [mm]	max C [min ⁻¹]	[#]	
YT-59155	120	22.2	13	13000	1	10
YT-59156	120	22.2	13	13000	2	10

EN Tapered rasp disc
 PL Tarnik wypukły
 DE Raspelscheibe gekröpft
 RU Диск фреза универсальный по дереву для УШМ
 CZ Rotační rašple
 HU Rotációs ráspoly
 RO Disc raspe
 FR Disque râpe
 IT Disco raspa convesso
 ES Disco escofina
 CN 锯片



- Grinding, milling
- Wood, cellular concrete, plastics, gypsum, drywall
- Szlifowanie, frezowanie
- Drewno, beton komórkowy, tworzywa sztuczne, gips, płyty gipsowo-kartonowe

YATO	Ø [mm]	Ød [mm]	max C [min ⁻¹]	[#]	
YT-59168	125	22.2	13000	1	10
YT-59169	125	22.2	13000	2	10
YT-59170	125	22.2	13000	3	10

EN Milling rasp disc
 PL Frez tarnikowy
 DE Raspelfräscheibe
 RU Диск-фреза шлифовальный для УШМ
 CZ Rotační rašple frézovací
 HU Ráspolykorong
 RO Disc raspe pt. frezat
 FR Disque à râpe de fraise
 IT Disco a raspa
 ES Disco escofina
 CN 铣刀盘

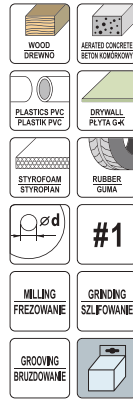

- Milling, grinding, grooving
- Wood, cellular concrete, plastics, gypsum, drywall
- Frezowanie, szlifowanie, bruzdowanie
- Drewno, beton komórkowy, tworzywa sztuczne, gips, płyty gipsowo-kartonowe

YATO	Ø [mm]	Ød [mm]	H [mm]	max C [min ⁻¹]	[#]	
YT-59178	120	22.2	6	13000	1	10
YT-59179	120	22.2	12	13000	1	10

EN Rasp milling cutter
 PL Frez tarnikowy uniwersalny
 DE Raspelfräs Universalscheibe
 RU Универсальная фреза
 CZ Rotační rašple
 HU Rotációs ráspoly
 RO Disc raspe
 FR Fraise râpe
 IT Fresa raspa a disco universale
 ES Disco escofina
 CN 锯片

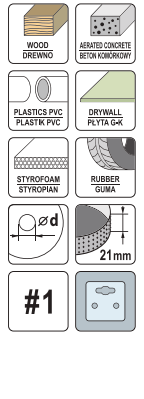

- Milling, grinding, grooving
- Wood, cellular concrete, plastics, gypsum, drywall
- Frezowanie, szlifowanie, bruzdowanie
- Drewno, beton komórkowy, tworzywa sztuczne, gips, płyty gipsowo-kartonowe

YATO	Ø [mm]	Ød [mm]	→L [mm]	max C [min ⁻¹]	[#]	
YT-59177	118	22.2	21	13000	1	10

EN Depressed center milling rasp disc
 PL Frez tarnikowy pełny wypukły
 DE Raspelfräscheibe konvexe
 RU Диск-фреза выпуклый для УШМ
 CZ Rotační rašple frézovací vypouklá
 HU Rotációs ráspolykorong széles
 RO Disc depresat raspe pt. frezat
 FR Disque à râpe de fraise arrondi
 IT Disco a raspa a centro depresso
 ES Disco escofina con centro deprimido
 CN 凹陷式中心铣盘

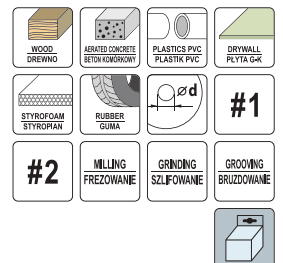

- Milling, grinding, grooving
- Wood, cellular concrete, plastics, gypsum, drywall
- Frezowanie, szlifowanie, bruzdowanie
- Drewno, beton komórkowy, tworzywa sztuczne, gips, płyty gipsowo-kartonowe

YATO	Ø [mm]	Ød [mm]	H [mm]	max C [min ⁻¹]	[#]	
YT-59180	120	22.2	6	13000	1	10
YT-59181	120	22.2	6	13000	2	10
YT-59182	120	22.2	12	13000	1	10
YT-59183	120	22.2	12	13000	2	10
YT-59184	120	22.2	18	13000	1	10
YT-59185	120	22.2	18	13000	2	10

EN Tin snips
PL Nożyce do cięcia blachy
DE Blechscherer
RU Ножницы по металлу

CZ Nůžky na plech
HU Lemezvágó olló
RO Foarfecă pt. tablă
FR Cisaille à tôle

IT Cesioie per lamiera
ES Tijera corta chapa
CN 航空剪



CrMo

INCREASED CUTTING POWER
ZWIĘKSZONA SIŁA CIĘCIA



DIN 6438 HRC 60-62



DIN 6438 HRC 60-62

YATO	L [mm]	Cutting length / Długość cięcia [mm]	Cooper / Miedź [mm]	Cold rolled steel / Stal zimnowalcowana [mm]	Steel HRC35 / Stal HRC35 [mm]	SS 304 / Stal nierdzewna 304 [mm]	
YT-1910	260	35	1.8	1.5	1.0	0.9	6/36

YATO	L [mm]	Cutting length / Długość cięcia [mm]	Cooper / Miedź [mm]	Cold rolled steel / Stal zimnowalcowana [mm]	Steel HRC35 / Stal HRC35 [mm]	SS 304 / Stal nierdzewna 304 [mm]	
YT-1915	235	30	1.5	1.2	1.0	0.7	6/36



DIN 6438 HRC 60-62



250 mm HRC 56-62

HIGH FREQUENCY HARDENING
HARTOWANIE IMPULSOWE

SERRATED EDGES
ZABKOWANE KRAWĘDZIE

YATO	L [mm]	Cutting length / Długość cięcia [mm]	Cooper / Miedź [mm]	Cold rolled steel / Stal zimnowalcowana [mm]	Steel HRC35 / Stal HRC35 [mm]	SS 304 / Stal nierdzewna 304 [mm]	
YT-1918	260	32	1.8	1.5	1.0	0.9	6/36

YATO	L [mm]	Cutting length / Długość cięcia [mm]	Cooper / Miedź [mm]	Cold rolled steel / Stal zimnowalcowana [mm]	Steel HRC35 / Stal HRC35 [mm]	SS 304 / Stal nierdzewna 304 [mm]	
YT-1960	250	40	2.0	1.5	1.0	0.8	6/36

EN Tin snips
PL Nożyce do cięcia blachy
DE Blechscherer

RU Ножницы по металлу
CZ Nůžky na plech
HU Lemezvágó olló

RO Foarfecă pt. tablă
FR Cisaille à tôle
IT Cesioie per lamiera

ES Tijera corta chapa
CN 航空剪



90°

HRC 60-62

CrMo

SERRATED EDGES
ZABKOWANE KRAWĘDZIE



YATO	L [mm]	Cutting length / Długość cięcia [mm]	Cooper / Miedź [mm]	Cold rolled steel / Stal zimnowalcowana [mm]	Steel HRC35 / Stal HRC35 [mm]	SS 304 / Stal nierdzewna 304 [mm]	
YT-1913	225	30	0.78	0.53	0.46	0.36	6/36

EN Tin snips
PL Nożyce do cięcia blachy
DE Blechscherer
RU Ножницы по металлу

CZ Nůžky na plech
HU Lemezvágó olló
FR Cisaille à tôle

IT Cesioie per lamiera
ES Tijera corta chapa
CN 航空剪



CrMo

INCREASED CUTTING POWER
ZWIĘKSZONA SIŁA CIĘCIA



DIN 6438 HRC 60-62

YATO	L [mm]	Cutting length / Długość cięcia [mm]	Cooper / Miedź [mm]	Cold rolled steel / Stal zimnowalcowana [mm]	Steel HRC35 / Stal HRC35 [mm]	SS 304 / Stal nierdzewna 304 [mm]	
YT-1912	260	35	1.8	1.5	1.0	0.9	6/36



DIN 6438 HRC 60-62



250 mm HRC 56-62

SERRATED EDGES
ZABKOWANE KRAWĘDZIE

HIGH FREQUENCY HARDENING
HARTOWANIE IMPULSOWE

YATO	L [mm]	Cutting length / Długość cięcia [mm]	Cooper / Miedź [mm]	Cold rolled steel / Stal zimnowalcowana [mm]	Steel HRC35 / Stal HRC35 [mm]	SS 304 / Stal nierdzewna 304 [mm]	
YT-1922	290	75	1.1	0.94	0.7	0.53	6/36

YATO	L [mm]	Cutting length / Długość cięcia [mm]	Cooper / Miedź [mm]	Cold rolled steel / Stal zimnowalcowana [mm]	Steel HRC35 / Stal HRC35 [mm]	SS 304 / Stal nierdzewna 304 [mm]	
YT-1962	250	45	2.0	1.5	1.0	0.8	6/36

EN Tin snips
 PL Nożyce do cięcia blachy
 DE Blechscherer
 RU Ножницы по металлу

CZ Nůžky na plech
 HU Lemezvágó olló
 RO Foarfecă pt. tablă
 FR Cisaille à tôle

IT Cesioie per lamiera
 ES Tijera corta chapa
 CN 航空剪



DIN 6438 **HRC 60-62**

DIN 6438 **HRC 60-62**

YATO	L [mm]	Cutting length / Długość cięcia [mm]	Cooper / Miedź [mm]	Cold rolled steel / Stal zimnowalcowana [mm]	Steel HRC35 / Stal HRC35 [mm]	SS 304 / Stal nierdzewna 304 [mm]	
YT-1911	260	35	1.8	1.5	1.0	0.9	6/36

YATO	L [mm]	Cutting length / Długość cięcia [mm]	Cooper / Miedź [mm]	Cold rolled steel / Stal zimnowalcowana [mm]	Steel HRC35 / Stal HRC35 [mm]	SS 304 / Stal nierdzewna 304 [mm]	
YT-1916	235	30	1.5	1.2	1.0	0.7	6/36



DIN 6438 **HRC 60-62**

250 mm **HRC 56-62** **SERRATED EDGES ZARZKOWANE KRAWĘDZIE** **HIGH FREQUENCY HARDENING HARTOWANIE WŁASZCZĄCE**

YATO	L [mm]	Cutting length / Długość cięcia [mm]	Cooper / Miedź [mm]	Cold rolled steel / Stal zimnowalcowana [mm]	Steel HRC35 / Stal HRC35 [mm]	SS 304 / Stal nierdzewna 304 [mm]	
YT-1919	260	32	1.8	1.5	1.0	0.9	6/36

YATO	L [mm]	Cutting length / Długość cięcia [mm]	Cooper / Miedź [mm]	Cold rolled steel / Stal zimnowalcowana [mm]	Steel HRC35 / Stal HRC35 [mm]	SS 304 / Stal nierdzewna 304 [mm]	
YT-1961	250	40	2.0	1.5	1.0	0.8	6/36

EN Tin snips
 PL Nożyce do cięcia blachy
 DE Blechscherer
 RU Ножницы по металлу

CZ Nůžky na plech
 HU Lemezvágó olló
 RO Foarfecă pt. tablă
 FR Cisaille à tôle

IT Cesioie per lamiera
 ES Tijera corta chapa
 CN 航空剪



YATO	L [mm]	Cutting length / Długość cięcia [mm]	Cooper / Miedź [mm]	Cold rolled steel / Stal zimnowalcowana [mm]	Steel HRC35 / Stal HRC35 [mm]	SS 304 / Stal nierdzewna 304 [mm]	
YT-1914	225	30	0.78	0.53	0.46	0.36	6/36

EN Tin snips
 PL Nożyce do cięcia blachy
 DE Blechscherer
 RU Ножницы по металлу
 CZ Nůžky na plech
 HU Lemezvágó olló

RO Foarfecă pt. tablă
 FR Cisaille à tôle

IT Cesioie per lamiera
 ES Tijera corta chapa
 CN 航空剪



YATO	L [mm]	Cutting length / Długość cięcia [mm]	Cooper / Miedź [mm]	Cold rolled steel / Stal zimnowalcowana [mm]	Steel HRC35 / Stal HRC35 [mm]	SS 304 / Stal nierdzewna 304 [mm]	
YT-1900	260	30	0.94	0.78	0.6	0.45	6/24

EN Tin snips
 PL Nożyce do cięcia blachy
 DE Blechscherer
 RU Ножницы по металлу

CZ Nůžky na plech
 HU Lemezvágó olló
 RO Foarfecă pt. tablă
 FR Cisaille à tôle

IT Cesioie per lamiera
 ES Tijera corta chapa
 CN 航空剪



YATO	L [mm]	Cutting length / Długość cięcia [mm]	Cooper / Miedź [mm]	Cold rolled steel / Stal zimnowalcowana [mm]	Steel HRC35 / Stal HRC35 [mm]	SS 304 / Stal nierdzewna 304 [mm]	
YT-1901	260	30	0.94	0.78	0.6	0.45	6/24

YATO	L [mm]	Cutting length / Długość cięcia [mm]	Cooper / Miedź [mm]	Cold rolled steel / Stal zimnowalcowana [mm]	Steel HRC35 / Stal HRC35 [mm]	SS 304 / Stal nierdzewna 304 [mm]	
YT-1902	300	50	0.94	0.78	0.6	0.45	6/24

EN Tin snips
PL Nożyce do cięcia blachy
DE Blechscherer
RU Ножницы по металлу
CZ Nůžky na plech
HU Lemezvágó olló

RO Foarfecă pt. tablă
FR Cisaille à tôle
IT Cesioie per lamiera
ES Tijera corta chapa
CN 航空剪



HRC
55-60

S55C

HIGH FREQUENCY
HARDENING
HARTONANIE
IMPULSOWE



YATO	L [mm]	Cutting length / Długość / Miedź / cięcia [mm]	Cooper / Miedź [mm]	Cold rolled steel / Stal zimnowalcowana [mm]	Steel HRC35 / Stal HRC35 [mm]	SS 304 / Stal nierdzewna 304 [mm]	
YT-1970	260	42	2.0	1.4	1.0	1.0	6/36

EN Tin snips
PL Nożyce do cięcia blachy
DE Blechscherer
RU Ножницы по металлу
CZ Nůžky na plech
HU Lemezvágó olló

RO Foarfecă pt. tablă
FR Cisaille à tôle
IT Cesioie per lamiera
ES Tijera corta chapa
CN 航空剪

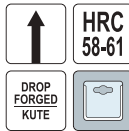

EN Tin snips
PL Nożyce do cięcia blachy
DE Blechscherer
RU Ножницы по металлу
CZ Nůžky na plech
HU Lemezvágó olló

RO Foarfecă pt. tablă
FR Cisaille à tôle
IT Cesioie per lamiera
ES Tijera corta chapa
CN 航空剪



YATO	L [mm]	Cutting length / Długość / Miedź / cięcia [mm]	Cooper / Miedź [mm]	Cold rolled steel / Stal zimnowalcowana [mm]	Steel HRC35 / Stal HRC35 [mm]	SS 304 / Stal nierdzewna 304 [mm]	
YT-1925	225	52	0.94	0.78	0.6	0.45	6/36

EN Tin snips
PL Nożyce do cięcia blachy
DE Blechscherer
RU Ножницы по металлу
CZ Nůžky na plech
HU Lemezvágó olló

RO Foarfecă pt. tablă
FR Cisaille à tôle
IT Cesioie per lamiera
ES Tijera corta chapa
CN 航空剪



YATO	L [mm]	Cutting length / Długość / Miedź / cięcia [mm]	Cooper / Miedź [mm]	Cold rolled steel / Stal zimnowalcowana [mm]	Steel HRC35 / Stal HRC35 [mm]	SS 304 / Stal nierdzewna 304 [mm]	
YT-1920	260	42	1.2	1.0	0.6	0.5	6/36

EN Tin snips
PL Nożyce do cięcia blachy
DE Blechscherer
RU Ножницы по металлу
CZ Nůžky na plech
HU Lemezvágó olló

RO Foarfecă pt. tablă
FR Cisaille à tôle
IT Cesioie per lamiera
ES Tijera corta chapa
CN 航空剪



S55C

HIGH FREQUENCY
HARDENING
HARTONANIE
IMPULSOWE



YATO	L [mm]	Cutting length / Długość / Miedź / cięcia [mm]	Cooper / Miedź [mm]	Cold rolled steel / Stal zimnowalcowana [mm]	Steel HRC35 / Stal HRC35 [mm]	SS 304 / Stal nierdzewna 304 [mm]	
YT-1924	254	52	0.94	0.78	0.6	0.45	6/36

EN Metal sheet nibbler
PL Ostrza zapasowe do nożyc matrycowych
DE Abbrechklingen für Blechnibbler
RU Лезвия для ножиц для резки жести
CZ Ostrí náhradní
HU Tartalékpenge
RO Lame de rezervă pt. forfecă tablă
FR Lame sécables pour grignoteuse a tole
IT Lama di ricambio per cesoia roditrice per lamiera
ES Cuchillas de recambio
CN 法式剪备用刀片



EN Spare blades for metal sheet nibbler
PL Ostrza zapasowe do nożyc matrycowych
DE Abbrechklingen für Blechnibbler
RU Лезвия для ножиц для резки жести
CZ Ostrí náhradní
HU Tartalékpenge
RO Lame de rezervă pt. forfecă tablă
FR Lame sécables pour grignoteuse a tole
IT Lama di ricambio per cesoia roditrice per lamiera
ES Cuchillas de recambio
CN 法式剪备用刀片



For YT-19260
Dla YT-19260

YATO	L [mm]	
YT-19260	260	6/36

YATO		
YT-19261		10/100

- EN Shears for cutting sheet metal
 PL Nożyce krawkowe do cięcia blach
 DE Rollenblechscherer
 RU Дискосовые ножницы для резки листового металла
 CZ Kotoučové nůžky na stříhání plechů
 HU Karos lemezvágó olló
 RO Foarfecă cu role pt. tăiere tablă
 FR Cisaille à tôle à molette
 IT Cesovia rotante per lamiera
 ES Cortador rotativo para chapa
 CN 手动钢板剪

120 mm



YATO	L [mm]	Cold rolled steel / Stal zimnowalcowana [mm]	Stainless steel / Stal nierdzwerna [mm]	Aluminium [mm]	
YT-18950	120	1.6	1.2	2.0	1

- EN Steel strap cutter
 PL Nożyce do cięcia taśmy stalowej
 DE Stahlgurblechscherer
 RU Ножницы для резки стальной ленты
 CZ Nůžky na plech
 HU Lemezvágó olló
- RO Foarfecă pt. tablă
 FR Cisaille à bande acier
 IT Cesovia per taglio reggetta in acciaio
 ES Tijeras para bandejas de acero
 CN 钢带剪

HRC 58-61



YATO	L [mm]	Cutting length / Długość cięcia [mm]	Steel HRC35 / Stal HRC35 [mm]	SS 304 / Stal nierdzwerna 304 [mm]	
YT-1930	305	28	0.8	0.6	6/24

- EN Bolt cutter
 PL Nożyce do pretów
 DE Bolzenschneider
 RU Болторез
 CZ Nůžky štípací na tyče
 HU Csapszegvágó olló
- RO Clește pt. buloane
 FR Coupe-boulon
 IT Tagliabulloni
 ES Cortavarillas
 CN 断线钳

HRC 56-61



YATO	L [mm]	Size / Rozmiar	max. Ø soft / maks. Ø miękkí [mm]	max. Ø medium / maks. Ø średnio twardy [mm]	
YT-1843	300	12"	5	4	20
YT-1844	350	14"	7	5	10
YT-1845	450	18"	8	6	10
YT-1846	600	24"	10	8	6
YT-1847	750	30"	13	10	4
YT-1848	900	36"	16	12	3

- EN Bolt cutter
 PL Nożyce do pretów
 DE Bolzenschneider
 RU Болторез
 CZ Nůžky štípací na tyče
 HU Csapszegvágó olló
- RO Clește pt. buloane
 FR Coupe-boulon
 IT Tagliabulloni
 ES Cortavarillas
 CN 断线钳

CrMo



YATO	L [mm]	Size / Rozmiar	max. Ø [mm]	
YT-1851	350	14"	6	6/24
YT-1852	450	18"	7	6/12
YT-1853	600	24"	10	2/12
YT-1854	750	30"	12	6
YT-1855	900	36"	14	4
YT-1856	1050	42"	16	2

- EN Bench mounted bolt cutter
 PL Nożyce do pretów stolowe
 DE Draht- und Kabelschneider Tischmodell
 RU Настольный болторез
 CZ Stoliňní nůžky na tyče
 HU Asztali csapszegvágó olló
 RO Foarfecă buloane pt. banc
 FR Coupe-boulon horizontal
 IT Tagliabulloni da appoggio
 ES Cortavarillas de mesa
 CN 多功能断线钳

max Ø 10 mm 600 mm HRC 58-62 CrMo



YATO	L [mm]	
YT-18410	600	2

- EN Bolt cutter
 PL Nożyce do drutu
 DE Drahtschere
 RU Ножницы для проволоки
 CZ Nůžky na drát
 HU Drótvágó olló
- RO Clește pt. tăiat sârmă
 FR Pince coupante pour fils
 IT Cesovia tagliafili
 ES Alicates para cortar alambre
 CN 断线钳

200 mm max Ø 3.5 mm CrV



YATO	L [mm]	max. Ø [mm]	
YT-18566	200	3.5	6/48

- EN Folding bolt cutter
 PL Nożyce do pretów składane
 DE Klappbarer Bolzenschneider
 RU Складной болторез
 CZ Nůžky na tyče skládací
 HU Öszecsukható csapszegvágó olló
 RO Clește pt. buloane pliabil
 FR Coupe-boulon pliable
 IT Tagliabulloni pieghevole
 ES Cortavarillas plegable
 CN 可折叠断线钳

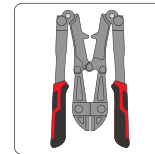

Ø 6.0 mm 450/280 mm CrMo



YATO	L [mm]	
YT-18413	450 (rozloženo), 280 (zložené)	10

- EN Concrete mesh cutter
 PL Nożyce do siatki zbrojarskiej
 DE Mattenschneider
 RU Ножницы для резки арматурной сетки
 CZ Pákové kleště na pletivo
 HU Gyékényvágó
 RO Clește pt. fier beton
 FR Coupe-trellis
 IT Cesovia per reti di rinforzo
 ES Cortante para varillas de encofrado
 CN 鹰嘴断线钳

800 mm max Ø 11 mm CrV



YATO	L [mm]	
YT-18400	800	5

- EN Wire rope cutter
 PL Nożyce do drutu i linek stalowych
 DE Kabel- und Drahtseilschere
 RU Ножницы арматурные
 CZ Štípací kleště na dráty a ocelová lanka
 HU Drótkötél vágó olló
 RO Foarfecă pt. cabluri de oțel și sârmă
 FR Pince coupante pour fils et câbles métalliques
 IT Cesovia per fili di ferro e funi di acciaio
 ES Tijeras para alambre y cables de acero
 CN 钢丝绳剪

190 mm max Ø 1.5 mm max Ø 4 mm HRC 58-62 CrV



YATO	Wire max. cutting diameter / Maks. średnica cięcia drutu [mm]	Steel line max. cutting diameter / Maks. średnica cięcia linki stalowej [mm]	
YT-18570	1.5	4	10/60



EN Hydraulic cutter
PL Ręczny obcinak hydrauliczny
DE Manueller Hydraulikscheider
RU Ручной гидравлический резак

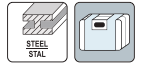

CZ Rucní hydraulický odřezávac
HU Kézi hidraulikus betonacélvágó
RO Cutter cu cilindru hidraulic
FR Coupe manuelle hydraulique

IT Cesoia idraulica manuale
ES Cortadora hidráulica manual
CN 液壓剪



∅ 4-12 mm
320 mm
6t

YATO 	Cutting diameter / Średnica cięcia [mm ²]	L [mm]	Force pressure / Siła nacisku [t]	
YT-22870	4-12	320	6	5



YATO 	Cutting diameter / Średnica cięcia [mm ²]	L [mm]	Force pressure / Siła nacisku [t]	
YT-22871	4-16	430	8	5
YT-22872	4-20	515	13	3

EN Heads for hydraulic cutter
PL Noże wymienne do obcinaka hydraulicznego
DE Austauschmesser für Hydraulikscheider
RU Сменные ножи для гидравлического резака
CZ Vyměnitelné nože do hydraulického odřezávac
HU Cserekes a hidraulikus betonacélvágóhoz
RO Cuțite pt. cutter hidraulic de cabluri
FR Lame pour coupe manuelle hydraulique
IT Teste per coltelli idraulici
ES Cuchillas intercambiables para cortadora hidráulica
CN 液壓鉗鉗口配件



2
PCS



YATO 	Size / Rozmiar [mm]	For / Dla	
YT-22873	12	YT-22870	10/100
YT-22874	16	YT-22871	10/100
YT-22875	20	YT-22872	10/100

EN Hydraulic metal hole puncher
PL Wycinak hydrauliczny otworów w blachach
DE Hydraulischer Blechlocher
RU Инструмент для просекания отверстий гидравлический ручной
CZ Hydraulický vysekávač otvorů v plechu
HU Hidraulikus lemezlyukasztó
RO Perforator hidraulic pt. metal
FR Emporte-pièce hydraulique à tôle
IT Punzonatrice idraulica per lamiera
ES Cortador hidráulico de agujeros en hojas de chapa
CN 液壓開孔器





∅ 22-60 mm

6t

max 3mm

360°



YATO 	Cutting diameter / Średnica cięcia [mm]	Force pressure / Siła nacisku [t]	
YT-18900	22-60	6	2

EN Hydraulic metal hole puncher
PL Wycinak hydrauliczny otworów w blachach
DE Hydraulischer Blechlocher
RU Инструмент для просекания отверстий гидравлический ручной
CZ Hydraulický vysekávač otvorů v plechu
HU Hidraulikus lemezlyukasztó
RO Perforator hidraulic pt. metal
FR Emporte-pièce hydraulique à tôle
IT Punzonatrice idraulica per lamiera
ES Cortador hidráulico de agujeros en hojas de chapa
CN 液壓開孔器





∅ 22-60 mm

6t

max 4mm



YATO 	Cutting diameter / Średnica cięcia [mm]	Force pressure / Siła nacisku [t]	
YT-18907	22-60	6	1

EN Multi-function scissors
 PL Nożyce wielofunkcyjne
 DE Multifunktionsmesser
 RU Ножницы многофункциональные
 CZ Všeúčelové nůžky
 HU Többfunkciós olló
 RO Foarfecă multifuncțională
 FR Ciseaux universelle
 IT Cesioie multifunzione
 ES Tijeras multifuncionales
 CN 不锈钢多用剪

65/200 mm HRC 50-54
 3Cr13



YATO	L [mm]	
YT-1976	200	12/72

EN Multi-function slot angle scissors
 PL Nożyce do cięć kątowych (ukośnych)
 DE Winkelschere (schräg)
 RU Ножницы для резы под углом (по диагонали)
 CZ Nůžky pro šikmé stříhání
 HU Gérvágó olló
 RO Clește pt. tăiat la unghi
 FR Ciseaux d'angle
 IT Forbici per tagli angolari (diagonali)
 ES Tijera de inglete
 CN 角度剪

245 mm ± 22.5° 45° 90°
 SS STAINLESS STEEL STAL MERCEZINA AI



YATO	L [mm]	
YT-18960	245	4/24

EN HD multifunctional scissors
 PL Nożyce techniczne wielofunkcyjne
 DE Multifunktionale technische Schere
 RU Технические многофункциональные ножницы
 CZ Multifunkční technické nůžky
 HU Műszaki olló - multifunkciós
 RO Foarfecă tehnică multifuncțională
 FR Ciseaux polyvalentes
 IT Cesioie tecniche multifunzione
 ES Tijera técnica multiusos
 CN 剪刀

250 mm SK5
 Cr12Mo



YATO	L [mm]	
YT-18963	250	6/24

EN Hand saw for wood
 PL Pila pilniczna do drewna
 DE Handsäge für Holz
 RU Ручная пила по дереву
 CZ Ruční pila na dřevo
 HU Rókafarkú fűrész
 RO Fierastrău „coada de vulpe” pt. lemn
 FR Scie égoïne à bois
 IT Segaccio per legno
 ES Serrucho para carpintero
 CN 手板锯

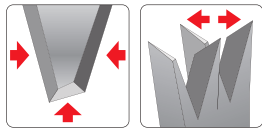

7TPI 1.6 mm 0.9 mm
 HRC 50-54 65Mn



YATO	L [mm]	
YT-3101	400	12/48
YT-3102	450	10/40
YT-3103	500	10/40

EN Hand saw for wood
 PL Pila pilniczna do drewna
 DE Handsäge für Holz
 RU Ручная пила по дереву
 CZ Ruční pila na dřevo
 HU Rókafarkú fűrész
 RO Fierastrău „coada de vulpe” pt. lemn
 FR Scie égoïne à bois
 IT Segaccio per legno
 ES Serrucho para carpintero
 CN 手板锯

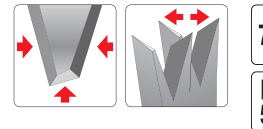

7TPI 1.6 mm 0.9 mm
 HRC 50-54 PTFE 65Mn



YATO	L [mm]	
YT-3106	400	12/48
YT-3107	450	10/40
YT-3108	500	10/40

EN Hand saw for wood
 PL Pila pilniczna do drewna
 DE Handsäge für Holz
 RU Ручная пила по дереву
 CZ Ruční pila na dřevo
 HU Rókafarkú fűrész
 RO Fierastrău „coada de vulpe” pt. lemn
 FR Scie égoïne à bois
 IT Segaccio per legno
 ES Serrucho para carpintero
 CN 手板锯

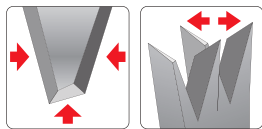

7TPI 1.6 mm 0.9 mm
 PTFE 65Mn



YATO	L [mm]	
YT-31091	400	6/24
YT-31092	450	6/24
YT-31093	500	6/24

EN Hand saw for wood
 PL Pila pilniczna do drewna
 DE Handsäge für Holz
 RU Ручная пила по дереву
 CZ Ruční pila na dřevo
 HU Rókafarkú fűrész
 RO Fierastrău „coada de vulpe” pt. lemn
 FR Scie égoïne à bois
 IT Segaccio per legno
 ES Serrucho para carpintero
 CN 手板锯

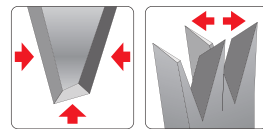

7TPI 65Mn
 PTFE



YATO	L [mm]	
YT-31095	350	12/48
YT-31096	400	12/48
YT-31097	450	12/48

EN Back saw for PVC
 PL Pila ręczna do PVC
 DE Handsäge für PVC
 RU Ручная пила для ПВХ
 CZ Ruční pila na PVC
 HU Kézifűrész PVC-hez

RO Fierastrău cu maner PVC
 FR Scie à main pour PVC
 IT Segà a mano per PVC
 ES Sierra de mano para PVC
 CN 鋸

PVC 350/440 mm 17 TPI 65Mn



YATO	L [mm]	
YT-31303	440	12/48

EN Japanese saw
 PL Pila japońska
 DE Japanische Handsäge
 RU Ножовка японского типа
 CZ Japonská ruka pila
 HU Japán fűrész

RO Fierăstrău japonez
 FR Scie japonaise
 IT Segà reversibile giapponese
 ES Sierra japonesa
 CN 双面齿拉锯

320/660 mm 7TPI 12 TPI SK5



YATO	L [mm]	
YT-31310	660	10/40

EN Drywall saw
PL Pila dwustronna do płyt gipsowo-kartonowych
DE Gipskartonsäge
RU Ножовка по гипсокартону

CZ Pila na sádrokarton
HU Kézi gipszkarton fűrész
RO Cuiț pt. plăci de rigips
FR Scie à guichet

IT Sega per pannelli in cartongesso
ES Serrucho para placas de yeso
CN 墙板锯



YATO	L [mm]	
YT-31343	315	12/96

EN Saw with adjustable handle
PL Pila z przestawianą rękojeścią
DE Säge mit verstellbarem Griff
RU Пила с регулируемой ручкой
CZ Pila s nastaviteľnou rukovetí
HU Fűrész állítható markolattal

RO Fierăstrău cu mâner reversibil
FR Scie à poignée réglable
IT Sega con maniglia regolabile
ES Sierra con mango móvil
CN 调节锯



YATO	L [mm]	
YT-31290	410	6/48

EN Back saw
PL Pila grzbietnica
DE Rücksäge
RU Пила для ступла

CZ Pila hřebenovka
HU Kézifűrész
RO Ferăstrău coadă de vulpe
FR Scie

IT Sega con dorso
ES Serrucho de costilla
CN 夹背锯

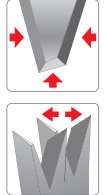

YATO	L [mm]	
YT-3130	300	12/60

EN Compass saw
PL Pila otwornica
DE Stichsäge

RU Выкружная пила
CZ Pila otvornice
HU Lyukfűrész

RO Fierăstrău coadă de șoarece
FR Scie étroite
IT Sega a foretto

ES Serrucho de punta
CN 鸡尾锯



YATO	L [mm]	
YT-3133	300	12/60

EN Wallboard saw
PL Pila do gipsów
DE Gipsäge

RU Ножовка по гипсокартону
CZ Pila na sádrú
HU Gipszfűrész

RO Fierăstrău pt. rigips
FR Scie pour plaques de plâtre
IT Sega per cartongesso

ES Serrucho para cartón yeso
CN 墙板锯



YATO	L [mm]	
YT-3134	300	12/60

EN Plastic miter box with dovetail saw
PL Plastikowa skrzynka uciosowa z piłą
DE Kunststoffschneidladen mit Säge
RU Ступно пластмассовое с пилой
CZ Přípravek na řezání úhlu s pilkou
HU Gэрbevágó műanyagláda hódítarkú fűrészszel
RO Fierăstrău cu dispozitiv de taiat la unghi
FR Boîte à onglets + scie
IT Taglia cornici in plastica con sega
ES Guía de ingletar y sierra
CN 燕尾锯



YATO	L [mm]	
YT-3150	350	10

EN Bow saw
PL Pila kabląkowa
DE Bügelsäge
RU Лучковая пила
CZ Oblouková pila
HU Keretes fűrész

RO Fierăstrău tip arc
FR Scie à archet
ES Sierra de arco
CN 弓锯



YATO	L [mm]	
YT-3200	300	12/24



YATO	L [mm]	
YT-3201	450	12/24
YT-3202	530	12/24
YT-3203	610	12/24
YT-3204	760	12/24

EN Bow saw blade for dry wood
 PL Brzeczczot do drewna suchego
 DE BÜgelsägeblatt für trockenes Holz
 RU Полотно для лучковой пилы по сухому дереву
 CZ Pilový list na suché dřevo
 HU Keretes fűrészhez fűrészlap száraz fához

RO Lamă pt. lemn uscat
 FR Lame pour bois sec
 IT Lama per legno secco
 ES Hoja de sierra para madera seca
 CN 干木锯条



YATO	L [mm]	
YT-3221	450	50/200
YT-3222	530	50/200
YT-3223	610	50/200
YT-3224	760	50/200

EN Bow saw blade for wet wood
 PL Brzeczczot do drewna mokrego
 DE BÜgelsägeblatt für frisches Holz
 RU Полотно для лучковой пилы по влажному дереву
 CZ Pilový list na mokré dřevo
 HU Keretes fűrészhez fűrészlap nedves fához

RO Lamă pt. lemn verde
 FR Lame pour bois humide
 IT Lama per legno bagnato
 ES Hoja de sierra para madera húmeda
 CN 湿木锯条



YATO	L [mm]	
YT-3230	300	50/200
YT-3231	450	50/200
YT-3232	530	50/200
YT-3233	610	50/200
YT-3234	760	50/200

EN Hacksaw frame
 PL Pila do metalu
 DE Metallbogensäge
 RU Пила по металлу

CZ Pílka na železo
 HU Fémfűrész
 RO Fierăstrău pt. metal
 FR Scie à métal

IT Seghetto per metallo
 ES Sierra de metalo
 CN 锯架



YATO	L [mm]	
YT-3160	300	10

YATO	L [mm]	
YT-3161	300	6/36

YATO	L [mm]	
YT-3163	300	5/20

EN Metal hacksaw
 PL Pila do metalu
 DE Metallsäge
 RU Ножовка по металлу
 CZ Pila na kov
 HU Fémfűrész
 RO Fierăstrău pt. metal
 FR Scie à métaux
 IT Seghetto per metallo
 ES Sierra para metales
 CN 金属钢锯

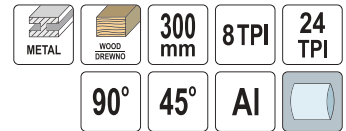

YATO	L [mm]	
YT-31612	300	12/36

EN Hacksaw blade for metal
 PL Brzeczczot do metalu
 DE Metallsägeblatt
 RU Полотно по металлу

CZ Pilový list na kov
 HU Fémfűrészlap
 RO Pânze fierăstrău pt. metal
 FR Lame de scie à métaux

IT Lama per metallo
 ES Hoja de sierra para metal
 CN 钢锯条



YATO	L [mm]	W [mm]	TPI	pcs / szt.	
YT-3460	300	12	24	5	10/200

YATO	L [mm]	W [mm]	TPI	pcs / szt.	
YT-3461	300	12	24	2	20/500

YATO	L [mm]	W [mm]	TPI	pcs / szt.	
YT-3462	300	12	24	2	20/500

EN Band saw blade
 PL Brzeczczot do pily taśmowej
 DE Bandsägeblätter
 RU Полотно для ленточной пилы
 CZ Pilový pás na pásovou pilu
 HU Szalagfűrészlap
 RO Panza pt. fierăstrău cu banda
 FR Lame de scie à ruban
 IT Lama per sega a nastro
 ES Hoja de sierra de cinta
 CN 带锯锯条

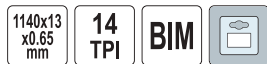

For YT-82185
 Dla YT-82185

YATO	L [mm]	W [mm]	TPI	
YT-82189	1140	0.65	14	20

EN Air saw blades
 PL Brzeczczoty do wyrzynarki
 DE Stichsägeblätter
 RU Полотно для пневмопилы сабельной
 CZ Pilové listy pro pneumatické přímočaré pily
 HU Fűrészlapok pneumatikus fűrészekhez

RO Lame rezervă fierăstrău pneumatic
 FR Lames de scie sabre pneumatique
 IT Lame per seghetti pneumatici
 ES Hojas de sierra de calar
 CN 锯片



For YT-09955
 Dla YT-09955

YATO	TPI	
YT-09958	24	50/200
YT-09959	32	50/200

EN Sabre saw blade
PL Brzeszczot do cegieł i pustaków
DE Säbelsägeblatt
RU Пильное полотно
CZ Pilový plátek do pily ocasky
HU Szablyafűrészlap
IT Lama per mattoni e mattoni cavi
ES Hoja de sierra sable
RO Pânză pt. fierăstrău sabie
CN 硬质合金锯条

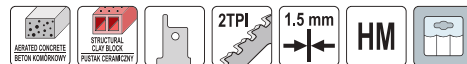

YATO	L [mm]	
YT-33951	300	20/100
YT-33950	455	25/100

EN Sabre saw blade
PL Brzeszczot do pily szablastej
DE Säbelsägeblatt
RU Пильное полотно
CZ Pilový plátek do pily ocasky
HU Szablyafűrészlap
RO Pânză pt. fierăstrău sabie
FR Lame de scie sabre
IT Lama per sega a gattuccio
ES Hoja de sierra sable
CN 往复锯条



WET WOOD DREWNO WROK
300 mm HCS
For YT-82280, YT-82814, YT-82904
Dla YT-82280, YT-82814, YT-82904

YATO	L [mm]	+/- [mm]	TPI	
YT-33920	300	1.45	5	10/100



For YT-82281, YT-82814, YT-82815, YT-82904
Dla YT-82281, YT-82814, YT-82815, YT-82904



For YT-82280, YT-82814, YT-82904
Dla YT-82280, YT-82814, YT-82904



For YT-82280, YT-82814, YT-82904
Dla YT-82280, YT-82814, YT-82904

YATO	L [mm]	+/- [mm]	TPI	
YT-33921	150	1.2	4	50/200
YT-33922	150	1.0	6	10/200
YT-33923	150	1.0	8	10/200

YATO	L [mm]	+/- [mm]	TPI	
YT-33930	150	1.0	10	10/200

YATO	L [mm]	+/- [mm]	TPI	
YT-33931	150	1.0	18	10/200
YT-33932	150	1.0	24	10/200



For YT-82280, YT-82814, YT-82904
Dla YT-82280, YT-82814, YT-82904



For YT-82280, YT-82814, YT-82904
Dla YT-82280, YT-82814, YT-82904



For YT-82280, YT-82814, YT-82904
Dla YT-82280, YT-82814, YT-82904

YATO	L [mm]	+/- [mm]	TPI	
YT-33933	225	1.0	10	10/200

YATO	L [mm]	+/- [mm]	TPI	
YT-33934	225	1.0	24	50/200

YATO	L [mm]	+/- [mm]	TPI	
YT-33935	300	1.25	6	50/100

EN Sabre saw blade
PL Brzeszczot do pily szablastej
DE Säbelsägeblatt
RU Пильное полотно
CZ Pilový plátek do pily ocasky
HU Szablyafűrészlap
RO Pânză pt. fierăstrău sabie
FR Lame de scie sabre
IT Lama per sega a gattuccio
ES Hoja de sierra sable
CN 往复锯条

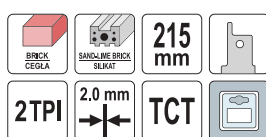

YATO	L [mm]	+/- [mm]	TPI	
YT-33960	215	2.0	2	100/200

EN Sabre saw blade
PL Brzeszczot do pily szablastej
DE Säbelsägeblatt
RU Пильное полотно
CZ Pilový plátek do pily ocasky
HU Szablyafűrészlap
RO Pânză pt. fierăstrău sabie
FR Lame de scie sabre
IT Lama per sega a gattuccio
ES Hoja de sierra sable
CN 往复锯条



• For straight cuts
• Doesn't bend when cuts
• Do cięć na wprost
• Nie wygina się podczas cięcia

For YT-82281, YT-82814, YT-82815, YT-82904
Dla YT-82281, YT-82814, YT-82815, YT-82904

YATO	L [mm]	+/- [mm]	TPI	
YT-33970	230	1.0	12	10/80

EN Sabre saw blade
PL Brzeszczot do pily szablastej
DE Säbelsägeblatt
RU Пильное полотно
CZ Pilový plátek do pily ocasky
HU Szablyafűrészlap
RO Pânză pt. fierăstrău sabie
FR Lame de scie sabre
IT Lama per sega a gattuccio
ES Hoja de sierra sable
CN 往复锯条

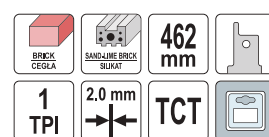

YATO	L [mm]	+/- [mm]	TPI	
YT-33961	462	2.0	1	25/50

EN Sabre saw blade
PL Brzeszczot do pily szablastej
DE Säbelsägeblatt
RU Пильное полотно
CZ Pilový plátek do pily ocasky
HU Szablyafűrészlap
RO Pânză pt. fierăstrău sabie
FR Lame de scie sabre
IT Lama per sega a gattuccio
ES Hoja de sierra sable
CN 往复锯条



• For straight cuts
• Doesn't bend when cuts
• Do cięć na wprost
• Nie wygina się podczas cięcia

For YT-82281, YT-82814, YT-82815, YT-82904
Dla YT-82281, YT-82814, YT-82815, YT-82904

YATO	L [mm]	+/- [mm]	TPI	
YT-33971	230	1.2	6	10/100

EN Sabre saw blade
 PL Brzeczczot do pily szablastej
 DE Säbelsägeblatt
 RU Пильное полотно
 CZ Pílový plátek do pily ocasky
 HU Szablyafűrészlap

RO Pânză pt. fierăstrău sabie
 FR Lame de scie sabre
 IT Lama per sega a gattuccio
 ES Hoja de sierra sable
 CN 往复锯条



120 mm 12 TPI 1.2 mm HCS

For YT-82281, YT-82814, YT-82815, YT-82904
 Dla YT-82281, YT-82814, YT-82815, YT-82904

• For plunge and curve cuts

• Do cięć wglębnych i po łuku

YATO	L [mm]	↳ [mm]	TPI	📦
YT-33972	120	1.2	12	10/100

EN Jig saw blades
 PL Brzeczczoty do wyrzynarki
 DE Stichsägeblätter

RU Полотна для лобзика
 CZ Pílové plátky pro přímochařé pily
 HU Dekopír fűrészlapok

RO Pânze pt. fierăstrău pendular
 FR Lames de scie sauteuse
 IT Lame per seghetti alternativi

ES Hojas de sierra de calar
 CN 曲线锯条

5 PCS

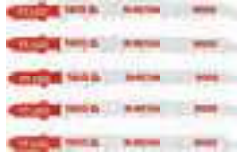

STEEL STEEL 100/75 mm 6TPI 1.27 mm BI-METAL

WOOD DREWING PVC 100/75 mm 10 TPI 1.3 mm HCS 65Mn

YATO	L [mm]	Working length / Długość robocza [mm]	↳ [mm]	TPI	📦
YT-3400	100	75	1.27	6	50/250

YATO	L [mm]	Working length / Długość robocza [mm]	↳ [mm]	TPI	📦
YT-3401	100	75	1.3	10	50/250



WOOD DREWING 100/75 mm 8TPI 1.2 mm HCS 65Mn

WOOD DREWING 100/75 mm 6TPI 1.3 mm HCS 65Mn

YATO	L [mm]	Working length / Długość robocza [mm]	↳ [mm]	TPI	📦
YT-3402	100	75	1.2	8	50/250

YATO	L [mm]	Working length / Długość robocza [mm]	↳ [mm]	TPI	📦
YT-3403	100	75	1.3	6	50/250



WOOD DREWING LAMINATE 100/75 mm CLEAN CUT / CZYSTE CIĘCIE HCS 65Mn

WOOD DREWING 100/75 mm 6TPI 1.3 mm HCS 65Mn

YATO	L [mm]	Working length / Długość robocza [mm]	↳ [mm]	TPI	📦
YT-3404	100	75	1.3	10	50/250

YATO	L [mm]	Working length / Długość robocza [mm]	↳ [mm]	TPI	📦
YT-3405	100	75	1.3	6	50/250



WOOD DREWING 100/75 mm 13 TPI 1.0 mm HCS 65Mn

WOOD DREWING 115/90 mm 13-8 TPI PLUNGE CUT / CIĘCIE WGLĘBNE HCS 65Mn

YATO	L [mm]	Working length / Długość robocza [mm]	↳ [mm]	TPI	📦
YT-3407	75	50	1.0	13	50/250

YATO	L [mm]	Working length / Długość robocza [mm]	↳ [mm]	TPI	📦
YT-3408	115	90	1.3	13-8	50/250



WOOD DREWING 115/90 mm 8TPI 1.3 mm HCS 65Mn

WOOD DREWING 100/75 mm 6TPI 1.4 mm HCS 65Mn

YATO	L [mm]	Working length / Długość robocza [mm]	↳ [mm]	TPI	📦
YT-3409	115	90	1.3	8	50/250

YATO	L [mm]	Working length / Długość robocza [mm]	↳ [mm]	TPI	📦
YT-3410	100	75	1.4	6	50/250

EN Jig saw blades
PL Brzeszczoły do wyrzynarki
DE Stichsägeblätter

RU Полотна для лобзика
CZ Pilové plátky pro přimočaré pily
HU Dekopír fűrészlapok

RO Pânze pt. fierăstrău pendular
FR Lames de scie sauteuse
IT Lama per seghetti alternativi

ES Hojas de sierra de calar
CN 曲线锯条

5
PCS



YATO	L [mm]	Working length / Długość robocza [mm]	± [mm]	TPI	
YT-3411	100	75	1.0	8	25/250

YATO	L [mm]	Working length / Długość robocza [mm]	± [mm]	TPI	
YT-3412	75	50	1.0	21	25/250

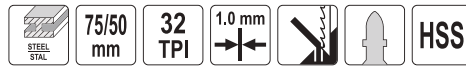

YATO	L [mm]	Working length / Długość robocza [mm]	± [mm]	TPI	
YT-3413	75	50	1.0	12	25/250

YATO	L [mm]	Working length / Długość robocza [mm]	± [mm]	TPI	
YT-3414	75	50	1.0	32	25/250



YATO	L [mm]	Working length / Długość robocza [mm]	± [mm]	TPI	
YT-3415	100	75	1.0	24-10	25/250

YATO	L [mm]	Working length / Długość robocza [mm]	± [mm]	TPI	
YT-3416	130	106	1.0	21	25/250

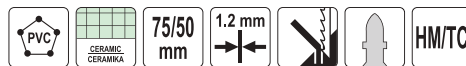
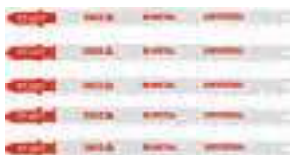

YATO	L [mm]	Working length / Długość robocza [mm]	± [mm]	TPI	
YT-3417	130	106	1.27	10-5	25/250

YATO	L [mm]	Working length / Długość robocza [mm]	± [mm]	TPI	
YT-3421	75	50	1.2		25/250

EN Jig saw blades
PL Brzeszczoły do wyrzynarki
DE Stichsägeblätter
RU Полотна для лобзика
CZ Pilové plátky pro přimočaré pily
HU Dekopír fűrészlapok
RO Pânze pt. fierăstrău pendular
FR Lames de scie sauteuse
IT Lama per seghetti alternativi
ES Hojas de sierra de calar
CN 曲线锯条

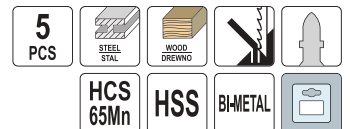

YATO	L [mm]	Working length / Długość robocza [mm]	± [mm]	TPI	
YT-3445	100, 100, 100, 75, 75	75, 75, 75, 50, 57	1.3, 1.3, 1.27, 1.0, 1.0	10, 6, 10, 32, 12	25/250

EN Half-moon saw blade for oscillating multitool HSS
 PL Brzeszczot okrągły HSS do narzędzia wielofunkcyjnego
 DE Rundes Sägeblatt HSS für Multifunktionswerkzeug
 RU Дискоее полотно HSS для многофункционального инструмента
 CZ Segmentový pilový list HSS pro multifunkční nářadí
 HU HSS kör keresztmetszetű fűrészlap multifunkciós szerszámhoz
 RO Lamă semicirculară HSS pt. unealta multifuncțională
 FR Lame segment HSS pour outil multifonction
 IT Lama di sega circolare per lo strumento multi-funzione HSS
 ES Hoja redonda HSS para herramienta multifuncional
 CN 半圆形摆动锯

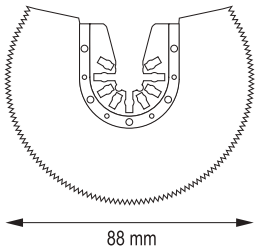
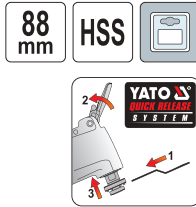

88 mm

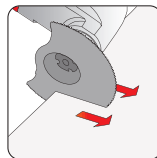

• Application: wood, plastic, soft metal, plaster
 • Zastosowanie: drewno, plastik, miękki metal, gips

For YT-82220, YT-82818, YT-82900
 Dla YT-82220, YT-82818, YT-82900

YATO **YT-34680** 10/100

EN Half-moon saw blade for oscillating multitool HCS
 PL Brzeszczot okrągły HCS do narzędzia wielofunkcyjnego
 DE Rundes Sägeblatt HCS für Multifunktionswerkzeug
 RU Дискоее полотно HCS для многофункционального инструмента
 CZ Segmentový pilový list HCS pro multifunkční nářadí
 HU HCS kör keresztmetszetű fűrészlap multifunkciós szerszámhoz
 RO Lamă semicirculară HCS pt. unealta multifuncțională
 FR Lame segment HCS pour outil multifonction
 IT Lama di sega circolare per lo strumento multi-funzione HCS
 ES Hoja redonda HCS para herramienta multifuncional
 CN 高碳钢扇型锯片

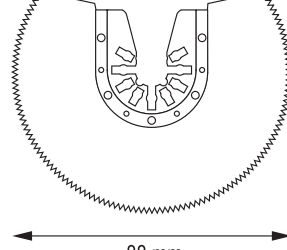
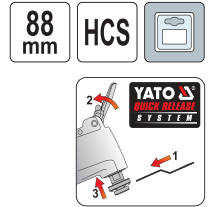

88 mm

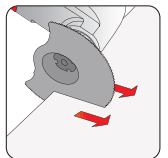

• Application: wood, plastic, soft metal, plaster
 • Zastosowanie: drewno, plastik, miękki metal, gips

For YT-82220, YT-82818, YT-82900
 Dla YT-82220, YT-82818, YT-82900

YATO **YT-34681** 10/100

EN Brazed carbide d-shape blade for oscillating multitool HM
 PL Brzeszczot okrągły HM do narzędzia wielofunkcyjnego
 DE Rundes Sägeblatt HM für Multifunktionswerkzeug
 RU Дискоее полотно HM для многофункционального инструмента
 CZ Segmentový pilový list HM pro multifunkční nářadí
 HU HM kör keresztmetszetű fűrészlap multifunkciós szerszámhoz
 RO Lamă rotundă HM pt. unealta multifuncțională
 FR Lame segment HM pour outil multifonction
 IT Lama di sega circolare per lo strumento multi-funzione HM
 ES Hoja redonda HM para herramienta multifuncional
 CN 摆动锯

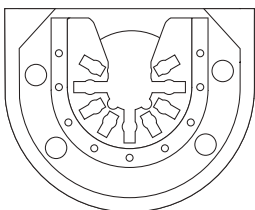
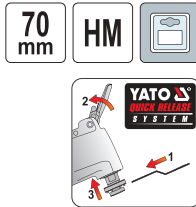

70 mm

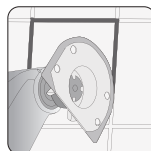

• Application: concrete, ceramic materials, epoxy resin, fibreglass
 • Zastosowanie: beton, materiały ceramiczne, żywica epoksydowa, włókno szklane

For YT-82220, YT-82818, YT-82900
 Dla YT-82220, YT-82818, YT-82900

YATO **YT-34682** 10/100

EN Half-moon saw blade for oscillating multitool BIM
 PL Brzeszczot półokrągły BIM do narzędzia wielofunkcyjnego
 DE Rundes Sägeblatt BIM für Multifunktionswerkzeug
 RU Дискоее полотно BIM для многофункционального инструмента
 CZ Segmentový pilový list BIM pro multifunkční nářadí
 HU BIM kör keresztmetszetű fűrészlap multifunkciós szerszámhoz
 RO Lamă semicirculară BIM pt. unealta multifuncțională
 FR Lame segment BIM pour outil multifonction
 IT Lama di sega circolare per lo strumento multi-funzione BIM
 ES Hoja redonda BIM para herramienta multifuncional
 CN 多功能锯片

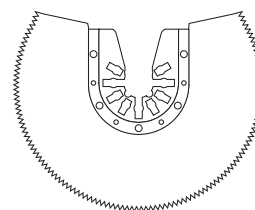
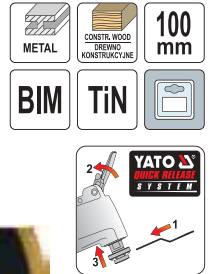

100 mm

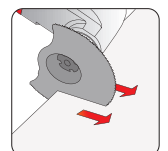

• Application: wood, metal
 • Zastosowanie: drewno, metal

For YT-82220
 Dla YT-82220

YATO **YT-34711** 10/100

EN Half-moon saw blade for oscillating multitool BIM
 PL Brzeszczot półokrągły BIM do narzędzia wielofunkcyjnego
 DE Rundes Sägeblatt BIM für Multifunktionswerkzeug
 RU Дисквое полотно BIM для многофункционального инструмента
 CZ Segmentový pilový list BIM pro multifunkční nářadí
 HU BIM kör keresztmetszetű fűrészlap multifunkciós szerszámhoz
 RO Lamă semirotundă BIM pt. unealtă multifuncțională
 FR Lame segment BIM pour outils multifonctions
 IT Lama di sega circolare per lo strumento multi-funzione BIM
 ES Hoja redonda BIM para herramienta multifuncional
 CN 多功能锯片

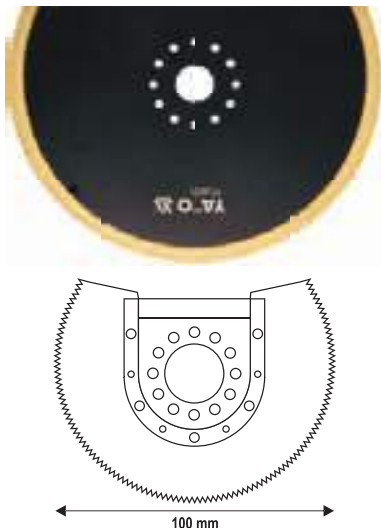
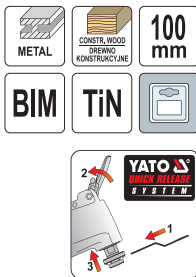

• Application: wood, metal
 • Zastosowanie: drewno, metal

For YT-82223
 Dla YT-82223



EN Plunge cutting saw blade for oscillating multitool BIM
 PL Brzeszczot wgłębny BIM do narzędzia wielofunkcyjnego
 DE Tiefenmesser BIM für Multifunktionswerkzeug
 RU Сабельное полотно BIM для многофункционального инструмента
 CZ Pilový list BIM na ponorné řezy pro multifunkční nářadí
 HU BIM merülő fűrészlap multifunkciós szerszámhoz
 RO Lamă BIM pt. unealtă oscilantă multifuncțională
 FR Lame scie plongeante BIM pour outil multifonction
 IT Lama per tagli dal pieno BIM
 ES Hoja para cortes profundos BIM para herramienta multifuncional
 CN 锯片

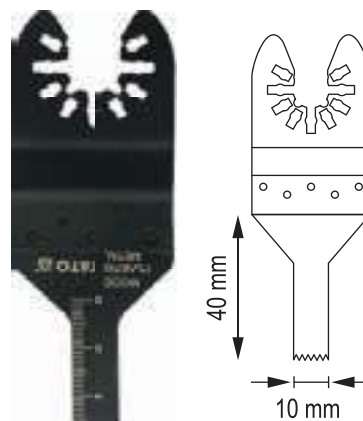
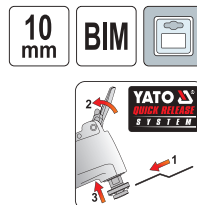

• Application: wood, plastic, metal, plaster, epoxy resin
 • Zastosowanie: drewno, plastik, metal, gips, żywica epoksydowa

For YT-82220, YT-82818, YT-82900
 Dla YT-82220, YT-82818, YT-82900



EN Plunge cutting saw blade for oscillating multitool BIM
 PL Brzeszczot wgłębny BIM do narzędzia wielofunkcyjnego
 DE Tiefenmesser BIM für Multifunktionswerkzeug
 RU Сабельное полотно BIM для многофункционального инструмента
 CZ Pilový list BIM na ponorné řezy pro multifunkční nářadí
 HU BIM merülő fűrészlap multifunkciós szerszámhoz
 RO Lamă BIM pt. unealtă oscilantă multifuncțională
 FR Lame scie plongeante BIM pour outil multifonction
 IT Lama per tagli dal pieno BIM
 ES Hoja para cortes profundos BIM para herramienta multifuncional
 CN 锯片

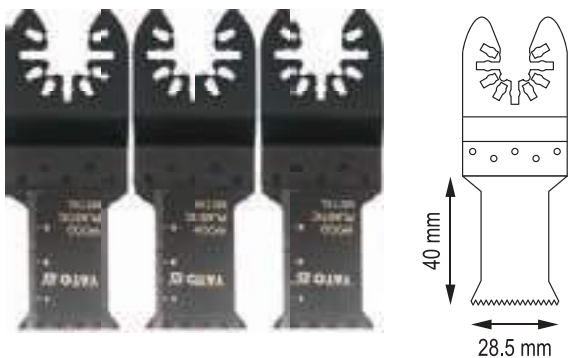
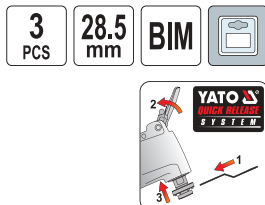

• Application: wood, plastic, metal, plaster, epoxy resin
 • Zastosowanie: drewno, plastik, metal, gips, żywica epoksydowa

For YT-82220, YT-82818, YT-82900
 Dla YT-82220, YT-82818, YT-82900



EN Plunge cutting saw blade for oscillating multitool HCS
 PL Brzeszczot wgłębny HCS do narzędzia wielofunkcyjnego
 DE Tiefenmesser HCS für Multifunktionswerkzeug
 RU Сабельное полотно HCS для многофункционального инструмента
 CZ Pilový list HCS na ponorné řezy pro multifunkční nářadí
 HU HCS merülő fűrészlap multifunkciós szerszámhoz
 RO Lamă HCS pt. unealtă oscilantă multifuncțională
 FR Lame scie plongeante HCS pour outil multifonction
 IT Lama per tagli dal pieno HCS
 ES Hoja para cortes profundos HCS para herramienta multifuncional
 CN 锯片

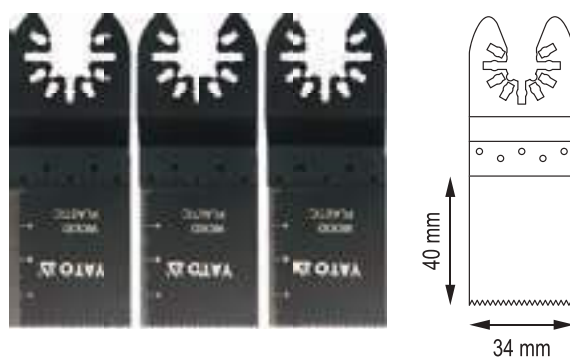
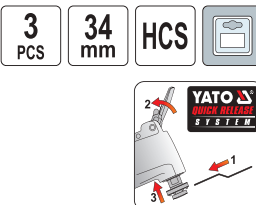

• Application: wood, plastic, plaster
 • Zastosowanie: drewno, plastik, gips

For YT-82220, YT-82818, YT-82900
 Dla YT-82220, YT-82818, YT-82900



EN Plunge cutting saw blade for oscillating multitool BIM
 PL Brzeczczot wglębny BIM do narzędzia wielofunkcyjnego
 DE Tiefenmesser BIM für Multifunktionswerkzeug
 RU Сабельное полотно BIM для многофункционального инструмента
 CZ Pílavý list BIM na ponorné řezy pro multifunkční nářadí
 HU BIM merülő fűrészlap multifunkciós szerszámhoz
 RO Lamă BIM pt. unealtă oscilantă multifuncțională
 FR Lame scie plongeante BIM pour outils multifonctions
 IT Lama per tagli dal pieno BIM
 ES Hoja para cortes profundos BIM para herramienta multifuncional
 CN 锯片

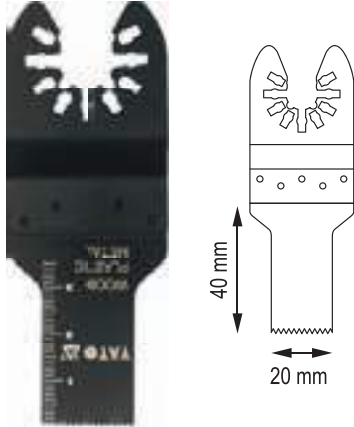
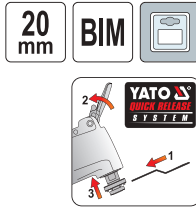

• Application: wood, plastic, metal, plaster, epoxy resin
 • Zastosowanie: drewno, plastik, metal, gips, żywica epoksydowa

For YT-82220, YT-82818, YT-82900
 Dla YT-82220, YT-82818, YT-82900

YATO **YT-34686** 10/100

EN Plunge cutting saw blade for oscillating multitool BIM
 PL Brzeczczot wglębny BIM do narzędzia wielofunkcyjnego
 DE Tiefenmesser BIM für Multifunktionswerkzeug
 RU Сабельное полотно BIM для многофункционального инструмента
 CZ Pílavý list BIM na ponorné řezy pro multifunkční nářadí
 HU BIM merülő fűrészlap multifunkciós szerszámhoz
 RO Lamă BIM pt. unealtă oscilantă multifuncțională
 FR Lame plongeante BIM pour outils multifonctions
 IT Lama per tagli dal pieno BIM
 ES Hoja para cortes profundos BIM para herramienta multifuncional
 CN 锯片

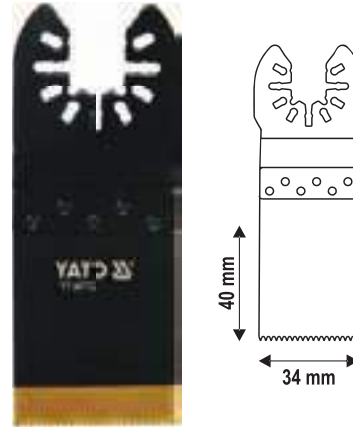
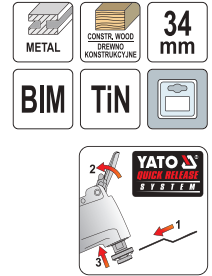

• Application: wood, metal
 • Zastosowanie: drewno, metal

For YT-82220
 Dla YT-82220

YATO **YT-34712** 10/100

EN Plunge cutting saw blade for oscillating multitool HCS
 PL Brzeczczot wglębny HCS do narzędzia wielofunkcyjnego
 DE Tiefenmesser HCS für Multifunktionswerkzeug
 RU Сабельное полотно HCS для многофункционального инструмента
 CZ Pílavý list HCS na ponorné řezy pro multifunkční nářadí
 HU HCS merülő fűrészlap multifunkciós szerszámhoz
 RO Lamă HCS pt. unealtă oscilantă multifuncțională
 FR Lame plongeante HCS pour outils multifonctions
 IT Lama per tagli dal pieno HCS
 ES Hoja para cortes profundos HCS para herramienta multifuncional
 CN 锯片

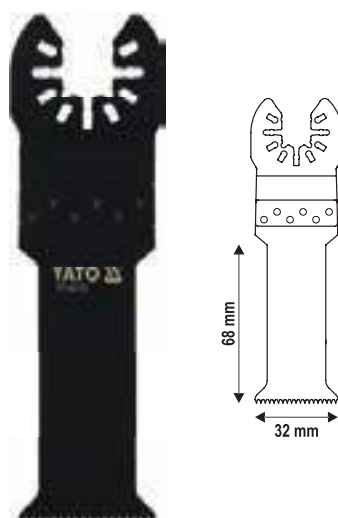
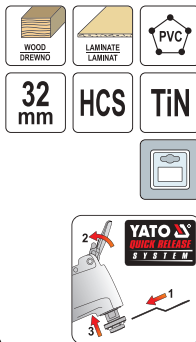

• Application: wood, laminate, plastic
 • Zastosowanie: drewno, laminat, plastik

For YT-82220
 Dla YT-82220

YATO **YT-34710** 10/100

EN Plunge cutting saw blade for oscillating multitool HCS
 PL Brzeczczot wglębny HCS do narzędzia wielofunkcyjnego
 DE Tiefenmesser HCS für Multifunktionswerkzeug
 RU Сабельное полотно HCS для многофункционального инструмента
 CZ Pílavý list HCS na ponorné řezy pro multifunkční nářadí
 HU HCS merülő fűrészlap multifunkciós szerszámhoz
 RO Lamă HCS pt. unealtă oscilantă multifuncțională
 FR Lame plongeante HCS pour outils multifonctions
 IT Lama per tagli dal pieno HCS
 ES Hoja para cortes profundos HCS para herramienta multifuncional
 CN 锯片

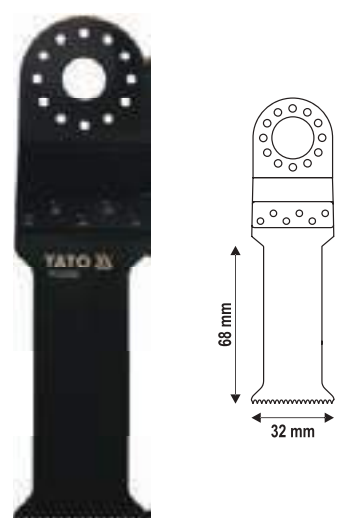
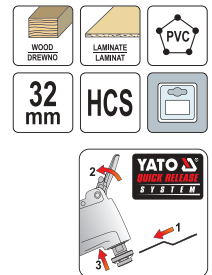

• Application: wood, laminate, plastic
 • Zastosowanie: drewno, laminat, plastik

For YT-82223
 Dla YT-82223

YATO **YT-34700** 10/100

EN Plunge cutting saw blade for oscillating multitool BIM
 PL Brzeszczot wgłębny BIM do narzędzia wielofunkcyjnego
 DE Tiefenmesser BIM für Multifunktionswerkzeug
 RU Сабельное полотно BIM для многофункционального инструмента
 CZ Pílový list BIM na ponorné řezy pro multifunkční nářadí
 HU BIM merülő fűrészlap multifunkciós szerszámhoz
 RO Lamă BIM pt. unealtă oscilantă multifuncțională
 FR Lame plongeante BIM pour outils multifonctions
 IT Lama per tagli dal pieno BIM
 ES Hoja para cortes profundos BIM para herramienta multifuncional
 CN 锯片

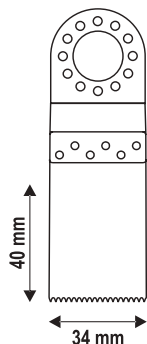
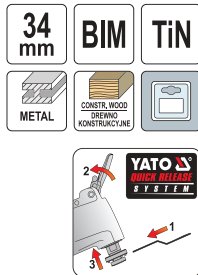

• Application: wood, metal
 • Zastosowanie: drewno, metal

For YT-82223
 Dla YT-82223



EN Plunge cutting saw blade for oscillating multitool BIM
 PL Brzeszczot wgłębny BIM do narzędzia wielofunkcyjnego
 DE Tiefenmesser BIM für Multifunktionswerkzeug
 RU Сабельное полотно BIM для многофункционального инструмента
 CZ Pílový list BIM na ponorné řezy pro multifunkční nářadí
 HU BIM merülő fűrészlap multifunkciós szerszámhoz
 RO Lamă BIM pt. unealtă oscilantă multifuncțională
 FR Lame plongeante BIM pour outils multifonctions
 IT Lama per tagli dal pieno BIM
 ES Hoja para cortes profundos BIM para herramienta multifuncional
 CN 锯片

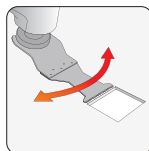
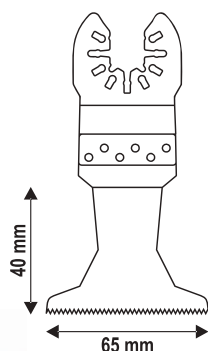
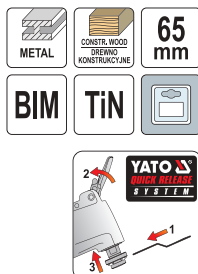

• Application: wood, metal
 • Zastosowanie: drewno, metal

For YT-82220
 Dla YT-82220



EN Plunge cutting saw blade for oscillating multitool BIM
 PL Brzeszczot wgłębny BIM do narzędzia wielofunkcyjnego
 DE Tiefenmesser BIM für Multifunktionswerkzeug
 RU Сабельное полотно BIM для многофункционального инструмента
 CZ Pílový list BIM na ponorné řezy pro multifunkční nářadí
 HU BIM merülő fűrészlap multifunkciós szerszámhoz
 RO Lamă BIM pt. unealtă oscilantă multifuncțională
 FR Lame plongeante BIM pour outils multifonctions
 IT Lama per tagli dal pieno BIM
 ES Hoja para cortes profundos BIM para herramienta multifuncional
 CN 锯片

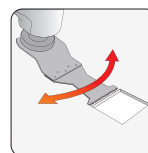
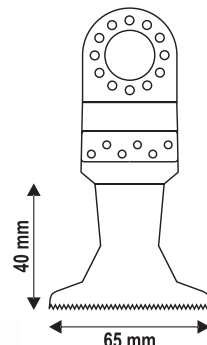
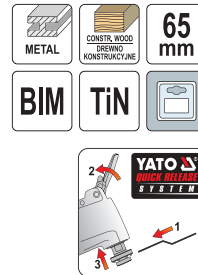

• Application: wood, metal
 • Zastosowanie: drewno, metal

For YT-82223
 Dla YT-82223

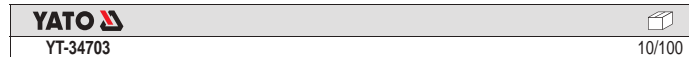

EN Brazed carbide triangular rasp for oscillating multitool
 PL Tarnik trójkątny do narzędzia wielofunkcyjnego
 DE Dreieckige Raspel für Multifunktionswerkzeug
 RU Треугольный рашпиль для многофункционального инструмента
 CZ Trojúhelníková brusná deska pro multifunkční nářadí
 HU Háromszög keresztmetszetű reszelő multifunkciós szerszámhoz
 RO Raspel triunghiular pt. unealtă multifuncțională
 FR Plateau de ponçage à béton carbure pour outil multifonction
 IT Raspa in metallo duro forma triangolare multi-funzione
 ES Escofa triangular para herramienta multifuncional
 CN 锯片

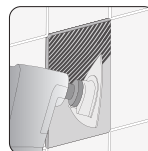
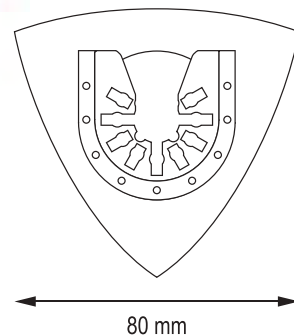
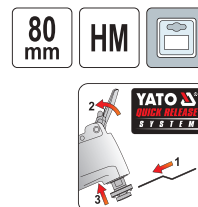

• Application: concrete, ceramic materials
 • Zastosowanie: beton, materiały ceramiczne

For YT-82220, YT-82818, YT-82900
 Dla YT-82220, YT-82818, YT-82900



EN Short scraper for oscillating multitool
 PL Skrobak do narzędzia wielofunkcyjnego
 DE Schaber für Multifunktionswerkzeug
 RU Скребок для многофункционального инструмента
 CZ Škrabka pro multifunkční nářadí
 HU Kaparó multifunkciós szerszámhoz
 RO Răzuitor pt. unealta multifuncțională
 FR Spatule pour outil multifonction
 IT Raschietto oscillante multifunzione adatto
 ES Raspador para herramienta multifuncional
 CN 锯片



52 mm
HCS

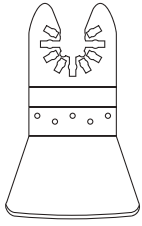

52 mm

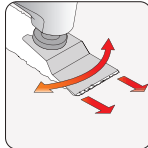

• Application: paint, adhesives, sealing compounds
 • Zastosowanie: farby, kleje, masy uszczelniające

For YT-82220, YT-82818, YT-82900
 Dla YT-82220, YT-82818, YT-82900

YATO

YT-34688 10/100

EN Triangular eva sanding pad for oscillating multitool
 PL Stopa szlifarska do narzędzia wielofunkcyjnego
 DE Schleifplatte für Multifunktionswerkzeug
 RU Шлифовальная насадка для многофункционального инструмента
 CZ Brusný nástavec pro multifunkční nářadí
 HU Csiszoló talp multifunkciós szerszámhoz
 RO Cap pt. sablat pt. unealta multifuncțională
 FR Plateau de ponçage pour outil multifonction
 IT Tasso di smerigliatrice multifunzionale
 ES Pie de rectificación para herramienta multifuncional
 CN 抛光盘

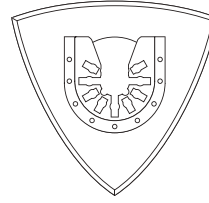

90 mm



• Application: wood, metal, plaster
 • Zastosowanie: drewno, metal, gips

For YT-82220, YT-82818, YT-82900
 Dla YT-82220, YT-82818, YT-82900

YATO

YT-34689 10/100

EN Triangular sanding pad for oscillating multitool
 PL Stopa szlifarska do narzędzia wielofunkcyjnego
 DE Schleifplatte für Multifunktionswerkzeug
 RU Шлифовальная насадка для многофункционального инструмента
 CZ Brusný nástavec pro multifunkční nářadí
 HU Csiszoló talp multifunkciós szerszámhoz
 RO Cap de șlefuit pt. unealta multifuncțională
 FR Plateau de ponçage pour outil multifonction
 IT Tasso di smerigliatrice multifunzionale
 ES Pie de rectificación para herramienta multifuncional
 CN 抛光盘

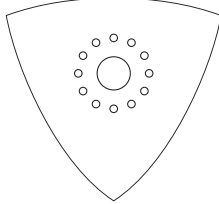
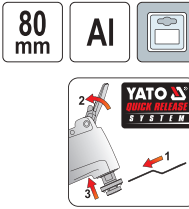

80 mm

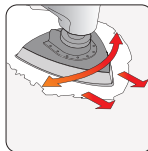

For YT-82223
 Dla YT-82223

• Application: wood, metal, plaster
 • Zastosowanie: drewno, metal, gips

YATO

YT-34692 10/100

EN Triangular sand paper for oscillating multitool
 PL Papier ścierny do narzędzia wielofunkcyjnego
 DE Schleifpapier für Multifunktionswerkzeug
 RU Шлифовальная бумага для многофункционального инструмента
 CZ Brusné plátno pro multifunkční nářadí
 HU Csiszolópapír multifunkciós szerszámhoz
 RO Hârtie abrazivă pt. unealta multifuncțională
 FR Feuilles abrasives pour outil multifonction
 IT Carta abrasiva per utensile multifunzione
 ES Papel de lija para herramienta multifuncional
 CN 抛光拉绒砂盘

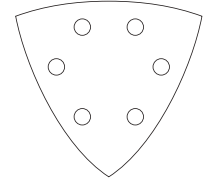
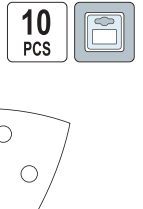

90 mm

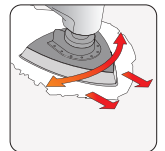

• Application: wood, metal, plaster
 • Zastosowanie: drewno, metal, gips

For YT-82220, YT-82223, YT-82818, YT-82900
 Dla YT-82220, YT-82223, YT-82818, YT-82900

YATO

YT-34690 10/100

EN Triangular sand paper for oscillating multitool
 PL Papier ścierny do narzędzia wielofunkcyjnego
 DE Schleifpapier für Multifunktionswerkzeug
 RU Шлифовальная бумага для многофункционального инструмента
 CZ Brusné plátno pro multifunkční nářadí
 HU Csiszolópapír multifunkciós szerszámhoz
 RO Hârtie abrazivă pt. unealta multifuncțională
 FR Feuilles abrasives pour outil multifonction
 IT Carta abrasiva per utensile multifunzione
 ES Papel de lija para herramienta multifuncional
 CN 抛光拉绒砂盘

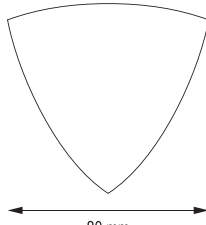
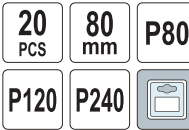

80 mm

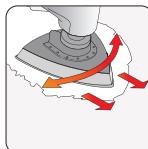

• Application: wood, metal, plaster
 • Zastosowanie: drewno, metal, gips

For YT-82220, YT-82223, YT-82818, YT-82900
 Dla YT-82220, YT-82223, YT-82818, YT-82900
 P80 (10 PCS), P120 (5 PCS), P240 (5 PCS)

YATO

YT-34693 5/50

EN Accessories set for oscillating multitool
 PL Zestaw akcesoriów do narzędzia wielofunkcyjnego
 DE Zubehörsatz für Multifunktionswerkzeug
 RU Набор принадлежностей для многофункционального инструмента
 CZ Souprava příslušenství pro multifunkční nářadí
 HU Tartozék szett multifunkciós szerszámhoz
 RO Set de accesorii pt. unealta multifuncțională
 FR Set d'accessoires pour outil multifonction
 IT Set di accessori per utensile multifunzione
 ES Juego de accesorios para herramienta multifuncional
 CN 锯片附件

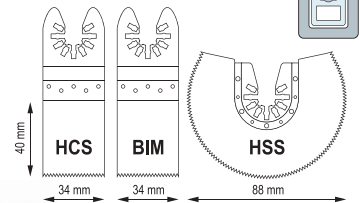
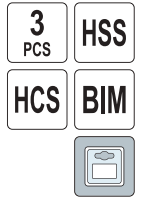

40 mm

34 mm

34 mm

88 mm



• Application: wood, plastic, metal, plaster, epoxy resin
 • Zastosowanie: drewno, plastik, metal, gips, żywica epoksydowa

For YT-82220, YT-82818, YT-82900
 Dla YT-82220, YT-82818, YT-82900

YATO

YT-34691 10/100

EN Tube wire brush
PL Szczotka druciana cylindryczna
DE Zylinder-Drahtbürste
RU Шетка для чистки труб
CZ Kartáč na trubky
HU Hengeres drótkefe

RO Perie de sârmă cilindrică
FR Brosse cylindrique pour tubes
IT Spazzola metallica a cilindro
ES Cepillo en espiral para tubos
CN 试管刷



YATO	Dimensions / Wymiary [mm]	
YT-47695	20x65x200	10/80
YT-47696	26x65x200	10/80
YT-47697	32x65x200	10/80
YT-47698	38x65x200	10/80

EN Wire brush
PL Szczotka druciana
DE Drahtbürste

RU Шетка проволочная
CZ Drátěný kartáč
HU Drótkefe

RO Perie de sârmă
FR Brosse fil métallique
IT Spazzola metallica

ES Cepillo de alambre
CN 钢丝刷



YATO	Row quantity / Liczba rzędów	
YT-6353	3	12/120
YT-6354	4	12/120
YT-6355	5	12/120
YT-6356	6	12/120

YATO	Row quantity / Liczba rzędów	
YT-6358	4	12/72
YT-6359	5	12/72
YT-6360	6	12/72

EN Wire brush
PL Szczotka druciana
DE Drahtbürste
RU Шетка проволочная
CZ Drátěný kartáč
HU Drótkefe

RO Perie de sârmă
FR Brosse fil métallique
IT Spazzola metallica
ES Cepillo de alambre
CN 钢丝刷



YATO	Row quantity / Liczba rzędów	L [mm]	
YT-6330	3	340	12/72

YATO	Row quantity / Liczba rzędów	L [mm]	
YT-6331	3	340	12/72



YATO	Row quantity / Liczba rzędów	L [mm]	
YT-6332	4	260	12/72

YATO	Row quantity / Liczba rzędów	L [mm]	
YT-6333	4	290	12/72

YATO	Row quantity / Liczba rzędów	Size / Rozmiar [mm]	
YT-6334	6	180x65	12/60



YATO	Row quantity / Liczba rzędów	L [mm]	
YT-6335	3	340	12/72

YATO	Row quantity / Liczba rzędów	L [mm]	
YT-6336	3	340	12/72

YATO	Row quantity / Liczba rzędów	L [mm]	
YT-6337	3	180	24/144



YATO	Row quantity / Liczba rzędów	L [mm]	
YT-6338	4	260	12/72

YATO	Row quantity / Liczba rzędów	L [mm]	
YT-6339	4	290	12/72

YATO	Row quantity / Liczba rzędów	L [mm]	
YT-6340	5	180	24/120



YATO	Row quantity / Liczba rzędów	L [mm]	
YT-6341	3	340	12/72

YATO	Row quantity / Liczba rzędów	L [mm]	
YT-6343	3	180	24/144

YATO	Row quantity / Liczba rzędów	L [mm]	
YT-6344	4	260	12/72



YATO	Row quantity / Liczba rzędów	L [mm]	
YT-6345	4	290	12/72

YATO	Row quantity / Liczba rzędów	L [mm]	
YT-6346	5	180	24/120

YATO	Row quantity / Liczba rzędów	L [mm]	
YT-6349	5	180	24/120

EN Wire brush set
PL Zestaw szczotek drucianych
DE Drahtbürsten-Satz
RU Набор проволочных щеток
CZ Sada kartáčů drátěných
HU Drótkefe készlet
RO Set perii de sârmă
FR Jeu de brosses à fils
IT Set di spazzole metalliche
ES Juego de cepillos de alambre
CN 钢丝刷组套



YATO	Row quantity / Liczba rzędów	L [mm]	
YT-6351	3	180	24/144

EN Cup brush with shaft
 PL Szczotka czolowa z trzpieniem
 DE Stahldraht-Topfbürste
 RU Щетка "чашка" со стержнем
 CZ Čelní kartáč drátěný se stopkou
 HU Homlok drótkefe, nyéllél
 RO Perie cupă cu ax
 FR Brosse coupe avec goupille
 IT Spazzola a tazza
 ES Cepillo de copa con mandril
 CN 钢丝轮



YATO	Ø [mm]	max c [min ⁻¹]	
YT-4750	75	4500	12/96

EN Cup brush with shaft
 PL Szczotka czolowa z trzpieniem
 DE Stahldraht-Topfbürste
 RU Щетка "чашка" со стержнем
 CZ Čelní kartáč drátěný se stopkou
 HU Homlok drótkefe, nyéllél
 RO Perie cupă cu ax
 FR Brosse coupe avec goupille
 IT Spazzola a tazza
 ES Cepillo de copa con mandril
 CN 钢丝轮



YATO	Ø [mm]	max c [min ⁻¹]	
YT-4751	75	4500	12/96

EN Cup brush with shaft
 PL Szczotka czolowa z trzpieniem
 DE Stahldraht-Topfbürste
 RU Щетка "чашка" со стержнем
 CZ Čelní kartáč drátěný se stopkou
 HU Homlok drótkefe, nyéllél
 RO Perie cupă cu ax
 FR Brosse coupe avec goupille
 IT Spazzola a tazza
 ES Cepillo de copa con mandril
 CN 钢丝轮



YATO	Ø [mm]	max c [min ⁻¹]	
YT-4752	75	6000	12/72

EN Cup brush with shaft
 PL Szczotka czolowa z trzpieniem
 DE Stahldraht-Topfbürste
 RU Щетка "чашка" со стержнем
 CZ Čelní kartáč drátěný se stopkou
 HU Homlok drótkefe, nyéllél
 RO Perie cupă cu ax
 FR Brosse coupe avec goupille
 IT Spazzola a tazza
 ES Cepillo de copa con mandril
 CN 带柄钢丝轮



YATO	Ø [mm]	max c [min ⁻¹]	
YT-47496	25	4500	20/240

EN Cup brush with shaft
 PL Szczotka czolowa z trzpieniem
 DE Stahldraht-Topfbürste
 RU Щетка "чашка" со стержнем
 CZ Čelní kartáč drátěný se stopkou
 HU Homlok drótkefe, nyéllél
 RO Perie cupă cu ax
 FR Brosse coupe avec goupille
 IT Spazzola a tazza
 ES Cepillo de copa con mandril
 CN 带柄钢丝轮



YATO	Ø [mm]	max c [min ⁻¹]	
YT-47497	50	4500	12/144

EN Cup brush with shaft
 PL Szczotka czolowa z trzpieniem
 DE Stahldraht-Topfbürste
 RU Щетка "чашка" со стержнем
 CZ Čelní kartáč drátěný se stopkou
 HU Homlok drótkefe, nyéllél
 RO Perie cupă cu ax
 FR Brosse coupe avec goupille
 IT Spazzola a tazza
 ES Cepillo de copa con mandril
 CN 带柄钢丝轮



YATO	Ø [mm]	max c [min ⁻¹]	
YT-47511	100	4500	6/36

EN Cup brush with shaft
 PL Szczotka czolowa z trzpieniem
 DE Stahldraht-Topfbürste
 RU Щетка "чашка" со стержнем
 CZ Čelní kartáč drátěný se stopkou
 HU Homlok drótkefe, nyéllél
 RO Perie cupă cu ax
 FR Brosse coupe avec goupille
 IT Spazzola a tazza
 ES Cepillo de copa con mandril
 CN 带柄钢丝轮



YATO	Ø [mm]	max c [min ⁻¹]	
YT-47518	65	12500	10/100

EN Cup brush with shaft
 PL Szczotka czolowa z trzpieniem
 DE Stahldraht-Topfbürste
 RU Щетка "чашка" со стержнем
 CZ Čelní kartáč drátěný se stopkou
 HU Homlok drótkefe, nyéllél
 RO Perie cupă cu ax
 FR Brosse coupe avec goupille
 IT Spazzola a tazza
 ES Cepillo de copa con mandril
 CN 带柄尼龙刷



YATO	Ø [mm]	max c [min ⁻¹]	
YT-47780	25	4500	20/240

EN Cup brush with shaft
 PL Szczotka czolowa z trzpieniem
 DE Stahldraht-Topfbürste
 RU Щетка "чашка" со стержнем
 CZ Čelní kartáč drátěný se stopkou
 HU Homlok drótkefe, nyéllél
 RO Perie cupă cu ax
 FR Brosse coupe avec goupille
 IT Spazzola a tazza
 ES Cepillo de copa con mandril
 CN 带柄尼龙刷



YATO	Ø [mm]	max c [min ⁻¹]	
YT-47782	75	4500	10/120



EN Cup brush with shaft set
 PL Szczotki druciane z trzpieniem
 DE Drahtbürste mit Einspannschaft
 RU Щетки проволочные со стержнем
 CZ Drátěný kartáč se stopkou
 HU Drótkefe, csapos
 RO Perii de sârmă cu ax
 FR Set de brosses coupe avec goupille
 IT Spazzola metallica a disco
 ES Cepillos de alambre con espiga
 CN 三件钢丝刷组套



YATO	Ø [mm]	max c [min ⁻¹]	
YT-4755	20, 50, 50	6000, 7500, 4500	12/60

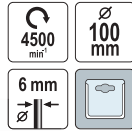

EN Circular brush with shaft
PL Szczotka tarczowa z trzpieniem
DE Stahldraht-Scheibenbürste
RU Щетка круговая со стержнем
CZ Okružní kartáč drátěný se stopkou
HU Tarcás drótkefe, nyéllal
RO Perie rotunda pt. bormasina
FR Brosse circulaire avec goupille
IT Spazzola a disco
ES Cepillo redondo
CN 钢丝轮



YATO 	Ø [mm]	max ω [min ⁻¹]	
YT-4757	100	4500	12/96



EN Circular brush with shaft
PL Szczotka tarczowa z trzpieniem
DE Stahldraht-Scheibenbürste
RU Щетка круговая со стержнем
CZ Okružní kartáč drátěný se stopkou
HU Tarcás drótkefe, nyéllal
RO Perie rotunda pt. bormasina
FR Brosse circulaire avec goupille
IT Spazzola a disco
ES Cepillo redondo
CN 钢丝轮



YATO 	Ø [mm]	max ω [min ⁻¹]	
YT-4758	100	4500	12/96



EN Circular brush with shaft
PL Szczotka tarczowa z trzpieniem
DE Stahldraht-Scheibenbürste
RU Щетка круговая со стержнем
CZ Okružní kartáč drátěný se stopkou
HU Tarcás drótkefe, nyéllal
RO Perie rotunda pt. bormasina
FR Brosse circulaire avec goupille
IT Spazzola a disco
ES Cepillo redondo
CN 钢丝轮



YATO 	Ø [mm]	max ω [min ⁻¹]	
YT-4759	75	20000	10/100



EN Circular brush with shaft
PL Szczotka tarczowa z trzpieniem
DE Stahldraht-Scheibenbürste
RU Щетка круговая со стержнем
CZ Okružní kartáč drátěný se stopkou
HU Tarcás drótkefe, nyéllal
RO Perie rotunda pt. bormasina
FR Brosse circulaire avec goupille
IT Spazzola a disco
ES Cepillo redondo
CN 钢丝轮



YATO 	Ø [mm]	max ω [min ⁻¹]	
YT-47565	50	4500	20/240
YT-47568	75	4500	12/144



EN Circular brush with shaft
PL Szczotka tarczowa z trzpieniem
DE Stahldraht-Scheibenbürste
RU Щетка круговая со стержнем
CZ Okružní kartáč drátěný se stopkou
HU Tarcás drótkefe, nyéllal
RO Perie rotunda pt. bormasina
FR Brosse circulaire avec goupille
IT Spazzola a disco
ES Cepillo redondo
CN 钢丝轮



YATO 	Ø [mm]	max ω [min ⁻¹]	
YT-47791	75	4500	10/120
YT-47792	100	4500	10/60

EN Circular brush with shaft
PL Szczotka tarczowa z trzpieniem
DE Stahldraht-Scheibenbürste
RU Щетка круговая со стержнем
CZ Okružní kartáč drátěný se stopkou
HU Tarcás drótkefe, nyéllal
RO Perie rotunda pt. bormasina
FR Brosse circulaire avec goupille
IT Spazzola a disco
ES Cepillo redondo
CN 钢丝轮



YATO 	Ø [mm]	max ω [min ⁻¹]	
YT-47800	50	4500	6/36
YT-47801	75	4500	6/36
YT-47802	100	4500	6/36

EN Cup brush with shaft set
PL Szczotki druciane z trzpieniem
DE Drahtbürste mit Einspannschaft
RU Щетки проволочные со стержнем
CZ Drátěný kartáč se stopkou
HU Drótkefe, csapós
RO Perii de sârmă cu ax
FR Set de brosses coupe avec goupille
IT Spazzola metallica a disco
ES Cepillos de alambre con espiga
CN 钢丝刷

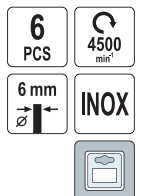

YATO 	Ø [mm]	max ω [min ⁻¹]	
YT-47593	37, 50, 62, 75	4500	6/60

EN Circular brush
 PL Szczotka tarczowa z gwintem
 DE Stahldraht-Scheibenbürste
 RU Щетка кырбоая
 CZ Okružní kartáč drátěný
 HU Tarcásás drótkefe
 RO Perie rotunda pt. bormasina
 FR Brosse circulaire avec filet
 IT Spazzola conica
 ES Cepillo redondo
 CN 钢丝轮





 12500
 min⁻¹
 100
 mm
M14 

YATO 	Ø [mm]	max. n [min ⁻¹]	
YT-4761	100	12500	8/64

EN Circular brush
 PL Szczotka tarczowa z gwintem
 DE Stahldraht-Scheibenbürste
 RU Щетка кырбоая
 CZ Okružní kartáč drátěný
 HU Tarcásás drótkefe
 RO Perie rotunda pt. bormasina
 FR Brosse circulaire avec filet
 IT Spazzola conica
 ES Cepillo redondo
 CN 钢丝轮



 10000
 min⁻¹
 125
 mm
M14 **INOX** 

YATO 	Ø [mm]	max. n [min ⁻¹]	
YT-4764	125	10000	8/48

EN Cup brush
 PL Szczotka czolowa z gwintem
 DE Stahldraht-Topfbürste
 RU Щетка "чашка"
 CZ Čelní kartáč drátěný
 HU Homlok drótkefe
 RO Perie cupă
 FR Brosse coupe avec filet
 IT Spazzola conica
 ES Cepillo de copa
 CN 钢丝轮





 8500
 min⁻¹
 100
 mm
M14 

YATO 	Ø [mm]	max. n [min ⁻¹]	
YT-4766	100	8500	4/32

EN Cup brush
 PL Szczotka czolowa z gwintem
 DE Stahldraht-Topfbürste
 RU Щетка "чашка"
 CZ Čelní kartáč drátěný
 HU Homlok drótkefe
 RO Perie cupă
 FR Brosse coupe avec filet
 IT Spazzola conica
 ES Cepillo de copa
 CN 钢丝轮



 11000
 min⁻¹
 75
 mm
M14 **INOX** 

YATO 	Ø [mm]	max. n [min ⁻¹]	
YT-4768	75	11000	6/36

EN Circular brush
 PL Szczotka tarczowa z gwintem
 DE Stahldraht-Scheibenbürste
 RU Щетка кырбоая
 CZ Okružní kartáč drátěný
 HU Tarcásás drótkefe
 RO Perie rotunda pt. bormasina
 FR Brosse circulaire avec filet
 IT Spazzola conica
 ES Cepillo redondo
 CN 钢丝轮





 12500
 min⁻¹
 100
 mm
M14 

YATO 	Ø [mm]	max. n [min ⁻¹]	
YT-4763	100	12500	8/64

EN Circular brush
 PL Szczotka tarczowa z gwintem
 DE Stahldraht-Scheibenbürste
 RU Щетка кырбоая
 CZ Okružní kartáč drátěný
 HU Tarcásás drótkefe
 RO Perie rotunda pt. bormasina
 FR Brosse circulaire avec filet
 IT Spazzola conica
 ES Cepillo redondo
 CN 钢丝轮



 12500
 min⁻¹
 125
 mm
M14 **INOX** 

YATO 	Ø [mm]	max. n [min ⁻¹]	
YT-4762	125	12500	10/60

EN Cup brush
 PL Szczotka czolowa z gwintem
 DE Stahldraht-Topfbürste
 RU Щетка "чашка"
 CZ Čelní kartáč drátěný
 HU Homlok drótkefe
 RO Perie cupă
 FR Brosse coupe avec filet
 IT Spazzola conica
 ES Cepillo de copa
 CN 钢丝轮





 12500
 min⁻¹
 60
 mm
M14 

YATO 	Ø [mm]	max. n [min ⁻¹]	
YT-4767	60	12500	10/80

EN Cup brush
 PL Szczotka czolowa z gwintem
 DE Stahldraht-Topfbürste
 RU Щетка "чашка"
 CZ Čelní kartáč drátěný
 HU Homlok drótkefe
 RO Perie cupă
 FR Brosse coupe avec filet
 IT Spazzola conica
 ES Cepillo de copa
 CN 钢丝轮



 8500
 min⁻¹
 100
 mm
M14 

YATO 	Ø [mm]	max. n [min ⁻¹]	
YT-4769	100	8500	4/16

EN Cup brush
PL Szczotka czolowa z gwintem
DE Stahldraht-Topfbürste
RU Щетка "чашка"
CZ Čelní kartáč drátěný
HU Homlok drótkefe
RO Perie cupă
FR Brosse coupe avec filet
IT Spazzola conica
ES Cepillo de copa
CN 钢丝轮



YATO	Ø [mm]	max c [min ⁻¹]	
YT-47691	125	6500	4/16

EN Cup brush
PL Szczotka czolowa z gwintem
DE Stahldraht-Topfbürste
RU Щетка "чашка"
CZ Čelní kartáč drátěný
HU Homlok drótkefe
RO Perie cupă
FR Brosse coupe avec filet
IT Spazzola conica
ES Cepillo de copa
CN 钢丝轮



YATO	Ø [mm]	max c [min ⁻¹]	
YT-47658	65	12500	10/80

EN Cup brush
PL Szczotka czolowa z gwintem
DE Stahldraht-Topfbürste
RU Щетка "чашка"
CZ Čelní kartáč drátěný
HU Homlok drótkefe
RO Perie cupă
FR Brosse coupe avec filet
IT Spazzola conica
ES Cepillo de copa
CN 尼龙刷

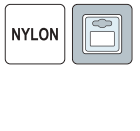

YATO	Ø [mm]	max c [min ⁻¹]	
YT-47785	65	12200	10/80
YT-47787	125	6500	6/24

EN Circular brush
PL Szczotka tarczowa z gwintem
DE Stahldraht-Scheibenbürste
RU Щетка круговая
CZ Okružní kartáč drátěný
HU Tarcás drótkefe
RO Perie rotunda pt. bormasina
FR Brosse circulaire avec filet
IT Spazzola conica
ES Cepillo redondo
CN 带柄平行刷



YATO	Ø [mm]	max c [min ⁻¹]	
YT-47554	150x32	6000	5/40
YT-47555	200x32	4500	5/20

EN Metal grinding disc
PL Tarcza do szlifowania metalu
DE Metall-Schleif-scheibe
RU Круги для шлифования по металлу
CZ Kotouč pro broušení kovů
HU Vágókorong fémhez
RO Disc pt. șlefuit metal
FR Disque de polissage pour métaux
IT Disco per rettifica metallo
ES Disco cortador para metal
CN 研磨片



YATO	Ø [mm]	max c [min ⁻¹]	
YT-47820	125	12500	6/36

EN Drill powered scrub brushes
PL Zestaw szczotek na wiertarkę
DE Bürstensatz für Bohrmaschine
RU Набор щеток для дрели
CZ Sada uhliků do vrtačky
HU Kefekészlet fűróhoz
RO Set perii de curățare pt. bormasină
FR Ensemble de brosses pour perceuse
IT Set di spazzole per trapano
ES Juego de cepillos para taladro
CN 清洁刷

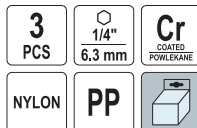

YATO	Ø [mm]	
YT-47553	50, 80, 100	40

EN Drill powered scrub brushes
PL Zestaw szczotek na wiertarkę
DE Bürstensatz für Bohrmaschine
RU Набор щеток для дрели
CZ Sada uhliků do vrtačky
HU Kefekészlet fűróhoz
RO Set perii de curățare pt. bormasină
FR Ensemble de brosses pour perceuse
IT Set di spazzole per trapano
ES Juego de cepillos para taladro
CN 清洁刷



YATO	Ø [mm]	
YT-47777	5, 8, 10, 12 (x2)	24

EN Electrician's knife
 PL Nóż monterski składany
 DE Montagemesser
 RU Нож складной
 CZ Montážní nůž
 HU Szerelő kés
 RO Cuijt pt. decablat
 FR Couteau d'électricien
 IT Coltello
 ES Cuchillo de montaje
 CN 电工刀

HRC 42-48
 3Cr13



85/200 mm



75/190 mm

YATO	L [mm]	
YT-7600	200	6/96

YATO	L [mm]	
YT-7601	190	6/96

EN Folding knife with bits
 PL Nóż składany z bitami
 DE Klappmesser
 RU Нож складной
 CZ Kapesní nůž
 HU Zsebkés
 RO Briceag
 FR Couteau pince multifonction avec embouts
 IT Coltello pieghevole con punte
 ES Navaja
 CN 折叠刀

AI
 SS
 STAINLESS STEEL
 STAL NIERDZEWA



- 3, 4 mm;
- PH1, PH2 mm;
- 3, 4 mm;
- T10, T20

YATO	
YT-76031	6/48

EN Folding knife
 PL Nóż składany
 DE Klappmesser
 RU Нож складной
 CZ Kapesní nůž
 HU Zsebkés
 RO Briceag
 FR Couteau pliant
 IT Coltello pieghevole
 ES Navaja
 CN 折叠刀

SS
 STAINLESS STEEL
 STAL NIERDZEWA



AI

YATO	
YT-76050	12/72



YATO	
YT-76051	12/120



YATO	
YT-76052	6/48

EN Multi knife
 PL Narzędzie wielofunkcyjne
 DE Klappmesser
 RU Нож складной
 CZ Kapesní nůž
 HU Zsebkés
 RO Patent multifuncțional
 FR Couteau pince multifonction
 IT Pinza multifunzione
 ES Navaja
 CN 多功能折叠刀

9 PCS
 SS
 STAINLESS STEEL
 STAL NIERDZEWA
 AI



YATO	
YT-76040	12/120

EN Multi knife
 PL Narzędzie wielofunkcyjne
 DE Klappmesser
 RU Нож складной
 CZ Kapesní nůž
 HU Zsebkés
 RO Patent multifuncțional
 FR Couteau pince multifonction
 IT Pinza multifunzione
 ES Navaja
 CN 多功能折叠刀

9 PCS
 SS
 STAINLESS STEEL
 STAL NIERDZEWA
 AI



YATO	
YT-76041	12/48

EN Multi knife
PL Narzędzie wielofunkcyjne
DE Klappmesser
RU Нож складной
CZ Kapesní nůž
HU Zsebkés
RO Patent multifuncțional
FR Couteau pince multifonction
IT Pinza multifunzione
ES Navaja
CN 多功能折叠刀

9
PCS
SS
STAINLESS STEEL
STAL NIERDZEWNA
AI



YATO
YT-76042

12/48

EN Utility knife with trapezoid blade
PL Nożyk z ostrzem trapezowym
DE Cuttermesser mit Trapezklinge
RU Нож с выдвижным трапециевидным лезвием
CZ Nůž s lichoběžníkovou čepelí
HU Trapéz pengés kés

RO Cutter cu lamă trapezoidală retractabilă
FR Cutter à lame trapezoidale
IT Taglierino con lama trapezoidale
ES Cortador trapezoidal retráctil
CN 折叠实用刀

1+5
61x33x0.5
mm
SK5



YATO
YT-7532

Blade size / Rozmiar ostrza [mm]
61x33x0.5

12/72

EN Utility knife with trapezoid blade
PL Nożyk z ostrzem trapezowym
DE Cuttermesser mit Trapezklinge
RU Нож с выдвижным трапециевидным лезвием
CZ Nůž s lichoběžníkovou čepelí
HU Trapéz pengés kés

RO Cutter cu lamă trapezoidală retractabilă
FR Cutter à lame trapezoidale
IT Taglierino con lama trapezoidale
ES Cortador trapezoidal retráctil
CN 折叠实用刀

x3
61x33x0.5
mm
SK5



YATO
YT-7520

Blade size / Rozmiar ostrza [mm]
61x33x0.5

6/48

EN Utility knife
PL Nożyk z łamanym ostrzem
DE Abbrechklingen-Messer
RU Нож строительный
CZ Nůž ulamovací
HU Barkácskés
RO Cutter cu lamă retractabilă
FR Cutter à lame sécable
IT Taglierino
ES Cortador retráctil
CN 美工刀

9
mm
1+2
ABS
TPR
AUTO
LOCK
BLOKADA
METAL
SLIDING BAR
METALOWA
PROWADNICA
SELF-LOADING
BLADES
SAMOŁADUJĄCE
OSTRZA
SK5



YATO
YT-75001

Blade size / Rozmiar ostrza [mm]
9x0.4

12/144

EN Utility knife
PL Nożyk z łamanym ostrzem
DE Abbrechklingen-Messer
RU Нож строительный
CZ Nůž ulamovací
HU Barkácskés
RO Cutter cu lamă retractabilă
FR Cutter à lame sécable
IT Taglierino
ES Cortador retráctil
CN 美工刀

9
mm
AUTO
LOCK
BLOKADA
METAL
BODY
METALOWY
KORPUS
METAL
SLIDING BAR
METALOWA
PROWADNICA
SK2H



YATO
YT-75003

Blade size / Rozmiar ostrza [mm]
9x0.4

10/240

ULTRA SHARP

EN Multi knife
PL Narzędzie wielofunkcyjne
DE Klappmesser
RU Нож складной
CZ Kapesní nůž
HU Zsebkés
RO Patent multifuncțional
FR Couteau pince multifonction
IT Pinza multifunzione
ES Navaja
CN 多功能折叠刀

9
PCS
SS
STAINLESS STEEL
STAL NIERDZEWNA



YATO
YT-76043

6/36

EN Utility knife with trapezoid blade
PL Nożyk z ostrzem trapezowym
DE Cuttermesser mit Trapezklinge
RU Нож с выдвижным трапециевидным лезвием
CZ Nůž s lichoběžníkovou čepelí
HU Trapéz pengés kés

RO Cutter cu lamă trapezoidală retractabilă
FR Cutter à lame trapezoidale
IT Taglierino con lama trapezoidale
ES Cortador trapezoidal retráctil
CN 折叠实用刀

x5
61x33x0.5
mm
150
mm
SK5



YATO
YT-7534

Blade size / Rozmiar ostrza [mm]
61x33x0.5

12/72

EN Utility knife with trapezoid blade
PL Nożyk z ostrzem trapezowym
DE Cuttermesser mit Trapezklinge
RU Нож с выдвижным трапециевидным лезвием
CZ Nůž s lichoběžníkovou čepelí
HU Trapéz pengés kés

RO Cutter cu lamă trapezoidală retractabilă
FR Cutter à lame trapezoidale
IT Taglierino con lama trapezoidale
ES Cortador trapezoidal retráctil
CN 折叠实用刀

1+3
61x33x0.5
mm
AUTO
RETRACTABLE
AUTOMATYCZNE
WYSUNIANIE
3
BLADE POSITIONS
POZYCJE CIĘCZY
Zn
TPR
ABS
SK5



STRAP SIDE CUTTER
OBCINAK BOCZNY



YATO
YT-75201

Blade size / Rozmiar ostrza [mm]
61x33x0.5

12/72

EN Utility knife
PL Nożyk z łamanym ostrzem
DE Abbrechklingen-Messer
RU Нож строительный
CZ Nůž ulamovací
HU Barkácskés
RO Cutter cu lamă retractabilă
FR Cutter à lame sécable
IT Taglierino
ES Cortador retráctil
CN 美工刀

9
mm
AUTO
LOCK
BLOKADA
METAL
SLIDING BAR
METALOWA
PROWADNICA
METAL
BODY
METALOWY
KORPUS
SK2H



ULTRA SHARP

YATO
YT-75002

Blade size / Rozmiar ostrza [mm]
9x0.4

10/240

EN Utility knife
PL Nożyk z łamanym ostrzem
DE Abbrechklingen-Messer
RU Нож строительный
CZ Nůž ulamovací
HU Barkácskés
RO Cutter cu lamă retractabilă
FR Cutter à lame sécable
IT Taglierino
ES Cortador retráctil
CN 美工刀

18
mm
AUTO
LOCK
BLOKADA
METAL
SLIDING BAR
METALOWA
PROWADNICA
ABS
SK2H



YATO
YT-75123

Blade size / Rozmiar ostrza [mm]
18x0.5

10/120

ULTRA SHARP

EN Utility knife
 PL Nożyk z lamany ostrzem
 DE Abbrechklingen-Messer
 RU Нож строительный
 CZ Nůž ulamovací
 HU Barkácskés
 RO Cutter cu lamă retractabilă
 FR Cutter à lame sécable
 IT Taglierino
 ES Cortador retráctil
 CN 美工刀

18 mm ABS SK2H



ULTRA SHARP

YATO	Blade size / Rozmiar ostrza [mm]	
YT-75124	18x0.5	10/120

EN Utility knife
 PL Nożyk z lamany ostrzem
 DE Abbrechklingen-Messer
 RU Нож строительный
 CZ Nůž ulamovací
 HU Barkácskés
 RO Cutter cu lamă retractabilă
 FR Cutter à lame sécable
 IT Taglierino
 ES Cortador retráctil
 CN 美工刀

18 mm Zn TPR SK5

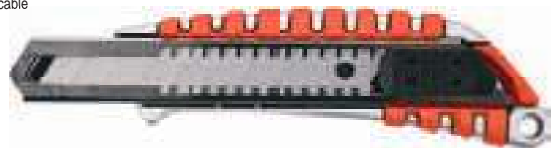

YATO	Blade size / Rozmiar ostrza [mm]	
YT-75122	18x0.5	12/144

EN Utility knife
 PL Nożyk z lamany ostrzem
 DE Abbrechklingen-Messer
 RU Нож строительный
 CZ Nůž ulamovací
 HU Barkácskés
 RO Cutter cu lamă retractabilă
 FR Cutter à lame sécable
 IT Taglierino
 ES Cortador retráctil
 CN 美工刀

ABS TPR SK2



YATO	Blade size / Rozmiar ostrza [mm]	
YT-7506	9x0.4	24/240
YT-7507	18x0.5	12/144

EN Utility knife
 PL Nożyk z lamany ostrzem
 DE Abbrechklingen-Messer
 RU Нож строительный
 CZ Nůž ulamovací
 HU Barkácskés
 RO Cutter cu lamă retractabilă
 FR Cutter à lame sécable
 IT Taglierino
 ES Cortador retráctil
 CN 美工刀

18 mm ABS TPR SK5



YATO	Blade size / Rozmiar ostrza [mm]	
YT-75072	18x0.5	12/144

EN Utility knife
 PL Nożyk z lamany ostrzem
 DE Abbrechklingen-Messer
 RU Нож строительный
 CZ Nůž ulamovací
 HU Barkácskés
 RO Cutter cu lamă retractabilă
 FR Cutter à lame sécable
 IT Taglierino
 ES Cortador retráctil
 CN 美工刀

25 mm ABS TPR SK5



YATO	Blade size / Rozmiar ostrza [mm]	
YT-75101	25x0.7	12/144

EN Utility knife
 PL Nożyk z lamany ostrzem
 DE Abbrechklingen-Messer
 RU Нож строительный
 CZ Nůž ulamovací
 HU Barkácskés
 RO Cutter cu lamă retractabilă
 FR Cutter à lame sécable
 IT Taglierino
 ES Cortador retráctil
 CN 美工刀

18 mm Zn TPR ABS SK5



YATO	Blade size / Rozmiar ostrza [mm]	
YT-75121	18x0.5	12/144

EN Utility knife
 PL Nożyk z lamany ostrzem
 DE Abbrechklingen-Messer
 RU Нож строительный
 CZ Nůž ulamovací
 HU Barkácskés
 RO Cutter cu lamă retractabilă
 FR Cutter à lame sécable
 IT Taglierino
 ES Cortador retráctil
 CN 美工刀

SK2



YATO	Blade size / Rozmiar ostrza [mm]	
YT-7511	9x0.4	24/288
YT-7512	18x0.5	12/96

EN Utility knife
 PL Nożyk z lamany ostrzem
 DE Abbrechklingen-Messer
 RU Нож строительный
 CZ Nůž ulamovací
 HU Barkácskés
 RO Cutter cu lamă retractabilă
 FR Cutter à lame sécable
 IT Taglierino
 ES Cortador retráctil
 CN 美工刀

18 mm ABS TPR SK5



YATO	Blade size / Rozmiar ostrza [mm]	
YT-75071	18x0.5	12/144

EN Utility knife
 PL Nożyk z lamany ostrzem
 DE Abbrechklingen-Messer
 RU Нож строительный
 CZ Nůž ulamovací
 HU Barkácskés

RO Cutter cu lamă retractabilă
 FR Cutter à lame sécable
 IT Taglierino
 ES Cortador retráctil
 CN 美工刀

ABS SK2



YATO	Blade size / Rozmiar ostrza [mm]	
YT-7504	9x0.4	24/240
YT-7505	18x0.5	24/240

EN Spare blades
 PL Ostrza zapasowe
 DE Abbrechklingen
 RU Запасные лезвия
 CZ Náhradní břity
 HU Tartalék pengék

RO Lame de rezervă
 FR Lamé sécables
 IT Lame di ricambio
 ES Cuchillas de repuesto
 CN 刀片

10 PCS SK2H



ULTRA SHARP

YATO	Blade size / Rozmiar ostrza [mm]	
YT-75260	9x0.4	10/240
YT-75261	18x0.5	10/120

EN Spare blades
PL Ostrza zapasowe
DE Abbrechklingen
RU Запасные лезвия
CZ Náhradní bity
HU Tartalék pengék

RO Lame de rezervă
FR Lame sécables
IT Lame di ricambio
ES Cuchillas de repuesto
CN 刀片

10
PCS SK5



YATO	Blade size / Rozmiar ostrza [mm]	
YT-7528	9x0.4	24/144
YT-7529	18x0.5	24/144
YT-7530	25x0.7	6/48

EN Spare blades
PL Ostrza zapasowe
DE Abbrechklingen
RU Запасные лезвия
CZ Náhradní bity
HU Tartalék pengék

RO Lame de rezervă
FR Lame sécables
IT Lame di ricambio
ES Cuchillas de repuesto
CN 刀片

10
PCS SK2



YATO	Blade size / Rozmiar ostrza [mm]	
YT-7524	9x0.4	24/240
YT-7525	18x0.5	24/144
YT-75262	25x0.7	10/60

EN Squeegee with felt for pressing the film
PL Rakiel do dociskania folii
DE Folienpressraker
RU Ракель для прижатия пленки
CZ Stěrka pro přitlačení fólie
HU Fólia kasirozó

RO Racleta colant
FR Racloir à feuilles
IT Raschietto per pellicola
ES Rasqueta para presionar película
CN 毛毡刮片

100x73
mm



YATO	Size / Rozmiar [mm]	
YT-52550	100x73	20/200

EN Oil glass cutter
PL Nóż olejowy do szkła
DE Ölglasschneider

RU Стеклопорец масляный
CZ Řezák na sklo
HU Olajkés üveghez

RO Diamant pt. tăiat sticlă cu ulei
FR Couteau à l'huile pour verre
IT Taglia vetro con serbatoio olio

ES Cuchillo de aceite para cristales
CN 玻璃割刀

HRA 92.5-93 YD05



177
mm

YATO	L [mm]	
YT-7560	177	12/120

EN Glass cutter with diamond tip
PL Nóż do cięcia szkła z końcówką diamentową
DE Glasschneider mit Diamantspitze
RU Стеклопорец с алмазным наконечником
CZ Nůž na sklo s diamentovou koncovkou
HU Üvegágó kés gyémánt fejfel

RO Diamant sticla
FR Coupe-verre à pointe de diamant
IT Tagliavetro con punta di diamante
ES Cortador de vidrio con punta de diamante
CN 玻璃割刀

175
mm



YATO	L [mm]	
YT-37390	175	6/240

EN Spare blades
PL Ostrza zapasowe
DE Ersatzklingen
RU Запасные лезвия
CZ Náhradní bity
HU Tartalék pengék
RO Lame de rezervă
FR Lame de rechange
IT Lame di ricambio
ES Cuchillas de repuesto
CN 刀片

10
PCS 61x33
x0.5
mm SK5



YATO	Blade size / Rozmiar ostrza [mm]	
YT-7531	61x33x0.5	24/144

EN Spare blades
PL Ostrza zapasowe
DE Ersatzklingen
RU Запасные лезвия
CZ Náhradní bity
HU Tartalék pengék
RO Lame de rezervă
FR Lame de rechange
IT Lame di ricambio
ES Cuchillas de repuesto
CN 刀片

10
PCS 61x33
x0.5
mm SK2



YATO	Blade size / Rozmiar ostrza [mm]	
YT-7527	61x33x0.5	24/144

EN Scissors
PL Nożyczki
DE Haushaltsschere
RU Ножницы
CZ Nůžky
HU Olló

RO Foarfecă
FR Ciseaux
IT Forbici
ES Tijeras
CN 剪刀

SS
STAINLESS STEEL
CUTTING TOOL



YATO	L [mm]	
YT-19763	170	12/120
YT-19764	190	12/120
YT-19765	215	12/120
YT-19766	245	12/120
YT-19767	300	12/120

HRA 92.5-93 YD05



178
mm

YATO	L [mm]	
YT-7561	178	12/120

EN 2-sided glass cutting tool
PL Dwustronny nóż do płytek ceramicznych i szkła
DE Doppelseitiger Fliesen- und Glasschneider
RU Двусторонний резак для керамической плитки и стекла
CZ Oboustranný nůž na keramické dlaždice a sklo
HU Kétoldalú csempé- és üvegágó kés
RO Instrument de tăiat sticlă cu 2 capete
FR Coupeur de carreaux et de verre à double face
IT Taglierina reversibile per piastrelle e vetro
ES Cuchillo doble para baldosas cerámicas y vidrio
CN 玻璃割刀

120
mm 2x 8mm YG6X 1-2-SIDED
CUTTING
CUTTING
+ 2-STROKING



YATO	L [mm]	
YT-37404	120	6/240

EN Glass cutter with 3 wheels
 PL Nóż do cięcia szkła z trzema kółkami
 DE Glasschneider mit drei Rädern
 RU Стеклоплез с тремя роликами
 CZ Nůž na sklo se třemi kolečky
 HU Üvegágó kés három tárcsával

RO Diamant sticlă cu 3 cutite
 FR Coupe-verre à 3 molettes
 IT Tagliavetro a 3 ruote
 ES Cortador de vidrio con tres ruedas
 CN 玻璃割刀

130
mm

3x
YG6X



YATO	L [mm]	
YT-37391	130	10/150

EN Drywall board cutting tool with measuring tape

PL Nóż do cięcia płyt gipsowo-kartonowych z miarą związaną

DE Gipskartonschneider mit Rollmaß

RU Нож для резы гипсокартона с рулеткой

CZ Nůž na sádrokarton se svinovacím metrem

HU Mérőszalagos gipszkartonvágó kés

RO Cuiț de tăiat plăci de gips-carton cu bandă de măsurare

FR Coupeur pour plaque de plâtre avec ruban-mètre intégré

IT Taglierina per cartongesso con metro a nastro

ES Cortador de placa de yeso con cinta métrica

CN 石膏板切割器



5m
19 mm

x5
BLADES
CUTTER



YATO	
YT-31350	30

EN Carving knife set

PL Zestaw nożyków

DE Klingensatz

RU Набор резаков

CZ Sada nožíků

HU Késkészlet

RO Set cutite prelucrare lemn

FR Sculpture ensemble de couteau

IT Set di coltelli

ES Juego de cuchillas

CN 美工刀

14 PCS HRC 60 T10 STEEL STAL AI HANDLE UCHWYT SOFT GRIP MEKKI UCHWYT



YATO	
YT-75140	6/48

EN Carving knife set

PL Zestaw nożyków

DE Klingensatz

RU Набор резаков

CZ Sada nožíků

HU Késkészlet

RO Set cutite prelucrare lemn

FR Sculpture ensemble de couteau

IT Set di coltelli

ES Juego de cuchillas

CN 雕刻刀

16 PCS SK5



YATO	
YT-75370	4/24

EN Multifunction tool for drawing lines
 PL Przyrząd do trasowania linii równoległych
 DE Markierungswerkzeug für parallele Linien
 RU Устройство для разметки параллельных линий
 CZ Nástroj pro směřování rovnolehlých linií
 HU Párhuzamjelölő
 RO Unealtă pt. trasat linii paralele
 FR Dispositif de marquage de lignes parallèles
 IT Strumento per disegnare linee parallele
 ES Trazador de arco lineal
 CN 木工划线器



SS STAINLESS STEEL STA. NEGERZENNIA AI

YATO	
YT-70730	20

EN Rotary cutter
 PL Nóż z okrągłym ostrzem
 DE Rollschneider
 RU Нож с круглым лезвием
 CZ Nůž s kulatým ostřím
 HU Körpengés kés

RO Cutter rotativ
 FR Couteau à lame ronde
 IT Coltello con lama circolare
 ES Cuchillo con filo redondo
 CN 割刀

45
mm

ABS
TPR

SK5

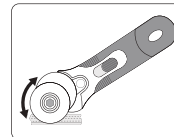

YATO	
YT-75360	12/96

EN Double edge trimmer
 PL Dwustronny nóż do odcinania oklein
 DE Kantentrimmer
 RU Двусторонний нож для мебельной пленки
 CZ Ořezávací nůž na hrany lamina
 HU Kétfélu vágó
 RO Rindea pt. finisaje
 FR Couteau réversible pour bois de placage
 IT Doppio coltello
 ES Cuchillo de doble filo para cortar chapas de madera
 CN 双边刨子

13-25 mm 1-3 SIDED CUTTING CHIECE 1, 2STRONNE SK5



YATO	
YT-5710	6/48

EN Automatic center punch
 PL Punktak automatyczny
 DE Automatischer Kömer
 RU Автоматический кернер
 CZ Automatické důlčikem
 HU Automatikus központ puncs

RO Punctator automat
 FR Pointeau automatique
 IT Bulino automatico
 ES Centro automático punch
 CN 划线笔

125
mm



YATO	L [mm]	
YT-47160	125	12/72

EN Scriber for glass, ceramics and metal
 PL Rysik do szkła, ceramiki i metalu
 DE Reißnadel für Glas, Keramik und Metall
 RU Штихель для стекла, керамика и металла
 CZ Rýsovací jehla na sklo, keramiku a kov
 HU Karctű üveghez, kerámiához és fémhez

RO Ac de trasat pt. sticlă, ceramică și metal
 FR Stylet verre, céramique et métal
 IT Penna di vetro ceramica metallo
 ES Trazador para vidrio, cerámica y metal
 CN 划线器

140
mm

YG6X



YATO	L [mm]	
YT-3740	140	20/300

EN Adjustable automatic center punch
 PL Punktak automatyczny regulowany
 DE Automatischer Kömer mit regelbare Schlagkraft
 RU Регулируемое автоматическое кернер
 CZ Nastavitelné automatické důlčikem
 HU Automatikus központ puncs

RO Punctator automat reglabil
 FR Pointeau automatique réglable
 IT Bulino automatico regolabile
 ES Ajustable centro automático punch
 CN 划线笔



125
mm







YATO	L [mm]	
YT-47161	125	12/72

EN Leather punch
PL Przebijak do skóry
DE Lederlocher
RU Круглый пробойник для кожи
CZ Průbojník na kůži
HU Bőrlyukasztó
RO Preducele
FR Perçoirs à cuir
IT Punteruolo per pelle
ES Perforar en piel
CN 皮带冲



YATO 	Ø [mm]	
YT-35850	2	20/100
YT-35851	3	20/100
YT-35852	4	20/100
YT-35853	5	20/100
YT-35854	6	20/100
YT-35855	7	20/100
YT-35856	8	20/100
YT-35857	9	20/100

YATO 	Ø [mm]	
YT-35858	10	20/100
YT-35859	11	20/100
YT-35860	12	20/100
YT-35861	13	20/100
YT-35862	14	20/100
YT-35863	15	20/100
YT-35864	16	20/100
YT-35865	17	20/100



YATO 	Ø [mm]	
YT-35866	18	20/100
YT-35867	19	20/80
YT-35868	20	20/80
YT-35869	21	20/60
YT-35870	22	20/80
YT-35871	23	10/50
YT-35872	24	20/60
YT-35873	25	20/60



EN Punch set
PL Przebijaki do skóry
DE Lederlocher-set
RU Набор пробойников для кожи
CZ Sada průbojníků na kůži
HU Bőrlyukasztó készlet
RO Set preducele
FR Kit de perçoirs à cuir
IT Set di punzoni
ES Juego de perforar en piel
CN 皮带冲组套



3
PCS

4
PCS



YATO 	Ø [mm]	
YT-35881	6, 8, 10	20/120

YATO 	Ø [mm]	
YT-35880	2, 3, 4, 5	20/120

EN Punch set
PL Przebijaki do skóry
DE Lederlocher-set
RU Набор пробойников для кожи
CZ Sada průbojníků na kůži
HU Bőrlyukasztó készlet
RO Set preducele
FR Kit de perçoirs à cuir
IT Set di punzoni
ES Juego de perforar en piel
CN 冲孔器组套

9
PCS





YATO 	Ø [mm]	
YT-3590	2.5, 3, 4, 5, 6, 7, 8, 9, 10	50

EN Punch set
PL Przebijaki do skóry
DE Lederlocher-set
RU Набор пробойников для кожи
CZ Sada průbojníků na kůži
HU Bőrlyukasztó készlet
RO Set preducele
FR Kit de perçoirs à cuir
IT Set di punzoni
ES Juego de perforar en piel
CN 冲孔器组套

15
PCS



YATO 	Ø [mm]	
YT-3591	2, 2.5, 3.2, 4, 4.8, 5.5, 6.4, 8, 9.5, 11.1, 12.7, 14, 15.8, 19, 22	10

- EN Window scraper CZ Škrábák na skla IT Raschietto per vetro
 PL Skrobak do szyby HU Kaparó üveghez ES Rascador de cristales
 DE Fensterabstreicher RO Răzuitor pt. geamuri CN 刮刀
 RU Скребок для стекла FR Gratteur pour vitres



300 mm

390-600 mm

TELESCOPIC HANDLE
 UCHWYT
 TELESKOPIWY

AI

YATO	L [mm]	
YT-7550	300	10/60

YATO	L [mm]	
YT-7551	390-600	10/60

- EN Floor scraper RO Racleta pt. podea ES Rascador para suelos
 PL Skrobak do podłóg CZ Škrabka na podlahu FR Racloir à plancher CN 地板铲刀
 DE Bodenabstreifer HU Padlókaparó IT Raschietto per pavimenti



65Mn

AI



350 mm

Fitting blades: YT-52843
 Pasujące ostrza: YT-52843

500 mm

Fitting blades: YT-52843
 Pasujące ostrza: YT-52843

YATO	L [mm]	
YT-52840	350	6/12

YATO	L [mm]	
YT-52841	500	2/12

- EN Spare blades RO Lame de rezervă ES Cuchillas de repuesto
 PL Ostrza zapasowe CZ Náhradní břity FR Lame de rechange CN 刀片
 DE Ersatzklingen HU Tartalék pengék IT Lame di ricambio

5 PCS



1.5 mm

65Mn



For YT-52840, YT-52841
 Dla YT-52840, YT-52841

YATO		
YT-52843		10

- EN Sliding hammer with scraper RO Ciocan inertial cu răzuitor
 PL Młot bezwładnościowy ze skrobakiem FR Impact grattoir
 DE Auswirkungen Schaber IT Martello inerziale con raschiatore
 RU Ударный скребок ES Raspador de impacto
 CZ Škrabka CN 冲击铲刀
 HU Kaparó eszköz



TELESCOPIC HANDLE
 UCHWYT
 TELESKOPIWY

T



YATO	L [mm]	
YT-52850	580-820	6

- EN Scraper RO Răzuitor ES Raspador
 PL Cyklina CZ Škrabka na parkety FR Grattoir CN 油漆刮刀
 DE Ziehklinge HU Simitógyalu IT Raschietto per legno



YATO	L [mm]	Blade length / Długość ostrza [mm]	
YT-75460	260	52	10/60

YATO	L [mm]	Blade length / Długość ostrza [mm]	
YT-75461	290	62	12/48

YATO	L [mm]	Blade length / Długość ostrza [mm]	
YT-75464	200	30	10/50
YT-75465	220	40	10/50
YT-75467	270	65	6/24

- EN Prybar scraper set
PL Zestaw skrobaków ze stali nierdzewnej
DE Edelstahl-Schaber-Set
RU Набор скребков из нержавеющей стали
CZ Sada škrabek z nerezové oceli
HU Kaparókészlet rozsdamentes acélból
RO Set de raclate
FR Ensemble de racleurs en acier inoxydable
IT Set di raschietti in acciaio inox
ES Juego de raspadores de acero inoxidable
CN 铲刀

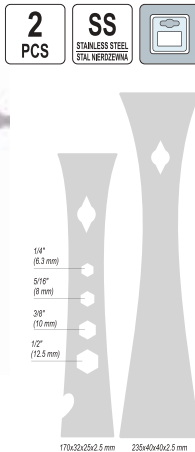

- EN Pry bar scraper set
PL Zestaw łomów i skrobaków
DE Brecheisen Schaber
RU Ломы скребки
CZ Škrabky páčidla
HU Feszítóvas kaparó
RO Set leviere
FR Pieds-de-biche et grattoirs
IT Piedi di porco raschietti
ES Palancas raspadores
CN 撬棍



YATO	[mm]	
YT-52860	170x32x25, 235x40x40	12/48

YATO	[mm]	
YT-52863	135x14, 182x25, 240x42	12/48

- EN Cabinet scraper set
PL Zestaw skrobaków ręcznych nierdzewnych
DE Edelstahl-Handschaber-Set
RU Набор ручных нержавеющей скребков
CZ Sada nerezových ručních škrabek
HU Kézi rozsdamentes kaparókészlet
RO Set raclate
FR Ensemble de grattoirs à main en acier inoxydable
IT Set di raschietti manuali inox
ES Juego de raspadores manuales inoxidables
CN 刮板



YATO	[mm]	
YT-52788	100x160, 120x80, 160x100, 205x98	20/40

- EN Block plane
PL Metalowy strug do drewna
DE Metallhobel für Holz
RU Металлический рубанок по дереву
CZ Kovový hoblík do dřeva
HU Fémgyaly
RO Rindea
FR Rabet à bois en métal
IT Pialla metallica per legno
ES Cepillo metálico para madera
CN 木工铁刨



YATO	Blade width / Szerokość ostrza [mm]	L [mm]	
YT-62900	44	235	24

- EN Block plane with two blade
PL Metalowy strug dwuostrzowy
DE Metallhobel mit Doppelleisen
RU Металлический рубанок с обоюдоострым лезвием
CZ Kovový hoblík s dvojitým ostřím
HU Kétpengés fémgyaly
RO Rindea cu 2 lame
FR Rabet en métal à deux lames
IT Pialla metallica a due lame
ES Cepillo metálico de doble hoja
CN 墙刨刨



YATO	Blade width / Szerokość ostrza [mm]	L [mm]	
YT-62907	23	235	12/48

- EN Chamfering planer
PL Strug do fazowania krawędzi
DE Kantenhobel
RU Рубанок для снятия фаски
CZ Nástroj na srážení hran
HU Letőrési vágógép
RO Rindea pt. tesire
FR Rabet à chanfreiner
IT Pialla per smusso
ES Cepillo para biselar bordes
CN 倒角刨

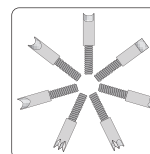

YATO	Blade width / Szerokość ostrza [mm]	L [mm]	
YT-62910	9	155	24

EN Steel file
 PL Piłnik do metalu
 DE Metallfeile
 RU Напильник по металлу
 CZ Zámečnický pilník
 HU Lakatos reszelő
 RO Pliă de lăcătușerie
 FR Lime à métal
 IT Lime per metallo
 ES Lima para metal
 CN 挫刀

#1 #2 #3 150 mm 200 mm 250 mm 300 mm T12



YATO	[#]	L [mm]	
YT-62228	1	150	20/80
YT-62229	1	200	20/80
YT-6223	1	250	20/80
YT-62231	1	300	10/40
YT-6180	2	150	20/80
YT-6185	2	200	20/80
YT-6228	2	250	20/80
YT-6190	2	300	10/40
YT-62328	3	150	20/80
YT-62329	3	200	20/80
YT-6233	3	250	20/80
YT-62331	3	300	10/40

YATO	[#]	L [mm]	
YT-62238	1	150	20/80
YT-62239	1	200	20/80
YT-6224	1	250	20/80
YT-62241	1	300	10/40
YT-6181	2	150	20/80
YT-6186	2	200	20/80
YT-6229	2	250	20/80
YT-6191	2	300	10/40
YT-62243	3	150	20/80
YT-62244	3	200	20/80
YT-62245	3	250	20/80
YT-62246	3	300	10/40



YATO	[#]	L [mm]	
YT-62248	1	150	20/80
YT-62249	1	200	20/80
YT-6225	1	250	20/80
YT-62251	1	300	10/40
YT-6182	2	150	20/80
YT-6187	2	200	20/80
YT-6230	2	250	20/80
YT-6192	2	300	10/40
YT-62338	3	150	20/80
YT-62339	3	200	20/80
YT-6234	3	250	20/80
YT-62341	3	300	10/40

YATO	[#]	L [mm]	
YT-62258	1	150	20/80
YT-62259	1	200	20/80
YT-6226	1	250	20/80
YT-62261	1	300	10/40
YT-6183	2	150	20/80
YT-6188	2	200	20/80
YT-6231	2	250	20/80
YT-6193	2	300	10/40
YT-62348	3	150	20/80
YT-62349	3	200	20/80
YT-6235	3	250	20/80
YT-62351	3	300	10/40

YATO	[#]	L [mm]	
YT-62268	1	150	20/80
YT-62269	1	200	20/80
YT-6227	1	250	20/80
YT-62271	1	300	10/40
YT-6184	2	150	20/80
YT-6189	2	200	20/80
YT-6232	2	250	20/80
YT-6194	2	300	10/40
YT-62358	3	150	20/80
YT-62359	3	200	20/80
YT-6236	3	250	20/80

EN Steel file set
 PL Zestaw pilników do metalu
 DE Metallfeilen-Satz
 RU Набор напильников по металлу

CZ Sada pilníků zámečnických
 HU Lakatos reszelő készlet
 RO Set pile de lăcătușerie
 FR Jeu de limes pour métal

IT Set di lime per metallo
 ES Juego de limas para metal
 CN 钢锉组套

#1 #2 #3 250 mm T12



3 PCS



5 PCS



5 PCS



YATO	[#]	
YT-6237	2	10/20

YATO	[#]	
YT-6238	1, 2	5/10

YATO	[#]	
YT-6239	3	5/10

EN Needle file set
PL Zestaw pilników iglaków
DE Nadelfeilens-Satz
RU Набор надфилей

CZ Sada jehlových pilníků
HU Túreszelő készlet
RO Set pile conice
FR Jeu de limes aiguilles

IT Set lime ad ago
ES Juego de limas de aguja
CN 什锦锉组套

6
PCS

GCr15



YATO	Working length / Długość robocza [mm]	[mm]	
YT-6160	65	3x140	50/200

YATO	Working length / Długość robocza [mm]	[mm]	
YT-6161	75	4x160	25/100

YATO	Working length / Długość robocza [mm]	[mm]	
YT-6162	85	5x180	25/100

EN Needle file set
PL Zestaw pilników iglaków
DE Nadelfeilens-Satz
RU Набор надфилей

CZ Sada jehlových pilníků
HU Túreszelő készlet
RO Set pile conice
FR Jeu de limes aiguilles

IT Set lime ad ago
ES Juego de limas de aguja
CN 什锦锉组套

10
PCS

GCr15



YATO	Working length / Długość robocza [mm]	[mm]	
YT-6163	65	3x140	25/100

YATO	Working length / Długość robocza [mm]	[mm]	
YT-6164	75	4x160	25/100
YT-6165	85	5x180	25/50

EN Diamond needle file
PL Pilnik iglak diamentowy
DE Diamant-Nadelfeile
RU Надфиль алмазный

CZ Diamantový jehlový pilník
HU Gyémánt túreszelő
RO Pilă diamentată
FR Lime diamant

IT Lima ad ago diamantata
ES Lima de aguja diamantada
CN 金刚石尖头锉

G150



YATO	Grit / Ziarnistość	Coating length / Długość nasypu [mm]	[mm]	
YT-6140	G150	52	3x140	120/1200
YT-6147	G150	50	4x160	80/800
YT-6152	G150	70	5x180	45/450

YATO	Grit / Ziarnistość	Coating length / Długość nasypu [mm]	[mm]	
YT-6141	G150	50	3x140	120/1200
YT-6148	G150	50	4x160	80/800
YT-6153	G150	70	5x180	45/450

YATO	Grit / Ziarnistość	Coating length / Długość nasypu [mm]	[mm]	
YT-6142	G150	50	3x140	120/1200
YT-6149	G150	50	4x160	80/800
YT-6154	G150	70	5x180	45/450



EN Diamond needle file set
 PL Zestaw pilników diamentowych iglaków
 DE Diamant-Nadelfeilen-Satz
 RU Набор надфилей алмазных

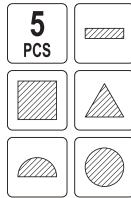
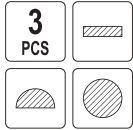

CZ Sada diamentových jehlových pilníků
 HU Gyémánt tűreszelő készlet
 RO Set pile diamentate
 FR Jeu de limes diamant

IT Set lime ad ago diamantate
 ES Juego de limas de aguja diamantadas
 CN 金刚石整形锉

G150 



YATO 	Grit / Ziamistość	Coating length / Długość nasypu [mm]	[mm]	
YT-6143	G150	50	3x140	40/400
YT-6150	G150	50	4x160	30/300
YT-6155	G150	70	5x180	15/150

YATO 	Grit / Ziamistość	Coating length / Długość nasypu [mm]	[mm]	
YT-6156	G150	70	180	10/100



EN Diamond needle file set
 PL Zestaw pilników diamentowych iglaków
 DE Diamant-Nadelfeilen-Satz
 RU Набор надфилей алмазных

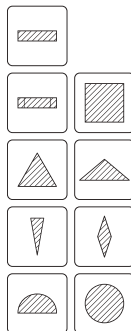
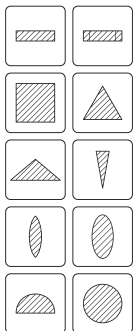

CZ Sada diamentových jehlových pilníků
 HU Gyémánt tűreszelő készlet
 RO Set pile diamentate
 FR Jeu de limes diamant

IT Set lime ad ago diamantate
 ES Juego de limas de aguja diamantadas
 CN 金刚石整形锉



10 PCS **G150** 



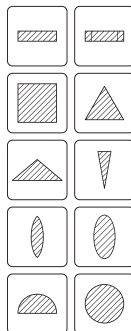
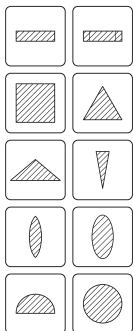

YATO 	Grit / Ziamistość	Coating length / Długość nasypu [mm]	[mm]	
YT-6144	G150	50	3x140	12/120

YATO 	Grit / Ziamistość	Coating length / Długość nasypu [mm]	[mm]	
YT-6145	G150	25	3x140	12/120



YATO 	Grit / Ziamistość	Coating length / Długość nasypu [mm]	[mm]	
YT-6146	G150	30	3x140	12/120

YATO 	Grit / Ziamistość	Coating length / Długość nasypu [mm]	[mm]	
YT-6151	G150	50	4x160	9/90

EN Diamond sharpening file
PL Osełka diamentowa - pilnik
DE Diamant-Schärfen-Datei
RU Напильник алмазный
CZ Diamantový pilník
HU Gyémánt reszelők

RO Pila diamentata pt. ascutit
FR Fichier de diamant
IT Pietra diamentata - lima
ES Archivo de afilado de diamante
CN 金刚石锉刀



YATO	Grit / Ziarnistość	L [mm]	
YT-76080	G240, G400	250	12/48

EN Diamond whetstone
PL Osełka diamentowa - blok
DE Diamant Schleifstein
RU Алмазный брусок
CZ Diamond brousek
HU Kétoldalal gyémánt fenőkő
RO Piatra abraziva diamentata
FR Affiloir diamanté
IT Pietra diamentata
ES Piedra de afilar diamentada
CN 金刚石磨刀石



YATO	Grit / Ziarnistość	Coating length / Długość nasypu [mm]	[mm]	
YT-76085	G300	50	150x50x4	10/60
YT-76086	G400	50	150x50x4	10/60
YT-76087	G600	50	150x50x4	10/60

EN Diamond grinding wheel dresser
PL Przyrząd diamentowy do wyrównywania tarcz szlifierskich
DE Diamant-Schleifrad-Dresser
RU Брусок алмазный для выравнивания абразивных дисков
CZ Diamantový ohrnovávač brusných kotoučů
HU Gyémánt kölehúzó
RO Dispozitiv pt. nivelare pietre polizor
FR Diamant meule roue pierre dresse
IT Utensile diamentato per levigare le mole
ES Muelas tocador con diamante plana
CN 砂轮修正器



YATO	
YT-61395	20/200

EN Wood rasp
PL Tamnik do drewna
DE Holzraspel
RU Рашпиль по дереву

CZ Rašple na dřevo
HU Fareszelő
RO Rasplă
FR Lime à bois

IT Lime per legno
ES Lima para madera
CN 木工锉



YATO	L [mm]		YATO	L [mm]		YATO	L [mm]	
YT-6220	250	12/72	YT-6219	250	12/72	YT-6221	250	12/72

EN Wood rasp set
PL Zestaw tamników do drewna
DE Holzraspelsatz
RU Набор рашпилей для дерева
HU Fareszelő készlet

RO Set raspile pt. lemn
FR Jeu de limes à bois
IT Set di lime per legno
ES Juego de limas para madera
CN 木工锉组套

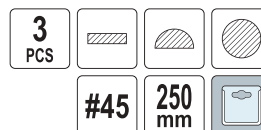

YATO	L [mm]	
YT-6222	250	5/20

EN Rasp for plaster
PL Tamnik do gipsu
DE Gipskartonplatten Rasp
RU Рашпиль для гипсокартона
CZ Rašple pro omítky
HU Reszelt vakolat
RO Rindea
FR Râpe pour plâtre
IT Raspa per gesso
ES Eliminador de yeso
CN 挫刨

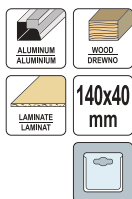

YATO	Working length / Długość robocza [mm]	Working width / Szerokość robocza [mm]	
YT-61678	140	40	15/60

EN Blade for rasp
PL Ostrze zapasowe do tamnika
DE Sägeblatraspel
RU Лезвие для рашпиля по гипсокартону
CZ Čepel do škrabacích
HU Penge reszelő
RO Rezervă pt. rindea de rigips
FR Lame râpe
IT Lama di ricambio per raspa
ES Hoja para raspar
CN 挫刨刀片

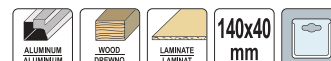

For YT-61678
Dla YT-61678

YATO	Working length / Długość robocza [mm]	Working width / Szerokość robocza [mm]	
YT-61679	140	40	10/120

EN Rasp for plaster
PL Tamnik do gipsu
DE Gipskartonplatten Rasp
RU Рашпиль для гипсокартона
CZ Rašple pro omítky
HU Reszelt vakolat
RO Rindea
FR Râpe pour plâtre
IT Raspa per gesso
ES Eliminador de yeso
CN 挫刨

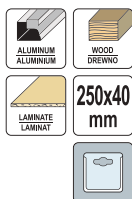

YATO	Working length / Długość robocza [mm]	Working width / Szerokość robocza [mm]	
YT-61680	250	40	15/60

EN Blade for rasp
PL Ostrze zapasowe do tamnika
DE Sägeblatraspel
RU Лезвие для рашпиля по гипсокартону
CZ Čepel do škrabacích
HU Penge reszelő
RO Rezervă pt. rindea de rigips
FR Lame râpe
IT Lama di ricambio per raspa
ES Hoja para raspar
CN 挫刨刀片



For YT-61680
Dla YT-61680



YATO	Working length / Długość robocza [mm]	Working width / Szerokość robocza [mm]	
YT-61681	250	40	30/120

EN Sand paper
 PL Papier ścierny
 DE Schleifpapier
 RU Наждачная бумага
 CZ Smirkový papír
 HU Csiszolópapír

RO Hârtie abrazivă
 FR Papier abrasif
 IT Carta vetrata
 ES Papel de lija
 CN 砂纸



- Application: paint, lacquer, filler, wood
- Abrasive: aluminium oxide
- Bond: synthetic resin
- Coating: semi-open
- Zastosowanie: farby, lakiery, szpachle, drewno
- Scierniwo: tlenek glinu
- Spoiwo: żywica syntetyczna
- Nasyp: półotwarty



YATO 	Grit / Ziarnistość	[mm]	pcs / szt.	
YT-8350	P40	230x280	50	500
YT-8351	P60	230x280	50	500
YT-8352	P80	230x280	50	500
YT-8353	P100	230x280	50	500
YT-8354	P120	230x280	50	500
YT-8355	P150	230x280	50	500
YT-8356	P180	230x280	50	500
YT-8357	P220	230x280	50	500
YT-8358	P240	230x280	50	500

EN Sand paper
 PL Papier ścierny
 DE Schleifpapier
 RU Наждачная бумага
 CZ Smirkový papír
 HU Csiszolópapír

RO Hârtie abrazivă
 FR Papier abrasif
 IT Carta vetrata
 ES Papel de lija
 CN 防水砂纸



- Application: paint, lacquer, filler
- Abrasive: silicon carbide
- Bond: synthetic resin
- Coating: closed
- Zastosowanie: farby, lakiery, szpachle
- Scierniwo: węgiel krzemu
- Spoiwo: żywica syntetyczna
- Nasyp: pełny



YATO 	Grit / Ziarnistość	[mm]	pcs / szt.	
YT-8405	P180	230x280	50	500
YT-8406	P220	230x280	50	500
YT-8407	P240	230x280	50	500
YT-8408	P280	230x280	50	500
YT-8409	P320	230x280	50	500
YT-8410	P360	230x280	50	500
YT-8411	P400	230x280	50	500

EN Sand paper
 PL Papier ścierny
 DE Schleifpapier
 RU Наждачная бумага
 CZ Smirkový papír
 HU Csiszolópapír

RO Hârtie abrazivă
 FR Papier abrasif
 IT Carta vetrata
 ES Papel de lija
 CN 防水砂纸



- Application: paint, lacquer, filler
- Abrasive: silicon carbide
- Bond: synthetic resin
- Coating: closed
- Zastosowanie: farby, lakiery, szpachle
- Scierniwo: węgiel krzemu
- Spoiwo: żywica syntetyczna
- Nasyp: pełny



YATO 	Grit / Ziarnistość	[mm]	pcs / szt.	
YT-8400	P60	230x280	50	500
YT-8401	P80	230x280	50	500
YT-8402	P100	230x280	50	500
YT-8403	P120	230x280	50	500
YT-8404	P150	230x280	50	500

EN Sand paper
 PL Papier ścierny
 DE Schleifpapier
 RU Наждачная бумага
 CZ Smirkový papír
 HU Csiszolópapír

RO Hârtie abrazivă
 FR Papier abrasif
 IT Carta vetrata
 ES Papel de lija
 CN 防水砂纸



- Application: paint, lacquer, filler
- Abrasive: silicon carbide
- Bond: synthetic resin
- Coating: closed
- Zastosowanie: farby, lakiery, szpachle
- Scierniwo: węgiel krzemu
- Spoiwo: żywica syntetyczna
- Nasyp: pełny

YATO 	Grit / Ziarnistość	[mm]	pcs / szt.	
YT-8412	P500	230x280	50	500
YT-8413	P600	230x280	50	500
YT-8414	P800	230x280	50	500
YT-8415	P1000	230x280	50	500
YT-8416	P1200	230x280	50	500
YT-8417	P1500	230x280	50	500
YT-8418	P2000	230x280	50	500

EN Abrasive cloth sheet
PL Płótno ściernie arkusz
DE Schleifgewebe Blatt
RU Шлифовальное полотно
CZ Brusné plátno
HU Csiszolóvászon lap

RO Coală pânză abrazivă
FR Tissu abrasif
IT Carta vetrata
ES Hojas de pano abrasivo
CN 砂布



- Application: metal, wood
- Abrasive: aluminium oxide
- Bond: semi-resin
- Coating: closed
- Zastosowanie: metal, drewno
- Ścierniwo: tlenek glinu
- Spoiwo: żywica
- Nasyp pełny

EN Abrasive mesh
PL Siatka ścierna
DE Schleifgitter
RU Абразивная сетка
CZ Brusná síťka
HU Csiszolóháló

RO Plasă abrazivă
FR Disque abrasif à maille
IT Rete abrasiva
ES Malla abrasiva
CN 网状砂纸

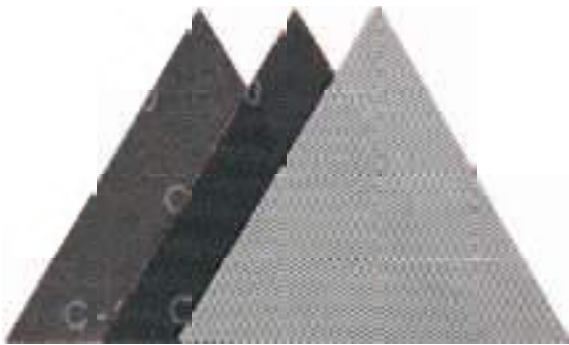
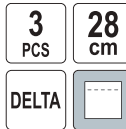

YATO	Grit / Ziarnistość	[mm]	pcs / szt.	
YT-846113	P80	280x280x280	3	100
YT-846133	P120	280x280x280	3	100
YT-846153	P180	280x280x280	3	100

EN Endless sanding belt
PL Taśma ścierna bezkońcowa
DE Schleifband
RU Шлифовальные ленты
CZ Brusný pás
HU Csiszoló szalag

RO Bandă abrazivă continuă
FR Bande abrasive sans fin
IT Nastro abrasivo senza fine
ES Pano abrasivo cinturón
CN 砂带



- Application: metal, wood
- Abrasive: aluminium oxide
- Bond: synthetic resin
- Coating: closed
- Zastosowanie: metal, drewno
- Ścierniwo: tlenek glinu
- Spoiwo: żywica syntetyczna
- Nasyp pełny

YATO	Grit / Ziarnistość	[mm]	pcs / szt.	
YT-09747	P60	20x520	10	50
YT-09748	P80	20x520	10	50
YT-09749	P100	20x520	10	50
YT-09750	P120	20x520	10	50

YATO	Grit / Ziarnistość	[mm]	pcs / szt.	
YT-83160	P36	230x280	50	250
YT-83161	P40	230x280	50	250
YT-83162	P60	230x280	50	250
YT-83163	P80	230x280	50	250
YT-83164	P100	230x280	50	250
YT-83165	P120	230x280	50	500
YT-83166	P150	230x280	50	500
YT-83167	P180	230x280	50	500
YT-83168	P220	230x280	50	500
YT-83169	P240	230x280	50	500

EN Endless sanding belt
PL Taśma ścierna bezkońcowa
DE Schleifband
RU Шлифовальные ленты
CZ Brusný pás
HU Csiszoló szalag

RO Bandă abrazivă continuă
FR Bande abrasive sans fin
IT Nastro abrasivo senza fine
ES Pano abrasivo cinturón
CN 砂带



- Application: metal, wood
- Abrasive: aluminium oxide
- Bond: synthetic resin
- Coating: closed
- Zastosowanie: metal, drewno
- Ścierniwo: tlenek glinu
- Spoiwo: żywica syntetyczna
- Nasyp pełny

YATO	Grit / Ziarnistość	[mm]	pcs / szt.	
YT-09743	P60	10x330	10	100
YT-09744	P80	10x330	10	100
YT-09745	P100	10x330	10	100
YT-09746	P120	10x330	10	100

EN No end abrasive band
PL Pas ścierny bezkońcowy
DE Schleifband
RU Шлифлента бесконечная
CZ Brusný pás
HU Csiszoló szalag

RO Bandă abrazivă continuă
FR Bande abrasive sans fin
IT Nastro abrasivo senza fine
ES Banda abrasiva sin fin
CN 砂带



- Application: metal, wood
- Abrasive: aluminium oxide
- Bond: synthetic resin
- Coating: closed
- Zastosowanie: metal, drewno
- Ścierniwo: tlenek glinu
- Spoiwo: żywica syntetyczna
- Nasyp pełny

YATO	Grit / Ziarnistość	[mm]	pcs / szt.	
YT-83221	P40	75x457	5	20/60
YT-83222	P60	75x457	5	20/60
YT-83223	P80	75x457	5	20/60
YT-83224	P100	75x457	5	20/60
YT-83225	P120	75x457	5	20/60

EN No end abrasive band
 PL Pas ścierny bezkońcowy
 DE Schleifband
 RU Шлифлента бесконечная

CZ Brusný pás
 HU Csiszoló szalag
 RO Bandă abrazivă continuă
 FR Bande abrasive sans fin

IT Nastro abrasivo senza fine
 ES Banda abrasiva sin fin
 CN 砂带



- Application: metal, wood
- Abrasive: aluminium oxide
- Bond: synthetic resin
- Coating: closed
- Zastosowanie: metal, drewno
- Ścierańco: tlenek glinu
- Spoiwo: żywica syntetyczna
- Nasyp pełny

YATO	Grit / Ziarnistość	[mm]	pcs / szt.	
YT-83227	P36	75x533	5	20/60
YT-83228	P40	75x533	5	20/60
YT-83229	P60	75x533	5	20/60
YT-83230	P80	75x533	5	20/60
YT-83231	P100	75x533	5	20/60
YT-83232	P120	75x533	5	20/60
YT-83233	P150	75x533	5	20/60

EN No end abrasive band
 PL Pas ścierny bezkońcowy
 DE Schleifband
 RU Шлифлента бесконечная

CZ Brusný pás
 HU Csiszoló szalag
 RO Bandă abrazivă continuă
 FR Bande abrasive sans fin

IT Nastro abrasivo senza fine
 ES Banda abrasiva sin fin
 CN 砂带



- Application: metal, wood
- Abrasive: aluminium oxide
- Bond: synthetic resin
- Coating: closed
- Zastosowanie: metal, drewno
- Ścierańco: tlenek glinu
- Spoiwo: żywica syntetyczna
- Nasyp pełny

YATO	Grit / Ziarnistość	[mm]	pcs / szt.	
YT-83235	P40	100x610	5	20/60
YT-83236	P60	100x610	5	10/30
YT-83237	P80	100x610	5	20/60
YT-83238	P100	100x610	5	20/60
YT-83239	P120	100x610	5	20/60

EN Sponge with diamond surface
 PL Gąbka z powierzchnią diamentową
 DE Diamant-Schleifschwamm
 RU Губка алмазная прямая
 CZ Diamantová houbička pro leštění
 HU Gyémánt felületű szivacs
 RO Burete cu suprafata diamantata
 FR Éponge à surface diamantée
 IT Spugna con superficie diamantata
 ES Esponja para lijar a mano de diamante
 CN 金刚石打磨块



YATO	Grit / Ziarnistość	
YT-76101	G60	50

EN Sponge with diamond surface
 PL Gąbka z powierzchnią diamentową
 DE Diamant-Schleifschwamm
 RU Губка алмазная прямая
 CZ Diamantová houbička pro leštění
 HU Gyémánt felületű szivacs
 RO Burete cu suprafata diamantata
 FR Éponge à surface diamantée
 IT Spugna con superficie diamantata
 ES Esponja para lijar a mano de diamante
 CN 金刚石打磨块



YATO	Grit / Ziarnistość	
YT-76105	G200	50

EN Sponge with diamond surface
 PL Gąbka z powierzchnią diamentową
 DE Diamant-Schleifschwamm
 RU Губка алмазная прямая
 CZ Diamantová houbička pro leštění
 HU Gyémánt felületű szivacs
 RO Burete cu suprafata diamantata
 FR Éponge à surface diamantée
 IT Spugna con superficie diamantata
 ES Esponja para lijar a mano de diamante
 CN 金刚石打磨块



YATO	Grit / Ziarnistość	
YT-76103	G100	50

EN Sponge with diamond surface
 PL Gąbka z powierzchnią diamentową
 DE Diamant-Schleifschwamm
 RU Губка алмазная прямая
 CZ Diamantová houbička pro leštění
 HU Gyémánt felületű szivacs
 RO Burete cu suprafata diamantata
 FR Éponge à surface diamantée
 IT Spugna con superficie diamantata
 ES Esponja para lijar a mano de diamante
 CN 金刚石打磨块



YATO	Grit / Ziarnistość	
YT-76108	G400	50

EN Flap disc – regular shape
PL Ściernica listkowa talerzowa płaska
DE Fächerschleifscheibe gerade
RU Круг лепестковый тарельчатый
CZ Lamelový brusný kotouč
HU Lamellás csiszoló normál
RO Disc lamelar frontal
FR Disque à lamelles abrasives plat
IT Disco abrasivo per metallo
ES Discos de paño abrasivo
CN 百叶轮



- Application: metal
- Abrasive: aluminium oxide
- Bond: synthetic resin
- Backing: fibreglass
- Zastosowanie: metal
- Ścierniwo: tlenek glinu
- Spoiwo: żywica syntetyczna
- Podkład: włókno szklane

YATO	Grit / Ziarnistość	Ø [mm]	Mounting hole diameter / Średnica mocowania [mm]	
YT-83271	P36	125	22.4	25/100
YT-83272	P40	125	22.4	25/100
YT-83273	P60	125	22.4	50/200
YT-83274	P80	125	22.4	50/200
YT-83275	P100	125	22.4	50/200
YT-83276	P120	125	22.4	50/200

EN Flap wheel with shaft
PL Ściernica listkowa trzpieniowa
DE Fächerschleifer mit Schaft
RU Круг лепестковый со шпинделем
CZ Lamelový kotouč s hřídelí
HU Legyező csiszoló csapos
RO Perie abraziva circulara cu tija
FR Disque à lamelles abrasives pivot
IT Ruote lamellari
ES Rueda laminar en tela abrasiva
CN 百叶轮



40x20
x6
mm
18000
min⁻¹

- Application: metal
- Abrasive: aluminium oxide
- Bond: synthetic resin
- Zastosowanie: metal
- Ścierniwo: tlenek glinu
- Spoiwo: żywica syntetyczna

YATO	Grit / Ziarnistość	[mm]	
YT-83351	P40	40x20x6	10/60
YT-83352	P60	40x20x6	10/60
YT-83353	P80	40x20x6	10/60
YT-83354	P100	40x20x6	10/60
YT-83355	P120	40x20x6	10/60
YT-83356	P150	40x20x6	10/60

EN Flap wheel with shaft
PL Ściernica listkowa trzpieniowa
DE Fächerschleifer mit Schaft
RU Круг лепестковый со шпинделем
CZ Lamelový kotouč s hřídelí
HU Legyező csiszoló csapos
RO Perie abraziva circulara cu tija
FR Disque à lamelles abrasives pivot
IT Ruote lamellari
ES Rueda laminar en tela abrasiva
CN 百叶轮



80x30
x6
mm
12000
min⁻¹

- Application: metal
- Abrasive: aluminium oxide
- Bond: synthetic resin
- Zastosowanie: metal
- Ścierniwo: tlenek glinu
- Spoiwo: żywica syntetyczna

YATO	Grit / Ziarnistość	[mm]	
YT-83371	P40	80x30x6	10/60
YT-83372	P60	80x30x6	10/60
YT-83373	P80	80x30x6	10/60
YT-83374	P100	80x30x6	10/60
YT-83375	P120	80x30x6	10/60
YT-83376	P150	80x30x6	10/60

EN Flap disc – depressed shape
PL Ściernica listkowa talerzowa wypukła
DE Fächerschleifscheibe gewölbt
RU Круг лепестковый тарельчатый
CZ Lamelový brusný kotouč - vypuklý
HU Lamellás csiszoló dőntött
RO Disc lamelar frontal depresat
FR Disque à lamelles abrasives bombé
IT Disco abrasivo a centro depresso
ES Discos de paño abrasivo centro embudido
CN 百叶轮

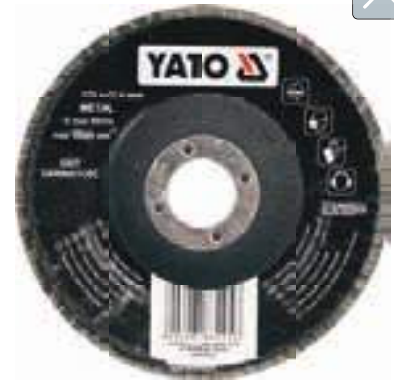

- Application: metal
- Abrasive: aluminium oxide
- Bond: synthetic resin
- Backing: fibreglass
- Zastosowanie: metal
- Ścierniwo: tlenek glinu
- Spoiwo: żywica syntetyczna
- Podkład: włókno szklane

YATO	Grit / Ziarnistość	Ø [mm]	Mounting hole diameter / Średnica mocowania [mm]	
YT-83291	P36	125	22.4	25/100
YT-83292	P40	125	22.4	25/100
YT-83293	P60	125	22.4	50/200
YT-83294	P80	125	22.4	50/200
YT-83295	P100	125	22.4	50/200
YT-83296	P120	125	22.4	50/200

EN Flap wheel with shaft
PL Ściernica listkowa trzpieniowa
DE Fächerschleifer mit Schaft
RU Круг лепестковый со шпинделем
CZ Lamelový kotouč s hřídelí
HU Legyező csiszoló csapos
RO Perie abraziva circulara cu tija
FR Disque à lamelles abrasives pivot
IT Ruote lamellari
ES Rueda laminar en tela abrasiva
CN 百叶轮



60x30
x6
mm
15000
min⁻¹

- Application: metal
- Abrasive: aluminium oxide
- Bond: synthetic resin
- Zastosowanie: metal
- Ścierniwo: tlenek glinu
- Spoiwo: żywica syntetyczna

YATO	Grit / Ziarnistość	[mm]	
YT-83361	P40	60x30x6	10/60
YT-83362	P60	60x30x6	10/60
YT-83363	P80	60x30x6	10/60
YT-83364	P100	60x30x6	10/60
YT-83365	P120	60x30x6	10/60
YT-83366	P150	60x30x6	10/60

EN Flap wheel with shaft
PL Ściernica listkowa trzpieniowa
DE Fächerschleifer mit Schaft
RU Круг лепестковый со шпинделем
CZ Lamelový kotouč s hřídelí
HU Legyező csiszoló csapos
RO Perie abraziva circulara cu tija
FR Disque à lamelles abrasives pivot
IT Ruote lamellari
ES Rueda laminar en tela abrasiva
CN 百叶轮



80x40
x6
mm
12000
min⁻¹

- Application: metal
- Abrasive: aluminium oxide
- Bond: synthetic resin
- Zastosowanie: metal
- Ścierniwo: tlenek glinu
- Spoiwo: żywica syntetyczna

YATO	Grit / Ziarnistość	[mm]	
YT-83381	P40	80x40x6	10/60
YT-83382	P60	80x40x6	10/60
YT-83383	P80	80x40x6	10/60
YT-83384	P100	80x40x6	10/60
YT-83385	P120	80x40x6	10/60
YT-83386	P150	80x40x6	10/60

EN Flap wheel with shaft
 PL Ściernica listkowa trzpieniowa
 DE Fächerschleifer mit Schaft
 RU Круг лепестковый со шпинделем
 CZ Lamelový kotouč s hřídelí
 HU Legyező csiszoló csapos
 RO Perie abraziva circulara cu tija
 FR Disque à lamelles abrasives pivot
 IT Ruote lamellari
 ES Rueda laminar en tela abrasiva
 CN 百叶轮



- Application: metal
- Abrasive: aluminium oxide
- Bond: synthetic resin
- Zastosowanie: metal
- Ścierniwo: tlenek glinu
- Spoivo: żywica syntetyczna

YATO	Grit / Ziarnistość	[mm]	
YT-83390	P60	50x30x6	10/60
YT-83391	P100	50x30x6	10/60
YT-83392	P150	50x30x6	10/60
YT-83393	P200	50x30x6	10/60

EN Flap wheel with shaft
 PL Ściernica listkowa trzpieniowa
 DE Fächerschleifer mit Schaft
 RU Круг лепестковый со шпинделем
 CZ Lamelový kotouč s hřídelí
 HU Legyező csiszoló csapos
 RO Perie abraziva circulara cu tija
 FR Disque à lamelles abrasives pivot
 IT Ruote lamellari
 ES Rueda laminar en tela abrasiva
 CN 百叶轮



- Application: metal
- Abrasive: aluminium oxide
- Bond: synthetic resin
- Zastosowanie: metal
- Ścierniwo: tlenek glinu
- Spoivo: żywica syntetyczna

YATO	Grit / Ziarnistość	[mm]	
YT-83394	P60	60x50x6	10/60
YT-83395	P100	60x50x6	10/60
YT-83396	P150	60x50x6	10/60
YT-83397	P200	60x50x6	10/60

EN Flap wheel with shaft
 PL Ściernica listkowa trzpieniowa
 DE Fächerschleifer mit Schaft
 RU Круг лепестковый со шпинделем
 CZ Lamelový kotouč s hřídelí
 HU Legyező csiszoló csapos
 RO Perie abraziva circulara cu tija
 FR Disque à lamelles abrasives pivot
 IT Ruote lamellari
 ES Rueda laminar en tela abrasiva
 CN 百叶轮



- Application: metal
- Abrasive: aluminium oxide
- Bond: synthetic resin
- Zastosowanie: metal
- Ścierniwo: tlenek glinu
- Spoivo: żywica syntetyczna

YATO	Grit / Ziarnistość	[mm]	
YT-83398	P60	80x50x6	10/60
YT-83399	P100	80x50x6	10/60
YT-83400	P150	80x50x6	10/60
YT-83401	P200	80x50x6	10/60

EN Abrasive mesh
 PL Siatka ścierna
 DE Schleifgitter
 RU Абразивная сетка
 CZ Brusná síťka
 HU Csiszolóháló
 RO Disc plasă abrazivă
 FR Disque abrasif à maille
 IT Rete abrasiva
 ES Malla abrasiva
 CN 网状砂纸



YATO	Grit / Ziarnistość	Ø [mm]	pcs / szt.	
YT-845803	P60	225	3	100
YT-845813	P80	225	3	100
YT-845823	P100	225	3	100
YT-845833	P120	225	3	100
YT-845843	P150	225	3	100
YT-845853	P180	225	3	100
YT-845863	P220	225	3	100

EN Abrasive disc
 PL Krążek ścierny
 DE Schleifblatt
 RU Круг шлифовальный
 CZ Brusný kotouč
 HU Csiszoló tárcsa
 RO Disc abraziv
 FR Disques abrasifs avec velcro
 IT Disco abrasivo
 ES Juego de discos abrasivos
 CN 圆形砂纸



- Application: metal, wood
- Abrasive: aluminium oxide
- Bond: synthetic resin
- Coating: semi-open
- Zastosowanie: metal, drewno
- Ścierniwo: tlenek glinu
- Spoivo: żywica syntetyczna
- Nasyp: półotwarty

YATO	Grit / Ziarnistość	Ø [mm]	
YT-83430	P36	125	50/200
YT-83431	P40	125	50/200
YT-83432	P60	125	50/200
YT-83433	P80	125	50/200
YT-83434	P100	125	50/200
YT-83435	P120	125	50/200
YT-83436	P150	125	50/200
YT-83437	P180	125	50/200
YT-83438	P220	125	50/200

EN Perforated abrasive disc
 PL Krążek ścierny perforowany
 DE Schleifscheibe, perforiert
 RU Перфорированный шлифовальный диск
 CZ Brusný kotouč perforovaný
 HU Perforált csiszolópapír
 RO Disc abraziv cu orificii
 FR Disque abrasif perforé
 IT Disco abrasivo perforato
 ES Muela abrasiva perforada
 CN 多孔砂纸



YATO	Grit / Ziarnistość	Ø [mm]	pcs / szt.	
YT-846003	P60	225	3	33
YT-846013	P80	225	3	33
YT-846023	P100	225	3	33
YT-846033	P120	225	3	33
YT-846043	P150	225	3	33
YT-846053	P180	225	3	33
YT-846063	P220	225	3	33

EN Abrasive disc with holes
 PL Krążek ścierny z otworami
 DE Schleifscheibe mit Löchern
 RU Круг шлифовальный перфорированный
 CZ Brusný kotouč s otvory
 HU Csiszolókorong nyílásokkal
 RO Disc abraziv cu orificii
 FR Disque abrasif avec trous
 IT Disco abrasivo con fori
 ES Disco abrasivo con orificios
 CN 圆形带孔砂纸

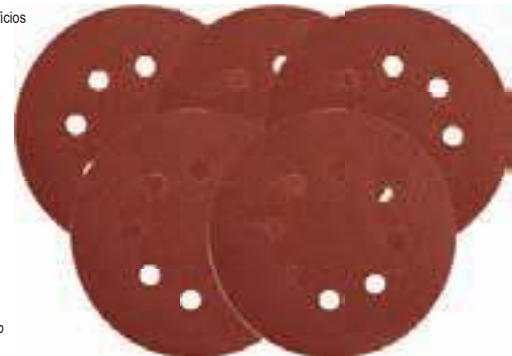

- Application: metal, wood
- Abrasive: aluminium oxide
- Bond: synthetic resin
- Coating: semi-open
- Zastosowanie: metal, drewno
- Ścierniwo: tlenek glinu
- Spoivo: żywica syntetyczna
- Nasyp: półotwarty

YATO	Grit / Ziarnistość	Ø [mm]	
YT-83451	P40	125	50/200
YT-83452	P60	125	50/200
YT-83453	P80	125	50/200
YT-83454	P100	125	50/200
YT-83455	P120	125	50/200
YT-83456	P150	125	50/200
YT-83457	P180	125	50/200
YT-83458	P220	125	50/200

EN Abrasive disc with holes
PL Kształek ścierny z otworami
DE Schleifscheibe mit Löchern
RU Круг шлифовальный перфорированный
CZ Brusný kotouč s otvory
HU Csiszolókorong nyílásokkal
RO Disc abraziv cu orificii
FR Disque abrasif avec trous
IT Disco abrasivo con fori
ES Disco abrasivo con orificios
CN 圆形带孔砂纸

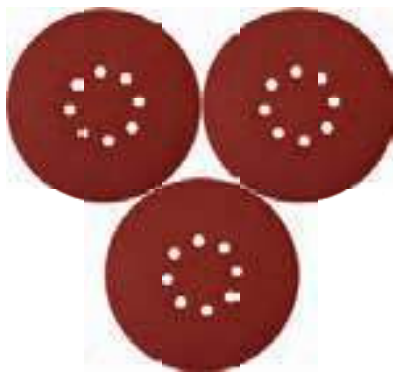

- Application: wood, plaster, paints
- Abrasive: aluminium oxide
- Bond: synthetic resin
- Coating: open
- Zastosowanie: drewno, gips, farby
- Ścierniwo: tlenek glinu
- Spoiwo: żywica syntetyczna
- Nasyp: otwarty

YATO	Grit / Ziarnistość	Ø [mm]	
YT-83460	P40	180	50/200
YT-83461	P60	180	50/200
YT-83462	P80	180	50/200
YT-83463	P100	180	50/200
YT-83464	P120	180	50/200
YT-83465	P150	180	50/200
YT-83466	P180	180	50/200
YT-83467	P240	180	50/200

EN Abrasive disc with holes
PL Kształek ścierny z otworami
DE Schleifscheibe mit Löchern
RU Круг шлифовальный перфорированный
CZ Brusný kotouč s otvory
HU Csiszolókorong nyílásokkal
RO Disc abraziv cu orificii
FR Disque abrasif avec trous
IT Disco abrasivo con fori
ES Disco abrasivo con orificios
CN 圆形带孔砂纸



- Application: wood, plaster
- Abrasive: aluminium oxide
- Bond: synthetic resin
- Coating: semi-open
- Zastosowanie: drewno, gips
- Ścierniwo: tlenek glinu
- Spoiwo: żywica syntetyczna
- Nasyp: półotwarty

For YT-82340, YT-82350, 79307
Dla YT-82340, YT-82350, 79307

YATO	Grit / Ziarnistość	Ø [mm]	
YT-83471	P60	225	60/120
YT-83472	P80	225	60/120
YT-83473	P100	225	60/120
YT-83474	P120	225	60/120
YT-83475	P150	225	60/120
YT-83476	P180	225	60/120
YT-83477	P240	225	60/120

EN Abrasive disc with holes
PL Kształek ścierny z otworami
DE Schleifscheibe mit Löchern
RU Круг шлифовальный перфорированный
CZ Brusný kotouč s otvory
HU Csiszolókorong nyílásokkal
RO Disc abraziv cu orificii
FR Disque abrasif avec trous
IT Disco abrasivo con fori
ES Disco abrasivo con orificios
CN 圆形带孔砂纸



- Application: steel, wood, paints, lacquers
- Abrasive: aluminium oxide
- Bond: epoxy resin
- Coating: semi-open
- Zastosowanie: stal, drewno, farby, lakiery
- Ścierniwo: tlenek glinu
- Spoiwo: żywica epoksydowa
- Nasyp: półotwarty

For YT-09739, YT-09740
Dla YT-09739, YT-09740

YATO	Grit / Ziarnistość	Ø [mm]	
YT-834581	P40	150	20
YT-834582	P60	150	20
YT-834583	P80	150	20
YT-834584	P100	150	20
YT-834585	P120	150	20
YT-834586	P150	150	20
YT-834587	P180	150	20
YT-834588	P220	150	20
YT-834589	P240	150	20

EN Abrasive disc with holes
PL Kształek ścierny z otworami
DE Schleifscheibe mit Löchern
RU Круг шлифовальный перфорированный
CZ Brusný kotouč s otvory
HU Csiszolókorong nyílásokkal
RO Disc abraziv cu orificii
FR Disque abrasif avec trous
IT Disco abrasivo con fori
ES Disco abrasivo con orificios
CN 圆形带孔砂纸



- Application: steel, wood, paints, lacquers
- Abrasive: aluminium oxide
- Bond: epoxy resin
- Coating: semi-open
- Zastosowanie: stal, drewno, farby, lakiery
- Ścierniwo: tlenek glinu
- Spoiwo: żywica epoksydowa
- Nasyp: półotwarty

For YT-82206, YT-82207
Dla YT-82206, YT-82207

YATO	Grit / Ziarnistość	Ø [mm]	
YT-834591	P40	150	20
YT-834592	P60	150	20
YT-834593	P80	150	20
YT-834594	P100	150	20
YT-834595	P120	150	20
YT-834596	P150	150	20
YT-834597	P180	150	20
YT-834598	P220	150	20
YT-834599	P240	150	20

EN Abrasive sheet with holes
PL Arkusz ścierny z otworami
DE Schleifblatt mit Löchern
RU Шлифовальная перфорированная бумага
CZ Brusný papír perforovaný
HU Rezgőcsiszoló papír
RO Coală abrazivă cu orificii
FR Papier de verre perforé
IT Carta abrasiva con fori
ES Hoja abrasiva con agujeros
CN 砂纸



- Application: steel, wood, paints, filler
- Abrasive: aluminium oxide
- Bond: synthetic resin
- Coating: semi-open
- Zastosowanie: stal, drewno, farby, szpachle
- Ścierniwo: tlenek glinu
- Spoiwo: żywica syntetyczna
- Nasyp: półotwarty

For YT-82230
Dla YT-82230

YATO	Grit / Ziarnistość	[mm]	
YT-83800	P40	93x187	100/200
YT-83801	P60	93x187	100/200
YT-83802	P80	93x187	100/200
YT-83803	P100	93x187	100/200
YT-83804	P120	93x187	100/200
YT-83805	P150	93x187	100/200
YT-83806	P180	93x187	100/200
YT-83807	P220	93x187	100/200
YT-83808	P240	93x187	100/200

EN Back pad for drywall sander
 PL Wymienna głowica szlifierska dla szlifierki do gipsu
 DE Schleifkopf für Gips-Schleifmaschine abnehmbar
 RU Запасная шлифовальная головка для гипсовой шлифовальной машины
 CZ Náhradní brusná hlavice pro broušení sádry
 HU Cserélhető csiszolófej falcsiszoló géphez
 RO Disc pt. slefuitor pereti
 FR Tête de ponçage de rechange pour ponceuses à plâtre
 IT Testa rotonda sostituibile per smerigliatrice per gesso
 ES Cabeza de rectificado reemplazable para la rectificadora de yeso
 CN 圓磨盤



For / Dla : YT-82340, YT-82350
 Fitting sand papers / Pasujące papiery: YT-83470, YT-83471, YT-83472, YT-83473, YT-83474, YT-83475, YT-83476, YT-83477, YT-84600, YT-84601, YT-84602, YT-84603, YT-84604, YT-84605, YT-84606

YATO	Ø [mm]	
YT-82353	225	15/60

EN Hook and loop sanding pad
 PL Talerz polerski z rzepem
 DE Klett-Polierteller
 RU Диск с липучкой полировальный
 CZ Talíř se suchým zipem
 HU Tépőzáras tárcsa
 RO Support disc abraziv cu velcro
 FR Plateau avec velcro
 IT Platorello con velcro
 ES Plato de soporte con velcro
 CN 抛光盘



YATO	Ø [mm]	
YT-47870	75	200
YT-47872	125	150
YT-47873	150	100

EN Hook and loop polishing sponge
 PL Gąbka polerska na rzep
 DE Klett-Polierschwamm
 RU Губка для полировки с липучкой
 CZ Leštící houba na suchý zip
 HU Tépőzáras polírozó szivacs
 RO Burete pt. lustruit
 FR Éponge de polissage avec velcro
 IT Tampone in spugna con velcro
 ES Esponja de pulido con velcro
 CN 海绵抛光盘

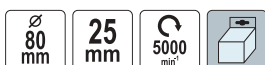

YATO	Sponge hardness / Twardość gąbki	
YT-47920	miękka	200
YT-47921	średnio twarda	200
YT-47922	twarda	200

EN Triangle back pad for drywall sander
 PL Wymienna trójkątna głowica dla szlifierki do gipsu
 DE Dreieck-Schleifkopf für Gips-Schleifmaschine abnehmbar
 RU Запасная треугольная головка для гипсовой шлифовальной машины
 CZ Vyměnitelná trojúhelníková hlavice pro broušení sádry
 HU Háromszög alakú cserélhető csiszolófej falcsiszoló géphez
 RO Disc triunghiular pt. slefuitor pereti
 FR Tête triangulaire de rechange pour ponceuse à plâtre
 IT Testa triangolare sostituibile per smerigliatrice per gesso
 ES Cabeza triangular reemplazable para la rectificadora de yeso
 CN 三角磨盤



For / Dla : YT-82350
 Fitting sand papers / Pasujące papiery: YT-84610, YT-84611, YT-84612, YT-84613, YT-84614, YT-84615, YT-84616

YATO	Dimensions / Wymiary [mm]	
YT-82354	280x280x280	20/60

EN Hook and loop backing pad
 PL Uchwyt mocujący z rzepem
 DE Klett-Haftstützteller
 RU Насадка шлифовальная под круг на липучке
 CZ Unašeč se suchým zipem
 HU Rögztűlőtárcsa tépőzáras
 RO Disc suport cu scai
 FR Plateau support avec velcro
 IT Platorello con velcro
 ES Plato para lijar y pulir con velcro
 CN 抛光盘



YATO	Ø [mm]	max. c [min⁻¹]	
YT-47860	75	12000	200
YT-47890	125	5000	100



EN Hook and loop polishing sponge
 PL Gąbka polerska na rzep
 DE Klett-Polierschwamm
 RU Губка для полировки с липучкой
 CZ Leštící houba na suchý zip
 HU Tépőzáras polírozó szivacs
 RO Burete pt. lustruit
 FR Éponge de polissage avec velcro
 IT Tampone in spugna con velcro
 ES Esponja de pulido con velcro
 CN 海绵抛光盘



YATO	Sponge hardness / Twardość gąbki	
YT-47892	miękka	200
YT-47893	średnio twarda	200
YT-47894	twarda	80
YT-47895	bardzo twarda	80



EN Hook and loop sanding sponge
PL Gąbka ścierna na rzep
DE Klett-Schleifschwamm
RU Губка полировальная с липучкой
CZ Abrázivní houba na suchý zip
HU Tépözárás csiszolószivacs
RO Burete abraziv cu velcro
FR Éponge abrasive à velcro
IT Spugna abrasiva con velcro
ES Esponja abrasiva con velcro
CN 海绵抛光盘



YATO 	
YT-47896	200



EN Thread adapter
PL Adapter z gwintem
DE Adapter mit Gewinde
RU Адаптер с винтом
CZ Adaptér se závitem
HU Menetes adapter
RO Adaptor cu filet
FR Adaptateur avec filetage
IT Adattatore con filettatura
ES Adaptador con rosca
CN 接杆



YATO 	Ø [mm]	
YT-47868	6	500

EN Polishing pad
PL Pad polerski
DE Polierpad
RU Диск полировальный
CZ Leštící kotouč
HU Polírozó tárcsa
RO Disc de lustruit
FR Tampon de polissage
IT Disco lucidatura
ES Pad de pulido
CN 海绵抛光盘



YATO 	Sponge hardness / Twardość gąbki	
YT-47880	miękka	60
YT-47881	średnio twarda	60
YT-47882	twarda	60
YT-47883	bardzo twarda	60



EN Polishing pad with sanding sponge
PL Pad polerski z gąbką ścierną
DE Polierpad mit Schleifschwamm
RU Диск полировальный с губкой
CZ Leštící kotouč abrazivní houba
HU Polírozó tárcsa csiszolószivaccsal
RO Disc de lustruit cu burete abraziv
FR Tampon de polissage avec éponge abrasive
IT Tampone lucidante con spugna abrasiva
ES Pad de pulido con esponja abrasiva
CN 海绵抛光盘



YATO 	
YT-47884	60



EN Polishing felt
PL Filc polerski
DE Polierfilz
RU Диск с войлоком для полировки
CZ Leštící filc
HU Poplírozó filc
RO Pâslă de lustruire
FR Feutre de polissage
IT Disco in feltro per lucidatura
ES Fieltro de pulido
CN 羊毛抛光盘



YATO 	Ø [mm]	H [mm]	
YT-47902	75	10	200
YT-47901	125	10	150
YT-47900	125	20	100

EN Hook and loop buffing pad
PL Futro polerskie na rzep
DE Klett-Polierfell
RU Полировальный меховой круг на липучке
CZ Vlněný leštící kotouč na suchý zip
HU Tépözárás gyapjas polírozó korong
RO Disc pt. polișat cu blană
FR Tampon de polissage à velcro
IT Pelliccia lucidante con velcro
ES Piel de pulido con velcro
CN 羊毛抛光盘





YATO 	Ø [mm]	
YT-47910	80	200
YT-47911	125	100
YT-47912	150	80
YT-47913	180	60

EN Polishing pad kit
 PL Zestaw do polerowania
 DE Polierpad-Set
 RU Набор для полировки
 CZ Leštící sada
 HU Polírozó készlet
 RO Kit discuri de lustruit
 FR Kit de polissage
 IT Kit per lucidatura
 ES Conjunto para pulido
 CN 抛光海绵

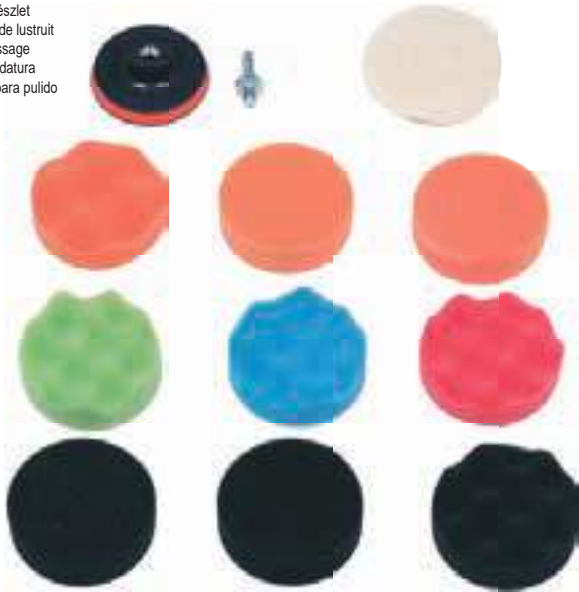
12 PCS **80** mm **6000** min² **M10** 





YATO 	Ø [mm]	
YT-47930	80	40

EN Polishing pad kit
 PL Zestaw do polerowania
 DE Polierpad-Set
 RU Набор для полировки
 CZ Leštící sada
 HU Polírozó készlet
 RO Kit discuri de lustruit
 FR Kit de polissage
 IT Kit per lucidatura
 ES Conjunto para pulido
 CN 抛光海绵

8 PCS **180** mm **6000** min² **M14** 





YATO 	Ø [mm]	
YT-47933	180	12

EN Polishing sponges for rims
 PL Gąbki polerskie do felg
 DE Polierschwämme für Felgen
 RU Полировальные губки для автомобильных шин
 CZ Leštící houby na ráčky
 HU Felincsiszóló szivacsok
 RO Bureți pt. lustruit jante
 FR Éponges de polissage des jantes
 IT Spugne lucidanti per cerchi
 ES Esponjas de pulido para llantas
 CN 海绵抛光轮

3 PCS **30-75** mm **80** mm **6000** min² **6** mm 





YATO 	Ø [mm]	
YT-47945	30-75	50

EN Polishing pad kit
 PL Zestaw do polerowania
 DE Polierpad-Set
 RU Набор для полировки
 CZ Leštící sada
 HU Polírozó készlet
 RO Kit discuri de lustruit
 FR Kit de polissage
 IT Kit per lucidatura
 ES Conjunto para pulido
 CN 抛光海绵

12 PCS **6000** min² **M14** 





YATO 	Ø [mm]	
YT-47931	125	12
YT-47932	150	12

EN Polishing pads
 PL Nakładki polerskie
 DE Polierhauben
 RU Накладки для полировки
 CZ Leštící kotouče
 HU Polírozó sapkák
 RO Discuri de lustruit
 FR Tampons de polissage
 IT Cuffie per lucidatura
 ES Almohadillas para pulido
 CN 仿毛抛光盘

2 PCS **250** mm **5000** min² 



For YT-82922
 Dla YT-82922

YATO 	Ø [mm]	
YT-47940	250	60

Memo

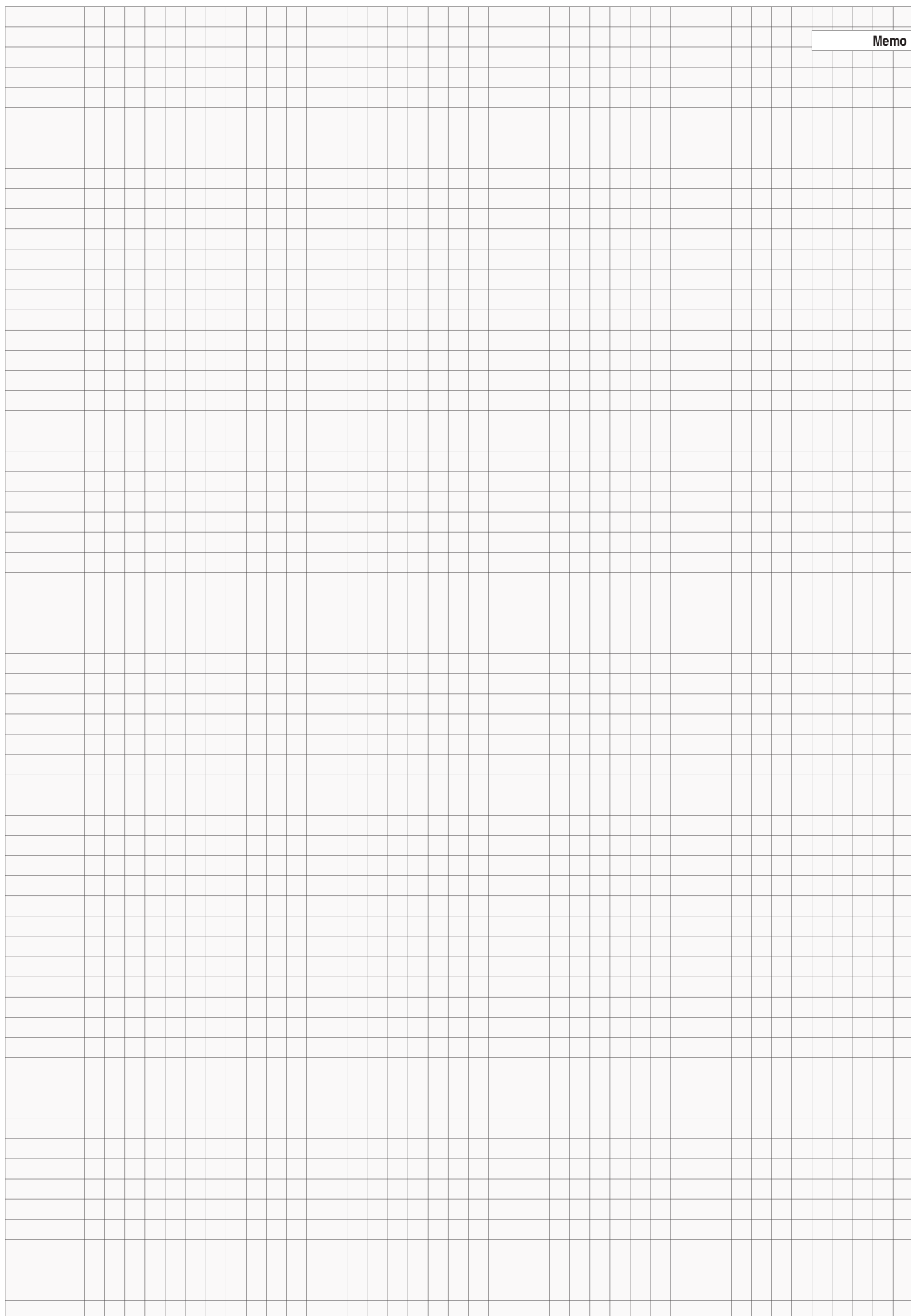

11

Plumbing tools
Narzędzia hydrauliczne



Ratchet die stock sets
Gwintownice ręczne z zestawem głowic

248



Calibrators
Kalibratory

258



Accessories for ratchet die stock
Akcesoria do gwintownic ręcznych

248



Pipe welders
Zgrzewarki do rur

258



Pipe wrenches
Klucze do rur

249-250



Pipe crimping pliers & accessories
Zaciskarki do rur i akcesoria

259-260



Strap wrenches
Klucze do rur taśmowe

250



Hinged pipe vices
Imadła zaciskowe do rur

260



Chain pipe wrenches
Klucze do rur łańcuchowe

250



Thread seal strings
Nici do uszczelniania gwintów

260



Water pump pliers
Szcypce nastawne

251



Plumbing accessories
Akcesoria hydrauliczne

260-261



Step wrenches
Klucze sztorcowe

251-252



Deburrers & accessories
Gratowniki i akcesoria

261



Pipe cutters
Obcinaki do rur

253-256



Pipe brushes
Szczotki do rur

262



Pipe benders
Giętarki do rur

256-257



Cleaning pads for pipes
Włókniny do czyszczenia rur

262



Hand flaring tools sets
Praski do rozszerzania rur

257-258



Drain cleaning accessories
Akcesoria do udrażniania kanalizacji

262-263



- EN Ratchet die stocks
- PL Gwintownica z zestawem glowic
- DE Rohrgewindeschneidsatz
- RU Ключи трубные
- CZ Sada závitníků
- HU Menetfűrő készlet
- RO Set filiere cu clichet
- FR Kit de filetage de tuyau
- IT Kit per filettatura tubi
- ES Tarrajas para tubo
- CN 管子铰板组套



5 PCS	3/8" 9.5 mm	1/2" 12.7 mm	3/4" 19 mm
1" 25 mm		9Cr2	

YATO	Size / Rozmiar	
YT-29001	3/8" (9.5 mm), 1/2" (12.7 mm), 3/4" (19.0 mm), 1" (25.0 mm)	4

- EN Ratchet die stocks
- PL Gwintownica z zestawem glowic
- DE Rohrgewindeschneidsatz
- RU Ключи трубные
- CZ Sada závitníků
- HU Menetfűrő készlet
- RO Set filiere cu clichet
- FR Kit de filetage de tuyau
- IT Kit per filettatura tubi
- ES Tarrajas para tubo
- CN 管子铰板组套



7 PCS	1/4" 6.3 mm	3/8" 9.5 mm	1/2" 12.7 mm	3/4" 19 mm
1" 25 mm	1 1/4" 32 mm		9Cr2	

YATO	Size / Rozmiar	
YT-2900	1/4" (6.3 mm), 3/8" (9.5 mm), 1/2" (12.7 mm), 3/4" (19.0 mm), 1" (25.0 mm), 1-1/4" (32.0 mm)	4

- EN Ratchet die stocks
- PL Gwintownica z zestawem glowic
- DE Rohrgewindeschneidsatz
- RU Ключи трубные
- CZ Sada závitníků
- HU Menetfűrő készlet
- RO Set filiere cu clichet
- FR Kit de filetage de tuyau
- IT Kit per filettatura tubi
- ES Tarrajas para tubo
- CN 管子铰板组套



7 PCS	1/2" 12.7 mm	3/4" 19 mm	1" 25 mm	1 1/4" 32 mm
1.5" 38 mm	2" 50 mm		9Cr2	

YATO	Size / Rozmiar	
YT-29003	1/2" (12.7 mm), 3/4" (19.0 mm), 1" (25.0 mm), 1-1/4" (32.0 mm), 1-1/2" (38.0 mm), 2" (50.0 mm)	2

- EN Spare knives for ratchet die stock
- PL Noże zapasowe do gwintownicy ręcznej
- DE Rohrgewinde-Schneidbacken
- RU Запасные ножи для оправки
- CZ Náhradní nože do ruční závitořezu
- HU Tartalék kések, racsnis csőmenetvágóhoz
- RO Cuițe de rezervă pt. filieră
- FR Lame pour taraud à main
- IT Lama di ricambio per filettatrici manuale
- ES Filos de recambio para terraja de mano
- CN 板牙



4 PCS
9Cr2

- EN Spare head for ratchet die stock
- PL Glowica zapasowa do gwintownicy ręcznej
- DE Rohrgewinde-Schneidkörpe
- RU Запасная оправка для нарезания трубной резьбы
- CZ Náhradní hlava pro ruční závitořez
- HU Tartalék fej, racsnis csőmenetvágóhoz
- RO Cap rezervă pt. filieră
- FR Mandrin porte-taraud
- IT Testina ricambio per filettatrici manuale
- ES Cabeza de recambio para terraja de mano
- CN 板牙头



9Cr2

YATO	Size / Rozmiar	pcs / szt.	
YT-2910	1/4" (6.3 mm)	4	50/200
YT-2911	3/8" (10.0 mm)	4	50/200
YT-2912	1/2" (12.5 mm)	4	50/200
YT-2913	3/4" (19.0 mm)	4	50/200
YT-2914	1" (25.0 mm)	4	50/200

YATO	Size / Rozmiar	
YT-2916	1/4" (6.3 mm)	10/40
YT-2917	3/8" (10.0 mm)	10/40
YT-2918	1/2" (12.5 mm)	10/40
YT-2919	3/4" (19.0 mm)	10/40
YT-2920	1" (25.0 mm)	10/40
YT-2921	1-1/4" (32.0 mm)	10/20

EN Pipe wrench
PL Klucz do rur
DE Rohrschlüssel
RU Ключ трубный

CZ Klíč součásti na trubky
HU Csőkulcs
RO Cheie reglabila pt. tevi
FR Clé aux tubes

IT Chiave per tubi
ES Llave para tubos
CN 铝合金管钳

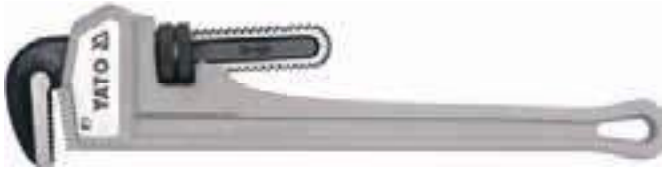

YATO	Size / Rozmiar	L [mm]	Max. pipe diameter / Maks. średnica rury	
YT-2482	14"	350	2" (50 mm)	6/12
YT-2483	18"	450	2.5" (63 mm)	2/10
YT-2484	24"	600	3" (75 mm)	2/6
YT-2485	36"	900	5" (125 mm)	3

EN Pipe wrench
PL Klucz do rur
DE Rohrschlüssel
RU Ключ трубный

CZ Klíč součásti na trubky
HU Csőkulcs
RO Cheie reglabila pt. tevi
FR Clé aux tubes

IT Chiave per tubi
ES Llave para tubos
CN 铝合金重型管钳



YATO	Size / Rozmiar	L [mm]	Max. pipe diameter / Maks. średnica rury	
YT-2222	12"	300	1" (25 mm)	6/24
YT-2223	14"	350	1.5" (38 mm)	4/16
YT-2224	18"	450	2" (50 mm)	3/12
YT-2225	24"	600	2.5" (63 mm)	3/6

EN Telescopic pipe wrench
PL Teleskopowy klucz do rur
DE Teleskop-Rohrschlüssel

RU Телескопический трубный гаечный ключ
CZ Teleskopický klíč do trubek
HU Teleszkópos csőfogó kulcs

RO Cheie pt. tevi telescopica
FR Clé télescopique pour tuyaux
IT Chiave giratubi telescopica



EN Adjustable pipe wrench
PL Klucz nastawny do rur
DE Rohrschlüssel

RU Ключ трубный переставной
CZ Nastavitelný klíč na trubky
HU Állítható csőkulcs

RO Cheie reglabila pt. tevi
FR Clé serre-tube „suédois”
IT Pinze regolabili per tubi

ES Llave para tubos
CN 管钳

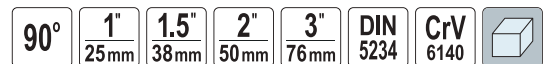

EN Pipe wrench
PL Klucz do rur
DE Rohrschlüssel
RU Ключ трубный

CZ Klíč součásti na trubky
HU Csőkulcs
RO Cheie reglabila pt. tevi
FR Clé aux tubes

IT Chiave per tubi
ES Llave para tubos
CN 加重型管钳



YATO	Size / Rozmiar	L [mm]	Max. pipe diameter / Maks. średnica rury	
YT-2488	10"	250	1" (25 mm)	6/18
YT-2489	12"	300	1.5" (38 mm)	6/12
YT-2490	14"	350	2" (50 mm)	2/10
YT-2491	18"	450	2.5" (63 mm)	3/6
YT-2492	24"	600	3" (75 mm)	2/4
YT-2493	36"	900	5" (125 mm)	1
YT-2494	48"	1200	6" (150 mm)	1

EN Pipe wrench
PL Klucz do rur
DE Rohrschlüssel
RU Ключ трубный

CZ Klíč součásti na trubky
HU Csőkulcs
RO Cheie reglabila pt. tevi
FR Clé aux tubes

IT Chiave per tubi
ES Llave para tubos
CN 偏置式重型管钳



YATO	Size / Rozmiar	L [mm]	Max. pipe diameter / Maks. średnica rury	
YT-2201	10"	250	1" (25 mm)	6/36
YT-2203	14"	350	1.5" (38 mm)	4/16
YT-2204	18"	450	2" (50 mm)	3/12
YT-2205	24"	600	2.5" (63 mm)	3/6
YT-2206	36"	900	4" (100 mm)	2/4

ES Llave telescópica para tubos
CN 管子钳



YATO	Size / Rozmiar	L [mm]	Max. pipe diameter / Maks. średnica rury [mm]	
YT-22257	16", 18", 20", 22"	400-550	80	8

YATO	L [mm]	Max. pipe diameter / Maks. średnica rury	
YT-2210	320	1" (25 mm)	24
YT-2211	420	1-1/2" (38 mm)	18
YT-2212	560	2" (50 mm)	12
YT-22123	630	3" (76 mm)	4

EN Adjustable pipe wrench
PL Klucz nastawny do rur
DE Rohrschlüssel

RU Ключ трубный переставной
CZ Nastavitelný klíč na trubky
HU Állítható csőkulcs

RO Cheie reglabilă pt. țevi
FR Clé serre-tube „suédois”
IT Pinze regolabili per tubi

ES Llave para tubos
CN 管钳

45° 1" 25mm 1.5" 38mm 2" 50mm 3" 76mm DIN 5234 CrV 6140



YATO	L [mm]	Max. pipe diameter / Maks. średnica rury	
YT-2213	330	1" (25 mm)	24
YT-2214	415	1-1/2" (38 mm)	18
YT-2215	530	2" (50 mm)	12
YT-22153	650	3" (76 mm)	4

EN Adjustable pipe wrench
PL Klucz nastawny do rur
DE Rohrschlüssel

RU Ключ трубный переставной
CZ Nastavitelný klíč na trubky
HU Állítható csőkulcs

RO Cheie reglabilă pt. țevi
FR Clé serre-tube „suédois”
IT Pinze regolabili per tubi

ES Llave para tubos
CN 弯嘴鹰嘴钳

S 1" 25mm 1.5" 38mm 2" 50mm 3" 76mm DIN 5234 CrV 6140



YATO	L [mm]	Max. pipe diameter / Maks. średnica rury	
YT-2216	330	1" (25 mm)	24
YT-2217	420	1-1/2" (38 mm)	18
YT-2218	535	2" (50 mm)	12
YT-22183	650	3" (76 mm)	4

EN Auto-adjustable pipe wrench
PL Szybkonastawny klucz do rur
DE Rollgabelschlüssel

RU Ключ разводной
CZ Nastavitelný klíč
HU Állítható svédkulcs

RO Cheie reglabilă
FR Clé à molette
IT Chiave autoregolabile per tubi

ES Llave ajustable
CN 可调式管钳

300mm 5/8"-11/2" 16-38mm SELF-ADJUSTING SAMO-NASTAWNY QUICK OPENING SZYBKIE OTWIERANIE HRC 46-52 HARDENED JAWS HARTOWANE SZCZĘKI



YATO	L [mm]	
YT-22005	300	6/24

EN Pipe wrench - german type
PL Klucz do rur - typ niemiecki
DE Rohrschlüssel - deutsch type
RU Трубный ключ - немецкий тип
CZ Nastavitelný klíč na trubky - němečina typ
HU Állítható csőkulcs - német típusú

RO Cheie reglabilă pt. țevi - tip german
FR Clé serre-tube type allemand
IT Chiave per tubi - tipo tedesco
ES Llave para tubos tipo alemán
CN 德式管子钳

HRC 47-53 HARDENED JAWS HARTOWANE SZCZĘKI



YATO	Size / Rozmiar	L [mm]	Max. jaws opening capacity / Maks. zakres rozwarcia szczęk [mm]	Max. pipe diameter / Maks. średnica rury [mm]	
YT-22000	7"	175	45	20	6/60
YT-22001	9"	225	60	30	6/36
YT-22002	10.5"	275	70	35	6/24

EN Strap for pipe wrench
PL Taśma zapasowa do klucza do rur
DE Gurt für Bandschlüssel
RU Ремень для ремешковых ключей
CZ Popruh pro klíče olejových filtrů
HU Szíjas az szíjas csőfogó

RO Bandă rezervă pt. cheie țevi
FR Courroie pour clés a courroie
IT Nastro di ricambio per chiave per tubi
ES Correa a llaves de correa
CN 皮带管钳配件

ø 8" 28x825mm 200mm NYLON AI



- Chromed pipes
- PVC pipes
- Oil filters
- Rury chromowane
- Rury PCV
- Filtry oleju

For YT-22255
Dla YT-22255

YATO	L [mm]	
YT-22256	100	

EN Telescopic pipe wrench
PL Teleskopowy klucz do rur
DE Teleskop-Rohrschlüssel
RU Телескопический трубный гаечный ключ
HU Teleszkópos csőfogó kulcs

RO Cheie bandă pt. țevi
FR Clé télescopique pour tuyaux
IT Chiave telescopica per tubi
ES Llave telescópica para tubos
CN 皮带管钳

ø 8" 300mm 28x825mm NYLON AI



YATO	L [mm]	Max. pipe diameter / Maks. średnica rury	
YT-22255	300	8" (200 mm)	5/50

EN Chain pipe wrench
PL Klucz łańcuchowy do rur
DE Kettenrohrzange
RU Ключ цепной для труб
CZ Klíč řetězový na trubky
HU Láncos csőfogó
RO Cheie reglabilă pt. țevi cu lanț
FR Clé à chaîne
IT Chiave a catena per tubi
ES Llave de cadena
CN 链条扳手

ø 4" 300mm 100mm INDUCTION HARDENED TEETH ZĘBY HARTOWANE INDUKCYJNIE ADJUSTABLE WORK RANGE REGULOWANY ZAKRES PRACY



YATO	L [mm]	Max. pipe diameter / Maks. średnica rury	
YT-22260	300	4" (100 mm)	6/24

EN Water pump pliers
PL Szczypce nastawne
DE Wasserpumpenzange
RU Клещи переставные
CZ Nastavitelné kleště
HU Állítható fogó

RO Cleste papagal
FR Pince réglable
IT Pinze regolabili
ES Tenaza ajustable
CN 水泵钳

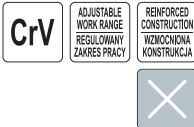

YATO	L [mm]	
YT-2090	250	6/36
YT-2091	300	6/36

EN Water pump pliers
PL Szczypce nastawne
DE Wasserpumpenzange
RU Клещи переставные
CZ Nastavitelné kleště
HU Állítható fogó

RO Cleste papagal
FR Pince réglable
IT Pinze regolabili
ES Tenaza ajustable
CN 水泵钳



YATO	L [mm]	
YT-2069	250	6/36

EN Water pump pliers
PL Szczypce nastawne
DE Wasserpumpenzange
RU Клещи переставные
CZ Nastavitelné kleště
HU Állítható fogó

RO Cleste papagal
FR Pince réglable
IT Pinze regolabili
ES Tenaza ajustable
CN 水泵钳



YATO	Jaws width / Szerokość szczęk [mm]	L [mm]	
YT-20890	30	175	6/72
YT-20891	38	240	6/60
YT-20892	50	300	6/36
YT-20893	95	415	6/24

EN Step wrench
PL Klucz stopniowy
DE Stufenschlüssel
RU Универсальный ступенчатый ключ
CZ Klič na radiátorové šroubení
HU Lépcsős radiátor kulcs

RO Cheie in trepte pt. radiator
FR Clé de montage étagée
IT Chiave gradini per radiatori
ES Llave de radiadores
CN 六角阶梯扳手



For YT-03315
Dia YT-03315



YATO	Ø	
YT-03316	1/2" (12.7 mm)	100

EN Water pump pliers
PL Szczypce nastawne
DE Wasserpumpenzange
RU Клещи переставные
HU Állítható fogó

RO Cleste papagal
FR Pince réglable
IT Pinze regolabili
ES Tenaza ajustable
CN 水泵钳

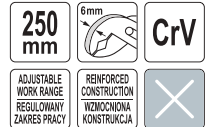

YATO	L [mm]	
YT-20911	250	6/36

EN Water pump pliers
PL Szczypce nastawne
DE Wasserpumpenzange
RU Клещи переставные
CZ Nastavitelné kleště
HU Állítható fogó

RO Cleste papagal
FR Pince réglable
IT Pinze regolabili
ES Tenaza ajustable
CN 水泵钳



YATO	L [mm]	
YT-2070	250	6/24

EN Internal ratchet wrench
PL Grzechotka wewnętrzna
DE Innenratschenschlüssel
RU Трещотка внутренняя
CZ Radiátorový kluč s ráčnou
HU Lépcsős kulcskészlet racsnival

RO Cheie robinet radiator
FR Clé de montage étagée
IT Cricchetto di tipo interno
ES Llave carraca radiadores
CN 穿心棘轮扳手



For YT-03316
Dia YT-03316

YATO	Ø	
YT-03315	1/2" (12.7 mm)	6/24

EN Step wrench with ratchet
PL Klucz stopniowy z grzechotką
DE Stufenschlüssel mit Ratsche
RU Ключ ступенчатый с трещоткой
CZ Klič na šroubení s ráčnou
HU Racsnis lépcsős kulcs

RO Cheie in trepte cu clichet
FR Clé de montage étagée avec cliquet
IT Chiave gradini per radiatori con cricchetto
ES Llave de radiadores con trinquete
CN 穿心棘轮扳手



□ □ □ 3/8" (9.5 mm), 29/68" (11.6 mm), 1/2" (12.7 mm), 21/32" (16.4 mm), 27/32" (21 mm)

YATO	Ø	
YT-03314	1/2" (12.7 mm)	6/24

EN Step wrench
 PL Klucz stopniowy
 DE Stufenschlüssel
 RU Универсальный ступенчатый ключ
 CZ Klíč na radiátorové šroubení
 HU Lépcsős radiátor kulcs

RO Cheie in trepte pt. radiator
 FR Clé de montage étagée
 IT Chiave gradini per radiatori
 ES Llave de radiadores
 CN 六角阶梯扳手



For YT-03315
 Dla YT-03315

YATO		
YT-03317	1/2" (12.7 mm)	100

EN Hole cutter for water taps
 PL Wycinak otworów pod kran
 DE Lochschneider für Wasserhähne
 RU Устройство для вырезания отверстий под смеситель
 CZ Vykružovač otvorů pro vodovodní baterii
 HU Csavaros lyukkvívógó
 RO Dispozitiv pt. perforat tabla
 FR Outil de coupe de trou pour robinets
 IT Punzonatrice a vite per rubinetti
 ES Cortador de agujeros para grifos
 CN 切孔器



YATO		Ø [mm]	
YT-21955		25	5/30
YT-21956		32	5/30
YT-21957		35	5/30

EN Special mixer-tap basin wrench
 PL Klucz lamany do instalacji armatury
 DE Standhahnmutterschlüssel für Armaturen
 RU Сгибающийся гаечный ключ для фитингов
 CZ Lámaný klíč na vodovodní baterie
 HU Derékszögű csaptelep kulcs
 RO Chei speciale pt. baterii sanitare
 FR Clé écrou robinet
 IT Chiave pieghevole per dadi e rubinetti
 ES Llave articulada para plomería
 CN 水槽扳手



9, 10, 11, 12, 14, 17 mm

YATO		
YT-24781		10/20

EN Sink wrench
 PL Teleskopowy klucz hakowy do armatury
 DE Teleskop-Hakenschlüssel für Armaturen
 RU Ключ для раковины телескопический
 CZ Teleskopický šmuvadlový klíč
 HU Teleszkópos csaptelepkulcs
 RO Cheie reglabilă pt. obiecte sanitare
 FR Clé à siphon télescopique
 IT Chiave telescopica per lavabo
 ES Llave para lavabo telescópica
 CN 水槽扳手

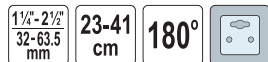

YATO		
YT-22251		6/12

EN Step wrench
 PL Klucz stopniowy
 DE Stufenschlüssel
 RU Универсальный ступенчатый ключ
 CZ Klíč na radiátorové šroubení
 HU Lépcsős radiátor kulcs
 RO Cheie in trepte pt. radiator
 FR Clé de montage étagée
 IT Chiave a cricco
 ES Llave de radiadores
 CN 六角阶梯扳手



YATO		
YT-03318		10/60

EN Special mixer-tap basin wrench
 PL Klucz lamany do instalacji armatury
 DE Standhahnmutterschlüssel für Armaturen
 RU Сгибающийся гаечный ключ для фитингов
 CZ Lámaný klíč na vodovodní baterie
 HU Derékszögű csaptelep kulcs
 RO Chei speciale pt. baterii sanitare
 FR Clé écrou robinet
 IT Chiave pieghevole per dadi e rubinetti
 ES Llave articulada para plomería
 CN 水槽扳手



8, 9, 10, 11, 12 mm

YATO		
YT-24780		20/40

EN Faucet reseating tool
 PL Frez do napraw kranów
 DE Wasserhahn-Ventil-Sitzfraeser
 RU Фреза для ремонта седла клапанов смесителей
 CZ Fréza na sedla vodovodních baterii
 HU Szelepfészekmaró
 RO Freză rectificat baterie sanitare
 FR Appareil à fraiser pour réparer les robinets
 IT Fresa per rubinetti
 ES Fresa para reparación de grifos
 CN 水阀修理器



YATO		
YT-21960		5/50

EN Nipple extractor set
 PL Zestaw do wykręcania nypki
 DE Nippelschlüsseln-Satz
 RU Набор для выкручивания ниппелей
 CZ Souprava pro vyšroubování vodovodních redukcí
 HU Belső csőkulcs
 RO Set de chei interne pt. țevi și fittinguri
 FR Jeu de porte-embouts pour dévisser mamelons
 IT Set di chavi per rimozione nippi
 ES Juego extractor de nipples
 CN 内管扳手

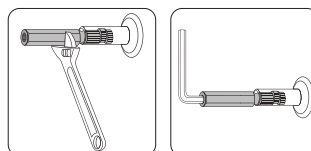
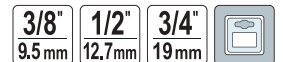

YATO		
YT-21793		6/24

EN PVC pipe cutter
PL Obcinak do rur PVC
DE PVC Rohrabscneider
RU Труборез для ПВХ труб
CZ Rezač PVC trubek
HU Csővágó olló PVC csővekhez

RO Foarfecă pt. tăiat țevi din PVC
FR Coupe-tube en PVC
IT Cesovia per tubi in PVC
ES Tijera cortatubos para PVC
CN PVC管子割刀



max Ø 35 mm
PEX
PVC PP PU PE
HRC 54
8Cr13

YATO	max. Ø [mm]	
YT-2230	35	6/48

EN PVC pipe cutter
PL Obcinak do rur PVC
DE PVC Rohrabscneider
RU Труборез для ПВХ труб
CZ Rezač PVC trubek
HU Csővágó olló PVC csővekhez
RO Foarfecă pt. tăiat țevi din PVC
FR Coupe-tube en PVC
IT Cesovia per tubi in PVC
ES Tijera cortatubos para PVC
CN PVC管子割刀

max Ø 42 mm
PEX
PVC PP PU PE
HRC 54
8Cr13
RATCHET SYSTEM SYSTEM ZAPADKOWY
QUICK OPENING SZYBKE OTWIERANIE



YATO	max. Ø [mm]	
YT-2231	42	6/48

EN PVC pipe cutter
PL Obcinak do rur PVC
DE PVC Rohrabscneider
RU Труборез для ПВХ труб
CZ Rezač PVC trubek
HU Csővágó olló PVC csővekhez
RO Foarfecă pt. tăiat țevi din PVC
FR Coupe-tube en PVC
IT Cesovia per tubi in PVC
ES Tijera cortatubos para PVC
CN PVC管子割刀

max Ø 63 mm
PEX
PVC PP PU PE
HRC 56-58
8Cr13
RATCHET SYSTEM SYSTEM ZAPADKOWY
QUICK OPENING SZYBKE OTWIERANIE



YATO	max. Ø [mm]	
YT-22312	63	6/24

EN PVC pipe cutter
PL Obcinak do rur PVC
DE PVC Rohrabscneider
RU Труборез для ПВХ труб
CZ Rezač PVC trubek
HU Csővágó olló PVC csővekhez
RO Foarfecă pt. tăiat țevi din PVC
FR Coupe-tube en PVC
IT Cesovia per tubi in PVC
ES Tijera cortatubos para PVC
CN PVC管子割刀

PEX
PVC PP PU PE
HRC 54
8Cr13
AI
RATCHET SYSTEM SYSTEM ZAPADKOWY
QUICK OPENING SZYBKE OTWIERANIE



max Ø 51 mm

YATO	max. Ø [mm]	
YT-2228	51	6/24



max Ø 64 mm

YATO	max. Ø [mm]	
YT-2229	64	6/24

EN PVC pipe cutter
PL Obcinak do rur PVC
DE PVC Rohrabscneider
RU Труборез для ПВХ труб
CZ Rezač PVC trubek
HU Csővágó olló PVC csővekhez
RO Foarfecă pt. tăiat țevi din PVC
FR Coupe-tube en PVC
IT Cesovia per tubi in PVC
ES Tijera cortatubos para PVC
CN PVC管子割刀

PVC PP PU PE
PTFE
SK5
AI



max Ø 36 mm

YATO	max. Ø [mm]	
YT-22270	36	10/50



max Ø 42 mm

YATO	max. Ø [mm]	
YT-22271	42	10/40



max Ø 50 mm

YATO	max. Ø [mm]	
YT-22272	50	10/30



max Ø 63 mm

YATO	max. Ø [mm]	
YT-22273	63	10/30



max Ø 75 mm

YATO	max. Ø [mm]	
YT-22274	75	10/30

EN PE pipe cutter
 PL Obcinak do rur PE
 DE PE Rohrabsschneider
 RU Труборез для ПЭ труб
 CZ Rezač PE trubek
 HU Csővágó olló PE csővekhez
 RO Foarfecă pt. tăiat țevi din PE
 FR Coupe-tube en PE
 IT Cesovia per tubi in PE
 ES Tijera cortatubos para PE
 CN 管子割刀

max Ø **64 mm** PVC PP PU PE PTFE SK5 AI



YATO	max. Ø [mm]	
YT-22295	64	6/24

EN PVC pipe cutter
 PL Obcinak do rur PVC
 DE PVC Rohrabsschneider
 RU Труборез для ПВХ труб
 CZ Rezač PVC trubek
 HU Csővágó olló PVC csővekhez

RO Foarfecă pt. tăiat țevi din PVC
 FR Coupe-tube en PVC
 IT Cesovia per tubi in PVC
 ES Tijera cortatubos para PVC
 CN PVC管子割刀

Ø **32 mm** PVC PP PU PE SK5 AI



YATO	max. Ø [mm]	
YT-22301	32	12/120

EN PVC pipe cutter
 PL Obcinak do rur PVC
 DE PVC Rohrabsschneider
 RU Труборез для ПВХ труб
 CZ Rezač PVC trubek
 HU Csővágó olló PVC csővekhez
 RO Foarfecă pt. tăiat țevi din PVC
 FR Coupe-tube en PVC
 IT Cesovia per tubi in PVC
 ES Tijera cortatubos para PVC
 CN PVC管子割刀

max Ø **42 mm** PVC PP PU PE HRC 54 8Cr13 AI



YATO	max. Ø [mm]	
YT-22292	42	6/48

EN PVC pipe cutter
 PL Obcinak do rur PVC
 DE PVC Rohrabsschneider
 RU Труборез для ПВХ труб
 CZ Rezač PVC trubek
 HU Csővágó olló PVC csővekhez
 RO Foarfecă pt. tăiat țevi din PVC
 FR Coupe-tube en PVC
 IT Cesovia per tubi in PVC
 ES Tijera cortatubos para PVC
 CN PVC管子割刀

max Ø **64 mm** PVC PP PU PE HRC 54 8Cr13 AI



YATO	max. Ø [mm]	
YT-22293	64	6/24

EN Pipe deburrer
 PL Gratownik do rur
 DE Rohrentgrater
 RU Гратосниматель для труб
 CZ Odhrotovač trubek
 HU Sorjázó
 RO Debavurure pt. tevi
 FR Ébavureur de tuyaux
 IT Sbastatore per tubi
 ES Desbarbador de tubos
 CN 修边器

PE 20-63 mm HCS 65Mn



YATO	Ø [mm]	
YT-22366	20, 25, 32, 40, 50, 63	150

EN Pipe cutter
 PL Obcinak do rur
 DE Rohrabsschneider
 RU Труборез для труб
 CZ Rezač trubek
 HU Csővágó
 RO Dispozitiv pt. tăiat țevi
 FR Coupe-tube
 IT Tagliatubi
 ES Cortatubos
 CN 管子割刀

PEX PVC PP PU PE AI Cu BEARING STEEL STAL ŁOŻYSKOWA

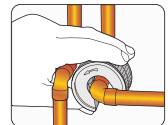

YATO	Cutting diameter / Średnica cięcia	External diameter / Średnica zewnętrzna [mm]	
YT-22353	19/32" (15 mm)	48	10/50
YT-22354	23/32" (18 mm)	59	10/50
YT-22355	7/8" (22 mm)	56	10/50

EN Pipe cutter
 PL Obcinak do rur
 DE Rohrabsschneider
 RU Труборез для труб
 CZ Rezač trubek
 HU Csővágó
 RO Dispozitiv pt. tăiat țevi
 FR Coupe-tube
 IT Tagliatubi
 ES Cortatubos
 CN 管子割刀

PEX PVC PP PU PE AI Cu 1/10"-7/8" 3-22 mm BEARING STEEL STAL ŁOŻYSKOWA



YATO	Cutting diameter / Średnica cięcia	
YT-22318	1/10" - 7/8" (3-22 mm)	100

EN Pipe cutter
 PL Obcinak do rur
 DE Rohrabsschneider
 RU Труборез для труб
 CZ Rezač trubek
 HU Csővágó
 RO Dispozitiv pt. tăiat țevi
 FR Coupe-tube
 IT Tagliatubi
 ES Cortatubos
 CN 管子割刀

PVC PP PU PE SS AI Cu 3-28 mm QUICK ADJUSTMENT SZYBKĄ REGULACJĄ HRC 56-62 9CrSi



YATO	Cutting diameter / Średnica cięcia [mm]	
YT-22341	3-28	10/60

EN Pipe cutter
PL Obcinak do rur
DE Rohrabsschneider
RU Труборез для труб
CZ Rezač trubek
HU Csővágó
RO Dispozitiv pt. tăiat țevi
FR Coupe-tube
IT Tagliatubi
ES Cortatubos
CN 管子割刀



<input type="checkbox"/> PVC PP PU PE SS Al Cu	<input type="checkbox"/> 3-28 mm	<input type="checkbox"/> QUICK ADJUSTMENT SZYBKA REGULACJA	<input type="checkbox"/> DEBURRER GRATOWNIK	<input type="checkbox"/> HRC 56-62	<input type="checkbox"/> 9CrSi	<input type="checkbox"/>
--	-------------------------------------	---	--	---------------------------------------	--------------------------------	--------------------------

YATO	Cutting diameter / Średnica cięcia [mm]	<input type="checkbox"/>
YT-22342	3-28	6/48

EN Pipe cutter
PL Obcinak do rur
DE Rohrabsschneider
RU Труборез для труб
CZ Rezač trubek
HU Csővágó
RO Dispozitiv pt. tăiat țevi
FR Coupe-tube
IT Tagliatubi
ES Cortatubos
CN 管子割刀



<input type="checkbox"/> PEX	<input type="checkbox"/> PVC PP PU PE SS Al Cu	<input type="checkbox"/> 3/8"-1 5/8" 10-40 mm	<input type="checkbox"/> BEARING STEEL STAL ŁOŻYSKOWA	<input type="checkbox"/>
------------------------------	--	--	--	--------------------------

YATO	Cutting diameter / Średnica cięcia	<input type="checkbox"/>
YT-2232	3/8" - 1-5/8" (10-40 mm)	20

EN Pipe cutter
PL Obcinak do rur
DE Rohrabsschneider
RU Труборез для труб
CZ Rezač trubek
HU Csővágó
RO Dispozitiv pt. tăiat țevi
FR Coupe-tube
IT Tagliatubi
ES Cortatubos
CN 管子割刀



<input type="checkbox"/> PVC PP PU PE SS Al Cu	<input type="checkbox"/> 16-54 mm	<input type="checkbox"/> QUICK ADJUSTMENT SZYBKA REGULACJA	<input type="checkbox"/> DEBURRER GRATOWNIK	<input type="checkbox"/> HRC 56-62	<input type="checkbox"/> 9CrSi	<input type="checkbox"/>
--	--------------------------------------	---	--	---------------------------------------	--------------------------------	--------------------------

YATO	Cutting diameter / Średnica cięcia [mm]	<input type="checkbox"/>
YT-22344	16-54	4/16

EN Pipe cutter
PL Obcinak do rur
DE Rohrabsschneider
RU Труборез для труб
CZ Rezač trubek
HU Csővágó
RO Dispozitiv pt. tăiat țevi
FR Coupe-tube
IT Tagliatubi
ES Cortatubos
CN 管子割刀



<input type="checkbox"/> PEX	<input type="checkbox"/> PVC PP PU PE Al Cu	<input type="checkbox"/> 2"-5" 50-127 mm	<input type="checkbox"/> QUICK ADJUSTMENT SZYBKA REGULACJA	<input type="checkbox"/> BEARING STEEL STAL ŁOŻYSKOWA	<input type="checkbox"/>
------------------------------	---	---	---	--	--------------------------

YATO	Cutting diameter / Średnica cięcia	<input type="checkbox"/>
YT-2235	2" - 5" (50-127 mm)	10

EN Pipe cutter
PL Obcinak do rur
DE Rohrabsschneider
RU Труборез для труб
CZ Rezač trubek
HU Csővágó
RO Dispozitiv pt. tăiat țevi
FR Coupe-tube
IT Tagliatubi
ES Cortatubos
CN 管子割刀



<input type="checkbox"/> PVC PP PU PE Al Cu	<input type="checkbox"/> 3-42 mm	<input type="checkbox"/> DEBURRER GRATOWNIK	<input type="checkbox"/> GCr15	<input type="checkbox"/> SPARE CUTTING WHEEL ZAPASOWE KÓŁKO TNAĆE	<input type="checkbox"/>
---	-------------------------------------	--	--------------------------------	--	--------------------------

YATO	Cutting diameter / Średnica cięcia [mm]	<input type="checkbox"/>
YT-22333	3-42	4/32

EN Pipe cutter
PL Obcinak do rur
DE Rohrabsschneider
RU Труборез для труб
CZ Rezač trubek
HU Csővágó
RO Dispozitiv pt. tăiat țevi
FR Coupe-tube
IT Tagliatubi
ES Cortatubos
CN 管子割刀



<input type="checkbox"/> PEX	<input type="checkbox"/> PVC PP PU PE Al Cu	<input type="checkbox"/> 1/10"-5/4" 3-32 mm	<input type="checkbox"/> QUICK ADJUSTMENT SZYBKA REGULACJA	<input type="checkbox"/> DEBURRER GRATOWNIK	<input type="checkbox"/> BEARING STEEL STAL ŁOŻYSKOWA	<input type="checkbox"/> SPARE CUTTING WHEEL ZAPASOWE KÓŁKO TNAĆE	<input type="checkbox"/>
------------------------------	---	--	---	--	--	--	--------------------------

YATO	Cutting diameter / Średnica cięcia	<input type="checkbox"/>
YT-22338	1/10" - 1-1/4" (3-32 mm)	50

EN Pipe cutter
PL Obcinak do rur
DE Rohrabsschneider
RU Труборез для труб
CZ Rezač trubek
HU Csővágó
RO Dispozitiv pt. tăiat țevi
FR Coupe-tube
IT Tagliatubi
ES Cortatubos
CN 管子割刀



<input type="checkbox"/> PEX	<input type="checkbox"/> PVC PP PU PE Al Cu	<input type="checkbox"/> 1/4"-7/4" 6-45 mm	<input type="checkbox"/> DEBURRER GRATOWNIK	<input type="checkbox"/> BEARING STEEL STAL ŁOŻYSKOWA	<input type="checkbox"/> SPARE CUTTING WHEEL ZAPASOWE KÓŁKO TNAĆE	<input type="checkbox"/>
------------------------------	---	---	--	--	--	--------------------------

YATO	Cutting diameter / Średnica cięcia	<input type="checkbox"/>
YT-2233	1/4" - 1-3/4" (6-45 mm)	25

EN Pipe cutter
PL Obcinak do rur
DE Rohrabsschneider
RU Труборез для труб
CZ Rezač trubek
HU Csővágó
RO Dispozitiv pt. tăiat țevi
FR Coupe-tube
IT Tagliatubi
ES Cortatubos
CN 管子割刀



<input type="checkbox"/> PEX	<input type="checkbox"/> PVC PP PU PE Al Cu	<input type="checkbox"/> 1/2"-5/2" 14-63 mm	<input type="checkbox"/> QUICK ADJUSTMENT SZYBKA REGULACJA	<input type="checkbox"/> BEARING STEEL STAL ŁOŻYSKOWA	<input type="checkbox"/> SPARE CUTTING WHEEL ZAPASOWE KÓŁKO TNAĆE	<input type="checkbox"/>
------------------------------	---	--	---	--	--	--------------------------

YATO	Cutting diameter / Średnica cięcia	<input type="checkbox"/>
YT-2234	1/2" - 2-1/2" (14-63 mm)	25

EN Pipe cutter
PL Obcinak do rur
DE Rohrabsschneider
RU Труборез для труб
CZ Rezač trubek
HU Csővágó
RO Dispozitiv pt. tăiat țevi
FR Coupe-tube
IT Tagliatubi
ES Cortatubos
CN 管子割刀



<input type="checkbox"/> PVC PP PU PE Al Cu	<input type="checkbox"/> 6-35 mm	<input type="checkbox"/> DEBURRER GRATOWNIK	<input type="checkbox"/> GCr15	<input type="checkbox"/> SPARE CUTTING WHEEL ZAPASOWE KÓŁKO TNAĆE	<input type="checkbox"/>
---	-------------------------------------	--	--------------------------------	--	--------------------------

YATO	Cutting diameter / Średnica cięcia [mm]	<input type="checkbox"/>
YT-22332	6-35	5/50

EN Replacement cutting wheel for pipe cutters
 PL Zapasowe kółko tnące do obcinaka do rur
 DE Ersatzschneidrad für Rohrschneider
 RU Запасной режущий диск для труборезов
 CZ Náhradní řezné kolečko na trubky frézy
 HU Tartalék vágókerék cső vágó
 RO Rolă de schimb pt. dispozitiv tăiere țevi
 FR Molette pour coupe
 IT Ruota di ricambio per tagliatubi
 ES Rueda de corte de repuesto para cortatubos
 CN 管子割刀刀片

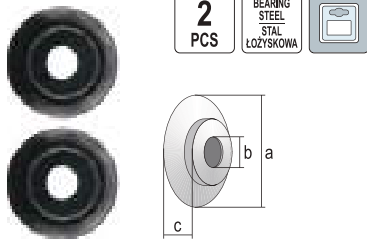

2 PCS BEARING STEEL STAL ŁOŻYSKOWA

EN Replacement cutting wheel or pipe cutters
 PL Zapasowe kółko tnące do obcinaka do rur
 DE Ersatzschneidrad für Rohrschneider
 RU Запасной режущий диск для труборезов
 CZ Náhradní řezné kolečko na trubky frézy
 HU Tartalék vágókerék cső vágó
 RO Rolă de schimb pt. dispozitiv tăiere țevi
 FR Molette pour coupe
 IT Ruota di ricambio per tagliatubi
 ES Rueda de corte de repuesto para cortatubos
 CN 管子割刀刀片

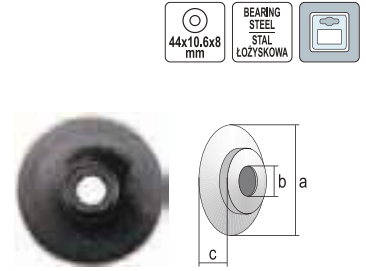

44x10.6x8 mm BEARING STEEL STAL ŁOŻYSKOWA

YATO	a [mm]	b [mm]	c [mm]	For / Dla	
YT-22313	18	6.0	4.8	YT-2233	50/300
YT-22314	26	14.0	7.5	YT-2232	6/108
YT-22315	18	6.0	4.8	YT-22338	50/300
YT-22316	27	6.3	5.0	YT-2234	24/288

YATO	a [mm]	b [mm]	c [mm]	For / Dla	
YT-22317	44	10.6	8	YT-2235	12/144

EN Replacement cutting wheel for pipe cutters
 PL Zapasowe kółko tnące do obcinaka do rur
 DE Ersatzschneidrad für Rohrschneider
 RU Запасной режущий диск для труборезов
 CZ Náhradní řezné kolečko na trubky frézy
 HU Tartalék vágókerék cső vágó
 RO Rolă de schimb pt. dispozitiv tăiere țevi
 FR Molette de rechange pour coupe-tube
 IT Ruota di ricambio per tagliatubi
 ES Rueda de corte de repuesto para cortatubos
 CN 管子割刀刀片

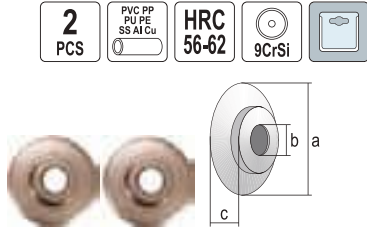

2 PCS PVC PP PU PE SS Al Cu HRC 56-62 9CrSi

EN Replacement cutting wheel for pipe cutters
 PL Zapasowe kółko tnące do obcinaka do rur
 DE Ersatzschneidrad für Rohrschneider
 RU Запасной режущий диск для труборезов
 CZ Náhradní řezné kolečko na trubky frézy
 HU Tartalék vágókerék cső vágó
 RO Rolă de schimb pt. dispozitiv tăiere țevi
 FR Molette de rechange pour coupe-tube
 IT Ruota di ricambio per tagliatubi
 ES Rueda de corte de repuesto para cortatubos
 CN 管子割刀刀片

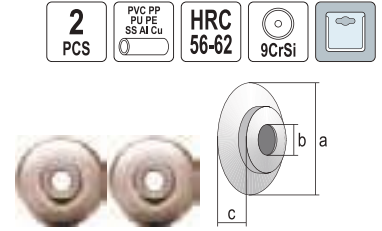

2 PCS PVC PP PU PE SS Al Cu HRC 56-62 9CrSi

YATO	a [mm]	b [mm]	c [mm]	For / Dla	
YT-22343	18.5	6	4.8	YT-22341, YT-22342	24/144

YATO	a [mm]	b [mm]	c [mm]	For / Dla	
YT-22345	21.5	6	4.9	YT-22344	24/144

EN Standard two handed bender
 PL Giętarka do rur
 DE Standard-Zweihand-Bieger
 RU Стандартный двуручный трубогиб
 CZ Dvouruční ohývačka cu trubek
 HU Kétkezes hajlító
 RO Dispozitiv de indoit teava
 FR Cintreuse à tubes manuelle
 IT Curvatubi manuale
 ES Curvadora de tubo manual
 CN 弯管器

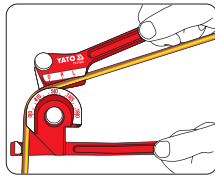

180° 1/4" 6.3mm
 5/16" 3/8" 8mm 9.5mm



YATO	Pipe diameter / Średnica rury	
YT-21840	1/4" (6.3 mm), 5/16" (8 mm), 3/8" (10 mm)	20

EN Standard two handed bender
 PL Giętarka do rur
 DE Standard-Zweihand-Bieger
 RU Стандартный двуручный трубогиб
 CZ Dvouruční ohývačka cu trubek
 HU Kétkezes hajlító
 RO Dispozitiv de indoit teava
 FR Cintreuse à tubes manuelle
 IT Curvatubi manuale
 ES Curvadora de tubo manual
 CN 弯管器

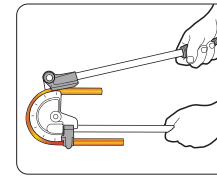

180° Al Cu SOFT STEEL BRASS WENKA STAL / MIEDŹ



YATO	Pipe diameter / Średnica rury	
YT-21842	15/32" (12 mm)	20
YT-21844	9/32" (15 mm)	10
YT-21845	5/8" (16 mm)	10
YT-21846	23/32" (18 mm)	10

EN Pipe bender set
 PL Giętarka do rur
 DE Rohrbiegeset
 RU Трубогиб ручной механический
 CZ Ruční ohývačka trubek
 HU Csőhajlító
 RO Set de indoit țevi
 FR Cintreuse de tuyaux
 IT Curvatubi manuale
 ES Dobladora de tubos
 CN 弯管器



6-22 mm

Ø 6, 8, 10, 12, 16, 19, 22 mm

YATO	Pipe diameter / Średnica rury [mm]	
YT-21847	6, 8, 10, 12, 16, 19, 22	4

EN Internal pipe bending spring
PL Sprężyna wewnętrzna do gięcia rur
DE Innen-Rohrbiegefeder
RU Пружина внутренняя для изгиба металлопластиковых труб

CZ Pružina pro ohýbání trubek vnitřní
HU Belső cső hajlító rugó
RO Arc indoire pt. tevi flexibilă
FR Ressort à cintrer intérieur

IT Molla piegatubi interna
ES Muelle curvavubos interior
CN 弹簧弯管器

760 mm

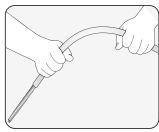

YATO	Pipe internal diameter / Wewnętrzna średnica rury [mm]	
YT-21850	16	25
YT-21851	20	25
YT-21852	25-26	25

EN External pipe bending spring
PL Sprężyna zewnętrzna do gięcia rur
DE Außen-Rohrbiegefeder
RU Пружина наружная для изгиба труб

CZ Pružina pro ohýbání trubek vnější
HU Csőhajlító rugó külső
RO Arc exterior de indoire a țevii
FR Ressort à cintrer extérieur pour tube

IT Molla piegatubi esterna
ES Muelle curvavubos exterior
CN 弯管弹簧

600 mm



YATO	Pipe external diameter / Zewnętrzna średnica rury [mm]	
YT-21855	16	40
YT-21856	20	40
YT-21857	25-26	20

EN Line set for bending pipes
PL Zestaw prętów do gięcia rur
DE Rohrbiegestab-Set
RU Набор стержней для гибки труб
CZ Sada tyčí pro ohýbání trubek
HU Csőhajlító rúdcsészlet
RO Set dispozitive pt. îndoirea țevilor
FR Jeu de tiges à cintrer pour courber tubes
IT Set di aste per piegatura tubi
ES Kit doblatubos
CN 塑胶棒

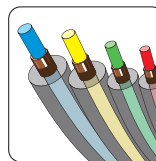
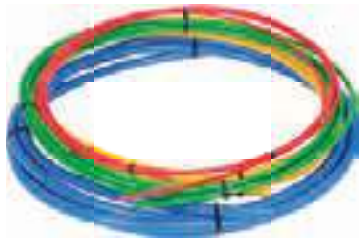

4 PCS	4m	4.0 mm	6.0 mm
9.0 mm	12 mm	PE	

YATO	Pipe diameter / Średnica rury	
YT-21860	1/4", 3/8", 1/2", 5/8"	10

EN Tube flaring tool
PL Kielicharka do ręcznego rozszerzania rur
DE Handpresse zum Aufweiten von Rohren
RU Пресс для ручного расширения труб
CZ Přípravek na ruční rozšiřování konců trubek
HU Kézi csőtágító készlet
RO Presă manuală pt. manșonarea țevilor
FR Set pour étendre les tubes
IT Attrezzi per svasatura di tubi
ES Abocinador manual para tubos
CN 扩孔器组套

22-28 mm

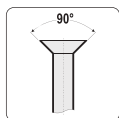

YATO	Pipe diameter / Średnica rury [mm]	
YT-2182	22, 25, 28	20

EN Tube flaring tool
PL Kielicharka do ręcznego rozszerzania rur
DE Handpresse zum Aufweiten von Rohren
RU Пресс для ручного расширения труб
CZ Přípravek na ruční rozšiřování konců trubek
HU Kézi csőtágító készlet
RO Presă manuală pt. manșonarea țevilor
FR Set pour étendre les tubes
IT Attrezzi per svasatura di tubi
ES Abocinador manual para tubos
CN 扩孔器组套

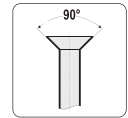

7 PCS

3-19 mm



YATO	Pipe diameter / Średnica rury [mm]	
YT-2180	3, 5, 6, 8, 10, 12, 14, 15, 16, 19	10

EN Tube flaring tool
PL Kielicharka do ręcznego rozszerzania rur
DE Handpresse zum Aufweiten von Rohren
RU Пресс для ручного расширения труб
CZ Přípravek na ruční rozšiřování konců trubek
HU Kézi csőtágító készlet
RO Presă manuală pt. manșonarea țevilor
FR Set pour étendre les tubes
IT Attrezzi per svasatura di tubi
ES Abocinador manual para tubos
CN 扩孔器组套

5-19 mm

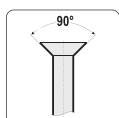

Ø 5, 6, 8, 10, 12, 16, 19 mm

YATO	Pipe diameter / Średnica rury [mm]	
YT-21802	5, 6, 8, 10, 12, 16, 19	10

EN Manual tube expander
PL Ekspander ręczny do rur
DE Manueller Rohrexpander
RU Расширитель-эспандер для труб
CZ Ruční expandér na trubky
HU Kézi csőtágító
RO Dispozitiv manual pt. expandat țevi
FR Extenseur de tube manuel
IT Espansore manuale per tubi
ES Expansor manual de tubos
CN 扩孔器

1/4"	5/16"	3/8"	1/2"
6.3mm	8mm	9.5mm	12.7mm
5/8"	3/4"	7/8"	
15.9mm	19mm	22.2mm	



YATO	Pipe diameter / Średnica rury	
YT-21805	1/4" (6.3 mm), 5/16" (8 mm), 3/8" (9.5 mm), 1/2" (12.7 mm), 5/8" (15.9 mm), 3/4" (19.0 mm), 7/8" (22.2 mm)	10/40

EN Lever tube expander
 PL Ekspander ręczny do rur
 DE Manuelle Rohraufweiter
 RU Расширитель-эспандер для труб
 CZ Ruční expandér na trubky
 HU Kézi csőtágító

RO Dispozitiv pt. expandat țevi
 FR Extenseur de tube à levier
 IT Espansore manuale per tubi
 ES Expansor manual de tubos
 CN 杠杆式胀管器

∅3/8"	∅1/2"
9.5 mm	12.7 mm
∅5/8"	∅3/4"
16 mm	19 mm
∅7/8"	∅1"
22.2 mm	25 mm
∅1 1/8"	
28.6 mm	



YATO	Pipe diameter / Średnica rury	
YT-21825	3/8" (9.5 mm), 1/2" (12.7 mm), 5/8" (15.9 mm), 3/4" (19.0 mm), 7/8" (22.2 mm), 1" (25.4 mm), 1-1/8" (28.6 mm)	4

EN Hydraulic tube expander
 PL Ekspander hydrauliczny do rur
 DE Hydraulischer Rohrexpander
 RU Ручной гидравлический расширитель труб
 CZ Hydraulický expandér trubek
 HU Hidraulikus csőtágító

RO Dispozitiv hidraulic pt. expandat țevi
 FR Extenseur de tube hydraulique
 IT Espansore idraulico per tubi
 ES Expansor hidráulico de tubos
 CN 液压胀管器

∅3/8"	∅1/2"
9.5 mm	12.7 mm
∅5/8"	∅3/4"
16 mm	19 mm
∅7/8"	∅1"
22.2 mm	25 mm
∅1 1/8"	
28.6 mm	



YATO	Pipe diameter / Średnica rury	
YT-21826	3/8" (9.5 mm), 1/2" (12.7 mm), 5/8" (15.9 mm), 3/4" (19.0 mm), 7/8" (22.2 mm), 1" (25.4 mm), 1-1/8" (28.6 mm)	4

EN Pipe calibration tool with reamer
 PL Kalibrator z gratownikiem
 DE Kalibrierer und Entgrater für Mehrschichtverbundrohr
 RU Калибратор пластиковый с фаскоснимателем
 CZ Kalibrátor s odhrotovačem pro trubku
 HU Csőkalibráló sorjázóval
 RO Calibrator teava cu debavurator
 FR Calibreur ébavureur pour tube multicouche
 IT Calibratore sbavatore per tubo
 ES Desbarbador y calibrador para tubos
 CN 三脚内外倒角整圆器



EN Pipe calibration tool with reamer
 PL Kalibrator z gratownikiem
 DE Kalibrierer und Entgrater für Mehrschichtverbundrohr
 RU Калибратор для труб с фаскоснимателем
 CZ Kalibrátor s odhrotovačem pro trubku
 HU Csőkalibráló sorjázóval
 RO Calibrator teava cu debavurator
 FR Calibreur ébavureur pour tube multicouche
 IT Calibratore sbavatore per tubo
 ES Desbarbador y calibrador para tubos
 CN 整圆倒角器



EN Pipe calibration tool
 PL Kalibrator do rur
 DE Kalibrierer für Mehrschichtverbundrohr
 RU Калибратор для труб
 CZ Kalibrátor pro trubku
 HU Csőkalibráló
 RO Calibrator teava multistrat
 FR Outil de calibrage pour tube multicouche
 IT Calibratore per tubo
 ES Calibrador para tubos multicapa
 CN 整圆器



YATO	Pipe external diameter / Zewnętrzna średnica rury [mm]	
YT-22373	16, 20, 25	200
YT-22374	16, 20, 26	200



YATO	Pipe external diameter / Zewnętrzna średnica rury [mm]	
YT-22375	16	10/40
YT-22376	20	10/40
YT-22377	25, 26	10/40



YATO	Pipe external diameter / Zewnętrzna średnica rury [mm]	
YT-22378	16, 18, 20, 25, 32	10/40

EN Plastic pipe welder
 PL Zgrzewarka do rur termoplastycznych
 DE Schweißgerät für thermoplastische Rohre
 RU Аппарат для сварки пластиковых труб
 CZ Svářečka na termoplastické trubky
 HU Hegesztő berendezés termoplasztikus csövekhez

RO Mașină de sudat țevi termoplastice
 FR Machine à souder pour tuyaux
 IT Polifusore saldatore per tubi plastica
 ES Máquina de soldadura de tubos de plástico
 CN 热熔器

175-245V~ 50/60Hz
800 W
0-320 °C
∅16-32 mm



∅ 16, 20, 25, 32 mm

YATO	[W]	
YT-82251	800	10

EN Plastic pipe welder
 PL Zgrzewarka do rur termoplastycznych
 DE Schweißgerät für thermoplastische Rohre
 RU Аппарат для сварки пластиковых труб
 CZ Svářečka na termoplastické trubky
 HU Hegesztő berendezés termoplasztikus csövekhez

RO Mașină de sudat țevi termoplastice
 FR Machine à souder pour tuyaux
 IT Polifusore saldatore per tubi plastica
 ES Máquina de soldadura de tubos de plástico
 CN 热熔器

230V~ 50Hz
850 W
0-300 °C



∅ 16, 20, 25, 32, 40, 50, 63 mm

YATO	[W]	
YT-82250	850	2

EN Crimping pliers for PEX-AL-PEX pipes
PL Praska do zaciskania złączek PEX-AL-PEX
DE Rohrpresszange PEX-AL-PEX
RU Пресс-клещи для металлопластиковых труб
CZ Lisovací kleště pro trubky PEX-AL-PEX
HU PEX-AL-PEX krimpelő eszköz
RO Clește de sertizare pt. țevi PEX-AL-PEX
FR Pince à sertir tuyaux PEX-AL-PEX
IT Crimpatrice per tubi PEX-AL-PEX
ES Alicates prensadores de tuberías PEX-AL-PEX
CN 手动压管钳



9 PCS	PEX 	U 16mm	U 20mm
U 25mm	U 32mm	6t 60 kN	TH 16mm
TH 20mm	TH 26mm	TH 32mm	



YATO
YT-21735 2

EN Crimping pliers for PEX-AL-PEX pipes
PL Praska do zaciskania złączek PEX-AL-PEX
DE Rohrpresszange PEX-AL-PEX
RU Пресс-клещи для металлопластиковых труб
CZ Lisovací kleště pro trubky PEX-AL-PEX
HU PEX-AL-PEX krimpelő eszköz
RO Clește de sertizare pt. țevi PEX-AL-PEX
FR Pince à sertir tuyaux PEX-AL-PEX
IT Crimpatrice per tubi PEX-AL-PEX
ES Alicates prensadores de tuberías PEX-AL-PEX
CN 手动压管钳



9 PCS	PEX 	U 16mm	U 20mm
U 25mm	U 32mm	TH 16mm	TH 20mm
TH 26mm	TH 32mm	10t	



YATO
YT-21758 4

EN Crimping pliers for PEX-AL-PEX pipes
PL Praska do zaciskania złączek PEX-AL-PEX
DE Rohrpresszange PEX-AL-PEX
RU Пресс-клещи для металлопластиковых труб
CZ Lisovací kleště pro trubky PEX-AL-PEX
HU PEX-AL-PEX krimpelő eszköz
RO Clește de sertizare pt. țevi PEX-AL-PEX
FR Pince à sertir tuyaux PEX-AL-PEX
IT Crimpatrice per tubi PEX-AL-PEX
ES Alicates prensadores de tuberías PEX-AL-PEX
CN 手动压管钳



9 PCS	PEX 	U 16mm	U 20mm
U 25mm	U 32mm	TH 16mm	TH 20mm
TH 26mm	TH 32mm	10t	360°



YATO
YT-21759 2

EN Crimping pliers for PEX-AL-PEX pipes
PL Praska do zaciskania złączek PEX-AL-PEX
DE Rohrpresszange PEX-AL-PEX
RU Пресс-клещи для металлопластиковых труб
CZ Lisovací kleště pro trubky PEX-AL-PEX
HU PEX-AL-PEX krimpelő eszköz

RO Clește de sertizare pt. țevi PEX-AL-PEX
FR Pince à sertir tuyaux PEX-AL-PEX
IT Crimpatrice per tubi PEX-AL-PEX
ES Alicates prensadores de tuberías PEX-AL-PEX
CN 手动压管钳

4 PCS	PEX 	TH 16mm	TH 20mm	TH 26mm	
----------	---------	------------	------------	------------	--



YATO
YT-21750 4

EN Crimping pliers for PEX-AL-PEX pipes
PL Praska do zaciskania złączek PEX-AL-PEX
DE Rohrpresszange PEX-AL-PEX
RU Пресс-клещи для металлопластиковых труб
CZ Lisovací kleště pro trubky PEX-AL-PEX
HU PEX-AL-PEX krimpelő eszköz

RO Clește de sertizare pt. țevi PEX-AL-PEX
FR Pince à sertir tuyaux PEX-AL-PEX
IT Crimpatrice per tubi PEX-AL-PEX
ES Alicates prensadores de tuberías PEX-AL-PEX
CN 手动压管钳

4 PCS	PEX 	U 16mm	U 20mm	U 25mm	
----------	---------	-----------	-----------	-----------	--



YATO
YT-21751 4

EN Spare die for crimping pliers
 PL Matryca zapasowa do zaciskarki
 DE Rohrpresszange-Pressbacke
 RU Вкладыш для пресс-инструмента
 CZ Náhradní matrice pro lisovací kleště
 HU Krimpelő betét
 RO Cap de schimb pt. presă
 FR Matrice pour pince à sertir tuyaux
 IT Inserto per pinza a pressione
 ES Matriz para alicate de prensar
 CN 手动压管钳模具

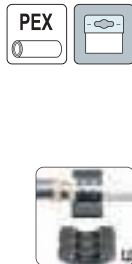

For YT-21735
 Dla YT-21735

YATO	[mm]	
YT-21740	16	50
YT-217403	18	50
YT-21741	20	50
YT-21742	25	50
YT-21743	32	100

EN Spare die for crimping pliers
 PL Matryca zapasowa do zaciskarki
 DE Rohrpresszange-Pressbacke
 RU Вкладыш для пресс-инструмента
 CZ Náhradní matrice pro lisovací kleště
 HU Krimpelő betét
 RO Cap de schimb pt. presă
 FR Matrice pour pince à sertir tuyaux
 IT Inserto per pinza a pressione
 ES Matriz para alicate de prensar
 CN 手动压管钳模具

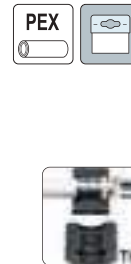

For YT-21735
 Dla YT-21735

YATO	[mm]	
YT-21744	16	50
YT-217443	18	50
YT-21745	20	50
YT-21746	26	50
YT-21747	32	100

EN Spare die for crimping pliers
 PL Matryca zapasowa do zaciskarki
 DE Rohrpresszange-Pressbacke
 RU Вкладыш для пресс-инструмента
 CZ Náhradní matrice pro lisovací kleště
 HU Krimpelő betét
 RO Cap de schimb pt. presă
 FR Matrice pour pince à sertir tuyaux
 IT Inserto per pinza a pressione
 ES Matriz para alicate de prensar
 CN 手动压管钳模具

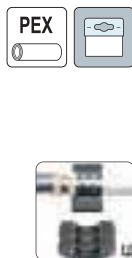

For YT-21750, YT-21751
 Dla YT-21750, YT-21751

YATO	[mm]	
YT-21755	16	50
YT-21756	20	50
YT-21757	25	50

EN Spare die for crimping pliers
 PL Matryca zapasowa do zaciskarki
 DE Rohrpresszange-Pressbacke
 RU Вкладыш для пресс-инструмента
 CZ Náhradní matrice pro lisovací kleště
 HU Krimpelő betét
 RO Cap de schimb pt. presă
 FR Matrice pour pince à sertir tuyaux
 IT Inserto per pinza a pressione
 ES Matriz para alicate de prensar
 CN 手动压管钳模具

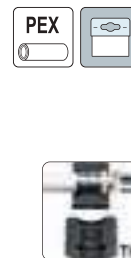

For YT-21750, YT-21751
 Dla YT-21750, YT-21751

YATO	[mm]	
YT-21752	16	50
YT-21753	20	50
YT-21754	26	50

EN Hinged pipe vice
 PL Imadło zaciskowe do rur
 DE Rohrschraubstock
 RU Тиски для труб
 CZ Upinací svěrák na trubky
 HU Satu, csőszorító
 RO Menghină pt. țevi
 FR Étau de serrage à tuyaux
 IT Morsa stringi tubo
 ES Tornillo de apriete para tubos
 CN 管子台虎钳



YATO	Max. mounting element diameter / Maks. średnica mocowanego elementu [mm]	
YT-6510	60	4
YT-6511	76	2
YT-6512	90	2
YT-6513	110	1

EN Water pressure gauge
 PL Zestaw do kontroli ciśnienia instalacji wodnej
 DE Druckmessgerät für Wasserinstallationen
 RU Набор для контроля давления в установках воды
 CZ Sada pro kontrolu tlaku vodovodní instalace
 HU Viznyomásmérő óra
 RO Manometru presiune apa
 FR Kit de contrôle de la pression du système sanitaire
 IT Set per controllo di pressione nell'impianto idrico
 ES Kit para el control de presión en la instalación de agua
 CN 水压表

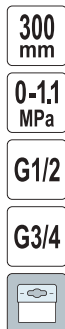

YATO	
YT-24790	10/80

EN Thread seal string
 PL Nić do uszczelniania gwintów
 DE Gewindedichtfaden
 RU Уплотнительная нить
 CZ Těsnící vlákno na závity
 HU Menetítőmitő zsinór
 RO Șnur pt. etansare filete
 FR Tuyau étanchéité cordon
 IT Filo sigillafi letti
 ES Hilo sellador
 CN 螺纹密封线



PIPE DIAMETER / ŚREDNICA RURY	CYCLE NUMBER / ILOŚĆ ZWIĄZKÓW
1/2" (12,5 mm)	6-8
3/4" (19 mm)	7-9
1" (25 mm)	8-12
1 1/2" (38 mm)	10-15
2" (50 mm)	15-25
2 1/2" (63 mm)	20-35
3" (75 mm)	25-35
3 1/2" (88 mm)	30-40
4" (100 mm)	35-45

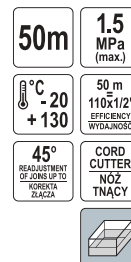

YATO	L [m]	
YT-29220	50	25/100

EN Thread seal string
 PL Nić do uszczelniania gwintów
 DE Gewindedichtfaden
 RU Уплотнительная нить
 CZ Těsnící vlákno na závity
 HU Menetítőmitő zsinór
 RO Șnur pt. etansare filete
 FR Tuyau étanchéité cordon
 IT Filo sigillafi letti
 ES Hilo sellador
 CN 螺纹密封线



PIPE DIAMETER / ŚREDNICA RURY	CYCLE NUMBER / ILOŚĆ ZWIĄZKÓW
1/2" (12,5 mm)	6-8
3/4" (19 mm)	7-9
1" (25 mm)	8-12
1 1/2" (38 mm)	10-15
2" (50 mm)	15-25
2 1/2" (63 mm)	20-35
3" (75 mm)	25-35
3 1/2" (88 mm)	30-40
4" (100 mm)	35-45

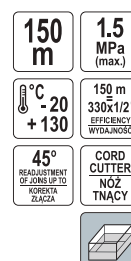

YATO	L [m]	
YT-29222	150	25/100

EN Radiator bleed key
 PL Kluczyk do odpowietrzania grzejników
 DE Heizkörper-Entlüftungsschlüssel
 RU Ключ для радиаторов
 CZ Klíč na odvzdušnění radiátorů
 HU Radiátor légtelenítő kulcs
 RO Cheie aerisit radiator
 FR Clé de purge pour radiateur
 IT Chiave per spurgo termosifoni
 ES Llave para purgar radiadores
 CN 排气钥匙



YATO	
YT-21991	24/144

EN Hand pressure test pump
PL Pompa ręczna do prób ciśnieniowych
DE Handpumpe für Druckproben
RU Ручной насос для опрессовки
CZ Ruční čerpadlo pro tlakové testování
HU Kézi nyomáspróba szivattyú
RO Pompa manuala testat presiunea
FR Pompe manuelle pour tests de pression
IT Pompa manuale per prove di pressione
ES Bomba manual para pruebas de presión
CN 试压泵

490x160
x165 mm
12L
0-5 MPa
G1/2



YATO	Tank capacity / Pojemność zbiornika [l]	
YT-24800	12	2

EN Hand pressure test pump
PL Pompa ręczna do prób ciśnieniowych
DE Handpumpe für Druckproben
RU Ручной насос для опрессовки
CZ Ruční čerpadlo pro tlakové testování
HU Kézi nyomáspróba szivattyú
RO Pompa manuala testat presiunea
FR Pompe manuelle pour tests de pression
IT Pompa manuale per prove di pressione
ES Bomba manual para pruebas de presión
CN 试压泵

7L
0-5 MPa
G1/2



YATO	Tank capacity / Pojemność zbiornika [l]	
YT-24801	7	2

EN Deburrer
PL Gratownik
DE Entgrater
RU Гратосниматель
CZ Odhrolovač
HU Sorjázó
RO Debavurator
FR Ébavureur
IT Sbastatore
ES Desbarbador
CN 修边器

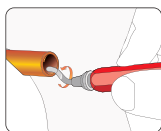

6 PCS
HSS M2
CHANGEABLE ROTATING BLADE
WYMIENNE OSTRZE OBROTOWE



YATO		
YT-22363		50/100

EN Pipe deburrer
PL Gratownik do rur
DE Rohrentgrater
RU Гратосниматель для труб
CZ Odhrolovač trubek
HU Sorjázó
RO Debavurator pt. tevi
FR Ébavureur de tuyaux
IT Sbastatore per tubi
ES Desbarbador de tubos
CN 修边器



∅ 4-40 mm
65Mn
ZNAL

YATO	∅ [mm]	
YT-22364	4-40	64

EN External chamfer tool
PL Gratownik zewnętrzny
DE Außenentgrater
RU Гратосниматель наружный для труб
CZ Přípravek na odstraňování ořepů
HU Külső sorjázó
RO Debavurator extern
FR Ébavureur extérieur
IT Sbastatore esterno
ES Desbarbador exterior
CN 外圆倒角器



∅ 3-19 mm
12 mm ↑
1/4"
6.3 mm
YG8

YATO	∅ [mm]	
YT-22357	3-19	10/80

EN Pipe deburrer
PL Gratownik do rur
DE Rohrentgrater
RU Гратосниматель для труб
CZ Odhrolovač trubek
HU Sorjázó
RO Debavurator pt. tevi
FR Ébavureur de tuyaux
IT Sbastatore per tubi
ES Desbarbador de tubos
CN 修边器



PVC PP
PU PE
SS Al Cu
6-36 mm

YATO	∅ [mm]	
YT-22365	6-36	80

EN Deburrer
PL Gratownik
DE Entgrater
RU Гратосниматель
CZ Odhrolovač
HU Sorjázó
RO Debavurator
FR Ébavureur
IT Sbastatore
ES Desbarbador
CN 修边器

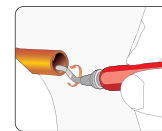

∅ 12 mm
HSS M2
CHANGEABLE ROTATING BLADE
WYMIENNE OSTRZE OBROTOWE



YATO		
YT-22360		50/150

EN Deburrer
PL Gratownik
DE Entgrater
RU Гратосниматель
CZ Odhrolovač
HU Sorjázó
RO Debavurator
FR Ébavureur
IT Sbastatore
ES Desbarbador
CN 修边器

max ∅ 25 mm
HSS M2
CHANGEABLE ROTATING BLADE
WYMIENNE OSTRZE OBROTOWE



YATO		
YT-22362		50/100

EN Replacement blade for deburrer
PL Ostrza zapasowe do gratownika
DE Ersatzklinge für Entgrater
RU Лезвие для снятия заусенцев
CZ Náhradní čepel pro odjehlování
HU Tartalék penge sorjázásához
RO Lame rezervă pt. debavurator
FR Set de lames pour ébavureur
IT Set di lame per sbastatore
ES Cuchilla de repuesto para desbarbar
CN 修边器刀片



10 PCS
HSS M2
UNIVERSAL SHAPE
UNIVERSÁLNY KSZÁLT
CHANGEABLE ROTATING BLADE
WYMIENNE OSTRZE OBROTOWE

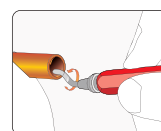

YATO		
YT-22361		12/144

For YT-22360
Dla YT-22360

EN Copper pipe internal brush
 PL Szczotka wewnętrzna do rur miedzianych
 DE Kupferrohr Innenbürste
 RU Щетка для внутренней очистки труб
 CZ Kartač vnitřní na měděné trubky
 HU Rézcső belső tisztító kefe
 RO Perii de interior pt. tevi de cupru
 FR Brosse aux tubes en cuivre
 IT Spazzola per il rame interno
 ES Cepillo para limpieza de tubos de cobre
 CN 管子刷



YATO	Pipe internal diameter / Wewnętrzna średnica rury [mm]	
YT-63701	15	12/240
YT-63702	18	12/240
YT-63703	22	12/240
YT-63704	28	12/240

EN Cleaning pad set for copper pipes
 PL Włókna do czyszczenia rur miedzianych
 DE Reinigungsvlies-Satz für Kupferrohre
 RU Губка абразивная
 CZ Brusné rouno
 HU Tisztítószivacs
 RO Burete abraziv
 FR Tampons de nettoyage
 IT Fibra abrasiva per la pulizia di tubo di rame
 ES Almohadilla abrasiva
 CN 百洁布

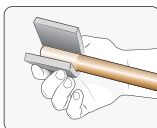

YATO	Size / Rozmiar [mm]	
YT-63740	75x130	50

EN Drain auger
 PL Spirala kanalizacyjna
 DE Rohrreinigungsspirale
 RU Трос сантехнический
 CZ Spirála na čišťení trubek
 HU Csőtisztító spirál
 RO Sarpe pt. desfundat țevi
 FR Câble de nettoyage de tuyaux
 IT Molla sturatubi
 ES Varilla para limpiar desagües
 CN 管道疏通器



YATO	Ø [mm]	L [m]	
YT-24990	6x1.3	6	12

EN Drain auger
 PL Spirala kanalizacyjna
 DE Rohrreinigungsspirale
 RU Трос сантехнический
 CZ Spirála na čišťení trubek
 HU Csőtisztító spirál

RO Sarpe pt. desfundat țevi
 FR Câble de nettoyage de tuyaux
 IT Molla sturatubi
 ES Varilla para limpiar desagües
 CN 管道疏通器



YATO	Ø [mm]	L [m]	
YT-25000	5x1.5	1.5	30/60
YT-25001	5x1.5	3.0	20/40
YT-25002	6x1.3	3.0	20/40
YT-25003	6x1.3	5.0	10/20
YT-25004	9x1.7	5.0	10
YT-25005	9x1.7	10.0	6

EN Copper pipe brush 2 in 1
 PL Szczotka do rur miedzianych 2 w 1
 DE 2 in 1 Kupferrohrbürste für Innen- und Außenreinigung
 RU Щетка для внутренней и внешней зачистки медных труб
 CZ Kartač vnitřní a vnější na měděné trubky
 HU Rézcső tisztító kefe 2 in 1
 RO Perii pt. tevi de cupru 2 in 1
 FR Brosse aux tubes en cuivre
 IT Spazzola per il tubi di rame 2 in 1
 ES 2 en 1 cepillo para limpieza de tubos de cobre int. y ext
 CN 管子刷



YATO	Pipe external & internal diameter / Zewnętrzna i wewnętrzna średnica rury [mm]	
YT-63705	15, 22	50/100

EN Drain suction pump
 PL Pompa do udrażniania kanalizacji
 DE Rohrreinigungspumpe
 RU Пневматический вантуз для прочистки труб
 CZ Čerpadlo na čišťení trubek
 HU Lefolyótisztító pumpa
 RO Pompă pt. desfundarea țevilor
 FR Déboucheur à pompe à vide
 IT Pompa sturatubi
 ES Desatascador bomba de vacío
 CN 气筒疏通器



YATO	
YT-25030	4

EN Drain auger
 PL Spirala kanalizacyjna
 DE Rohrreinigungsspirale
 RU Трос сантехнический
 CZ Spirála na čišťení trubek
 HU Csőtisztító spirál
 RO Sarpe pt. desfundat țevi
 FR Câble de nettoyage de tuyaux
 IT Molla sturatubi
 ES Varilla para limpiar desagües
 CN 管道疏通器



YATO	Ø [mm]	L [m]	
YT-24991	6x1.3	7.6	8

EN Toilet auger
 PL Przetykacz do toalet
 DE Abflusstamper
 RU Средство от засорения унитаза
 CZ Čistič toalet
 HU Duguláshárító
 RO Dispozitiv pt. desfundat toaleta
 FR Ustensile pour déboucher les toilettes
 IT Stura WC
 ES Sonda destapadora wc
 CN 疏通器

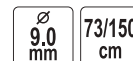

YATO	Ø [mm]	L [cm]	
YT-24983	9	150	6

- EN Drain rod set
PL Zestaw prętów do udrażniania kanalizacji
DE Abflusstreinigungsstangen-Set
RU Прутья для прочистки канализационных труб
CZ Pruty k čištění kanalizace sada
HU Csőtisztító rudkészlet
RO Accesorii pt. dispozitiv defundat revii
FR Tiges pour déboucher les canalisations
IT Kit di barre per lo sturamento della rete fognaria
ES Varillas de alcantarillado, juego
CN 疏通器

12 PCS 20 mm 9.2m 10x93.2 cm PP

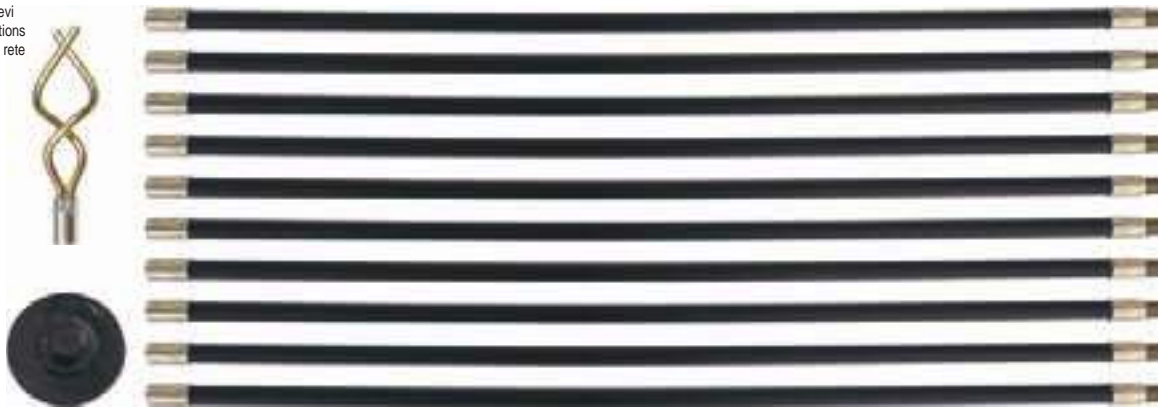

YATO
YT-24980 8

- EN Brush for drain cleaning
PL Szczotka do udrażniania kanalizacji
DE Abflusbürste
RU Щетка для прочистки канализационных труб
CZ Štětka k čištění kanalizace
HU Csőtisztító kefe
RO Perie pt. curățarea scurgerilor
FR Brosse pour déboucher les canalisations
IT Spazzola per lo sturamento della rete fognaria
ES Cepillo de alcantarillado
CN 疏通器刷头

PP NYLON



For YT-24980
Dla YT-24980

YATO	Ø [mm]	
YT-24970	100	20/40
YT-24971	200	20/40
YT-24972	250	20/40

- EN Scraper for drain cleaning
PL Skrobak opadowy do udrażniania kanalizacji
DE Klappschaber für Abflusreinigung
RU Проходной скребок для прочистки канализационных труб
CZ Odpadová škrabka k čištění kanalizace
HU Csőtisztító kaparó
RO Racletă pt. curățarea țevilor
FR Grattoir pour déboucher les canalisations
IT Raschietto gravitazionale per lo sturamento della rete fognaria
ES Rasqueta articulada de alcantarillado
CN 疏通器耙头

95x1.5 mm
 ZINC PLATED OCYNKO-WANA



For YT-24980
Dla YT-24980

YATO	Size / Rozmiar [mm]	
YT-24965	95x1.5	20/100

- EN Double worm for drain cleaning
PL Końcówka spiralna do udrażniania kanalizacji
DE Doppelschnecke für Abflusreinigung
RU Спиральный наконечник для прочистки канализационных труб
CZ Spirálová koncovka k čištění kanalizace
HU Csőtisztító dupla menetes csavar
RO Cap spirală dublă pt. curățarea scurgerilor
FR Extrémité en spirale pour déboucher les canalisations
IT Testa spirale per lo sturamento della rete fognaria
ES Tubo espiral de drenaje
CN 疏通器绕钩

165x7 mm ZINC PLATED OCYNKO-WANA



For YT-24980
Dla YT-24980

YATO	Size / Rozmiar [mm]	
YT-24963	165x7	24/96

- EN Guide wheel for drain cleaning
PL Kółko prowadzące do udrażniania kanalizacji
DE Leitrad für Abflusreinigung
RU Ведущее колесо для прочистки канализационных труб
CZ Naváděcí kolečko k čištění kanalizace
HU Csőtisztító vezetőkerék
RO Roata ghidaj curățarea scurgerilor
FR Roue de guidage pour déboucher les canalisations
IT Anello di guida per lo sturamento della rete fognaria
ES Rueda de guía de drenaje
CN 疏通器滚轮

55 mm ZINC PLATED OCYNKO-WANA















For YT-24980
Dla YT-24980

YATO	Ø [mm]	
YT-24966	55	20/60

12

Fastening tools
Narzędzia do łczenia



Hand riveters & accessories Nitownice ręczne i akcesoria		266-269	Foam guns Pistolety do pianki		272
Hand riveters Nitownice ręczne		266	Caulking guns Wyciskacze do mas		272-274
Hand riveting tools Nitownice ręczne, dźwigniowe		267	Steel cable ties Opaski metalowe		274
Hand nut tools Nitownice do nitonakrętek		267	Cable ties Opaski plastikowe		274
Hand riveters nut column Nitownice do nitotrzpieni		268	Burners & soldering tools Palniki i lutownice		275-282
Threaded rivet nuts Nitonakrętki		268	Spot welders Zgrzewarki		282
Blind rivets Nity		269	Glue sticks Wkłady klejowe		283
Pliers for hollow expansion bolts Zaciskarki do kołków typu Molly		269	Jigs & patterns Wzorniki i szablony		284
Screw, plug & nail sets Zestawy wkrętów, kołków i gwoździ		269			
Staple guns & staples Zszywacze i zszywki		270-271			
Staple guns Zszywacze		270			
Staple removers Rozszywacze		271			
Staples Zszywki		271			
Nails Gwoździe		271			

EN Hand riveter
 PL Nitownica ręczna
 DE Hand-Nietzange
 RU Ручной заклепочник
 CZ Ruční nýtovačka
 HU Kézi szegecshúzó

RO Presă de nituit manuală
 FR Riveteuse manuelle
 IT Rivettatrice manuale
 ES Remachadora manual
 CN 手动拉铆枪

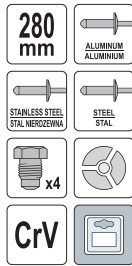

YATO	Ø [mm]	L [mm]	
YT-3600	2.4, 3.2, 4, 4.8	280	6/24

EN Hand riveter
 PL Nitownica ręczna
 DE Hand-Nietzange
 RU Ручной заклепочник
 CZ Ruční nýtovačka
 HU Kézi szegecshúzó

RO Presă de nituit manuală
 FR Riveteuse manuelle
 IT Rivettatrice manuale
 ES Remachadora manual
 CN 手动拉铆枪

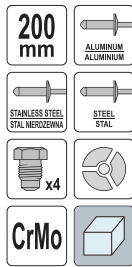

YATO	Ø [mm]	L [mm]	
YT-36012	2.4, 3.2, 4, 4.8	200	30

EN Hand riveter
 PL Nitownica ręczna
 DE Hand-Nietzange
 RU Ручной заклепочник
 CZ Ruční nýtovačka
 HU Kézi szegecshúzó

RO Presă de nituit manuală
 FR Riveteuse manuelle
 IT Rivettatrice manuale
 ES Remachadora manual
 CN 手动拉铆枪



YATO	Ø [mm]	Ø	L [mm]	
YT-36013	2.4, 3.2, 4, 4.8	M3, M4, M5, M6	275	8

EN Hand riveter
 PL Nitownica ręczna
 DE Hand-Nietzange
 RU Ручной заклепочник
 CZ Ruční nýtovačka
 HU Kézi szegecshúzó

RO Presă de nituit manuală
 FR Riveteuse manuelle
 IT Rivettatrice manuale
 ES Remachadora manual
 CN 手动拉铆枪

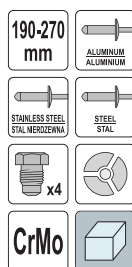

YATO	Ø [mm]	L [mm]	
YT-36070	2.4, 3.2, 4, 4.8	190-270	20

EN Hand riveter
 PL Nitownica ręczna
 DE Hand-Nietzange
 RU Ручной заклепочник
 CZ Ruční nýtovačka
 HU Kézi szegecshúzó

RO Presă de nituit manuală
 FR Riveteuse manuelle
 IT Rivettatrice manuale
 ES Remachadora manual
 CN 手动拉铆枪



YATO	Ø [mm]	L [mm]	
YT-36007	2.4, 3.2, 4, 4.8	250	6/24

EN Hand riveter
 PL Nitownica ręczna
 DE Hand-Nietzange
 RU Ручной заклепочник
 CZ Ruční nýtovačka
 HU Kézi szegecshúzó

RO Presă de nituit manuală
 FR Riveteuse manuelle
 IT Rivettatrice manuale
 ES Remachadora manual
 CN 手动拉铆枪

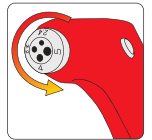
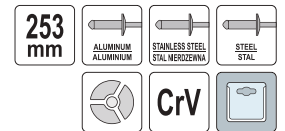

YATO	Ø [mm]	L [mm]	
YT-36011	2.4, 3.2, 4, 4.8	253	12/36

EN Rivet for plastic rivets kit
 PL Zestaw nitownica do nitów plastikowych
 DE Kunststoff-Nietzangen-Satz
 RU Комплект заклепочница для пластиковых заклепок
 CZ Sada nýtovnice do plastových nýtů
 HU Szegecshúzó készlet műanyag szegecsekhez
 RO Set de nituri din plastic + cleste
 FR Ensemble riveteuse pour rivets en plastique
 IT Kit rivettatrice per rivetti in plastica
 ES Juego remachadora para remaches de plástico
 CN 拉铆枪组套



41 PCS
 165 mm
 PVC

5x15.8 mm (10 PCS); 5x17.2 mm (10 PCS); 6.3x25.2 mm (10 PCS); 6.6x17.2 mm (10 PCS)

YATO	Ø [mm]	L [mm]	
YT-35970	5, 6.3, 6.6	165	15/30

EN Lazy tongue riveter
 PL Nitownica harmonijkowa czolowa
 DE Blindnietzange
 RU Передний складной заклепочник
 CZ Nýtovačka harmoniková čelná
 HU Harmóniák popszegecshúzó homlok

RO Presă de nituit armonică - frontală
 FR Pince riveter extensible
 IT Rivettatrice pieghevole anteriore
 ES Remachadora perezoso tong
 CN 重型伸缩拉铆枪

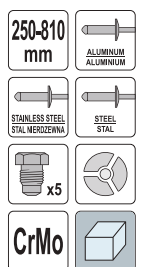

YATO	Ø [mm]	L [mm]	
YT-36060	2.4, 3.2, 4, 4.8, 6.4	250-810	10

EN Hand riveting tool
PL Nitownica dźwigniowa
DE Hebelnietzange
RU Заклепочник рычажный
CZ Nýtovačka páková
HU Kézi szegecshúzó
RO Presă de nituit manuală
FR Riveteuse à levier
IT Rivettatrice a leva
ES Remachadora de palanca
CN 拉铆枪

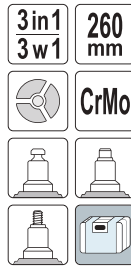

YATO	Ø [mm]	Ø	L [mm]	
YT-36091	2.4, 3.2, 4, 4.8, 6.4	M3, M4, M5, M6, M8, M10	260	6

EN Hand riveting tool
PL Nitownica dźwigniowa
DE Hebelnietzange
RU Заклепочник рычажный
CZ Nýtovačka páková
HU Kézi szegecshúzó

RO Presă de nituit manuală
FR Riveteuse à levier
IT Rivettatrice a leva
ES Remachadora de palanca
CN 拉铆枪

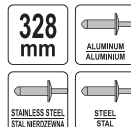
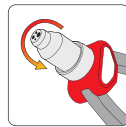

YATO	Ø [mm]	L [mm]	
YT-36092	3.2, 4, 4.8, 6.4	328	12

EN Hand riveting tool
PL Nitownica dźwigniowa
DE Hebelnietzange
RU Заклепочник рычажный
CZ Nýtovačka páková
HU Kézi szegecshúzó

RO Presă de nituit manuală
FR Riveteuse à levier
IT Rivettatrice a leva
ES Remachadora de palanca
CN 拉铆枪

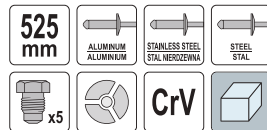

YATO	Ø [mm]	L [mm]	
YT-3610	3.2, 4, 4.8, 6, 6.4	525	12

EN Hand rivet nut tool
PL Nitownica ręczna do nitonakrętek
DE Nietmutternzange
RU Ручной заклепочник для резьбовых заклепок
CZ Ruční nýtovačka na matice
HU Emelytűs popszegecshúzó

RO Clește pt. piulițe nituibile
FR Riveteuse manuelle aux écrous
IT Rivettatrice per dadi filettati
ES Remachadora de tuercas
CN 手动螺母枪

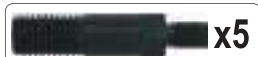

YATO	Ø	L [mm]	
YT-36112	M3, M4, M5, M6, M8	300	20

EN Hand riveting tool
PL Nitownica dźwigniowa
DE Hebelnietzange
RU Заклепочник рычажный
CZ Nýtovačka páková
HU Kézi szegecshúzó

RO Presă de nituit manuală
FR Riveteuse à levier
IT Rivettatrice a leva
ES Remachadora de palanca
CN 拉铆枪

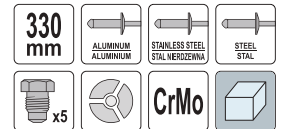

YATO	Ø [mm]	L [mm]	
YT-3609	3.2, 4, 4.8, 6, 6.4	330	16

EN Hand riveting tool
PL Nitownica dźwigniowa
DE Hebelnietzange
RU Заклепочник рычажный
CZ Nýtovačka páková
HU Kézi szegecshúzó

RO Presă de nituit manuală
FR Riveteuse à levier
IT Rivettatrice a leva
ES Remachadora de palanca
CN 拉铆枪

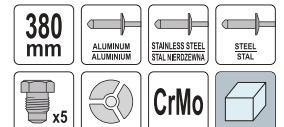

YATO	Ø [mm]	L [mm]	
YT-36095	2.4, 3.2, 4, 4.8, 6.4	380	12

EN Hand rivet nut tool
PL Nitownica ręczna do nitonakrętek
DE Nietmutternzange
RU Ручной заклепочник для резьбовых заклепок
CZ Ruční nýtovačka na matice
HU Emelytűs popszegecshúzó

RO Clește pt. piulițe nituibile
FR Riveteuse manuelle aux écrous
IT Rivettatrice per dadi filettati
ES Remachadora de tuercas
CN 手动螺母枪



YATO	Ø	L [mm]	
YT-36140	M3, M4, M5, M6	200	20

EN Hand rivet nut tool
PL Nitownica ręczna do nitonakrętek
DE Nietmutternzange
RU Ручной заклепочник для резьбовых заклепок
CZ Ruční nýtovačka na matice
HU Emelytűs popszegecshúzó

RO Clește pt. piulițe nituibile
FR Riveteuse manuelle aux écrous
IT Rivettatrice per dadi filettati
ES Remachadora de tuercas
CN 手动螺母枪



YATO	Ø	L [mm]	
YT-3612	M5, M6, M8, M10, M12	330	5

EN Hand rivet nut tool
 PL Nitownica ręczna do nitonakrętek
 DE Nietmutterzange
 RU Ручной заклёпочник для резьбовых заклёпок
 CZ Ruční nýtovačka na matice
 HU Emeltyűs popszegecshúzó

RO Clește pt. piulițe nituibile
 FR Riveteuse manuelle aux écrous
 IT Rivettatrice per dadi filettati
 ES Remachadora de tuercas
 CN 手动螺母枪

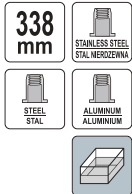

YATO	∅	L [mm]	
YT-36119	M5, M6, M8, M10, M12	338	6

EN Hand rivet nut tool
 PL Nitownica ręczna do nitonakrętek
 DE Nietmutterzange
 RU Ручной заклёпочник для резьбовых заклёпок
 CZ Ruční nýtovačka na matice
 HU Emeltyűs popszegecshúzó

RO Clește pt. piulițe nituibile
 FR Riveteuse manuelle aux écrous
 IT Rivettatrice per dadi filettati
 ES Remachadora de tuercas
 CN 手动螺母枪



YATO	∅	L [mm]	
YT-36118	M3, M4, M5, M6, M8, M10, M12	360	6

EN Hand rivet nut tool
 PL Nitownica ręczna do nitonakrętek
 DE Nietmutterzange
 RU Ручной заклёпочник для резьбовых заклёпок
 CZ Ruční nýtovačka na matice
 HU Emeltyűs popszegecshúzó

RO Clește pt. piulițe nituibile
 FR Riveteuse manuelle aux écrous
 IT Rivettatrice per dadi filettati
 ES Remachadora de tuercas
 CN 手动螺母枪

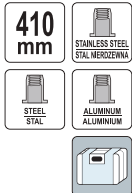

YATO	∅	L [mm]	
YT-36129	M3, M4, M5, M6, M8, M10, M12	410	5

EN Threaded aluminum rivet nuts
 PL Nitonakrętki aluminiowe
 DE Aluminium Blindnietmutter
 RU Алюминиевые резьбовые заклёпки
 CZ Hliníkové nýtovací matice
 HU Szegecsanya alumínium

RO Piulițe nituibile
 FR Écrous à rivet aluminium
 IT Alluminio dadi per rivetti ciechi
 ES Tuercas remachadas aluminio
 CN 柳枪螺母



YATO	Size / Rozmiar	
YT-36451	M3	125/500
YT-36452	M4	100/400
YT-36453	M5	75/300
YT-36454	M6	50/200

EN Hand rivet nut tool
 PL Nitownica ręczna do nitonakrętek
 DE Nietmutterzange
 RU Ручной заклёпочник для резьбовых заклёпок
 CZ Ruční nýtovačka na matice
 HU Emeltyűs popszegecshúzó

RO Clește pt. piulițe nituibile
 FR Riveteuse manuelle aux écrous
 IT Rivettatrice per dadi filettati
 ES Remachadora de tuercas
 CN 手动螺母枪



YATO	∅	L [mm]	
YT-36127	M3, M4, M5, M6, M8, M10, M12	360	12

EN Hand rivet nut tool
 PL Nitownica ręczna do nitonakrętek
 DE Nietmutterzange
 RU Ручной заклёпочник для резьбовых заклёпок
 CZ Ruční nýtovačka na matice
 HU Emeltyűs popszegecshúzó

RO Clește pt. piulițe nituibile
 FR Riveteuse manuelle aux écrous
 IT Rivettatrice per dadi filettati
 ES Remachadora de tuercas
 CN 手动螺母枪



YATO	∅	L [mm]	
YT-36125	M3, M4, M5, M6, M8, M10, M12	420	5

EN Hand riveter nut column set
 PL Nitownica ręczna do nitotrzpieni z akcesoriami
 DE Nietzange für Blindnieterschrauben mit Zubehör
 RU Заклёпочник для резьбовых заклёпок с принадлежностями
 CZ Ruční nýtovačka na nýtovací šrouby s příslušenstvím
 HU Kézi szegecsanya húzó tartozékokkal
 RO Set șuruburi nituibile
 FR Riveteuse manuelle pour boulons à rivet aveugle avec accessoires
 IT Rivettatrice manuale per perni filettati
 ES Remachadora manual para espárragos remachables con accesorios
 CN 柳螺母柱枪

RO Piulițe nituibile
 FR Écrous à rivet acier
 IT Dadi per rivetti ciechi
 ES Tuercas remachadas
 CN 拉柳螺母



YATO	∅	L [mm]	
YT-36150	M4, M5, M6, M8	360	6

EN Threaded rivet nuts
 PL Nitonakrętki stalowe
 DE Blindnietmutter
 RU Резьбовые заклёпки
 CZ Nýtovací matice
 HU Szegecsanya

RO Piulițe nituibile
 FR Écrous à rivet acier
 IT Dadi per rivetti ciechi
 ES Tuercas remachadas
 CN 拉柳螺母



YATO	Size / Rozmiar	
YT-36470	M3	125/500
YT-36471	M4	100/400
YT-36472	M5	75/300
YT-36473	M6	50/200
YT-36474	M8	35/140
YT-36475	M10	25/100
YT-36476	M12	15/60

EN Threaded rivet nuts
PL Nitonakrętki
DE Blindnietmutter
RU Резьбовые заклепки
CZ Nýtovací matice
HU Szegecsanyák
RO Piulițe nituibile
FR Écrous à rivet
IT Dadi per rivetti ciechi
ES Tuercas remachadas
CN 拉铆螺母



150
PCS

AI

M3x40, M4x35, M5x25, M6x25, M8x15, M10x10 mm



150
PCS

M3x40, M4x35, M5x25, M6x25, M8x15, M10x10 mm



300
PCS

AI

M3x25, M4x25, M5x25, M6x25, M8x25, M10x25, M3x25, M4x25, M5x25, M6x25, M8x25, M10x25 mm

YATO		
YT-36460	24	

YATO		
YT-36481	24	

YATO		
YT-36480	5/20	

EN Nuts column
PL Nitotrzpienie
DE Blindnietverschraubung
RU Шпильки заклепки с винтом
CZ Nýtovací šrouby
HU Szegecs csavar
RO Șuruburi nituibile
FR Boulons à rivet aveugle
IT Pemi filettati
ES Espárragos remachables
CN 螺母柱

20
PCS

AI



YATO	Size / Rozmiar	
YT-36200	M4	50/300
YT-36201	M5	40/160
YT-36202	M6	25/100
YT-36203	M8	15/60

EN Plastic blind rivets
PL Nity plastikowe
DE Kunststoffnieten
RU Заклепки вытяжные пластиковые
CZ Plastové nýty
HU Műanyag szegecsek
RO Nituri din plastic
FR Rivets en plastique
IT Rivetti in plastica
ES Remaches de plástico
CN 塑料铆钉

10
PCS

NYLON

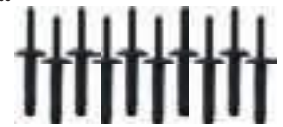

YATO	Size / Rozmiar [mm]	
YT-35981	5.0x15.8	250
YT-35982	5.0x17.2	250
YT-35980	6.3x25.2	250
YT-35983	6.6x17.2	250

EN Pliers for hollow expansion bolts
PL Zaciskarka do kołków „Molly”
DE Maueranker-Einsetzwerkzeug
RU Клещи для дюбелей „Молли”
CZ Kleště kotvící pro Molly hmoždinky
HU Molly fogó üreges bővítőcsavarokhoz
RO Clește pt. ancore metalice
FR Pince pour chevilles creux
IT Crimpatrice per pioli „Molly”
ES Alicata para tacos „Molly”
CN 膨胀螺栓钳组套

175
mm

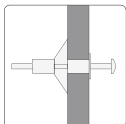

YATO	L [mm]	
YT-51452	175	5/30

EN Pliers for hollow expansion bolts
PL Zaciskarka do kołków „Molly”
DE Maueranker-Einsetzwerkzeug
RU Клещи для дюбелей „Молли”
CZ Kleště kotvící pro Molly hmoždinky
HU Molly fogó üreges bővítőcsavarokhoz
RO Clește pt. ancore metalice
FR Pince pour chevilles creux
IT Crimpatrice per pioli „Molly”
ES Alicata para tacos „Molly”
CN 膨胀螺栓钳组套

10 PCS



Ø 7 mm (32 mm) x5;
Ø 9 mm (37 mm) x5;
Ø 4 mm (40 mm);
Ø 5 mm (44 mm)

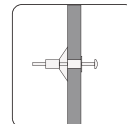

YATO		
YT-51450		6/24

EN Pliers for hollow expansion bolts
PL Zaciskarka do kołków „Molly”
DE Maueranker-Einsetzwerkzeug
RU Клещи для дюбелей „Молли”
CZ Kleště kotvící pro Molly hmoždinky
HU Molly fogó üreges bővítőcsavarokhoz
RO Clește pt. ancore metalice
FR Pince pour chevilles creux
IT Crimpatrice per pioli „Molly”
ES Alicata para tacos „Molly”
CN 膨胀螺栓钳组套

60 PCS

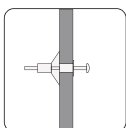

Ø 7 mm (32 mm) x35;
Ø 9 mm (37 mm) x15;
Ø 9 mm (52 mm) x10;
Ø 4 mm (40 mm);
Ø 5 mm (44 mm);
Ø 5 mm (58 mm)

YATO		
YT-51451		3/12

EN Hardened knurled nails assortment
PL Radełkowane gwoździe do betonu
DE Stahlnägel geriffelt Sortiment
RU Гвозди оцинкованные для бетона
CZ Kalený hřebík do betonu
HU Récézett szeg készlet
RO Set cuie pt. beton
FR Assortiment de clous mousés harnes
IT Chiodi zigrinati per calcestruzzo
ES Jogo de pregos durados com erradas
CN 竹节钉组套

106
PCS

ZINC
PLATED
OCYNKO-
WANA



3.5 x 50 mm (66 PCS), 3.5 x 70 mm (40 PCS)

YATO		
YT-36510		12/24

EN Staple gun
 PL Zszywacz tapicerski
 DE Tacker
 RU Crennep
 CZ Čalounická sešivačka
 HU Kárpitos tűzőgép
 RO Capsator tapițerie
 FR Agrafeuse tapisserie
 IT Cucitrice per tappezzeria
 ES Grapadora de tapicero
 CN 打钉枪

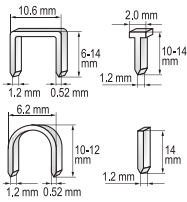

YATO
 YT-7000

12/24

EN Staple gun
 PL Zszywacz tapicerski
 DE Tacker
 RU Crennep
 CZ Čalounická sešivačka
 HU Kárpitos tűzőgép
 RO Capsator tapițerie
 FR Agrafeuse tapisserie
 IT Cucitrice per tappezzeria
 ES Grapadora de tapicero
 CN 打钉枪

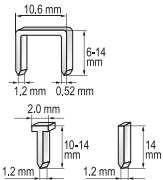
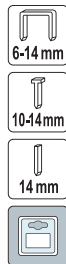

YATO
 YT-7003

6/24

EN Staple gun
 PL Zszywacz tapicerski
 DE Tacker
 RU Crennep
 CZ Čalounická sešivačka
 HU Kárpitos tűzőgép
 RO Capsator tapițerie
 FR Agrafeuse tapisserie
 IT Cucitrice per tappezzeria
 ES Grapadora de tapicero
 CN 打钉枪

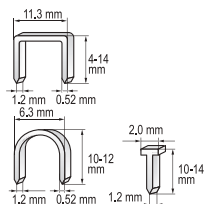
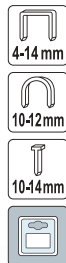

YATO
 YT-70020

6/24

EN Staple gun
 PL Zszywacz tapicerski
 DE Tacker
 RU Crennep
 CZ Čalounická sešivačka
 HU Kárpitos tűzőgép
 RO Capsator tapițerie
 FR Agrafeuse tapisserie
 IT Cucitrice per tappezzeria
 ES Grapadora de tapicero
 CN 打钉枪



EN Staple gun
 PL Zszywacz tapicerski
 DE Tacker
 RU Crennep
 CZ Čalounická sešivačka
 HU Kárpitos tűzőgép
 RO Capsator tapițerie
 FR Agrafeuse tapisserie
 IT Cucitrice per tappezzeria
 ES Grapadora de tapicero
 CN 打钉枪

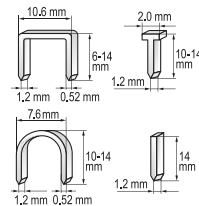

YATO
 YT-7001

12/24

EN Staple gun
 PL Zszywacz tapicerski
 DE Tacker
 RU Crennep
 CZ Čalounická sešivačka
 HU Kárpitos tűzőgép
 RO Capsator tapițerie
 FR Agrafeuse tapisserie
 IT Cucitrice per tappezzeria
 ES Grapadora de tapicero
 CN 打钉枪

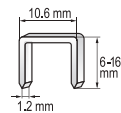

YATO
 YT-7005

6/24

EN Staple gun
 PL Zszywacz tapicerski
 DE Tacker
 RU Crennep
 CZ Čalounická sešivačka
 HU Kárpitos tűzőgép
 RO Capsator tapițerie
 FR Agrafeuse tapisserie
 IT Cucitrice per tappezzeria
 ES Grapadora de tapicero
 CN 打钉枪

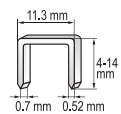

YATO
 YT-7007

12/24

EN Staple gun
 PL Zszywacz tapicerski
 DE Tacker
 RU Crennep
 CZ Čalounická sešivačka
 HU Kárpitos tűzőgép
 RO Capsator tapițerie
 FR Agrafeuse tapisserie
 IT Cucitrice per tappezzeria
 ES Grapadora de tapicero
 CN 打钉枪

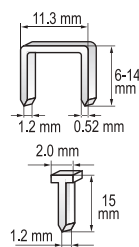

YATO
 YT-70021

6/24

- EN Hammer tacker
PL Zszywacz młotkowy
DE Hammer Tacker
RU Молотковый степлер
CZ Sponkovač kládiový
HU Kalapács tűzőgép
- RO Capsator ciocan
FR Marteau agrafeur
IT Martello cucitrice
ES Grapadora de martillo
CN 钉锤

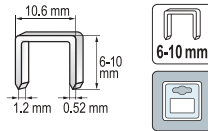

YATO
YT-7004

10/20

- EN Hog ring pliers
PL Szypce do łączenia siatki
DE Gitterverbindungsange
RU Клещи для обжима сетки
CZ Klešťe pro spojování pletiva
HU Drótrögzítő kapcsozó fogó
RO Clește pt. capse legat plasă
FR Pince à grillage
IT Pinza clippatrice per reti
ES Grapadora para mallas
CN 封口钳



YATO
YT-51470

L [mm]

190

40

- EN Staples
PL Zszywki
DE Heftklammern
RU Скобы
CZ Sponky
HU Tűzőkapocs
RO Capse tapițerie
FR Agrafes
IT Punti
ES Grapas
CN 码钉

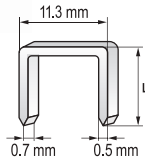
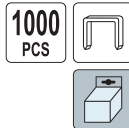

For YT-7007
Dla YT-7007

YATO

L [mm]

pcs / szt.

YATO	L [mm]	pcs / szt.	
YT-7051	6	1000	60/360
YT-7052	8	1000	60/300
YT-7053	10	1000	60/240
YT-7054	12	1000	50/200
YT-7055	14	1000	40/160

- EN Hog ring staples C-type
PL Klamry typu "C" do łączenia siatki
DE C-Typ-Schnallen für Netzverbindungen
RU Скобы типа "C" для обжима сетки
CZ Sponky typu "C" pro spojování pletiva
HU "C" típusú drótfűző kapocs
RO Capse tip "C" pt. plasă
FR Agrafes en "C" pour pince à grillage
IT Punti tipo "C" per pinza clippatrice
ES Grapas tipo "C" para mallas
CN 钉



For YT-51470
Dla YT-51470

YATO
YT-51471

20

- EN Staple remover
PL Rozszywacz
DE Klammern abwender
RU Скобоудалитель
CZ Rozešivač
HU Kapocsiszedő
- RO Extractor capse
FR Degrafeuse
IT Fiocco di rimozione
ES Quitagrapas
CN 起钉器



YATO
YT-7011

25/100

- EN Staples
PL Zszywki
DE Heftklammern
RU Скобы
CZ Sponky
HU Tűzőkapocs
RO Capse tapițerie
FR Agrafes
IT Punti
ES Grapas
CN 码钉

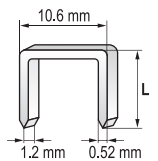
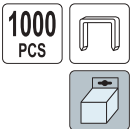

For YT-7000, YT-7001, YT-7003, YT-7005, YT-70020, YT-70021
Dla YT-7000, YT-7001, YT-7003, YT-7005, YT-70020, YT-70021

YATO

L [mm]

pcs / szt.

YATO	L [mm]	pcs / szt.	
YT-7022	6	1000	50/200
YT-7023	8	1000	50/200
YT-7024	10	1000	50/100
YT-7025	12	1000	50/100
YT-7026	14	1000	50/100

- EN Staples
PL Zszywki
DE Heftklammern
RU Скобы
CZ Sponky
HU Tűzőkapocs
RO Capse tapițerie
FR Agrafes
IT Punti
ES Grapas
CN 码钉

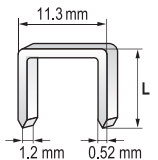
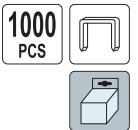

For YT-70020, YT-70021
Dla YT-70020, YT-70021

YATO

L [mm]

pcs / szt.

YATO	L [mm]	pcs / szt.	
YT-70270	6	1000	50/200
YT-70271	8	1000	50/200
YT-70272	10	1000	50/100
YT-70273	12	1000	50/100
YT-70274	14	1000	50/100

- EN Nails for staple gun
PL Gwoździe do zszywacza
DE Nageln für Tacker
RU Гвозди для степлера
CZ Hřebíky pro sešivačku
HU Szeg tűzőgéphez
- RO Cuie pt. capsator
FR Clous pour agrafeuses
IT Chiodi per cucitrice
ES Clavos para grapadoras
CN 直钉

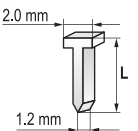

For YT-7000, YT-7001, YT-7003, YT-70020
Dla YT-7000, YT-7001, YT-7003, YT-70020

YATO

L [mm]

pcs / szt.

YATO	L [mm]	pcs / szt.	
YT-7032	10	1000	50/200
YT-7033	12	1000	50/200
YT-7034	14	1000	50/200

EN Foam gun
 PL Pistolet do pianki montażowej
 DE Schaumpistole



RU Пистолет для монтажной пены
 CZ Pistole na montážní pěnu
 HU Szerelőhab kinyomó pisztoly



RO Pistol pt. spumă
 FR Pistolet à mousse expansive
 IT Pistola per schiuma poliuretanică

ES Pistola para espuma de poliuretano
 CN 发泡枪



PTFE 





YATO  
 YT-6740 10/20

YATO  
 YT-6741 10/20



YATO  
 YT-6743 20

YATO  
 YT-6745 20

EN Foam gun
 PL Pistolet do pianki montażowej
 DE Schaumpistole

RU Пистолет для монтажной пены
 CZ Pistole na montážní pěnu
 HU Szerelőhab kinyomó pisztoly

RO Pistol pt. spumă
 FR Pistolet à mousse expansive
 IT Pistola per schiuma poliuretanică



ES Pistola para espuma de poliuretano
 CN 发泡枪



AI  QUICK FLOW ADJUSTMENT SZYBKĄ REGULACJĄ WYPŁYWU 





PTFE

PTFE

YATO  
 YT-67421 20

YATO  
 YT-67441 20

YATO  
 YT-67433 20

EN Foam gun
 PL Pistolet do pianki montażowej
 DE Schaumpistole



RU Пистолет для монтажной пены
 CZ Pistole na montážní pěnu
 HU Szerelőhab kinyomó pisztoly

RO Pistol pt. spumă
 FR Pistolet à mousse expansive
 IT Pistola per schiuma poliuretanică

ES Pistola para espuma de poliuretano
 CN 发泡枪

320 mm AI PTFE 



YATO  
 YT-67422 20

EN Foam gun
 PL Pistolet do pianki montażowej
 DE Schaumpistole



RU Пистолет для монтажной пены
 CZ Pistole na montážní pěnu
 HU Szerelőhab kinyomó pisztoly

RO Pistol pt. spumă
 FR Pistolet à mousse expansive
 IT Pistola per schiuma poliuretanică

ES Pistola para espuma de poliuretano
 CN 发泡枪

500 mm AI  QUICK FLOW ADJUSTMENT SZYBKĄ REGULACJĄ WYPŁYWU 



YATO  
 YT-67460 20

EN Caulking gun
 PL Wyciskacz do mas
 DE Kartuschenpistole

RU Пистолет для герметика
 CZ Ruční výtlačná pistole
 HU Extrudáló pisztoly

RO Pistol silicon
 FR Pistolet à cartouche
 IT Pistola per silicone
 ES Pistola para masilla
 CN 堵缝枪

225 mm 300 ml 



YATO  L [mm] 
 YT-6751 225 10/12

EN Caulking gun
 PL Wyciskacz do mas
 DE Kartuschenpistole

RU Пистолет для герметика
 CZ Ruční výtlačná pistole
 HU Extrudáló pisztoly

RO Pistol silicon
 FR Pistolet à cartouche
 IT Pistola per silicone
 ES Pistola para masilla
 CN 堵缝枪

225 mm 300 ml 



YATO  L [mm] 
 YT-6753 225 6/12

EN Caulking gun
 PL Wyciskacz do mas
 DE Kartuschenpistole

RU Пистолет для герметика
 CZ Ruční výtlačná pistole
 HU Extrudáló pisztoly

RO Pistol silicon
 FR Pistolet à cartouche
 IT Pistola per silicone
 ES Pistola para masilla
 CN 堵缝枪

225 mm 310 ml 



YATO  L [mm] 
 YT-6754 225 6/12

EN Caulking gun
PL Wyciskacz do mas
DE Kartuschenpistole
RU Пистолет для герметика
CZ Ruční výtlačná pistole
HU Extrudáló pisztoly
RO Pistol silicon
FR Pistolet à cartouche
IT Pistola per silicone
ES Pistola para masilla
CN 堵缝枪

225 mm 300 ml 



YATO 	L [mm]	
YT-6750	225	20/24

EN Caulking gun
PL Wyciskacz do mas
DE Kartuschenpistole
RU Пистолет для герметика
CZ Ruční výtlačná pistole
HU Extrudáló pisztoly
RO Pistol silicon
FR Pistolet à cartouche
IT Pistola per silicone
ES Pistola para masilla
CN 堵缝枪

225 mm 300 ml 





YATO 	L [mm]	
YT-6755	225	10/20

EN Caulking gun
PL Wyciskacz do mas
DE Kartuschenpistole
RU Пистолет для герметика
CZ Ruční výtlačná pistole
HU Extrudáló pisztoly
RO Pistol silicon
FR Pistolet à cartouche
IT Pistola per silicone
ES Pistola para masilla
CN 堵缝枪

205 mm 300 ml 



YATO 	L [mm]	
YT-67573	205	10

EN Caulking gun
PL Wyciskacz do mas
DE Kartuschenpistole
RU Пистолет для герметика
CZ Ruční výtlačná pistole
HU Extrudáló pisztoly
RO Pistol silicon
FR Pistolet à cartouche
IT Pistola per silicone
ES Pistola para masilla
CN 堵缝枪

245 mm 400 ml 





YATO 	L [mm]	
YT-67574	245	12

EN Caulking gun
PL Wyciskacz do mas
DE Kartuschenpistole
RU Пистолет для герметика
CZ Ruční výtlačná pistole
HU Extrudáló pisztoly
RO Pistol silicon
FR Pistolet à cartouche
IT Pistola per silicone
ES Pistola para masilla
CN 堵缝枪



225x60 mm

YATO 	L [mm]	
YT-67520	225	12



225x70 mm



YATO 	L [mm]	
YT-67560	225	6



225x60 mm



YATO 	L [mm]	
YT-67570	225	12

EN Air caulking gun
PL Pneumatyczny wyciskacz do mas
DE Pneumatische Kartuschenpistole
RU Пневматический пистолет для герметика
CZ Pneumatická výtlačná pistole
HU Pneumatikus extrudáló pisztoly
RO Pistol pneumatic pt. silicon
FR Pistolet à extruder pneumatique
IT Pistola pneumatica per sigillanti
ES Pistola neumática para masilla
CN 气动胶枪

1.0 MPa 380 mm 600 ml
AI  



$L_{pA} < 70$ dB; $L_{WA} < 80$ dB; $a_n < 2,5$ m/s²

YATO 	L [mm]	
YT-67470	380	10

EN Caulking gun
PL Wyciskacz do mas
DE Kartuschenpistole
RU Пистолет для герметика
CZ Ruční výtlačná pistole
HU Extrudáló pisztoly
RO Pistol silicon
FR Pistolet à cartouche
IT Pistola per silicone
ES Pistola para masilla
CN 堵缝枪

600 mm \varnothing 60 mm 2.0 mm
TRANSPARENT PRZEZROCZYSTY 





YATO 	L [mm]	
YT-67571	600	20

EN Sealed nozzle set
PL Końcówki do nakładania silikonu
DE Enden zum Auftragen von Silikon
RU Наконечники для нанесения силикона
CZ Koncovky pro nanášení silikonu
HU Szilikon felhelyező fejelek
RO Set duze pt. silicon
FR Embouts d'application du silicone
IT Punte per applicatori di silicone
ES Puntas para aplicar silicona
CN 不锈钢喷嘴



14 PCS SS304 STAINLESS STEEL 

YATO 	\varnothing [mm]	
YT-52622	5, 6, 7, 9, 10, 12, 13, 16, 20, 25, 26, 28, 30, 35	50

EN Pressure roller for use in bonding and laminating
 PL Walek do silnego dociskania klejonych powierzchni
 DE Andruckrolle zum starken Andrücken auf geklebte Oberflächen
 RU Ролик для сильного прижима приклеенных поверхностей
 CZ Váleček pro silné přitlačení lepených povrchů
 HU Henger ragasztott felületek erős lenyomásához
 RO Rola pt. lipit si laminat
 FR Rouleau à lisser
 IT Rullo pressore per superfici difficili da incollare
 ES Rodillo para apretar superficies pegadas
 CN 地毯滚筒

38x75 mm

320 mm

RUBBER GUMA

AI



YATO	Roller size / Rozmiar walka [mm]	L [mm]	
YT-44150	38x75	320	6/24

EN Pressure roller for use in bonding and laminating
 PL Walek do silnego dociskania klejonych powierzchni
 DE Andruckrolle zum starken Andrücken auf geklebte Oberflächen
 RU Ролик для сильного прижима приклеенных поверхностей
 CZ Váleček pro silné přitlačení lepených povrchů
 HU Henger ragasztott felületek erős lenyomásához
 RO Rola pt. lipit si laminat
 FR Rouleau à lisser
 IT Rullo pressore per superfici difficili da incollare
 ES Rodillo para apretar superficies pegadas
 CN 地毯滚筒

38x75 mm

370 mm

RUBBER GUMA

STEEL STAL



YATO	Roller size / Rozmiar walka [mm]	L [mm]	
YT-44151	38x75	370	6/24

EN Pressure roller for use in bonding and laminating
 PL Walek do silnego dociskania klejonych powierzchni
 DE Andruckrolle zum starken Andrücken auf geklebte Oberflächen
 RU Ролик для сильного прижима приклеенных поверхностей
 CZ Váleček pro silné přitlačení lepených povrchů
 HU Henger ragasztott felületek erős lenyomásához
 RO Rola pt. lipit si laminat
 FR Rouleau à lisser
 IT Rullo pressore per superfici difficili da incollare
 ES Rodillo para apretar superficies pegadas
 CN 地毯滚筒

38x190 mm

450-690 mm

RUBBER GUMA

STEEL STAL



YATO	Roller size / Rozmiar walka [mm]	L [mm]	
YT-44152	38x190	450-690	6

EN Stainless steel cable ties
 PL Opaski zaciskowe ze stali nierdzewnej
 DE Edelstahl-Kabelbinder
 RU Хомуты из нержавеющей стали
 CZ Nadicové svorky z nerezové oceli
 HU Rozsdamentes acél kábelkötélgő

RO Coliere metalice reglabile
 FR Colliers de serrage en acier inoxydable
 IT Fascette in acciaio inossidabile
 ES Abrazaderas de acero inoxidable
 CN 不锈钢扎带



SS201
 STAINLESS STEEL
 STAL NIERDZEWNA

YATO	Size / Rozmiar [mm]	pcs / szt.	
YT-70560	4.6x125	100	100
YT-70561	4.6x200	100	100
YT-70562	4.6x250	100	50
YT-70563	4.6x300	100	50
YT-70564	4.6x350	100	50
YT-70565	4.6x400	100	50

YATO	Size / Rozmiar [mm]	pcs / szt.	
YT-70566	4.6x450	100	50
YT-70567	4.6x500	100	50
YT-70580	8.0x200	50	80
YT-70581	8.0x250	50	80
YT-70582	8.0x300	50	60
YT-70583	8.0x350	50	60

YATO	Size / Rozmiar [mm]	pcs / szt.	
YT-70584	8.0x400	50	50
YT-70585	8.0x450	50	50
YT-70586	8.0x500	50	50
YT-70587	8.0x550	50	50
YT-70588	8.0x600	50	40

EN Cable ties
 PL Opaski plastikowe
 DE Kabelbinder

RU Кабельные стяжки пластиковые
 CZ Stahovací pásy plastové
 HU Kábelkötélgők

RO Set coliere din plastic
 FR Attaches de câble
 IT Fascette di plastica

ES Bridas de plástico
 CN 尼龙扎带

50 PCS

PA66

UL94 V-2

JUV



YATO	Size / Rozmiar [mm]	Max. tensile strength / Maks. odporność na zrywanie [kg]	Max. wire bundle diameter / Maks. średnica wiązki kabli [mm]	pcs / szt.	
YT-70630	7.6x200	55	50	50	75/150
YT-70631	7.6x300	55	80	50	50/100
YT-70632	7.6x350	55	90	50	50/100
YT-70633	7.6x400	55	105	50	50/100
YT-70634	7.6x430	55	105	50	50/100
YT-70635	7.6x500	55	145	50	40/80
YT-70636	9.0x450	80	108	50	30/60
YT-70637	9.0x550	80	160	50	25/50
YT-70638	9.0x700	80	195	50	20/40
YT-70639	12.6x760	114	205	50	10/20

YATO	Size / Rozmiar [mm]	Max. tensile strength / Maks. odporność na zrywanie [kg]	Max. wire bundle diameter / Maks. średnica wiązki kabli [mm]	pcs / szt.	
YT-70650	7.6x200	55	50	50	75/150
YT-70651	7.6x300	55	80	50	50/100
YT-70652	7.6x350	55	90	50	50/100
YT-70653	7.6x400	55	105	50	50/100
YT-70654	7.6x430	55	105	50	50/100
YT-70655	7.6x500	55	145	50	40/80
YT-70656	9.0x450	80	108	50	30/60
YT-70657	9.0x550	80	160	50	25/50
YT-70658	9.0x700	80	195	50	20/40
YT-70659	12.6x760	114	205	50	10/20

EN Releasable cable ties
 PL Opaski plastikowe rozpinane
 DE Wiederverwendbare Kabelbinder

CZ Kabelové stahovací pásy odnímatelné
 HU Nyitható kábelkötélgők
 RO Colier plastic reutilizabil
 FR Attaches de câble amovibles

IT Fascette riapribili in plastica
 ES Bridas para cables reutilizables
 CN 尼龙扎带

PA66

UL94 V-2

JUV



YATO	Size / Rozmiar [mm]	Max. tensile strength / Maks. odporność na zrywanie [kg]	Max. wire bundle diameter / Maks. średnica wiązki kabli [mm]	pcs / szt.	
YT-70660	3.6x150	12	35	100	100/200
YT-70661	4.8x200	18	45	100	50/100
YT-70662	7.6x150	15	35	50	75/150
YT-70663	7.6x200	20	45	50	75/150
YT-70664	7.6x250	22	60	50	75/150
YT-70665	7.6x300	22	75	50	50/100
YT-70666	7.6x350	22	85	50	50/100
YT-70667	7.6x400	22	100	50	50/100
YT-70668	7.6x450	22	125	50	35/70

YATO	Size / Rozmiar [mm]	Max. tensile strength / Maks. odporność na zrywanie [kg]	Max. wire bundle diameter / Maks. średnica wiązki kabli [mm]	pcs / szt.	
YT-70670	3.6x150	12	35	100	100/200
YT-70671	4.8x200	18	45	100	50/100
YT-70672	7.6x150	15	35	50	75/150
YT-70673	7.6x200	20	45	50	75/150
YT-70674	7.6x250	22	60	50	75/150
YT-70675	7.6x300	22	75	50	50/100
YT-70676	7.6x350	22	85	50	50/100
YT-70677	7.6x400	22	100	50	50/100
YT-70678	7.6x450	22	125	50	35/70

EN Gas torch
PL Palnik gazowy
DE Gasbrenner
RU Газовая горелка
CZ Plynový hořák
HU Gázégő
RO Arzător de gaz
FR Chalumeau à gaz
IT Saldatore bruciatore a gas
ES Soplete de gas
CN 火焰枪



PIEZO	0.7 kW
30 ml	60-90 min
GAS GAZ	BUTANE BUTAN
LIGHTER GAS GAZ DO ZAPALNICZEK	LOCK BLOKADA
CHILDREN PROTECTION ZABEZPECZENIE PRZED DZIECIAMI	



YATO	[kW]	
YT-36700	0.7	10/20

EN Gas torch
PL Palnik gazowy
DE Gasbrenner
RU Газовая горелка
CZ Plynový hořák
HU Gázégő
RO Arzător de gaz
FR Chalumeau à gaz
IT Saldatore bruciatore a gas
ES Soplete de gas
CN 火焰枪



PIEZO	0.2 kW
13.1 g/h	
BUTANE BUTAN	LIGHTER GAS GAZ DO ZAPALNICZEK
LOCK BLOKADA	CHILDREN PROTECTION ZABEZPECZENIE PRZED DZIECIAMI

YATO	[kW]	
YT-36725	0.2	50

EN Gas torch
PL Palnik gazowy
DE Gasbrenner
RU Газовая горелка
CZ Plynový hořák
HU Gázégő
RO Arzător de gaz
FR Chalumeau à gaz
IT Saldatore bruciatore a gas
ES Soplete de gas
CN 火焰枪



PIEZO	0.4 kW
29 g/h	1350 °C
GAS GAZ	BUTANE BUTAN
LOCK BLOKADA	

YATO	[kW]	
YT-36726	0.4	10/40

EN Gas torch
PL Palnik gazowy
DE Gasbrenner
RU Газовая горелка
CZ Plynový hořák
HU Gázégő
RO Arzător de gaz
FR Chalumeau à gaz
IT Saldatore bruciatore a gas
ES Soplete de gas
CN 火焰枪



PIEZO	0.13 kW
9.5 g/h	1350 °C
GAS GAZ	BUTANE BUTAN
LOCK BLOKADA	

YATO	[kW]	
YT-36727	0.13	10/50

EN Gas blow torch
PL Palnik gazowy
DE Lötbrenner
RU Газовая горелка
CZ Plynový hořák
HU Gázégő

RO Arzator pe gaz
FR Chalumeau à gaz
IT Saldatore bruciatore a gas
ES Soplete de gas
CN 喷枪

PIEZO	1.7 kW	123 g/h
GAS GAZ	BUTANE BUTAN	



YATO	[kW]	
YT-36711	1.7	40

EN Gas soldering lamp
PL Gazowa lampa lutownicza
DE Gaslötlampe
RU Газовая паяльная лампа
CZ Plynová pájecí lampa
HU Gázos forrasztólámpa

RO Lampă de lipit pe gaz
FR Lampe à souder
IT Lampada per saldare a gas
ES Lampa de gas para soldar
CN 喷灯

PIEZO	1.7 kW	123 g/h
GAS GAZ	BUTANE BUTAN	



EURO TYPE EN417



YATO	[kW]	
YT-36720	1.7	12

EN Soldering tool set
 PL Lutownica gazowa z akcesoriami
 DE Gaslötkolben Satz
 RU Газовый паяльный набор
 CZ Plynová pajka souprava
 HU Gaz forrasztópaka készletek

RO Set ciocan de lipit cu gaz
 FR Fer à souder à gaz
 IT Saldatore a gas
 ES Soldador a gas con accesorios
 CN 自动点火多功能瓦斯组套

7 PCS	PIEZO	30-125 W	30 ml	75 min	GAS GAZ	BUTANE BUTAN	PROPANE BUTANE PROPAN BUTAN	LIGHTER GAS GAZ DO ZAPALNICZEK	LOCK BLOKADA	CHILDREN PROTECTION DZIECIĘCIE PRZECI DOSTĘCIE	
----------	-------	-------------	----------	--------	------------	-----------------	--------------------------------------	---	-----------------	---	--

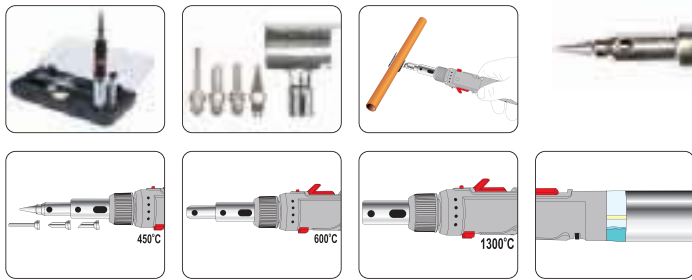

YATO	[W]	
YT-36706	30-125	6

EN Gas blow torch
 PL Palnik gazowy
 DE Lötbrenner
 RU Газовая горелка
 CZ Plynový hořák
 HU Gázégő
 RO Arzător de gaz
 FR Chalumeau à gaz
 IT Saldatore bruciatore a gas
 ES Soplete de gas
 CN 火焰枪

PIEZO	1.0 kW	73 g/h
GAS GAZ	BUTANE BUTAN	

EN Gas blow torch
 PL Palnik gazowy
 DE Lötbrenner
 RU Газовая горелка
 CZ Plynový hořák
 HU Gázégő
 RO Arzător de gaz
 FR Chalumeau à gaz
 IT Saldatore bruciatore a gas
 ES Soplete de gas
 CN 火焰枪

PIEZO	1.28 kW	GAS GAZ	AIR POWETRZE
LOCK BLOKADA	BUTANE BUTAN		



YATO	[kW]	
YT-36710	1	10/100

YATO	[kW]	
YT-36709	1.28	6/12

EN Turbo gas torch
 PL Palnik gazowy turbo
 DE Turbo-Handbrenner
 RU Газовая горелка турбо
 CZ Plynový hořák turbo
 HU Kézi gázégő
 RO Arzător cu gaz turbo
 FR Chalumeau à gaz
 IT Saldatore bruciatore a gas
 ES Quemador de gas turbo
 CN 手持式焊枪

PIEZO	2800 °C	2.0 kW	142 g/h	2.59 MPa
G1" F	GAS GAZ	PROPANE PROPAN	AUTO START STOP	LOCK BLOKADA
	CONTINUOUS RUN LOCK BLOKADA PRACY (CHABLE)	TURBO NOZZLE DYŹKA TURBO		

EN Gas blow torch
 PL Palnik gazowy
 DE Lötbrenner
 RU Газовая горелка
 CZ Plynový hořák
 HU Gázégő
 RO Arzător de gaz
 FR Chalumeau à gaz
 IT Saldatore bruciatore a gas
 ES Soplete de gas
 CN 喷枪

PIEZO	2.0 kW	145 g/h
GAS GAZ	BUTANE BUTAN	

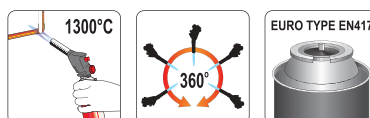

YATO	[kW]	
YT-36715	2	5/20

YATO	[kW]	
YT-36712	2	20/80

EN Blow torch
PL Lutownica gazowa dekarska
DE Gas-Dachdeckerlötkolben
RU Кровельный газовый паяльник
CZ Pokrývačská plynová pájka
HU Gázégő tetőfedő munkához
RO Ciocan de lipit cu gaz
FR Fer à souder couvreur
IT Cannello saldatore a gas per posa coperture tetti
ES Soldador a gas de tejás
CN 焊枪套装



YATO	[W]	L [mm]	
YT-36701	4	360	20

EN Soldering torch
PL Palnik do lutowania
DE Lötbrenner
RU Горелка для пайки
CZ Pájecí hořák
HU Forrasztópáka
RO Arzător pe gaz
FR Torche de soudage
IT Cannello di brasatura
ES Soplete de soldadura
CN 焊枪套装



YATO	[kW]	L [mm]	
YT-36730	4	360	20

EN Soldering torch
PL Palnik do lutowania
DE Lötbrenner
RU Горелка для пайки
CZ Pájecí hořák
HU Forrasztópáka

RO Arzător pe gaz
FR Torche de soudage
IT Cannello di brasatura
ES Soplete de soldadura
CN 焊枪套装



YATO	[kW]	L [mm]	
YT-36731	4	360	20

EN Roofing torch
PL Palnik dekarski
DE Dachdeckerbrenner
RU Горелка кровельная
CZ Pokrývačský hořák
HU Tetőfedő égő
RO Arzător pt. acoperiș
FR Outil à souder pour toiture
IT Cannello per posa coperture tetti
ES Antorcha de techo
CN 焊枪套装



YATO	[kW]	L [mm]	
YT-36740	8	370	10

EN Roofing torch
PL Palnik dekarski
DE Dachdeckerbrenner
RU Горелка кровельная
CZ Pokrývačský hořák
HU Tetőfedő égő
RO Arzător pt. acoperiș
FR Outil à souder pour toiture
IT Cannello per posa coperture tetti
ES Antorcha de techo
CN 焊枪套装



YATO	[kW]	L [mm]	
YT-36741	65	900	6

EN Weed burner
PL Palnik do wypalania chwastów
DE Unkrautbrenner
RU Горелка для выжигания сорняков
CZ Hořák na plevel
HU Gyomégető

RO Arzător pt. buruieni
FR Désherbeur thermique
IT Bruciatore di erbacce
ES Quemador de malezas
CN 除草炬

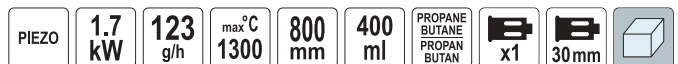

YATO	[kW]	L [mm]	
YT-36742	1.7	800	12

- EN Silicone soldering mat
- PL Mata silikonowa do lutowania
- DE Silikon-Lötmatte
- RU Силиконовый коврик для пайки
- CZ Silikonová podložka pro letování
- HU Szilikon forrasztóalátét
- RO Covoraș din silicon pt. lipit
- FR Tapis à souder en silicone
- IT Tappetino per saldatura in silicone
- ES Estera de soldadura de silicona
- CN 硅胶垫



YATO	Size / Rozmiar [mm]	
YT-82468	250x350	50
YT-82469	300x400	30

- EN Solvent dispenser with pump
- PL Butelka z dozownikiem z pompką
- DE Flasche mit Dosiereinrichtung mit Pumpe
- RU Бутылка с дозатором-насосом
- CZ Láhev s dávkovačem a pumpičkou
- HU Üveg pumpás adagolóval
- RO Dispenser pt. solventi
- FR Bouteille avec pompe
- IT Flacone dosatore a pompa
- ES Botella con dispensador y bomba
- CN 按压式酒精瓶



YATO	[ml]	
YT-82516	100	20/120

- EN Dust blower ball
- PL Gruszka do przedmuchiwania
- DE Blasebalg
- RU Груша для продувки
- CZ Hruška pro profukování
- HU Porfúvó
- RO Pompa suflat praful
- FR Poire de gonflage
- IT Bulbo soffiatore
- ES Pera sopladora
- CN 吹尘球



YATO	
YT-82512	30/180

- EN Soldering tips set
- PL Zestaw grtów do lutowania
- DE Lötspitzen-Satz
- RU Набор наконечников для паяльника
- CZ Sada pájecích hrotů
- HU Forrasztóhegy készlet
- RO Set vârfuri pt. ciocan de lipit
- FR Jeu de pannes de fer à souder
- IT Set di punte per saldatura
- ES Juego de puntas de soldadura
- CN 烙铁头件套



Tip types: T-1, T-B, T-K, T2.4D, T-2C, T-3C
Rodzaje grtów: T-1, T-B, T-K, T2.4D, T-2C, T-3C

YATO	
YT-82525	24/240

- EN Soldering tips set
- PL Zestaw grtów do lutowania
- DE Lötspitzen-Satz
- RU Набор наконечников для паяльника
- CZ Sada pájecích hrotů
- HU Forrasztóhegy készlet
- RO Set vârfuri pt. ciocan de lipit
- FR Jeu de pannes de fer à souder
- IT Set di punte per saldatura
- ES Juego de puntas de soldadura
- CN 烙铁头件套



Tip types: T-1, T-B, T-K, T-1.2D, T2.4D, T-3.2D, T-1C, T-2C, T-3C
Rodzaje grtów: T-1, T-B, T-K, T-1.2D, T2.4D, T-3.2D, T-1C, T-2C, T-3C

YATO	
YT-82526	24/240

- EN Soldering iron tip
- PL Grot lutowniczy
- DE Lötspitze
- RU Наконечник для паяльника
- CZ Pájecí hrot
- HU Forrasztóhegy
- RO Vârf rezervă pt. ciocan de lipit
- FR Panne de fer à souder
- IT Punta per saldatura
- ES Punta de soldadura
- CN 烙铁头

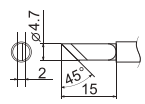

K

YATO	
YT-82491	100/600

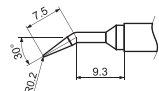

JL02

YATO	
YT-82492	100/600

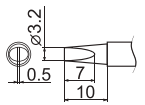

D32

YATO	
YT-82493	100/600

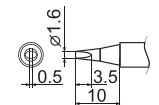

D16

YATO	
YT-82494	100/600

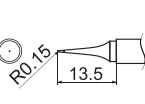

ILS

YATO	
YT-82495	100/600

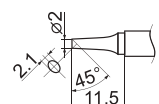

BC2

YATO	
YT-82496	100/600

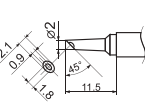

BCM2

YATO	
YT-82497	100/600

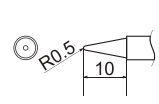

B2

YATO	
YT-82498	100/600

EN Sponge for soldering station
PL Gąbka do stacji lutowniczej
DE Schwamm für Lötstation
RU Губка для паяльной станции
CZ Houbička do pájecí stanice
HU Szivacs forrasztóállomáshoz
RO Burete pt. statia de lipit
FR Éponge pour station de soudage
IT Spugna per stazione di saldatura
ES Esponja para la estación de soldadura
CN 烙铁头清洁海绵

3
PCS



YT-82467



40/800

EN Solder tip cleaner brass wire
PL Czystać do grtów z mosiężnymi wiórami
DE Lötspitzen-Reiniger - Messingspäne
RU Очиститель паяльных жал, латунная стружка
CZ Čistič hrotů mosazné hobliny
HU Pákahegy tisztító rézforgács
RO Burete de sarmă pt. curățare vâră ciocan de lipit
FR Boule de nettoyage à copeaux de laiton
IT Pulitore per punte, trucioli in ottone
ES Alambre de latón para limpieza de puntas de soldadura
CN 烙铁头除锡球+锡渣盒

BRASS
MOSIADZ



YT-82510



30/120

EN Hot air nozzles
PL Zestaw dysz do gorącego powietrza
DE Heißluftdüsen
RU Комплект форсунок для горячего воздуха
CZ Sada horkovzdušných trysek
HU Forró levegő fúvókakészlet
RO Duze pt. stație de lipit cu aer cald
FR Jeu de buses à air chaud
IT Set di ugelli per aria calda
ES Juego de boquillas para aire caliente
CN 风咀4件套

4
PCS

12 mm

4.4 mm

8.0 mm

10 mm



YT-82520



50/300

EN Vacuum pen
PL Chwytak próżniowy
DE Vakuumgreifer
RU Вакуумный захват
CZ Vakuové čapadlo
HU Vákuumos alkatrész fogó

RO Pompă de vid pt. lipire
FR Pince à vide
IT Utensile da presa a vuoto
ES Pluma de succión de bomba de vacío
CN 防静电真空吸笔

3.0 mm

6.0 mm

10 mm

150 mm



YT-82514

L [mm]

150



12/240

EN Heat resistant tape
PL Taśma kaptonowa
DE Kapton-Band
RU Каптоновая лента
CZ Kaptonová páska
HU Kapton szalag
RO Banda termorezistentă
FR Bande kapton
IT Nastro kapton
ES Cinta kapton
CN 防焊高温胶带

300 °C



W [mm]

L [m]



YT-82540

5

33

110/440

YT-82541

10

33

64/256

YT-82542

20

33

32/128

EN Soldering iron with temperature adjustment
PL Lutownica z regulacją temperatury
DE Temperaturgesteuerter LötKolben
RU Паяльник с терморегулятором
CZ Pájka s regulací teploty
HU Hőszabályozós forrasztó

RO Letcon cu reglaj de temperatura
FR Fer à souder à température réglée
IT Saldatore con temperatura regolabile
ES Soldador con ajuste de temperatura
CN 调温电烙铁

220-240V~
50Hz

50 W

200-450 °C

+/- 25 °C

900M



• Constant tip temperature control

• Stały odczyt temperatury grata



[W]

[°C]



YT-82700

50

200-450

10/100

EN Soldering iron with temperature adjustment
PL Lutownica z regulacją temperatury
DE Temperaturgesteuerter LötKolben
RU Паяльник с терморегулятором
CZ Pájka s regulací teploty
HU Hőszabályozós forrasztó

RO Letcon cu reglaj de temperatura
FR Fer à souder à température réglée
IT Saldatore con temperatura regolabile
ES Soldador con ajuste de temperatura
CN 数显电烙铁

220-240V~
50Hz

80 W

50-480 °C

+/- 2 °C

900M

LCD
BACKLIGHT
POSSIBILITÀ



• Constant tip temperature control

• Temperature calibration function

• Stały odczyt temperatury grata

• Funkcja kalibracji temperatury



[W]

[°C]



YT-82701

80

50-480

10/50

- EN Soldering iron
- PL Lutownica oporowa
- DE LötKolben
- RU Электропаяльник
- CZ Pájka odporová
- HU Forrasztópáka
- RO Ciocan de lipit
- FR Fer à souder
- IT Saldatore a stagno
- ES Soldador de resistencia
- CN 电烙铁



230V~
50Hz

2-3 min

YATO	[W]	[°C]	[mm]	
YT-8271	30	400	Ø3.8x73	16
YT-8272	60	500	Ø5.8x85	16
YT-8273	80	520	Ø6.8x95	16

- EN Desoldering pump
- PL Odsyszac do cyny
- DE Entlötlaugepumpe
- RU Шприц для удаления припоя
- CZ Odpájecí sací pumpa
- HU Önszippantó
- RO Pompa fluidor
- FR Pompe à dessouder
- IT Pompa aspira stagno
- ES Bomba desoldadora
- CN 手动吸锡器

PTFE



YATO

YT-82742

100/400



YATO

YT-82743

100/200



YATO

YT-82744

50/100

- EN Solder wick
- PL Taśma rozlutownicza, plecionka miedziana
- DE Lötloch - Kupfergeflecht
- RU Лента для удаления припоя, медная оплетка
- CZ Odpájecí páska, mědný svazek
- HU Fonott réz kiforrasztó huzal
- RO Bandă îndepărtare exces de cositor
- FR Bande de soudure en cuivre toronné
- IT Nastro dissaldante, treccia rame
- ES Cinta desoldadora trenza de cobre
- CN 吸锡带

COPPER
MIEDZ



- EN Magnifying glass with LED light
- PL Lupa z podświetleniem LED
- DE Lupe mit LED-Licht
- RU Лупа с LED подсветкой
- CZ Lupa s LED osvětlením
- HU Nagyító LED világítással
- RO Lupă
- FR Loupe avec éclairage LED
- IT Lente d'ingrandimento con luce LED
- ES Lupa con iluminación LED
- CN 放大镜

3x
Ø 75mm

45x
Ø 20mm

LED

UV
LED

3x
AAA I



Battery not included
Baterii nie dołączono

YATO

YT-73845

10/120

- EN Magnifier
- PL Szkló powiększające
- DE Vergrößerungsglas
- RU Увеличительное стекло
- CZ Lupa
- HU Nagyító üveg
- RO Lupă
- FR Loupe
- IT Lente d'ingrandimento
- ES Lupa de mano
- CN 放大镜

4x
Ø 75mm



YATO

YT-73855

10/120

- EN Helping hand with magnifying glass
- PL Zestaw „trzecia ręka” z lupą
- DE Dritte Hand mit Lupe
- RU Комплект „третья ручка” с лупой
- CZ Držák třetí ruka s lupou
- HU Paneltartó állvány „harmadik kéz”
- RO Lupă cu suport reglabil
- FR Troisième main avec loupe
- IT Supporto terza mano con lente d'ingrandimento
- ES Tercera mano con lupa
- CN 放大镜

3x
Ø 75mm

4.5x
Ø 20mm

10
LED

USB
POWERED
ZASILANE

3x
AAA I

COB
LED



Battery not included
Baterii nie dołączono

YATO

YT-73861

20

EN Transformer soldering gun
PL Lutownica transformatorowa
DE Lötpistole
RU Электрический паяльник
CZ Transformátorová páječka
HU Forrasztópáka

RO Pistol de lipit
FR Fer à souder transformateur
IT Saldatore istantaneo
ES Soldador transformador
CN 焊枪

220-240V~50Hz
180 W
0-600 °C
S2 20%
WORKING MODE
TYTUŁ PRACY
LED
LIGHTING
OSWIELENIE



YATO	[W]	[°C]	
YT-8245	180	0-600	10

EN Soldering station
PL Stacja lutownicza
DE Lötstation
RU Паяльная станция
CZ Letovací stanice
HU Forrasztópáka állomás
RO Stație de lipit
FR Station de soudage
IT Stazione di saldatura
ES Estación de soldadura
CN 焊台

- Constant tip temperature control
- Temperature calibration function
- Auto sleep 1-240 min
- Stały odczyt temperatury grota
- Funkcja kalibracji temperatury
- Automatyczny tryb czuwania 1-240 min

220-240V~50Hz
75 W
200-480 °C
+/- 1 °C
900M
LCD
BACKLIGHT
POŚWIETLENIE
ESD
SAFE
USB
BATTERY CHARGER
ŁADOWNIKA



YATO	[W]	[°C]	
YT-82456	75	200-480	8

EN Soldering station
PL Stacja lutownicza
DE Lötstation
RU Паяльная станция
CZ Letovací stanice
HU Forrasztópáka állomás
RO Stație de lipit
FR Station de soudage
IT Stazione di saldatura
ES Estación de soldadura
CN 焊台

220-240V~50Hz
70 W
200-480 °C
+/- 1 °C
900M
LED
DISPLAY
WYŚWIETLACZ
ESD
SAFE

- Constant tip temperature control
- Auto sleep 1-99 min
- Auto power off function 1-99 min
- Stały odczyt temperatury grota
- Automatyczny tryb czuwania 1-99 min
- Automatyczne wyłączenie urządzenia 1-99 min



YATO	[W]	[°C]	
YT-82459	70	200-480	8

EN Transformer soldering gun
PL Lutownica transformatorowa
DE Lötpistole
RU Электрический паяльник
CZ Transformátorová páječka
HU Forrasztópáka

RO Pistol de lipit
FR Fer à souder transformateur
IT Saldatore istantaneo
ES Soldador transformador
CN 焊枪

230-240V~50Hz
200 W
S2 20%
WORKING MODE
TYTUŁ PRACY
LED
LIGHTING
OSWIELENIE



YATO	[W]	[°C]	
YT-82451	200	70-200, 201-350, 351-500	10

EN Hot air soldering station
PL Stacja lutownicza hot air
DE Heißluft-Lötstation
RU Термовоздушная паяльная станция
CZ Horkovzdušná pájecí stanice
HU Hot air forrasztóállomás
RO Stație de lipit cu aer cald
FR Station de soudage à air chaud
IT Stazione di saldatura Hot Air
ES Estación de soldadura hot air
CN 热风拆焊台

- Brushless motor fan
- Auto sleep 0-240 min
- Auto power off function
- Build-in position sensor
- Bezszczotkowy wentylator
- Automatyczny tryb czuwania
- Automatyczne wyłączenie urządzenia
- Czujnik odłożenia grzałki

220-240V~50Hz
750 W
100-500 °C
+/- 2 °C
120 l/min
LED
DISPLAY
WYŚWIETLACZ
ESD
SAFE



YATO	[W]	[°C]	
YT-82457	750	100-500	8

EN 2 in 1 hot air soldering station
PL 2 w 1 stacja lutownicza hot air
DE 2 in 1 Heißluft-Lötstation
RU Термовоздушная паяльная станция 2 в 1
CZ Horkovzdušná pájecí stanice 2 v 1
HU 2 az 1-ben hot air forrasztóállomás
RO Stație de lipit, 2 in 1, cu aer cald
FR Station de soudage à air chaud 2 en 1
IT 2 in 1 stazione di saldatura hot air
ES 2 en 1 estación de soldadura hot air
CN 热风拆焊台

- Constant tip temperature control
- Brushless motor fan
- Auto sleep 0-240 min
- Auto power off function
- Build-in position sensor
- Stały odczyt temperatury grota
- Bezszczotkowy wentylator
- Automatyczny tryb czuwania
- Automatyczne wyłączenie urządzenia
- Czujnik odłożenia grzałki

220-240V~50Hz
750 W
100-480 °C
+/- 2 °C
120 l/min
75 W
200-480 °C
+/- 1 °C
900M
LED
DISPLAY
WYŚWIETLACZ
ESD
SAFE



YATO	[W]	[°C]	
YT-82458	75 (lutownica), 750 (dmuchawa hot air)	200-480 (lutownica), 100-480 (dmuchawa hot air)	6

EN Soldering station
 PL Stacja lutownicza
 DE Lötstation
 RU Паяльная станция
 CZ Letovací stanice
 HU Forrasztópáka állomás
 RO Stație de lipit
 FR Station de soudage
 IT Stazione di saldatura
 ES Estación de soldadura
 CN 焊台

220-240V-50/60Hz 60 W 90-480 °C +/- 2 °C 900M LED DISPLAY WYSWIETLACZ



- Constant tip temperature control
- Auto sleep 10 min
- Stały odczyt temperatury grotła
- Automatyczny tryb czuwania 10 min

YATO	[W]	[°C]	
YT-82460	60	90-480	16

EN Portable digital soldering iron
 PL Przenośna lutownica cyfrowa
 DE Tragbarer digitaler Lötkeißen
 RU Портативный цифровой паяльник
 CZ Přenosná digitální páječka
 HU Hordozható digitális forrasztópáka
 RO Ciocan de lipit portabil cu display
 FR Fer à souder numérique portable
 IT Saldatore digitale portatile
 ES Soldador digital portátil
 CN 电烙铁

9-24 V 18-65 W QC/PD 90-480 °C +/- 2 °C T12 OLED AUTO SLEEP HIBERNACIJA TEMPERATURE CALIBRATION KALIBRACIJA TEMPERATURY USB



YATO	[W]	[°C]	
YT-82490	18-65	90-480	50

EN Soldering station
 PL Stacja lutownicza
 DE Lötstation
 RU Паяльная станция
 CZ Letovací stanice
 HU Forrasztópáka állomás

RO Stație de lipit
 FR Station de soudage
 IT Stazione di saldatura
 ES Estación de soldadura
 CN 焊台



- Temperature calibration function
- Funkcja kalibracji temperatury

110-240V-50-60Hz 75 W 90-480 °C +/- 2 °C T12 LCD x3 MEMORY PARAMS AUTO SLEEP HIBERNACIJA TEMPERATURE CALIBRATION KALIBRACIJA TEMPERATURY

YATO	[W]	[°C]	
YT-82462	75	90-480	12

EN Soldering station
 PL Stacja lutownicza
 DE Lötstation
 RU Паяльная станция
 CZ Letovací stanice
 HU Forrasztópáka állomás

RO Stație de lipit
 FR Station de soudage
 IT Stazione di saldatura
 ES Estación de soldadura
 CN 焊台



- Constant tip temperature control
- Temperature calibration function
- Stały odczyt temperatury grotła
- Funkcja kalibracji temperatury

110-240V-50-60Hz 75 W 90-480 °C +/- 2 °C T12 LED DISPLAY WYSWIETLACZ

YATO	[W]	[°C]	
YT-82461	75	90-480	30

EN Portable spot welder
 PL Przenośna zgrzewarka do ognia
 DE Tragbares Punktschweißgerät
 RU Портативный аппарат для точечной сварки
 CZ Přenosná bodová svářečka
 HU Hordozható ponthegesztő gép
 RO Aparat de sudură în puncte portabil
 FR Soudeuse par points portable
 IT Saldatrice a punti portatile
 ES Soldador por puntos portátil
 CN 便携式点焊机



1-10 A 500 A FeNi max 0.2mm 99%Ni max 0.15mm USB 5V/2A 6300 mAh LI-PO

YATO			
YT-82507			30

EN Glue sticks
PL Wkłady klejowe
DE Heissklebepatronen
RU Стержни для горячей склейки

CZ Lepicí tyčinky
HU Ragasztópisztoly betét
RO Batoane adeziv
FR Bâtons de colle pour pistolet

IT Stick di colla
ES Barras de cola
CN 热熔胶棒

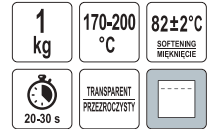

∅ 11mm
200mm

∅ 11mm
300mm

YATO	∅ [mm]	L [mm]	
YT-82430	11	200	20

YATO	∅ [mm]	L [mm]	
YT-82431	11	300	20

EN Glue sticks
PL Wkłady klejowe
DE Heissklebepatronen
RU Стержни для горячей склейки
CZ Lepicí tyčinky
HU Ragasztópisztoly betét

RO Batoane adeziv
FR Bâtons de colle pour pistolet
IT Stick di colla
ES Barras de cola
CN 热熔胶棒

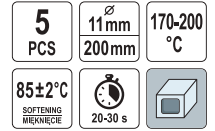

YATO	Color / Kolor	∅ [mm]	L [mm]	
YT-82433	czarny	11	200	40/120
YT-82434	czerwony	11	200	40/120
YT-82435	niebieski	11	200	40/120
YT-82436	zielony	11	200	40/120

YATO	Color / Kolor	∅ [mm]	L [mm]	
YT-82437	żółty	11	200	40/120
YT-82438	biały	11	200	40/120
YT-82439	brazowy	11	200	40/120

EN Glue sticks
PL Wkłady klejowe
DE Heissklebepatronen
RU Стержни для горячей склейки
CZ Lepicí tyčinky
HU Ragasztópisztoly betét

RO Batoane adeziv
FR Bâtons de colle pour pistolet
IT Stick di colla
ES Barras de cola
CN 热熔胶棒



YATO	Color / Kolor	∅ [mm]	L [mm]	
YT-82440	bezbarny	7.2	200	30/120

EN Glue sticks
PL Wkłady klejowe
DE Heissklebepatronen
RU Стержни для горячей склейки
CZ Lepicí tyčinky
HU Ragasztópisztoly betét

RO Batoane adeziv
FR Bâtons de colle pour pistolet
IT Stick di colla
ES Barras de cola
CN 热熔胶棒

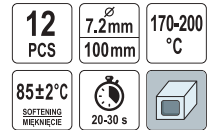
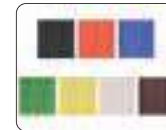

YATO	Color / Kolor	∅ [mm]	L [mm]	
YT-82441	czarny	7.2	100	50/200
YT-82442	czerwony	7.2	100	50/200
YT-82443	niebieski	7.2	100	50/200
YT-82444	zielony	7.2	100	50/200

YATO	Color / Kolor	∅ [mm]	L [mm]	
YT-82445	żółty	7.2	100	50/200
YT-82446	biały	7.2	100	50/200
YT-82447	brazowy	7.2	100	50/200

EN Plastic welding rods
PL Wkłady do spawania plastiku
DE Kunststoffschweißdrähte
RU Прутки для сварки пластика

CZ Tyčinky pro svařování plastů
HU Műanyag hegesztő pálcá
RO Liant pt. lipit
FR Tiges de soudure plastique

IT Bacchette per saldatura del materiale plastico
ES Cartuchos para soldar plástico
CN 塑料焊条



300 °C PP

270-300 °C PE

YATO	Size / Rozmiar [mm]	L [m]	
YT-82303	2.5x5	1	30/120

YATO	Size / Rozmiar [mm]	L [m]	
YT-82304	2.5x5	1	30/120



350 °C ABS

300-400 °C PVC

300 °C PPR

YATO	Size / Rozmiar [mm]	L [m]	
YT-82305	2.5x5	1	30/120

YATO	Size / Rozmiar [mm]	L [m]	
YT-82306	2.5x5	1	30/120

YATO	Size / Rozmiar [mm]	L [m]	
YT-82307	2.5x5	1	30/120

- EN Kitchen worktop jig
- PL Szablon do łączenia blatów
- DE Frässhablone Arbeitsplatte
- RU Шаблон для кухонных столешниц
- CZ Šablona pro spoj kuchyňských desek
- HU Munkalap összemaró sablon
- RO Șablon
- FR Gabarit de profilage pour plans de travail
- IT Sistema di giunzioni per piani da cucina
- ES Plantilla para el fresado de encimeras
- CN 木工模板



1000x390 x53 mm	max 700 mm	HARDENED LAMINATE UTWARDZANY	
-----------------------	------------------	------------------------------------	--

YATO	Dimensions / Wymiary [mm]	
YT-70890	1000x390x12	5

- EN Dovetail marker
- PL Szablon do trasowania "jaskółczy ogon"
- DE Schwalbenschwanz-Schablone
- RU Шаблон ласточкин хвост
- CZ Rybinová šablona
- HU Fecskefarag fogazó sablon
- RO Sablon coada de randunica
- FR Gabarit à queue d'aronde
- IT Marcatore a coda di rondine
- ES Plantilla cola de milano
- CN 木工定位器



64x23 x18 mm	AI	
--------------------	-----------	--

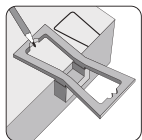

YATO	Dimensions / Wymiary [mm]	
YT-44080	64x23x18	50/200

- EN Tine milling template
- PL Szablon frezarski do połączeń na jaskółczy ogon
- DE Zinkenfrässhablone
- RU Шиповое приспособление для соединения "ласточкин хвост"
- CZ Cinkovací přípravek
- HU Csapoló készülék
- RO Sablon pt. imbinari coada de randunica
- FR Gabarit pour assemblages à queues d'aronde
- IT Dima per fresatura per collegamenti a coda di rondine
- ES Plantilla para juntas cola milano
- CN 开榫机

max 300 mm	max 8-32mm +		
------------------	--------------------	--	--



YATO	Dimensions / Wymiary [mm]	
YT-44085		2

- EN Hinge hole drilling guide locator
- PL Szablon do osadzania zawiasów
- DE Scharnier-Montageschablone
- RU Шаблон для установки петель
- CZ Šablona pro montáž závěsů
- HU Zsanér sablon
- RO Șablon pt. balamale
- FR Gabarit de perçage pour charnières
- IT Dima di traccia per cerniere
- ES Plantilla para bisagras
- CN 定位器

85x40 x22 mm	ABS	
--------------------	------------	--



YATO	Dimensions / Wymiary [mm]	
YT-44135	85x40x22	50/200

- EN Dovetail marker
- PL Szablon do trasowania "jaskółczy ogon"
- DE Schwalbenschwanz-Schablone
- RU Шаблон ласточкин хвост
- CZ Rybinová šablona
- HU Fecskefarag fogazó sablon
- RO Sablon coada de randunica
- FR Gabarit à queue d'aronde
- IT Marcatore a coda di rondine
- ES Plantilla cola de milano
- CN 木工定位器



64x23 x18 mm	AI	
--------------------	-----------	--

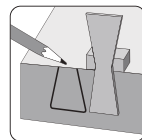

YATO	Dimensions / Wymiary [mm]	
YT-44081	64x23x18	50/200

- EN Aluminium alloy scriber gauge
- PL Przymiar traserski stolarski
- DE Anreißschablone für Schreiner
- RU Линейка для разметки и столярных работ
- CZ Rýsovací a tesafské pravítko
- HU Asztalos sablon
- RO Sablon din aluminiu
- FR Gabarit de pose charpentier
- IT Righello per falegnameria
- ES Regla de carpintería
- CN 木工划线器

60x45 x45 mm	AI	
--------------------	-----------	--

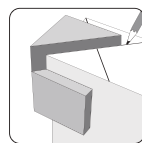

YATO	Dimensions / Wymiary [mm]	
YT-44087	60x45x45	50/200

- EN Hinge hole drilling guide locator
- PL Szablon do osadzania zawiasów
- DE Scharnier-Montageschablone
- RU Шаблон для установки петель
- CZ Šablona pro montáž závěsů
- HU Zsanér sablon
- RO Șablon pt. balamale
- FR Gabarit de perçage pour charnières
- IT Dima di traccia per cerniere
- ES Plantilla para bisagras
- CN 定位器

270x55 x3.6 mm	ABS	
----------------------	------------	--



YATO	Dimensions / Wymiary [mm]	
YT-44136	270x55x3.6	50/200

Memo



13

Construction tools
Narzędzia budowlane



Floor laminate cutters & accessories
Gilotyny do cięcia paneli podłogowych i akcesoria
288 

Scaffolds
Rusztowania
305 

Floor plank cutters
Gilotyny do cięcia wykładzin
288 

Straight pliers
Kleszcze do gięcia blach
305 

Tile cutting machines & accessories
Przyrządy do cięcia glazury i akcesoria
289-292 

Roofwork tools
Narzędzia dekarские
306 

Jigs & patterns
Wzorniki i szablony
292-293 

Paving tools
Narzędzia brukarskie
306-307 

Scrapers & accessories
Szpachelki i akcesoria
293-295 

Floating rules
Łaty
307 

Masonry tools
Narzędzia tynkarskie i murarskie
295-300 

Knives
Noże
307 

Floats
Pace 295
Trowels
Kielnie 298
Plaster scrubbers
Zdzieraki do tynków 299
Mortar guns
Wyciskacze do zapraw 299
Plaster & stucco spray guns
Tynkownice pneumatyczne 299
Finishing work tools
Narzędzia do prac wykończeniowych 299

Electric hoists
Elektryczne wciągarki linowe
308 

Mixers
Mieszadła
308-309 

Painting tools
Narzędzia malarskie
301-302 

Suction lifters
Uchwyty do szyb
309-311 

Paint brushes
Pędzle 301
Painting bowls
Kuwety malarskie 302
Painting mixers
Mieszadła do farb 302
Painting buckets
Wiadra malarskie 302
Painting sheets
Folie malarskie 302

Pencils & chalks
Ołówki i kredy
311-312 

Pencils
Ołówki 311
Chalks
Kredy 312

Tools for drywalls
Narzędzia do płyt gipsowo-kartonowych
302-305 

EN Floor laminate cutter
 PL Gilotylna do cięcia paneli podłogowych
 DE Laminatschneider
 RU Резак для ламината
 CZ Rezačka na laminátové podlahy
 HU Laminált padló vágógép
 RO Aparat de tăiat parchet laminat
 FR Guillotine pour couper les panneaux
 IT Taglierina per laminati
 ES Guillotina para corte de laminados
 CN 木地板切割器

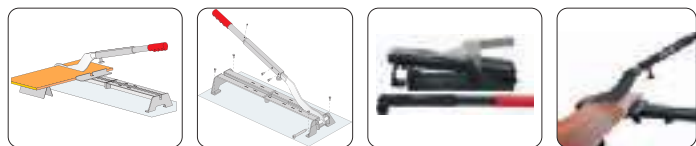

YATO **YAT-37301** 2

EN Floor laminate cutter
 PL Gilotylna do cięcia paneli podłogowych
 DE Laminatschneider
 RU Резак для ламината
 CZ Rezačka na laminátové podlahy
 HU Laminált padló vágógép
 RO Aparat de tăiat parchet laminat
 FR Guillotine pour couper les panneaux
 IT Taglierina per laminati
 ES Guillotina para corte de laminados
 CN 木地板切割器



• Application: parquet and vinyl flooring, VCT, PVC, rubber, foam
 • Zastosowanie: parkiety, panele winylowe, płytki winylowe, PVC, gumy, pianki

YATO **YAT-37303** 6

EN Deck board straightening tool
 PL Dociągacz desek podłogowych
 DE Terrassendielen-Richtwerkzeug
 RU Инструмент для стяжки досок пола
 CZ Montážní páka na podlahové desky
 HU Padlódeszka megkötő eszköz
 RO Dispozitiv pt. montaj scânduri de terasă
 FR Outil de redressage de plancher
 IT Attrezzo per installazione di pavimenti
 ES Herramienta para apretar tablas para suelos
 CN 甲板矫正工具

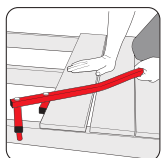

YATO **YAT-62930** L [mm] 670 10

EN Floor laminate cutter
 PL Gilotylna do cięcia paneli podłogowych
 DE Laminatschneider
 RU Резак для ламината
 CZ Rezačka na laminátové podlahy
 HU Laminált padló vágógép
 RO Aparat de tăiat parchet laminat
 FR Guillotine pour couper les panneaux
 IT Taglierina per laminati
 ES Guillotina para corte de laminados
 CN 木地板切割器

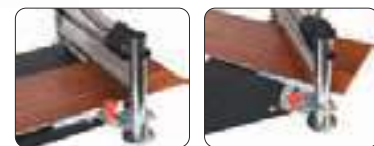

• Application: PVC, laminates, rubber, plastics
 • Zastosowanie: PVC, laminaty, gumy, tworzywa sztuczne

YATO **YAT-37311** L [mm] 600 2

EN Hardwood floor positioning tool
 PL Dociągacz desek podłogowych
 DE Parkett-Verlegewerkzeug
 RU Струбина для укладки ламината и паркета
 CZ Nářadí pro montáž podlah
 HU Laminált padló behúzóvas racsnis
 RO Dispozitiv fixare parchet
 FR Outil de redressage de plancher
 IT Attrezzo per installazione di pavimenti
 ES Conector de posicionamiento de pisos
 CN 地板安装器

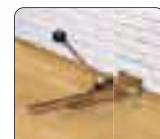
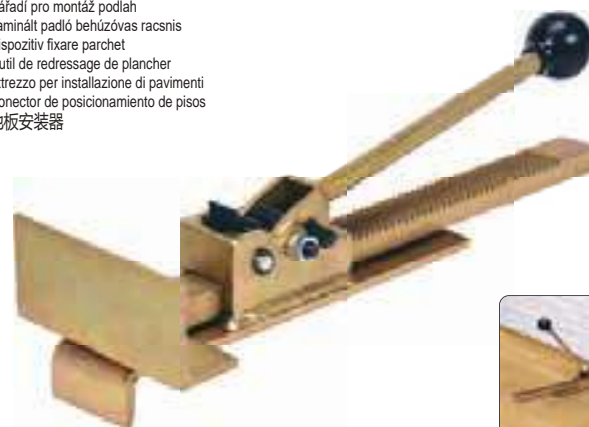

YATO **YAT-37317** L [mm] 420 6

EN Floor plank cutter
 PL Gilotylna do cięcia wykładzin z PVC
 DE PVC-Streifenschneider
 RU Гильотина для резки напольных покрытий из ПВХ
 CZ Gilotina pro řezání podlahových krytin z PVC
 HU PVC padló vágó kés
 RO Aparat tăiat parchet, mochetă și linoleum
 FR Coupe-bandes PVC
 IT Taglierino per rivestimenti in PVC
 ES Guillotina-cizalla para suelos de PVC
 CN 木地板切割器

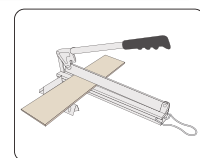



• Application: PVC, laminates, rubber, plastics
 • Zastosowanie: PVC, laminaty, gumy, tworzywa sztuczne

YATO **YAT-37325** 12

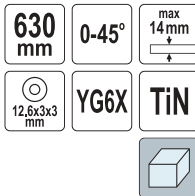
EN Tile cutter
PL Przyrząd do cięcia glazury
DE Fliesenschneider
RU Плиткорез
CZ Přístroj na řezání glazury
HU Csempévágó
RO Mașină pt. tăiat plăci ceramice
FR Coupeuse pour céramique
IT Taglierina per piastrelle
ES Cortadora de cerámica
CN 瓷砖切割器





YATO 	L [mm]	
YT-3703	630	2

EN Tile cutter
PL Przyrząd do cięcia glazury
DE Fliesenschneider
RU Плиткорез
CZ Přístroj na řezání glazury
HU Csempévágó

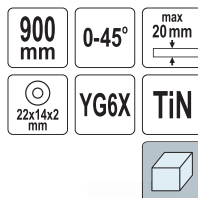
RO Mașină pt. tăiat plăci ceramice
FR Coupeuse pour céramique
IT Taglierina per piastrelle
ES Cortadora de cerámica
CN 瓷砖切割器



YATO 	L [mm]	
YT-3705	900	1

EN Tile cutting wheel
PL Kółko tnące wymienne
DE Schneiderrad
RU Ролик для плиткореза
CZ Výměnné kolečko
HU Cseregörgő csavarral

RO Cujiț rolă
FR Molette coupante avec barre
IT Lama di ricambio tondo
ES Recambio de cuchillo redondo
CN 瓷砖切割轮



For YT-3704, YT-3705, YT-3706, YT-3707, YT-3708
Dia YT-3704, YT-3705, YT-3706, YT-3707, YT-3708

YATO 	
YT-3714	50/200

EN Tile cutter
PL Przyrząd do cięcia glazury
DE Fliesenschneider
RU Плиткорез
CZ Přístroj na řezání glazury
HU Csempévágó

RO Mașină pt. tăiat plăci ceramice
FR Coupeuse pour céramique
IT Taglierina per piastrelle
ES Cortadora de cerámica
CN 瓷砖切割器

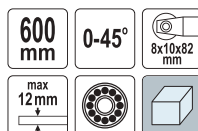



YATO 	L [mm]	
YT-37036	600	3

EN Tile cutting wheel
PL Kółko tnące wymienne
DE Schneiderrad
RU Ролик для плиткореза
CZ Výměnné kolečko
HU Cseregörgő csavarral

RO Cujiț rolă
FR Molette coupante avec barre
IT Lama di ricambio tondo
ES Recambio de cuchillo redondo
CN 瓷砖切割轮



For YT-3700, YT-3701, YT-3702
Dia YT-3700, YT-3701, YT-3702

YATO 	
YT-3712	50/250

EN Tile cutting wheel
PL Kółko tnące wymienne
DE Schneiderrad
RU Ролик для плиткореза
CZ Výměnné kolečko
HU Cseregörgő csavarral

RO Cujiț rolă
FR Molette coupante avec barre
IT Lama di ricambio tondo
ES Recambio de cuchillo redondo
CN 瓷砖切割轮





For YT-3703
Dia YT-3703

YATO 	
YT-3713	50/200

EN Tile cutter
PL Przyrząd do cięcia glazury
DE Fliesenschneider
RU Плиткорез
CZ Přístroj na řezání glazury
HU Csempévágó

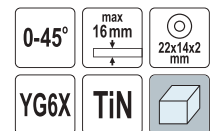
RO Mașină pt. tăiat plăci ceramice
FR Coupeuse pour céramique
IT Taglierina per piastrelle
ES Cortadora de cerámica
CN 瓷砖切割器



YATO 	L [mm]	
YT-3707	600	2
YT-3708	800	2

EN Tile cutting wheel
PL Kółko tnące wymienne
DE Schneiderrad
RU Ролик для плиткореза
CZ Výměnné kolečko
HU Cseregörgő csavarral

RO Cujiț rolă
FR Molette coupante avec barre
IT Lama di ricambio tondo
ES Recambio de cuchillo redondo
CN 瓷砖切割轮



For YT-3704, YT-3705, YT-3706, YT-3707, YT-3708
Dia YT-3704, YT-3705, YT-3706, YT-3707, YT-3708

YATO 	
YT-37141	50/200

EN Tile cutting wheel
PL Kółko tnące wymienne
DE Schneiderrad
RU Ролик для плиткореза



CZ Výměnné kolečko
HU Cseregörgő csavarral

RO Cujiț rolă
FR Molette coupante avec barre

IT Lama di ricambio tondo
ES Recambio de cuchillo redondo
CN 瓷砖切割轮



For YT-37034, YT-37036
Dia YT-37034, YT-37036

YATO 	
YT-37038	300

EN Tile cutter
 PL Przyrząd do cięcia glazury
 DE Fliesenschneider
 RU Плиткорез
 CZ Přístroj na řezání glazury
 HU Csempévágó

RO Mașină pt. tăiat plăci ceramice
 FR Coupeuse pour céramique
 IT Taglierina per piastrelle
 ES Cortadora de cerámica
 CN 瓷砖切割器

800 mm

0-45°

22x6x6 mm

max 12 mm



CLASS / KLASA

2x AAA I



YATO	L [mm]	
YT-37022	800	2

EN Tile cutting wheel
 PL Kółko tnące wymienne
 DE Schneiderrad
 RU Ролик для плиткореза
 CZ Výměnné kolečko
 HU Cseregörgő csavarral

RO Cuțit rolă
 FR Molette coupante
 IT Lama di ricambio tondo
 ES Recambio de cuchillo redondo
 CN 瓷砖切割轮

22x6x6 mm

YG6X



YATO		
YT-37150		50/500

EN Tile cutter
 PL Przyrząd do cięcia glazury
 DE Fliesenschneider
 RU Плиткорез
 CZ Přístroj na řezání glazury
 HU Csempévágó

RO Mașină pt. tăiat plăci ceramice
 FR Coupeuse pour céramique
 IT Taglierina per piastrelle
 ES Cortadora de cerámica
 CN 瓷砖切割器

600 mm

max 12 mm

22x6x6 mm

AI



YATO	L [mm]	
YT-37042	600	2

EN Tile cutter
 PL Przyrząd do cięcia glazury
 DE Fliesenschneider
 RU Плиткорез
 CZ Přístroj na řezání glazury
 HU Csempévágó

RO Mașină pt. tăiat plăci ceramice
 FR Coupeuse pour céramique
 IT Taglierina per piastrelle
 ES Cortadora de cerámica
 CN 瓷砖切割器

1000 mm

max 16 mm

22x6x6 mm



YG6X



YATO	L [mm]	
YT-37052	1000	1

EN Tile cutter
 PL Przyrząd do cięcia glazury
 DE Fliesenschneider
 RU Плиткорез
 CZ Přístroj na řezání glazury
 HU Csempévágó

RO Mașină pt. tăiat plăci ceramice
 FR Coupeuse pour céramique
 IT Taglierina per piastrelle
 ES Cortadora de cerámica
 CN 瓷砖切割器

max 14 mm

22x6x6 mm





YG6X



YATO	L [mm]	
YT-37000	800	2
YT-37002	1200	2

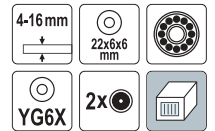

EN Tile cutter
PL Przyrząd do cięcia glazury
DE Fliesenschneider
RU Плиткопез
CZ Přístroj na řezání glazury
HU Csempévágó
RO Mașină pt. tăiat plăci ceramice
FR Coupeuse pour céramique
IT Taglierina per piastrelle
ES Cortadora de cerámica
CN 瓷砖切割器



YATO 	L [mm]	
YT-37010	1650	1
YT-37011	1850	1

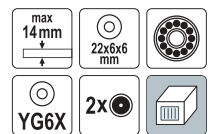

EN Tile cutter
PL Przyrząd do cięcia glazury
DE Fliesenschneider
RU Плиткопез
CZ Přístroj na řezání glazury
HU Csempévágó
RO Mașină pt. tăiat plăci ceramice
FR Coupeuse pour céramique
IT Taglierina per piastrelle
ES Cortadora de cerámica
CN 瓷砖切割器

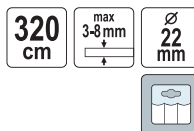

YATO 	L [mm]	
YT-37015	1050	1
YT-37016	1300	1
YT-37017	1650	1

EN Large format tile cutter
PL Przetwarzarka do płyt ceramicznych
DE Keramikplattentrenmaschine
RU Резак для керамической плитки
CZ Rezačka keramických desek
HU Csempévágó
RO Dispozitiv pt. tăiat plăci ceramice
FR Coupe carrelage
IT Troncatrice per pannelli di ceramica
ES Cortador para placas de cerámica
CN 瓷砖切割器





YATO 	L [mm]	
YT-36980	3200	1

EN Tile cutter with table
PL Przetwarzarka do płytek ceramicznych ze stołem
DE Keramikfliesenschneider mit Tisch
RU Резак для керамической плитки со столом
CZ Rezačka keramických dlaždic se stolem
HU Csempévágó asztal

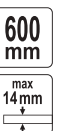
RO Mașină pt. tăiat plăci ceramice cu stand
FR Scie à carreaux sur table
IT Tagliapiastrelle a banco
ES Cortador para baldosas cerámicas con mesa
CN 瓷砖切割器



YATO 	L [mm]	
YT-37040	600	1

EN Tile cutting pliers
 PL Szczypce do cięcia i łamania glazury
 DE Glasurzange
 RU Кусачки для плитки
 CZ Kleště do glazury
 HU Csempefogó
 RO Clește pt. plăci ceramic
 FR Pince grès mosaïque
 IT Tenaglia per piastrelle
 ES Tenazas para azulejos
 CN 瓷砖钳

200 mm YG6X



YATO L [mm]
 YT-37160 200 6/36

EN Tile cutting pliers
 PL Szczypce do łamania glazury
 DE Glasurzange
 RU Кусачки для плитки
 CZ Kleště do glazury
 HU Csempefogó
 RO Clește pt. plăci ceramic
 FR Pince grès mosaïque
 IT Tenaglia per piastrelle
 ES Tenazas para azulejos
 CN 瓷砖钳

200 mm 2x YG6X TiN



YATO L [mm]
 YT-37161 200 6/36

EN Tile cutting pliers
 PL Szczypce do glazury
 DE Glasurzange
 RU Кусачки для плитки
 CZ Kleště do glazury
 HU Csempefogó
 RO Clește pt. plăci ceramic
 FR Pince grès mosaïque
 IT Tenaglia per piastrelle
 ES Tenazas para azulejos
 CN 瓷砖钳

200 mm YG6X



YATO L [mm]
 YT-37164 200 6/60

EN Tile chamfering machine
 PL Prowadnica do fazowania płytek
 DE Führung zum Anfasen von Fliesen
 RU Направляющая для снятия фаски
 CZ Vodítko pro srážení hran dlaždic
 HU Vezetősín átlós csempévágáshoz
 RO Dispozitiv pt. tesit plăci
 FR Dispositif de chanfreinage pour carrelage
 IT Smussatrice per piastrelle
 ES Máquina de biselado de azulejos
 CN 瓷砖倒角器

250x170 mm 45° AI



YATO [mm]
 YT-36984 250x170 50

EN Grout remover
 PL Skrobak do fug
 DE Fugenreiniger
 RU Скребок для швов кладки
 CZ Škrábák na spáry
 HU Fugakihúzó
 RO Răzuitoare pt. rosturi
 FR Gratteur pour fugues
 IT Raschietto per fuga piastrelle
 ES Rascador para juntas
 CN 砂浆去除器



YATO
 YT-37170 10/60

EN Interchangeable brick jointer
 PL Przyrząd do wygładzania fug
 DE Vorrichtung zum Glätten von Fugen
 RU Инструмент для затирки швов
 CZ Zařízení na vyhlazení spár
 HU Fugasimító szerszám
 RO Dispozitiv modelat rosturile dintre caramizi
 FR Lisseur de joints
 IT Attrezzo per levigare le giunzioni
 ES Alisador de juntas
 CN 墙缝刀

4 PCS 1/2" 5/8" 3/4" 7/8" SS



YATO
 YT-37177 6/24

EN Glaze bucket
 PL Wiadro glazownicze
 DE Fliesenwaschset Rolleneimer
 RU Ведро с роликами для затирки швов
 CZ Malířské vědro
 HU Fugázó vödör
 RO Galeata pt. zugravit
 FR Seau de peinture
 IT Secchio per lavaggio piastrelle
 ES Cubo de pintura
 CN 釉桶

22L PE



YATO Capacity / Pojemność [l]
 YT-54750 22 42

EN Steel contour gauge
 PL Wzornik do kopiowania kształtów
 DE Profil Imuster
 RU Шаблон профилей
 CZ Profilová šablona
 HU Profil sablon
 RO Șablon profil
 FR Jauges d'épaisseurs métriques
 IT Sagoma di contorno
 ES Plantilla de perfiles
 CN 仿形规

150 mm 46 mm STEEL NEEDLES STALOWE IGLY mm inch

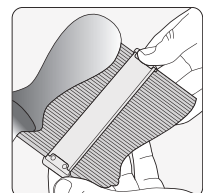

YATO L [mm]
 YT-70870 150 12/48

EN Profile gauge
PL Wzornik profili
DE Profilehre
RU Шаблон профилей
CZ Profilová šablona
HU Profilsablon

RO Șablon profil
FR Copieur de profil
IT Calibro da profilo
ES Plantilla de perfil
CN 轮廓仪



125 mm

YATO	L [mm]	
YT-3735	125	24/72



260 mm

YATO	L [mm]	
YT-3736	260	10/40

EN Trowel for silicone
PL Szpachelka do silikonu
DE Spachtel für Silikon
RU Шпатель для силикона
CZ Špachtle na silikon
HU Spachli szilikonhoz
RO Spatulă pt. silicon
FR Spatule à silicone
IT Spatola per silicone
ES Espátula para silicona
CN 橡塑刮板



YATO	
YT-5260	20/300

EN Trowel for silicone
PL Szpachelka do silikonu
DE Spachtel für Silikon
RU Шпатель для силикона
CZ Špachtle na silikon
HU Spachli szilikonhoz
RO Spatulă pt. silicon
FR Spatule à silicone
IT Spatola per silicone
ES Espátula para silicona
CN 橡塑刮板



YATO	
YT-5262	20/200

EN Stucco spatulas set
PL Szpachelki sztukatorskie
DE Stukkateureisen
RU Шпатель штукатурный двухсторонний
CZ Štukatérský nástroj
HU Spatulák

RO Spatula metalica
FR Spatule à moulures
IT Set di spatole per stucco
ES Espátulas
CN 修正刀

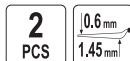

YATO	
YT-52780	6/48

EN Profile gauge
PL Wzornik profili
DE Profilehre
RU Шаблон профилей
CZ Profilová šablona
HU Profilsablon

RO Șablon profil
FR Copieur de profil
IT Calibro da profilo
ES Plantilla de perfil
CN 轮廓仪



YATO	L [mm]	
YT-37364	525	9/18

EN Trowel for silicone
PL Szpachelka do silikonu
DE Spachtel für Silikon
RU Шпатель для силикона
CZ Špachtle na silikon
HU Spachli szilikonhoz
RO Spatulă pt. silicon
FR Spatule à silicone
IT Spatola per silicone
ES Espátula para silicona
CN 橡塑刮板

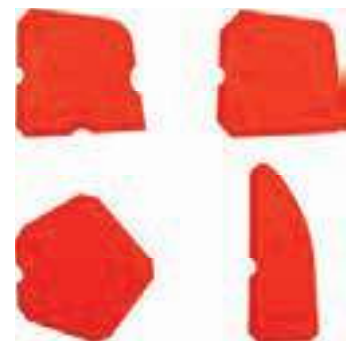

YATO	
YT-5261	20/200

EN Caulking tool set
PL Zestaw narzędzi do fug silikonowych
DE Fugenglätter Set
RU Набор инструментов уплотнительных
CZ Sada nástrojů pro spoje
HU Az izületek eszközei
RO Set raclete pt. silicon
FR Ensemble d'outils à calfeutrer
IT Set di attrezzi per fughe in silicone
ES Conjunto de herramientas para empalmes
CN 钢丝刷



YATO	
YT-52621	12/48

EN Scraper with bits
PL Szpachelka nierdzewna szlifowana
DE Edelstahlspachtel geschliffen
RU Шпатель из шлифованной нержавеющей стали
CZ Špachtle z broušené nerezové oceli
HU Csiszolt rozsdamentes spakli
RO Racleta cu biti
FR Spatule en acier inoxydable broyé
IT Spatola in acciaio inossidabile rettificato
ES Espátula inox esmerilada
CN 油灰刀



□ 1/4" (6.3 mm); 5, 6 mm (L=25 mm); CrV;
✦ 1/4" (6.3 mm); PH2 (L=25 mm; 2 PCS); CrV

YATO	
YT-52760	10/60

EN Multi-funktion paint scraper
 PL Skrobak malarski nierdzewny profilowany
 DE Malerschaber rostfrei, profiliert
 RU Скребок малярный из нержавеющей стали, профилированный
 CZ Profilovaná malířská škrabka z nerezové oceli
 HU Profilozott rozsdamentes festékkaparó
 RO Racleta vopsea multifunctionala
 FR Racleur à peinture profilé en acier inoxydable
 IT Raschietto per vernice profilato inossidabile
 ES Rasqueta de pintura inoxidable perfilada
 CN 油灰刀

1/4"
6.3mm
HRC
44-49
3Cr13
SS
STAINLESS STEEL
STAL NIERDZEWNA
CrV



□ 1/4" (6.3 mm); 5, 6 mm (L=25 mm); CrV;
 ⊕ 1/4" (6.3 mm); PH2 (L=25 mm; 2 PCS); CrV

YATO		
YT-52870		12/144

EN Stainless steel putty knife
 PL Szpachla nierdzewna
 DE Edelstahl-Kleberspachtel
 RU Шпатель из нержавеющей стали
 CZ Nerezová špachtle
 HU Rozsdamentes spatki
 RO Spaclu inox pt. chituit
 FR Spatule à enduire en inox
 IT Spatola in acciaio inox
 ES Espátula de acero inoxidable
 CN 不锈钢刮刀

SS
STAINLESS STEEL
STAL NIERDZEWNA



YATO	Working width / Szerokość robocza [mm]	
YT-52245	150	12/120
YT-52246	200	12/120
YT-52247	250	12/120

EN Finishing spatula
 PL Szpachla wykończeniowa
 DE Flächenspachtel
 RU Финишный шпатель
 CZ Špachtle fasádní
 HU Glett lehzúó
 RO Gletieră finisare
 FR Couteau à lissier
 IT Spatola lisciante per rasatura
 ES Espátula para alisado
 CN 刮刀

✗



YATO	Working width / Szerokość robocza [mm]	
YT-52220	250	2
YT-52221	400	2
YT-52222	600	2
YT-52223	800	2
YT-52224	1000	2

EN Handle adapter for finishing spatula
 PL Uchwyt do szpachli wykończeniowej
 DE Adapter für Flächenspachtel
 RU Ручка для финишных шпателей
 CZ Adaptér pro fasádní špachtli
 HU Glett lehzúó nyelezhető adapter
 RO Adaptor mâner pt. spatulă finisare
 FR Adaptateur de perche pour couteaux à lissier
 IT Adattatore per spatola di finitura
 ES Mango para espátula de acabado
 CN 刮刀手柄

✗



For YT-52220, YT-52221, YT-52222, YT-52223, YT-52230, YT-52231, YT-52232, YT-52233
 Dla YT-52220, YT-52221, YT-52222, YT-52223, YT-52230, YT-52231, YT-52232, YT-52233

YATO		
YT-52237		4

EN Multi-funktion paint scraper
 PL Skrobak malarski nierdzewny profilowany
 DE Malerschaber rostfrei, profiliert
 RU Скребок малярный из нержавеющей стали, профилированный
 CZ Profilovaná malířská škrabka z nerezové oceli
 HU Profilozott rozsdamentes festékkaparó
 RO Racleta vopsea multifunctionala
 FR Racleur à peinture profilé en acier inoxydable
 IT Raschietto per vernice profilato inossidabile
 ES Rasqueta de pintura inoxidable perfilada
 CN 油灰刀

HRC
44-49
3Cr13

SS
STAINLESS STEEL
STAL NIERDZEWNA



YATO		
YT-52871		12/144

EN Plastic scraper set
 PL Zestaw skrobaków - szpachelki
 DE Schaber-Spachtel-Satz
 RU Набор скребков - шпатели
 CZ Sada škrabek - špachtle
 HU Kaparókészlet - spatulák
 RO Set raclete din plastic
 FR Jeu de raclettes et spatules
 IT Kit di raschietti - spatole
 ES Juego de raspadores - espátulas
 CN 塑料油灰刀

6 PCS
40 mm
50 mm
80 mm
100 mm
150 mm
200 mm
ABS



YATO		
YT-52740		6/24

EN Finishing spatula
 PL Szpachla wykończeniowa
 DE Flächenspachtel
 RU Финишный шпатель
 CZ Špachtle fasádní
 HU Glett lehzúó
 RO Gletieră finisare
 FR Couteau à lissier
 IT Spatola lisciante per rasatura
 ES Espátula para alisado
 CN 刮刀

✗



YATO	Working width / Szerokość robocza [mm]	
YT-52230	250	4
YT-52231	400	4
YT-52232	600	4
YT-52233	800	2
YT-52234	1000	2

EN Handle adapter for spatulas
 PL Uchwyt na przedłużkę do szpachli
 DE Stieladapter für Spachtel
 RU Адаптер для шпателя
 CZ Držák špachtle na tyč
 HU Spakli nyelezhető adapter
 RO Adaptor mâner pt. spatulă finisare
 FR Adaptateur de manche pour spatules
 IT Adattatore per spatola
 ES Adaptador de mango para espátula
 CN 刮刀手柄

✗



For YT-5226, YT-5228, YT-5230, YT-52310, YT-52311, YT-52312, YT-52313, YT-52314, YT-52320
 Dla YT-5226, YT-5228, YT-5230, YT-52310, YT-52311, YT-52312, YT-52313, YT-52314, YT-52320

YATO		
YT-52317		4

EN Replaceable blade for finishing spatula
PL Ostrze do szpachli wykończeniowej
DE Ersatzblatt für Flächenspachtel
RU Лезвие для финишного шпателя
CZ Náhradní čepel do špachtle fasádní
HU Cserélhető penge glett lehúzóhoz

RO Lamă de înlocuit pt. gletieră finisare
FR Lame pour couteaux à lisser
IT Lama per spatola lisciante
ES Cuchilla de recambio para espátula de alisado
CN 刮墙板刀片



YATO	W [mm]	For / Dla	
YT-52240	250	YT-52230	5
YT-52241	400	YT-52231	5
YT-52242	600	YT-52232	5
YT-52243	800	YT-52233	5
YT-52244	1000	YT-52224, YT-52234	5

EN Gypsum container
PL Pojemnik na gips
DE Gipsbehälter
RU Контейнер для гипса
CZ Nádobna na sádru
HU Gipsztál
RO Vas prelucrare ipsos
FR Conteneur rond pour préparation de plâtre
IT Recipiente per gesso
ES Contenedor para yeso
CN 石膏桶



83 mm
130 mm
0.5 L

YATO		
YT-51881	0.5	20

EN Trowel
PL Paca
DE Reibebrett
RU Терка
CZ Hladitko
HU Glettelő



270x130 mm
SS
STAINLESS STEEL
STAL NIERDZEWNA

• Made of special cold rolled stainless steel sheet with elasticity factor up to 2000 N/mm
• Części robocze ze specjalnej zimnowalcowanej blachy nierdzewnej o sprężystości do 2000 N/mm

YATO	Size / Rozmiar [mm]	
YT-5200	270x130	30

EN Trowel
PL Paca
DE Reibebrett
RU Терка
CZ Hladitko
HU Glettelő



SS
STAINLESS STEEL
STAL NIERDZEWNA

• Made of special cold rolled stainless steel sheet with elasticity factor up to 2000 N/mm
• Części robocze ze specjalnej zimnowalcowanej blachy nierdzewnej o sprężystości do 2000 N/mm

YATO	Size / Rozmiar [mm]	
YT-5207	380x130	10
YT-5209	480x130	10
YT-5210	580x130	10

EN Gypsum container
PL Pojemnik na gips
DE Gipsbehälter
RU Контейнер для гипса
CZ Nádobna na sádru
HU Gipsztál
RO Vas prelucrare ipsos
FR Conteneur rond pour préparation de plâtre
IT Recipiente per gesso
ES Contenedor para yeso
CN 石膏桶

50 mm
155 mm
0.5 L



YATO		
YT-51880	0.5	20

EN Stainless steel scraper set
PL Szpachelki nierdzwne "japonki"
DE Aufstreichspachtel
RU Набор шпателей тип "Японский"
CZ Špachtle japonky nerezavějící
HU Spatula rozsdamentes
RO Șpacluri japoneze inoxidabile
FR Raclleur en acier inoxydable ensemble
IT Spatole giapponesi in acciaio inox
ES Espátulas "japonesas" de acero
CN 刮刀



4 PCS
50 mm
75 mm
100 mm
150 mm
SS
STAINLESS STEEL
STAL NIERDZEWNA

YATO		
YT-52790		10/40

EN Trowel
PL Paca
DE Reibebrett
RU Терка



SS
STAINLESS STEEL
STAL NIERDZEWNA

• Made of special cold rolled stainless steel sheet with elasticity factor up to 2000 N/mm
• Części robocze ze specjalnej zimnowalcowanej blachy nierdzewnej o sprężystości do 2000 N/mm

YATO	Teeth size / Rozmiar zębów [mm]	Size / Rozmiar [mm]	
YT-5202	6x6	275x130	30
YT-5203	8x8	270x130	30
YT-5204	10x10	260x130	30

EN Trowel
PL Paca
DE Reibebrett
RU Терка
CZ Hladitko
HU Glettelő
RO Gletieră
FR Truelle
IT Frattazzo
ES Llana
CN 抹子



500 mm

YATO	L [mm]	
YT-5212	500	20

EN Bull float kit
 PL Ręczna listwa wibracyjna
 DE Handrüttelbohle
 RU Ручная виброрейка
 CZ Ruční vibrační lišta
 HU Kézi betonlehúzó
 RO Riglă vibrantă manuală
 FR Règle vibrante portative
 IT Staggia vibrante manuale
 ES Regla vibrante manual
 CN 抹子



120x20
cm

AI

3x180cm

EN Trowel
 PL Paca
 DE Reibebrett
 RU Терка
 CZ Hladitko
 HU Glettelő
 RO Gletieră
 FR Truelle
 IT Frattazzo
 ES Llana
 CN 抹子



200x80
mm

SS
STAINLESS STEEL
STAHLWERKZEUGE

• Made of special cold rolled stainless steel sheet with elasticity factor up to 2000 N/mm
 • Części robocze ze specjalnej zimnowalcowanej blachy nierdzewnej o sprężystości do 2000 N/mm

YATO	Size / Rozmiar [mm]	
YT-30900	1200x200	1

YATO	Size / Rozmiar [mm]	
YT-5214	200x80	20

EN Trowel
 PL Paca
 DE Reibebrett
 RU Терка
 CZ Hladitko
 HU Glettelő
 RO Gletieră
 FR Truelle
 IT Frattazzo
 ES Llana
 CN 抹子



YATO	Size / Rozmiar [mm]	
YT-51900	250x95	5

EN Trowel
 PL Paca
 DE Reibebrett
 RU Терка
 CZ Hladitko
 HU Glettelő
 RO Gletieră
 FR Truelle
 IT Frattazzo
 ES Llana
 CN 抹子



18
mm



YATO	Size / Rozmiar [mm]	
YT-51909	270x130	10

EN Trowel
 PL Paca
 DE Reibebrett
 RU Терка
 CZ Hladitko
 HU Glettelő
 RO Gletieră
 FR Truelle
 IT Frattazzo
 ES Llana
 CN 抹子



8
mm



YATO	Size / Rozmiar [mm]	
YT-51901	270x130	10

EN Trowel
 PL Paca
 DE Reibebrett
 RU Терка
 CZ Hladitko
 HU Glettelő
 RO Gletieră
 FR Truelle
 IT Frattazzo
 ES Llana
 CN 抹子



40
mm



YATO	Size / Rozmiar [mm]	
YT-51902	270x130	10

EN Trowel
 PL Paca
 DE Reibebrett
 RU Терка
 CZ Hladitko
 HU Glettelő
 RO Gletieră
 FR Truelle
 IT Frattazzo
 ES Llana
 CN 抹子



40
mm



YATO	Size / Rozmiar [mm]	
YT-51903	270x130	10

EN Trowel
 PL Paca
 DE Reibebrett
 RU Терка
 CZ Hladitko
 HU Glettelő
 RO Gletieră
 FR Truelle
 IT Frattazzo
 ES Llana
 CN 抹子





30
mm



YATO	Size / Rozmiar [mm]	
YT-51904	270x130	10

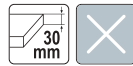

EN Trowel
PL Paca
DE Reibebrett
RU Терка
CZ Hladitko
HU Glettelő
RO Gletieră
FR Truelle
IT Frattazzo
ES Llana
CN 抹子



YATO  Size / Rozmiar [mm] 
YT-51905 270x130 10



EN Trowel
PL Paca
DE Reibebrett
RU Терка
CZ Hladitko
HU Glettelő
RO Gletieră
FR Truelle
IT Frattazzo
ES Llana
CN 抹子



YATO  Size / Rozmiar [mm] 
YT-51906 270x130 10



EN Trowel
PL Paca
DE Reibebrett
RU Терка
CZ Hladitko
HU Glettelő
RO Gletieră
FR Truelle
IT Frattazzo
ES Llana
CN 抹子



YATO  Size / Rozmiar [mm] 
YT-51907 270x130 5



EN Trowel
PL Paca
DE Reibebrett
RU Терка
CZ Hladitko
HU Glettelő
RO Gletieră
FR Truelle
IT Frattazzo
ES Llana
CN 抹子



YATO  Size / Rozmiar [mm] 
YT-51908 270x130 10



EN Trowel
PL Paca
DE Reibebrett
RU Терка
CZ Hladitko
HU Glettelő
RO Gletieră
FR Truelle
IT Frattazzo
ES Llana
CN 抹子



YATO  Size / Rozmiar [mm] 
YT-51910 270x130 10

EN Trowel
PL Paca
DE Reibebrett
RU Терка
CZ Hladitko
HU Glettelő
RO Gletieră
FR Truelle
IT Frattazzo
ES Llana
CN 抹子



YATO  Size / Rozmiar [mm] 
YT-51911 270x130 20



EN Rasp for polystyrene
PL Tarka do styropianu
DE Reibebrett für Styropor
RU Терка для пенопласта
CZ Rašple na polystyren
HU Polisztirol reszelő
RO Gletieră pt. răzuit polistiren
FR Planche à poncer pour polystyrène
IT Raspa per polistirolo
ES Escofina para poliestireno
CN 多孔砂板



YATO  Size / Rozmiar [mm] 
YT-51920 375x155 10

EN Rasp for polystyrene
PL Tarka do styropianu
DE Reibebrett für Styropor
RU Терка для пенопласта
CZ Rašple na polystyren
HU Polisztirol reszelő
RO Gletieră pt. răzuit polistiren
FR Planche à poncer pour polystyrène
IT Raspa per polistirolo
ES Escofina para poliestireno
CN 多孔砂板



YATO  Size / Rozmiar [mm] 
YT-5218 370x165 20

- EN Rasp for polystyrene
- PL Tarka do styropianu
- DE Reibebrett für Styropor
- RU Терка для пенопласта
- CZ Rašple na polystyren
- HU Polisztirol reszelő
- RO Gletieră pt. răzuțit polistiren
- FR Planche à poncer pour polystyrène
- IT Raspa per polistirolo
- ES Escofina para poliestireno
- CN 多孔砂板

360x160 mm



YATO	Size / Rozmiar [mm]	
YT-51921	360x160	10

- EN Facade putty knife
- PL Szczałka fasadowa
- DE Flächenspachtel
- RU Шпатель фасадный
- CZ Špachtle fasádní
- HU Fali spatulya

- RO Spaclu inox
- FR Spatule de façade
- IT Spatola per facciate
- ES Espátula de fachada
- CN 剥皮刀

SS



• Made of special cold rolled stainless steel sheet with elasticity factor up to 2000 N/mm

• Części robocze ze specjalnej zimnowalcowanej blachy nierdzewnej o sprężystości do 2000 N/mm

YATO	L [mm]	
YT-5226	250	20
YT-5228	350	20
YT-5230	500	20

- EN Trowel
- PL Kielnia
- DE Kelle
- RU Кельма
- CZ Lžíce
- HU Vakolókanál
- RO Mistrie
- FR Truelle
- IT Cazzuola
- ES Paleta
- CN 抹子



200x190 mm

• Made of special cold rolled stainless steel sheet with elasticity factor up to 2000 N/mm

• Części robocze ze specjalnej zimnowalcowanej blachy nierdzewnej o sprężystości do 2000 N/mm

YATO	Size / Rozmiar [mm]	
YT-5234	200x190	10

- EN Trowel
- PL Kielnia
- DE Kelle
- RU Кельма
- CZ Lžíce
- HU Vakolókanál
- RO Mistrie
- FR Truelle
- IT Cazzuola
- ES Paleta
- CN 抹子



• Made of special cold rolled stainless steel sheet with elasticity factor up to 2000 N/mm

• Części robocze ze specjalnej zimnowalcowanej blachy nierdzewnej o sprężystości do 2000 N/mm

YATO	Dimensions / Wymiary [mm]	
YT-5240	165x80x55	20

- EN Trowel
- PL Kielnia
- DE Kelle
- RU Кельма
- CZ Lžíce
- HU Vakolókanál
- RO Mistrie
- FR Truelle
- IT Cazzuola
- ES Paleta
- CN 抹子



• Made of special cold rolled stainless steel sheet with elasticity factor up to 2000 N/mm

• Części robocze ze specjalnej zimnowalcowanej blachy nierdzewnej o sprężystości do 2000 N/mm

YATO	Size / Rozmiar [mm]	
YT-5242	100x130	20
YT-5243	80x110	20

- EN Rasp for mineral wool
- PL Zdzierak do wełny
- DE Schleifbrett für Mineralwolle
- RU Терка-скребок для минеральной ваты
- CZ Škrábák na minerální vlnu
- HU Ásványgyapot kaparó
- RO Rindea pt. vată minerală
- FR Râpe pour laine
- IT Frattazzo per levigare lana mineral
- ES Escofina para lana mineral
- CN 矿物棉锉刨

285x145 mm



YATO	Size / Rozmiar [mm]	
YT-52477	285x145	10

- EN Facade putty knife
- PL Szczałka fasadowa
- DE Flächenspachtel
- RU Шпатель фасадный
- CZ Špachtle fasádní
- HU Fali spatulya
- RO Spaclu inox
- FR Spatule de façade
- IT Spatola per facciate
- ES Espátula de fachada
- CN 剥皮刀



YATO	Size / Rozmiar [mm]	
YT-52310	150x90	10
YT-52311	250x90	10
YT-52312	350x90	10
YT-52313	450x90	10
YT-52314	550x90	10

- EN Trowel
- PL Kielnia
- DE Kelle
- RU Кельма
- CZ Lžíce
- HU Vakolókanál
- RO Mistrie
- FR Truelle
- IT Cazzuola
- ES Paleta
- CN 抹子



SS

• Made of special cold rolled stainless steel sheet with elasticity factor up to 2000 N/mm

• Części robocze ze specjalnej zimnowalcowanej blachy nierdzewnej o sprężystości do 2000 N/mm

YATO	Dimensions / Wymiary [mm]	
YT-5237	120x180x80	10

- EN Trowel
- PL Kielnia
- DE Kelle
- RU Кельма
- CZ Lžíce
- HU Vakolókanál
- RO Mistrie
- FR Truelle
- IT Cazzuola
- ES Paleta
- CN 抹子



• Made of special cold rolled stainless steel sheet with elasticity factor up to 2000 N/mm

• Części robocze ze specjalnej zimnowalcowanej blachy nierdzewnej o sprężystości do 2000 N/mm

YATO	Size / Rozmiar [mm]	
YT-5245	135x80	20

- EN Curved edge bucket scoop
PL Szpachla profilowana do wiadra
DE Eimerschaber
RU Шпатель для ведра
CZ Profilovaná stěrka na kbelky
HU Ivelt kisedő spakli
RO Spaclu curbat pt. galeata
FR Stucateur pour seau
IT Spatola inclinata lama arrotondata per sechcio
ES Espátula para limpieza de cubeta
CN 圆弧铲



165
mm



YATO	Working width / Szerokość robocza [mm]	4
YT-52320	165	

- EN Scraper for plaster and aerated blocks
PL Zdzierak wyrównujący
DE Gipsobel mit Stahlklingen
RU Рубанок для газобетона
CZ Vyrovňovací škrabák
HU Kiegyenlítő dörzsölő
RO Raspel de nivelare
FR Lime grosse droit
IT Raschiatore livellatore
ES Raspador
CN 干墙器



YATO	Size / Rozmiar [mm]	10
YT-52472	405x84	

- EN Plaster scrubber
PL Zdzierak do tynków
DE Alu-Rabott
RU Треугольный мастерок для каменщиков
CZ Škrabák
HU Vakolat gyalu alu késes
RO Gletiera abraziva
FR Enleveur du badigeon
IT Utensile per sgrossare
ES Rascador para enlucido
CN 石膏去除器



455x90
mm

AI



- EN Mortar gun with nozzles kit
PL Wyciskacz do fugowania
DE Mörtelspritze
RU Пистолет для затирки швов
CZ Pistole vytláčovací
HU Kinyomó pisztoly
RO Pistol pt. silicon
FR Seringue mortier
IT Pistola per silicone
ES Pistola para calafatear mortero
CN 堵缝枪



YATO		10
YT-67580		

- EN Plaster / stucco spray gun
PL Tynkownica pneumatyczna do ścian
DE Spritzpistole für Mörtel
RU Пневмоковш для штукатурки стен
CZ Strikací pistole pro maltu
HU Habarcás szórópisztoly

- RO Dispozitiv pneumatic pt. tencuit
FR Pistolet à peinture pour mortier
DE Intonacatrice pneumatica per pareti
ES Pistola pulverizadora para mortero
CN 重型气动便携式墙面水泥砂浆喷枪

0.4-0.8
MPa

400
l/min

4.75L

max
50
m³/h

STANDARD



$L_{pA} = 93,6 \pm 2,5$ dB; $L_{wA} = 104,6 \pm 2,5$ dB; $a_n = < 2,5$ m/s²

YATO		4
YT-54400		

- EN Plaster scrubber
PL Zdzierak do tynków
DE Alu-Rabott
RU Треугольный мастерок для каменщиков
CZ Škrabák
HU Vakolat gyalu alu késes
RO Gletiera abraziva
FR Enleveur du badigeon
IT Utensile per sgrossare
ES Rascador para enlucido
CN 石膏去除器



YATO	Size / Rozmiar [mm]	10
YT-52471	248x133	

- EN Scraper with teeth for plaster and aerated blocks
PL Zdzierak wyrównujący z ząbkami
DE Gipsobel mit Stahlklingen gezahnt
RU Рубанок для газобетона зубчатый
CZ Vyrovňovací škrabák se zoubky
HU Fogas, kiegyenlítő dörzsölő
RO Raspel cu dinți
FR Lime grosse droit avec dents
IT Raschiatore livellatore dentato
ES Raspador con dientes
CN 干墙器



YATO	Size / Rozmiar [mm]	10
YT-52473	405x84	

YATO	Size / Rozmiar [mm]	25
YT-5247	450x90	

- EN Mortar gun with nozzles kit
PL Wyciskacz do fugowania
DE Mörtelspritze
RU Пистолет для затирки швов
CZ Pistole vytláčovací
HU Kinyomó pisztoly
RO Pistol pt. silicon
FR Seringue mortier
IT Pistola per silicone
ES Pistola para calafatear mortero
CN 堵缝枪



1L

AI



YATO		12
YT-67583		

- EN Spiked soles for work shoes
PL Podeszwy z kolcami
DE Sohlen mit Spikes
RU Подошвы с шипами
CZ Podesšve s hroty
HU Szögös cipőtalp
RO Săboți cu țepi pt. șapă autonivelantă
FR Semelles à pointes
IT Sottoscarpe chiodate
ES Suelas con clavos
CN 草地鞋



300
mm

TTTT
45mm



YATO	L [mm]	20
YT-80820	300	

EN Stamp roller
 PL Walek do wyciskania wzorów w tynku
 DE Musterpressrolle für Putz
 RU Валик для выдавливания рисунков в штукатурке
 CZ Váleček pro vytlačení vzorů na omítkách
 HU Henger minták dombornyomásához a vakolatban
 RO Rolă model tencuială
 FR Rouleau texturé pour plâtre
 IT Rullo goffratore per intonaco
 ES Rodillo con relieve para enlucidos
 CN 橡胶压花滚筒



YATO	Size / Rozmiar [mm]	
YT-51960	230x70	25

EN Stamp roller
 PL Walek do wyciskania wzorów w tynku
 DE Musterpressrolle für Putz
 RU Валик для выдавливания рисунков в штукатурке
 CZ Váleček pro vytlačení vzorů na omítkách
 HU Henger minták dombornyomásához a vakolatban
 RO Rolă model tencuială
 FR Rouleau texturé pour plâtre
 IT Rullo goffratore per intonaco
 ES Rodillo con relieve para enlucidos
 CN 橡胶压花滚筒



YATO	Size / Rozmiar [mm]	
YT-51961	230x70	25

EN Stamp roller
 PL Walek do wyciskania wzorów w tynku
 DE Musterpressrolle für Putz
 RU Валик для выдавливания рисунков в штукатурке
 CZ Váleček pro vytlačení vzorů na omítkách
 HU Henger minták dombornyomásához a vakolatban
 RO Rolă model tencuială
 FR Rouleau texturé pour plâtre
 IT Rullo goffratore per intonaco
 ES Rodillo con relieve para enlucidos
 CN 橡胶压花滚筒



YATO	Size / Rozmiar [mm]	
YT-51962	230x70	25

EN Stamp roller
 PL Walek do wyciskania wzorów w tynku
 DE Musterpressrolle für Putz
 RU Валик для выдавливания рисунков в штукатурке
 CZ Váleček pro vytlačení vzorů na omítkách
 HU Henger minták dombornyomásához a vakolatban
 RO Rolă model tencuială
 FR Rouleau texturé pour plâtre
 IT Rullo goffratore per intonaco
 ES Rodillo con relieve para enlucidos
 CN 橡胶压花滚筒



YATO	Size / Rozmiar [mm]	
YT-51963	180x70	25

EN Stamp roller
 PL Walek do wyciskania wzorów w tynku
 DE Musterpressrolle für Putz
 RU Валик для выдавливания рисунков в штукатурке
 CZ Váleček pro vytlačení vzorů na omítkách
 HU Henger minták dombornyomásához a vakolatban
 RO Rolă model tencuială
 FR Rouleau texturé pour plâtre
 IT Rullo goffratore per intonaco
 ES Rodillo con relieve para enlucidos
 CN 橡胶压花滚筒



YATO	Size / Rozmiar [mm]	
YT-51964	180x70	25

EN Multi-purpose brush
 PL Szczotka do tynków dekoracyjnych
 DE Bürste für Dekorationsputz
 RU Щетка для декоративной штукатурки
 CZ Štětká do dekoracních omítek
 HU Dekoratív vakolatához való kefe
 RO Perie pt. tencuială
 FR Brosse multi-fonctions
 IT Spazzola per effetti decorativi di intonaco
 ES Escoba para enlucidos decorativos
 CN 万用刷



YATO	Size / Rozmiar [mm]	
YT-51970	400x25	50
YT-51971	200x25	50

EN Multi-purpose brush
 PL Szczotka do tynków dekoracyjnych
 DE Bürste für Dekorationsputz
 RU Щетка для декоративной штукатурки
 CZ Štětká do dekoracních omítek
 HU Dekoratív vakolatához való kefe

RO Perie pt. tencuială
 FR Brosse multi-fonctions
 IT Spazzola per effetti decorativi di intonaco
 ES Escoba para enlucidos decorativos
 CN 万用刷



YATO	Size / Rozmiar [mm]	
YT-51973	140x235	40

EN Self-adhesive protective film
 PL Folia ochronna samoprzylepna
 DE Selbstklebende Schutzfolie
 RU Самоклеящаяся пленка
 CZ Ochranná samolepicí fólie
 HU Őntapadós védőfólia
 RO Folie de protecție autoadezivă
 FR Film de protection auto-adhésif
 IT Pellicola protettiva adesiva
 ES Película protectora autoadhesiva
 CN 自粘保护膜





YATO	W [cm]	L [m]	± [µm]	
YT-54300	25	30	45	12
YT-54310	50	30	45	6
YT-54313	50	75	45	6
YT-54320	60	50	45	4

EN Flat paint brush
PL Pędzel angielski
DE Flachpinsel
RU Кисть флейцевая тип Английский
CZ Štětec anglický
HU Laposecset

RO Pensulă englezească
FR Pinceau plat anglais
IT Pennello piatto
ES Brocha plana
CN 平刷



• Application: oil, emulsion, latex and ceramic paints, impregnating paint, varnish
• Zastosowanie: farby olejne, emulsyjne, lateksowe i ceramiczne, impregnaty, lakiery



YATO 	Brush width / Szerokość pędzla	
YT-54500	1" (25 mm)	12
YT-54501	1.5" (38 mm)	12
YT-54502	2" (50 mm)	12
YT-54503	2.5" (63 mm)	12
YT-54504	3" (76 mm)	12
YT-54505	4" (100 mm)	12

EN Flat paint brush
PL Pędzel angielski
DE Flachpinsel
RU Кисть флейцевая тип Английский
CZ Štětec anglický
HU Laposecset

RO Pensulă englezească
FR Pinceau plat anglais
IT Pennello piatto
ES Brocha plana
CN 平刷



• Application: oil, emulsion, latex and ceramic paints, impregnating paint, varnish
• Zastosowanie: farby olejne, emulsyjne, lateksowe i ceramiczne, impregnaty, lakiery



YATO 	Brush width / Szerokość pędzla	
YT-54540	1" (25 mm)	12
YT-54541	1.5" (38 mm)	12
YT-54542	2" (50 mm)	12
YT-54543	2.5" (63 mm)	12
YT-54544	3" (76 mm)	12

EN Flat paint brush
PL Pędzel angielski
DE Flachpinsel
RU Кисть флейцевая тип Английский
CZ Štětec anglický
HU Laposecset

RO Pensulă englezească
FR Pinceau plat anglais
IT Pennello piatto
ES Brocha plana
CN 平刷



• Application: oil, emulsion, latex and ceramic paints, impregnating paint, varnish
• Zastosowanie: farby olejne, emulsyjne, lateksowe i ceramiczne, impregnaty, lakiery



YATO 	Brush width / Szerokość pędzla	
YT-54550	1" (25 mm)	12
YT-54551	1.5" (38 mm)	12
YT-54552	2" (50 mm)	12
YT-54553	2.5" (63 mm)	12
YT-54554	3" (76 mm)	12

EN Flat paint brush
PL Pędzel angielski
DE Flachpinsel
RU Кисть флейцевая тип Английский
CZ Štětec anglický
HU Laposecset

RO Pensulă englezească
FR Pinceau plat anglais
IT Pennello piatto
ES Brocha plana
CN 平刷



• Application: oil, emulsion, latex and ceramic paints, impregnating paint, varnish
• Zastosowanie: farby olejne, emulsyjne, lateksowe i ceramiczne, impregnaty, lakiery



YATO 	Brush width / Szerokość pędzla	
YT-54560	1" (25 mm)	12
YT-54561	1.5" (38 mm)	12
YT-54562	2" (50 mm)	12

EN Round paint brush
PL Pędzel okrągły
DE Ringpinsel
RU Кисть круглая
CZ Kulatý štětec
HU Marokocset

RO Pensula rotundă
FR Pinceau rond
IT Pennello rotondo
ES Brocha redonda
CN 圆刷



• Application: oil, emulsion, latex and ceramic paints, impregnating paint, varnish
• Zastosowanie: farby olejne, emulsyjne, lateksowe i ceramiczne, impregnaty, lakiery



YATO 	Brush width / Szerokość pędzla [mm]	
YT-54590	16	12
YT-54591	23	12
YT-54592	29	12
YT-54593	33	12

EN Angled paint brush
PL Pędzel kątowy
DE Heizkörperpinsel
RU Кисть радиаторная
CZ Úhlová štětec
HU Radiátorecset

RO Pensula pt. calorifere
FR Pinceau à radiateur
IT Pennello ad angolo
ES Brocha angulada de radiadores
CN 平刷





• Application: oil, emulsion, latex and ceramic paints, impregnating paint, varnish
• Zastosowanie: farby olejne, emulsyjne, lateksowe i ceramiczne, impregnaty, lakiery

YATO 	Brush width / Szerokość pędzla	
YT-54620	1.5" (38 mm)	12
YT-54621	2" (50 mm)	12
YT-54622	2.5" (63 mm)	12

EN Wall brush
PL Pędzel tapetowy
DE Flächenstreicher
RU Кисть макловица
CZ Štětec na tapety dřevěný
HU Ecset fa tapétákhoz
RO Bidinea pt. tapet
FR La brosse à peinture rectangulaire
IT Pennello per carta da parati
ES Brocha de empapelar madero
CN 平刷



• Application: oil, emulsion, latex and ceramic paints, impregnating paint, varnish
• Zastosowanie: farby olejne, emulsyjne, lateksowe i ceramiczne, impregnaty, lakiery

YATO 	Size / Rozmiar [mm]	
YT-54640	110x30	2
YT-54641	140x40	2
YT-54642	150x50	2

- EN Paint bucket
- PL Kuwotka malarska
- DE Farbschale
- RU Ковш для краски
- CZ Malířská vanička
- HU Kúvetta
- RO Tavă suport trafalet
- FR Seau de peinture
- IT Ciotola per vernice
- ES Cubeta para rodillo
- CN 顏料碗



YATO		
YT-54730		80

- EN Paint mixer
- PL Mieszadło do farb ręczne
- DE Manueller Farbmischer
- RU Мешалка для красок
- CZ Míchadlo na hmoty
- HU Keverő festékekhez
- RO Mixer vopsea
- FR Mélangeur pour peintures
- IT Miscelatore manuale per vernici
- ES Mezclador para pinturas
- CN 油漆搅拌机



YATO		
YT-54670		50

- EN Painting bucket
- PL Wiadro malarskie
- DE Malereimer
- RU Ведро малярное
- CZ Vědro malířské
- HU Festővödör
- RO Căleată pt. vopsea
- FR Seau à peinture
- IT Secchio per vernice
- ES Cubo para pintar
- CN 油漆桶



YATO	V [l]	
YT-54741	8	10
YT-54742	12	10
YT-54743	15	10
YT-54744	19	10

- EN Transport roller dolly
- PL Wózek, platforma transportowa
- DE Transportplattform
- RU Транспортная тележка
- CZ Přepravní plošina
- HU Szállító platform
- RO Platforma cu roti pt. transport
- FR Chariot à plateforme
- IT Carrello a piattaforma
- ES Carro de transporte
- CN 木板搬家器



YATO	Loading plate size / Rozmiar płyty ładunkowej [mm]	
YT-37420	500x300	6

- EN Dust protection door type "U"
- PL Osłona przeciwpylowa - drzwi foliowe typu "U"
- DE Folien-Staubschutztür, U-Form
- RU Пылезащитная пленка - пленочная дверь типа "U"
- CZ Protiprachový kryt - fóliové dveře typu "U"
- HU Porvédelem - "U" típusú fóliaajtó
- RO Protecție ușă împotriva prafului tip "U"
- FR Pare-poussière - porte en plastique de type "U"
- IT Protezione antipolvere - porta in pellicola tipo "U"
- ES Puerta de protección antipolvo tipo "U"
- CN 塑料装修防尘门

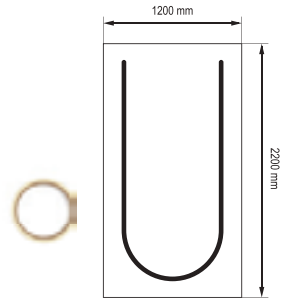

YATO	Size / Rozmiar [mm]	
YT-67220	1200x2200	12

- EN Dust protection door type "L"
- PL Osłona przeciwpylowa - drzwi foliowe typu "L"
- DE Folien-Staubschutztür, L-Form
- RU Пылезащитная пленка - пленочная дверь типа "L"
- CZ Protiprachový kryt - fóliové dveře typu "L"
- HU Porvédelem - "L" típusú fóliaajtó
- RO Protecție ușă împotriva prafului tip "L"
- FR Pare-poussière - porte en plastique de type "L"
- IT Protezione antipolvere - porta in pellicola tipo "L"
- ES Puerta de protección antipolvo tipo "L"
- CN 塑料装修防尘L

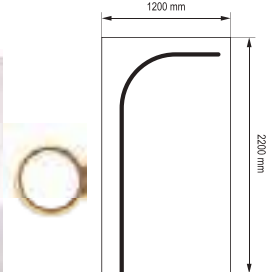

YATO	Size / Rozmiar [mm]	
YT-67221	1200x2200	12

- EN Tile adjuster
- PL Podnośnik do ułożenia płytek
- DE Fliesenheber
- RU Локатор для плитки
- CZ Zvedák k zvedání dlaždic
- HU Lapemelő
- RO Dispozitiv pt. ridicat plăci
- FR Lève panneaux
- IT Sollevatore delle piastrelle
- ES Levantador de baldosas
- CN 瓷砖抬高器

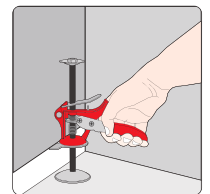

YATO		
YT-37200		10/60

- EN Transport roller dolly
- PL Wózek, platforma transportowa
- DE Transportplattform
- RU Транспортная тележка
- CZ Přepravní plošina
- HU Szállító platform
- RO Platforma cu roti pt. transport
- FR Chariot à plateforme
- IT Carrello a piattaforma
- ES Carro de transporte
- CN 木板搬家器



YATO	Loading plate size / Rozmiar płyty ładunkowej [mm]	
YT-37421	575x300	6

EN Transport dolly with handle
PL Platforma transportowa z dyszlem
DE Transportplattform mit Deichsel
RU Транспортная тележка с дышлом
CZ Přepravní plošina s madlem
HU Szállító platform vonórúddal
RO Platformă cu roți și mâner pt. transport
FR Chariot à plateforme avec timon
IT Carrello a piattaforma con impugnatura
ES Carro de transporte con asa
CN 木板搬家器

575x300 mm max 200 kg MDF



YATO Loading plate size / Rozmiar płyty ładunkowej [mm] 4
YT-37422 575x300

EN Transport dolly with handle
PL Platforma transportowa z dyszlem
DE Transportplattform mit Deichsel
RU Транспортная тележка с дышлом
CZ Přepravní plošina s madlem
HU Szállító platform vonórúddal
RO Platformă cu roți și mâner pt. transport
FR Chariot à plateforme avec timon
IT Carrello a piattaforma con impugnatura
ES Carro de transporte con asa
CN 木板搬家器

700x375 mm max 250 kg MDF



YATO Loading plate size / Rozmiar płyty ładunkowej [mm] 4
YT-37423 700x375

EN Drywall tool cart
PL Wózek do transportu płyt gipsowo-kartonowych
DE Transportwagen für Gipskartonplatten
RU Тележка для транспортировки гипсокартона
CZ Vozík pro přepravu sádro-kartonových desek
HU Gipskarton szállító kézikocsi
RO Carucior pt. transport plăci gips carton
FR Chariot pour le transport des plaques de carton-plâtre
IT Carrello per trasporto pannelli GK
ES Carro de transporte de placas cartón yeso
CN 面板运输工具车

1240x640 x1210 mm max 900 kg
203 mm
1x BRAKE HAMULEC



YATO Dimensions / Wymiary [mm] 1
YT-37430 1240x640x1210

EN Trolley for transporting large plate
PL Wózek do transportu dużych płyt
DE Plattenkarre zum Transport von großflächigen Platten
RU Тележка для перевозки больших плит
CZ Vozík pro přepravu velkých panelů
HU Lapszállító kocsi
RO Cărucior pt. transportul plăcii mari
FR Chariot porte plaque et panneau
IT Carrello porta lastre
ES Carro manual de transporte para planchas
CN 移木板车

125 mm



YATO Dimensions / Wymiary [mm] 6
YT-37433

EN Drywall tool cart
PL Wózek do transportu płyt gipsowo-kartonowych
DE Transportwagen für Gipskartonplatten
RU Тележка для транспортировки гипсокартона
CZ Vozík pro přepravu sádro-kartonových desek
HU Gipskarton szállító kézikocsi
RO Carucior pt. transport plăci gips carton
FR Chariot pour le transport des plaques de carton-plâtre
IT Carrello per trasporto pannelli GK
ES Carro de transporte de placas cartón yeso
CN 面板运输工具车

600x90 x1000 mm max 200 kg
830 mm 230 mm 260 mm



YATO Dimensions / Wymiary [mm] 1
YT-37434 600x90x1000

EN Wallboard carrier
PL Uchwyt do noszenia płyt gipsowo-kartonowych
DE Plattenträger mit Tragegriff
RU приспособление для переноски плит
CZ Držák pro přenášení desek s rukojetí
HU Jellemzők és előnyök
RO Dispozitiv pt. transportat plăci de gips-carton
FR Porte-plaques a griffes
IT Impugnatura porta lastre in cartongesso
ES Empunadura porta-placas
CN 石膏板提取器



YATO 2/12
YT-37440

EN Panel carrier
PL Uchwyt do noszenia płyt i desek
DE Tragegriff für Platten und Bretter
RU Ручка для переноски плит и досок
CZ Rukojeť pro přenášení panelů a desek
HU Fogantyú lemezek és deszkák hordozásához
RO Dispozitiv pt. transportat plăci
FR Porte plaques et panneaux
IT Maniglia per il trasporto pannelli e tavole
ES Soporte para llevar paneles y tableros
CN 石膏板提手

max 24 mm



YATO 20
YT-37441

- EN Panel carry
- PL Nosidło do płyt gipsowo-kartonowych
- DE Plattenträger mit Tragegriff
- RU Приспособление для переноски плит
- CZ Držák pro přenášení desek s rukojetí
- HU Gipszkarton hordó
- RO Dispozitiv pt. transportat plăci de gips-carton
- FR Poignée transport de plaque
- IT Porta lastre in cartongesso
- ES Porta-paneles
- CN 石膏板提手



max **80 kg**

ABS

- EN Drywall board lifter
- PL Aluminiowa dźwignia do unoszenia płyt gipsowo-kartonowych
- DE Alu-Plattenheber für Gipskartonplatten
- RU Педаль подъемная для гипсокартона
- CZ Růka pro zdvihací plošiny
- HU Gipszkarton emelő
- RO Pană de picior pt. rigips
- FR Levier à panneau
- IT Sollevatore in alluminio per lastre
- ES Levanta paneles
- CN 石膏板起板器



55 mm

AI

YATO	Max. lifting capacity / Maks. udźwig [kg]	
YT-37444	80	12

YATO		
YT-37450		10

- EN Plasterboard edge planer
- PL Strug do krawędzi płyt gipsowo-kartonowych
- DE Gipskarton-Kantenhobel
- RU Рубанок кромочный для гипсокартона
- CZ Hoblík na hrany sádrokartonu
- HU Gipszkarton élygaly
- RO Rindea pt. gips carton
- FR Rabot à chanfreiner pour plaques de plâtre
- IT Piaalla per bordi del cartongesso
- ES Cepillo biselador para cartón yeso
- CN 能刨角器



9.5-15 mm

x2 **BLADES CUTTER**

- EN 2 knives for planer set
- PL Noże do struga do płyt gipsowo-kartonowych
- DE Klingen für Gipskartonhobel
- RU Ножи для рубанка для гипсокартона
- CZ Nože do hoblíku do sádro-kartonových desek
- HU Penge gipszkarton gyaluhoz

- RO Set 2 cutite rindea
- FR Lame pour cutter de carton plâtre
- IT Lame per pialla per pannelli di cartongesso
- ES Cuchillas para cepillo de placas cartón-yeso
- CN 刀片

2 **PCS**

YATO		
YT-76260		10/60

YATO		
YT-76261		75/300

For YT-76260
Dla YT-76260



- EN Drywall stripper
- PL Obcinak dwustronny do płyt gipsowo-kartonowych
- DE Streifenschneider
- RU Рейсмус-резак для гипсокартона
- CZ Rezák na sádrokarton
- HU Gipszkarton vágó
- RO Dispozitiv reglabil de taiere a placilor de gips-carton
- FR Outil coupe cloison sèche
- IT Taglierina reversibile per cartongesso
- ES Cortador de tiras para tablaroca
- CN 石膏板切割器



2x **DOUBLE-SIDED DWU-STRONNY**

ø 28 mm

- EN Drywall stripper
- PL Obcinak dwustronny do płyt gipsowo-kartonowych
- DE Streifenschneider
- RU Рейсмус-резак для гипсокартона
- CZ Rezák na sádrokarton
- HU Gipszkarton vágó
- RO Dispozitiv reglabil de taiere a placilor de gips-carton
- FR Outil coupe cloison sèche
- IT Taglierina reversibile per cartongesso
- ES Cortador de tiras para tablaroca
- CN 石膏板切割器

DOUBLE-SIDED DWU-STRONNY

x10

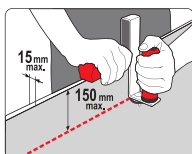

YATO		
YT-76266		6/12

- EN Drywall stripper
- PL Obcinak dwustronny do płyt gipsowo-kartonowych
- DE Streifenschneider
- RU Рейсмус-резак для гипсокартона
- CZ Rezák na sádrokarton
- HU Gipszkarton vágó
- RO Dispozitiv reglabil de taiere a placilor de gips-carton
- FR Outil coupe cloison sèche
- IT Taglierina reversibile per cartongesso
- ES Cortador de tiras para tablaroca
- CN 石膏板切割器

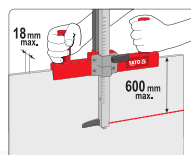

DOUBLE-SIDED DWU-STRONNY

x10



YATO		
YT-76270		1

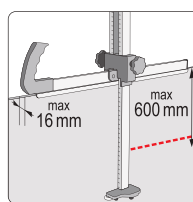

YATO		
YT-76280		6

EN Telescopic support bar
PL Podpora teleskopowa
DE Baustütze-Schnellspannstütze
RU Подъемник-распорка для гипсокартона
CZ Tuč teleskopická rozpěrná
HU Teleszkópos támasztórúd
RO Suport sustinere telescopic
FR Presse extensible
IT Supporto telescopico
ES Puntal expansion
CN 伸缩顶杆



115
60 cm
max
30 kg

EN Telescopic support bar
PL Podpora teleskopowa
DE Baustütze-Schnellspannstütze
RU Подъемник-распорка для гипсокартона
CZ Tuč teleskopická rozpěrná
HU Teleszkópos támasztórúd
RO Suport sustinere telescopic
FR Presse extensible
IT Supporto telescopico
ES Puntal expansion
CN 伸缩顶杆



290
125 cm
max
30 kg



EN Mini folding scaffold
PL Rusztowanie składane
DE Klappgerüst
RU Складные леса
CZ Skládací lešení
HU Őszecsukható állvány
RO Mini scelălă piabilă
FR Échafaudage pliant
IT Ponteggio pieghevole
ES Andamio plegable
CN 迷你脚手架

154x113.5 x86 cm
152x45.5 x14.5 cm FOLDED ZIGZORE
103.5x40 cm
89.5 cm
2x
AI



YATO
YT-30610

1

EN Work platform
PL Podest roboczy
DE Arbeitsplattform
RU Рабочая платформа
CZ Pracovní plošina
HU Munkaállvány
RO Platformă de lucru
FR Plate-forme de travail
IT Pedana da lavoro
ES Plataforma de trabajo
CN 洗车台

960x305 x490(h) mm
max
150 kg
AI



YATO
YT-30600

1

EN Seaming pliers
PL Kleszcze do gięcia blach
DE Zange zum Blechbiegen
RU Клещи кровельные
CZ Kleště na ohýbání plechu
HU Falcfogó
RO Clește pt. îndoirea tablei
FR Pince a plier la tôle
IT Pinza piega lamiera
ES Alicates para doblar chapa
CN 钣金钳

60 mm
DROP FORGED KUTE



280 mm 45°

YATO
YT-5416

L [mm]
280

10/20



260 mm 90°

YATO
YT-5417

L [mm]
260

10/20



280 mm 180°

YATO
YT-5415

L [mm]
280

10/20

EN Seaming pliers
PL Kleszcze do gięcia blach
DE Zange zum Blechbiegen
RU Клещи кровельные
CZ Kleště na ohýbání plechu
HU Falcfogó
RO Clește pt. îndoirea tablei
FR Pince a plier la tôle
IT Pinza piega lamiera
ES Alicates para doblar chapa
CN 钣金钳



100 mm

YATO
YT-54153

L [mm]
300

6

EN Single seam clench
 PL Zaciskacz rąbka pojedynczego
 DE Klemmvorrichtung für einfachen Falz
 RU Зажим одинарного фальца
 CZ Svorka pro drážkování s jednoduchým lemem
 HU Korczáró fogó
 RO Dispozitiv pt. îmbinat foi de tablă
 FR Pince à joint debout simple
 IT Pinza per aggraffatura singola
 ES Pinza de primer pliegue para junta alzada
 CN 屋顶施工工具

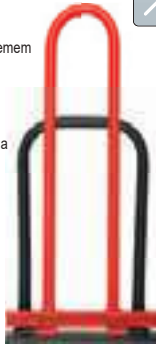

YATO	Pipe diameter / Średnica rurki [mm]	Size / Rozmiar [mm]	
YT-5400	18	480x220	5

EN Double seam clench
 PL Zaciskacz rąbka podwójnego
 DE Klemmvorrichtung für doppelten Falz
 RU Зажим двойного фальца
 CZ Svorka pro drážkování s dvojitým lemem
 HU Dupla korczáró fogó
 RO Dispozitiv pt. îmbinat foi de tablă, falt dublu
 FR Pince à double joint debout
 IT Pinza per aggraffatura doppia
 ES Pinza de segundo pliegue para junta alzada
 CN 屋顶施工工具

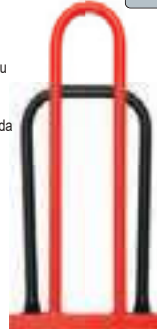

YATO	Pipe diameter / Średnica rurki [mm]	Size / Rozmiar [mm]	
YT-5402	18	480x220	5

EN Eaves clench
 PL Zaciskacz okapu
 DE Traufenklemme
 RU Зажим для карнизной планки
 CZ Svorka do okapu
 HU Ereszcáró fogó
 RO Clemă îndoi tablă pt. streșină
 FR Pince à larmier
 IT Pinza chiusura gronda
 ES Pinza para alero
 CN 屋顶施工工具



YATO	Pipe diameter / Średnica rurki [mm]	Size / Rozmiar [mm]	
YT-5405	18	450x200	5

EN Eaves turner
 PL Kantownik okapu
 DE Traufenkanter
 RU Кромкогиб для карнизной планки
 CZ Ohýbač hran okapu
 HU Ereszperemező fogó
 RO Clemă îndoi tablă
 FR Plieuse à larmier
 IT Piegatrice per gronda
 ES Pinza para doblar bandeja
 CN 屋顶施工工具



YATO	Pipe diameter / Średnica rurki [mm]	Size / Rozmiar [mm]	
YT-5404	18	450x200	5

EN Metal panel hemming tool
 PL Zaginadlo ręczne parapetowe
 DE Falzwerkzeug für Metallplatten
 RU Ручной изгиб
 CZ Nástroj na lemování parapetu
 HU Kézi korczáró szerszám
 RO Instrument de tivire a panourilor metalice
 FR Outil pour plier les appuis de fenêtre
 IT Utensile per piegare pannelli di metallo
 ES Dobladora manual de vierteaguas metálicos
 CN 金属板折边器



YATO	Working width / Szerokość robocza [mm]	L [mm]	
YT-54090	250	230	10

EN Drainpipe hooks bender
 PL Zaginacz haków rynnowych
 DE Biegevorrichtung für Rinnenhaken
 RU Инструмент для загиба крюков желобов
 CZ Ohýbač okapových háků
 HU Ereszcsatornavas hajlító

RO Dispozitiv pt. indoi carlige burlan
 FR Pince à crochets de gouttières
 IT Piegaferrì per sostegni grondaia
 ES Pinza para soportes de canalón
 CN 弯管器



YATO	L [mm]	
YT-5410	680	4

EN Rebar bender
 PL Klucz do gięcia prętów
 DE Betonstahl-Bieger
 RU Ручной ключ для гибки арматуры
 CZ Klíč pro ohýbání tyčí
 HU Kézi betonacél hajlító
 RO Dispozitiv indoi fier beton
 FR Cintreuse de barres d'armature
 IT Piegatondini
 ES Dobladora manual de barras
 CN 钢筋弯管器

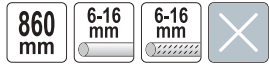

YATO	L [mm]	
YT-54200	860	2

EN Drainpipe hooks bender
 PL Zaginacz haków rynnowych
 DE Biegevorrichtung für Rinnenhaken
 RU Инструмент для загиба крюков желобов
 CZ Ohýbač okapových háků
 HU Ereszcsatornavas hajlító
 RO Dispozitiv pt. indoi carlige burlan
 FR Pince à crochets de gouttières
 IT Piegaferrì per sostegni grondaia
 ES Pinza para soportes de canalón
 CN 弯管器



YATO	L [mm]	
YT-54101	630	4

EN Pipe crimper
 PL Szczypce do karbowania rur
 DE Rohrziehzange mit 5 Klingen
 RU Ножницы по металлу для гофры
 CZ Kleště krepovací
 HU Kreppelő kullancsok
 RO Cleste gofrare burlane
 FR Pince a gauffer 5 lames
 IT Pinza per corrugare tubi
 ES Crimpadora de tubos
 CN 波浪剪



YATO	L [mm]	
YT-22380	260	6/36

EN Wire tying twister hook
 PL Klucz do wiązania drutu zbrojeniowego
 DE Rödeldraht-Drillkurbel
 RU Крючок для вязки арматуры
 CZ Radlovačka
 HU Huzalsodró
 RO Dispozitiv pt. legat fier beton
 FR Lieur
 IT Gancio per legare armature
 ES Gancho para amarrar alambre
 CN 钢筋钩

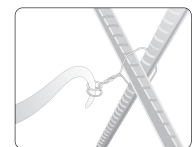

YATO	L [mm]	
YT-54230	210	50/100

EN Automatic twister hook for wire tying
PL Klucz automatyczny do skręcania drutu
DE Röhldraht-Drillkurbel
RU Автоматический крюк для вязки арматуры
CZ Spirálový vazač
HU Huzalsodró készülőék
RO Dispozitiv automat pt. legat fier beton
FR Lieur automatique
IT Torcifi lo automatico
ES Gancho para amarrar alambre automatico
CN 自动伸缩钢筋钩

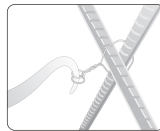

300 mm



YATO	L [mm]	
YT-54233	300	10/30

EN Paving slab lifter
PL Chwytnak do płyt chodnikowych
DE Greifer für Steinplatten
RU Захват для тротуарной плитки
CZ Uchopovač dlažebních desky
HU Járólapp fogó
RO Dispozitiv pt. ridicat dale de pavaj
FR Léve-dalle réglable
IT Maniglia per trasporto piastrelle
ES Pinzas para transportar losas
CN 提砖器



GALVANIZED
STEEL
STAL
OCYNKOWANA



YATO	Grip range / Zakres chwytu [mm]	
YT-46500	300-500	5/15
YT-46501	400-600	5/15

EN Floating rule
PL Łata murarska
DE Setzlatte
RU Правило-уровень
CZ Stahovací lat'
HU Lehúzóléc
RO Dreptar
FR Niveau à bulle
IT Livella
ES Nivel de albañil
CN 刮板

0.057°
1mm/1m
ACCURACY
DOKŁADNOŚĆ

x2



YATO	L [mm]	
YT-3071	1500	10
YT-3072	2000	10
YT-3073	2500	10
YT-3074	3000	10

EN Trapezoid floating rule
PL Łata tynkarska
DE Abziehlatte
RU Правило штукатурное
CZ Stahovací lat' trapézová
HU Trapéz lehúzóléc
RO Dreptar trapezoidal
FR Règle trapézoïdale
IT Stadia per muratore a trapezio
ES Regla de albañil
CN 梯形刮板



YATO	L [mm]	
YT-3081	1500	10
YT-3082	2000	10
YT-3083	2500	10
YT-3084	3000	10

EN Knife for roofing paper
PL Nóż do cięcia papy
DE Messer zum Schneiden von Pappe
RU Нож для резки рубероида
CZ Nůž k řezání lepenky
HU Kátrányapírvágó olló

RO Cuțit pt. tăierea cartonului bituminat
FR Couteau pour carton
IT Coltello per tagliare cartone bituminoso
ES Cuchilla para cortar cartón alquitranado
CN 多功能刀

90/230 mm

SS
STAINLESS STEEL
STAL NERZEWNA



YATO	L [mm]	
YT-7620	230	12/60

EN Wire twisting pliers
PL Szczypce do skręcania drutu
DE Drahtwirbelzange
RU Клещи для вязки арматуры
CZ Kleště na kroucení drátu
HU Dróthajlító fogó
RO Clește pt. legat fier beton
FR Pince à torsader les fils
IT Pinza torcillo
ES Alicates para torcer alambre
CN 钢筋钩

300 mm

DROP FORGED KUTE



YATO	L [mm]	
YT-54240	300	10/40

EN Brick tongs
PL Chwytnak do podnoszenia płyt lub cegieł
DE Greifer zum Heben von Platten oder Ziegeln
RU Захват для подъема плит или кирпича
CZ Nástroj pro přenášení desek a cihel
HU Csempé- és téglafogó
RO Clește caramida
FR Pince de levage pour dalles et briques
IT Pinza per sollevamento lastre o mattoni
ES Pinzas para transportar placas o ladrillos
CN 砖夹

400-670 mm



YATO	Grip range / Zakres chwytu [mm]	
YT-37470	400-670	12

EN Toothed comb with variable length
PL Łata zębata z regulowaną długością
DE Längenverstellbare Zahnlatte
RU Зубчатая рейка с регулируемой длиной
CZ Zubatá lata s nastaviteľnou dĺžkou
HU Állítható hosszúságú fogás léc
RO Riglă dințată cu lungime variabilă
FR Latte dentée réglable en longueur
IT Livellatrice a cazzuola dentata con lunghezza regolabile
ES Llana dentada con longitud ajustable
CN 瓷砖平灰器

20x15 mm

109-150 cm

x1

SS
STAINLESS STEEL
STAL NERZEWNA



YATO	L [mm]	
YT-30700	1090-1500	10

EN Knife for mineral wool
PL Nóż do cięcia izolacji budowlanych
DE Dämmstoffmesser
RU Нож для резки строительной изоляции
CZ Nůž k řezání stavebních izolačních hmot
HU Kés építésszigetelés vágásához
RO Cuțit pt. tăierea izolațiilor
FR Couteau pour isolants
IT Coltello per tagliare l'isolamento di costruzione
ES Cuchilla para cortar aislamiento de construcción
CN 多功能刀

SS
STAINLESS STEEL
STAL NERZEWNA



YATO	L [mm]	
YT-7623	500	10/50



YATO	L [mm]	
YT-7624	480	10/50

EN Electric hoist
 PL Elektryczny wciągnik linowy
 DE Elektro-Seilwinde
 RU Электрическая канатная лебёдка
 CZ Elektrický naviják kladkostroj
 HU Elektromos csőrő
 RO Troliu electric cu cablu
 FR Treuil électrique à corde
 IT Verricello elettrico
 ES Cabria eléctrica de cuerdas
 CN 电动葫芦



230V~50Hz 500 W

125kg 8m/min max 11m
250kg 4m/min max 5.5m

STOP

$L_{pA} = 52,2 \pm 1,2$ dB; $L_{wA} = 73,6 \pm 2,31$ dB

YATO	[W]	
YT-5901	500	2

EN Electric hoist
 PL Elektryczny wciągnik linowy
 DE Elektro-Seilwinde
 RU Электрическая канатная лебёдка
 CZ Elektrický naviják kladkostroj
 HU Elektromos csőrő
 RO Troliu electric cu cablu
 FR Treuil électrique à corde
 IT Verricello elettrico
 ES Cabria eléctrica de cuerdas
 CN 电动葫芦



230V~50Hz 900 W

250kg 8m/min max 11m
500kg 4m/min max 5.5m

STOP

$L_{pA} = 54,0 \pm 0,9$ dB; $L_{wA} = 78,0 \pm 6,57$ dB

YATO	[W]	
YT-5904	900	2

EN Mixer
 PL Mieszadło
 DE Rührer
 RU Мешалка
 CZ Michadlo
 HU Keverő

RO Mixer
 FR Mélangeur
 IT Frusta
 ES Mezclador
 CN 搅拌棒



• Application: powder materials, general-purpose adhesives, gypsum surface finishing mixes, epoxy grouts
 • Zastosowanie: materiały sypkie, gotowe zaprawy klejowe, masy szpachlowe, zaprawy do spoinowania

YATO	Ø [mm]	L [mm]	Toolholder type / Rodzaj uchwyty narzędziowego	Max. mixing capacity / Maks. wydajność mieszania [kg]	
YT-5490	85	410	sześciokątny	4-9	30
YT-5491	100	600	sześciokątny	6-16	16
YT-5492	85	450	SDS-Plus	4-9	30
YT-5493	100	600	SDS-Plus	6-16	16

EN Mixer
 PL Mieszadło
 DE Rührer
 RU Мешалка
 CZ Michadlo
 HU Keverő

RO Mixer
 FR Mélangeur
 IT Frusta
 ES Mezclador
 CN 搅拌棒



• Application: emulsion paints, acrylic paints, lacquers, stains, other liquid materials
 • Zastosowanie: farby emulsyjne, farby akrylowe, lakiery, bejce, inne materiały płynne

EN Electric hoist
 PL Elektryczny wciągnik linowy
 DE Elektro-Seilwinde
 RU Электрическая канатная лебёдка
 CZ Elektrický naviják kladkostroj
 HU Elektromos csőrő
 RO Troliu electric cu cablu
 FR Treuil électrique à corde
 IT Verricello elettrico
 ES Cabria eléctrica de cuerdas
 CN 电动葫芦



230V~50Hz 550 W

150kg 8m/min max 11m
300kg 4m/min max 5.5m

STOP

$L_{pA} = 52,2 \pm 0,9$ dB; $L_{wA} = 75,4 \pm 4,8$ dB

YATO	[W]	
YT-5902	550	2

EN Electric hoist
 PL Elektryczny wciągnik linowy
 DE Elektro-Seilwinde
 RU Электрическая канатная лебёдка
 CZ Elektrický naviják kladkostroj
 HU Elektromos csőrő
 RO Troliu electric cu cablu
 FR Treuil électrique à corde
 IT Verricello elettrico
 ES Cabria eléctrica de cuerdas
 CN 电动葫芦



230V~50Hz 1050 W

300kg 8m/min max 11m
600kg 4m/min max 5.5m

STOP

$L_{pA} = 58,9 \pm 1,9$ dB; $L_{wA} = 79,9 \pm 2,79$ dB

YATO	[W]	
YT-5905	1050	2

EN Mixer
 PL Mieszadło
 DE Rührer
 RU Мешалка
 CZ Michadlo
 HU Keverő

RO Mixer
 FR Mélangeur
 IT Frusta
 ES Mezclador
 CN 搅拌棒



• Application: powder materials, general-purpose adhesives, gypsum surface finishing mixes, epoxy grouts
 • Zastosowanie: materiały sypkie, gotowe zaprawy klejowe, masy szpachlowe, zaprawy do spoinowania

YATO	Ø [mm]	L [mm]	Toolholder type / Rodzaj uchwyty narzędziowego	Max. mixing capacity / Maks. wydajność mieszania [kg]	
YT-54895	60	320	sześciokątny	4-9	30

EN Mixer
 PL Mieszadło
 DE Rührer
 RU Мешалка
 CZ Michadlo
 HU Keverő



YATO	Ø [mm]	L [mm]	Toolholder type / Rodzaj uchwyty narzędziowego	Max. mixing capacity / Maks. wydajność mieszania [kg]	
YT-5494	80	400	sześciokątny	5-10	30
YT-5496	100	600	SDS-Plus	15-30	20

EN Mixer
PL Mieszadło
DE Rührer
RU Меуанка
CZ Michadlo
HU Keverő

RO Mixer
FR Mélangeur
IT Frusta
ES Mezclador
CN 搅拌棒



• Application: general-purpose adhesives, masonry mortars, jointless floors, thin-layer mineral plasters, gypsum surface finishing mixes, isolation masses

• Zastosowanie: zaprawy klejowe, zaprawy murarskie, jastrych, tynki strukturalne, masy szpachlowe, masy izolacyjne

YATO	Ø [mm]	L [mm]	Toolholder type / Rodzaj uchwytu narzędziowego	Max. mixing capacity / Maks. wydajność mieszania [kg]	
YT-5497	70	400	sześciokątny	5-10	20
YT-5499	100	600	sześciokątny	10-20	16
YT-5500	120	600	sześciokątny	15-25	14
YT-5501	100	600	SDS-Plus	10-20	16
YT-5502	120	600	SDS-Plus	15-25	14
YT-5503	120	600	M14	15-25	14
YT-5504	160	600	M14	20-30	8

EN Mixer
PL Mieszadło
DE Rührer
RU Меуанка
CZ Michadlo
HU Keverő

RO Mixer
FR Mélangeur
IT Frusta
ES Mezclador
CN 搅拌棒



• Application: mortars, concrete, plasters, other semi-fluid materials with sand or gravel filling

• Zastosowanie: zaprawy, beton, tynki, inne półpłynne, lepkie materiały z wypełnieniem piaskowym lub żwirowym

YATO	Ø [mm]	L [mm]	Max. mixing capacity / Maks. wydajność mieszania [kg]	Toolholder type / Rodzaj uchwytu narzędziowego	
YT-5506	120	600	15-25	SDS-Plus	12
YT-5507	120	600	15-25	M14	12
YT-5508	160	600	20-30	M14	8

EN Pump suction cup
PL Przyssawka z pompką próżniową
DE Saugheber mit Vakuumpumpe
RU Присоска вакуумная
CZ Vakuový držák
HU Vákuumos tapadókorong
RO Ventuză cu pompă
FR Ventouse avec pompe à vide
IT Ventosa con pompa a vuoto
ES Ventosa con bomba de vacío
CN 吸盘



Ø 204 mm
max 58 kg
ABS

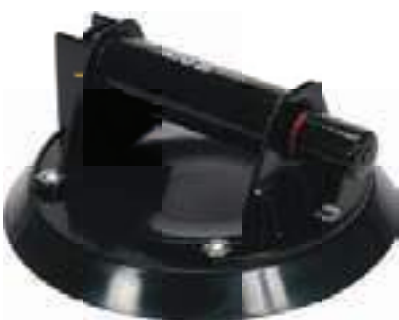

YATO	Ø [mm]	Max. lifting capacity / Maks. udźwig [kg]	
YT-37220	204	58	10

EN Pump suction cup
PL Przyssawka z pompką próżniową
DE Saugheber mit Vakuumpumpe
RU Присоска вакуумная
CZ Vakuový držák
HU Vákuumos tapadókorong
RO Ventuză cu pompă
FR Ventouse avec pompe à vide
IT Ventosa con pompa a vuoto
ES Ventosa con bomba de vacío
CN 吸盘

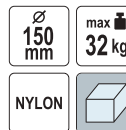

Ø 150 mm
max 32 kg
NYLON



YATO	Ø [mm]	Max. lifting capacity / Maks. udźwig [kg]	
YT-37223	150	32	24

EN Mixer
PL Mieszadło
DE Rührer
RU Меуанка
CZ Michadlo
HU Keverő

RO Mixer
FR Mélangeur
IT Frusta
ES Mezclador
CN 搅拌棒



• Application: general-purpose adhesives, masonry mortars, jointless floors, thin-layer mineral plasters, gypsum surface finishing mixes, isolation masses

• Zastosowanie: zaprawy klejowe, zaprawy murarskie, jastrych, tynki strukturalne, masy szpachlowe, masy izolacyjne

YATO	Ø [mm]	L [mm]	Toolholder type / Rodzaj uchwytu narzędziowego	Max. mixing capacity / Maks. wydajność mieszania [kg]	
YT-55027	100	600	M14	10-20	16
YT-55033	135	600	M14	20-30	10

EN Mixer
PL Mieszadło
DE Rührer
RU Меуанка
CZ Michadlo
HU Keverő

RO Mixer
FR Mélangeur
IT Frusta
ES Mezclador
CN 搅拌棒



• Application: mortars, concrete, plasters, other semi-fluid materials with sand or gravel filling

• Zastosowanie: zaprawy, beton, tynki, inne półpłynne, lepkie materiały z wypełnieniem piaskowym lub żwirowym

YATO	Ø [mm]	L [mm]	Toolholder type / Rodzaj uchwytu narzędziowego	Max. mixing capacity / Maks. wydajność mieszania [kg]	
YT-55073	135	600	M14	20-30	10

EN Suction lifter
PL Uchwyt-przyssawka do szyb
DE Glassauger
RU Стеклодомкрат
CZ Podtlakový držák na sklo
HU Vákuumos üvegfogó tappancs
RO Ventuză
FR Ventouse pour pare-brise
IT Ventosa per vetro
ES Elevador de ventosa
CN 玻璃吸盘



Ø 125 mm
max 60 kg
AI



YATO	Ø [mm]	Max. lifting capacity / Maks. udźwig [kg]	
YT-37235	125	60	30

EN Suction lifter
 PL Uchwyt-przysawka do szyb
 DE Glassauger
 RU Стеклодомкрат
 CZ Podtlakový držák na sklo
 HU Vákuumos üvegfogó tappancs
 RO Ventuză
 FR Ventouse pour pare-brise
 IT Ventosa per vetro
 ES Elevador de ventosa
 CN 玻璃吸盘

Ø 125 mm max 120 kg AI



YATO	Ø [mm]	Max. lifting capacity / Maks. udźwíg [kg]	
YT-37236	125	120	20

EN Tile suction cup
 PL Przysawka do glazury
 DE Saugnapf für Fliesen
 RU Присоска для плитки
 CZ Přísavka na obklady
 HU Lapemelő tapadókorong
 RO Ventuză pt. plăci ceramice
 FR Ventouse pour carrelage
 IT Ventosa per piastrelle
 ES Ventosa para azulejos
 CN 吸盘

Ø 125 mm max 5 kg SILICONE SILIKON



YATO	Ø [mm]	Max. lifting capacity / Maks. udźwíg [kg]	
YT-37221	125	5	60

EN Suction lifter
 PL Uchwyt-przysawka do szyb
 DE Glassauger
 RU Стеклодомкрат
 CZ Podtlakový držák na sklo
 HU Vákuumos üvegfogó tappancs
 RO Ventuză
 FR Ventouse pour pare-brise
 IT Ventosa per vetro
 ES Elevador de ventosa
 CN 玻璃吸盘

Ø 150 mm max 100 kg STEEL STAL



YATO	Ø [mm]	Max. lifting capacity / Maks. udźwíg [kg]	
YT-37238	150	100	10

EN Suction lifter
 PL Uchwyt-przysawka do szyb
 DE Glassauger
 RU Стеклодомкрат
 CZ Podtlakový držák na sklo
 HU Vákuumos üvegfogó tappancs
 RO Ventuză
 FR Ventouse pour pare-brise
 IT Ventosa per vetro
 ES Elevador de ventosa
 CN 玻璃吸盘

Ø 150 mm max 300 kg STEEL STAL



YATO	Ø [mm]	Max. lifting capacity / Maks. udźwíg [kg]	
YT-37240	150	300	5

EN Suction lifter
 PL Uchwyt-przysawka do szyb
 DE Glassauger
 RU Стеклодомкрат
 CZ Podtlakový držák na sklo
 HU Vákuumos üvegfogó tappancs
 RO Ventuză
 FR Ventouse pour pare-brise
 IT Ventosa per vetro
 ES Elevador de ventosa
 CN 玻璃吸盘

Ø 125 mm max 190 kg AI



YATO	Ø [mm]	Max. lifting capacity / Maks. udźwíg [kg]	
YT-37237	125	190	12

EN Pump suction cup
 PL Przysawka z pompką próżniową
 DE Saugheber mit Vakuumpumpe
 RU Присоска вакуумная
 CZ Vákuový držák
 HU Vákuumos tapadókorong
 RO Ventuză cu pompă
 FR Ventouse avec pompe à vide
 IT Ventosa con pompa a vuoto
 ES Ventosa con bomba de vacío
 CN 吸盘

Ø 150 mm max 60 kg ABS RUBBER GUMA



YATO	Ø [mm]	Max. lifting capacity / Maks. udźwíg [kg]	
YT-37222	150	60	24

EN Suction lifter
 PL Uchwyt-przysawka do szyb
 DE Glassauger
 RU Стеклодомкрат
 CZ Podtlakový držák na sklo
 HU Vákuumos üvegfogó tappancs
 RO Ventuză
 FR Ventouse pour pare-brise
 IT Ventosa per vetro
 ES Elevador de ventosa
 CN 玻璃吸盘

Ø 150 mm max 155 kg STEEL STAL



YATO	Ø [mm]	Max. lifting capacity / Maks. udźwíg [kg]	
YT-37239	150	155	10

EN Suction lifter
 PL Uchwyt-przysawka do szyb
 DE Glassauger
 RU Стеклодомкрат
 CZ Podtlakový držák na sklo
 HU Vákuumos üvegfogó tappancs
 RO Ventuză
 FR Ventouse pour pare-brise
 IT Ventosa per vetro
 ES Elevador de ventosa
 CN 玻璃吸盘

Ø 120 mm max 120 kg ABS



YATO	Ø [mm]	Max. lifting capacity / Maks. udźwíg [kg]	
YT-37241	120	120	10

- EN Suction lifter
PL Uchwyt-przyssawka do szyby
DE Glassauger
RU Стеклодомкрат
CZ Podtlakový držák na sklo
HU Vákuumos üvegfogó tappancs
RO Ventuză
FR Ventouse pour pare-brise
IT Ventosa per vetro
ES Elevador de ventosa
CN 玻璃吸盘



YATO	Ø [mm]	Max. lifting capacity / Maks. udźwig [kg]	
YT-37242	120	180	5

- EN Angle suction holder
PL Uchwyt-przyssawka do szyb kątowa
DE Verstellbarer Winkelsauger für Glas
RU Угловая присоска для стекла
CZ Úhlová přísavka na sklo
HU Derékszögű üvegfogó tappancs
RO Ventuză unghiulară
FR Ventouse articulée pour vitre
IT Ventosa ad angolo per vetro
ES Elevador tipo ventosa angular
CN 角度吸盘



YATO	Ø [mm]	Max. lifting capacity / Maks. udźwig [kg]	
YT-37214	118	50	10

- EN Carpenter's pencil
PL Ołówek stolarski
DE Zimmermannsbleistift
RU Карандаш столярный
CZ Tesařská tužka
HU Asztalos ceruza
- RO Creion de tâmplărie
FR Crayon menuisier
IT Matita per falegnami
ES Lapiz de carpintero
CN 木工铅笔

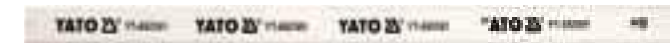

YATO	L [mm]	W [mm]	
YT-692501	245	15	144/1152

- EN Carpenter's pencil set
PL Zestaw ołówek stolarskich
DE Bleistiftset für Zimmerleute
RU Набор столярных карандашей
CZ Sada tesařských tužek
HU Asztalos ceruzakészlet
- RO Set creioane dulgherie
FR Jeu de crayons de charpentier
IT Set di matite da carpentiere
ES Juego de lapices de carpintero
CN 木工铅笔



YATO	L [mm]	W [mm]	pcs / szt.	
YT-692603	175	12	3	480
YT-692612	175	12	12	120

- EN Carpenters pencils red / blue
PL Ołówki techniczne czerwony/niebieski
DE Duo-Marker Bleistift rot / blau
- RU Карандаши красный / синий
CZ Zásuvka červená / modrá tužka
HU Fiók ceruza piros / kék
- RO Creion bicolor, rosu / albastru
FR Crayon bicolore rouge / bleu
IT Matite tecniche rosso / blu



- EN Adjustable suction cups
PL Przyssawki pozycjonujące
DE Verstellbarer Saugheber
RU Присоска для стягивания швов двухчашечная
CZ Polohovací přísavka
HU Állítható tapadókorong
RO Ventuză reglabila
FR Ventouse de manutention
IT Ventosa regolabile di allineamento
ES Ventosa de vacío ajustable
CN 瓷砖拼缝吸盘



YATO	Ø [mm]	L [mm]	
YT-37210	150	440	6

- EN Carpenter's pencil
PL Ołówek stolarski
DE Zimmermannsbleistift
RU Карандаш столярный
CZ Tesařská tužka
HU Asztalos ceruza
- RO Creion de tâmplărie
FR Crayon menuisier
IT Matita per falegnami
ES Lapiz de carpintero
CN 木工铅笔



YATO	L [mm]	W [mm]	pcs / szt.	
YT-6925	245	15	144	8



YATO	L [mm]	W [mm]	pcs / szt.	
YT-6926	245	12	144	8

- EN Masonry pencil
PL Ołówek murarski
DE Maurerbleistift
RU Карандаш каменщика
CZ Tužka zednická
HU Kőműves keverő
- RO Creion
FR Crayon maçon
IT Matita per muratori
ES Lapiz de albañil
CN 木工铅笔

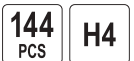

YATO	L [mm]	W [mm]	pcs / szt.	
YT-6927	245	12	144	8

- ES Cajón lapiz rojo / azul
CN 木工铅笔



YATO	
YT-69940	120

EN Automatic carpenters / masonry pencil
 PL Ołówek stolarski / murarski automatyczny
 DE Tischler- und Maurer-Druckstift
 RU Автоматический столярный карандаш / карандаш каменщика

CZ Stolářská / zednická tužka automatická
 HU Asztalos / kőműves töltőceruza
 RO Creion de tâmplărie / zidărie mecanic
 FR Crayon menuisier / maçon automatique

IT Matita per falegnami e carpentieri
 ES Lápiz automático de carpintero / albanil
 CN 自动木工铅笔

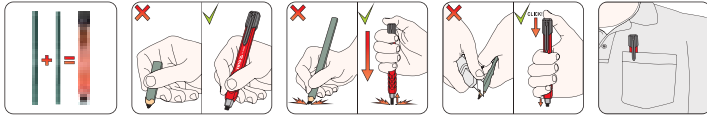

EN Automatic carpenters / masonry pencil with spare leads
 PL Ołówek stolarski / murarski automatyczny + dodatkowe grafity
 DE Tischler- und Maurer-Druckstift + zusätzliche Bleistiftmine
 RU Автоматический столярный карандаш / карандаш каменщика + дополнительный графит
 CZ Stolářská / zednická tužka automatická + náhradní tuha
 HU Asztalos / kőműves töltőceruza + tartalék grafit
 RO Creion de tâmplărie / zidărie mecanic + mină de rezervă
 FR Crayon menuisier / maçon automatique
 IT Matita per falegnami e carpentieri ricaricabile
 ES Lápiz automático de carpintero / albanil + mina adicional
 CN 自动木工铅笔组套



EN Deep hole pencil with leads
 PL Ołówek do głębokich otworów z rysikami
 DE Tieflochmarker mit Ersatzminen
 RU Карандаш для глубоких отверстий со сменными стержнями
 CZ Tužka do hlubokých otvorů s náhradními náplněmi
 HU Mélylyuk jelölő hegyekkel
 RO Creion cu mine pt. găuri adânci
 FR Crayon à trous profonds avec recharge
 IT Matita per fori profondi con marcatori
 ES Lápiz para orificios profundos con puntas de trazar
 CN 木工铅笔

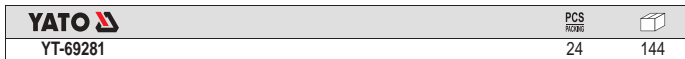
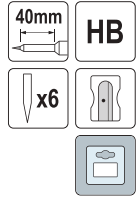

EN Lead HB
 PL Grafit HB
 DE Bleistiftmine HB
 RU Графит HB
 CZ Tuha HB
 HU Grafit HB

RO Grafit HB
 FR Mine HB
 IT Grafite HB
 ES Mina HB
 CN 自动木工铅笔笔芯



For YT-69280, YT-69281
 Dla YT-69280, YT-69281



EN Lead HB
 PL Grafit HB
 DE Bleistiftmine HB
 RU Графит HB

CZ Tuha HB
 HU Grafit HB
 RO Grafit HB
 FR Mine HB



For YT-69280, YT-69281
 Dla YT-69280, YT-69281



EN Chalk set
 PL Kreda techniczna
 DE Signierkreide
 RU Мелок для рисования

CZ Barevná křída
 HU Színes kréta
 RO Set creioane cerate
 FR Craie pour le dessin

IT Gesso tecnico
 ES Tiza técnica
 CN 记号蜡笔



12 PCS 120x12 mm METAL CONCRETE BETON GLASS SZKLO WOOD DREWING RUBBER GUMA STONE KAMEN

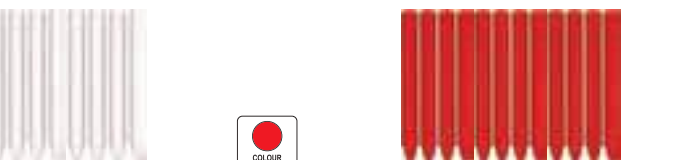

Memo



14

Measuring tools
Narzędzia miernicze



Hygrometers
Higrometry

316 

Electronic measuring tools
Elektroniczne urządzenia pomiarowe

322-325 

Measuring tapes
Miary zwijane

316-317 

Leveling patches
Łaty niwelacyjne

325 

Rulers
Przymiary

318 

Levels
Poziomnice

326-327 

Steel set squares
Ekierki metalowe

318 

Feelers
Szczelinomierze

328 

Try squares
Kątowniki stolarskie

318-320 

Dividers & calipers
Cyrkle i macki

328 

Vernier calipers
Suwmiarki

321 

Protractors
Kątomierze

329 

Micrometers
Mikrometry

321 

Screw pitch gauges
Sprawdziany grzebieniowe do gwintów

329 

EN Hygrometer
 PL Higrometr
 DE Hygrometer
 RU Гигрометр
 CZ Hygrometr
 HU Higrométer
 RO Higrometru
 FR Hygrometre
 IT Igrometro
 ES Higrómetro
 CN 湿度测试仪

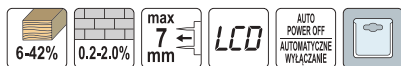

YATO **YT-73140** 54/108

EN Hygrometer
 PL Higrometr
 DE Hygrometer
 RU Гигрометр
 CZ Hygrometr
 HU Higrométer



YATO **YT-73141** 20/40

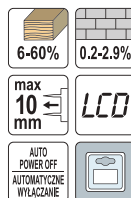

EN Measuring tape
 PL Miara zwijana
 DE Rollbandmass
 RU Пынетка
 CZ Měřicí pásmo
 HU Mérőszalag
 RO Ruletă
 FR Ruban à mesurer
 IT Metro a nastro
 ES Flexómetro
 CN 卷尺

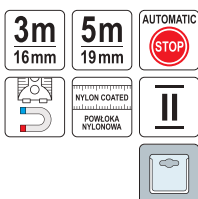

YATO	L [m]	W [mm]	
YT-7103	3	16	12/120
YT-7105	5	19	12/120

EN Measuring tape
 PL Miara zwijana
 DE Rollbandmass
 RU Пынетка
 CZ Měřicí pásmo
 HU Mérőszalag
 RO Ruletă
 FR Ruban à mesurer
 IT Metro a nastro
 ES Flexómetro
 CN 卷尺

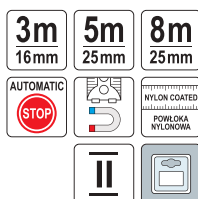

YATO	L [m]	W [mm]	
YT-7110	3	16	12/120
YT-7111	5	25	12/60
YT-7112	8	25	6/60

EN Measuring tape
 PL Miara zwijana
 DE Rollbandmass
 RU Пынетка
 CZ Měřicí pásmo
 HU Mérőszalag
 RO Ruletă
 FR Ruban à mesurer
 IT Metro a nastro
 ES Flexómetro
 CN 卷尺

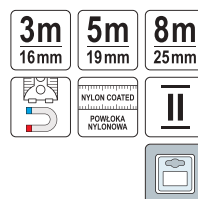

YATO	L [m]	W [mm]	
YT-7126	3	16	12/120
YT-7127	5	19	12/120
YT-7128	8	25	6/60

EN Measuring tape
 PL Miara zwijana
 DE Rollbandmass
 RU Пынетка
 CZ Měřicí pásmo
 HU Mérőszalag
 RO Ruletă
 FR Ruban à mesurer
 IT Metro a nastro
 ES Flexómetro
 CN 卷尺

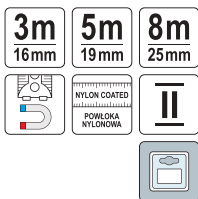

YATO	L [m]	W [mm]	
YT-7129	3	16	12/120
YT-7130	5	19	12/120
YT-7131	8	25	6/60

EN Measuring tape
 PL Miara zwijana
 DE Rollbandmass
 RU Пынетка
 CZ Měřicí pásmo
 HU Mérőszalag
 RO Ruletă
 FR Ruban à mesurer
 IT Metro a nastro
 ES Flexómetro
 CN 卷尺

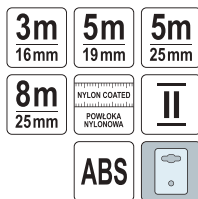

YATO	L [m]	W [mm]	
YT-71070	3	16	12/120
YT-71071	5	19	12/96
YT-71072	5	25	12/72
YT-71073	8	25	6/48

EN Measuring tape
 PL Miara zwijana
 DE Rollbandmass
 RU Пынетка
 CZ Měřicí pásmo
 HU Mérőszalag
 RO Ruletă
 FR Ruban à mesurer
 IT Metro a nastro
 ES Flexómetro
 CN 卷尺

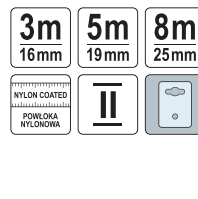

YATO	L [m]	W [mm]	
YT-71075	3	16	12/120
YT-71076	5	19	12/96
YT-71077	8	25	6/48

EN Measuring tape
PL Miara zwijana
DE Rollbandmass
RU Рулетка
CZ Měřicí pásmo
HU Mérőszalag
RO Ruletă
FR Ruban à mesurer
IT Metro a nastro
ES Flexómetro
CN 卷尺

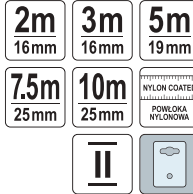

YATO	L [m]	W [mm]	
YT-7-1150	2	16	12/120
YT-7-1151	3	16	12/120
YT-7-1153	5	19	12/96
YT-7-1155	7.5	25	6/48
YT-7-1156	10	25	6/36

EN Measuring tape
PL Miara zwijana
DE Rollbandmass
RU Рулетка
CZ Měřicí pásmo
HU Mérőszalag
RO Ruletă
FR Ruban à mesurer
IT Metro a nastro
ES Flexómetro
CN 卷尺

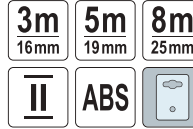

YATO	L [m]	W [mm]	
YT-7-1080	3	16	12/120
YT-7-1081	5	19	12/120
YT-7-1082	8	25	6/48

EN Measuring tape
PL Miara zwijana
DE Rollbandmass
RU Рулетка
CZ Měřicí pásmo
HU Mérőszalag
RO Ruletă
FR Ruban à mesurer
IT Metro a nastro
ES Flexómetro
CN 卷尺

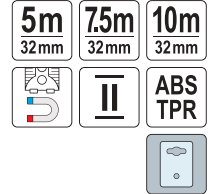

YATO	L [m]	W [mm]	
YT-7-1085	5	32	6/36
YT-7-1086	7.5	32	6/36
YT-7-1087	10	32	6/24

EN Measuring tape
PL Miara zwijana
DE Rollbandmass
RU Рулетка
CZ Měřicí pásmo
HU Mérőszalag
RO Ruletă
FR Ruban à mesurer
IT Metro a nastro
ES Flexómetro
CN 卷尺

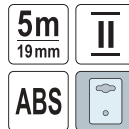

YATO	L [m]	W [mm]	
YT-7-1320	5	19	6/60

EN Steel measuring tape
PL Taśma miernicza stalowa
DE Rollbandmass
RU Мерная лента стальная
CZ Měřicí pásmo ocelové
HU Acél mérőszalag
RO Ruleta sticlă
FR Ruban à mesurer acier
IT Misura di nastro a acciaio
ES Cinta de medir de acero
CN 钢卷尺



YATO	L [m]	W [mm]	
YT-7-1580	20	13	10/40
YT-7-1581	30	13	10/40
YT-7-1582	50	13	5/20

EN Fibreglass measuring tape
PL Taśma miernicza z włókna szklanego
DE Rollbandmass
RU Мерная лента фиберглас
CZ Měřicí pásmo - skleněné vlákno
HU Mérőszalag - üvegszál
RO Ruleta fibra sticlă
FR Ruban à mesurer fibre-verre
IT Misura di nastro in fibra di vetro
ES Cinta de medir - fibra cristal
CN 纤维卷尺

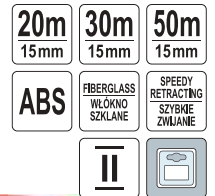

YATO	L [m]	W [mm]	
YT-7-1570	20	15	10/40
YT-7-1571	30	15	10/40
YT-7-1572	50	15	5/20

EN Fibreglass measuring tape
PL Taśma miernicza z włókna szklanego
DE Rollbandmass
RU Мерная лента фиберглас
CZ Měřicí pásmo - skleněné vlákno
HU Mérőszalag - üvegszál
RO Ruleta fibra sticlă
FR Ruban à mesurer fibre-verre
IT Misura di nastro in fibra di vetro
ES Cinta de medir - fibra cristal
CN 纤维卷尺

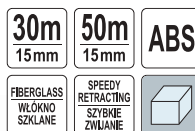

YATO	L [m]	W [mm]	
YT-7-1540	30	15	10
YT-7-1541	50	15	10

EN Diameter and circumference measuring tape
PL Taśma stalowa do pomiaru średnicy i obwodu
DE Umfang Bandmass
RU Циркометр для измерения длины окружности и диаметра
CZ Cirkometry-měřicí pásky pro obvod a průměr
HU Circometer szalagos mérés
RO Banda pt. masurat circumferinta
FR Ruban à mesurer circomètre
IT Metro a nastro in acciaio per misurare diametro e circonferenza
ES Circometer cinta métrica
CN 圆周尺



YATO	Ø [mm]	Circumference / Obwód [mm]	
YT-7-1700	20-300	60-950	50
YT-7-1701	300-700	940-2200	50
YT-7-1702	700-1100	2190-3460	50

EN Stainless steel flexible ruler
 PL Przymiar stalowy elastyczny
 DE Metrisches Gerade Lineal Inox
 RU Линейка гибкие, нержавеющей сталь
 CZ Měřítko z nerezové pružinové oceli
 HU Acél vonalzó

RO Riglă de măsură din oțel inoxidabil
 FR Règle métallique en inox
 IT Righello flessibile in acciaio
 ES Regla flexible acero inox
 CN 钢直尺

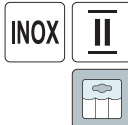

EN Aluminium ruler
 PL Przymiar aluminiowy
 DE Alu Zeichen-Massstab
 RU Линейка алюминиевая
 CZ Hliníkové pravítko
 HU Alumínium vonalzó

RO Riglă aluminiu
 FR Règle aluminium
 IT Righello di alluminio
 ES Regla de aluminio
 CN 铝合金直尺



YATO	L [mm]	
YT-70720	150	10/500
YT-70721	300	12/300
YT-70722	500	20/120
YT-70723	600	20/120
YT-70724	1000	20/60

YATO	L [mm]	
YT-7070	300	25/100
YT-7071	600	10/50

EN Safety cutting ruler
 PL Linijka do bezpiecznego cięcia
 DE Sicherheits-Schneidelineal
 RU Линейка для безопасной резки
 CZ Bezpečnostní řezací pravítko
 HU Biztonsági vágó vonalzó

RO Riglă de tăiere cu protecție
 FR Règle pour couper en sécurité
 IT Righello da taglio
 ES Regla para corte seguro
 CN 防护尺



EN Aluminium ruler
 PL Przymiar aluminiowy
 DE Alu Zeichen-Massstab
 RU Линейка алюминиевая
 CZ Hliníkové pravítko
 HU Alumínium vonalzó

RO Riglă aluminiu
 FR Règle aluminium
 IT Righello di alluminio
 ES Regla de aluminio
 CN 铝合金直尺



YATO	L [mm]	
YT-70725	200	20/200
YT-70726	300	20/120
YT-70727	450	10/80

YATO	L [mm]	
YT-70713	500	8/32
YT-70715	1000	8/32

EN Steel set square
 PL Ekiarka metalowa
 DE Anschlagwinkeldreieck
 RU Угольник для плотника и столяра
 CZ Úhelník
 HU Fém derékszög
 RO Echer tamplarie
 FR Équerre de menuisier
 IT Squadra metallica
 ES Escuadra metálica
 CN 铝合金三角尺



EN Aluminium alloy triangle
 PL Kątownik ciesielski do krokwi
 DE Anschlagwinkeldreieck
 RU Угольник для плотника и столяра
 CZ Úhelník na meranie
 HU Fém derékszög
 RO Echer aluminiu pt. dulgherie
 FR Équerre triangle règle
 IT Squadra da carpentiere
 ES Escuadra metálica
 CN 铝合金三角尺



EN Adjustable quick square
 PL Ekiarka metalowa - kątownik
 DE Metall-Dreieck - Winkelmesser
 RU Металлический угольник
 CZ Kovový úhelník
 HU Fém vonalzó - derékszög
 RO Echer reglabil
 FR Equerre de charpentier avec rapporteur d'angle
 IT Squadra da disegno metallica
 ES Escuadra metálica
 CN 金属三角三角板



YATO	L [mm]	
YT-70780	170	6/72
YT-70781	270	6/36

YATO	L [mm]	
YT-70786	180	8/64
YT-70787	300	6/24

YATO	Dimensions / Wymiary [mm]	
YT-70782	175x175x275	6/24

EN Extension layout tool
 PL Kątownik aluminiowy ze stopką - ekiarka
 DE Aluminium-Quadrat mit Fuß - Metall-Winkelmaß - Winkelmesser
 RU Алюминиевый угольник с основанием - металлический угольник - угольник
 CZ Hliníkový úhelník s patkou - kovový úhelník - úhleník
 HU Talpas alumínium derékszög - fém vonalzó - derékszög
 RO Echer reglabil cu talpă
 FR Cornière en aluminium avec pied - équerre en métal - rapporteur
 IT Squadra in alluminio con piede - squadra da disegno metallica - squadra
 ES Escuadra de aluminio con pie, metálica
 CN 铝合金三角尺



YATO	Dimensions / Wymiary [mm]	
YT-70783	165x185x210-290	6/24

EN Folding builder's square
 PL Kątownik budowlany składany
 DE Bauwinkel Klappbar
 RU Угольник складной строительный
 CZ Skládací stavařský úhelník
 HU Összecsukható derékszög
 RO Echer pliabil din aluminiu
 FR Équerre pliante
 IT Squadra da muratore pieghevole
 ES Escuadra plegable construcción
 CN 折叠铝合金角尺



YATO	Dimensions / Wymiary [mm]	
YT-70850	840x600x600	6/24
YT-70851	1720x1220x1220	10

EN Aluminium try square
PL Kątownik do płyt gipsowo-kartonowych
DE Anschlagwinkel
RU Угольник столярный
CZ Truhlářský úhelník černý
HU Asztalos derékszög, fekete

RO Echer de tâmplărie negru
FR Équerre
IT Squadra per pannelli in gesso
ES Escuadra de aluminio
CN 角尺

1200 mm
90°
±0.03 mm
AI



YATO	L [mm]	
YT-7085	1200	10

EN Try square
PL Kątownik stalowy
DE Anschlagwinkel
RU Угольник столярный
CZ Truhlářský úhelník
HU Asztalos derékszög
RO Echer de tâmplărie
FR Équerre
IT Angolo di acciaio
ES Escuadra
CN 不锈钢角尺

SS
STAINLESS STEEL
STAL NIERDZEWNA



YATO	Size / Rozmiar [mm]	
YT-7083	150x300	25/100
YT-7084	250x500	10/50

EN Combination square
PL Kątownik ślusarski nierdzewny
DE Edelstahl-Schlosserwinkel
RU Угольник слесарный
CZ Zámečnický úhelník nerezový
HU Rozsdamentes lakatos derékszög
RO Echer combinat
FR Équerre de serrurier en acier inoxydable
IT Squadra per fabbro in acciaio inox
ES Escuadra de cerrajero inoxidable
CN 角尺

150 mm
x1
SS
STAINLESS STEEL
STAL NIERDZEWNA



YATO	L [mm]	
YT-7084	150	6/48

EN Aluminium try square
PL Kątownik aluminiowy
DE Alu-Zimmermannswinkel
RU Угольник столярный алюминиевый
CZ Truhlářský úhelník černý
HU Asztalos derékszög
RO Echer reglabil
FR Règle d'angle
IT Angolo di alluminio
ES Escuadra de aluminio
CN T型尺

mm inch
AI



YATO	Size / Rozmiar [mm]	
YT-70791	600x360	6/24
YT-70792	1220x560	6/12

EN Aluminium try square
PL Kątownik aluminiowy
DE Anschlagwinkel
RU Угольник столярный
CZ Truhlářský úhelník
HU Asztalos derékszög
RO Echer de tâmplărie
FR Équerre en aluminium
IT Angolo di alluminio
ES Escuadra de aluminio
CN 铝合金角尺

45° 90° AI



YATO	L [mm]	
YT-7080	250	6/36
YT-7081	300	6/36
YT-7082	350	6/36

EN Carpentry square set
PL Zestaw kątowników stolarskich
DE Tischlerwinkelsatz
RU Набор столярных уголков
CZ Sada tesafských úhelníků
HU Asztalos derékszög készlet
RO Set echer tamplarie
FR Jeu d'équerres de menuiserie
IT Set di squadra da carpentiere
ES Conjunto de escuadras de carpintero
CN 木工角尺

4 PCS
BRASS MOSIADZ
SS2Cr13



YATO	L [mm]	
YT-70823	180, 235, 250, 250	4/40

EN Adjustable ruler
PL Kątownik nastawny do przenoszenia wymiarów
DE Multifunktionales Messlineal
RU Разметочный инструмент линейка-шаблон
CZ Pokosník nastavitelný
HU Szögmérőtékek
RO Echer reglabil
FR Angle mesure
IT Squadra regolabile tracciatore
ES Medición del ángulo
CN 铝合金四折尺

120x250 mm
mm inch
AI



YATO	Size / Rozmiar [mm]	
YT-70880	250x120	10/50

EN Adjustable angle square
PL Kątownik nastawny
DE Einstellbarer Winkel
RU Регулируемый угольник
CZ Nastavitelný úhloměr
HU Állítható asztalos derékszög
RO Echer reglabil
FR Règle d'angle réglable
IT Squadra regolabile
ES Escuadra ajustable
CN 可调整角度尺

45° 90° 135° 300 mm
AI
SS
STAINLESS STEEL
STAL NIERDZEWNA



YATO	L [mm]	
YT-70794	300 (listwa), 160 (stopka)	60

EN Multi-purpose bevel
 PL Kątownik wielofunkcyjny
 DE Mehrzweck-Winkelhalter
 RU Многофункциональный угольник
 CZ Multifunkční úhelník
 HU Multifunkciós derékszög
 RO Raportor multifuncțional cu nivelă
 FR Règle d'angle multifonction
 IT Squadra multifunzionale
 ES Escuadra multifunción
 CN 组合角尺

45°	90°	150 mm	mm inch
x1	Al	SS STAINLESS STEEL STAL NIERZCENNA	



YATO	L [mm]	
YT-70770	150	12/72

EN Multi-purpose bevel with protract
 PL Kątownik wielofunkcyjny centrujący
 DE Zentrier-Mehrzweck-Winkelhalter
 RU Многофункциональный центрирующий угольник
 CZ Multifunkční centrovací úhelník
 HU Multifunkciós központosító derékszög
 RO Raportor multifuncțional cu nivelă
 FR Règle de centrage multifonctionnel
 IT Squadra multifunzionale centrante
 ES Escuadra multifunción de centrage
 CN 组合角尺

45°	90°	300 mm	mm inch
x1	Al	SS STAINLESS STEEL STAL NIERZCENNA	



YATO	L [mm]	
YT-70772	300	12/36

EN 3D aluminium mitre square
 PL Kątownik przestrzenny
 DE Raum-Winkelstahl
 RU Пространственный угольник
 CZ Posuvný úhelník
 HU 3D vonalzó

RO Echer aluminiu 3D
 FR Équerre japonaise
 IT Squadra tridimensionale
 ES Escuadra tridimensional
 CN 木工角尺

3D	METRIC METRYCZNY
Al	



YATO	Dimensions / Wymiary [mm]	
YT-70825	150x70x215	10/50

EN Multi-purpose bevel
 PL Kątownik wielofunkcyjny
 DE Mehrzweck-Winkelhalter
 RU Многофункциональный угольник
 CZ Multifunkční úhelník
 HU Multifunkciós derékszög
 RO Raportor multifuncțional cu nivelă
 FR Règle d'angle multifonction
 IT Squadra multifunzionale
 ES Escuadra multifunción
 CN 组合角尺

45°	90°	300 mm	mm inch
x1	Al	SS STAINLESS STEEL STAL NIERZCENNA	



YATO	L [mm]	
YT-70771	300	12/72

EN 3D aluminium mitre square
 PL Kątownik aluminiowy 3D
 DE Winkel mit Gehrung
 RU Угольник алюминиевый 3D
 CZ Japonský 3D úhelník
 HU Alu derékszög 3D

RO Echer pt. imbinari
 FR Japonais en alliage d'aluminium bois règle
 IT Squadra in alluminio 3D
 ES Japonés regla de aluminio cuadrado diseño
 CN 划线尺

3D	45°
90°	Al



YATO	L [mm]	
YT-70797	300	25/100

EN 3D aluminium mitre square
 PL Kątownik aluminiowy 3D
 DE Winkel mit Gehrung
 RU Угольник алюминиевый 3D
 CZ Japonský 3D úhelník
 HU Alu derékszög 3D

RO Echer pt. imbinari
 FR Japonais en alliage d'aluminium bois règle
 IT Squadra in alluminio 3D
 ES Japonés regla de aluminio cuadrado diseño
 CN 铝合金划线尺

3D	45°
90°	Al

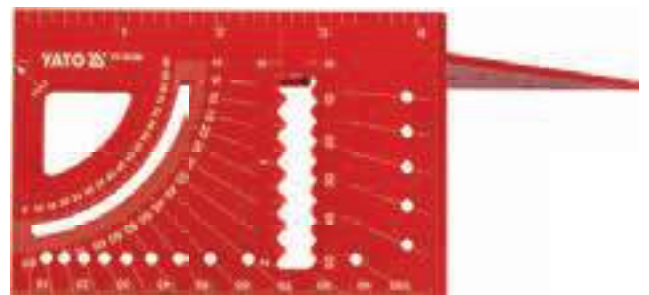



YATO	L [mm]	
YT-70796	300	10/100

EN Vernier caliper
PL Suwmiarka
DE Messschieber
RU Штангенциркуль
CZ Posuvné měřtko
HU Tolóméró

RO Şubler
FR Pied à coulisse
IT Calibro
ES Calibrador vernier
CN 游标卡尺

0-150 mm
mm
inch
+/- 0.02 mm
SS
STAINLESS STEEL
STAL NERDZEWNA





YATO 			Measuring range / Zakres pomiaru [mm]	
YT-7200	0-150	50		

EN Vernier caliper
PL Suwmiarka
DE Messschieber
RU Штангенциркуль
CZ Posuvné měřtko
HU Tolóméró

RO Şubler
FR Pied à coulisse
IT Calibro
ES Calibrador vernier
CN 游标卡尺

mm
inch
+/- 0.02 mm
SS
STAINLESS STEEL
STAL NERDZEWNA





YATO 			Measuring range / Zakres pomiaru [mm]	
YT-72003	0-200	30		
YT-72004	0-300	20		

EN Disc brake vernier caliper
PL Suwmiarka do tarcz hamulcowych
DE Scheibenbremse noniusschieber
RU Штангенциркуль для тормозных листов
CZ Digitální posuvné měřtko na brzdové kotouče
HU Tárcsafék tolóméró
RO Şubler pt. măsurat discuri de frână
FR Disque de frein etrier vernier
IT Calibro a corsoio per dischi del freno
ES Freno de disco pie de rey
CN 制动片卡尺

160 mm
0-60 mm
+/- 0.01 mm
SS
STAINLESS STEEL
STAL NERDZEWNA





YATO 			Measuring range / Zakres pomiaru [mm]	
YT-72090	0-60	50		

EN Micrometer
PL Mikrometr
DE Mikrometer
RU Микрометр

CZ Mikrometr
HU Mikrométer
RO Micrometru
FR Micromètre

+/- 0.01 mm





YATO 			Measuring range / Zakres pomiaru [mm]	
YT-72300	0-25	100		
YT-72301	25-50	50		
YT-72302	50-75	50		
YT-72303	75-100	30		

EN Digital caliper
PL Suwmiarka elektroniczna
DE Digital Messschieber
RU Штангенциркуль электронный
CZ Posuvné měřtko elektronické
HU Digitális tolóméró

RO Şubler electronic
FR Pied à coulisse électronique
IT Calibro
ES Calibrador vernier digital
CN 数显卡尺

0-150 mm
mm
inch
+/- 0.03 mm
LCD
1x SR44
SS
STAINLESS STEEL
STAL NERDZEWNA





YATO 			Measuring range / Zakres pomiaru [mm]	
YT-7201	0-150	10/50		

EN Vernier caliper
PL Suwmiarka
DE Messschieber
RU Штангенциркуль
CZ Posuvné měřtko
HU Tolóméró

RO Şubler
FR Pied à coulisse
IT Calibro
ES Calibrador vernier
CN 游标卡尺

0-600 mm
mm
inch
+/- 0.05 mm
AI





YATO 			Measuring range / Zakres pomiaru [mm]	
YT-70740	0-600	12/24		

EN Disc brake digital caliper
PL Suwmiarka elektroniczna do tarcz hamulcowych
DE Digitalen Scheibenbremse
RU Штангенциркуль электронный для тормозных листов
CZ Elektronické posuvné měřtko na brzdové kotouče
HU Elektronikus tárcsafék tolóméró
RO Şubler pt. măsurat discuri de frana cu display digital
FR Disque de frein etrier électronique
IT Calibro a corsoio elettronico per dischi del freno
ES Pie de rey digital para discos de freno
CN 制动片卡尺

mm
inch
180 mm
0-70 mm
+/- 0.03 mm
55mm
LCD
SS
STAINLESS STEEL
STAL NERDZEWNA
1x CR2032





YATO 			Measuring range / Zakres pomiaru [mm]	
YT-72093	0-70	50		

EN Micrometer with a digital display
PL Mikrometr z wyświetlaczem cyfrowym
DE Mikrometer mit Digitalanzeige
RU Микрометр с цифровым индикатором
CZ Mikrometr s digitálním displejem
HU Mikrométer digitális kijelzővel
RO Micrometru cu afişaj digital
FR Micromètre
IT Micrometro con digitale elettronico
ES Micrómetro con pantalla digital
CN 数显外径千分尺

mm
inch
0-25 mm
+/- 0.001 mm
LCD



YATO 			Measuring range / Zakres pomiaru [mm]	
YT-72305	0-25	50		

EN Laser distance meter with tape measure and cross laser line
 PL Dalmierz laserowy z miarą zwiżaną i laserem krzyżowym
 DE Laserentfernungsmesser mit Maßband und Kreuzlaser
 RU Лазерный дальномер с рулеткой и перекрестными лучами
 CZ Laserový dálkoměr s měřicí páskou a křížovým laserem
 HU Lézeres távolságmérő mérőszalaggal és kereszt lézérrel
 RO Telemetru laser, cu ruleta
 FR Télémètre laser avec ruban à mesurer et laser croisé
 IT Tracciatore laser con metro a rullo e laser a raggio incrociato
 ES Telémetro láser con cinta métrica y láser cruzado
 CN 激光卷尺测距仪



3 in 1 3 w 1	5m 19mm	II	0.2-40m ±2mm
90°	CLASS II LASER	MEMORY PAMIĘĆ	LCD
ABS	2x AAA		



YATO **YT-73122** 20

EN Laser distance meter
 PL Dalmierz laserowy
 DE Laserentfernungsmesser
 RU Лазерный дальномер
 CZ Laserový měřič vzdálenosti
 HU Lézeres távolságmérő
 RO Telemetru cu laser
 FR Télémètre laser
 IT Misuratore di distanza laser
 ES Medidor de distancia láser
 CN 激光测距仪



40m	0.2-40m ±2mm
	x20 MEMORY PAMIĘĆ
x10 MODES TRYBY	CONSTANT ANGLE PITCH MEASUREMENT CIĄGŁY POMIAR KĄTA NACHYLENIA
IP65	USB
3x AAA	

EN Laser distance meter
 PL Dalmierz laserowy
 DE Laserentfernungsmesser
 RU Лазерный дальномер
 CZ Laserový měřič vzdálenosti
 HU Lézeres távolságmérő
 RO Telemetru cu laser
 FR Télémètre laser
 IT Misuratore di distanza laser
 ES Medidor de distancia láser
 CN 激光测距仪



60m	0.2-60m ±2mm
	x20 MEMORY PAMIĘĆ
x10 MODES TRYBY	CONSTANT ANGLE PITCH MEASUREMENT CIĄGŁY POMIAR KĄTA NACHYLENIA
IP65	USB
3x AAA	

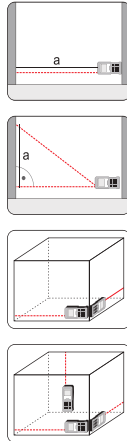
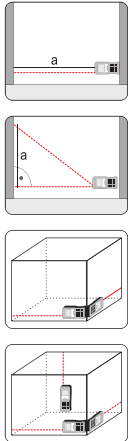

YATO **YT-73126** 20

YATO **YT-73127** 20

EN Laser distance meter
 PL Dalmierz laserowy
 DE Laserentfernungsmesser
 RU Лазерный дальномер
 CZ Laserový měřič vzdálenosti
 HU Lézeres távolságmérő
 RO Telemetru cu laser
 FR Télémètre laser
 IT Misuratore di distanza laser
 ES Medidor de distancia láser
 CN 激光测距仪



50m	0.05-50m ±2mm
	x99 MEMORY PAMIĘĆ
x6 MODES TRYBY	MAX MIN
DIGITAL LEVEL CYFROWA POZIOMICA	CALIBRATION MODE TRYB KALIBRACJI
2x AAA	

EN Laser distance meter
 PL Dalmierz laserowy
 DE Laserentfernungsmesser
 RU Лазерный дальномер
 CZ Laserový měřič vzdálenosti
 HU Lézeres távolságmérő
 RO Telemetru cu laser
 FR Télémètre laser
 IT Misuratore di distanza laser
 ES Medidor de distancia láser
 CN 激光测距仪



100m	0.05-100m ±2mm
	x99 MEMORY PAMIĘĆ
x6 MODES TRYBY	MAX MIN
DIGITAL LEVEL CYFROWA POZIOMICA	CALIBRATION MODE TRYB KALIBRACJI
2x AAA	

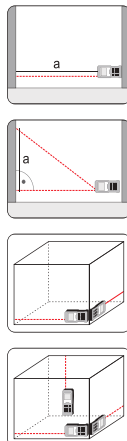
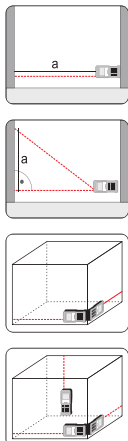

YATO **YT-731251** 50

YATO **YT-731252** 50

EN Laser distance meter
PL Dalmierz laserowy
DE Laserentfernungsmesser
RU Лазерный дальномер
CZ Laserový měřič vzdálenosti
HU Lézeres távolságmérő
RO Telemetru cu laser
FR Télémètre laser
IT Misuratore di distanza laser
ES Medidor de distancia láser
CN 激光测距仪



5-900m
±1m
905 nm
0-300
±5 km/h
H
CLASS / KLASA II
2x AAA

YATO

YT-73129

30

EN Distance measuring wheels
PL Kolo miernicze
DE Messrad
RU Колесо измерительное
CZ Kolečko pro měření vzdálenosti
HU Kicsi mérőkerék
RO Roată de măsură
FR Roues de mesure
IT Ruota di misurazione
ES Ruedas de medición
CN 测距轮



0.1-9999.9 m
0.5% ACCURACY / DOKŁADNOŚĆ
160 mm
38-92 cm
AI



YATO

YT-71650

8

EN Distance measuring wheels
PL Kolo miernicze
DE Messrad
RU Колесо измерительное
CZ Kolečko pro měření vzdálenosti
HU Kicsi mérőkerék
RO Roată de măsură
FR Roues de mesure
IT Ruota di misurazione
ES Ruedas de medición
CN 测距轮



m/ft 0.1-9999.9 m
0.5% ACCURACY / DOKŁADNOŚĆ
160 mm
LCD
82-104 cm
AI ABS



YATO

YT-71655

10

EN Cross line green laser
PL Laser krzyżowy zielony
DE Grüne Kreuzlinien-Laser
RU Лазерный уровень зеленый крест
CZ Laser zelený křížový
HU Zöld keresztlézér
RO Nivelă cu laser verde
FR Niveau laser à croix verte
IT Livella laser verde a linee incrociate
ES Nivel láser verde en cruz
CN 激光水平仪

±3.0 mm /10 m
LÁZER KÖZVETLEN DOKLADNOSZ/LASER
±4°
SEL-FEJESZÁLLÍTÉS / SAMOREGULACJA
510-530 nm
1/4" (6.3 mm)
TRIPÓD THREAD / GWINT STĄTYWY
°C -10 +50
≤1 mW
CLASS / KLASA II
IP54
6V
4x AA



YATO

YT-30433

30

EN Cross line green laser
PL Laser krzyżowy zielony
DE Grüne Kreuzlinien-Laser
RU Лазерный уровень зеленый крест
CZ Laser zelený křížový
HU Zöld keresztlézér
RO Nivelă cu laser verde
FR Niveau laser à croix verte
IT Livella laser verde a linee incrociate
ES Nivel láser verde en cruz
CN 激光水平仪

±3.0 mm /10 m
LÁZER KÖZVETLEN DOKLADNOSZ/LASER
±4°
SEL-FEJESZÁLLÍTÉS / SAMOREGULACJA
500-540 nm
3.7 V
2200mAh
Li-Ion
1/4" (6.3 mm)
TRIPÓD THREAD / GWINT STĄTYWY
°C -10 +50
≤1 mW
CLASS / KLASA II



YATO

YT-30434

20

EN Line green laser
 PL Laser liniowy zielony
 DE Grüne Linienlaser
 RU Лазерный уровень зеленый линейный
 CZ Laser zelený liniový
 HU Zöld vonalélér
 RO Nivelă cu laser verde
 FR Niveau laser à ligne verte
 IT Livella laser lineare verde
 ES Nivel láser de línea verde
 CN 绿光水平仪

±3,0mm /10m LASER ACCURACY DOKŁADNOŚĆ LASERA	±4° SELF-REGULATION SAMOREGULACJA	510-530 nm	1/4" (6,3 mm) TRIPOD THREAD GWINT STĄTYWY	°C -10 +50
≤1 mW	CLASS / KLASA II	IP54	6V	4x AA



YATO **YT-30435** 20

EN Tile laser
 PL Laser glazurniczy
 DE Fliesenlaser
 RU Лазерный уровень для плит
 CZ Laserová vodováha
 HU Csempélézer
 RO Nivel laser pt. plăci
 FR Laser tuile
 IT Livella laser per piastrelle
 ES Láser de baldosas
 CN 地板仪

10m	±10mm /10m	x2
ABS	2x AA	

90°



YATO **YT-30410** 4/16

EN Red glasses for laser
 PL Okulary czerwone do pracy z laserem
 DE Rote Laserschutzbrille
 RU Красные очки для работы с лазером
 CZ Červené brýle pro práci s laserem
 HU Piros lézerszemüveg
 RO Ochelari rosii pt. laser
 FR Lunettes d'amélioration laser rouges
 IT Occhiali rossi per raggi laser
 ES Gafas para visión láser rojas
 CN 眼镜



YATO **YT-30460** 80

EN Red laser target card
 PL Płytką pozycjonującą do lasera czerwonego
 DE Rote Laser Zieltafel
 RU Пластина для красного лазерного нивелира
 CZ Čílová deska pro červený laser
 HU Céltábla piros lézerhez
 RO Placă țintă pt. laser roșu
 FR Plaque de positionnement pour laser rouge
 IT Piastra bersaglio rossa per laser
 ES Placa de tarjeta para láser rojo
 CN 激光靶

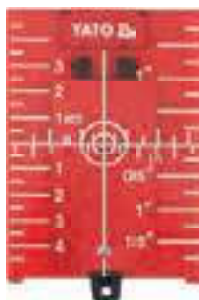

YATO **YT-30464** Dimensions / Wymiary [mm] 400
75x105x3.2

EN Green laser glasses
 PL Okulary zielone do pracy z laserem
 DE Grüne Laserschutzbrille
 RU Зеленые очки для работы с лазером
 CZ Zelené brýle pro práci s laserem
 HU Zöld lézerszemüveg
 RO Ochelari verzi pt. laser
 FR Lunettes d'amélioration laser vert
 IT Occhiali verdi per raggi laser
 ES Gafas para visión láser verde
 CN 激光眼镜



YATO **YT-30461** 80

EN Green laser target card
 PL Płytką pozycjonującą do lasera zielonego
 DE Grüne Laser Zieltafel
 RU Пластина для зеленого лазерного нивелира
 CZ Čílová deska pro zelený laser
 HU Céltábla zöld lézerhez
 RO Placă țintă pt. laser verde
 FR Plaque de positionnement pour laser vert
 IT Piastra bersaglio verde per laser
 ES Placa de tarjeta para láser verde
 CN 激光靶

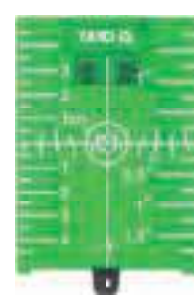

YATO **YT-30465** Dimensions / Wymiary [mm] 400
75x105x3.2

EN Aluminium tripod
PL Statyw aluminiowy
DE Aluminium-Stativ
RU Алюминиевый штатив
CZ Hliníkový statív
HU Alumínium állvány
RO Trepied aluminiu
FR Trépied en aluminium
IT Tripode in alluminio
ES Trípode de aluminio
CN 三角架

1/4" 5/8"
(6.3mm) (15.2mm)
TRIPOD THREAD
GWINN-STATYVU

AI



YATO	H [mm]	
YT-30471	150-280	20
YT-30473	320-750	10
YT-30475	460-1200	20
YT-30477	470-1500	20

EN Laser pole with tripod
PL Tyczka do lasera ze statywem
DE Laser Teleskopstange mit Stativ
RU Штанга-штатив для лазерного уровня
CZ Tyč se stativem pro laseru
HU Teleszkóprúd, lézer állvány
RO Stâlp laser cu trepid
FR Perche de laser avec trépied
IT Asta per laser con treppiede
ES Barra para láser con trípode
CN 水平仪伸缩杆

max
3.7
m

AI



YATO	H [m]	
YT-30500	maks. 3.7	4

EN Aluminium tripod
PL Statyw aluminiowy
DE Aluminium-Stativ
RU Алюминиевый штатив
CZ Hliníkový statív
HU Alumínium állvány
RO Trepied aluminiu
FR Trépied en aluminium
IT Tripode in alluminio
ES Trípode de aluminio
CN 三角架

max
1500
mm

min
950
mm

1/4" 5/8"
(6.3mm) (15.2mm)
TRIPOD THREAD
GWINN-STATYVU

AI



YATO	H [mm]	
YT-30479	950-1500	4

EN Laser mounting pole
PL Tyczka do montażu lasera
DE Laser Teleskopstange
RU Штанга для лазерного уровня
CZ Tyč pro montáž laseru
HU Lézer teleszkóprúd
RO Tijă telescopică pt. nivele laser
FR Pôile de montage pour laser
IT Asta di montaggio laser
ES Barra para láser
CN 水平仪伸缩杆

max
4m

AI



YATO	H [m]	
YT-30503	maks. 4	6

EN Leveling patch
PL Łata niwelacyjna teleskopowa
DE Teleskop-Nivellierlatte
RU Телескопическая нивелирная рейка
CZ Teleskopová nivační latka
HU Teleszkópos szintezőléc
RO Dispozitiv nivelare
FR Mire de nivellement télescopique
IT Stadia telescopica
ES Varilla de nivelación telescópica
CN 塔尺

AI



YATO	L [mm]	
YT-30491	1040-3000	12
YT-30492	1200-5000	12

- EN Aluminium level
 PL Poziomnica aluminiowa
 DE Alu-Wasserwaage
 RU Алюминиевый уровень
- CZ Hliníková vodováha
 HU Alumínium vízérték
 RO Nivelă cu bulă din aluminiu
 FR Niveau à bulle aluminium
- IT Livella in alluminio
 ES Nivel de burbuja de aluminio
 CN 铝合金水平尺

0.057° = 1mm/m ACCURACY / DOKŁADNOŚĆ

x3

ALUMINIUM HIGH QUALITY PROFILE / ALUMINIUM WYSOKIEJ JAKOŚCI PROFIL WYSOKIEJ JAKOŚCI

1.5mm PROFILE

SHOCK-PROOF / ODPORNA NA WSTRZĄSY



YATO	L [mm]	
YT-3001	400	20/60
YT-3002	600	20/60
YT-3003	800	10/40
YT-3004	1000	10/40
YT-3005	1200	10/20

- EN Aluminium level
 PL Poziomnica aluminiowa
 DE Alu-Wasserwaage
 RU Алюминиевый уровень
- CZ Hliníková vodováha
 HU Alumínium vízérték
 RO Nivelă cu bulă din aluminiu
 FR Niveau à bulle aluminium
- IT Livella in alluminio
 ES Nivel de burbuja de aluminio
 CN 铝合金水平尺

SHOCK-PROOF / ODPORNA NA WSTRZĄSY



0.057° = 1mm/m ACCURACY / DOKŁADNOŚĆ

x3

ALUMINIUM HIGH QUALITY PROFILE / ALUMINIUM WYSOKIEJ JAKOŚCI PROFIL WYSOKIEJ JAKOŚCI

1.5mm PROFILE

YATO	L [mm]	
YT-3022	600	10/30
YT-3023	800	10/30
YT-3024	1000	30
YT-3025	1200	20
YT-3026	1500	20



0.027° = 0.5 mm/m ACCURACY / DOKŁADNOŚĆ

x3

ALUMINIUM HIGH QUALITY PROFILE / ALUMINIUM WYSOKIEJ JAKOŚCI PROFIL WYSOKIEJ JAKOŚCI

YATO	L [mm]	
YT-30071	600	10/40
YT-30072	800	10/30
YT-30073	1000	10/20
YT-30074	1200	10/20



0.027° = 0.5 mm/m ACCURACY / DOKŁADNOŚĆ

x2

ALUMINIUM HIGH QUALITY PROFILE / ALUMINIUM WYSOKIEJ JAKOŚCI PROFIL WYSOKIEJ JAKOŚCI

YATO	L [mm]	
YT-30060	400	10/40
YT-30061	600	10/40
YT-30062	800	10/30
YT-30063	1000	10/20
YT-30064	1200	10/20

- EN Aluminium level
 PL Poziomnica aluminiowa
 DE Alu-Wasserwaage
 RU Алюминиевый уровень
 CZ Hliníková vodováha
 HU Alumínium vízérték
- RO Cumpana de nivel aluminiu
 FR Niveau à bulle aluminium
 IT Livella in alluminio
 ES Nivel de burbuja de aluminio
 CN 铝合金水平尺

300 mm

0.027° = 0.5 mm/m ACCURACY / DOKŁADNOŚĆ

x2

AI

- EN Aluminium level
 PL Poziomnica aluminiowa
 DE Alu-Wasserwaage
 RU Алюминиевый уровень
 CZ Hliníková vodováha
 HU Alumínium vízérték
- RO Nivelă cu bulă din aluminiu
 FR Niveau à bulle aluminium
 IT Livella in alluminio
 ES Nivel de burbuja de aluminio
 CN 铝合金水平尺

0.027° = 0.5 mm/m ACCURACY / DOKŁADNOŚĆ

x3

AI



YATO	L [mm]	
YT-30310	300	40

YATO	L [mm]	Magnet quantity / Liczba magnesów	
YT-30311	600	5	20
YT-30312	800	6	20
YT-30313	1000	7	15

- EN Trapezoidal spirit level
 PL Poziomnica trapezowa
 DE Trapezförmige Wasserwaage
 RU Трапецидальный уровень
 CZ Vodováha trapezova
 HU Vízérték trapéz
- RO Nivelă trapezoidală
 FR Niveau trapèze
 IT Livella trapezoidale
 ES Trapezoides nivel
 CN 水平尺

0.027° = 0.5 mm/m ACCURACY / DOKŁADNOŚĆ

x2

ALUMINIUM HIGH QUALITY PROFILE / ALUMINIUM WYSOKIEJ JAKOŚCI PROFIL WYSOKIEJ JAKOŚCI

SHOCK-PROOF / ODPORNA NA WSTRZĄSY



YATO	L [mm]	
YT-30370	250	60

EN Torpedo level
PL Poziomnica torpedo
DE Torpedo-Wasserwaage
RU Уровень торпедо
CZ Vodováha torpedo
HU Vízmeríték torpedó
RO Nivelă Torpedo
FR Niveaux à bulle torpede
IT Livella torpeda
ES Nivel torpedo
CN 水平尺



YATO	L [mm]	
YT-30330	230	45

EN Tile-setting spirit level
PL Poziomnica glazurnicza
DE Fliesenleger-Wasserwaage
RU Уровень каменщика
CZ Vodováha pro obkladáče
HU Burkolói vízmeríték
RO Nivelă
FR Niveau à bulle pour carrelage
IT Livella per piastrellista
ES Nivel para azulejos
CN 水平尺

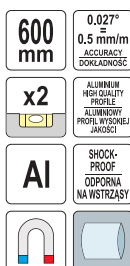
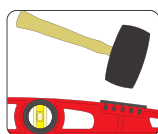

YATO	L [mm]	
YT-30320	600	30

EN Magnetic digital level
PL Poziomnica elektroniczna magnetyczna
DE Elektronische Magnet-Wasserwaage
RU Электронный магнитный спиртовой уровень
CZ Elektronická magnetická vodováha
HU Mágneses elektromos vízmeríték
RO Nivelă digitală magnetică
FR Niveau à bulle électronique magnétique
IT Livella magnetica elettronica
ES Magnético nivel electrónico
CN 迷你数显水平尺



YATO	L [mm]	
YT-30395	150	30

EN Magnetic digital level
PL Poziomnica elektroniczna magnetyczna
DE Elektronische Magnet-Wasserwaage
RU Электронный магнитный спиртовой уровень
CZ Elektronická magnetická vodováha
HU Mágneses elektromos vízmeríték
RO Nivelă digitală magnetică
FR Niveau à bulle électronique magnétique
IT Livella elettronica magnetica
ES Magnético nivel electrónico
CN 迷你数显水平尺

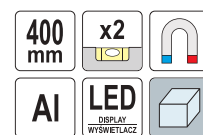

YATO	L [mm]	
YT-30397	400	30

EN Digital laser level
PL Poziomnica elektroniczna z laserem
DE Elektronische Laser-Wasserwaage
RU Электронный уровень с лазерной точкой
CZ Elektronická vodováha s laserem
HU Elektronikus lézeres vízmeríték
RO Nivelă cu laser electronică
FR Niveau laser électronique
IT Livella elettronica con laser
ES Nivel láser electrónico
CN 数显激光水平尺



YATO	L [mm]	
YT-30400	610	20



EN Feeler CZ Spároměr IT Spessimetro
 PL Szczelinomierz HU Hézagmérő ES Calibre de fisuras
 DE Fühlerlehre RO Lere CN 塞尺
 RU Щупы FR Palpeur



100 mm 10 mm
 x17 GAUGES LISTKI



200 mm 12.8 mm
 x17 GAUGES LISTKI



YATO	L [mm]	W [mm]	+/- [mm]	
YT-7220	100	10	0.02, 0.03, 0.04, 0.05, 0.06, 0.07, 0.08, 0.09, 0.10, 0.15, 0.20, 0.25, 0.30, 0.40, 0.50, 0.75, 1.0	10/200

YATO	L [mm]	W [mm]	+/- [mm]	
YT-7221	200	12.8	0.02, 0.03, 0.04, 0.05, 0.06, 0.07, 0.08, 0.09, 0.10, 0.15, 0.20, 0.25, 0.30, 0.40, 0.50, 0.75, 1.0	10/100

100 mm 10 mm
 x10 GAUGES LISTKI



200 mm 12.8 mm
 x14 GAUGES LISTKI



YATO	L [mm]	W [mm]	+/- [mm]	
YT-7222	100	10	0.05, 0.06, 0.07, 0.08, 0.09, 0.10, 0.20, 0.30, 0.40, 0.50	10/100

YATO	L [mm]	W [mm]	+/- [mm]	
YT-7223	200	12.8	0.05, 0.06, 0.07, 0.08, 0.09, 0.10, 0.15, 0.20, 0.25, 0.30, 0.35, 0.40, 0.45, 0.50	10/100

EN Divider
 PL Cyrkiel z prowadnicą
 DE Bogenspitzzirkel
 RU Циркуль разметочный с подвижной дугой
 CZ Kružidlo s obloukem
 HU Ipari körző
 RO Compas
 FR Compas traçoir
 IT Compasso con guida
 ES Compas con fijador
 CN 卡规



EN Spring divider
 PL Cyrkiel ze sprężyną i śrubą
 DE Zirkel mit Stift
 RU Циркуль разметочный с винтом
 CZ Kružidlo s pružinou
 HU Precíziós körző
 RO Compas de trasaj cu reglaj
 FR Compas à ressort
 IT Compasso con molla e vite
 ES Compas de puntas, con muelle
 CN 弹簧卡规



EN Outside caliper
 PL Macka zewnętrzna
 DE Greifzirkel (Außenaster)
 RU Кронциркуль для наружных измерений
 CZ Hmatadlo
 HU Külső jelölő
 RO Compas exterior
 FR Compas d'épaisseur
 IT Comparatore a bracci tastatori per esterni
 ES Compas planos para exteriores
 CN 外卡规



YATO	L [mm]	
YT-72100	150	50
YT-72101	200	50
YT-72102	300	50

YATO	L [mm]	
YT-72106	150	50
YT-72107	200	50
YT-72108	300	50

YATO	L [mm]	
YT-72115	200	50
YT-72116	300	50

EN Outside caliper with spring
 PL Macka zewnętrzna sprężynowa
 DE Aussenzirkel
 RU Кронциркуль для наружных измерений с винтом
 CZ Obkročně hmatadlo se stavěcím šroubem
 HU Precíziós külső jelölő
 RO Compas exterior cu reglaj
 FR Compas à ressort d'épaisseur
 IT Comparatore a bracci tastatori per esterni a molla
 ES Compas para exteriores, con muelle
 CN 弹簧外卡规



EN Inside caliper with spring
 PL Macka wewnętrzna sprężynowa
 DE Innenzirkel
 RU Кронциркуль-нутромер для внутренних измерений с винтом
 CZ Hmatadlo vnitřní s pružinou
 HU Precíziós jelölő körző
 RO Compas interior
 FR Compas à ressort d'intérieur
 IT Comparatore a bracci tastatori per interni a molla
 ES Compas para interiores, con muelle
 CN 弹簧内卡规



YATO	L [mm]	
YT-72120	150	50
YT-72121	200	50
YT-72122	250	50

YATO	L [mm]	
YT-72125	150	50
YT-72126	200	25/50
YT-72127	250	10/50

EN Bevel protractor
PL Kątomierz
DE Winkelmesser
RU Транспортир
CZ Protractor
HU Szögmérő

RO Raportor extensibil
FR Rapporteur
IT Rapportatore
ES Transportador
CN 可调量角器



380 mm
10-170°
5-85°
AI

YATO	L [mm]	
YT-70853	380	10/60

EN Protractor
PL Kątomierz
DE Winkelmesser
RU Транспортир

CZ Protractor
HU Szögmérő
RO Raportor
FR Rapporteur

IT Rapportatore
ES Transportador
CN 量角器



+/-
0.1 mm

YATO	Size / Rozmiar [mm]	
YT-72140	120x150	50
YT-72141	150x200	50

EN Digital angle ruler
PL Kątomierz elektroniczny
DE Digitaler Winkelmesser
RU Электронный транспортир
CZ Elektronický úhloměr
HU Elektronikus szögmérő

RO Echer reglabil digital
FR Rapporteur d'angle électronique
IT Rapportatore elettronica
ES Escuadra electrónica
CN 数显角度尺

mm
inch
LCD
+/-
0.2°
0-360°
1x
+
CR2032
MANUAL
LOCKING
RECZNE
BLOKOWANE



YATO	L [mm]	
YT-71003	200	10/50
YT-71004	300	10/40
YT-71005	500	5/20

EN Screw pitch gauge
PL Sprawdzian grzebieniowy do gwintów
DE Gewindelehre
RU Резьбомер

CZ Měřič závitů
HU Menetsablon
RO Lere pt. filet
FR Jauge de filetage

IT Calibro del filo
ES Galga para roscas
CN 螺纹规

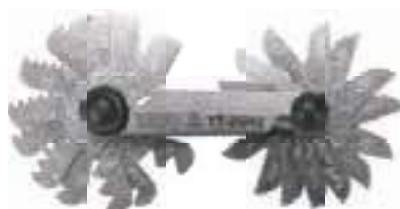

METRIC
METRYCZNY
0.25-6.0
mm
60°
x24
BLADES
OSTRA

WHITWORTH
4-62
55°
x28
BLADES
OSTRA

METRIC
METRYCZNY
0.25-6.0
mm
60°
WHITWORTH
4-62
55°
x52
BLADES
OSTRA

YATO	Thread size metric / Rozmiar gwintów metryczne [mm]	
YT-29980	0.25, 0.3, 0.35, 0.4, 0.45, 0.5, 0.6, 0.7, 0.75, 0.8, 0.9, 1, 1.25, 1.5, 1.75, 2, 2.5, 3, 3.5, 4, 4.5, 5, 5.5, 6	30/300

YATO	Thread size Whitworth / Rozmiar gwintów Whitworth	
YT-29982	4, 4.5, 5, 6, 7, 8, 9, 10, 11, 12, 13, 14, 15, 16, 18, 20, 22, 24, 25, 26, 28, 30, 32, 36, 40, 48, 60, 62	30/300

YATO	Thread size metric / Rozmiar gwintów metryczne [mm]	Thread size Whitworth / Rozmiar gwintów Whitworth	
YT-29984	0.25, 0.3, 0.35, 0.4, 0.45, 0.5, 0.6, 0.7, 0.75, 0.8, 0.9, 1, 1.25, 1.5, 1.75, 2, 2.5, 3, 3.5, 4, 4.5, 5, 5.5, 6	4, 4.5, 5, 6, 7, 8, 9, 10, 11, 12, 13, 14, 16, 18, 19, 20, 22, 24, 25, 26, 28, 30, 32, 36, 40, 48, 60, 62	20/200

15

Pneumatic tools

Narzędzia pneumatyczne



Impact wrenches Klucze udarowe		332-336
--	---	---------

Impact wrenches 1/2" Klucze udarowe 1/2"	332
Impact wrenches 3/4" Klucze udarowe 3/4"	335
Impact wrenches 1" Klucze udarowe 1"	335

Other air tools Inne narzędzia pneumatyczne		337-343
---	---	---------

Pneumatic sets Zestawy pneumatyczne	337
Pneumatic ratchets & sets Grzechotki pneumatyczne i zestawy	337
Pneumatic grinders Szlifierki pneumatyczne	338
Pneumatic cut-off tools & discs Przecinarki pneumatyczne i tarcze	340
Air body saws Wyrzynarki pneumatyczne	340
Pneumatic shears Nożyce pneumatyczne	340
Pneumatic drills Wiertarki pneumatyczne	341
Pneumatic hammers & accessories Młotki pneumatyczne i akcesoria	341
Inflating guns & heads Pistolety do pompowania i głowice	342

Painting equipment & accessories Narzędzia do malowania i akcesoria		343-345
---	---	---------

Spray guns Pistolety lakiernicze	343
Air vacuum cleaners Odkurzacze pneumatyczne	344
Cleaning foam guns Pistolety do wytwarzania piany	344
Blow guns Pistolety do przedmuchiwania	344
Washing guns Pistolety do ropowania	345
Sandblasting tools & accessories Narzędzia do piaskowania i akcesoria	345
Work benches Stojaki lakiernicze	345

Pneumatic accessories Akcesoria instalacji pneumatycznej		346-349
--	---	---------

Air filters, regulators & lubricators Filtry, reduktory i smarownice	346
Spiral hoses Węże spiralne	346
Reinforced hoses Węże zbrojone	347
Couplers Złącza	349

Air grease guns Smarownice pneumatyczne		350-351
---	---	---------

Pneumatic compressors Kompresory pneumatyczne		352
---	---	-----

Pneumatic riveters Nitownice pneumatyczne		353
---	---	-----

Pneumatic staplers & nailers Zszywacze i gwoździarki pneumatyczne		353
---	--	-----



Screws Wkręty	353
-------------------------	-----

EN Angle impact wrench
 PL Klucz pneumatyczny przegubowy
 DE Druckluft-Schlagschrauber mit Gelenk
 RU Ключ пневматический шарнирный
 CZ Pneumatický úhlový rázový uťahovák
 HU Csuklós pneumatikus ütvecsavarozó
 RO Cheie pneumatică de impact cu articulație
 FR Clé à choc pneumatique
 IT Avvitatore pneumatico snodato
 ES Llave neumática articulada
 CN 角度衝擊扳手

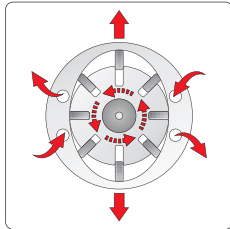
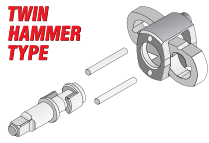

1/2" 12.7 mm	TWIN HAMMER TYPE	0.63 MPa	113 l/min
500 Nm	8000 min⁻¹		
			



$L_{pA} = 84,8 \pm 3,0 / 90,1 \pm 3,0$ dB; $L_{wA} = 95,8 \pm 3,0 / 101,1 \pm 3,0$ dB; $a_n = 4,894 \pm 1,5$ m/s²



YATO 	[Nm]	
YT-09510	500	10

EN Impact wrench
 PL Klucz pneumatyczny
 DE Druckluft-Schlagschrauber
 RU Ударный пневматический гайковерт
 CZ Kluč pneumatický
 HU Pneumatikus ütvecsavarozó
 RO Pistol pneumatic
 FR Clé à choc pneumatique
 IT Chiave ad impulsi pneumatica
 ES Llave neumática de percusión
 CN 气动扳手

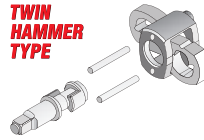

1/2" 12.7 mm	TWIN HAMMER TYPE	0.63 MPa	119 l/min	550 Nm
7500 min⁻¹				
				



$L_{pA} = 92,0 \pm 3,0$ dB; $L_{wA} = 103,0 \pm 3,0$ dB; $a_n = 5,47 \pm 1,5$ m/s²



YATO 	[Nm]	
YT-09511	550	6

EN Impact wrench
 PL Klucz pneumatyczny
 DE Druckluft-Schlagschrauber
 RU Ударный пневматический гайковерт
 CZ Kluč pneumatický
 HU Pneumatikus ütvecsavarozó
 RO Pistol pneumatic
 FR Clé à choc pneumatique
 IT Chiave ad impulsi pneumatica
 ES Llave neumática de percusión
 CN 气动扳手

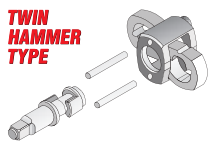

1/2" 12.7 mm	TWIN HAMMER TYPE	0.63 MPa	142 l/min	570 Nm
10000 min⁻¹	COMPOSITE BODY KOMPOZITNY KORPUS			
				



$L_{pA} = 90,7 \pm 3,0$ dB; $L_{wA} = 101,7 \pm 3,0$ dB; $a_n = 3,0 \pm 1,5$ m/s²

YATO 	[Nm]	
YT-09505	570	10

EN Impact wrench
 PL Klucz pneumatyczny
 DE Druckluft-Schlagschrauber
 RU Ударный пневматический гайковерт
 CZ Kluč pneumatický
 HU Pneumatikus ütvecsavarozó
 RO Pistol pneumatic
 FR Clé à choc pneumatique
 IT Chiave ad impulsi pneumatica
 ES Llave neumática de percusión
 CN 气动扳手

1/2" 12.7 mm	SINGLE HAMMER TYPE	0.63 MPa	142 l/min	1200 Nm
10000 min⁻¹	COMPOSITE BODY KOMPOZITNY KORPUS			
				



SHORT BODY

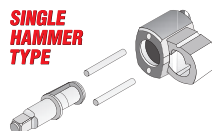

$L_{pA} = 87,0 \pm 1,0$ dB; $L_{wA} = 94,0 \pm 2,0$ dB; $a_n = 9,4 \pm 0,9$ m/s²

YATO 	[Nm]	
YT-09515	1200	10

EN Impact wrench
PL Klucz pneumatyczny
DE Druckluft-Schlagschrauber
RU Ударный пневматический гайковерт
CZ Klíč pneumatický
HU Pneumatikus ütvecsavarozó
RO Pistol pneumatic
FR Clé à choc pneumatique
IT Chiave ad impulsi pneumatica
ES Llave neumática de percusión
CN 气动扳手

1/2" 12.7mm	TWIN HAMMER TYPE	0.63 MPa	184 l/min	680 Nm
7000 min ⁻¹	COMPOSITE BODY KOMPÓZITÓVY KÖRPOUS	STANDARD		

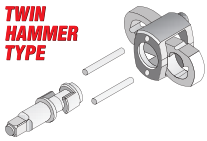

$L_{pA} = 95,0 \pm 3,0$ dB; $L_{wA} = 106,0 \pm 3,0$ dB; $a_n = 9,1 \pm 1,5$ m/s²

YATO	[Nm]	
YT-09524	680	5

EN Impact wrench
PL Klucz pneumatyczny
DE Druckluft-Schlagschrauber
RU Ударный пневматический гайковерт
CZ Klíč pneumatický
HU Pneumatikus ütvecsavarozó
RO Pistol pneumatic
FR Clé à choc pneumatique
IT Chiave ad impulsi pneumatica
ES Llave neumática de percusión
CN 气动扳手

1/2" 12.7mm	TWIN HAMMER TYPE	0.6-0.8 MPa	119 l/min	850 Nm
7000 min ⁻¹	COMPOSITE BODY KOMPÓZITÓVY KÖRPOUS	STANDARD		

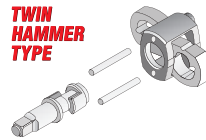

$L_{pA} = 92,0 \pm 3,0$ dB; $L_{wA} = 103,0 \pm 3,0$ dB; $a_n = 5,47 \pm 1,5$ m/s²

YATO	[Nm]	
YT-09525	850	6

EN Impact wrench
PL Klucz pneumatyczny
DE Druckluft-Schlagschrauber
RU Ударный пневматический гайковерт
CZ Klíč pneumatický
HU Pneumatikus ütvecsavarozó
RO Pistol pneumatic
FR Clé à choc pneumatique
IT Chiave ad impulsi pneumatica
ES Llave neumática de percusión
CN 气动扳手

1/2" 12.7mm	TWIN HAMMER TYPE	0.63 MPa	120 l/min
1000 Nm	6000 min ⁻¹	STANDARD	

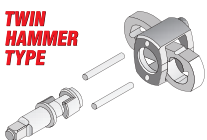

$L_{pA} = 92,0 \pm 3,0$ dB; $L_{wA} = 103,0 \pm 3,0$ dB; $a_n = 5,47 \pm 1,5$ m/s²

YATO	[Nm]	
YT-09528	1000	6

EN Impact wrench
PL Klucz pneumatyczny
DE Druckluft-Schlagschrauber
RU Ударный пневматический гайковерт
CZ Klíč pneumatický
HU Pneumatikus ütvecsavarozó
RO Pistol pneumatic
FR Clé à choc pneumatique
IT Chiave ad impulsi pneumatica
ES Llave neumática de percusión
CN 气动扳手

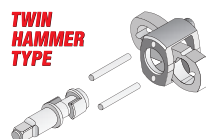

1/2" 12.7mm	TWIN HAMMER TYPE	0.63 MPa	153 l/min	1356 Nm
10000 min ⁻¹	COMPOSITE BODY KOMPÓZITÓVY KÖRPOUS	STANDARD		



$L_{pA} = 93,7 \pm 3,1$ dB; $L_{wA} = 104,7 \pm 3,1$ dB; $a_n = 4,4 \pm 0,4$ m/s²

YATO	[Nm]	
YT-0953	1356	10

EN Impact wrench
 PL Klucz pneumatyczny
 DE Druckluft-Schlagschrauber
 RU Ударный пневматический гайковерт
 CZ Klíč pneumatický
 HU Pneumatikus ütvecsavarozó
 RO Pistol pneumatic
 FR Clé à choc pneumatique
 IT Chiave ad impulsi pneumatica
 ES Llave neumática de percusión
 CN 气动扳手

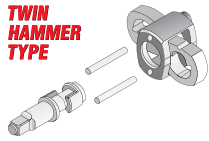

1/2" 12.7mm	TWIN HAMMER TYPE	0.63 MPa	153 l/min	1150 Nm
10000 min⁻¹	COMPOSITE BODY KOMPOZITNY KÖRPUŠ			



$L_{pa} = 93,7 \pm 3,1 \text{ dB}$; $L_{wa} = 104,7 \pm 3,1 \text{ dB}$; $a_p = 4,4 \pm 0,4 \text{ m/s}^2$



YATO 	[Nm]	
YT-09540	1150	10

EN Impact wrench
 PL Klucz pneumatyczny
 DE Druckluft-Schlagschrauber
 RU Ударный пневматический гайковерт
 CZ Klíč pneumatický
 HU Pneumatikus ütvecsavarozó
 RO Pistol pneumatic
 FR Clé à choc pneumatique
 IT Chiave ad impulsi pneumatica
 ES Llave neumática de percusión
 CN 气动扳手

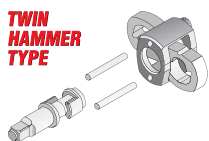

1/2" 12.7mm	TWIN HAMMER TYPE	0.63 MPa	184 l/min	1560 Nm
8000 min⁻¹	COMPOSITE BODY KOMPOZITNY KÖRPUŠ			



$L_{pa} = 87,0 \pm 1,0 \text{ dB}$; $L_{wa} = 94,0 \pm 2,0 \text{ dB}$; $a_p = 9,4 \pm 0,9 \text{ m/s}^2$



YATO 	[Nm]	
YT-09545	1560	5

EN Impact wrench
 PL Klucz pneumatyczny
 DE Druckluft-Schlagschrauber
 RU Ударный пневматический гайковерт
 CZ Klíč pneumatický
 HU Pneumatikus ütvecsavarozó
 RO Pistol pneumatic
 FR Clé à choc pneumatique
 IT Chiave ad impulsi pneumatica
 ES Llave neumática de percusión
 CN 气动扳手

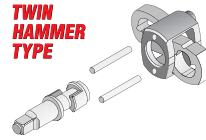

1/2" 12.7mm	TWIN HAMMER TYPE	0.63 MPa	198 l/min	1700 Nm
7000 min⁻¹	COMPOSITE BODY KOMPOZITNY KÖRPUŠ			



$L_{pa} = 92,2 \pm 3,0 \text{ dB}$; $L_{wa} = 103,2 \pm 3,0 \text{ dB}$; $a_p = 4,66 \pm 1,5 \text{ m/s}^2$



YATO 	[Nm]	
YT-09544	1700	10

EN Impact wrench
 PL Klucz pneumatyczny
 DE Druckluft-Schlagschrauber
 RU Ударный пневматический гайковерт
 CZ Klíč pneumatický
 HU Pneumatikus ütvecsavarozó
 RO Pistol pneumatic
 FR Clé à choc pneumatique
 IT Chiave ad impulsi pneumatica
 ES Llave neumática de percusión
 CN 气动扳手

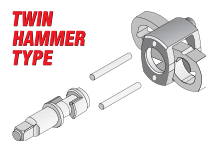
1/2" 12.7mm	TWIN HAMMER TYPE	0.63 MPa	180 l/min	1800 Nm
7400 min⁻¹	COMPOSITE BODY KOMPOZITNY KÖRPUŠ			



$L_{pa} = 92,0 \pm 3,0 \text{ dB}$; $L_{wa} = 103,0 \pm 3,0 \text{ dB}$; $a_p = 5,47 \pm 1,5 \text{ m/s}^2$

YATO 	[Nm]	
YT-09546	1800	8

EN Impact wrench
PL Klucz pneumatyczny
DE Druckluft-Schlagschrauber
RU Ударный пневматический гайковерт
CZ Klíč pneumatický
HU Pneumatikus ütvecsavarozó
RO Pistol pneumatic
FR Clé à choc pneumatique
IT Chiave ad impulsi pneumatica
ES Llave neumática de percusión
CN 气动扳手

3/4" 19 mm	TWIN HAMMER TYPE	0.63 MPa	660 l/min	1300 Nm
5000 min ⁻¹	G 3/8			



$L_{pa} = 92,0 \pm 3,0$ dB; $L_{wa} = 103,0 \pm 3,0$ dB; $a_n = 5,47 \pm 1,5$ m/s²

YATO	[Nm]	
YT-09564	1300	4

EN Impact wrench
PL Klucz pneumatyczny
DE Druckluft-Schlagschrauber
RU Ударный пневматический гайковерт
CZ Klíč pneumatický
HU Pneumatikus ütvecsavarozó
RO Pistol pneumatic
FR Clé à choc pneumatique
IT Chiave ad impulsi pneumatica
ES Llave neumática de percusión
CN 气动扳手

3/4" 19 mm	TWIN HAMMER TYPE	0.63 MPa	255 l/min	2300 Nm
7000 min ⁻¹	COMPOSITE BODY KOMPOZYTYWY KORPUS	STANDARD		



$L_{pa} = 97,9 \pm 3,0$ dB; $L_{wa} = 108,9 \pm 3,0$ dB; $a_n = 5,75 \pm 1,5$ m/s²

YATO	[Nm]	
YT-09575	2300	4

EN Impact wrench
PL Klucz pneumatyczny
DE Druckluft-Schlagschrauber
RU Ударный пневматический гайковерт
CZ Klíč pneumatický
HU Pneumatikus ütvecsavarozó
RO Pistol pneumatic
FR Clé à choc pneumatique
IT Chiave ad impulsi pneumatica
ES Llave neumática de percusión
CN 气动扳手

3/4" 19 mm	TWIN HAMMER TYPE	0.63 MPa	198 l/min	1630 Nm
5500 min ⁻¹	COMPOSITE BODY KOMPOZYTYWY KORPUS	G 3/8		



$L_{pa} = 100,6 \pm 3,0$ dB; $L_{wa} = 111,6 \pm 3,0$ dB; $a_n = 10,21 \pm 1,5$ m/s²

YATO	[Nm]	
YT-09571	1630	6

EN Impact wrench
PL Klucz pneumatyczny
DE Druckluft-Schlagschrauber
RU Ударный пневматический гайковерт
CZ Klíč pneumatický
HU Pneumatikus ütvecsavarozó
RO Pistol pneumatic
FR Clé à choc pneumatique
IT Chiave ad impulsi pneumatica
ES Llave neumática de percusión
CN 气动扳手

1" 25 mm	PINLESS HAMMER TYPE	0.63 MPa	560 l/min	2600 Nm
4000 min ⁻¹		G 1/2		

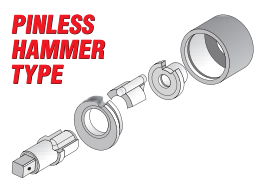

• Application: automotive service stations, trucks
• Strong, uniform impact
• Przeznaczenie: serwis, samochody ciężarowe
• Silny, jednolity uder

$L_{pa} = 94,1 \pm 2,8$ dB; $L_{wa} = 104,8 \pm 2,8$ dB; $a_n = 14,53 \pm 1,93$ m/s²

YATO	[Nm]	
YT-0959	2600	1

EN Impact wrench
 PL Klucz pneumatyczny
 DE Druckluft-Schlagschrauber
 RU Ударный пневматический гайковерт
 CZ Klíč pneumatický
 HU Pneumatikus ütvecsavarzó

RO Pistol pneumatic
 FR Clé à choc pneumatique
 IT Chiave ad impulsi pneumatica
 ES Llave neumática de percusión
 CN 气动扳手

• Application: automotive service stations, trucks
 • Strong, uniform impact

• Przeznaczenie: serwis, samochody ciężarowe
 • Silny, jednolity uder

**PINLESS
 HAMMER
 TYPE**



$L_{PA} = 97,2 \pm 2,0$ dB; $L_{WA} = 107,7 \pm 2,8$ dB; $a_h = 23,58 \pm 4,76$ m/s²



1" 25mm	PINLESS HAMMER TYPE	0.63 MPa	560 l/min	2600 Nm	4000 min ⁻¹	G1/2	
------------	---------------------------	-------------	--------------	------------	---------------------------	------	---

YATO 	[Nm]	
YT-0960	2600	1

EN Impact wrench
 PL Klucz pneumatyczny
 DE Druckluft-Schlagschrauber
 RU Ударный пневматический гайковерт
 CZ Klíč pneumatický
 HU Pneumatikus ütvecsavarzó

RO Pistol pneumatic
 FR Clé à choc pneumatique
 IT Chiave ad impulsi pneumatica
 ES Llave neumática de percusión
 CN 气动扳手



**PINLESS
 HAMMER
 TYPE**



$L_{PA} = 97,1 \pm 3,0$ dB; $L_{WA} = 108,1 \pm 3,0$ dB; $a_h = 13,75 \pm 1,5$ m/s²



1" 25mm	PINLESS HAMMER TYPE	0.6-1.0 MPa	355 l/min	3200 Nm	3500 min ⁻¹	G1/2	
------------	---------------------------	----------------	--------------	------------	---------------------------	------	---

YATO 	[Nm]	
YT-09615	3200	1

EN Impact wrench
 PL Klucz pneumatyczny
 DE Druckluft-Schlagschrauber
 RU Ударный пневматический гайковерт
 CZ Klíč pneumatický
 HU Pneumatikus ütvecsavarzó

RO Pistol pneumatic
 FR Clé à choc pneumatique
 IT Chiave ad impulsi pneumatica
 ES Llave neumática de percusión
 CN 气动扳手

**PINLESS
 HAMMER
 TYPE**

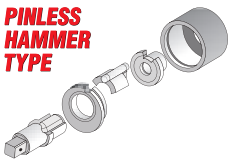

$L_{PA} = 97,0 \pm 3,0$ dB; $L_{WA} = 108,0 \pm 3,0$ dB; $a_h = 12,579 \pm 1,5$ m/s²



1" 25mm	PINLESS HAMMER TYPE	1.0 MPa	450 l/min	4800 Nm	5000 min ⁻¹	G1/2	
------------	---------------------------	------------	--------------	------------	---------------------------	------	---

YATO 	[Nm]	
YT-09618	4800	1

EN Impact wrench
 PL Klucz pneumatyczny
 DE Druckluft-Schlagschrauber
 RU Ударный пневматический гайковерт
 CZ Klíč pneumatický
 HU Pneumatikus ütvecsavarzó

RO Pistol pneumatic
 FR Clé à choc pneumatique
 IT Chiave ad impulsi pneumatica
 ES Llave neumática de percusión
 CN 气动扳手

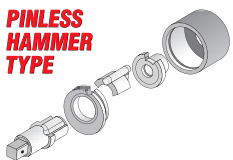

**PINLESS
 HAMMER
 TYPE**



$L_{PA} = 84,4 \pm 3,0$ dB; $L_{WA} = 95,4 \pm 3,0$ dB; $a_h = 2,6 \pm 1,5$ m/s²



1" 25mm	PINLESS HAMMER TYPE	0.63 MPa (max)	650 l/min	5800 Nm	7000 min ⁻¹	G1/2	
------------	---------------------------	----------------------	--------------	------------	---------------------------	------	---

YATO 	[Nm]	
YT-09620	5800	1

EN 3 in 1 air combo kit
PL Zestaw pneumatyczny 3 w 1
DE 3 in 1 Druckluft-Satz
RU Пневматический набор 3 в 1
CZ Pneumatická sada 3 v 1
HU 3 az 1-ben pneumatikus készlet
RO Kit aer comprimat 3 in 1
FR Ensemble pneumatique 3 en 1
IT Kit di utensili pneumatici 3 in 1
ES Set neumático 3 en 1
CN 棘扳手磨三合一工具



1/2" 12.7mm	0.63 MPa	113 l/min	85 Nm	180 mm ²
15000 min ⁻¹	18000 min ⁻¹	6 mm Ø	STANDARD	



$L_{pA} = 88,0 \pm 3,0$ dB; $L_{wA} = 99,0 \pm 3,0$ dB; $a_h = 3,95 \pm 1,5$ m/s²

EN Ratchet air wrench
PL Grzechotka pneumatyczna
DE Druckluft-Ratschenschrauber
RU Пневмотрещотка
CZ Pneumatická ráčna
HU Préslevegős behajtó szerszám
RO Antrenor pneumatic
FR Clé à cliquet pneumatique
IT Chiave a cricchetto pneumatica
ES Carraca neumática
CN 气动棘轮扳手

1/2" 12.7mm	0.63 MPa	142 l/min	80 Nm
160 min ⁻¹	360° AIR EXHAUST WYDMUCHI POWIERZA	SPEED REGULATOR REGULACJA PRĘDKOŚCI	1.4 kg
	COMPOSITE BODY KOMPONENTOWY KORPUS	STANDARD	



ULTRA LIGHT

$L_{pA} = 94,0 \pm 3,0$ dB; $L_{wA} = 105,0 \pm 3,0$ dB; $a_h = 2,6 \pm 1,5$ m/s²

YATO	[Nm]	
YT-09803	80	12

EN Ratchet air wrench
PL Grzechotka pneumatyczna
DE Druckluft-Ratschenschrauber
RU Пневмотрещотка
CZ Pneumatická ráčna
HU Préslevegős behajtó szerszám

RO Antrenor pneumatic
FR Clé à cliquet pneumatique
IT Chiave a cricchetto pneumatica
ES Carraca neumática
CN 气动棘轮扳手

1/2" 12.7mm	0.62 MPa	110 l/min
68 Nm	160 min ⁻¹	STANDARD



$L_{pA} = 93,1 \pm 1,9$ dB; $L_{wA} = 104,4 \pm 2,7$ dB; $a_h = 19,98 \pm 2,47$ m/s²

YATO	[Nm]	
YT-0980	68	20

YATO	[Nm]	
YT-09860	85	10

EN Ratchet air wrench
PL Grzechotka pneumatyczna
DE Druckluft-Ratschenschrauber
RU Пневмотрещотка
CZ Pneumatická ráčna
HU Préslevegős behajtó szerszám

RO Antrenor pneumatic
FR Clé à cliquet pneumatique
IT Chiave a cricchetto pneumatica
ES Carraca neumática
CN 气动棘轮扳手

1/2" 12.7mm	0.62 MPa	120 l/min
80 Nm	160 min ⁻¹	STANDARD



$L_{pA} = 87,6 \pm 1,9$ dB; $L_{wA} = 97,7 \pm 2,7$ dB; $a_h = 14,83 \pm 1,96$ m/s²

YATO	[Nm]	
YT-0981	80	20

EN Ratchet wrench kit
PL Zestaw z grzechotką pneumatyczną
DE Druckluft-Ratschenschrauber mit Zubehör
RU Пневмотрещотка в наборе
CZ Klíč ráčnový pneumatický s příslušenstvím
HU Pneumatikus racsnkulcs készlet
RO Antrenor pneumatic cu accesorii
FR Clé à cliquet pneumatique
IT Chiave a cricchetto pneumatica
ES Juego con carraca neumática
CN 气动棘轮扳手组套

1/2" 12.7mm	0.62 MPa	110 l/min	68 Nm	160 min ⁻¹
STANDARD	CrV	OIL POT OLIWIARKA		





10, 11, 12, 13, 14, 17, 19 mm;
1/2" (12.7 mm) (L=75 mm);
1/2" (12.7 mm);
6 mm x 1/2" (12.7 mm);
PH2, PH3, PH4;
T20, T25, T27, T30, T40;
4, 5, 6, 7, 8 mm

$L_{pA} = 93,1 \pm 1,9$ dB; $L_{wA} = 104,4 \pm 2,7$ dB; $a_h = 19,98 \pm 2,47$ m/s²

YATO	[Nm]	
YT-0982	68	4

- EN Air grinder
- PL Szlifierka pneumatyczna prosta
- DE Drucklufteinhandschleifer
- RU Шлифмашина пневматическая
- CZ Bruska přímá pneumatická
- HU Pneumatikus egyenescsiszoló
- RO Polizor pneumatic
- FR Mini ponceuse pneumatique
- IT Smerigliatrice diritta pneumatica
- ES Lijadora neumática recta
- CN 气动修磨机





0.62 MPa	160 l/min	20000 min ⁻¹
3, 6 mm Ø		

$L_{pa} = 100,7 \pm 2,4$ dB; $L_{wa} = 106,2 \pm 3,7$ dB; $a_n = 2,83 \pm 0,93$ m/s²

- EN Air grinder
- PL Szlifierka pneumatyczna prosta
- DE Drucklufteinhandschleifer
- RU Шлифмашина пневматическая
- CZ Bruska přímá pneumatická
- HU Pneumatikus egyenescsiszoló
- RO Polizor pneumatic
- FR Mini ponceuse pneumatique
- IT Smerigliatrice diritta pneumatica
- ES Lijadora neumática recta
- CN 气动修磨机





ADJUSTABLE SPEED REGULATOR. REAR AIR EXHAUST CAN BE ROTATED 360°
REGULACJA PRĘDKOŚCI. MOŻLIWOŚĆ USTAWIENIA WYDMUCHU POWIETRZA O 360°

0.63 MPa	113 l/min	25000 min ⁻¹
6 mm Ø		
COMPOSITE BODY KOMPZYTOWY KORPUS		
		



$L_{pa} = 88,0 \pm 3,0$ dB; $L_{wa} = 99,0 \pm 3,0$ dB; $a_n = 2,9 \pm 1,5$ m/s²



YATO 	
YT-09632	20

- EN Pneumatic angle grinder
- PL Szlifierka pneumatyczna kątowa
- DE Ruckluft-Winkelschleifer
- RU Пневматическая угловая шлифовальная машина
- CZ Pneumatické úhlovou brusku
- HU Pneumatikus sarokcsiszoló
- RO Polizor unghiular pneumatic
- FR Pneumatique meuleuse d'angle
- IT Smerigliatrice angolare pneumatica
- ES Amoladora angular neumática
- CN 气动角磨

0.63 MPa	141 l/min	11000 min ⁻¹	125 x 16/22 mm
M10			





$L_{pa} = 87,0 \pm 3,0$ dB; $L_{wa} = 98,0 \pm 3,0$ dB; $a_n = 3,4 \pm 1,5$ m/s²

YATO 	
YT-09675	8

YATO 	
YT-0965	25

- EN Air grinder
- PL Szlifierka pneumatyczna prosta
- DE Drucklufteinhandschleifer
- RU Шлифмашина пневматическая
- CZ Bruska přímá pneumatická
- HU Pneumatikus egyenescsiszoló
- RO Polizor pneumatic
- FR Mini ponceuse pneumatique
- IT Smerigliatrice diritta pneumatica
- ES Lijadora neumática recta
- CN 气动刻磨机

0.63 MPa	113 l/min	25000 min ⁻¹	6 mm Ø
360° AIR EXHAUST WYDMUCH POWIETRZA	SPEED REGULATOR REGULACJA PRĘDKOŚCI	0.33 kg	
COMPOSITE BODY KOMPZYTOWY KORPUS			





ULTRA LIGHT 

$L_{pa} = 97,0 \pm 3,0$ dB; $L_{wa} = 108,0 \pm 3,0$ dB; $a_n = 0,9 \pm 1,5$ m/s²

YATO 	
YT-09633	40

- EN Pneumatic angle grinder
- PL Szlifierka pneumatyczna kątowa
- DE Ruckluft-Winkelschleifer
- RU Пневматическая угловая шлифовальная машина
- CZ Pneumatické úhlovou brusku
- HU Pneumatikus sarokcsiszoló
- RO Polizor unghiular pneumatic
- FR Pneumatique meuleuse d'angle
- IT Smerigliatrice angolare pneumatica
- ES Amoladora angular neumática
- CN 气动刻磨机

0.63 MPa	113 l/min	20000 min ⁻¹	6 mm Ø
360° AIR EXHAUST WYDMUCH POWIETRZA	SPEED REGULATOR REGULACJA PRĘDKOŚCI	0.48 kg	
COMPOSITE BODY KOMPZYTOWY KORPUS			



$L_{pa} = 92,0 \pm 3,0$ dB; $L_{wa} = 103,0 \pm 3,0$ dB; $a_n = 1,4 \pm 1,5$ m/s²

YATO 	
YT-09676	30

ULTRA LIGHT 

EN Air sander
PL Szlifierka pneumatyczna mimośrodowa
DE Druckluft-Excenterschleifer
RU Шлифмашина эксцентриковая пневматическая
CZ Bruska pneumatická
HU Pneumatikus polírozó
RO Masina de slefuit pneumatica
FR Ponceuse pneumatique
IT Smerigliatrice orbitale pneumatica
ES Lijadora neumática excéntrica
CN 气动抛光机



ULTRA LIGHT

$L_{pa} = 87,0 \pm 3,0$ dB; $L_{wa} = 98,0 \pm 3,0$ dB; $a_h = 2,3 \pm 2,5$ m/s²

YATO	YT-09730	20
-------------	-----------------	----

EN Air sander
PL Szlifierka pneumatyczna mimośrodowa
DE Druckluft-Excenterschleifer
RU Шлифмашина эксцентриковая пневматическая
CZ Bruska pneumatická
HU Pneumatikus polírozó
RO Masina de slefuit pneumatica
FR Ponceuse pneumatique
IT Smerigliatrice orbitale pneumatica
ES Lijadora neumática excéntrica
CN 气动磨光机



$L_{pa} = 90,0 \pm 3,0$ dB; $L_{wa} = 101,0 \pm 3,0$ dB; $a_h = 4,4 \pm 2,5$ m/s²

YATO	YT-09740	10
-------------	-----------------	----

EN Air sander
PL Szlifierka pneumatyczna mimośrodowa
DE Druckluft-Excenterschleifer
RU Шлифмашина эксцентриковая пневматическая
CZ Bruska pneumatická
HU Pneumatikus polírozó
RO Masina de slefuit pneumatica
FR Ponceuse pneumatique
IT Smerigliatrice orbitale pneumatica
ES Lijadora neumática excéntrica
CN 气动磨光机

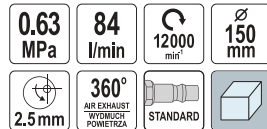

$L_{pa} = 90,0 \pm 3,0$ dB; $L_{wa} = 101,0 \pm 3,0$ dB; $a_h = 4,4 \pm 2,5$ m/s²

YATO	YT-09739	10
-------------	-----------------	----

EN Air sander
PL Szlifierka pneumatyczna mimośrodowa
DE Druckluft-Excenterschleifer
RU Шлифмашина эксцентриковая пневматическая
CZ Bruska pneumatická
HU Pneumatikus polírozó
RO Masina de slefuit pneumatica
FR Ponceuse pneumatique
IT Smerigliatrice orbitale pneumatica
ES Lijadora neumática excéntrica
CN 气动研磨机



$L_{pa} = 91,0 \pm 3,0$ dB; $L_{wa} = 105,0 \pm 4,0$ dB; $a_h = 10,3 \pm 1,2$ m/s²

YATO	YT-09738	10
-------------	-----------------	----

EN Air belt sander
PL Pneumatyczna szlifierka taśmowa
DE Pneumatische Bandschleifer
RU Пневматический ленточный напильник
CZ Pneumatická pásová bruska
HU Pneumatikus szalagcsiszoló
RO Polizor pneumatic cu bandă
FR Ponceuse à bande pneumatique
IT Levigatrice a nastro pneumatica
ES Lijadora de banda neumática
CN 气动砂磨机

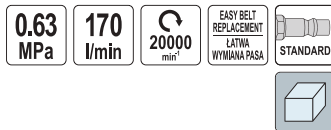

Includes belts: P60, P80, P120
W zestawie pasy: P60, P80, P120
 $L_{pa} = 93,0 \pm 3,0$ dB; $L_{wa} = 104,0 \pm 3,0$ dB;
 $a_h = 4,8 \pm 1,5$ m/s²

YATO	Abrasive belt size / Rozmiar taśmy ściernej [mm]	10
YT-09741	10x330	10

EN Air belt sander
PL Pneumatyczna szlifierka taśmowa
DE Pneumatische Bandschleifer
RU Пневматический ленточный напильник
CZ Pneumatická pásová bruska
HU Pneumatikus szalagcsiszoló
RO Polizor pneumatic cu bandă
FR Ponceuse à bande pneumatique
IT Levigatrice a nastro pneumatica
ES Lijadora de banda neumática
CN 气动砂磨机



Includes belts: P60, P80, P120
W zestawie pasy: P60, P80, P120
 $L_{pa} = 93,0 \pm 3,0$ dB; $L_{wa} = 104,0 \pm 3,0$ dB;
 $a_h = 4,8 \pm 1,5$ m/s²

YATO	Abrasive belt size / Rozmiar taśmy ściernej [mm]	10
YT-09742	20x520	10

EN Air cut-off tool
 PL Przecinarka pneumatyczna
 DE Druckluft-Schneidmaschine
 RU Резак пневматический
 CZ Příčná bruska pneumatická
 HU Pneumatikus sarokcsiszoló
 RO Masina de taiat cu aer comprimat
 FR Coupeuse pneumatique
 IT Fresa pneumatica
 ES Cortadora neumática
 CN 气动角磨

0.65 MPa	127 l/min	18000 min ⁻¹	75x9.5 mm		
--------------------	---------------------	-----------------------------------	---------------------	--	--



$L_{pa} = 87,0 \pm 3,0$ dB; $L_{wa} = 98,0 \pm 3,0$ dB; $a_n = 1,36 \pm 1,5$ m/s²

YATO	
YT-09715	10

EN Air cut-off tool
 PL Przecinarka pneumatyczna
 DE Druckluft-Schneidmaschine
 RU Резак пневматический
 CZ Příčná bruska pneumatická
 HU Pneumatikus sarokcsiszoló
 RO Masina de taiat cu aer comprimat
 FR Coupeuse pneumatique
 IT Fresa pneumatica
 ES Cortadora neumática
 CN 气动切割机

0.8 MPa	170 l/min	18000 min ⁻¹	75x9.5 mm	360° AIR EXHAUST WYDMUCH POWIETRZA	
0.7 kg					



ULTRA LIGHT

$L_{pa} = 90,0 \pm 3,0$ dB; $L_{wa} = 101,0 \pm 3,0$ dB; $a_n = 1,2 \pm 1,5$ m/s²

YATO	
YT-09717	20

EN Metal cutting discs
 PL Tarcze do cięcia metalu
 DE Metall-Trennscheiben
 RU Круги отрезные по металлу
 CZ Souprava kotoučů pro řezání kovu
 HU Vágókorong készlet fémhez
 RO Set de pânze de taiat metal
 FR Set de disques pour métal
 IT Disco per taglio metallo
 ES Juego de discos para cortar metal
 CN 金属切割片组套

5 PCS	max 80 m/s	18000 min ⁻¹	75x9.5 x2 mm	
-----------------	----------------------	-----------------------------------	------------------------	--



For YT-0993, YT-09715, YT-09717
 Dla YT-0993, YT-09715, YT-09717

YATO	
YT-0994	12/48

EN Air body saw
 PL Wyrzynarka pneumatyczna
 DE Druckluft Stichsäge
 RU Пила пневматическая сабельная
 CZ Pneumatická přimočará pila
 HU Pneumatikus kardfűrész
 RO Fierăstrău pneumatic
 FR Scie sabre pneumatique
 IT Sega alternativa pneumatica
 ES Sierra de calar neumática
 CN 气锯



0.63 MPa	170 l/min	9000 min ⁻¹		

$L_{pa} = 78,0 \pm 3,0$ dB; $L_{wa} = 89,0 \pm 3,0$ dB; $a_n = 23 \pm 1,5$ m/s²

YATO	
YT-09955	20

EN Air shears pistol type
 PL Nożyce pneumatyczne kątowe
 DE Pneumatische Schere
 RU Пневматические ножницы угловые
 CZ Pneumatické nůžky na plech
 HU Pneumatikus ollók
 RO Foarfecă pneumatică
 FR Cisailles pneumatiques
 IT Cesoia pneumatica angolare
 ES Tijera neumática
 CN 气动剪刀



0.63 MPa	141 l/min	1800 min ⁻¹	5.5 mm	
max 1.2 mm STEEL STEEL	max 1.4 mm Al			



$L_{pa} = 80,0 \pm 3,0$ dB; $L_{wa} = 91,0 \pm 3,0$ dB; $a_n = 6,5 \pm 1,5$ m/s²

YATO	
YT-09944	10

EN Air shears
PL Nożyce pneumatyczne proste
DE Pneumatische Schere
RU Пневматические ножницы прямые
CZ Pneumatické nůžky na plech
HU Pneumatikus ollók
RO Foarfecă pneumatică
FR Ciseaux pneumatiques
IT Cesoia pneumatica diritta
ES Tijera neumática
CN 气动剪刀

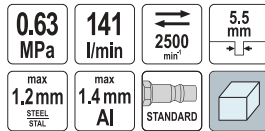

$L_{pa} = 90,0 \pm 3,0$ dB; $L_{wa} = 101,0 \pm 3,0$ dB; $a_n = 4,6 \pm 1,5$ m/s²

YATO
YT-09945

15

EN Air drill
PL Wiertarka pneumatyczna
DE Druckluft-Bohrmaschine
RU Пневматическая дрель
CZ Vrtáčka vzduchová
HU Pneumatikus fúró
RO Mașină de găurit pneumatică
FR Perceuse pneumatique
IT Trapano ad aria compressa
ES Taladradora neumática
CN 气钻



$L_{pa} = 89,7 \pm 3,0$ dB; $L_{wa} = 100,7 \pm 3,0$ dB; $a_n = 0,89 \pm 1,5$ m/s²

YATO
YT-09702

12

EN Air drill
PL Wiertarka pneumatyczna
DE Druckluft-Bohrmaschine
RU Пневматическая дрель
CZ Vrtáčka vzduchová
HU Pneumatikus fúró
RO Mașină de găurit pneumatică
FR Perceuse pneumatique
IT Trapano ad aria compressa
ES Taladradora neumática
CN 气钻

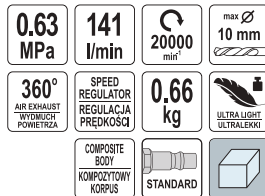

ULTRA LIGHT

$L_{pa} = 92,0 \pm 3,0$ dB; $L_{wa} = 103,0 \pm 3,0$ dB; $a_n = 6,2 \pm 1,5$ m/s²

YATO
YT-09695

20

EN Air drill
PL Wiertarka pneumatyczna
DE Druckluft-Bohrmaschine
RU Пневматическая дрель
CZ Vrtáčka vzduchová
HU Pneumatikus fúró
RO Mașină de găurit pneumatică
FR Perceuse pneumatique
IT Trapano ad aria compressa
ES Taladradora neumática
CN 气钻



ULTRA LIGHT

$L_{pa} = 98,0 \pm 3,0$ dB; $L_{wa} = 109,0 \pm 3,0$ dB; $a_n = 2,8 \pm 1,5$ m/s²

YATO
YT-09703

10

EN Air hammer
PL Młotek pneumatyczny
DE Druckluft-Schlaghammer
RU Зубило пневматическое
CZ Sekáč vzduchový
HU Pneumatikus vésőgép

RO Ciocan pneumatic
FR Marteau pneumatique
IT Martello pneumatica
ES Martillo neumático
CN 冲击式气铲

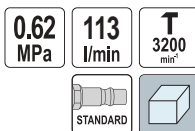

$L_{pa} = 96,3 \pm 1,3$ dB; $L_{wa} = 107,7 \pm 2,5$ dB; $a_n = 2,62 \pm 9,1$ m/s²

YATO
YT-0990

10

EN Air hammer
PL Młotek pneumatyczny
DE Druckluft-Schlaghammer
RU Зубило пневматическое
CZ Sekáč vzduchový
HU Pneumatikus vésőgép

RO Ciocan pneumatic
FR Marteau pneumatique
IT Martello pneumatica
ES Martillo neumático
CN 冲击式气铲



$L_{pa} = 95,0 \pm 3,0$ dB; $L_{wa} = 106,0 \pm 3,0$ dB; $a_n = 20,0 \pm 4,5$ m/s²

YATO
YT-09904

10

ULTRA LIGHT

EN Air needle scaler
 PL Pneumatyczny młotek igłowy
 DE Luft-Nadel-Scaler
 RU Пневматический игольчатый отбойник
 CZ Pneumatické jehlové kladivo
 HU Pneumatikus tűs rozsdaleverő
 RO Pistol pneumatic de curățat cu ace
 FR Dérouilleur décapeur pneumatique
 IT Scrostatore pneumatico ad aghi
 ES Limpiador de agujas neumáticas
 CN 气动除锈器

0.63 MPa **99** l/min **T** 4000 min⁻¹



$L_{pA} = 97,0 \pm 3,0$ dB; $L_{wA} = 108,0 \pm 3,0$ dB; $a_n = 18,9 \pm 1,5$ m/s²

YATO **YT-09912** **6**

EN Air needle scaler
 PL Pneumatyczny młotek igłowy
 DE Luft-Nadel-Scaler
 RU Пневматический игольчатый отбойник
 CZ Pneumatické jehlové kladivo
 HU Pneumatikus tűs rozsdaleverő
 RO Pistol pneumatic de curățat cu ace
 FR Dérouilleur décapeur pneumatique
 IT Scrostatore pneumatico ad aghi
 ES Limpiador de agujas neumáticas
 CN 气动除锈器

0.63 MPa **48** l/min **T** 3000 min⁻¹



$L_{pA} = 87,8 \pm 3,0$ dB; $L_{wA} = 98,8 \pm 3,0$ dB; $a_n = 6,9 \pm 1,18$ m/s²

YATO **YT-09913** **25**

EN Air needle scaler
 PL Pneumatyczny młotek igłowy
 DE Luft-Nadel-Scaler
 RU Пневматический игольчатый отбойник
 CZ Pneumatické jehlové kladivo
 HU Pneumatikus tűs rozsdaleverő
 RO Pistol pneumatic de curățat cu ace
 FR Dérouilleur décapeur pneumatique
 IT Scrostatore pneumatico ad aghi
 ES Limpiador de agujas neumáticas
 CN 气动除锈器

0.63 MPa **113** l/min **T** 4500 min⁻¹



$L_{pA} = 100,0 \pm 3,0$ dB; $L_{wA} = 111,0 \pm 3,0$ dB; $a_n = 13,0 \pm 1,5$ m/s²

YATO **YT-09910** **8**

EN Needle head
 PL Glowka igłowa
 DE Nadelkopf
 RU Головка пневматического молотка
 CZ Jehlová hlaviče
 HU Tűs rozsdaleverő fej
 RO Cap rezerva pt. ciocan pneumatic cu ace
 FR Tête à aiguilles
 IT Testa per scrostatore ad aghi
 ES Cabezal de agujas
 CN 除锈筒



For YT-09910
 Dla YT-09910

YATO **YT-09911** **20**

EN Shank chisel for air hammer
 PL Diuta do młotka pneumatycznego
 DE Lufthammer Meißel-Set
 RU Комплект зубил для пневматического молотка
 CZ Diáta pro pneumatické kladivo
 HU Véső készlet pneumatikus véső kalapácsolhoz

RO Set dalti pt. ciocan pneumatic
 FR Ensemble marteau burineur
 IT Set di scalpelli per martelli pneumatici
 ES Juego de martillos para martillos neumáticos
 CN 气动铲刀

4 PCS

120 mm



For YT-0990, 81133, YT-09904
 Dla YT-0990, 81133, YT-09904

YATO **YT-09901** **50**

EN Inflating gun
 PL Pistolet do pompowania
 DE Inflatorpistole
 RU Пистолет для накачивания
 CZ Pistole na čerpání z manometrem
 HU Pumpáló pisztoly nyomásmérővel
 RO Pistol cu manometru
 FR Pistolet pour gonflage de pneus avec manomètre
 IT Pistola per gonfiaggio
 ES Pistola de bombeo con manometro
 CN 充气枪

0.6 MPa (max.) **44** cm **360°**



$L_{pA} = 89,0 \pm 2,5$ dB; $L_{wA} = 100,0 \pm 2,5$ dB; $a_n = < 2,5$ m/s²

YATO **YT-23701** **20**

EN Inflating gun
PL Pistolet do pompowania
DE Inflatorpistole
RU Пистолет для накачивания
CZ Pistolet na čerpání z manometrem
HU Pumpáló pisztoly nyomásmérővel
RO Pistol cu manometru
FR Pistolet pour gonflage de pneus avec manomètre
IT Pistola per gonfiaggio
ES Pistola de bombeo con manometro
CN 充气枪



$L_{pA} = 89,0 \pm 2,5$ dB; $L_{wA} = 100,0 \pm 2,5$ dB; $a_n = <2,5$ m/s²

YATO	
YT-2370	8/40

EN Inflating gun
PL Pistolet do pompowania
DE Inflatorpistole
RU Пистолет для накачивания
CZ Pistolet na čerpání z manometrem
HU Pumpáló pisztoly nyomásmérővel
RO Pistol cu manometru
FR Pistolet pour gonflage de pneus avec manomètre
IT Pistola per gonfiaggio
ES Pistola de bombeo con manometro
CN 充气枪



$L_{pA} = 89,0 \pm 2,5$ dB; $L_{wA} = 100,0 \pm 2,5$ dB; $a_n = <2,5$ m/s²

YATO	
YT-2370S	20

EN Inflating gun
PL Pistolet do pompowania
DE Inflatorpistole
RU Пистолет для накачивания
CZ Pistolet na čerpání z manometrem
HU Pumpáló pisztoly nyomásmérővel
RO Pistol cu manometru
FR Pistolet pour gonflage de pneus avec manomètre
IT Pistola per gonfiaggio
ES Pistola de bombeo con manometro
CN 充气枪



$L_{pA} = 89,0 \pm 2,5$ dB; $L_{wA} = 100,0 \pm 2,5$ dB; $a_n = <2,5$ m/s²

YATO	
YT-23702	10/40

EN Inflating head
PL Głowica do pompowania
DE Klemmnippel (universal)
RU Насадка на насос под шланг
CZ Hlava na čerpání
HU Pumpafej
RO Cap pt. pompă de umflat
FR Mandrin de pompe
IT Testa per il pompaggio
ES Cabeza de bombeo
CN 充气头



YATO	Connector diameter / Średnica króćca [mm]	
YT-2371	6	50/300
YT-2372	8	50/300

EN Spray gun with fluid cup
PL Pistolet natryskowy
DE Lackierpistole mit Fließbecher
RU Пистолет-распылитель с бачком
CZ Pistolet na lakování z nádrží
HU Festékszóró pisztoly
RO Pistol de vopsit cu rezervor
FR Pistolet à peinture
IT Pistola vernice
ES Pistola de barniz
CN 喷枪



0.3 MPa (max.)
410 l/min
1.4 mm
0.6 L
HVLP

$L_{pA} = 74,0$ dB; $L_{wA} = 85,0$ dB; $a_n = <2,5$ m/s²



0.3 MPa (max.)
410 l/min
1.5 mm
0.6 L
HVLP

$L_{pA} = 76,0$ dB; $L_{wA} = 87,0$ dB; $a_n = <2,5$ m/s²



0.4 MPa (max.)
380 l/min
1.8 mm
1 L

$L_{pA} = 79,0$ dB; $L_{wA} = 90,0$ dB; $a_n = <2,5$ m/s²



0.3 MPa
220 l/min
0.8 mm
0.1 L
HVLP

$L_{pA} = 67,0$ dB; $L_{wA} = 78,0$ dB; $a_n = <2,5$ m/s²

YATO	
YT-2340	20

YATO	
YT-2341	20

YATO	
YT-2346	10

YATO	
YT-2357	20

- EN Air vacuum cleaner
- PL Odkurzacz pneumatyczny
- DE Druckluftstaubsauger
- RU Пневматический пылесос
- CZ Pneumatický vysavač
- HU Pneumatikus porszívó
- RO Aspirator cu aer comprimat
- FR Aspirateur pneumatique
- IT Aspirapolvere pneumatico
- ES Aspirador neumático
- CN 吹吸尘枪



0.62 MPa	25 mm	AI		

$L_{pa} = 83,0 \pm 3,0$ dB; $L_{wa} = 94,0 \pm 3,0$ dB; $a_h = <2,5$ m/s²

- EN Cleaning foam gun
- PL Pistolet do wytwarzania piany
- DE Schaumpistole
- RU Пистолет для образования пены
- CZ Pistolet pro vytváření pěny
- HU Habpisztoly
- RO Pistol pt. spuma
- FR Pistolet pour faire de la mousse
- IT Pistola per erogazione schiuma
- ES Pistola generadora de espuma
- CN 发动机清洗枪

0.62 MPa (max.)	113 l/min	220 mm	1L	AI		
------------------------------	---------------------	------------------	-----------	-----------	--	--



$L_{pa} = 85,0 \pm 3,0$ dB; $L_{wa} = 96,0 \pm 3,0$ dB; $a_h = <2,5$ m/s²

YATO	YT-23640		10
-------------	-----------------	--	----

YATO	YT-09990		10
-------------	-----------------	--	----

- EN Cleaning foam gun
- PL Pistolet do wytwarzania piany
- DE Schaumpistole
- RU Пистолет для образования пены
- CZ Pistolet pro vytváření pěny
- HU Habpisztoly
- RO Pistol pt. spuma
- FR Pistolet pour faire de la mousse
- IT Pistola per erogazione schiuma
- ES Pistola generadora de espuma
- CN 泡沫枪

0.62 MPa (max.)	113 l/min	TURBO NOZZLE DYSZA TURBO	1L	AI		
------------------------------	---------------------	--	-----------	-----------	--	--



$L_{pa} = 85,0 \pm 3,0$ dB; $L_{wa} = 96,0 \pm 3,0$ dB; $a_h = <2,5$ m/s²

YATO	YT-23641		10
-------------	-----------------	--	----

- EN Blow gun with extension
- PL Pistolet do przedmuchiwania z przedłużką
- DE Ausblaspistole mit Verlängerung
- RU Пистолет для продувки с удлинителем
- CZ Ofukovací pistole s nástavcem
- HU Lefúvó pisztoly hosszú toldattal
- RO Pistol pt. suflat cu extensie
- FR Soufflette avec rallonge
- IT Pistola di soffiaggio con prolunga
- ES Pistola de soplado con extensión
- CN 吹尘枪

0.8 MPa (max.)	1/4" 6,3mm	AI		
-----------------------------	-----------------------------	-----------	--	--



$L_{pa} = 91,0$ dB; $L_{wa} = 102,0$ dB; $a_h = <2,5$ m/s²

YATO	YT-2373		20/40
-------------	----------------	--	-------

- EN Blow gun with extension
- PL Pistolet do przedmuchiwania z przedłużką
- DE Ausblaspistole mit Verlängerung
- RU Пистолет для продувки с удлинителем
- CZ Ofukovací pistole s nástavcem
- HU Lefúvó pisztoly hosszú toldattal
- RO Pistol pt. suflat cu extensie
- FR Soufflette avec rallonge
- IT Pistola di soffiaggio con prolunga
- ES Pistola de soplado con extensión
- CN 吹尘枪

0.8 MPa (max.)	110 mm	BRASS MOSIADZ	PP		
-----------------------------	------------------	-------------------------	-----------	--	--



$L_{pa} = 89,0$ dB; $L_{wa} = 100,0$ dB; $a_h = <2,5$ m/s²

YATO	YT-23731		20/40
-------------	-----------------	--	-------

- EN Blow gun with extension
- PL Pistolet do przedmuchiwania z przedłużką
- DE Ausblaspistole mit Verlängerung
- RU Пистолет для продувки с удлинителем
- CZ Ofukovací pistole s nástavcem
- HU Lefúvó pisztoly hosszú toldattal
- RO Pistol pt. suflat cu extensie
- FR Soufflette avec rallonge
- IT Pistola di soffiaggio con prolunga
- ES Pistola de soplado con extensión
- CN 吹尘枪

0.8 MPa (max.)	320 mm	PP		
BRASS MOSIADZ				



$L_{pa} = 89,0$ dB; $L_{wa} = 100,0$ dB; $a_h = <2,5$ m/s²

YATO	YT-23732		30/60
-------------	-----------------	--	-------

- EN Blow gun with extension
- PL Pistolet do przedmuchiwania z przedłużką
- DE Ausblaspistole mit Verlängerung
- RU Пистолет для продувки с удлинителем
- CZ Ofukovací pistole s nástavcem
- HU Lefúvó pisztoly hosszú toldattal
- RO Pistol pt. suflat cu extensie
- FR Soufflette avec rallonge
- IT Pistola di soffiaggio con prolunga
- ES Pistola de soplado con extensión
- CN 吹尘枪

0.8 MPa (max.)	520 mm	PP		
BRASS MOSIADZ				



$L_{pa} = 89,0$ dB; $L_{wa} = 100,0$ dB; $a_h = <2,5$ m/s²

YATO	YT-23733		30/60
-------------	-----------------	--	-------

EN Short air blow gun with turbo
PL Pistolet do przedmuchiwania krótki turbo
DE Turbo-Blaspistole, kurz
RU Короткий турбо пистолет для продувки
CZ Profukovací pistole krátká turbo
HU Fúvató pisztoly rövid turbó
RO Pistol de suflat scurt, funcție turbo
FR Soufflette à air comprimée courte turbo
IT Pistola per soffiaggio corte turbo
ES Pistola de soplado, corta turbo
CN 增压吹尘枪

0.62 MPa 45 mm TURBO NOZZLE DYŠKA TURBO STANDARD



$L_{pa} = 86,0 \pm 3,0$ dB; $L_{wa} = 97,0 \pm 3,0$ dB; $a_n = <2,5$ m/s²

YATO
YT-23722 50

EN Long air blow gun with turbo
PL Pistolet do przedmuchiwania długi turbo
DE Turbo-Blaspistole, lang
RU Длинный турбо пистолет для продувки
CZ Profukovací pistole dlouhá turbo
HU Fúvató pisztoly hosszú turbó
RO Pistol de suflat, tijă lungă, funcție turbo
FR Soufflette à air comprimée longue turbo
IT Pistola per soffiaggio lungo turbo
ES Pistola de soplado, larga turbo
CN 长嘴增压吹尘枪

0.62 MPa (max) 110 mm TURBO NOZZLE DYŠKA TURBO STANDARD



$L_{pa} = 86,0 \pm 3,0$ dB; $L_{wa} = 97,0 \pm 3,0$ dB; $a_n = <2,5$ m/s²

YATO
YT-23723 25

EN Air washing gun
PL Pistolet do ropowania
DE Druckluft-Sprühpistole
RU Пистолет для нефтewания
CZ Pistole na ropování
HU Olajzó pisztoly
RO Pistol pt. spălat
FR Pistolet de lavage à air
IT Pistola lavaggio per nafta
ES Pistola de petrolear
CN 清洗枪

0.8 MPa (max) 130 l/min 0.85L AI STANDARD



$L_{pa} = 92,0$ dB; $L_{wa} = 103,0$ dB; $a_n = <2,5$ m/s²

YATO
YT-2374 2/12

EN Air sand blaster
PL Pistolet do piaskowania z węzłem
DE Pistole zum Sandstrahlen
RU Пескоструйный пистолет
CZ Pískovací pistole s hadicí
HU Homokszóró pisztoly tömlővel
RO Pistol de sablat
FR Pistolet de sablage avec tuyau
IT Pistola sabbiatrica
ES Pistola para limpieza con chorro de arena con manguera
CN 喷砂枪

0.8 MPa (max) 160 l/min 1/4" 6.3 mm 1m AI STANDARD



$L_{pa} = 90,0$ dB; $L_{wa} = 101,0$ dB; $a_n = <2,03$ m/s²

YATO
YT-2375 10

EN Gun suitable for sand-blasting
PL Pistolet do piaskowania ze zbiornikiem
DE Sandstrahlpistole
RU Пескоструйный пистолет
CZ Pískovací pistole se zásobníkem
HU Homokszóró pisztoly tartállyal
RO Pistol de sablat
FR Pistolet de sablage avec réservoir
IT Pistola sabbiatrica con serbatoio
ES Pistola para limpieza con chorro de arena con recip
CN 喷砂枪

0.8 MPa 160 l/min 1L AI STANDARD



$L_{pa} = 91,0$ dB; $L_{wa} = 102,0$ dB; $a_n = 2,03$ m/s²

YATO
YT-2376 20

EN Work bench
PL Stojak lakierniczy rozstawny
DE Lackierständer, verstellbar
RU Раздвижная лакировочная стойка
CZ Stojan lakovnický rozkládací
HU Kinyitható lakkozó állvány
RO Banc extensibil pt. vopsit
FR Support à peindre
IT Supporto pieghevole
ES Montante plegable para barnizar
CN 工作台

max 10 kg 50x85 cm max 150 kg 100x45 cm



YATO
YT-5555 1

EN Mini filter
PL Filtr
DE Filter
RU Минифильтр
CZ Filtr
HU Szűrő
RO Minifiltru
FR Vidange mini
IT Filtro
ES Filtro
CN 微型过滤器

1.4 MPa (max.)
8 cm³
1/4" 6.3mm



YATO
YT-2380

25/50

EN Pressure reducing valve with manometer
PL Reduktor ciśnienia z manometrem
DE Druckminderer mit Manometer
RU Клапан уменьшения давления с манометром
CZ Redukční ventil s manometrem
HU Nyomáscsökkentő szelep nyomásmérővel
RO Valvă reducere presiune cu manometru
FR Réducteur avec manomètre
IT Regolatore di pressione con manometro
ES Reductor + manómetro
CN 带表调压减压阀

1.2 MPa (max.)
1/4" 6.3mm



YATO
YT-2381

25/50

EN Air filter and regulator
PL Filtr z reduktorem
DE Druckluft-Filterregler
RU Фильтр-влажностделитель с редуктором
CZ Redukční ventil s filtrem
HU Szűrő-nyomásszabályzó
RO Filtru cu reductor
FR Filtre à air avec réducteur
IT Filtro con regolatore
ES Filtro y regulador de aire
CN 过滤器

0.93 MPa (max.)
15 cm³
1/4" 6.3mm
max°C 60



YATO
YT-2382

25/50

EN Air filter and regulator
PL Filtr z reduktorem
DE Druckluft-Filterregler
RU Фильтр-влажностделитель с редуктором
CZ Redukční ventil s filtrem
HU Szűrő-nyomásszabályzó
RO Filtru cu reductor
FR Filtre à air avec réducteur
IT Filtro con regolatore
ES Filtro y regulador de aire
CN 过滤器

0.93 MPa (max.)
90 cm³
1/2" 12.7mm
max°C 60



YATO
YT-2383

25/50

EN Air filter, regulator and lubricator
PL Zespół filtrujący, reduktor i smarownica
DE Druckluft-Filterregler mit Öl
RU Фильтр-влажностделитель с редуктором и лубрикаторм
CZ Redukční ventil s filtrem a maznic
HU Szűrő, nyomásszabályzó, olajzó
RO Filtru cu reductor și rezervor de ulei
FR Filtre à air, régulateur et lubrificateur
IT Gruppo filtro, regolatore e lubrificatore
ES Filtro de aire, regulador y lubricador
CN 过滤器

0.93 MPa (max.)
25cm³ FILTER
15cm³ LUBRICATOR SMAROWNICA
1/4" 6.3mm
max°C 60



YATO
YT-2384

25/50

EN Air filter, regulator and lubricator
PL Zespół filtrujący, reduktor i smarownica
DE Druckluft-Filterregler mit Öl
RU Фильтр-влажностделитель с редуктором и лубрикаторм
CZ Redukční ventil s filtrem a maznic
HU Szűrő, nyomásszabályzó, olajzó
RO Filtru cu reductor și rezervor de ulei
FR Filtre à air, régulateur et lubrificateur
IT Gruppo filtro, regolatore e lubrificatore
ES Filtro de aire, regulador y lubricador
CN 过滤器

0.93 MPa (max.)
90cm³ FILTER
60cm³ LUBRICATOR SMAROWNICA
1/4" 6.3mm
max°C 60



YATO
YT-2385

25

EN Spiral hose with quick couplers
PL Wąż spiralny z szybkozłączami
DE Spiralschlauch mit Schnellkupplung
RU Шланг спиральный с быстроразъемными соединениями
CZ Spirálová vzduchová hadice s rychlospojkami
HU Spirál tömlő gyorscsatlakozós

RO Furtun spiralat cu cuple rapide
FR Tuyau spirale avec raccords rapides
IT Tubo a spirale con raccordi rapidi
ES Manguera espiral con conectores rápidos
CN 气管带接头

1.2 MPa (max.)
PU
STANDARD



YATO	Internal diameter / Średnica wewnętrzna [mm]	External diameter / Średnica zewnętrzną [mm]	L [m]	
YT-24201	5.5	8	5	50
YT-24202	5.5	8	10	25
YT-24203	5.5	8	15	25
YT-24204	6.5	10	5	50
YT-24205	6.5	10	10	20
YT-24206	6.5	10	15	25
YT-24207	8.0	12	5	20
YT-24208	8.0	12	10	10
YT-24209	8.0	12	15	10

EN Reinforced air hose with quick couplers
PL Wąż techniczny zbrojony z szybkozłączami
DE Verstärkter Luftschauch mit Schnellkupplung
RU Пневматический шланг с быстроразъемными соединениями
CZ Vzduchová hadice s rychlospojkami
HU Levegőtömítő gyorscsatlakozós
RO Furtun aer comprimat cuple rapide
FR Tuyau air comprimé avec raccords rapides
IT Tubo con rinforzo per aria con raccordi rapidi
ES Manguera de aire con conectores rápidos
CN 气管带接头

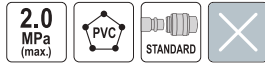

YATO	Internal diameter / Średnica wewnętrzna [mm]	L [m]	
YT-24220	8	10	10
YT-24221	8	20	8
YT-24224	10	10	10
YT-24225	10	20	4

EN Hybrid air hose
PL Przewód pneumatyczny hybrydowy
DE Hybrid-Druckluftleitung
RU Пневматический гибридный шланг
CZ Hybridní pneumatická hadice
HU Hibrid pneumatikus vezeték
RO Furtun aer, hibrid
FR Tuyau pneumatique hybride
IT Condotto pneumatico ibrido
ES Conduto neumático híbrido
CN 橡胶高弹管



YATO	Internal diameter / Średnica wewnętrzna [mm]	L [m]	
YT-24230	6.5	10	10
YT-24231	6.5	20	5
YT-24232	6.5	30	4

EN Hybrid air hose
PL Przewód pneumatyczny hybrydowy
DE Hybrid-Druckluftleitung
RU Пневматический гибридный шланг
CZ Hybridní pneumatická hadice
HU Hibrid pneumatikus vezeték
RO Furtun aer, hibrid
FR Tuyau pneumatique hybride
IT Condotto pneumatico ibrido
ES Conduto neumático híbrido
CN 橡胶高弹管



YATO	Internal diameter / Średnica wewnętrzna [mm]	L [m]	
YT-24233	8	10	10
YT-24234	8	20	5

EN Hybrid air hose
PL Przewód pneumatyczny hybrydowy
DE Hybrid-Druckluftleitung
RU Пневматический гибридный шланг
CZ Hybridní pneumatická hadice
HU Hibrid pneumatikus vezeték
RO Furtun aer, hibrid
FR Tuyau pneumatique hybride
IT Condotto pneumatico ibrido
ES Conduto neumático híbrido
CN 橡胶高弹管



YATO	Internal diameter / Średnica wewnętrzna [mm]	L [m]	
YT-24236	12.5	10	10
YT-24237	12.5	20	5

EN Air hose reel
PL Wąż pneumatyczny na zwijaku
DE Luftschauch am Haspel
RU Шланг пневматический на катушке
CZ Navíják se vzduchovou hadicí
HU Sűrített levegős tömlődob
RO Furtun de aer pe tambur
FR Enrouleur de tuyaux d'air
IT Avvolgitubo aria
ES Carrete de manguera de aire
CN 气动软管卷盘



YATO	
YT-24240	2

EN Air hose reel
PL Wąż pneumatyczny na zwijaku
DE Luftschauch am Haspel
RU Шланг пневматический на катушке
CZ Navíják se vzduchovou hadicí
HU Sűrített levegős tömlődob
RO Furtun de aer pe tambur
FR Enrouleur de tuyaux d'air
IT Avvolgitubo aria
ES Carrete de manguera de aire
CN 气动软管卷盘



YATO	
YT-24241	2

EN Air hose reel
PL Wąż pneumatyczny na zwijaku
DE Luftschauch am Haspel
RU Шланг пневматический на катушке
CZ Navíják se vzduchovou hadicí
HU Sűrített levegős tömlődob
RO Furtun de aer pe tambur
FR Enrouleur de tuyaux d'air
IT Avvolgitubo aria
ES Carrete de manguera de aire
CN 气动软管卷盘







YATO	
YT-24242	4

EN Air hose reel
PL Wąż pneumatyczny na zwijaku
DE Luftschauch am Haspel
RU Шланг пневматический на катушке
CZ Navíják se vzduchovou hadicí
HU Sűrített levegős tömlődob
RO Furtun de aer pe tambur
FR Enrouleur de tuyaux d'air
IT Avvolgitubo aria
ES Carrete de manguera de aire
CN 气动软管卷盘



YATO	
YT-24243	4

EN Air hose reel
 PL Waż pneumatyczny na zwijaku
 DE Luftschnlauch am Haspel
 RU Шланг пневматический на катушке
 CZ Naviják se vzduchovou hadicí
 HU Sűrített levegős tömlődob
 RO Furtun de aer pe tambur
 FR Enrouleur de tuyaux d'air
 IT Avvolgitubo aria
 ES Carrete de manguera de aire
 CN 气动软管卷盘



2.0 MPa (max.)	20 m	\varnothing 8 mm	G 1/4 BSPT	
				
x4 ANCHORS KOTVY	EASILY MOUNT LÁTVY MONTÁZ	PVC		





EN Air hose reel
 PL Waż pneumatyczny na zwijaku
 DE Luftschnlauch am Haspel
 RU Шланг пневматический на катушке
 CZ Naviják se vzduchovou hadicí
 HU Sűrített levegős tömlődob
 RO Furtun de aer pe tambur
 FR Enrouleur de tuyaux d'air
 IT Avvolgitubo aria
 ES Carrete de manguera de aire
 CN 气动软管卷盘

2.0 MPa (max.)	15 m	\varnothing 9.5 mm	G 1/4 BSPT	
				
x4 ANCHORS KOTVY	EASILY MOUNT LÁTVY MONTÁZ	PVC		



YATO  **YT-24244**  2

YATO  **YT-24245**  1

EN Air hose reel
 PL Waż pneumatyczny na zwijaku
 DE Luftschnlauch am Haspel
 RU Шланг пневматический на катушке
 CZ Naviják se vzduchovou hadicí
 HU Sűrített levegős tömlődob
 RO Furtun de aer pe tambur
 FR Enrouleur de tuyaux d'air
 IT Avvolgitubo aria
 ES Carrete de manguera de aire
 CN 气动软管卷盘

2.0 MPa (max.)	15 m	\varnothing 12.5 mm	G 1/4 BSPT	
				
x4 ANCHORS KOTVY	EASILY MOUNT LÁTVY MONTÁZ	PVC		



EN Air hose reel
 PL Waż pneumatyczny na zwijaku
 DE Luftschnlauch am Haspel
 RU Шланг пневматический на катушке
 CZ Naviják se vzduchovou hadicí
 HU Sűrített levegős tömlődob
 RO Furtun de aer pe tambur
 FR Enrouleur de tuyaux d'air
 IT Avvolgitubo aria
 ES Carrete de manguera de aire
 CN 气动软管卷盘

2.0 MPa (max.)	15 m	\varnothing 9.5 mm	G 1/4 BSPT	
				
EASILY MOUNT LÁTVY MONTÁZ	PVC			



YATO  **YT-24246**  1

YATO  **YT-24250**  1

EN Air hose reel
 PL Waż pneumatyczny na zwijaku
 DE Luftschnlauch am Haspel
 RU Шланг пневматический на катушке
 CZ Naviják se vzduchovou hadicí
 HU Sűrített levegős tömlődob
 RO Furtun de aer pe tambur
 FR Enrouleur de tuyaux d'air
 IT Avvolgitubo aria
 ES Carrete de manguera de aire
 CN 气动软管卷盘

2.0 MPa (max.)	20 m	\varnothing 9.5 mm	G 1/4 BSPT		EASILY MOUNT LÁTVY MONTÁZ
					
					PVC
					



EN Air hose reel
 PL Waż pneumatyczny na zwijaku
 DE Luftschnlauch am Haspel
 RU Шланг пневматический на катушке
 CZ Naviják se vzduchovou hadicí
 HU Sűrített levegős tömlődob
 RO Furtun de aer pe tambur
 FR Enrouleur de tuyaux d'air
 IT Avvolgitubo aria
 ES Carrete de manguera de aire
 CN 气动软管卷盘

2.0 MPa (max.)	30 m	\varnothing 8 mm	G 1/4 BSPT	PVC	
					



YATO  **YT-24251**  1

YATO  **YT-24253**  1

EN Quick coupler
PL Szybkozłącze
DE Schnellkupplung
RU Быстрое соединение
CZ Rychlospojka
HU Gyorscsatlakozó
RO Mufă rapidă pt. aer comprimat
FR Raccord rapide
IT Attacco rapido
ES Conexión de la entrada de aire
CN 快速接头

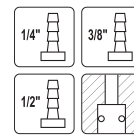
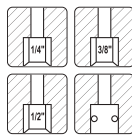
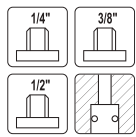

YATO	Thread size / Rozmiar gwintu	Box
YT-2390	G1/4	20/120
YT-2391	G3/8	20/120
YT-2392	G1/2	20/120

YATO	Thread size / Rozmiar gwintu	Box
YT-2393	G1/4	20/120
YT-2394	G3/8	20/120
YT-2395	G1/2	20/120

YATO	Connector diameter / Średnica króćca [mm]	Box
YT-2396	6	20/120
YT-2397	8	20/120
YT-2398	10	20/120

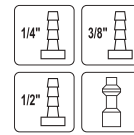
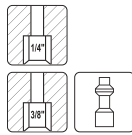
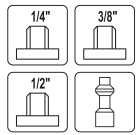

YATO	Thread size / Rozmiar gwintu	Box
YT-2399	G1/4	50/250
YT-2401	G3/8	50/250
YT-2402	G1/2	50/250

YATO	Thread size / Rozmiar gwintu	Box
YT-2403	G1/4	50/250
YT-2404	G3/8	50/250

YATO	Connector diameter / Średnica króćca [mm]	Box
YT-2405	6	50/250
YT-2406	8	50/250
YT-2407	10	50/250

EN Quick coupler
PL Szybkozłącze
DE Schnellkupplung
RU Быстрое соединение
CZ Rychlospojka
HU Gyorscsatlakozó
RO Mufă rapidă pt. aer comprimat
FR Raccord rapide
IT Attacco rapido
ES Conexión de la entrada de aire
CN 快速接头

2
PCS

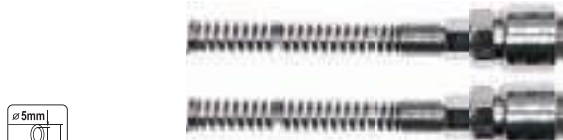

YATO	Box
YT-24100	6/60

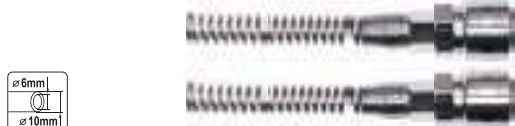

YATO	Box
YT-24101	6/60



YATO	Box
YT-24102	6/60

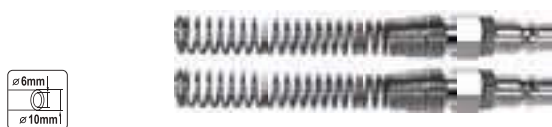

YATO	Box
YT-24103	6/60

EN 2 way quick coupler
PL Szybkozłącze podwójne
DE Zwei-wege Schnellkupplung
RU Двусторонняя быстроразъемные соединения
CZ Two-way rychlospojky
HU Levegőelosztó kettes gyorscsat
RO Distribuitoare cuple rapide
FR Dérivation type y en cuivre
IT Raccordo ottone con vie
ES Manera 2 manguera de aire pase de acoplamiento rápido
CN 三通万用插嘴

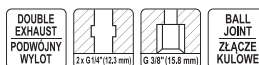

YATO	Box
YT-24091	25/50

EN Quick coupler
PL Szybkozłącze
DE Schnellkupplung
RU Быстрое соединение
CZ Rychlospojka
HU Gyorscsatlakozó
RO Mufă rapidă pt. aer comprimat
FR Raccord rapide
IT Attacco rapido
ES Conexión de la entrada de aire
CN 快速接头

BRASS
MOSIADZ

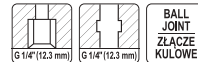

YATO	Box
YT-24092	50/100

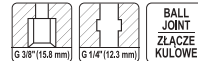

YATO	Box
YT-24093	50/100

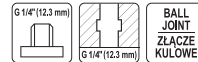

YATO	Box
YT-24094	50/100

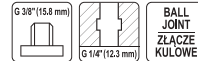

YATO	Box
YT-24095	50/100

EN Air hose swivel connector
PL Przegub pneumatyczny
DE Druckluft Gelenk-Kupplung
RU Пневматическое соединение
CZ Pneumatický kloub
HU Pneumatikus forgócsukló
RO Conector pivotant pt. furtun de aer
FR Raccord pneumatique
IT Giunto pneumatico
ES Junta neumática
CN 万向接头

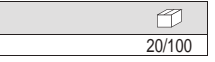

YATO	Box
YT-24130	20/100

EN Pneumatic grease injector
 PL Smarownica pneumatyczna
 DE Druckluft-Fettpresse
 RU Пневматический нагнетатель смазки
 CZ Maznice pneumatická
 HU Pneumatikus zsírzó
 RO Pompă pneumatică pt. gresat
 FR Pompe à graisse pneumatique
 IT Ingrassatore pneumatico
 ES Bomba de engrase neumática lubricar
 CN 气动黄油机



40 MPa (max.)	0.6-0.8 MPa
12 L	4 m
50:1 RATIO SPEZIJANJE	STANDARD
	

$L_{PA} = 97,0 \pm 3,0$ dB; $L_{WA} = 108,0 \pm 3,0$ dB

YATO 		
YT-07067	12	1

EN Pneumatic grease injector
 PL Smarownica pneumatyczna
 DE Druckluft-Fettpresse
 RU Пневматический нагнетатель смазки
 CZ Maznice pneumatická
 HU Pneumatikus zsírzó
 RO Pompă pneumatică pt. gresat
 FR Pompe à graisse pneumatique
 IT Ingrassatore pneumatico
 ES Bomba de engrase neumática lubricar
 CN 气动黄油机



40 MPa (max.)	0.6-0.8 MPa	30 L	4 m
50:1 RATIO SPEZIJANJE		STANDARD	

$L_{PA} = 99,0 \pm 3,0$ dB; $L_{WA} = 110,0 \pm 3,0$ dB



YATO 		
YT-07068	30	1

EN Pneumatic grease injector
 PL Smarownica pneumatyczna
 DE Druckluft-Fettpresse
 RU Пневматический нагнетатель смазки
 CZ Maznice pneumatická
 HU Pneumatikus zsírzó
 RO Pompă pneumatică pt. gresat
 FR Pompe à graisse pneumatique
 IT Ingrassatore pneumatico
 ES Bomba de engrase neumática lubricar
 CN 气动黄油机



40 MPa (max.)	0.6-0.8 MPa	45 L	4 m
50:1 RATIO SPEZIJANJE		STANDARD	

$L_{PA} = 97,0 \pm 3,0$ dB; $L_{WA} = 108,0 \pm 3,0$ dB



YATO 		
YT-07069	45	1

EN Pneumatic oiling machine
 PL Pneumatyczny napełniacz do oleju
 DE Pneumatischer Öleinfüller
 RU Пневматический наполнитель для масла
 CZ Pneumatické plnidlo oleje
 HU Pneumatikus olajfeltöltő
 RO Pompă pneumatică pt. ulei
 FR Pompes et de remplissage d'huile pneumatique
 IT Dispositivo di riempimento olio
 ES Dispositivo de llenado de aceite
 CN 齿轮油加油机



0.3 MPa (max.)	20 L
1.1 m	1x
STANDARD	
	

$L_{PA} = 101,2 \pm 3,0$ dB; $L_{WA} = 119,8 \pm 3,0$ dB

YATO 		
YT-07195	20	1

EN Pneumatic oil drain extractor
PL Zlewarko-wysysarka pneumatyczna
DE Druckluft Ölabsauggerät / Ölaufanggerät
RU Маслосборная установка пневматическая
CZ Pneumatická odsávačka vyjetého oleje
HU Pneumatikus fátartolaj gyűjtő / leszívó
RO Recuperator pneumatic pt. ulei uzat
FR Récupérateur d'huile par aspiration
IT Aspiratore-recuperatore pneumatico
ES Recuperador de aceite de succión
CN 抽接油机



0.7-0.8 MPa
SUCTION
OŚSIŚWIANIE

0.18 MPa
EJECTION
OPROZNIANIE

70 L

6
SUCTION PROBES
SONDY ŚSACIE

4x

STANDARD

$L_{pA} = 101,2 \pm 3,0$ dB; $L_{wA} = 119,8 \pm 3,0$ dB

YATO	[]	[]
YT-07191	70	1

EN Air grease gun
PL Smarownica pneumatyczna
DE Druckluft-Fettpresse
RU Шприц для смазки пневматический
CZ Mazací lis pneumatický
HU Pneumatikus zsírzó
RO Pistol de gresat pneumatic
FR Pistolet à graisse pneumatique
IT Ingrassatore pneumatico
ES Pistola engrasadora neumática
CN 气动黄油枪



0.62 MPa
IN
0.2-0.62 MPa

OUT
30-40 MPa

400 cm³

28 l/min

STANDARD

$L_{pA} = 85,0 \pm 3,0$ dB; $L_{wA} = 96,0 \pm 3,0$ dB; $a_n \leq 2,5$ m/s²

YATO	[]	[]
YT-07055		10

EN Pneumatic oil drain extractor
PL Zlewarko-wysysarka pneumatyczna
DE Druckluft Ölabsauggerät / Ölaufanggerät
RU Маслосборная установка пневматическая
CZ Pneumatická odsávačka vyjetého oleje
HU Pneumatikus fátartolaj gyűjtő / leszívó
RO Recuperator pneumatic pt. ulei uzat
FR Récupérateur d'huile par aspiration
IT Aspiratore-recuperatore pneumatico
ES Recuperador de aceite de succión
CN 抽接油机



0.7-0.8 MPa
SUCTION
OŚSIŚWIANIE

0.18 MPa
EJECTION
OPROZNIANIE

90 L

6
SUCTION PROBES
SONDY ŚSACIE

4x

STANDARD

$L_{pA} = 101,2 \pm 3,0$ dB; $L_{wA} = 119,8 \pm 3,0$ dB

YATO	[]	[]
YT-07190	90	1

EN Air grease gun
PL Smarownica pneumatyczna
DE Druckluft-Fettpresse
RU Шприц для смазки пневматический
CZ Mazací lis pneumatický
HU Pneumatikus zsírzó
RO Pistol de gresat pneumatic
FR Pistolet à graisse pneumatique
IT Ingrassatore pneumatico
ES Pistola engrasadora neumática
CN 气动黄油枪



0.63 MPa
IN
0.2-0.63 MPa

OUT
6-28 MPa

400 cm³

220 l/min

STANDARD

$L_{pA} \leq 70,0$ dB; $L_{wA} \leq 80,0$ dB; $a_n \leq 2,5$ m/s²

YATO	[]	[]
YT-07057		10

EN Air compressor
 PL Kompressor olejowy
 DE Ölkompressor
 RU Масляный компрессор
 CZ Olejový kompresor
 HU Olajos kompresszor
 RO Compresor
 FR Compresseur à pistons
 IT Compresore a olio
 ES Compresor de pistón
 CN 直连式空压机

230-240V~
50Hz

1.5kW
2KM

1500
W

 2850
min⁻¹

0.8
MPa



200
l/min

24L





$L_{pa} = 74.2 \pm 3.0$ dB; $L_{wa} = 93.7 \pm 2.23$ dB

YATO 	[W]	
YT-23300	1500	1

EN Air compressor
 PL Kompressor olejowy
 DE Ölkompressor
 RU Масляный компрессор
 CZ Olejový kompresor
 HU Olajos kompresszor
 RO Compresor
 FR Compresseur à pistons
 IT Compresore a olio
 ES Compresor de pistón
 CN 直连式空压机

230-240V~
50Hz

1.5kW
2KM

1500
W

 2850
min⁻¹

0.8
MPa

200
l/min

50L





$L_{pa} = 74.2 \pm 3.0$ dB; $L_{wa} = 93.7 \pm 2.23$ dB

YATO 	[W]	
YT-23305	1500	1

EN Air compressor
 PL Kompressor olejowy
 DE Ölkompressor
 RU Масляный компрессор
 CZ Olejový kompresor
 HU Olajos kompresszor
 RO Compresor
 FR Compresseur à pistons
 IT Compresore a olio
 ES Compresor de pistón
 CN 直连式空压机

230V~
50Hz

2.2kW
3KM

2200
W

 1100
min⁻¹

2x 

1.0
MPa



360
l/min

100L





$L_{pa} = 74.7 \pm 3.0$ dB; $L_{wa} = 93.8 \pm 2.28$ dB

YATO 	[W]	
YT-23310	2200	1

EN Air compressor
 PL Kompressor olejowy
 DE Ölkompressor
 RU Масляный компрессор
 CZ Olejový kompresor
 HU Olajos kompresszor
 RO Compresor
 FR Compresseur à pistons
 IT Compresore a olio
 ES Compresor de pistón
 CN 直连式空压机

230V~
50Hz

2.2kW
3KM

2200
W

 1100
min⁻¹

2x 

1.0
MPa

360
l/min

200L





$L_{pa} = 74.7 \pm 3.0$ dB; $L_{wa} = 93.8 \pm 2.28$ dB

YATO 	[W]	
YT-23320	2200	1

EN Pneumatic riveting machine
PL Nitownica pneumatyczna
DE Druckluft Nietzange
RU Пневматический заклёпочник
CZ Pneumatická nýtovačka
HU Pneumatikus popszegecsőhúzó
RO Presa pneumatica pt. nituit
FR Riveuse pneumatique
IT Rivettatrice pneumatica
ES Máquina remachadora
CN 气动拉铆枪

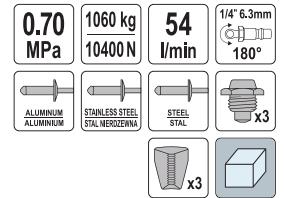

$L_{pa} = 83.6 \pm 1.9$ dB; $L_{ma} = 97.4 \pm 2.8$ dB; $a_h = 0.66 \pm 0.21$ m/s²

YATO	Ø [mm]	Max. piston stroke / Maks. skok tłoka silownika [mm]	F [kg]	F [N]	
YT-36171	2.4, 3.2, 4, 4.8, 5	18	757-1060	7430-10400	10

EN Pneumatic riveting machine
PL Nitownica pneumatyczna
DE Druckluft Nietzange
RU Пневматический заклёпочник
CZ Pneumatická nýtovačka
HU Pneumatikus popszegecsőhúzó
RO Presa pneumatica pt. nituit
FR Riveuse pneumatique
IT Rivettatrice pneumatica
ES Máquina remachadora
CN 气动拉铆枪

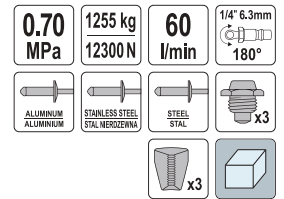

$L_{pa} = 87.2 \pm 2.3$ dB; $L_{ma} = 94.5 \pm 3.0$ dB; $a_h = 0.54 \pm 0.15$ m/s²

YATO	Ø [mm]	Max. piston stroke / Maks. skok tłoka silownika [mm]	F [kg]	F [N]	
YT-36177	4, 4.8, 5, 5.4, 6, 6.4	20	1255	12300	10

EN Pneumatic riveting machine
PL Nitownica pneumatyczna
DE Druckluft Nietzange
RU Пневматический заклёпочник
CZ Pneumatická nýtovačka
HU Pneumatikus popszegecsőhúzó
RO Presa pneumatica pt. nituit
FR Riveuse pneumatique
IT Rivettatrice pneumatica
ES Máquina remachadora
CN 气动拉铆枪

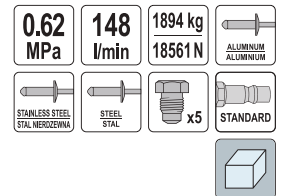

$L_{pa} = 81.2 \pm 3.0$ dB; $L_{ma} = 92.2 \pm 3.0$ dB; $a_h = 0.6 \pm 0.56$ m/s²

YATO	Ø [mm]	Max. piston stroke / Maks. skok tłoka silownika [mm]	F [kg]	F [N]	
YT-3618	2.4, 3.2, 4, 4.8, 6.4	19	1894	18561	6

- Application: industry
- Przeznaczenie: przemysł

EN Collated screws for metal
PL Wkręty na taśmie do metalu
DE Magazinierter Schrauben für Metall
RU Саморезы в ленте по металлу
CZ Šrouby do kovu na pásce
HU Szalagtáras csavar fémhez

RO Banda suruburi pt. metal
FR Vis pour métal en bande
IT Viti per metallo a nastro
ES Tornillos en tira para metal
CN 螺丝钉

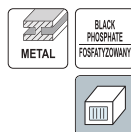

YATO	Ø [mm]	L [mm]	Screw head drive type / Rodzaj nacięcia łba	pcs / szt.	
YT-09440	3.5	25	PH2	1000	10
YT-09442	3.5	35	PH2	1000	10

EN Collated screws for wood
PL Wkręty na taśmie do drewna
DE Magazinierter Schrauben für Holz
RU Саморезы в ленте по дереву
CZ Šrouby do dřeva na pásce
HU Szalagtáras csavar fához

RO Banda suruburi pt. lemn
FR Vis pour bois en bande
IT Viti per legno a nastro
ES Tornillos en tira para madera
CN 螺丝钉



YATO	Ø [mm]	L [mm]	Screw head drive type / Rodzaj nacięcia łba	pcs / szt.	
YT-09460	3.9	35	PH2	1000	10
YT-09461	3.9	45	PH2	1000	8

16

Special automotive tools & equipment
Narzędzia i wyposażenie
warsztatu samochodowego



Furniture & cabinets Meble i szafki		357-377
---	---	---------

Furniture Meble	357
Roller cabinets with tools insert Szafki serwisowe z narzędziami	360
Tool cabinets Szafki serwisowe	366
Workbenches Stoły warsztatowe	369
Tools in PVC trays Zestawy narzędzi do szuflad	369
Accessories for tool cabinets & workbenches Akcesoria do szafek i stołów	375

Tool boxes Skrzynki narzędziowe		378-381
---	---	---------

Lubrication system tools Narzędzia do obsługi układu smarowania		382-389
---	---	---------

Oil filter wrenches & sets Klucze do filtra oleju i zestawy	382
Oil drain plug sockets Klucze do spustu oleju	384
Grease guns & accessories Smarownice ręczne i akcesoria	386
Oil cans Oliwiarki	388
Oil and fuel pumps Pompy do oleju oraz paliwa	389

Pullers Ściągacze		390-405
-----------------------------	---	---------

Pullers Ściągacze	390
Roller stud extractor sets Zestawy ściągaczy do szpilek	397
Upholstery removers Ściągacze do tapicerki	404

Car window tools Narzędzia do szyb samochodowych		406-407
--	---	---------

Special pullers Ściągacze specjalistyczne		407-408
---	---	---------

Air condition tools Narzędzia do klimatyzacji		409
---	---	-----

Fuel feel pipe pliers Szczypce motoryzacyjne		409-413
--	---	---------

Engine repair tools Narzędzia do obsługi silnika		414-448
--	---	---------

Piston ring compressors Zaciskacze do pierścieni	414
Honing machines & accessories Honownice i akcesoria	414
Engine repair and diagnostic tools Narzędzia do diagnostyki i naprawy silników	416

Brake system tools Narzędzia do obsługi układu hamulcowego		448-456
--	---	---------

Suspension system tools Narzędzia do obsługi podwozia		456-462
---	---	---------

Spring clamps & accessories Ściągacze do sprężyn i akcesoria	456
Shock absorber nut sets Zestawy nasadek do amortyzatorów	457
Tire valve stem inserter Przeciągacze do zaworów gumowych	457
Wheel balance pliers Szczypce do wyważania kół	458
Deep thin wall impact sockets Udarowe klucze nasadowe do felg aluminiowych	458
Wheel wrenches Klucze do kół	460
Impact wrenches Klucze udarowe	461
Tire levers Łyżki do opon	462

Workshop tools Narzędzia warsztatowe		462-473
--	---	---------

Inspection tools Narzędzia inspekcyjne	462
Magnetic pick up tools Chwytki magnetyczne	462
Magnetic trays Tacki magnetyczne	463
Workshop seats Taborety warsztatowe	465
Workshop creepers Leżanki warsztatowe	465
Workshop mats Maty warsztatowe	465
Voltage testers Próbniki napięcia	466
Tapes Taśmy	466
Number & letter stamps Znaczniki cyfrowe i literowe	466
Thread repair sets & accessories Zestawy do naprawy gwintów i akcesoria	466
Pressure gauges Wskaźniki ciśnienia	470
Pumps Pompy	471
Compressors Kompresory	471
Hoses Węże	472





Air wedges	
Poduszki montażowe	473
Tire racks	
Stojaki na koła	473

Funnels, oil drainer & drainer pans		
Lejki, miski i zlewarki do oleju	473-475	

Bottle & floor jacks		
Dźwigniki słupkowe i podnośniki	476-477	

Vehicle ramps & jack stands		
Najazdy i podstawki pod samochód	478	

Slide hammers		
Młotki blacharskie	478	

Porta power kits		
Rozpieraki hydrauliczne	478-479	

Battery chargers, jump starters, power inverters & battery testers		
Prostowniki, urządzenia rozruchowe, przetwornice napięcia i testery akumulatorów	479-483	

Refractometers		
Refraktometry	483	

Workshop cable reels		
Przedłużacze warsztatowe	484	

Workshop equipment		
Sprzęt warsztatowy	484-488	

Chain blocks		
Wciągarki łańcuchowe	484	
Lever blocks		
Wciągarki łańcuchowe dźwigniowe	484	
Hand pullers		
Wciągarki linowe, ręczne	484	
Transmission jacks		
Podnośniki skrzyni biegów	485	
Parts washers		
Mylki warsztatowe	485	
Sandblaster cabinets & accessories		
Piaskarki kabinowe i akcesoria	486	
Shop cranes & shop presses		
Żurawie i prasy warsztatowe	487	

Workshop standardized parts		
Normalia motoryzacyjne	489-505	

CREATE YOUR WORKPLACE - STWÓRZ SWOJE MIEJSCE PRACY

YT-08931

High workshop cabinet
Szafka warsztatowa wysoka



YT-08E35

Wall cabinet
Szafka podwieszana

YT-08E36

Hook panel
Panel perforowany

YT-08E38

YT-08E39

Worktop
Blat roboczy

YT-08E34

Workshop cabinet
Szafka warsztatowa

YT-08E33

Workshop cabinet
Szafka warsztatowa

EN High workshop cabinet
PL Szafka warsztatowa wysoka
DE Hoher Werkstattschrank
RU Шкаф для мастерской высокий
CZ Dilenská skříň na nářadí vysoká
HU Magas szerszámós szekrény
RO Dulap pt. atelier înalt
FR Armoire d'atelier haute
IT Armadio da officina alto
ES Armario de taller alto
CN 高柜



660x457
x2000
mm

x3
SHELVES
POZIEM

ADJUSTABLE
FEET
REGULOWANE
STOPY

2x



EN Workshop cabinet
PL Szafka warsztatowa
DE Werkstattschrank
RU Тумба инструментальная
CZ Dilenská skříň na nářadí
HU Szerszámós szekrény
RO Dulap pt. atelier
FR Armoire d'atelier
IT Armadio da officina
ES Armario de taller
CN 工具柜



660x457
x863
mm

4x

ADJUSTABLE
FEET
REGULOWANE
STOPY

BALL
BEARINGS
ŁOŻYSKA
KULKOWE

2x



YATO

Drawer quantity / Liczba szuflad

YT-08933

4

1

EN Workshop cabinet
PL Szafka warsztatowa
DE Werkstattschrank
RU Тумба инструментальная
CZ Dilenská skříň na nářadí
HU Szerszámós szekrény
RO Dulap pt. atelier
FR Armoire d'atelier
IT Armadio da officina
ES Armario de taller
CN 工具柜



660x457
x863
mm

SHELF
POLKA

ADJUSTABLE
FEET
REGULOWANE
STOPY

2x



YATO

YT-08931

1

YATO

YT-08934

1

EN Wall cabinet
 PL Szafka podwieszana
 DE Hängeschrank
 RU Настенный инструментальный шкаф
 CZ Nástěnná skříň
 HU Fali szekrény
 RO Dulap de perete
 FR Armoire murale
 IT Armadio sospeso
 ES Gabinete de pared
 CN 小墙柜

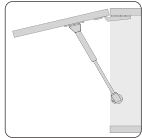

YATO 
 YT-08935



EN Shelf
 PL Półka
 DE Regal
 RU Полка
 CZ Pólicka
 HU Polc
 RO Raft
 FR Étagère
 IT Scaffale
 ES Estante
 CN 层板



For YT-08931, YT-08934
 Dla YT-08931, YT-08934

YATO 
 YT-08932



EN Worktop
 PL Blat roboczy
 DE Werkstatt Tischplatte
 RU Столешница для мастерской
 CZ Pracovní deska
 HU Munkalap
 RO Blat de lucru
 FR Plan de travail
 IT Piano di lavoro
 ES Encimera
 CN 木质工作台面



YATO 
 YT-08938



EN Worktop
 PL Blat roboczy
 DE Werkstatt Tischplatte
 RU Столешница для мастерской
 CZ Pracovní deska
 HU Munkalap
 RO Blat de lucru
 FR Plan de travail
 IT Piano di lavoro
 ES Encimera
 CN 木质工作台面



YATO 
 YT-08939



EN Strengthening element
 PL Wzmocnienie blatu
 DE Verstärkungselement
 RU Укрепление столешницы
 CZ Podpůrný prvek
 HU Asztali támogató
 RO Ranforsare pt. blat de lucru
 FR Support de table
 IT Rinforzo del piano di lavoro
 ES Soporte de mesa
 CN 工作台面挂板



For YT-08939
 Dla YT-08939

YATO 
 YT-08940



EN Hook panel
 PL Panel perforowany
 DE Perforierte Wand
 RU Стенка с перфорацией
 CZ Děrovaná stěna
 HU Perforált fal
 RO Perete perforat
 FR Mur perforé
 IT Pannello forato
 ES Pared perforada
 CN 网孔板



YATO 
 YT-08936



EN Hook panel support
PL Stelaż do paneli perforowanych
DE Verstärkungselement Perforierte Wand
RU Каркас для стенки с перфорацией
CZ Podpůrný prvek děrovaná stěna
HU Asztali támogatás perforált fal
RO Cadru de metal
FR Panneaux muraux perforés pour le soutien
IT Telaio per pannelli forati
ES Paneles de pared perforados de soporte
CN 工具柜



EN Hook panel support
PL Stelaż do paneli perforowanych
DE Verstärkungselement Perforierte Wand
RU Каркас для стенки с перфорацией
CZ Podpůrný prvek děrovaná stěna
HU Asztali támogatás perforált fal
RO Cadru de metal
FR Panneaux muraux perforés pour le soutien
IT Telaio per pannelli forati
ES Paneles de pared perforados de soporte
CN 工具柜



For YT-08936 x 3
Dla YT-08936 x 3

YATO	
YT-08941	1



For YT-08936 x 2
Dla YT-08936 x 2

YATO	
YT-08942	1

EN Power tool holder
PL Półka na elektronarzędzia
DE Elektrowerkzeug-Aufbewahrungshalterung
RU Полка для шуруповертов
CZ Držák závěsný na elektrické nářadí
HU Elektromos szerszámtartó
RO Suport scule electrice
FR Support pour outils électriques
IT Mensola porta elettrotrattensili
ES Estante para herramientas eléctricas
CN 电动工具架



YATO	Socket quantity / Liczba kieszeni	
YT-09091	6	10

EN Power tool organizer
PL Półka na elektronarzędzia
DE Elektrowerkzeug-Aufbewahrungsregal
RU Полка для электроинструмента
CZ Závěsný organizér na elektrické nářadí
HU Elektromos szerszámtartó polc

RO Organizator pt. scule electrice
FR Support pour outils électriques
IT Mensola porta elettrotrattensili
ES Estante para herramientas eléctricas
CN 电动工具架

465x405
x225
mm



YATO	Tray quantity / Liczba półek	Socket quantity / Liczba kieszeni	
YT-09092	2	4	1

EN Power tool cabinet
PL Szafka na elektronarzędzia
DE Elektrowerkzeug-Wandschrank
RU Шкаф настенный для электроинструмента
CZ Skříňka na elektrické nářadí
HU Elektromos szerszámtartó szekrény

RO Dulap pt. scule electrice
FR Armoire pour outils électriques
IT Armadietto per elettrotrattensili
ES Armario para herramientas eléctricas
CN 电动工具柜

480x430
x280
mm



YATO	Socket quantity / Liczba kieszeni	
YT-09093	4	1

EN Service tool cabinet with tools
 PL Szafka serwisowa z narzędziami
 DE Werkstattwagen mit Werkzeug
 RU Сервисная тележка с инструментами
 CZ Vozík servisní s nářadím
 HU Szerszámköcsi szerszámokkal

RO Dulap echipat cu scule
 FR Servante d'atelier complète
 IT Carrello porta attrezzi completo
 ES Carro taller con herramientas
 CN 维修工具柜

157
PCS

977x725
x480
mm

7x

BALL BEARINGS
ŁOŻYSKA
KULKOWE

15kg

CENTRAL LOCK
BLOKADA
CENTRALNA

OIL PROOF
STEEL WORKTOP
OLEJODOPRNY
STALOWY BLAT

3
TRAYS
TACE

EVA

∅120mm

2x
BRAKE
HAMULEC

UNIVERSAL PERFORATION
UNIVERSALNA
PERFORACJA

CORNER BUMPERS
NAROŻNE
ODBOJNIKI

2x

KEY

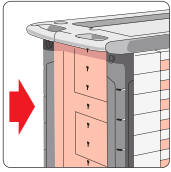

Drawer 1 / Szuflada 1

- 1/2" (12.7 mm): 8, 9, 10, 11, 12, 13, 14, 15, 16, 17, 18, 19, 20, 21, 22, 24 (L=38 mm); 27, 30, 32 mm (L=42 mm), 1/4" (6.3 mm): 4, 4.5, 5, 5.5, 6, 7, 8, 9, 10, 11, 12, 13 (L=25 mm); CrV 50BV30;
- 1/2" (12.7 mm): 10, 13, 14, 15, 17, 19, 21 mm (L=76 mm), 1/4" (6.3 mm): 6, 7, 8, 9, 10, 11, 12, 13 (L=50 mm); CrV 50BV30;
- 1/2" (12.7 mm): E10, E11, E12, E14, E16, 1/4" (6.3 mm): E4, E5, E6, E7, E8; CrV 50BV30;
- 1/2" (12.7 mm): (127, 254 mm), 1/4" (6.3 mm): (50.8, 101.6 mm); CrV 50BV30;
- 1/2" (12.7 mm); CrV 50BV30;
- 1/2" (12.7 mm): 16, 21 mm; CrV 50BV30;
- 1/2" (12.7 mm); (255 mm), 1/4" (6.3 mm); (152.4 mm); CrV 50BV30;
- 1/2" (12.7 mm); (255 mm), 1/4" (6.3 mm); (155 mm); CrV 6140;
- 1/4" (6.3 mm); (150 mm); CrV 50BV30;
- 1/4" (6.3 mm): 4, 5.5, 6.5 mm; AISI S2 / CrV 6150;
- 1/4" (6.3 mm): PH1 (x2), PH2 (x2), PH3; AISI S2 / CrV 6150;
- 1/4" (6.3 mm): PZ1, PZ2, PZ3; AISI S2 / CrV 6150;
- 1/4" (6.3 mm): T8, T10, T15, T20, T25, T30, T40; AISI S2 / CrV 6150;
- 1/4" (6.3 mm): 3, 4, 5, 6, 7, 8 mm; AISI S2 / CrV 6150

Drawer 2 / Szuflada 2

- ∅ 3-6 mm (L=52 mm), ∅ 6-8 (L=58 mm), ∅ 8-11 (L=66 mm), ∅ 11-14 (L=75 mm), ∅ 14-18 (L=80 mm), ∅ 18-25 (L=88 mm);
- 8, 9, 10, 11, 12, 13, 14, 15, 16, 17, 18, 19, 21, 22, 24 mm; CrV;
- 200 mm; CrV;
- T10, T15, T20, T25, T27, T30, T40, T45, T50; CrV 6150;
- 2, 2.5, 3, 4, 5, 6, 7, 8, 10, 12 mm; CrV 6150

Drawer 3 / Szuflada 3

- 6x100 mm; CrV 6150; PH2x100 mm; CrV 6150;
- 6x38, 3x75 mm; S2; PH0x75, PH2x38 mm; S2;
- 180 mm; CrV 50;
- 160 mm; CrV 50;
- 160 mm; CrV 6150;
- 150 mm;
- 180 mm; CrMo;
- 180 mm; CrV 50;
- 180 mm; CrV 50;
- 180 mm; CrV 50;
- 180 mm; CrV 50;
- 1.5, 2, 2.5, 3, 4, 5, 6, 8, 10 mm; CrV 6150



YATO
YT-55308

Drawer quantity / Liczba szuflad

7



1

EN Service tool cabinet with tools
PL Szafka serwisowa z narzędziami
DE Werkstattwagen mit Werkzeug
RU Сервисная тележка с инструментами
CZ Vozík servisní s nářadím
HU Szerszámkocsi szerszámokkal

RO Dulap echipat cu scule
FR Servante d'atelier complète
IT Carrello porta attrezzi completo
ES Carro taller con herramientas
CN 维修工具柜

165
PCS

958x766
x465
mm

7x

BALL BEARINGS
ŁOŻYSKA
KULKOWE

DRAWERS
LOCKING
BLOKADA
SZUFLAD

CENTRAL
LOCK
BLOKADA
CENTRALNA

NON SLIP
WORKTOP
BLAT ANTY-
POŚLIZGOWY

∅125mm

BRAKE
HAMULEC

UNIVERSAL PERFORATION
UNIWERSALNA
PERFORACJA

DOUBLE WALLS
PODWOJNE
SCIANY

CORNER BUMPERS
NARÓZNE
ODBOJNIKI

3x

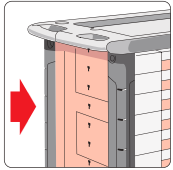

Drawer 1 / Szufłada 1

- 1/2" (12.7 mm), 3/8" (9.5 mm);
- T20, T25, T30, T40, T45, T50, T55 (L=30 mm);
- T20, T25, T30, T40, T45, T50, T55 (L=75 mm); AISI S2;
- 4, 5, 6, 7, 8, 10, 12 mm (L=30 mm); 4, 5, 6, 7, 8, 10, 12 mm (L=75 mm); AISI S2;
- M5, M6, M8, M10, M12 (L=30 mm); M5, M6, M8, M10, M12 (L=75 mm); AISI S2;
- 6, 7, 8, 9, 10, 11, 12, 13, 14, 15, 16, 17, 18, 19, 20, 21 mm; CrV;
- 22, 24, 27, 28, 30, 32 mm; CrV

Drawer 2 / Szufłada 2

- 1/2" (12.7 mm): 10, 11, 12, 13, 14, 15, 16, 17, 18, 19, 20, 21, 22, 23, 24, 27, 30, 32 mm; CrV 50BV30;
- 1/2" (12.7 mm); (127 mm); CrV 50BV30;
- 1/2" (12.7 mm); CrV 50BV30;
- 1/2" (12.7 mm): 16; 21 mm; CrV 50BV30;
- 1/2" (12.7 mm); (255 mm); CrV 50BV30;
- 1/2" (12.7 mm); (255 mm); 72T; CrV 6140;
- 1/4" (6.3 mm): 3.5, 4, 4.5, 5, 5.5, 6, 7, 8, 9, 10, 11, 12, 13, 14 mm; CrV 50BV30;
- 1/4" (6.3 mm): 8, 10, 11, 12, 13 mm; CrV 50BV30;
- 1/4" (6.3 mm); (50.8, 101.6 mm); CrV 6140;
- 1/4" (6.3 mm); CrV 50BV30;
- 1/4" (6.3 mm); (152.4 mm); CrV 50BV30;
- 1/4" (6.3 mm); (155 mm); 72T; CrV 6140;
- 1/4" (6.3 mm); (150 mm); CrV 50BV30;
- 180 mm;
- 160 mm;
- 160 mm long nose;
- 160 mm bent nose

Drawer 3 / Szufłada 3

- 3x75, 5x100, 5x150, 6x38, 6x100, 6x150, 8x150 mm; CrMo;
- PH0x100, PH1x75, PH1x100, PH2x38, PH2x100, PH2x150, PH3x150 mm; CrMo;
- 180, 250 mm;
- 280 mm

Drawer 4 / Szufłada 4

- 3/4" (19.0 mm): 21, 22, 24, 27, 28, 29, 30, 32, 34, 36, 41, 46, 50, 55 mm; CrV 50BV30;
- 3/4" (19.0 mm); (200 mm); CrV 6140;
- 3/4" (19.0 mm); CrV 50BV30;
- 3/4" (19.0 mm); (500 mm); 72T; CrV 6140;
- 3/4" (19.0 mm); (500 mm); CrV 50BV30

Drawer 5 / Szufłada 5

- 1/2" (12.7 mm) x 5/16" (7.9 mm);
- 8 mm (L=35 mm); 8 mm (L=75 mm);
- PH3 (L=35 mm); PH1, PH2, PH3 (L=75 mm);
- 12-38 mm;
- 3" (75 mm);
- 82 mm;
- 200 mm;
- 135 mm;
- 300, 400, 500 mm

13 interchangeable trays with YATO tools
13 wymiennych modułów z narzędziami YATO



YATO	Drawer quantity / Liczba szuflad	
YT-55293	7	1

EN Service tool cabinet with tools
 PL Szafka serwisowa z narzędziami
 DE Werkstattwagen mit Werkzeug
 RU Сервисная тележка с инструментами
 CZ Vozík servisní s nářadím
 HU Szerszámköcsi szerszámokkal

RO Dulap echipat cu scule
 FR Servante d'atelier complète
 IT Carrello porta attrezzi completo
 ES Carro taller con herramientas
 CN 维修工具柜

177 PCS	970x770 x470 mm	6x	BALL BEARINGS ŁOŻYSKA KULKOWE	DRAWERS LOCKING BLOKADA SZUFLAD	NON SLIP WORKTOP BLAT ANTY- POŚLIZGOWY
∅125mm	BRAKE HAMULEC	UNIVERSAL PERFORATION UNIWERSALNA PERFORACJA	DOUBLE WALLS PODWÓJNE ŚCIANY	CORNER BUMPERS NAROZNE ODBOJNIKI	2x

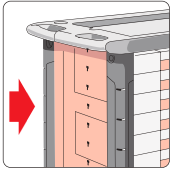

Drawer 1 / Szuflada 1

- 6, 7, 8, 9, 10, 11, 12, 13, 14, 15, 16, 17, 18, 19, 20, 21 mm; CrV;
- 22, 24, 27, 28, 30, 32 mm; CrV;
- 6x7, 8x9, 10x11, 12x13, 14x15, 16x17, 18x19 mm; CrV

Drawer 2 / Szuflada 2

- 3x75, 5x100, 5x150, 6x38, 6x100, 6x150, 8x150 mm; CrMo;
- PH0x100, PH1x75, PH1x100, PH2x38, PH2x100, PH2x150, PH3x150 mm; CrMo;
- 180 mm;
- 160 mm;
- 160 mm long nose;
- 160 mm bent nose

Drawer 3 / Szuflada 3

- 1/2" (12.7 mm): 10, 11, 12, 13, 14, 15, 16, 17, 18, 19, 20, 21, 22, 23, 24, 27, 30, 32 mm; CrV 50BV30;
- 1/2" (12.7 mm); (127 mm); CrV 50BV30;
- 1/2" (12.7 mm); CrV 50BV30;
- 1/2" (12.7 mm): 16; 21 mm; CrV 50BV30;
- 1/2" (12.7 mm); (255 mm); CrV 50BV30;
- 1/2" (12.7 mm); (255 mm); 72T; CrV 6140;
- T20, T25, T30, T40, T45, T50, T55 (L=30 mm); T20, T25, T30, T40, T45, T50, T55 (L=75 mm); AISI S2;
- 4, 5, 6, 7, 8, 10, 12 mm (L=30 mm); 4, 5, 6, 7, 8, 10, 12 mm (L=75 mm); AISI S2;
- M5, M6, M8, M10, M12 (L=30 mm); M5, M6, M8, M10, M12 (L=75 mm); AISI S2;
- 1/2" (12.7 mm), 3/8" (9.5 mm);
- 1/2" (12.7 mm): 8, 9, 10, 11, 12, 13, 14, 15, 16, 17, 18, 19, 20, 21 mm (L=76 mm); CrV 50BV30

Drawer 4 / Szuflada 4

- 300 g (L=300 mm);
- 40 mm (L=350 mm);
- 10x8x142 mm, 12x10x152 mm, 16x13x172 mm;
- 3/8" (9.5 mm): 6, 7, 8, 9, 10, 11, 12, 13, 14, 15, 16, 17, 18, 19, 20, 21, 22 mm; CrV 50BV30;
- 3/8" (9.5 mm): (76, 152.4 mm); CrV 50BV30;
- 3/8" (9.5 mm); CrV 50BV30;
- 3/8" (9.5 mm); (198 mm); CrV 50BV30;
- 3/8" (9.5 mm); (200 mm); 72T; CrV 6140;
- 1/4" (6.3 mm): 3.5, 4, 4.5, 5, 5.5, 6, 7, 8, 9, 10, 11, 12, 13, 14 mm; CrV 50BV30;
- 1/4" (6.3 mm): 8, 10, 11, 12, 13 mm; CrV 50BV30;
- 1/4" (6.3 mm); (50.8, 101.6 mm); CrV 6140;
- 1/4" (6.3 mm); CrV 50BV30;
- 1/4" (6.3 mm); (152.4 mm); CrV 50BV30
- 1/4" (6.3 mm); (155 mm); 72T; CrV 6140;
- 1/4" (6.3 mm); (150 mm); CrV 50BV30

12 interchangeable trays with YATO tools
 12 wymiennych modułów z narzędziami YATO



YATO	Drawer quantity / Liczba szuflad	
YT-5530	6	1

EN Service tool cabinet with tools
PL Szafka serwisowa z narzędziami
DE Werkstattwagen mit Werkzeug
RU Сервисная тележка с инструментами
CZ Vozík servisní s nářadím
HU Szerszámkocsi szerszámokkal

RO Dulap echipat cu scule
FR Servante d'atelier complète
IT Carrello porta attrezzi completo
ES Carro taller con herramientas
CN 维修工具柜

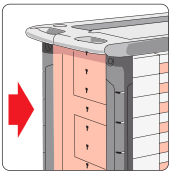

Drawer 1 / Szufiada 1

- 6, 7, 8, 9, 10, 11, 12, 13, 14, 15, 16, 17, 18, 19, 20, 21 mm; CrV;
- 22, 24, 27, 28, 30, 32 mm; CrV;
- 6x7, 8x9, 10x11, 12x13, 14x15, 16x17, 18x19 mm; CrV

Drawer 2 / Szufiada 2

- 3x75, 5x100, 5x150, 6x38, 6x100, 6x150, 8x150 mm; CrMo;
- PH0x100, PH1x75, PH1x100, PH2x38, PH2x100, PH2x150, PH3x150 mm; CrMo;
- 180 mm;
- 160 mm;
- 160 mm long nose;
- 160 mm bent nose

Drawer 3 / Szufiada 3

- 1/2" (12.7 mm): 10, 11, 12, 13, 14, 15, 16, 17, 18, 19, 20, 21, 22, 23, 24, 27, 30, 32 mm; CrV 50BV30;
- 1/2" (12.7 mm): (127 mm); CrV 50BV30;
- 1/2" (12.7 mm); CrV 50BV30;
- 1/2" (12.7 mm): 16, 21 mm; CrV 50BV30;
- 1/2" (12.7 mm); (255 mm); CrV 50BV30;
- 1/2" (12.7 mm); (255 mm); 72T; CrV 6140;
- T20, T25, T30, T40, T45, T50, T55 (L=30 mm); T20, T25, T30, T40, T45, T50, T55 (L=75 mm); AISI S2;
- 4, 5, 6, 7, 8, 10, 12 mm (L=30 mm); 4, 5, 6, 7, 8, 10, 12 mm (L=75 mm); AISI S2;
- M5, M6, M8, M10, M12 (L=30 mm); M5, M6, M8, M10, M12 (L=75 mm); AISI S2;
- 1/2" (12.7 mm), 3/8" (9.5 mm);
- 1/2" (12.7 mm): 8, 9, 10, 11, 12, 13, 14, 15, 16, 17, 18, 19, 20, 21 mm (L=76 mm); CrV 50BV30

Drawer 4 / Szufiada 4

- 300 g (L=300 mm);
- 40 mm (L=350 mm);
- 10x8x142 mm, 12x10x152 mm, 16x13x172 mm;
- 3/8" (9.5 mm): 6, 7, 8, 9, 10, 11, 12, 13, 14, 15, 16, 17, 18, 19, 20, 21, 22 mm; CrV 50BV30;
- 3/8" (9.5 mm); (76, 152.4 mm); CrV 50BV30;
- 3/8" (9.5 mm); CrV 50BV30;
- 3/8" (9.5 mm); (198 mm); CrV 50BV30;
- 3/8" (9.5 mm); (200 mm); 72T; CrV 6140;
- 1/4" (6.3 mm): 3.5, 4, 4.5, 5, 5.5, 6, 7, 8, 9, 10, 11, 12, 13, 14 mm; CrV 50BV30;
- 1/4" (6.3 mm): 8, 10, 11, 12, 13 mm; CrV 50BV30;
- 1/4" (6.3 mm); (50.8, 101.6 mm); CrV 6140;
- 1/4" (6.3 mm); CrV 50BV30;
- 1/4" (6.3 mm); (152.4 mm); CrV 50BV30;
- 1/4" (6.3 mm); (155 mm); 72T; CrV 6140;
- 1/4" (6.3 mm); (150 mm); CrV 50BV30

12 interchangeable trays with YATO tools
12 wymiennych modułów z narzędziami YATO



YATO	Drawer quantity / Liczba szuflad	
YT-55300	6	1

EN Service tool cabinet with tools
 PL Szafka serwisowa z narzędziami
 DE Werkstattwagen mit Werkzeug
 RU Сервисная тележка с инструментами
 CZ Vozík servisní s nářadím
 HU Szerszámkocsi szerszámokkal

RO Dulap echipat cu scule
 FR Servante d'atelier complète
 IT Carrello porta attrezzi completo
 ES Carro taller con herramientas
 CN 维修工具柜

185 PCS
970x770 x**470** mm
6x
 BALL BEARINGS
 ŁOŻYSKA KULKOWE
 DRAWERS LOCKING
 BLOKADA SZUFLAD
 NON SLIP WORKTOP
 BLAT ANTY-POŚLIZGOWY
 BRAKE HAMULEC
 UNIVERSAL PERFORATION
 UNIWERSALNA PERFORACJA
 DOUBLE WALLS
 PODWÓJNE ŚCIANY
 CORNER BUMPERS
 NARÓŻNE ODBOJNIKI
 ø125 mm
 2x

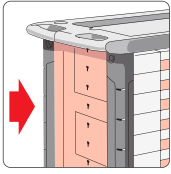

Drawer 1 / Szuflada 1

- 6, 7, 8, 9, 10, 11, 12, 13, 14, 15, 16, 17, 18, 19, 20, 21 mm; CrV;
- 22, 24, 27, 28, 30, 32 mm; CrV;
- 6x7, 8x9, 10x11, 12x13, 14x15, 16x17, 18x19 mm; CrV

Drawer 2 / Szuflada 2

- 3x75, 5x100, 5x150, 6x38, 6x100, 6x150, 8x150 mm; CrMo;
- PH0x100, PH1x75, PH1x100, PH2x38, PH2x100, PH2x150, PH3x150 mm; CrMo;
- 180 mm;
- 160 mm;
- 160 mm long nose;
- 160 mm bent nose

Drawer 3 / Szuflada 3

- 1/2" (12.7 mm): 10, 11, 12, 13, 14, 15, 16, 17, 18, 19, 20, 21, 22, 23, 24, 27, 30, 32 mm; CrV 50BV30;
- 1/2" (12.7 mm); (127 mm); CrV 50BV30;
- 1/2" (12.7 mm); CrV 50BV30;
- 1/2" (12.7 mm): 16, 21 mm; CrV 50BV30;
- 1/2" (12.7 mm); (255 mm); CrV 50BV30;
- 1/2" (12.7 mm); (255 mm); T2T; CrV 6140;
- T20, T25, T30, T40, T45, T50, T55 (L=30 mm); T20, T25, T30, T40, T45, T50, T55 (L=75 mm); AISI S2;
- 4, 5, 6, 7, 8, 10, 12 mm (L=30 mm); 4, 5, 6, 7, 8, 10, 12 mm (L=75 mm); AISI S2;
- M5, M6, M8, M10, M12 (L=30 mm); M5, M6, M8, M10, M12 (L=75 mm); AISI S2;
- 1/2" (12.7 mm), 3/8" (9.5 mm);
- 1/2" (12.7 mm): 8, 9, 10, 11, 12, 13, 14, 15, 16, 17, 18, 19, 20, 21 mm (L=76 mm); CrV 50BV30

Drawer 4 / Szuflada 4

- 300 g (L=300 mm);
- Ø 40 mm (L=350 mm);
- 10x8x142 mm, 12x10x152 mm, 16x13x170 mm;
- 1/4" (6.3 mm): 3.5, 4, 4.5, 5, 5.5, 6, 7, 8, 9, 10, 11, 12, 13, 14 mm; CrV 50BV30;
- 1/4" (6.3 mm): 8, 10, 11, 12, 13 mm; CrV 50BV30;
- 1/4" (6.3 mm); (50.8, 101.6 mm); CrV 6140;
- 1/4" (6.3 mm); CrV 50BV30;
- 1/4" (6.3 mm); (152.4 mm); CrV 50BV30;
- 1/4" (6.3 mm); (155 mm); T2T; CrV 6140;
- 1/4" (6.3 mm); (150 mm); CrV 50BV30;
- 1/2" (12.5 mm): E10, E12, E14, E16, E18, E20;
- 1/4" (6.3 mm): E4, E5, E6, E7, E8;
- 2, 2.5, 3, 4, 5, 6, 7, 8, 10, 12 mm;
- T10, T15, T20, T25, T27, T30, T40, T45, T50

12 interchangeable trays with YATO tools
 12 wymiennych modułów z narzędziami YATO



YATO	Drawer quantity / Liczba szuflad	
YT-55307	6	1

16

EN Service tool cabinet with tools
PL Szafka serwisowa z narzędziami
DE Werkstattwagen mit Werkzeug
RU Сервисная тележка с инструментами
CZ Vozík servisní s nářadím
HU Szerszámköcsi szerszámokkal

RO Dulap echipat cu scule
FR Servante d'atelier complète
IT Carrello porta attrezzi completo
ES Carro taller con herramientas
CN 维修工具柜

211
PCS

980x770
x465
mm

7x

BALL
BEARINGS
ŁOŻYSKA
KULKOWE

DRAWERS
LOCKING
BLOKADA
SZUFLAD

NON SLIP
WORKTOP
BLAT ANTI-
POŚLĘGOWY

DOUBLE
WALLS
PODWÓJNE
SCIANY

∅125mm

BRAKE
HAMULEC

UNIVERSAL
PERFORATION
UNIWERSALNA
PERFORACJA

CORNER
BUMPER
NARÓŻNE
ODBOJNIKI

3x

KEY
KŁÓC

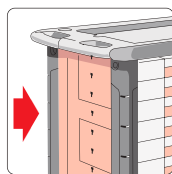

Drawer 1 / Szufłada 1

- 1/2" (12.7 mm): 8, 9, 10, 11, 12, 13, 14, 15, 16, 17, 18, 19, 20, 21, 22, 24 mm (L=38 mm); 27, 30, 32 mm (L=42 mm), 1/4" (6.3 mm): 4, 4.5, 5, 5.5, 6, 7, 8, 9, 10, 11, 12, 13 mm (L=25 mm); CrV 50BV30;
- 1/2" (12.7 mm): 10, 13, 14, 15, 17, 19, 21 mm (L=76 mm), 1/4" (6.3 mm): 6, 7, 8, 9, 10, 11, 12, 13 mm (L=50 mm); CrV 50BV30;
- 1/2" (12.7 mm): E10, E11, E12, E14, E16, 1/4" (6.3 mm): E4, E5, E6, E7, E8; CrV 50BV30;
- 1/2" (12.7 mm): (127, 254 mm), 1/4" (6.3 mm): (50.8, 101.6 mm); CrV 50BV30;
- 1/2" (12.7 mm): CrV 50BV30;
- 1/2" (12.7 mm): 16, 21 mm; CrV 50BV30;
- 1/2" (12.7 mm): (255 mm), 1/4" (6.3 mm): (152.4 mm); CrV 50BV30;
- 1/2" (12.7 mm): (255 mm), 1/4" (6.3 mm): (155 mm); CrV 6140;
- 1/4" (6.3 mm): (150 mm); CrV 50BV30;
- 1/4" (6.3 mm): 4, 5.5, 6.5 mm; AISI S2 / CrV 6150;
- 1/4" (6.3 mm): PH1 x2, PH2 x2, PH3; AISI S2 / CrV 6150;
- 1/4" (6.3 mm): PZ1, PZ2, PZ3; AISI S2 / CrV 6150;
- 1/4" (6.3 mm): T8, T10, T15, T20, T25, T30, T40; AISI S2 / CrV 6150;
- 1/4" (6.3 mm): 3, 4, 5, 6, 7, 8 mm; AISI S2 / CrV 6150

Drawer 2 / Szufłada 2

- 200 mm; CrV;
- ∅ 3-6 mm (L=52 mm), ∅ 6-8 mm (L=58 mm), ∅ 8-11 mm (L=66 mm), ∅ 11-14 mm (L=75 mm), ∅ 14-18 mm (L=80 mm), ∅ 18-25 mm (L=88 mm);
- 8, 9, 10, 11, 12, 13, 14, 15, 16, 17, 18, 19, 21, 22, 24 mm; CrV;
- T10, T15, T20, T25, T27, T30, T40, T45, T50; CrV 6150;
- 2, 2.5, 3, 4, 5, 6, 7, 8, 10, 12 mm; CrV 6150

Drawer 3 / Szufłada 3

- 6x38, 2x75, 3x75, 4x100, 5x100, 6x100 mm; PH0x100, PH1x100, PH2x38, PH2x150, PH3x150 mm;
- T7x75, T8x75, T9x75, T10x100, T15x100, T20x100, T25x100, T27x100 mm; S2;
- 6.0x150 mm; PH2x150 mm; CrV 6150

Drawer 4 / Szufłada 4

- 180 mm;
- 160 mm;
- 200 mm;
- 250 mm;
- 400 g;
- 340 g;
- 12.5x152, 16.0x172 mm; CrV 6150;
- 3x150, 4x150, 5x150, 6x150, 8x150 mm; CrV 6150;
- 8x112 mm; CrV 6150

Drawer 5 / Szufłada 5

- M3x0.5 x3, M4x0.7 x3, M5x0.8 x3, M6x1.0 x3, M7x1.0 x3, M8x1.25 x3, M10x1.5 x3, M12x1.75 x3; HSS M2;
- M3, M4x0.7, M5x0.8, M6x1.0, M7x1.0, M8x1.25, M10x1.5, M12x1.75; HSS M2;
- M7-M9;
- M3-M12;
- #2, 200 mm;
- #2, 200 mm;
- #2, 200 mm;
- LED;
- 3 m x 16 mm;
- 300 mm;
- 0-150 mm

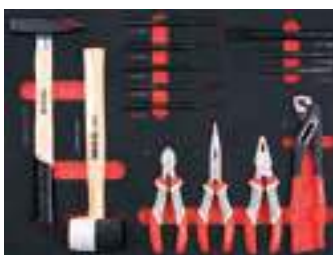

YATO	Drawer quantity / Liczba szuflad	
YT-55290	7	1

EN Tool chest
 PL Szafka warsztatowa
 DE Werkzeugkasten
 RU Тумба инструментальная
 CZ Dilenská skříňka na nářadí
 HU Szerszámok szekrény
 RO Dulap scule
 FR Caisse à outils
 IT Armadio con cassetti per officina
 ES Cajonera portátil
 CN 工具柜

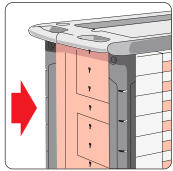
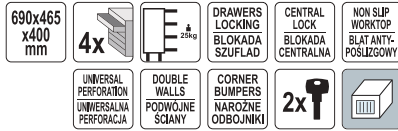

YATO Drawer quantity / Liczba szuflad
 YT-09152 4 1

EN Tool chest
 PL Szafka warsztatowa
 DE Werkzeugkasten
 RU Тумба инструментальная
 CZ Dilenská skříňka na nářadí
 HU Szerszámok szekrény
 RO Dulap scule
 FR Caisse à outils
 IT Armadio con cassetti per officina
 ES Cajonera portátil
 CN 工具柜

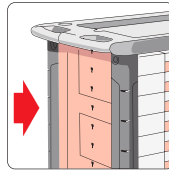

YATO Drawer quantity / Liczba szuflad
 YT-09155 6 1

EN Roller cabinet
 PL Szafka serwisowa
 DE Werkstattrollwagen
 RU Инструментальная тележка
 CZ Vozík servisní na nářadí
 HU Szerszámok kocsi
 RO Dulap de scule
 FR Servante d'atelier
 IT Carrello porta attrezzi
 ES Carro para herramientas
 CN 工具车

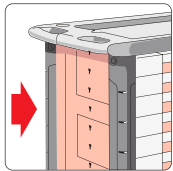

YATO Drawer quantity / Liczba szuflad
 YT-09002 6+1 1

EN Roller cabinet
 PL Szafka serwisowa
 DE Werkstattrollwagen
 RU Инструментальная тележка
 CZ Vozík servisní na nářadí
 HU Szerszámok kocsi
 RO Dulap de scule
 FR Servante d'atelier
 IT Carrello porta attrezzi
 ES Carro para herramientas
 CN 工具车

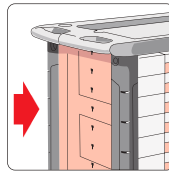
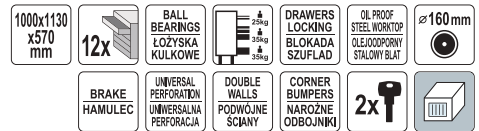

YATO Drawer quantity / Liczba szuflad
 YT-09003 12 1

EN Roller cabinet
 PL Szafka serwisowa
 DE Werkstattrollwagen
 RU Инструментальная тележка
 CZ Vozík servisní na nářadí
 HU Szerszámok kocsi
 RO Dulap de scule
 FR Servante d'atelier
 IT Carrello porta attrezzi
 ES Carro para herramientas
 CN 工具车

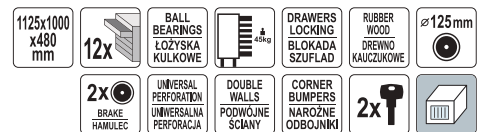

YATO Drawer quantity / Liczba szuflad
 YT-09005 12 1

EN Roller cabinet
PL Szafka serwisowa
DE Werkstattrollwagen
RU Инструментальная тележка
CZ Vozík servisní na nářadí
HU Szerszámok kocsi
RO Dulap de scule
FR Servante d'atelier
IT Carrello porta attrezzi
ES Carro para herramientas
CN 工具车



YATO	Drawer quantity / Liczba szuflad	1
YT-09004	7	1

EN Roller cabinet
PL Szafka serwisowa
DE Werkstattrollwagen
RU Инструментальная тележка
CZ Vozík servisní na nářadí
HU Szerszámok kocsi
RO Dulap de scule
FR Servante d'atelier
IT Carrello porta attrezzi
ES Carro para herramientas
CN 工具车



YATO	Drawer quantity / Liczba szuflad	1
YT-09032	7+1	1

EN Roller cabinet
PL Szafka serwisowa
DE Werkstattrollwagen
RU Инструментальная тележка
CZ Vozík servisní na nářadí
HU Szerszámok kocsi
RO Dulap de scule
FR Servante d'atelier
IT Carrello porta attrezzi
ES Carro para herramientas
CN 工具车



YATO	Drawer quantity / Liczba szuflad	1
YT-09032	7	1

EN Roller cabinet
PL Szafka serwisowa
DE Werkstattrollwagen
RU Инструментальная тележка
CZ Vozík servisní na nářadí
HU Szerszámok kocsi
RO Dulap de scule
FR Servante d'atelier
IT Carrello porta attrezzi
ES Carro para herramientas
CN 工具车



YATO	Drawer quantity / Liczba szuflad	1
YT-0913	6	1

EN Roller cabinet
 PL Szafka serwisowa
 DE Werkstattrollwagen
 RU Инструментальная тележка
 CZ Vozík servisní na nářadí
 HU Szerszámos kocsi
 RO Dulap de scule
 FR Servante d'atelier
 IT Carrello porta attrezzi
 ES Carro para herramientas
 CN 工具车

995x680 x458 mm	7x	BALL BEARINGS ŁOŻYSKA KULKOWE	max 300kg	DRAWERS LOCKING BLOKADA SZUFLAD
CENTRAL LOCK BLOKADA CENTRALNA	NON SLIP WORKTOP BLAT ANTY- POŚLIZGOWY	∅127mm	2x BRAKE HAMULEC	2x



YATO	Drawer quantity / Liczba szuflad	
YT-0914	7	1

EN Roller cabinet
 PL Szafka serwisowa
 DE Werkstattrollwagen
 RU Инструментальная тележка
 CZ Vozík servisní na nářadí
 HU Szerszámos kocsi
 RO Dulap de scule
 FR Servante d'atelier
 IT Carrello porta attrezzi
 ES Carro para herramientas
 CN 工具车

958x766 x465 mm	6x	BALL BEARINGS ŁOŻYSKA KULKOWE	max 250kg 250kg 350kg	DRAWERS LOCKING BLOKADA SZUFLAD
CENTRAL LOCK BLOKADA CENTRALNA	NON SLIP WORKTOP BLAT ANTY- POŚLIZGOWY	∅125mm	2x BRAKE HAMULEC	2x



YATO	Drawer quantity / Liczba szuflad	
YT-0902	6	1

EN Roller cabinet
 PL Szafka serwisowa
 DE Werkstattrollwagen
 RU Инструментальная тележка
 CZ Vozík servisní na nářadí
 HU Szerszámos kocsi
 RO Dulap de scule
 FR Servante d'atelier
 IT Carrello porta attrezzi
 ES Carro para herramientas
 CN 工具车

975x765 x465 mm	6x	BALL BEARINGS ŁOŻYSKA KULKOWE	max 250kg 250kg 350kg	DRAWERS LOCKING BLOKADA SZUFLAD
CENTRAL LOCK BLOKADA CENTRALNA	NON SLIP WORKTOP BLAT ANTY- POŚLIZGOWY	∅125mm	2x BRAKE HAMULEC	2x



YATO	Drawer quantity / Liczba szuflad	
YT-55299	6	1

EN Roller cabinet
 PL Szafka serwisowa
 DE Werkstattrollwagen
 RU Инструментальная тележка
 CZ Vozík servisní na nářadí
 HU Szerszámos kocsi
 RO Dulap de scule
 FR Servante d'atelier
 IT Carrello porta attrezzi
 ES Carro para herramientas
 CN 工具车

944x665 x453 mm	7x	BALL BEARINGS ŁOŻYSKA KULKOWE	max 250kg 250kg 350kg	DRAWERS LOCKING BLOKADA SZUFLAD
CENTRAL LOCK BLOKADA CENTRALNA	NON SLIP WORKTOP BLAT ANTY- POŚLIZGOWY	∅111mm	2x BRAKE HAMULEC	2x



YATO	Drawer quantity / Liczba szuflad	
YT-09000	7	1

EN Workshop trolley
PL Wózek warsztatowy
DE Werkstatt-Servicewagen
RU Инструментальная тележка
CZ Dílenský policový vozík
HU Műhelykocsi
RO Cărucior pt. atelier
FR Chariot d'atelier
IT Carrello da officina
ES Carro para taller
CN 三层工具车



YATO Tray quantity / Liczba pólek
YT-55210 3 1

EN Shutter cabinet
PL Szafka wisząca
DE Werkstatt-Hängeschrank
RU Шкаф настенный для инструмента
CZ Závěsná skříňka
HU Szerszámtároló
RO Raft pt. scule
FR Placard d'atelier
IT Scaffale
ES Armario colgante
CN 卷帘橱



YATO Dimensions / Wymiary [mm]
YT-09061 1500x605x185 1

EN Drawer insert / Combination spanners
PL Wkład do szuflady / Klucze płasko-oczkowe
DE Schubladeneinlage / Schrauben- und Ringschlüssel
RU Ложемент для выдвижного ящика / Комбинированные ключи
CZ Vložka do zásuvky / Klíče ploché-očkové
HU Fiókbetét / Csillag - villás kulcsok
RO Modul dulap scule / Chei combinate
FR Module pour servante avec clés mixtes
IT Modulo portautensili / Chiavi
ES Módulo de herramientas / Llave española de muletila
CN 两用扳手托盘组套



22, 24, 27, 28, 30, 32 mm; CrV

YATO
YT-5532 4

EN Workshop trolley
PL Wózek warsztatowy
DE Werkstatt-Servicewagen
RU Инструментальная тележка
CZ Dílenský policový vozík
HU Műhelykocsi
RO Cărucior pt. atelier
FR Chariot d'atelier
IT Carrello da officina
ES Carro para taller
CN 三层工具车



YATO Tray quantity / Liczba pólek
YT-55212 3 1

EN Workbench
PL Stół warsztatowy
DE Werkbank
RU Бестак
CZ Pracovní stůl
HU Munkapad
RO Banc de lucru
FR Table d'atelier
IT Banco da lavoro
ES Banco de trabajo
CN 工作台



YATO Dimensions / Wymiary [mm]
YT-08920 1500x780x830 1

EN Drawer insert / Bi-hexagonal ring spanner
PL Wkład do szuflady / Klucze oczkowe odgięte
DE Schubladeneinlage / Doppelringschlüssel
RU Ложемент для выдвижного ящика / Ключи накидные изогнутые
CZ Vložka do zásuvky / Klíče očkové ohnuté
HU Fiókbetét / Hajlítottszerű csillagkulcs
RO Modul dulap scule / Chei inelare
FR Module pour servante / Clés contre-coudées
IT Modulo portautensili / Chiavi
ES Módulo de herramientas / Llave de estrella
CN 双头高颈梅花扳手托盘组套



21x23, 24x27, 25x28, 30x32 mm; CrV

YATO
YT-5543 8

EN Drawer insert / Combination spanners
 PL Wkład do szuflady / Klucze płasko-oczkowe
 DE Schubladeneinlage / Schrauben- und Ringschlüssel
 RU Ложемент для выдвижного ящика / Комбинированные ключи
 CZ Vložka do zásuvky / Klíče ploché-očkové
 HU Fiókbetét / Csillag - villás kulcsok
 RO Modul dulap scule / Chei combinate
 FR Module pour servante avec clés mixtes
 IT Modulo portautensili / Chiavi
 ES Módulo de herramientas / Llave española de muletilla
 CN 两用扳手托盘组套

16 PCS CrV



6, 7, 8, 9, 10, 11, 12, 13, 14, 15, 16, 17, 18, 19, 20, 21 mm; CrV

YATO
 YT-5531 8

EN Drawer insert / L-type socket wrench
 PL Wkład do szuflady / Klucz nasadowy typ „L”
 DE Schubladeneinlage / Steckschlüssel gebogen
 RU Ложемент для выдвижного ящика / Ключи торцевые L-типа
 CZ Vložka do zásuvky / Nástrčný klíč fajtkový
 HU Fiókbetét / Kulcs, dugó-pipa
 RO Adaos la sertar / Cheie tubulara cu cot tip „L”
 FR Module pour servante / Clés a douille de type „L”
 IT Modulo portautensili / Chiave a tubo tipo „L”
 ES Módulo de herramientas / Llave de vaso „L”
 CN 套筒托盘工具组套

10 PCS CrV



7, 8, 9, 10, 11, 12, 13, 14, 17, 19 mm; CrV

YATO
 YT-55456 4

EN Drawer insert / Pliers
 PL Wkład do szuflady / Szczypce
 DE Schubladeneinlage / Zangen
 RU Ложемент для выдвижного ящика / Клещи
 CZ Vložka do zásuvky / Kleště
 HU Fiókbetét / Zégerfogó készlet
 RO Modul dulap scule / Clești
 FR Module pour servante avec pinces
 IT Modulo portautensili / Pinze
 ES Módulo de herramientas / Pinzas
 CN 卡簧钳托盘组套

4 PCS CrV



180 mm; external straight; CrV;
 180 mm; internal straight; CrV;
 180 mm; external bent; CrV;
 180 mm; internal bent; CrV

YATO
 YT-55443 8

EN Drawer insert / Pliers
 PL Wkład do szuflady / Szczypce
 DE Schubladeneinlage / Zangen
 RU Ложемент для выдвижного ящика / Клещи
 CZ Vložka do zásuvky / Kleště
 HU Fiókbetét / Fogók
 RO Modul dulap scule / Clești
 FR Module pour servante avec pinces
 IT Modulo portautensili / Pinze
 ES Módulo de herramientas / Pinzas
 CN 大力钳托盘组套

3 PCS CrMo CrV



180, 250 mm; CrMo;
 280 mm; CrV

YATO
 YT-55472 8

EN Drawer insert / Bi-hexagonal ring spanner
 PL Wkład do szuflady / Klucze oczkowe odgięte
 DE Schubladeneinlage / Doppelringschlüssel
 RU Ложемент для выдвижного ящика / Ключи накидные изогнутые
 CZ Vložka do zásuvky / Klíče očkové ohnuté
 HU Fiókbetét / Hajlítottszerű csillagkulcs
 RO Modul dulap scule / Chei inelare
 FR Module pour servante / Clés contre-coudées
 IT Modulo portautensili / Chiavi
 ES Módulo de herramientas / Llave de estrella
 CN 双头高颈梅花扳手托盘组套

7 PCS CrV



6x7, 8x9, 10x11, 12x13, 14x15, 16x17, 18x19 mm; CrV

YATO
 YT-5533 8

EN Drawer insert / Pliers
 PL Wkład do szuflady / Szczypce
 DE Schubladeneinlage / Zangen
 RU Ложемент для выдвижного ящика / Клещи
 CZ Vložka do zásuvky / Kleště
 HU Fiókbetét / Fogó készlet
 RO Modul dulap scule / Clești
 FR Module pour servante avec pinces
 IT Modulo portautensili / Pinze
 ES Módulo de herramientas / Pinzas
 CN 钳子托盘组套

4 PCS CrV



180 mm; CrV;
 160 mm; CrV;
 160 mm long nose; CrV;
 160 mm bent nose; CrV

YATO
 YT-5534 8

EN Drawer insert / Pliers
 PL Wkład do szuflady / Szczypce
 DE Schubladeneinlage / Zangen
 RU Ложемент для выдвижного ящика / Клещи
 CZ Vložka do zásuvky / Kleště
 HU Fiókbetét / Fogók
 RO Modul dulap scule / Clești
 FR Module pour servante avec pinces
 IT Modulo portautensili / Pinze
 ES Módulo de herramientas / Pinzas
 CN 钳子托盘组套

3 PCS CrMo CrV



180 mm;
 250 mm; CrMo;
 250 mm; CrV

YATO
 YT-55463 8

EN Drawer insert / Pliers
 PL Wkład do szuflady / Szczypce
 DE Schubladeneinlage / Zangen
 RU Ложемент для выдвижного ящика / Клещи
 CZ Vložka do zásuvky / Kleště
 HU Fiókbetét / Fogók
 RO Modul dulap scule / Clești
 FR Module pour servante avec pinces
 IT Modulo portautensili / Pinze
 ES Módulo de herramientas / Pinzas
 CN 钳子托盘组套

3 PCS CrMo CrV



250 mm; CrV;
 125 mm; CrMo;
 300 mm; CrV

YATO
 YT-55473 8

EN Drawer insert / Tool set for plumbers
PL Wkład do szuflady / Zestaw narzędziowy dla hydraulików
DE Schubladeneinlage / Werkzeug-Set für Klempner
RU Вклад к выдвижному ящику / Набор инструментов для водопроводчик
CZ Vložka do zásuvky / Sada nářadí pro instalatér
HU Fiókbetét / Szerszámkészlet vízvezeték-szerelő
RO Modul dulap scule / Set de scule pt. instalator
FR Module plastique pour servante / Ensemble d'outils pour les plombier
IT Tenone per l'armadio / Tool set per idraulici
ES Accesorio de cajón / Conjunto de herramientas para fontanero
CN 管道工具组套

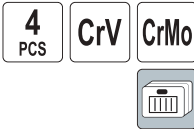

250 mm; CrV;
330 mm; CrV 6140;
250 mm; CrMo;
15 m x 19 mm; PTFE



YATO
YT-55480

5

EN Drawer insert / Tool set for plumbers
PL Wkład do szuflady / Zestaw narzędziowy dla hydraulików
DE Schubladeneinlage / Werkzeug-Set für Klempner
RU Вклад к выдвижному ящику / Набор инструментов для водопроводчик
CZ Vložka do zásuvky / Sada nářadí pro instalatér
HU Fiókbetét / Szerszámkészlet vízvezeték-szerelő
RO Modul dulap scule / Set de scule pt. instalator
FR Module plastique pour servante / Ensemble d'outils pour les plombier
IT Tenone per l'armadio / Tool set per idraulici
ES Accesorio de cajón / Conjunto de herramientas para fontanero
CN 管道工具组套

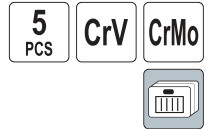

250 mm;
300 mm;
250 mm; CrV;
3-32 mm;
10 m x 12 mm; PTFE



YATO
YT-55481

5

EN Drawer insert / Pliers and adjustable wrenches
PL Wkład do szuflady / Szczypce i klucze nastawne
DE Schubladeneinlage / Zangen und rollgabelschlüssel
RU Ложемент для выдвижного ящика / Клещи и ключ разводной
CZ Vložka do zásuvky / Kleště, nastavitelný klíč
HU Fiókbetét / Fogók és állítható svédkulcs
RO Modul dulap scule / Clești și cheie reglabilă
FR Module pour servante / Pinces et clé a molette
IT Modulo portautensili / Pinze
ES Módulo de herramientas / Pinzas y llave ajustable
CN 活扳手及大力钳托盘组套



200, 250 mm;
250 mm; CrMo;
150 mm; CrMo



YATO
YT-55444

8

EN Drawer insert / Pliers
PL Wkład do szuflady / Szczypce
DE Schubladeneinlage / Zangen
RU Ложемент для выдвижного ящика / Клещи
CZ Vložka do zásuvky / Kleště
HU Fiókbetét / Fogók
RO Modul dulap scule / Clești
FR Module pour servante avec pinces
IT Modulo portautensili / Pinze
ES Módulo de herramientas / Pinzas
CN 绝缘钳子托盘组套



180 mm; 1000V; CrV;
160 mm; 1000V; CrV;
160 mm; 1000V; CrV;
175 mm; 1000V



YATO
YT-55464

8

EN Drawer insert / Slotted screwdrivers
PL Wkład do szuflady / Wkrętaki płaskie
DE Schubladeneinlage / Flachscharauer
RU Ложемент для выдвижного ящика / Плоские отвертки
CZ Vložka do zásuvky / Šroubováky ploché
HU Fiókbetét / Lapos csavarhúzó
RO Modul dulap scule / Șurubelnițe drepte
FR Module pour servante avec tournevis
IT Modulo portautensili / Set di cacciaviti piatti
ES Módulo de herramientas / Desarmadores planos
CN 一字螺丝批托盘组套



3x75, 5x100, 5x150, 6x38, 6x100, 6x150, 8x150 mm; CrMo

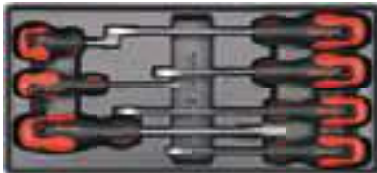

YATO
YT-5535

8

EN Drawer insert / Phillips screwdrivers
PL Wkład do szuflady / Wkrętaki krzyżakowe
DE Schubladeneinlage / Kreuzschlitzschrauber
RU Ложемент для выдвижного ящика / Крестовидные отвертки
CZ Vložka do zásuvky / Šroubováky křížové
HU Fiókbetét / Kereszt csavarhúzó
RO Adaos la sertar / Șurubelnițe în cruce
FR Module pour servante avec tournevis
IT Modulo portautensili / Set di cacciaviti a croce
ES Módulo de herramientas / Desarmadores de cruz
CN 十字螺丝批托盘组套



PH0x100, PH1x75, PH1x100, PH2x38, PH2x100, PH2x150, PH3x150 mm; CrMo



YATO
YT-5536

8

EN Drawer insert / Screwdriver set
PL Wkład do szuflady / Zestaw wkrętaków
DE Schubladeneinlage / Schraubendrehersatz
RU Ложемент для выдвижного ящика / Набор отвёрток
CZ Vložka do zásuvky / Sada šroubováků
HU Fiókbetét / Csavarhúzó készlet
RO Modul dulap scule / Set șurubelnițe
FR Module pour servante avec tournevis
IT Modulo portautensili / Set di cacciaviti
ES Módulo de herramientas / Juego de destornilladores
CN 螺丝批托盘组套



3x75, 5x75, 4x100, 6x100; PH0x75, PH1x75, PH2x100 mm; S2;
1.4x50, 2x50, 2.4x50 mm; PH00x50, PH0x50, PH1x50 mm; S2



YATO
YT-55455

8

EN Drawer insert / Go-through screwdrivers
PL Wkład do szuflady / Wkrętaki do pobijania
DE Schubladeneinlage / Schlag-Schraubendreher-Satz
RU Ложемент для выдвижного ящика / Ударные отвертки
CZ Vložka do zásuvky / Šroubováky s úderným koncem
HU Fiókbetét / Úthető csavarhúzó készlet
RO Modul dulap scule / Șurubelnițe mecanice
FR Module pour servante / Jeu de tournevis à frapper
IT Modulo portautensili / Set di cacciaviti a percussione
ES Módulo de herramientas / Destornilladores de golpe
CN 敲击螺丝批托盘组套



6x150, 8x200, PH2x150, PH3x200 mm; CrV



YATO
YT-55469

8

EN Drawer insert / Screwdriver set
 PL Wkład do szuflady / Zestaw wkrętek
 DE Schubladeneinlage / Schraubendreher-Set
 RU Ложемент для выдвижного ящика / Набор отверток
 CZ Vložka do zásuvky / Sada šroubováků
 HU Fiókbetét / Csavarhúzó készlet
 RO Modul dulap scule / Set șurubelnițe
 FR Module pour servante avec trousse
 IT Modulo portautensili / Set di cacciaviti
 ES Módulo de herramientas / Juego de destornilladores
 CN 螺丝批托盘组套

8 PCS S2



2.5x75, 4x100, 5.5x125, 6.5x150, PH1x80, PH2x100, PH3x150 mm; 1000V; S2;
 4x190 mm; 250V

YATO
 YT-55462 8

EN Drawer insert / Tool set
 PL Wkład do szuflady / Zestaw narzędziowy
 DE Schubladeneinlage / Werkzeug-Set
 RU Ложемент для выдвижного ящика / Набор инструмента
 CZ Vložka do zásuvky / Sada nářadí
 HU Fiókbetét / Szerszámkészlet
 RO Adoas la sertar / Trusa de scule
 FR Module pour servante / Coffret d'outillage
 IT Modulo portautensili / Set di utensili
 ES Módulo de herramientas / Juego de herramientas
 CN 套筒托盘工具组套

4 PCS CrV



3/4" (19.0 mm); (200 mm); CrV 6140;
 3/4" (19.0 mm); CrV 50BV30;
 3/4" (19.0 mm); (500 mm); CrV 50BV30;
 3/4" (19.0 mm); (500 mm); 72T; CrV 6140

YATO
 YT-55458 4

EN Drawer insert / Socket set
 PL Wkład do szuflady / Zestaw kluczy nasadowych
 DE Schubladeneinlage / Steckschlüsselsatz
 RU Ложемент для выдвижного ящика / Торцовые ключи
 CZ Vložka do zásuvky / Klíče nástrčné
 HU Fiókbetét / Dugókulcsok
 RO Modul dulap scule / Chei tubulare
 FR Module pour servante avec set d'outillages
 IT Modulo portautensili / Chiave a bussola
 ES Módulo de herramientas / Llaves de cubo
 CN 套筒托盘组套

22 PCS CrV



3/8" (9.5 mm); 6, 7, 8, 9, 10, 11, 12, 13, 14, 15, 16, 17, 18, 19, 20, 21, 22 mm; CrV 50BV30;
 3/8" (9.5 mm); (76, 152.4 mm); CrV 50BV30;
 3/8" (9.5 mm); CrV 50BV30;
 3/8" (9.5 mm); (198 mm); CrV 50BV30;
 3/8" (9.5 mm); (200 mm); 72T; CrV 6140

YATO
 YT-5542 8

EN Drawer insert / Socket set
 PL Wkład do szuflady / Zestaw kluczy nasadowych
 DE Schubladeneinlage / Steckschlüsselsatz
 RU Ложемент для выдвижного ящика / Торцовые ключи
 CZ Vložka do zásuvky / Klíče nástrčné
 HU Fiókbetét / Dugókulcsok
 RO Modul dulap scule / Chei tubulare
 FR Module pour servante avec set d'outillages
 IT Modulo portautensili / Chiave a bussola
 ES Módulo de herramientas / Llaves de cubo
 CN 套筒托盘组套

25 PCS CrV



1/4" (6.3 mm); 3.5, 4, 4.5, 5, 5.5, 6, 7, 8, 9, 10, 11, 12, 13, 14 mm; CrV 50BV30;
 1/4" (6.3 mm); 8, 10, 11, 12, 13 mm; CrV 50BV30;
 1/4" (6.3 mm); (50.8, 101.6 mm); CrV 6140;
 1/4" (6.3 mm); CrV 50BV30;
 1/4" (6.3 mm); (152.4 mm); CrV 50BV30;
 1/4" (6.3 mm); (155 mm); 72T; CrV 6140;
 1/4" (6.3 mm); (150 mm); CrV 50BV30

YATO
 YT-5541 8

EN Drawer insert / Socket set
 PL Wkład do szuflady / Zestaw kluczy nasadowych
 DE Schubladeneinlage / Steckschlüsselsatz
 RU Ложемент для выдвижного ящика / Торцовые ключи
 CZ Vložka do zásuvky / Klíče nástrčné
 HU Fiókbetét / Dugókulcsok
 RO Modul dulap scule / Chei tubulare
 FR Module pour servante avec set d'outillages
 IT Modulo portautensili / Chiave a bussola
 ES Módulo de herramientas / Llaves de cubo
 CN 套筒托盘组套

24 PCS CrV



1/2" (12.7 mm); 10, 11, 12, 13, 14, 15, 16, 17, 18, 19, 20, 21, 22, 23, 24, 27, 30, 32 mm; CrV 50BV30;
 1/2" (12.7 mm); (127 mm); CrV 50BV30;
 1/2" (12.7 mm); CrV 50BV30;
 1/2" (12.7 mm); 16; 21 mm; CrV 50BV30;
 1/2" (12.7 mm); (255 mm); CrV 50BV30;
 1/2" (12.7 mm); (255 mm); 72T; CrV 6140

YATO
 YT-5537 4

EN Drawer insert / Screwdriver bits
 PL Wkład do szuflady / Końcówki śrubokrętowe
 DE Schubladeneinlage / Endstücke für Schraubenzieher
 RU Ложемент для выдвижного ящика / Насадки для отверток
 CZ Vložka do zásuvky / Šroubovací nástavce
 HU Fiókbetét / Csavarhúzó bitek
 RO Modul dulap scule / Bit
 FR Module pour servante avec set d'embouts
 IT Modulo portautensili / Chiave punti di avvitamento
 ES Módulo de herramientas / Puntas para desarmadores
 CN 旋具头托盘组套

40 PCS S2



T20, T25, T30, T40, T45, T50, T55 (L=30 mm); T20, T25, T30, T40, T45, T50, T55 (L=75 mm); AISI S2;
 4, 5, 6, 7, 8, 10, 12 (L=30 mm); 4, 5, 6, 7, 8, 10, 12 (L=75 mm); AISI S2;
 M5, M6, M8, M10, M12 (L=30 mm); M5, M6, M8, M10, M12 (L=75 mm); AISI S2;
 1/2" (12.7 mm), 3/8" (9.5 mm)

YATO
 YT-5538 8

EN Drawer insert / Socket set
PL Wkład do szuflady / Zestaw kluczy nasadowych
DE Schubladeneinlage / Steckschlüsselsatz
RU Ложмент для выдвижного ящика / Торцовые ключи
CZ Vložka do zásuvky / Klíče nástrčné
HU Fiókbetét / Dugókulcsok
RO Modul dulap scule / Chei tubulare
FR Module pour servante avec set d'outillages
IT Modulo portautensili / Chiave a bussola
ES Módulo de herramientas / Llaves de cubo
CN 套筒托盘工具组套

14
PCS CrV
50BV30



3/4" (19.0 mm): 19, 21, 22, 24, 27, 28, 30, 32, 34, 36, 41, 46, 50, 55 mm; CrV 50BV30

YATO
YT-55457 4

EN Drawer insert / Deep sockets
PL Wkład do szuflady / Klucze nasadowe długie
DE Schubladeneinlage / Tiefe Steckschlüssel
RU Ложмент для выдвижного ящика / Торцовые глубокие ключи
CZ Vložka do zásuvky / Klíče nástrčné hluboké
HU Fiókbetét / Hosszú dugókulcsok
RO Modul dulap scule / Tubulare adânci
FR Module pour servante avec set de douilles
IT Modulo portautensili / Chiave a bussola lunghe
ES Módulo de herramientas / Llaves de cubo profundo
CN 六角长套筒托盘组套

14
PCS CrV
50BV30



1/2" (12.7 mm): 8, 9, 10, 11, 12, 13, 14, 15, 16, 17, 18, 19, 20, 21 mm (L=76 mm); CrV 50BV30

YATO
YT-5539 8

EN Drawer insert / Tool set
PL Wkład do szuflady / Zestaw narzędziowy
DE Schubladeneinlage / Werkzeug-Set
RU Ложмент для выдвижного ящика / Набор инструмента
CZ Vložka do zásuvky / Sada nářadí
HU Fiókbetét / Szerszámkészlet
RO Adaos la sertar / Trusa de scule
FR Module pour servante / Coffret d'outillage
IT Modulo portautensili / Set di utensili
ES Módulo de herramientas / Juego de herramientas
CN 旋具托盘组套

31
PCS CrV S2



1/2" (12.7 mm): E10, E12, E14, E16, E18, E20 (L=38 mm); CrV 50BV30;

1/2" (12.7 mm): 10 mm; CrV 6150;

M5, M6, M8, M10, M12 (L=30 mm); AISI S2;

2, 2.5, 3, 4, 5, 6, 7, 8, 10, 12 mm; CrV 6150;

T10, T15, T20, T25, T27, T30, T40, T45, T50; CrV 6150

YATO
YT-55451 8

EN Drawer insert / Hammers and chisels
PL Wkład do szuflady / Młotki i przecinaki
DE Schubladeneinlage / Hämmer und Meißel
RU Ложмент для выдвижного ящика / Молотки и зубила
CZ Vložka do zásuvky / Kladiva, díla a sekáče
HU Fiókbetét / Kalapácsok és hidegvágók
RO Adaos la sertar / Ciocane și dalți
FR Module pour servante avec marteaux et burins
IT Modulo portautensili / Martelli e scalpelli
ES Módulo de herramientas / Martillos y cinceles
CN 锤头凿子托盘组套

5
PCS CrV



300 g (L=300 mm);

40 mm (L=350 mm);

10x8x142 mm, 12x10x152 mm, 16x13x172 mm; CrV

YATO
YT-5540 8

EN Drawer insert / Measuring tools
PL Wkład do szuflady / Narzędzia miernicze
DE Schubladeneinlage / Messwerkzeuge
RU Ложмент для выдвижного ящика / Измерительные приборы
CZ Vložka do zásuvky / Měřeni
HU Fiókbetét / Mérésszűkűk
RO Adaos la sertar / Instrumente de măsură
FR Module pour servante / Outils de mesurage
IT Modulo portautensili / Strumenti di misura
ES Módulo de herramientas / Instrumentos de medición
CN 量具托盘组套

5
PCS AI SS



ABS



300 mm; AI;

0-150 mm; SS;

2 m;

3m x 16 mm; ABS;

0.02-1.00 mm

YATO
YT-55474 8

EN Drawer insert / Steel file set
PL Wkład do szuflady / Pilniki do metalu
DE Schubladeneinlage / Feilensatz
RU Ложмент для выдвижного ящика / Набор напильников
CZ Vložka do zásuvky / Pilníky na kov
HU Fiókbetét / LLakatos reszelő készlet
RO Adaos la sertar / Pile de lăcătușerie
FR Module pour servante / Jeu de limes à métal
IT Modulo portautensili / Set di lime per metallo
ES Módulo de herramientas / Juego de limas para metal
CN 锉刀托盘组套

5
PCS T12



#2, 200 mm; T12;

#2, 200 mm; T12;

#2, 200 mm; T12;

#2, 200 mm; T12;

#2, 200 mm; T12

YATO
YT-55453 8

EN Drawer insert / Hand riveter with rivets
 PL Wkład do szuflady / Nitownica ręczna z głowicą obrotową
 DE Schubladeneinlage / Blindnietzange
 RU Ложемент для выдвижного ящика / Ручной заклёпочник
 CZ Vložka do zásuvky / Ruční nýtovačka
 HU Fiókbetét / Kézi popszegecshűző
 RO Modul dulap scule / Clește pt. popnituri
 FR Module pour servante / Riveteuse a main
 IT Modulo portautensili / Rivettatrice manuale girevole
 ES Módulo de herramientas / Remachadora de mano
 CN 拉铆枪托盘组套



2.4, 3.2, 4.0, 4.8 mm; CrV;
 9.6x3.2, 9.6x4.0, 12.7x4.0, 9.6x4.8, 12.7x4.8 mm; Al

YATO YT-55466 8

EN Drawer insert / Automotive workshop tools
 PL Wkład do szuflady / Zestaw narzędzi warsztatowych
 DE Schubladeneinlage / Kfz-werkzeuge
 RU Ложемент для выдвижного ящика / Автомобильные инструменты
 CZ Vložka do zásuvky / Auto nářadí
 HU Fiókbetét / Autóipari szerszámok
 RO Modul dulap scule / Scule auto
 FR Module pour servante / Outils de réparation automobile
 IT Modulo portautensili / Set attrezzi officina
 ES Módulo de herramientas / Herramientas de automoción
 CN 轮胎修理工具托盘组套



200 mm;
 135 mm;
 300, 400, 500 mm; CrV

YATO YT-55477 4

EN Drawer insert / Tool set
 PL Wkład do szuflady / Zestaw narzędziowy
 DE Schubladeneinlage / Werkzeug-Set
 RU Ложемент для выдвижного ящика / Набор инструмента
 CZ Vložka do zásuvky / Sada nářadí
 HU Fiókbetét / Szerszámkészlet
 RO Adaos la sertar / Trusa de scule
 FR Module pour servante / Coffret d'outillage
 IT Modulo portautensili / Set di utensili
 ES Módulo de herramientas / Juego de herramientas
 CN 工具托盘组套



140 mm; SS;
 200 mm; 3Cr13;
 19 mm x 20 mm;
 4x190 mm; 250 V;
 1, 1.5, 2, 2.5, 3, 3.5, 4, 4.5, 5, 5.5, 6, 6.5, 7, 7.5, 8, 8.5, 9, 9.5, 10 mm; HSS 6542

YATO YT-55471 8

EN Drawer insert / Tool set
 PL Wkład do szuflady / Zestaw narzędziowy
 DE Schubladeneinlage / Werkzeug-Set
 RU Ложемент для выдвижного ящика / Набор инструмента
 CZ Vložka do zásuvky / Sada nářadí
 HU Fiókbetét / Szerszámkészlet
 RO Adaos la sertar / Trusa de scule
 FR Module pour servante / Coffret d'outillage
 IT Modulo portautensili / Set di utensili
 ES Módulo de herramientas / Juego de herramientas
 CN 工具托盘组套



1" (25 mm), L=330 mm; CrV;
 250 mm; CrMo;
 2.4, 3.2, 4.0, 4.8 mm;
 9.6x3.2, 9.6x4.0, 12.7x4.8 mm; Al

YATO YT-55478 8

EN Drawer insert / Automotive workshop tools
 PL Wkład do szuflady / Zestaw narzędzi warsztatowych
 DE Schubladeneinlage / Kfz-werkzeuge
 RU Ложемент для выдвижного ящика / Автомобильные инструменты
 CZ Vložka do zásuvky / Auto nářadí
 HU Fiókbetét / Autóipari szerszámok
 RO Modul dulap scule / Scule auto
 FR Module pour servante / Outils de réparation automobile
 IT Modulo portautensili / Set attrezzi officina
 ES Módulo de herramientas / Herramientas de automoción
 CN 轮胎修理工具托盘组套



1/2" (12.7 mm) x 5/16" (7.9 mm); CrV 6150;
 8 mm (L=35 mm); 8 mm (L=75 mm); CrV 6150;
 PH3 (L=35 mm); PH1, PH2, PH3 (L=75 mm); CrV 6150;
 12-38 mm; CrV 6150;
 3" (75 mm); CrV;
 82 mm; CrV

YATO YT-55476 4

EN Drawer insert / Taps and die set
 PL Wkład do szuflady / Zestaw narzynek i gwintowników
 DE Schubladeneinlage / Gewindeschneidwerkzeug-Satz
 RU Ложемент для выдвижного ящика / Набор плашек и метчиков
 CZ Vložka do zásuvky / Souprava závitníků a kruhových závitových čelistí
 HU Fiókbetét / Menetfűró és menetvágó készlet
 RO Modul dulap scule / Set de tarozi și filiere
 FR Module pour servante / Pince a riveter avec embouts
 IT Modulo portautensili / Set di filiera a maschi
 ES Módulo de herramientas / Juego de machos de rosca y cojinetes
 CN 丝锥板牙托盘组套



M3x0.5 x3, M4x0.7x3, M5x0.8 x3, M6x1.0 x3, M7x1.0 x3,
 M8x1.25, M10x1.5, M12x1.75; HSS M2;
 M3x0.5, M4x0.7, M5x0.8, M6x1.0, M7x1.0, M8x1.25, M10x1.5, M12x1.75; HSS M2;
 M7-M9;
 M3-M12;
 0.5 - 1.75 mm; 27G; 28G

YATO YT-55465 8

EN Drawer insert
PL Wkład do szuflady
DE Schubladeneinlage
RU Ложмент для выдвигающего ящика
CZ Vložka do zásuvky
HU Fiókbetét

RO Tavă pt. dulap scule
FR Module pour servante
IT Modulo portautensili
ES Módulo para carros de herramientas
CN 吸塑盒





For YT-5531
Dla YT-5531

YATO 	
YT-55311	5/30





For YT-5532
Dla YT-5532

YATO 	
YT-55321	5/30





For YT-5533
Dla YT-5533

YATO 	
YT-55331	5/30



For YT-5534
Dla YT-5534

YATO 	
YT-55341	5/30

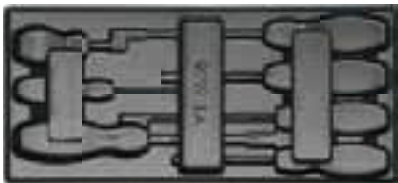

For YT-5535
Dla YT-5535

YATO 	
YT-55351	5/30

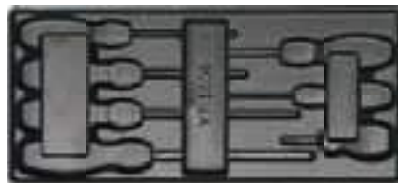

For YT-5536
Dla YT-5536

YATO 	
YT-55361	5/30





For YT-5537
Dla YT-5537

YATO 	
YT-55371	5/30





For YT-5538
Dla YT-5538

YATO 	
YT-55381	5/30





For YT-5539
Dla YT-5539

YATO 	
YT-55391	5/30



For YT-5540
Dla YT-5540

YATO 	
YT-55401	5/30

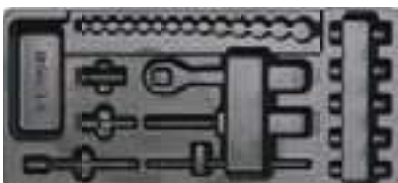



For YT-5541
Dla YT-5541

YATO 	
YT-55411	5/30



For YT-5542
Dla YT-5542

YATO 	
YT-55421	5/30



For YT-55454
Dla YT-55454

YATO 	
YT-55479	5/30

CREATE YOUR WORKPLACE - STWÓRZ SWOJE MIEJSCE PRACY



- EN** Legs for workbench, long
PL Nogi do stołu warsztatowego, długie
DE Beine für Werkbank, lange
RU Ножи для верстака, длинные
CZ Nohy k pracovnímu stolu, dlouhé
HU Lábak munkapadhoz
RO Picioare pt. banc de lucru, lungi
FR Jambes pour table d'atelier
IT Gambe del tavolo piedi del banco da lavoro
ES Patas para banco de trabajo, largas
CN 工作台长桌腿



2
PCS

140
cm

For YT-08920
 Dla YT-08920

YATO	L [mm]	
YT-08921	1400	2

- EN** Connection steel pipes set
PL Rury montażowe
DE Anschluss Stahlrohre Gesetzt
RU Стальная труба монтаж
CZ Ocelové trubky
HU Acélsövek
RO Kit montare dulap scule
FR Tuyaux en acier
IT Set di montaggio per tabella utensili
ES Tubos de acero
CN 高档工具柜定位杆



2
PCS

45
cm

∅ **28**
mm

For YT-09152, YT-09155 + YT-0902,
 YT-0903, YT-0904
 Dla YT-09152, YT-09155 + YT-0902,
 YT-0903, YT-0904

YATO	L [mm]	∅ [mm]	
YT-09071	450	28	20

- EN** Compartmented shelf and paper roll holder
PL Półka z uchwytem na papier
DE Werkstattwagenablage mit Papierrollehalter
RU Полка с держателем для бумаги
CZ Police s úchytem na papír
HU Kiegészítő polc és papírröplni tartó funkcióval
RO Compartiment pt. dulap si suport hartie
FR Support rouleau papier
IT Mensola portarotoli carta
ES Estante con sujetapapel
CN 托架



305x305
x145
mm

For YT-0902, YT-0903, YT-0904, YT-0905
 Dla YT-0902, YT-0903, YT-0904, YT-0905

YATO	Dimensions / Wymiary [mm]	
YT-0907	305x305x145	4

- EN** Dustbin
PL Pojemnik na odpady
DE Abfalleimer
RU Мусорный ящик
CZ Zásobník na odpad
HU Szemétkosár
RO Lada de gunoi
FR Poubelle
IT Contenitore di rifiuti
ES Cubo de basura
CN 废品箱



300x300
x190
mm

For YT-0902, YT-0903, YT-0904, YT-0905
 Dla YT-0902, YT-0903, YT-0904, YT-0905

YATO	Dimensions / Wymiary [mm]	
YT-0908	300x300x190	4

- EN** Holders for workshop box
PL Uchwyty do montażu szafki warsztatowej
DE Halterungen für die Montage eines Werkstattsschranks
RU Крепеж для рабочего шкафа
CZ Montážní držáky dílenské skřínky
HU Műhelyszekrény tartó
RO Suport pt. montarea dulap de scule
FR Porte-placard d'atelier
IT Staffa di montaggio per armadio portautensili
ES Elementos de fijación para instalación de cajón de taller
CN 高档工作台吊柜架



2
PCS

500x100
x350
mm

For YT-08920, YT-09152
 Dla YT-08920, YT-09152

YATO	Dimensions / Wymiary [mm]	
YT-08922	500x100x350	2

- EN** Double project center backwall
PL Tablica narzędziowa
DE Werkzeuggestafel
RU Доска для инструментов
CZ Deska na nářadí
HU Szerszámtartó panel
RO Panou perforat pt. scule
FR Panneau porte outils
IT Pannello porta utensili
ES Panel para herramientas
CN 高档工具车挂板

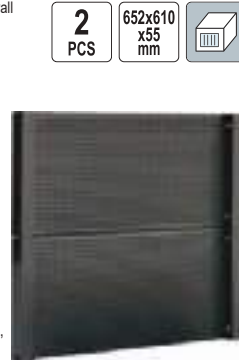

2
PCS

652x610
x55
mm

For YT-0902, YT-0903, YT-09031,
 YT-0904, YT-55290, YT-55292,
 YT-55293, YT-5530
 Dla YT-0902, YT-0903, YT-09031,
 YT-0904, YT-55290, YT-55292,
 YT-55293, YT-5530

YATO	Dimensions / Wymiary [mm]	
YT-09072	652x610x55	1

- EN** Separate board for drawer
PL Przegroda do szafki
DE Trennsteg für Werkstatt-Wagen-Schublade
RU Перегородки для ящика
CZ Pňíhrádka do police
HU Több rekeszes tálcá
RO Separatoare pt. sertar dulap scule
FR Cloison tiroir court
IT Separatore per armadio
ES Separador para armario
CN 抽屉分隔板



For YT-0902, YT-0903, YT-0904, YT-0905
 Dla YT-0902, YT-0903, YT-0904, YT-0905

YATO	Dimensions / Wymiary [mm]	
YT-0910	391x58x4	24
YT-0911	391x128x4	24

EN Magnetic towel holder
PL Magnetyczny uchwył na ręczniki
DE Magnetischer Rollenhalter
RU Магнитная вешалка для бумаги
CZ Držáků magnetických papírových ručníků
HU Mágneses papírtörő állvány

RO Suport magnetic pt. prosop hârtie
FR Porte-serviettes en papier magnétique
IT Portasciugamani magnetico
ES Magnético de papel toallero
CN 磁性纸巾挂架



YATO
YT-08680

24

EN Magnetic shelf
PL Półka magnetyczna
DE Magnetische Ablage
RU Магнитная полка для тележки
CZ Magnetický regál pro nářadí
HU Mágneses polc szerszámkocsikhoz

RO Cutie magnetice pt. depozitare
FR Magnétique plat
IT Mensola magnetica
ES Soporte de almacenamiento magnético
CN 磁性工具盒



YATO
YT-08681

10

EN Magnetic tool tray set
PL Zestaw półek magnetycznych
DE Magnetische Werkzeugablage Set

RU Набор магнитных полок для тележки
CZ Sada magnetických poliček
HU Mágneses polc készlet

RO Set tăvi magnetice
FR Magnétique étagères set
IT Set di ripiani magnetici

ES Juego de estantes magnéticos
CN 磁性工具盘

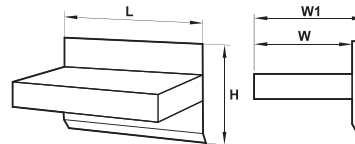

	L (mm)	H (mm)	W (mm)	W1 (mm)
	310	120	115	125
	270	120	115	125
	210	120	115	125
	155	120	115	125

YATO
YT-08682

6

EN Magnetic hooks set
PL Zestaw haczyków magnetycznych
DE Magnetische Haken Set
RU Набор магнитных крючков для тележки
CZ Sada magnetických háčků
HU Mágneses kampók halmaza

RO Set de cârlige magnetice
FR Ensemble de crochets magnétiques
IT Set di ganci magnetici
ES Conjunto de ganchos magnéticos
CN 磁性挂钩



YATO
YT-08690

12/48

EN Hook for panel
PL Haczyki do panelu perforowanego
DE Haken für perforierte Wände
RU Гачки для стенки с перфорацией
CZ Háčky pro stěnu s perforací
HU Horgok perforált panelhez

RO Cârlige pt. panouri perforate
FR Crochets pour le mur avec perforation
IT Ganci per pannelli forati
ES Ganchos para pared con perforación
CN 挂钩



For YT-08936
Dla YT-08936



YATO
YT-08937

20

EN Service utility key
PL Klucz do szafek serwisowych
DE Schaltschrank-Schlüssel für Gängige Schränke
RU Ключ для сервисных шкафов
CZ Klíč na rozvodné skříně
HU Kapcsolószekrény kulcs
RO Cheie universală pt. cămine utilități
FR Clés universelles pour armoires de commande
IT Chiave universale a croce per armadietti
ES Llaves para armarios de control
CN 多用阀门钥匙

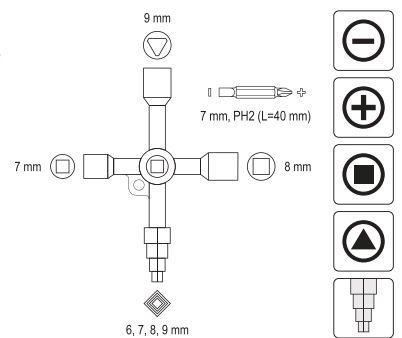



YATO
YT-66700



20/120



- | | | |
|--------------------------|----------------------|----------------------------|
| EN Tool box | CZ Skříňka na nářadí | IT Cassetta degli attrezzi |
| PL Skrzynka narzędziowa | HU Szerszámós láda | ES Caja de herramientas |
| DE Werkzeugkasten | RO Cutie de scule | CN 两抽屉工具组套 |
| RU Инструментальный ящик | FR Boîte à outils | |



YATO 	Drawer quantity / Liczba szuflad	
YT-09108	1	2

YATO 	Drawer quantity / Liczba szuflad	
YT-09107	2	2

- | | | |
|--------------------------------------|-------------------------------------|---|
| EN 3-module tool trolley | CZ Vozík na nářadí 3 sekce | IT Carrello portautensili con 3 scomparti |
| PL Wózek narzędziowy 3-częściowy | HU Kerekos szerszámósláda 3 részes | ES Carro de herramientas con 3 módulos |
| DE Werkzeugtrolley 3-teilig | RO Troler pt. scule cu 3 module | CN 拉杆式工具箱 |
| RU Тележка инструментальная 3 секции | FR Chariot porte-outils à 3 modules | |

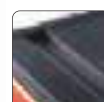

YATO 		
YT-09102	1	1

YATO 		
YT-09101	1	1

EN 3-module tool trolley with tools
PL Wózek narzędziowy 3-częściowy z narzędziami
DE Werkzeugtrolley 3-teilig mit Werkzeugen
RU Тележка с инструментами 3 секции
CZ Vozík na nářadí 3 sekce
HU Kerekesszerszámláda 3 részes
RO Troler scule cu 3 module
FR Chariot complet avec outils à 3 modules
IT Carrello portautensili con 3 moduli e strumenti
ES Carros con herramientas 3 módulos
CN 手推式工具箱







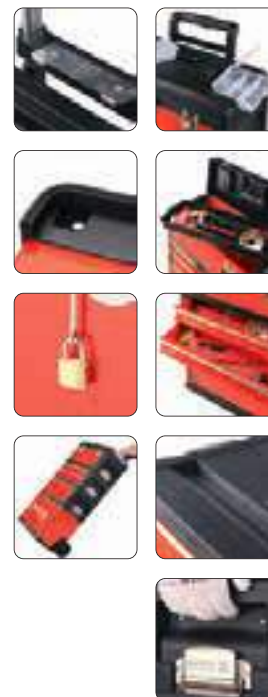





78
PCS

3
TRAYS
TACE







YATO 
YT-09104





Drawer 1 / Szuflada 1

-  1/2" (12.7 mm): 8, 10, 12, 13, 14, 15, 16, 17, 18, 19, 20, 21, 22 mm; CrV 50BV30;
-  1/2" (12.7 mm); (127 mm); CrV 50BV30;
-  1/2" (12.7 mm); (255 mm); 72T; CrV 6140;
-  3x75, 6x100; PH0x75, PH2x100 mm; S2;
-  215 mm;
-  1/4" (6.3 mm): 3.0, 3.5, 4.0, 5.5, 6.5 mm (L=25 mm); S2;
-  1/4" (6.3 mm): PH0, PH1, PH2, PH3 (L=25 mm); S2;
-  1/4" (6.3 mm): PZ0, PZ1, PZ2, PZ3 (L=25 mm); S2;
-  1/4" (6.3 mm): T10, T15 (L=25 mm); S2;
-  1/4" (6.3 mm): 2, 3, 4, 5, 6 mm (L=25 mm); S2;
-  1/4" (6.3 mm): 5, 6, 7, 8 x2, 9, 10, 11, 12, 13 mm

Drawer 2 / Szuflada 2

-  8, 10, 12, 13, 14, 15, 16, 17, 18, 19, 21 mm; CrV;
-  18 mm; SK5;
-  18 mm; SK5;
-  3 m x 16 mm

Drawer 3 / Szuflada 3

-  180 mm;
-  160 mm;
-  200 mm;
-  300 mm; 16-38 mm;
-  2, 2.5, 3, 4, 5, 6, 7, 8, 10, 12 mm; CrV 6150





YATO 
YT-09104

1



EN Cantilever tool box
 PL Skrzynka narzędziowa
 DE Werkzeugkoffer
 RU Инструментальный ящик
 CZ Nástrojová skříňka
 HU Szerszámosláda
 RO Cutie pt. scule
 FR Boîte à outils
 IT Cassetta degli attrezzi
 ES Caja de herramientas
 CN 手提工具箱



YATO  Dimensions / Wymiary [mm] 
 YT-0882 360x150x115 4



EN Cantilever tool box
 PL Skrzynka narzędziowa
 DE Werkzeugkoffer
 RU Инструментальный ящик
 CZ Nástrojová skříňka
 HU Szerszámosláda
 RO Cutie pt. scule
 FR Boîte à outils
 IT Cassetta degli attrezzi
 ES Caja de herramientas
 CN 手提工具箱



YATO  Dimensions / Wymiary [mm] 
 YT-0883 428x180x180 1

EN Cantilever tool box
 PL Skrzynka narzędziowa
 DE Werkzeugkoffer
 RU Инструментальный ящик
 CZ Nástrojová skříňka
 HU Szerszámosláda
 RO Cutie pt. scule
 FR Boîte à outils
 IT Cassetta degli attrezzi
 ES Caja de herramientas
 CN 工具箱



YATO  Dimensions / Wymiary [mm] 
 YT-0884 460x200x180 1



EN Cantilever tool box
 PL Skrzynka narzędziowa
 DE Werkzeugkoffer
 RU Инструментальный ящик
 CZ Nástrojová skříňka
 HU Szerszámosláda
 RO Cutie pt. scule
 FR Boîte à outils
 IT Cassetta degli attrezzi
 ES Caja de herramientas
 CN 工具箱



YATO  Dimensions / Wymiary [mm] 
 YT-0885 460x200x225 1



EN Cantilever tool box
 PL Skrzynka narzędziowa
 DE Werkzeugkoffer
 RU Инструментальный ящик
 CZ Nástrojová skříňka
 HU Szerszámosláda
 RO Cutie pt. scule
 FR Boîte à outils
 IT Cassetta degli attrezzi
 ES Caja de herramientas
 CN 手提工具箱



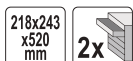

YATO  Dimensions / Wymiary [mm] 
 YT-0886 510x220x240 1

EN Cantilever tool box
 PL Skrzynka narzędziowa
 DE Werkzeugkoffer
 RU Инструментальный ящик
 CZ Nástrojová skříňka
 HU Szerszámosláda
 RO Cutie pt. scule
 FR Boîte à outils
 IT Cassetta degli attrezzi
 ES Caja de herramientas
 CN 工具箱





YATO  Drawer quantity / Liczba szuflad 
 YT-08872 2 218x255x520 1

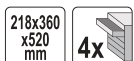

YATO  Drawer quantity / Liczba szuflad 
 YT-08873 3 218x300x520 1



YATO  Drawer quantity / Liczba szuflad 
 YT-08874 4 218x360x520 1

EN Tool box with tools
PL Skrzynka z narzędziami
DE Werkzeugkoffer
RU Инструментальный ящик
CZ Nástrojová skříňka
HU Szerszámoszláda
RO Cutie pt. scule
FR Boîte d'outils
IT Cassetta degli attrezzi
ES Caja de herramientas
CN 工具组套



62 PCS	475x230 x365 mm	1/2" 12.7mm	CrV 50BV30	CrV 6150
CrV 6140	72T	AS-DRIVE	⊖	⊕

- 1/2" (12.7 mm): 10, 11, 12, 13, 14, 15, 16, 17, 18, 19, 20, 21, 22, 23, 24 mm (L=38 mm); 27, 30, 32 mm (L=42 mm); CrV 50BV30;
- 1/2" (12.7 mm): (76, 127, 254 mm); CrV 50BV30;
- 1/2" (12.7 mm); CrV 50BV30;
- 1/2" (12.7 mm): 21 mm; CrV 50BV30;
- 1/2" (12.7 mm); (255 mm); CrV 50BV30;
- 1/2" (12.7 mm); 72T; CrV 6140;
- 1/2" (12.7 mm); (450 mm); CrV 50BV30;
- 6, 7, 8, 9, 10, 11, 12, 13, 14, 15, 16, 17, 18, 19, 20, 21, 22, 24 mm; CrV;
- 6x100, 6x150, 8x200 mm; CrV 6150;
- PH2x100, PH3x150, PH3x200 mm; CrV 6150;
- 180 mm; CrV;
- 160 mm; CrV;
- 160 mm; CrV;
- 1.5, 2, 2.5, 3, 4, 5, 6, 8, 10 mm; CrV 6150



YATO	Dimensions / Wymiary [mm]	
YT-3895	475x230x365	1

EN Tool box with tools
PL Skrzynka z narzędziami
DE Werkzeugkoffer
RU Инструментальный ящик
CZ Nástrojová skříňka
HU Szerszámoszláda

RO Cutie pt. scule
FR Boîte d'outils
IT Cassetta degli attrezzi
ES Caja de herramientas
CN 工具组套



80 PCS	460x220 x245 mm	1/2" 12.7mm	1/4" 6.3mm	CrV 50BV30
CrV 6140	S2	72T	AS-DRIVE	⊖

- 1/2" (12.7 mm): 10, 11, 12, 13, 14, 15, 17, 19 mm (L=38 mm);
- 1/4" (6.3 mm): 5, 6, 7, 8, 9, 10, 11, 12, 13 mm (L=25 mm); CrV 50BV30;
- 1/2" (12.7 mm): 21 mm; CrV 50BV30;
- 1/2" (12.7 mm); (255 mm); 72T; CrV 6140;
- 1/4" (6.3 mm); (150 mm); CrV 50BV30;
- 1/4" (6.3 mm) x 1/4" (6.3 mm); CrV 50BV30;
- 1/4" (6.3 mm): 3 x2, 4 x2, 5 x2, 5.5 x2, 6 x2 mm (L=25 mm); AISI S2;
- 1/4" (6.3 mm): PH0, PH1 x2, PH2 x2, PH3 (L=25 mm); AISI S2;
- 1/4" (6.3 mm): PZ0, PZ1 x2, PZ2 (L=25 mm); AISI S2;
- 6, 7, 8, 9, 10, 11, 12, 13, 14, 15, 17, 19 mm; CrV;
- 5x75 mm, 6x100 mm, 8x150 mm, PH1x75 mm, PH2x100 mm; S2;
- 180 mm; CrV;
- 160 mm; CrV;
- 160 mm; CrV;
- 250 mm;
- 300 g;
- 18 mm; SK2;
- 18x0.5 mm; SK2;
- 1.5, 2, 2.5, 3, 4, 5, 5.5, 6 mm; T10, T15, T20, T25, T27, T30, T40; CrV



YATO	Dimensions / Wymiary [mm]	
YT-38951	460x220x245	1

- EN Oil filter chain wrench
- PL Klucz łańcuchowy do filtrów oleju
- DE Ölfilter-Kettenschlüssel
- RU Цепной ключ для масляных фильтров
- CZ Klíč na olejové filtry řetězový
- HU Olajszűrő leszedő láncos
- RO Cheie cu lanț pt. filtre ulei
- FR Clé à chaîne pour filtre à huile
- IT Chiave a catena per filtri olio
- ES Llave de cadena para filtros de aceite
- CN 过滤器链式扳手





1/2"
12.7mm

DOUBLE CHAIN
PODWÓJNY LANCUCH

CrV



YATO 	Ø [mm]	
YT-08253	60-115	5/30
YT-08254	75-170	5/30



- EN Oil filter wrench
- PL Klucz do filtra oleju
- DE Ölfilterschlüssel
- RU Съёмник масляного фильтра
- CZ Klíč na olejový filtr
- HU Olajszűrő leszedő
- RO Cheie pt. filtru de ulei
- FR Clé pour filtre à huile
- IT Chiave per filtro olio
- ES Llave para filtro de aceite
- CN 滤清器扳手



1/2"
12.7mm

CrMo



YATO 	Ø [mm]	
YT-08235	60-80	20
YT-08236	80-105	20



- EN Self-adjustable oil filters pliers
- PL Szczypce samonastawne do filtrów oleju
- DE Selbsteinstellende Zangen für Ölfilter
- RU Саморегулирующиеся клещи для масляного фильтра
- CZ Samonastavovací kleště pro olejový filtr
- HU Önbeállító olajszűrő leszedő fogó
- RO Cheie reglabilă pt. filtre ulei
- FR Pince à filtre à huile auto-ajustable
- IT Pinza auto-regolante per filtri d'olio
- ES Pinzas autoajustables para filtros de aceite
- CN 滤清器扳手

60-120
mm

280
mm

ADJUSTABLE
NASTAWNY



YATO 	Ø [mm]	L [mm]	
YT-08231	60-120	280	6/36

- EN Oil filter chain wrench
- PL Klucz łańcuchowy do filtrów oleju
- DE Ölfilter-Kettenschlüssel
- RU Цепной ключ для масляных фильтров
- CZ Klíč na olejové filtry řetězový
- HU Olajszűrő leszedő láncos
- RO Cheie cu lanț pt. filtre ulei
- FR Clé à chaîne pour filtre à huile
- IT Chiave a catena per filtri olio
- ES Llave de cadena para filtros de aceite
- CN 过滤器链式扳手





Ø
60-160
mm

DOUBLE CHAIN
PODWÓJNY LANCUCH

CrV



YATO 	Ø [mm]	
YT-08255	60-160	6/24

- EN Oil filter wrench
- PL Klucz do filtra oleju
- DE Ölfilterschlüssel
- RU Съёмник масляного фильтра
- CZ Klíč na olejový filtr
- HU Olajszűrő leszedő
- RO Cheie pt. filtru de ulei
- FR Clé pour filtre à huile
- IT Chiave per filtro olio
- ES Llave para filtro de aceite
- CN 滤清器扳手





1/2"
12.7mm

105x150
mm



CrMo

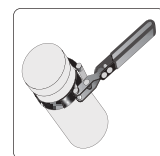

YATO 	Ø [mm]	
YT-08237	105-150	8

- EN Oil filter wrench
- PL Klucz do filtra oleju
- DE Ölfilterschlüssel
- RU Съёмник масляного фильтра
- CZ Klíč na olejový filtr
- HU Olajszűrő leszedő
- RO Cheie pt. filtru de ulei
- FR Clé pour filtre à huile
- IT Chiave per filtro olio
- ES Llave para filtro de aceite
- CN 滤清器扳手



YATO 	Ø [mm]	
YT-0820	60-73	6/36
YT-0821	73-85	6/36
YT-0822	85-95	6/36
YT-0823	95-111	6/36

EN Belt oil wrench
PL Klucz taśmowy do filtrów oleju
DE Ölfilterschlüssel mit Riemen
RU Ключ тросовый для масляных фильтров
CZ Klíč na olejové filtry
HU Olajszűrő leszedő

RO Cheie filtru cu banda
FR Clé au filtre d'huile
IT Chiave a nastro per filtro olio
ES Llave de cinta para filtros de aceite
CN 皮带钳扳手

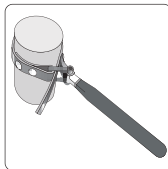

YATO	Ø [mm]	
YT-0824	80-160	6/60
YT-0825	100-200	5/20

EN Fuel filter socket
PL Nasadka do filtra paliwa
DE Aufsatz für Kraftstofffilter
RU Крышка для топливного фильтра
CZ Násada do palivového filtru
HU Üzemanyagszűrő fedél kulcs
RO Cheie pt. filtru combustibil
FR Douille pour filtre à carburant
IT Attacco per filtro del carburante
ES Vaso para filtro de combustible
CN 燃油过滤器套筒



1/2" 12.7mm
27 mm
CrV
FOR FUEL FILTER DO FILTRA PALIWA



YATO	Ø	
YT-12000	1/2" (12.5 mm)	20/40

EN Cap type oil filter wrench set
PL Zestaw kluczy nasadowych do filtra oleju
DE Steckschlüsselsatz für Ölfilter
RU Набор торцовых ключей к масляному фильтру
CZ Sada miskovitých klíčů na olejové filtry
HU Dugókulcs készlet olajszűrőhöz
RO Set de chei tubulare pt. filtru de ulei
FR Jeu de cloches pour filtre d'huile
IT Set chiavi a tazza per filtri olio
ES Juego de llaves para filtros de aceite
CN 碗型滤清器扳手手套

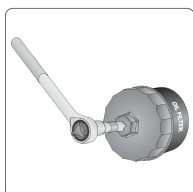

number number	size rozmiar	layers warstwy	grooves bruzdy	faces powierzchnie	car models modele samochodu
66/6	SW66	1	6		Fiat Punto 1.2, Renault Clio 1.2, Rapid, Twingo
76/8	SW76	1	8		Fiat, Lancia
76/12	SW76	1		12	Fiat, Mercedes, Renault
86/16	SW86	1		16	Volvo
86/18	SW86	1		18	VW Golf, Audi A6 TDI, Peugeot, Citroen
92/10	SW92	1		10	Fiat
93/45	SW93	1	45		VW, Audi TDI
96/18	SW96	1	18		Audi A4, A6 TDI, VQ Passat TDI, Renault Laguna
106/15	SW106	1		15	Fiat Ducato
108/15	SW108	1		15	Volvo
108/18	SW108	1	18		Renault Espace, Laguna, Safrane, Traffic

EN Oil filter wrench
PL Klucz do filtra oleju
DE Ölfilterschlüssel
RU Съёмник масляного фильтра
CZ Klíč na olejový filtr
HU Olajszűrő leszedő
RO Cheie pt. filtru de ulei
FR Clé pour filtre à huile
IT Chiave per filtro olio
ES Llave para filtro de aceite
CN 滤清器扳手



2.5"-4" 63-120 mm
3/8" 9.5 mm
1/2" 12.7 mm
HRC 40-50
CrV

YATO		
YT-0826		12/36

EN Haldex filter service tool
PL Klucz specjalny do filtra haldex
DE Spezialschlüssel für Haldex-Filter
RU Специальный ключ для фильтра haldex
CZ Speciální klíč do filtru haldex
HU Speciális kulcs haldex szűrőhöz

RO Cheie pt. filtru haldex
FR Clé pour filtre haldex
IT Chiave filtro olio per frizione haldex
ES Llave especial para el filtro haldex
CN 差速器滤芯板

Ø 46 mm
390 mm
CrMo
VAG
HALDEX



VAG

YATO	L [mm]	
YT-05971	390	10/20



13 PCS
65-120 mm
3/8" 9.5 mm
1/2" 12.7 mm

YATO		
YT-0594		5

- EN Cap type oil filter wrench set
- PL Zestaw kluczy nasadowych do filtra oleju
- DE Steckschlüsselsatz für Ölfilter
- RU Набор торцовых ключей к масляному фильтру
- CZ Sada miskovitých klíčů na olejové filtry
- HU Dugókulcs készlet olajszűrőhöz
- RO Set de chei tubulare pt. filtru de ulei
- FR Jeu de cloches pour filtre d'huile
- IT Set chiavi a tazza per filtri olio
- ES Juego de llaves para filtros de aceite
- CN 碗型滤清器扳手组套

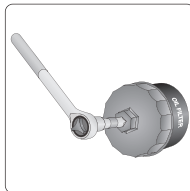

30
PCS **3/8"**
9.5 mm

number numer	size rozmiar	layers warstwy	grooves bruzdy	faces powierzchnie	car models modele samochodow
66/6	SW66	1	6		Fiat Punto 1.2, Renault Clio 1.2, Rapid, Twingo
65/14	SW65	1		14	Daihatsu, Toyota, Nissan, Fiat
65/67	SW65-67	1		14	Daihatsu, Toyota
68/14	SW68	1		14	Mazda, Ford, Subaru
73/14	SW73	1		14	Toyota, Lexus
74/15	SW74	1		15	Audi, Rover, Chrysler
74/76	SW74-76	2		15	Ford, Opel, VW, Audi, Mercedes
75/77	SW75-77	2		15	VW, Audi, Isuzu, Mercedes
76/12	SW76	1		12	Fiat, Mercedes, Renault
76/14	SW76	1		14	VW, Porsche, Mercedes, BMW, Audi, Opel
76/30	SW76	1	30		Ford
76/8	SW76	1	8		Fiat, Lancia
78/15	SW78	1		15	Nissan, Ford, Toyota
80/15	SW80	1		15	Nissan, Honda, Opel, Mazda
80/82	SW80-82	2		15	Subaru, Toyota, Honda, Nissan
86/16	SW86	1		16	Volvo
86/18	SW86	1		18	VW Golf, Audi A6 TDI, Peugeot, Citroen
90/15	SW90	1		15	Honda, Mitsubishi, Isuzu
92/10	SW92	1		10	Fiat
93/15	SW93	1		15	Mazda, Volvo, Mitsubishi, Nissan, Honda
93/36	SW93	1	36		Ford
93/45	SW93	1	45		VW, Audi TDI
95/15	SW95	1	15		Toyota, Alfa Romeo, Ford
96/18	SW96	1	18		Audi A4, A6 TDI, VQ Passat TDI, Renault Laguna
100/15	SW100	1		15	Isuzu, Mitsubishi
106/15	SW106	1		15	Fiat Ducato
108/15	SW108	1		15	Volvo
108/18	SW108	1		18	Renault Espace, Laguna, Safrane, Traffic



YATO
YT-0596 3

- EN Oil filter offset wrench set
- PL Zestaw kluczy oczkowych do filtra oleju
- DE Ölfilterschlüssel-Satz
- RU Набор гаечных ключей для масляного фильтра
- CZ Sada klíčů na olejové filtry
- HU Olajszűrő leszedő kulcs készlet

- RO Set chei pt. filtru de ulei
- FR Jeu de clés polygonales pour filtre d'huile
- IT Set chiavi per filtri olio
- ES Juego de llaves para filtros de aceite
- CN 滤油器扳手组套

7
PCS **3/8"**
9.5 mm



24, 25, 27, 28, 29, 32, 36 mm

YATO
YT-05985 12/24

- EN Plastic oil plug driver set
- PL Zestaw kluczy do plastikowych korków oleju
- DE Schlüsselset für Plastikölstopfen
- RU Набор ключей для пластиковых масляных пробок
- CZ Sada klíčů na plastové olejové zátky
- HU Kulcskészlet műanyag olajleeresztő dugókhöz
- RO Set chei pt. bușon ulei de plastic
- FR Clés universelles pour bouchons de vidange d'huile en matière plastique
- IT Set di chiavi per tappi olio in plastica
- ES Juego de llaves para tapones de plástico para aceite
- CN 塑料油塞扳手组



5
PCS **3/8"**
9.5 mm

BMW, Ford, PSA, VAG

YATO
YT-05980 20

- EN Square oil drain plug wrench
- PL Klucz do korków spustowych oleju
- DE Schlüssel für Ölablassschraube
- RU Ключ для масляной пробки
- CZ Klíč do spouštěcích zátek oleje
- HU Olajleeresztő csavar kulcs

- RO Cheie pt. bușon ulei
- FR Clé pour bouchons de vidange d'huile
- IT Chiave per tappo di scarico olio
- ES Llave para tapones de descarga de aceite
- CN 方形放油塞扳手

8mm
10mm
PEUGEOT
RENAULT
VOLVO



Peugeot, Renault, Volvo

YATO
YT-05995 6/36

- EN Oil pan drain plug removal set
- PL Zestaw do obsługi korków spustowych oleju
- DE Ölablassschrauben-Schlüssel-Satz
- RU Комплект для откручивания масляных пробок
- CZ Sada pro demontáž vypouštěcí zátky olejové vany
- HU Olajleeresztő dugó kezelő készlet
- RO Set bușoane pt. baie ulei
- FR Kit d'entretien de bouchons de vidange d'huile
- IT Kit per la rimozione di tappi per olio
- ES Juego para extraer tapones de drenaje de aceite
- CN 塑料油底壳拆装工具

6
PCS **VAG** **PLASTIC OIL PLUGS PLASTIKOWE KORKI OLEJU**



VAG

YATO
YT-05994 12/72

EN Oil drain plug key set
PL Zestaw kluczy do korków oleju
DE Ölabblasschrauben-Schlüssel-Satz
RU Комплект ключей для сливной пробки
CZ Klíče nástrčné na zátky olejových van motorů
HU Olajleeresztő kulcs készlet

RO Set chei pt. bușon ulei
FR Ensemble de clés de bouchon de vidange d'huile
IT Set di chiavi a bussola
ES Juego de llaves para tapones de aceite
CN 油底壳螺丝组套

6
PCS
3/8"
9.5 mm
CrV



- 8, 3/8", 10, 12, 1/2", 14 mm;
- 3/8" (9.5 mm), 1/2" (12.7 mm)

YATO		
YT-05997	3/8" (9.5 mm)	10/40

EN Oil drain plug set
PL Zestaw kluczy do korków oleju
DE Ölabblasschrauben-Schlüssel-Satz
RU Комплект ключей для сливной пробки
CZ Klíče nástrčné na zátky olejových van motorů
HU Olajleeresztő kulcs készlet

RO Set chei pt. bușon ulei
FR Ensemble de clés de bouchon de vidange d'huile
IT Set di chiavi a bussola
ES Juego de llaves para tapones de aceite
CN 排油塞旋具组套

18
PCS
3/8"
9.5 mm
CrV



- 3/8" (9.5 mm): 7, 8, 10, 11, 12, 13, 14 mm;
- 5/16" (7.9 mm), 3/8" (9.5 mm);
- 3/8" (9.5 mm): 8, 9, 10, 12, 14, 17 mm;
- 3/8" (9.5 mm): 10 mm;
- 3/8" (9.5 mm): 10 mm, 3/8" (9.5 mm): 160 mm

YATO		
YT-0599	3/8" (9.5 mm)	10

EN Oil drain plug key set
PL Zestaw kluczy do korków oleju
DE Ölabblasschrauben-Schlüssel-Satz
RU Комплект ключей для сливной пробки
CZ Klíče nástrčné na zátky olejových van motorů
HU Olajleeresztő kulcs készlet
RO Set chei pt. bușon ulei
FR Ensemble de clés de bouchon de vidange d'huile
IT Set di chiavi a bussola
ES Juego de llaves para tapones de aceite
CN 油底壳修理工具

- 3/8" (9.5 mm): 8, 9, 10, 12, 13, 14, 17 mm;
- 3/8" (9.5 mm): 7, 8, 10, 11, 12, 13, 14 mm;
- 3/8" (9.5 mm) x 5/16" (7.9 mm), 3/8" (9.5 mm) x 3/8" (9.5 mm);
- 3/8" (9.5 mm): 10 mm;
- 3/8" (9.5 mm): T45;
- 3/8" (9.5 mm): M16;
- 3/8" (9.5 mm): 10 mm;
- 3/8" (9.5 mm);
- 3/8" (9.5 mm) x 1/4" (6.3 mm);
- 3/8" (9.5 mm): 160 mm;
- 3/8" (9.5 mm): 100 mm;
- 1/4" (6.3 mm): 10 mm;
- 1/4" (6.3 mm): VAG



YATO		
YT-05998	3/8" (9.5 mm)	10

EN Oil drain plug key set
PL Zestaw kluczy do korków oleju
DE Ölabblasschrauben-Schlüssel-Satz
RU Комплект ключей для сливной пробки
CZ Klíče nástrčné na zátky olejových van motorů
HU Olajleeresztő kulcs készlet

RO Set chei pt. bușon ulei
FR Ensemble de clés de bouchon de vidange d'huile
IT Set di chiavi a bussola
ES Juego de llaves para tapones de aceite
CN 排油塞旋具组套

18
PCS
3/8"
9.5 mm
CrV
50BV30



- 3/8" (9.5 mm): 7, 8, 10, 11, 12, 13, 14 mm;
- 5/16" (7.9 mm), 3/8" (9.5 mm);
- 3/8" (9.5 mm): 8, 9, 10, 12, 14, 17 mm;
- 3/8" (9.5 mm): 10 mm;
- 3/8" (9.5 mm): M16;
- 3/8" (9.5 mm): 10 mm

YATO		
YT-05991	3/8" (9.5 mm)	5/10

EN Oil drain plug key set
PL Zestaw kluczy do korków oleju
DE Ölabblasschrauben-Schlüssel-Satz
RU Комплект ключей для сливной пробки
CZ Klíče nástrčné na zátky olejových van motorů
HU Olajleeresztő kulcs készlet

RO Set chei pt. bușon ulei
FR Ensemble de clés de bouchon de vidange d'huile
IT Set di chiavi a bussola
ES Juego de llaves para tapones de aceite
CN 排油塞组套

12
PCS
3/8"
9.5 mm



- 3/8" (9.5 mm): 8, 11, 13 mm;
- 3/8" (9.5 mm): 8, 9, 10, 12, 14, 17 mm

YATO		
YT-0600	3/8" (9.5 mm)	10

26 PCS **3/8"** 9.5 mm **CrV** PLASTIC OIL PLUGS PLASTIKOWE KORKI OLEJU

EN Grease gun
 PL Smarownica ręczna
 DE Handhebel-Fettpresse
 RU Шприц для смазки ручной
 CZ Maznice páková
 HU Karos zsírzó

RO Pistol de gresat
 FR Pompe à graisse manuelle
 IT Ingrassatore manuale
 ES Pistola de engrase manual
 CN 手动黄油枪

70 MPa (max.)
 31 MPa
 500 cm³
 AI 



YATO 
 YT-0700  20

EN Grease gun
 PL Smarownica ręczna
 DE Handhebel-Fettpresse
 RU Шприц для смазки ручной
 CZ Maznice páková
 HU Karos zsírzó
 RO Pistol de gresat
 FR Pompe à graisse manuelle
 IT Ingrassatore manuale
 ES Pistola de engrase manual
 CN 手动黄油枪

70 MPa (max.)
 31 MPa
 120 cm³
 AI 



YATO 
 YT-0701  30

EN Grease gun
 PL Smarownica ręczna
 DE Handhebel-Fettpresse
 RU Шприц для смазки ручной
 CZ Maznice páková
 HU Karos zsírzó

RO Pistol de gresat
 FR Pompe à graisse manuelle
 IT Ingrassatore manuale
 ES Pistola de engrase manual
 CN 手动黄油枪

70 MPa (max.)
 31 MPa
 400 cm³
 AI 





YATO 
 YT-0705  20

EN Grease gun
 PL Smarownica ręczna
 DE Handhebel-Fettpresse
 RU Шприц для смазки ручной
 CZ Maznice páková
 HU Karos zsírzó

RO Pistol de gresat
 FR Pompe à graisse manuelle
 IT Ingrassatore manuale
 ES Pistola de engrase manual
 CN 手动黄油枪

70 MPa (max.)
 31 MPa
 600 cm³
 AI 



YATO 
 YT-07044  6

EN Grease gun
 PL Smarownica ręczna
 DE Handhebel-Fettpresse
 RU Шприц для смазки ручной
 CZ Maznice páková
 HU Karos zsírzó
 RO Pistol de gresat
 FR Pompe à graisse manuelle
 IT Ingrassatore manuale
 ES Pistola de engrase manual
 CN 手动黄油枪

27-41 MPa
 600 cm³
 AI 



YATO 
 YT-07042  6/12

EN Grease gun
 PL Smarownica ręczna
 DE Handhebel-Fettpresse
 RU Шприц для смазки ручной
 CZ Maznice páková
 HU Karos zsírzó
 RO Pistol de gresat
 FR Pompe à graisse manuelle
 IT Ingrassatore manuale
 ES Pistola de engrase manual
 CN 手动黄油枪

27-41 MPa
 800 cm³
 AI 





YATO 
 YT-07043  4/8

EN Two-way operation grease gun
 PL Smarownica ręczna, wzmocniona
 DE Handhebel-Fettpresse
 RU Шприц для масляной смазки
 CZ Páková maznice
 HU Karos zsírzó

RO Masina de gresat cu furtun rigid
 FR Pistolet de graissage manuel
 IT Lubrificatore manuale
 ES Pistola de engrase
 CN 重型黄油枪

70 MPa (max.)
 42 MPa
 500 cm³
 AI 





YATO 
 YT-0704  12

EN Two-way operation grease gun
 PL Smarownica ręczna, wzmocniona
 DE Handhebel-Fettpresse
 RU Шприц для масляной смазки
 CZ Páková maznice
 HU Karos zsírzó

RO Masina de gresat cu furtun rigid
 FR Pistolet de graissage manuel
 IT Lubrificatore manuale
 ES Pistola de engrase
 CN 重型黄油枪

70 MPa (max.)
 42 MPa
 500 cm³
 AI 



YATO 
 YT-07041  10

EN Grease gun
PL Smarownica ręczna
DE Handhebel-Fettpresse
RU Шприц для смазки ручной
CZ Maznice páková
HU Karos zsírzó
RO Pistol de gresat
FR Pompe à graisse manuelle
IT Ingrassatore manuale
ES Pistola de engrase manual
CN 手动黄油枪



55 MPa (max.)
24.8 MPa
400 cm³
AI



YATO 

YT-07045

6

EN Grease gun
PL Smarownica ręczna
DE Handhebel-Fettpresse
RU Шприц для смазки ручной
CZ Maznice páková
HU Karos zsírzó

RO Pistol de gresat
FR Pompe à graisse manuelle
IT Ingrassatore manuale
ES Pistola de engrase manual
CN 手动黄油枪



69 MPa (max.)
27.6 MPa
400 cm³
AI



YATO 

YT-07046

8

EN Extraction & fill pump
PL Odśysarka ręczna do płynów eksploatacyjnych
DE Manuelle Absaugvorrichtung für Betriebsflüssigkeiten
RU Ручной отсос для рабочих жидкостей
CZ Ruční odsávací zařízení provozních kapalin
HU Kézi üzemi folyadék elszívó

RO Pompă manuală extractie
FR Appareil portable de vidange par aspiration
IT Aspiratore manuale per liquidi
ES Dispositivo de succión manual
CN 抽油泵

200 ml
FOR OPERATIONAL LIQUIDS
DOPPELNU
EKSPLOATACYJNYCH



YATO 

YT-07083

24

EN Extraction & fill pump
PL Odśysarka ręczna do płynów eksploatacyjnych
DE Manuelle Absaugvorrichtung für Betriebsflüssigkeiten
RU Ручной отсос для рабочих жидкостей
CZ Ruční odsávací zařízení provozních kapalin
HU Kézi üzemi folyadék elszívó

RO Pompă manuală extractie
FR Appareil portable de vidange par aspiration
IT Aspiratore manuale per liquidi
ES Dispositivo de succión manual
CN 抽加油壶

500 ml
FOR OPERATIONAL LIQUIDS
DOPPELNU
EKSPLOATACYJNYCH



YATO 

YT-07084

20

EN Oil transfer pump
PL Pompa transferowa do oleju
DE Öl-Umfüllpumpe
RU Шприц для перекачки масел
CZ Ruční olejová pumpa
HU Olajpumpa

RO Pompă extras ulei
FR Pompe pour huile
IT Lubrificatore manuale per travaso olio
ES Bomba manual de travase dual
CN 输油泵

70 MPa (max.)
31 MPa
500 cm³



YATO 

YT-0707

20

EN Oil drainer
PL Odśysarka ręczna do oleju
DE Öl-Absaugpumpe
RU Ручной шприц для откачки масла
CZ Ruční odsávací oleje
HU Kézi olajszivattyú

RO Pompă extras ulei
FR Seringue à huile
IT Lubrificatore manuale per aspirazione olio
ES Bomba manual de travase
CN 输油泵

70 MPa (max.)
31 MPa
500 cm³



YATO 

YT-0708

20

EN Grease gun adaptors set
PL Zestaw końcówek do smarownic
DE Mundstücksatz für Fettpressen
RU Набор наконечников для смазочного шприца
CZ Sada koncovek pro maznice
HU Olajozó fejkészlet
RO Set adaptoare pt. gresoare
FR Jeu d'accessoires pour pompes à graisse
IT Kit di nipples per ingrassatori
ES Juego de puntas para engrasadores
CN 黄油嘴配件套装

7 PCS 38 cm 90° 180° 360° UNIVERSAL UNIVERSAL 



YATO 

YT-07110

10

EN Grease coupler
PL Glowica do smarownicy
DE Fettpressenkopf
RU Головка для пресс-масленки
CZ Hlavice do maznice
HU Olajozó fej
RO Cap pt. pistol de gresat
FR Tête de graisseur
IT Testa per lubrificatore
ES Cabezal para engrasador
CN 高压油嘴头

15 mm G26 



YATO 

YT-07102

Ø [mm]

15

18/72

EN Multi-use transfer pump
 PL Pompa transferowa do płynów
 DE Übertragungspumpe für Flüssigkeiten
 RU Перекачивающий насос для жидкостей
 CZ Přechrávací čerpadlo na kapaliny
 HU Átvivő szivattyú folyadékokhoz

RO Pompa de transfer multifunctionala
 FR Pompe de transfert de liquides
 IT Pompa di trasferimento per liquidi
 ES Bomba de transferencia de líquidos
 CN 打气筒

170 ml
 FOR OPERATIONAL LIQUIDS TO PERFORM EXPLORATORY WORKS
 PUMP FUNCTION FUNKCJA POMPKI
 PVC
 PP



YATO	[ml]	
YT-07071	170	6/24

EN Manual hand pump
 PL Odsysarka ręczna do płynów eksploatacyjnych
 DE Handabsauger für Betriebsflüssigkeiten
 RU Ручной инструмент для всасывания рабочих жидкостей
 CZ Ruční odsávací zařízení provozních kapalin
 HU Kézi szivattyú üzemi folyadékokhoz
 RO Pompă manuală extracție
 FR Pompe d'aspiration manuelle de fluides
 IT Aspiratore manuale per liquidi
 ES Bomba manual para fluidos de trabajo
 CN 抽油泵

1.5L
 FOR OPERATIONAL LIQUIDS TO PERFORM EXPLORATORY WORKS



Opel, PSA

YATO	
YT-07082	20

EN Grease pump
 PL Smarownica ręczna
 DE Manuelle Fettpumpe
 RU Ручной нагнетатель смазки

CZ Maznice ruční
 HU Kézi zsírópumpa
 RO Pompă pt. gresat
 FR Pompe à graisse manuelle

IT Ingrassatore manuale
 ES Bomba engrase manual
 CN 黄油泵

1.5 m



13.8 MPa (max.)

4 kg



13.8 MPa (max.)

8 kg



20.5 MPa (max.)

16 kg

YATO	Grease tank capacity / Pojemność zbiornika smaru [kg]	
YT-07061	4	1

YATO	Grease tank capacity / Pojemność zbiornika smaru [kg]	
YT-07063	8	1

YATO	Grease tank capacity / Pojemność zbiornika smaru [kg]	
YT-07065	16	1

EN Flexible tube for grease gun
 PL Wążek do tawotnicy
 DE Schlauch für Fettpresse
 RU Шприц для перекачки масел
 CZ Hadička na maznice na šmír
 HU Tömítő a zsíróhoz

RO Furtun flexibil pt. pistol de gresat
 FR Flexible pour graisseur
 IT Tubo flessibile per ingrassatore
 ES Manguera para engrasador
 CN 手用黄油枪软管

∅ 3.2mm



YATO	L [mm]	
YT-0709	300	12/144
YT-0710	500	12/144

EN Flexible hose for grease gun
 PL Wążek do tawotnicy
 DE Fettpressenschlauch
 RU Шланг для тавотницы
 CZ Hadička do vazelíny
 HU Cső zsíróhoz

RO Furtun flexibil pt. pistol de gresat
 FR Flexible pour graisseur
 IT Tubo flessibile per ingrassatore
 ES Manguera para engrasador
 CN 高压尼龙软管

69 MPa (max.)
 440 mm

G26

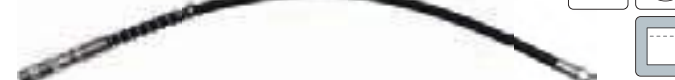

YATO	L [mm]	
YT-07101	440	9/36

EN Oil can with a flexible applicator
 PL Oliwiarka z elastycznym aplikatorem
 DE Ölkanne mit elastischem Applikator

RU Масленка с гибким наконечником
 CZ Olejníčka s flexibilním hrdlem
 HU Hajlékony csövű olajozó

RO Pompiță de ulei cu aplicator flexibil
 FR Burette à huile avec applicateur souple
 IT Oliatore con ugello flessibile

ES Aceitera con aplicador flexible
 CN 油壶



200 ml

IMPACT RESISTANT
 ODPORNY NA UDERZENIA

YATO	V [ml]	
YT-06912	200	10/120



300 ml

IMPACT RESISTANT
 ODPORNY NA UDERZENIA

YATO	V [ml]	
YT-06913	300	10/120



500 ml

IMPACT RESISTANT
 ODPORNY NA UDERZENIA

YATO	V [ml]	
YT-06914	500	10/80

YATO	V [cm³]	
YT-0690	220	10/120
YT-0691	270	10/120

EN Precision oiler
PL Oliwiarka precyzyjna
DE Präzisionsöler
RU Прецизионная масленка
CZ Přesná olejníčka
HU Precíz olajozó
RO Gresor de precizie
FR Graisseur de précision
IT Oliatore di precisione
ES Aceitera de precisión
CN 润滑油笔



15 ml
150 mm
AI

EN Engine oil filler set
PL Lejek do wlewania oleju z adapterami
DE Ölfüller-Set
RU Воронка для моторного масла с адаптерами
CZ Sada pro plnění motorového oleje
HU Olajfelöntő adapter
RO Set completare ulei motor
FR Adaptateur de remplissage d'huile aide avec entonnoir
IT Imbuto per versare olio con adattatori
ES Automotiva embudo de llenado de aceite
CN 加油漏斗组套



15 PCS
2L
FOR TIGHT SPACES DO CIĄSNYCH PRZESTRZYM
AI

YATO	V [ml]	
YT-06977	15	12/120

YATO		
YT-06919		4

EN Oil pump
PL Pompa tłokowa do oleju
DE Öl-Umfüllpumpe
RU Шприц ручной заливной
CZ Ruční olejová pumpa
HU Olajpumpa
RO Pompă manuală pt. ulei
FR Pompe pour huile
IT Pompa manuale travaso fusti olio
ES Bomba manual para aceite
CN 吸油泵



16-18 l/min
45-90 cm
max 55 min
0.31 CYCLE CYCL
AI
FOR OIL DO OLEJU

YATO	
YT-0712	10

EN Aluminium rotary oil pump
PL Aluminiowa pompa do oleju
DE Aluminium-Kurbelpumpe
RU Алюминиевый ручной бочковой насос
CZ Hliník rotační čerpadlo
HU Alumínium rotációs szivattyú
RO Pompă rotativă din aluminiu
FR Pompe manuelle pour huile
IT Pompa a mano per olio
ES Aluminio bomba rotary
CN 手摇油泵



21 l/min
500 cm
300 cm
x3 PIPE RURA
AI
FOR OIL DO OLEJU

YATO	
YT-07115	10

EN High value rotary barrel pump
PL Wysokowydajna pompa rotacyjna do paliwa
DE Kurbelpumpe für Benzinfässer
RU Насос топливный ротационный
CZ Čerpadlo palivové rotační
HU Kézi pumpa hordóhoz (forgatható)
RO Pompă rotativă pt. combustibil
FR Pompe rotative à combustible
IT Pompa rotativa travaso gasolio
ES Bomba de combustible rotatoria
CN 手摇泵



100 l/min
100 cm
1.01 CYCLE CYCL
180 µm BRASS FILTER ROSEMARY FEKTR
2.4m ANTISTATIC HOSE WIG ANTISTATYCZNY
AI
FOR FUELS AND OIL DO PALIW I OLEJU

YATO	
YT-0715	4

EN Electric engine oil extractor pump
PL Elektryczna pompa do odsysania oleju silnikowego
DE Elektrische Ölabsaugpumpe
RU Электрический насос для перекачки масла
CZ Elektrické čerpadlo na odsávání oleje
HU Elektromos olaj szivattyú
RO Pompă electrică de scos ulei
FR Pompe électrique de vidange d'huile moteur
IT Pompa elettrica aspirazione per olio motore
ES Bomba eléctrica extractora de aceite de motor
CN 汽车机油电动泵



100 W
12V
2-4 l/min

• Gear pump
• Pompa zębata

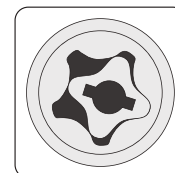

Ø 6, 8, 10 mm

YATO	[W]	
YT-07140	100	12

EN Two arms jaw puller RU Съёмник для подшипников RO Extractor rulmenti ES Extractor
 PL Ściągacz dwuramienny CZ Stahovák FR Extracteur CN 两爪拉马
 DE Abzieher-2-armig HU Csapágyelhúzó IT Estrattore a due griffe

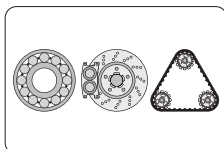

10 mm
 4"
 100 mm
 max Ø
 60 mm
 max
 1.2t



10 mm
 3"
 76 mm
 max Ø
 75 mm
 max
 1.1t



YATO	mm	mm	max. Ø [mm]	max. [t]	
YT-2514	10	100	60	1.2	6/60

YATO	mm	mm	max. Ø [mm]	max. [t]	
YT-2515	10	76	75	1.1	6/60

12 mm
 4"
 100 mm
 max Ø
 100 mm
 max
 1.4t



17 mm
 6"
 150 mm
 max Ø
 120 mm
 max
 6t



22 mm
 8"
 200 mm
 max Ø
 180 mm
 max
 9t



YATO	mm	mm	max. Ø [mm]	max. [t]	
YT-2516	12	100	100	1.4	12/48

YATO	mm	mm	max. Ø [mm]	max. [t]	
YT-2517	17	150	120	6	10/20

YATO	mm	mm	max. Ø [mm]	max. [t]	
YT-2518	22	200	180	9	6

EN Three arms jaw puller RU Съёмник для подшипников RO Extractor rulmenti cu trei brate ES Extractor detres patas
 PL Ściągacz trójramienny CZ Stahovák třiramenný FR Extracteur CN 三爪拉马
 DE Abzieher-3-armig HU Csapágyelhúzó IT Estrattore a tre griffe

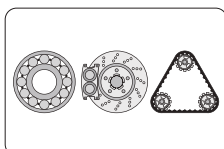

10 mm
 3"
 76 mm
 max Ø
 80 mm
 max
 1.5t



12 mm
 4"
 100 mm
 max Ø
 100 mm
 max
 2.5t



YATO	mm	mm	max. Ø [mm]	max. [t]	
YT-2519	10	76	80	1.5	6/60

YATO	mm	mm	max. Ø [mm]	max. [t]	
YT-2520	12	100	100	2.5	6/36

17 mm
 6"
 150 mm
 max Ø
 130 mm
 max
 5t



22 mm
 8"
 200 mm
 max Ø
 180 mm
 max
 9t



22 mm
 12"
 300 mm
 max Ø
 180 mm
 max
 11t



YATO	mm	mm	max. Ø [mm]	max. [t]	
YT-2521	17	150	130	5	12

YATO	mm	mm	max. Ø [mm]	max. [t]	
YT-2522	22	200	180	9	4

YATO	mm	mm	max. Ø [mm]	max. [t]	
YT-2523	22	300	180	11	2

EN Three arms jaw puller
PL Ściągacz trójramienny
DE Abzieher-3-armig
RU Съёмник для подшипников

CZ Stahovák tříramenný
HU Csapágyelhűző
RO Extractor rulmenti cu trei brate
FR Extracteur

IT Estrattore a tre griffe
ES Extractor detres patas
CN 三爪拉马

CrV 

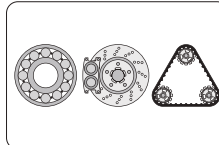

14 mm
3"
76 mm
∅ 50-150 mm



15 mm
4"
100 mm
∅ 60-200 mm



19 mm
6"
150 mm
∅ 80-300 mm

YATO	[mm]	[mm]	∅ [mm]	
YT-2511	14	76	50-150	20

YATO	[mm]	[mm]	∅ [mm]	
YT-2512	15	100	60-200	20

YATO	[mm]	[mm]	∅ [mm]	
YT-2513	19	150	80-300	10

EN Universal puller set
PL Ściągacz do łożysk w miejscach trudnodostępnych
DE Abziehvorrichtung für Lager
RU Съёмник подшипников в труднодоступных местах
CZ Sada na stahování ložisek na obtížně dostupných místech
HU Csapágyelhűző
RO Set extractor rulmenti
FR Extracteur aux roulements
IT Set di estrattori universali
ES Extractor de rodamientos en lugares de difícil acceso
CN 多功能拉拔器

• 13 x 250 mm;
• 13 x 200 mm;
• 13 x 100 mm;
• 160 mm;
• 

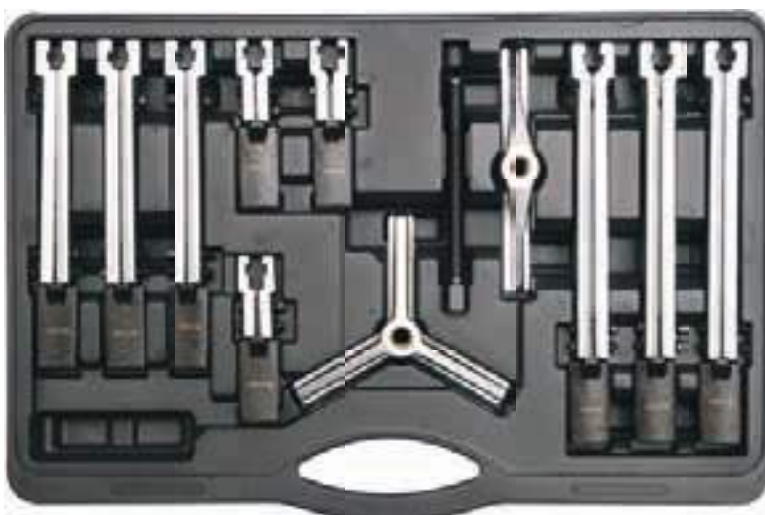
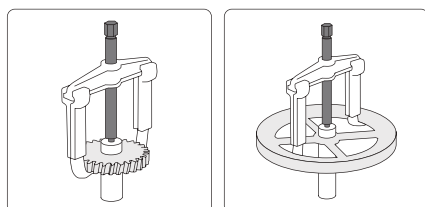

12 PCS
DROP FORGED KUTE
FOR TIGHT SPACES DO CIĄŻYCH PRZESTRZENI

YATO	
YT-25105	2

EN Gear puller
PL Ściągacz do łożysk
DE Lagerabzieher
RU Съёмник подшипников
CZ Stahovák na ložiska
HU Csapágyelhűző
RO Extractor pt. rulmenti
FR Extracteur de roulement
IT Estrattore per cuscinetti
ES Extractor de cojinetes
CN 齿轮拉拔器

13-38 mm CrV 6150 



YATO	∅ [mm]	
YT-2510	13-38	20

EN Universal wheel hub puller
PL Ściągacz uniwersalny do tarcz i bębnow
DE Scheiben-und Trommelbremsen Abzieher
RU Универсальный съёмник ступицы и полуоси
CZ Stahovák na brzdové bubny
HU Univerzális féktárcsa és fékdob lehűző
RO Trusa universala pt. transmisie cardanica
FR Extracteur universel pour les disques et les tambours
IT Estrattore a vite universale
ES Extractor universal de discos y tambores
CN 万用轮毂拉马

90-140 mm 130-180 mm CrV 

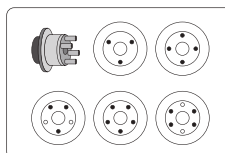

YATO	
YT-0602	6

- EN Separator and hydraulic cylinder turnbuckle
- PL Separator i ściągacz z sitownikiem hydraulicznym
- DE Separator und Abziehvorrichtung mit Hydraulikservomotor
- RU Сепаратор и съёмник с сервомотором
- CZ Oddělovač a stahovák s hydraulickým válcem
- HU Csapágyelhúzó és körmös csapágyelhúzó hidraulikus kézpumpával
- RO Separator și ancoră pt. servomotor hidraulic
- FR Séparateur avec actionneur hydraulique
- IT Separatore frizione cilindro idraulico
- ES Separador y tensor de tornillo con cilindro hidráulico
- CN 液压分离器组合



50 kN

HYDRAULIC CYLINDER
ŚLOWNIK
HYDRAULICZNY

HRC 38-45

DROP FORGED KUTE

CrV

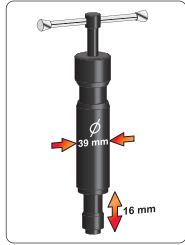

YATO	Force pressure / Sila nacisku [kN]	
YT-0609	50	2

- EN Twin leg puller with jaw hook
- PL Ściągacz uniwersalny dwuramienny
- DE Doppel Abzieher mit Haken
- RU Съёмник универсальный
- CZ Stahovák dvouramenný univerzální
- HU Csapágyelhúzó készlet
- RO Carlig cu falci pt. extras cu picor dublu
- FR Extracteur universel à deux bras
- IT Estrattore universale a due bracci
- ES Extractor de cuatro patas
- CN 单边两爪拉马

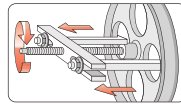
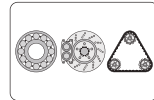

YATO		
YT-0640		10

- EN Gear puller set
- PL Ściągacz dwuramienny i separator
- DE Lagerabzieher, Trennmesser
- RU Съёмник универсальный с сепаратором
- CZ Stahovák dvouramenný
- HU Csapágyelhúzó készlet
- RO Set extras rulmenți
- FR Extracteur 2 bras + separateur
- IT Estrattore a due bracci a separatore
- ES Kit de extractor
- CN 齿轮拉拔器

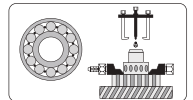
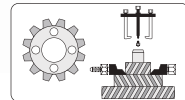
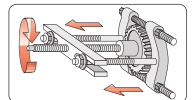
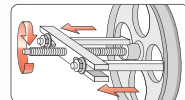
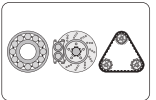

YATO		
YT-0641		4

- EN Gear puller set
- PL Ściągacz dwuramienny i separator
- DE Lagerabzieher, Trennmesser
- RU Съёмник универсальный с сепаратором
- CZ Stahovák dvouramenný
- HU Csapágyelhúzó készlet
- RO Set extras rulmenți
- FR Extracteur 2 bras + separateur
- IT Estrattore a due bracci a separatore
- ES Kit de extractor
- CN 齿轮拉拔器



14 PCS

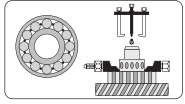
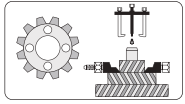
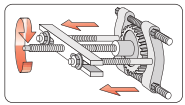
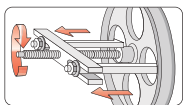
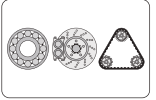

YATO		
YT-06412		2

EN Slide hammer and bearing puller set
PL Ściągacz bezwładnościowy do łożysk
DE Träge Abziehvorrichtung für Lager
RU Набор съёмников с обратным молотком
CZ Rázový stahovák s kluzným kladivem na ložiska
HU Csúszósúlyos csapágyelhúzó készlet
RO Set ciocan culisant extractor de rulmenti
FR Extracteur de roulements à inertie
IT Kit estrattore cuscinetti con martello scorrevole
ES Extractor de inercia para cojinetes
CN 滑锤轴承拉拔器组套

5
PCS

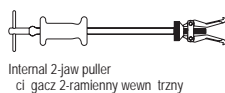
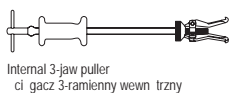
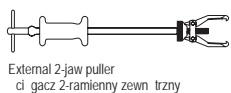
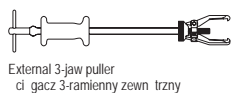
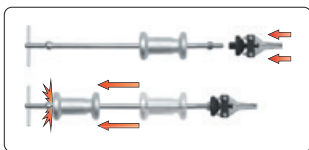
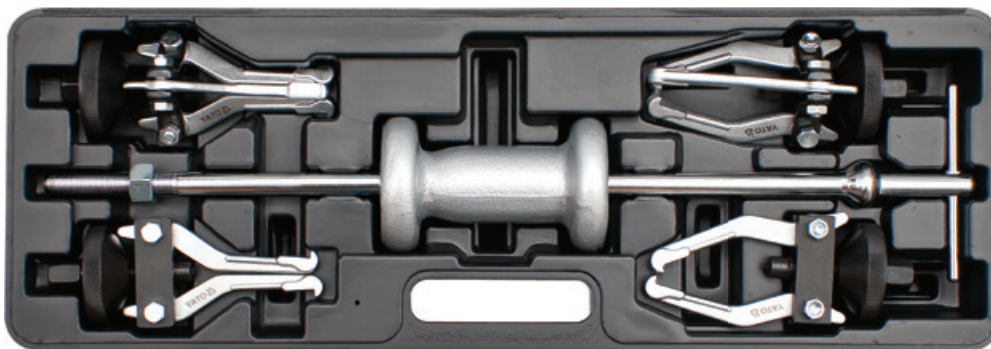

YATO
YT-2540

2

EN Bearing extractor set
PL Ściągacz bezwładnościowy do łożysk
DE Trägheitsabziehvorrichtung für Lager
RU Инерционный съёмник подшипников
CZ Stahovák kluzného ložiska
HU Csúzó kalapácsos csapágyelhúzó
RO Set extractor rulment
FR Extracteur de roulements
IT Kit estrattore cuscinetti con martello scorrevole
ES Extractor de rodamientos por inercia
CN 内轴承拉马

15
PCS

8-58
mm

INTERNAL
PULLER
ŚCIĄGACZ
WEWNĘTRZNY

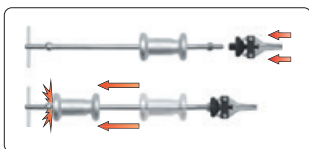
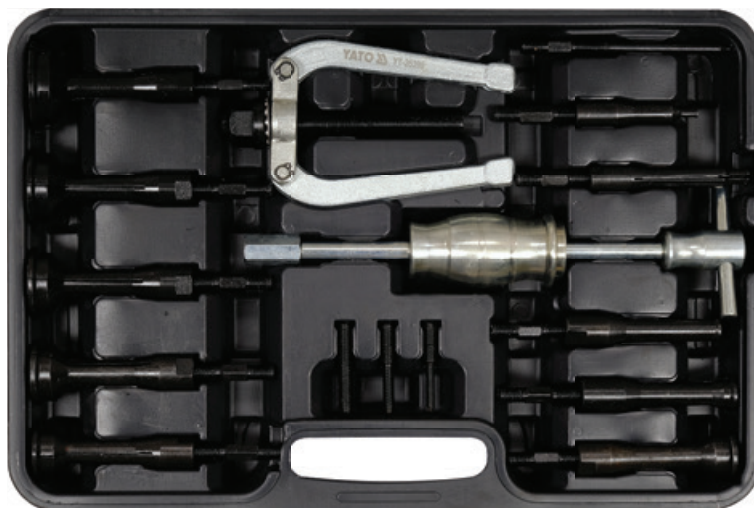

YATO
YT-25390

2

EN Slide hammer set
PL Ściągacz bezwładnościowy do piast i łożysk
DE Träge Abziehvorrichtung für Naben und Lager
RU Набор съёмников с обратным молотком
CZ Rázový stahovák s kluzným kladivem na náboje a ložiska
HU Csúszósúlyos kerékagy - és csapágyelhúzó készlet
RO Set ciocan culisant extractor de rulmenti și bucșe
FR Extracteur de roulements et moyeux à inertie
IT Estrattore per cuscinetti ruote con martello scorrevole
ES Extractor de inercia para cubos y cojinetes
CN 滑锤

16
PCS

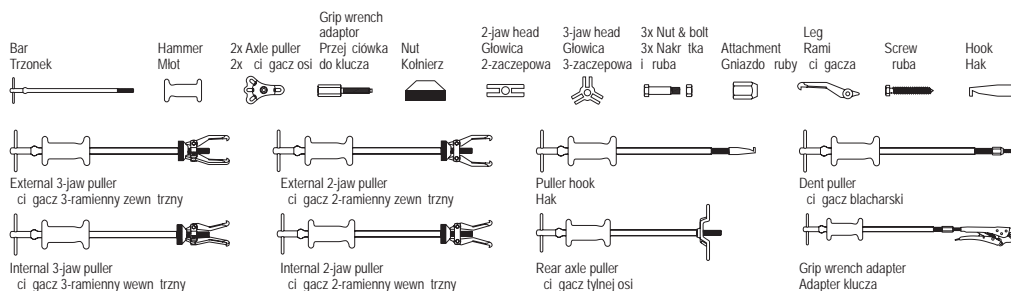
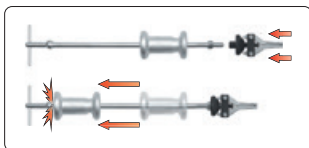

YATO
YT-25391

2

- EN CV joint assembly removal tool
- PL Ściągacz przegubów napędowych
- DE Gelenkwellen-Abzieher
- RU Съемник приводных шарниров
- CZ Stahovák kloubů hnacích hřídelí
- HU Féltengely csukló lehvűző
- RO Extractor universal pt. cap de planetara
- FR Extracteur de joint homocinétique
- IT Estrattore per giunti omocinetici
- ES Extractor de juntas homocinéticas
- CN 汽车球头拆卸工具



250 mm

145 mm

30 mm

UNIVERSAL
UNIVERSALNY



YATO 	L [mm]	
YT-06144	250	5

- EN Bearing and bush driver set
- PL Zestaw do osadzania łożysk i uszczelniaczy
- DE Lager- und Buchsentreiber-Satz
- RU Набор для установки подшипников и сальников
- CZ Sada pro montáž gufer a ložisek
- HU Csapógy és szimering beütő készlet

- RO Set pt. înlocuit rulment, simering
- FR Outils pour montage des roulements et joint
- IT Set di tamponi per cuscinetti e guarnizioni
- ES Juego de conductores del anillo y del sello de rodadura
- CN 斜型培令套安装器

52 PCS

STEEL
STAL



Ø 18, 19, 20, 21, 22, 23, 24, 25, 26, 27, 28, 29, 30, 31, 32, 33, 34, 35, 36, 37, 38, 39, 40, 41, 42, 43, 44, 45, 46, 47, 48, 49, 50, 51, 52, 53, 54, 55, 56, 57, 58, 59, 60, 61, 61, 63, 64, 65, 74 mm

YATO 	
YT-25417	1



- EN Front wheel bearing adapter set
- PL Ściągacz łożysk piasty przedniej
- DE Radlagerabzieher werkzeugsatz vorderachse
- RU Набор для снятия переднего подшипника переднеприводных автомобилей
- CZ Sada na demontáž ložisek přední nápravy
- HU Csapógylehűző adapter készlet első futóműhöz

- RO Set schimbat rulment roata fata
- FR Extracteur de moyeux
- IT Set estrattori per cuscinetti ruota anteriore adattatore universale
- ES Extractor de cojinetes para cubos de rueda delanteros
- CN 轴承拆装组套

23 PCS

FOR FRONT WHEEL BEARINGS ONLY (LEFT/RIGHT PASTY PRZEDNIEJ)



YATO 	
YT-2541	2

- EN Bearing and bush driver set
- PL Zestaw do osadzania łożysk i uszczelniaczy
- DE Lager- und Buchsentreiber-Satz
- RU Набор для установки подшипников и сальников
- CZ Sada pro montáž gufer a ložisek
- HU Csapógy és szimering beütő készlet

- RO Set pt. înlocuit rulment, simering
- FR Outils pour montage des roulements et joint
- IT Set di tamponi per cuscinetti e guarnizioni
- ES Juego de conductores del anillo y del sello de rodadura
- CN 斜型培令套安装器

33 PCS

METRIC
SAE

AI



Included / W zestawie: SAE adapters / adaptory calowe: 3/8"x7/16", 7/16"x1/2", 1/2"x9/16", 9/16"x5/8", 39/64"x11/16", 5/8"x3/4", 11/16"x13/16", 47/64"x7/8", 13/16"x15/16", 55/64"x1", 15/16"x1-1/16", 1"x1-1/8", 1-1/8"x1-1/4", 1-1/4"x1-3/8", 1-1/16"x1-3/16", 1-3/16"x1-5/16"; metric adapters / adaptory metryczne: Ø 10x12, 12x14, 14x16, 15x17, 16x18, 18x20, 20x22, 22x24, 25x27, 28x30, 30x34, 32x36, 35x40, 38x42 mm; pins / trzpienie: Ø 0.4", 0.6", 0.8"

YATO 	
YT-25418	10

EN Bearing and bushing tool set
PL Zestaw do obsługi łożysk i tulei
DE Radlagerwerkzeug-Satz
RU Набор для обслуживания подшипников и втулок
CZ Sada pro údržbu ložisek a pouzder
HU Kerékcsapágy és persely szerelő készlet
RO Set extractoare bucse și rulmenți
FR Kit d'outils pour l'installation et démontage du roulement
IT Kit per montaggio / smontaggio dei cuscinetti e manicotti
ES Juego de herramientas de cojinete de rueda
CN 轴承安装工具



26
PCS

FOR BEARINGS
AND BUSHINGS
DO ŁOŻYSK
I TULEI

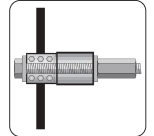

Ø 10, 12, 14, 16 mm (L=450 mm);
□ Yellow / Żółte: 46 x 36 mm, 58 x 48 mm, 70 x 60 mm, 82 x 72 mm, 44 x 34 mm, 56 x 46 mm, 68 x 58 mm, 80 x 70 mm, 54 x 44 mm, 66 x 56 mm, 78 x 68 mm;
□ Silver / Srebrne: 52 x 42 mm, 64 x 54 mm, 76 x 66 mm, 50 x 40 mm, 62 x 52 mm, 74 x 64 mm, 48 x 38 mm, 60 x 50 mm, 72 x 62 mm;
□ (2 PCS)

YATO

YT-25411

1

EN Bearing and bushing tool set
PL Zestaw do obsługi łożysk i tulei
DE Radlagerwerkzeug-Satz
RU Набор для обслуживания подшипников и втулок
CZ Sada pro údržbu ložisek a pouzder
HU Kerékcsapágy és persely szerelő készlet
RO Set extractoare bucse și rulmenți
FR Kit d'outils pour l'installation et démontage du roulement
IT Kit per montaggio / smontaggio dei cuscinetti e manicotti
ES Juego de herramientas de cojinete de rueda
CN 轴承安装工具

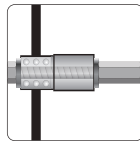

31
PCS

38
mm

FOR BEARINGS
AND BUSHINGS
DO ŁOŻYSK
I TULEI



EN Ball joint separator tool kit
PL Prasa śrubowa do sworzni i tulei
DE Schraubenpresse für Bolzen und Buchsen
RU Винтовой пресс для штифтов и втулок
CZ Šroubovací lis pro čepy a pouzdra
HU Gömbcsukló ki-beszerelő készlet
RO Presă pt. bucse și pivoți
FR Clé à douille universelle
IT Estrattore per perni e boccole
ES Prensa de husillo para pernos y casquillos
CN 球头拆卸组套

9
PCS

22
mm

130
mm

FOR PINS
AND BUSHINGS
DO SWORZNI
I TULEI



YATO

YT-25412

1



□ Ø 45/51 x 44 mm, Ø 57/63 x 44 mm; Ø 70/76 x 55 mm

YATO

YT-25413

1

EN Self-tightening pull clamp
PL Klamra blacharska samozaciskowa
DE Karosserie-Zugklemme
RU Зажим для кузовных работ
CZ Karosářská svěrka samosvorná k tahání
HU Őnszorító húzóató pófa egyenes
RO Clemă pt. tablă cu strângere automată
FR Pince de traction de tirage pour carrosserie
IT Pinza autoserrante per riparazione carrozzeria
ES Abrazadera de tiro para reparación de carrocería
CN 窄型张引夹

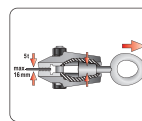

5t

125
mm

AUTO
TIGHTEN
SAMO-
ZACISKOWA

42x20mm



EN C-type self-tightening pull clamp
PL Klamra blacharska samozaciskowa typu „C”
DE Karosserie-Zugklemme Typ „C”
RU Зажим для кузовных работ типа „C”
CZ Karosářská svěrka samosvorná k tahání typ „C”
HU Őnszorító húzóató pófa öblös
RO Clemă pt. tablă cu strângere automată de tip „C”
FR Pince de traction de tirage pour carrosserie type C
IT Pinza autoserrante per riparazione carrozzeria tipo „C”
ES Abrazadera de tiro para reparación de carrocería tipo „C”
CN 宽型张引夹

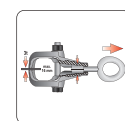

3t

142
mm

C
TYPE

35x15mm

AUTO
TIGHTEN
SAMO-
ZACISKOWA



YATO

YT-2542

L [mm]

125

12



YATO

YT-2543

L [mm]

142

10

EN Twist socket set
 PL Zestaw wykrętek do śrub
 DE Schraubenaudreher-Set
 RU Набор для извлечения обломанных болтов
 CZ Sada vyťahováku stržených šroubů
 HU Sérült csavar leszedő készlet

RO Set extractoare șuruburi
 FR Jeu d'extracteurs de vis cassées
 IT Set di estrattori per bulloni spanati
 ES Juego de extractores de pernos
 CN 螺栓取出器组套

10
PCS
3/8"
9.5 mm

HRC
52-55

CrMo

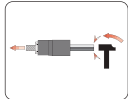

3/8" (9.5 mm): 10, 11, 12, 13, 14, 15, 16, 17, 19 mm;
 Ø 8 mm

YATO
YT-0603

20

EN Twist socket set
 PL Zestaw wykrętek do śrub
 DE Schraubenaudreher-Set
 RU Набор для извлечения обломанных болтов
 CZ Sada vyťahováku stržených šroubů
 HU Sérült csavar leszedő készlet

RO Set extractoare șuruburi
 FR Jeu d'extracteurs de vis cassées
 IT Set di estrattori per bulloni spanati
 ES Juego de extractores de pernos
 CN 螺栓取出器组套

10
PCS
3/8"
9.5 mm

HRC
52-55

CrMo

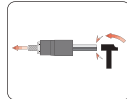

3/8" (9.5 mm): 9, 10, 11, 12, 13, 14, 15, 16, 17, 19 mm

YATO
YT-06031

20

EN Twist socket set
 PL Zestaw wykrętek do śrub
 DE Schraubenaudreher-Set
 RU Набор для извлечения обломанных болтов
 CZ Sada vyťahováku stržených šroubů
 HU Sérült csavar leszedő készlet
 RO Set extractoare șuruburi
 FR Jeu d'extracteurs de vis cassées
 IT Set di estrattori per bulloni spanati
 ES Juego de extractores de pernos
 CN 螺栓取出器组套

6
PCS

1/2"
12.7 mm

CrMo

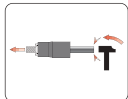

1/2" (12.5 mm): 17, 19, 21, 23, 27 mm;
 Ø 12 mm

YATO
YT-06032

20

EN Screw extractor set & HSS drill bits
 PL Wykrętki do zerwanych śrub i wiertła do metalu HSS
 DE Schraubenaudreher-Satz & HSS Bohrer
 RU Экстракторы и сверла по металлу HSS
 CZ Vrtáky do přetržených šroubu & vrtáky na kov HSS
 HU Törtszavar kiséző készlet + fúrószárak fémhez HSS
 RO Trusă extractoare șuruburi rupte și burghie pt. metal HSS
 FR Set d'extracteurs aux vis
 IT Estrattori di vite HSS
 ES Destornillador para tornillos arrancados & HSS brocas
 CN 断丝取出器组套

12
PCS

M3-M24

1.4-15
mm

HSS



No.	Ø [mm]	M	Ø [mm]
#1	1.4 - 3.6	3 - 6	1.8
#2	2.1 - 4.9	6 - 8	2.6
#3	3.1 - 6.5	8 - 11	3.7
#4	4.8 - 8.8	11 - 14	5.5
#5	6.2 - 11.0	14 - 18	7.0
#6	9.4 - 15.0	18 - 24	10.3



YATO
YT-0591

20/40

EN Universal extractor set
 PL Uniwersalny zestaw do wykręcania
 DE Gewindeausdreh-Satz
 RU Набор экстракторов для болтов и гаек
 CZ Nástrojová sada pro poškozené šrouby a matice
 HU Szerszámkészlet sérült csavarokhoz és anyákhoz
 RO Set universal de extras șuruburi
 FR Extracteurs universels de vis et d'écrous
 IT Set universale di cacciaviti
 ES Juego de extractores tornillos rotos
 CN 螺丝, 螺杆, 螺母取出器组套

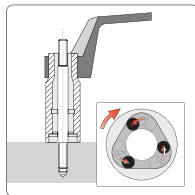

17
PCS

1/2"
12.7 mm

3/8"
9.5 mm

CrV
50BV30

CrMo
42



3/8" (9.5 mm): 9, 10, 11, 12, 13, 14, 16 (L=28); 19 mm (L=30); CrMo 42;
 1/2" (12.5 mm): 6, 8 (L=60 mm); 10, 12 mm (L=70 mm); CrV 50BV30;
 M3-M6, M6-M8, M8-M11, M11-M14, M14-M18; CrMo 42

YATO
YT-06033

10

EN Universal extractor set
 PL Uniwersalny zestaw do wykręcania
 DE Gewindeausdreh-Satz
 RU Набор экстракторов для болтов и гаек
 CZ Nástrojová sada pro poškozené šrouby a matice
 HU Szerszámkészlet sérült csavarokhoz és anyákhoz
 RO Set universal de extras șuruburi
 FR Extracteurs universels de vis et d'écrous
 IT Set universale di cacciaviti
 ES Juego de extractores tornillos rotos
 CN 螺丝螺母取出器

26
PCS

3/8"
9.5 mm

CrMo
35

CrMo
42

HSS
4341

HRC
47-50



1/4", 8 mm, 3/8", 10 mm, 11 mm, 12 mm, 1/2", 13 mm, 14 mm, 16 mm, 17 mm, 11/16", 19 mm; CrMo 42;
 M3-M6, M6-M8, M8-M11, M11-M14, M14-M18, M18-M24; CrMo 35;
 2.4, 3.2, 4.0, 6.4, 7.2, 9.5 mm; HSS 4341;
 1/4" (6.3 mm) x 3/8" (9.5 mm)

YATO
YT-05893

10

EN Twist socket set
PL Zestaw wykrętek do śrub
DE Schraubenausdreher-Set
RU Набор для извлечения обломанных болтов
CZ Sada vyťahováku stržených šroubů
HU Sérült csavar leszedő készlet
RO Set extractoare șuruburi
FR Jeu d'extracteurs de vis cassées
IT Set di estrattori per bulloni spanati
ES Juego de extractores de pernos
CN 螺栓取出器组套

16 PCS 72T CrMo 42 HRC 47-50

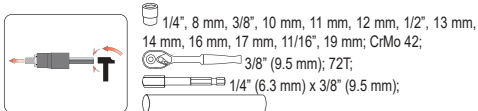

YATO **YT-05897** 10

EN Universal extractor set
PL Uniwersalny zestaw do wykręcania
DE Gewindeausdreh-Satz
RU Набор инструментов для поврежденных болтов и гаек
CZ Nástrojová sada pro poškozené šrouby a matice
HU Szerszámkészlet sérült csavarokhoz és anyákhoz
RO Set universal de extras șuruburi
FR Etablecer extractoare șuruburi si piulite
IT Set universale di cacciaviti
ES Extracteurs establecer vis et écrous
CN 破損螺母取出器

26 PCS 3/8" 9.5 mm HSS CrMo 42

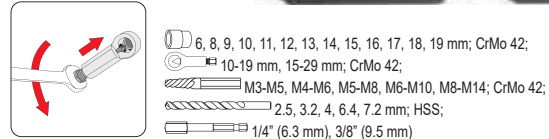

YATO **YT-06037** 10

EN Screw extractor set
PL Wykrętki do zerwanych śrub
DE Schraubenausdreher-Set
RU Набор для извлечения обломанных болтов
CZ Vrtáky do přetržených šroubů
HU Törtcsavar kiszedő készlet
RO Trusă extractoare șuruburi rupte
FR Set d'extracteurs aux vis
IT Estrattori di viti
ES Destornillador para tornillos arrancados
CN 断丝取出器

5 PCS 1/4" 6.3 mm HSS 4241



YATO **YT-06035** 40

Ø [mm] 0-6, 1-8, 2-10, 3-12, 4-14

EN Twist socket set
PL Zestaw wykrętek do śrub
DE Schraubenausdreher-Set
RU Набор для извлечения обломанных болтов
CZ Sada vyťahováku stržených šroubů
HU Sérült csavar leszedő készlet
RO Set extractoare șuruburi
FR Jeu d'extracteurs de vis cassées
IT Set di estrattori per bulloni spanati
ES Juego de extractores de pernos
CN 螺栓取出器组套

5 PCS 3/8" 9.5 mm CrMo



3/8" (9.5 mm): 10, 11, 13, 14, 16 mm

YATO **YT-06038** 10/20

EN Screw extractor set
PL Wykrętki do zerwanych śrub
DE Schraubenausdreher-Set
RU Набор для извлечения обломанных болтов
CZ Vrtáky do přetržených šroubů
HU Törtcsavar kiszedő készlet
RO Trusă extractoare șuruburi rupte
FR Set d'extracteurs aux vis
IT Estrattori di viti
ES Destornillador para tornillos arrancados
CN 断丝取出器组套

6 PCS



No.	Ø [mm]	L [mm]
#1	3-6	52
#2	6-8	58
#3	8-11	66
#4	11-14	75
#5	14-18	80
#6	18-25	88

YATO **YT-0590** 12/48

EN Tap socket set
PL Zestaw adapterów do gwintowników
DE Adaptersatz für Gewindebohrer
RU Набор адаптеров для метчиков
CZ Sada hlavice na závitníky
HU Menetfűró dugókulcs adapter készlet
RO Set tubulare pt. tarazi
FR Jeu d'adapteurs pour tarauds
IT Set di adattatori per madreviti
ES Juego de adaptadores para machos de roscar
CN 丝锥套筒组套

10 PCS 1/4" 6.3 mm 3/8" 9.5 mm CrV



1/4" (6.3 mm): #1, #2, #3, #3.5, #4, #4.5; 3/8" (9.5 mm): #5, #6, #7, #8

YATO **YT-29280** 10/40

1/4" (6.3 mm), 3/8" (9.5 mm)

EN Bolt extractor set
PL Zestaw wykrętek do szpilek
DE Schraubenausdreher-Set
RU Набор экстракторов для шпилек

CZ Souprava na demontáž závrtných šroubů
HU Csavarkihajító készlet
RO Set extractoare șuruburi deteriorate
FR Set d'extracteurs aux épingles

IT Set bussola estrattore per brugola
ES Juego de extractores de alfileres
CN 断丝取出器组套

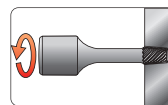

HRC 49-52 8660



6 PCS 3/8" 9.5 mm

YATO **YT-0623** 50

Ø [mm] 2, 3, 4, 6, 8, 10

5 PCS 1/2" 12.7 mm



YATO **YT-0624** 20

Ø [mm] 8, 10, 12, 14, 16

EN Bolt extractor set
 PL Zestaw wykrętek do szpilek
 DE Satz von Ausziehvorrichtungen für Stifte
 RU Набор экстракторов для шпилек
 CZ Souprava na demontáž závrtných šroubů
 HU Csavarkihajtó készlet

RO Set extractoare șuruburi deteriorate
 FR Set d'extracteurs aux épingles
 IT Set bussola estrattore per brugola
 ES Juego de extractores de alfileres
 CN 螺丝取出器

10
PCS
CrMo
42
HRC
50-53



3, 4, 5, 5.5, 6, 7, 8, 9, 10, 11 mm; 1/8", 5/32", 3/16", 7/32", 1/4", 9/32", 5/16", 11/32", 3/8", 13/32"

YATO
YT-05890 20

EN Bolt extractor set
 PL Zestaw wykrętek do szpilek
 DE Satz von Ausziehvorrichtungen für Stifte
 RU Набор экстракторов для шпилек
 CZ Souprava na demontáž závrtných šroubů
 HU Csavarkihajtó készlet

RO Set extractoare șuruburi deteriorate
 FR Set d'extracteurs aux épingles
 IT Set bussola estrattore per brugola
 ES Juego de extractores de alfileres
 CN 断丝取出器组套

25
PCS
CrV
50
3-23
mm
HRC
50-53



3, 4, 5, 5.5, 6, 7, 8, 9, 10, 11, 12, 13, 13.5, 14, 15, 16, 17, 17.5, 18, 19, 20, 21, 21.5, 22, 23 mm

YATO
YT-06034 10

EN Damaged bolt removal set
 PL Zestaw bitów do obrabionych śrub
 DE Schraubenausdreher-Bitsatz für beschädigte Schrauben
 RU Набор бит экстракторов для выкручивания винтов
 CZ Sada bitů pro obráběné šrouby
 HU Megmunkált csavar eltávolító készlet
 RO Set extractoare șuruburi deteriorate
 FR Jeu de extracteurs de vis
 IT Kit estrattori per viti bulloni danneggiati
 ES Conjunto de puntas para tornillos desgastados
 CN 紧固件拆卸特殊六角套筒旋头组套

8
PCS
1/4"
6.3mm
3/8"
9.5mm
AISI
S2
CrV



1/4" (6.3 mm): L=38 mm; H3, H4, H5, H6;
 3/8" (9.5 mm): L=50 mm; H7, H8, H9, H10

YATO
YT-04580 10/40

EN Damaged bolt removal set
 PL Zestaw bitów do obrabionych śrub
 DE Schraubenausdreher-Bitsatz für beschädigte Schrauben
 RU Набор бит экстракторов для выкручивания винтов
 CZ Sada bitů pro obráběné šrouby
 HU Megmunkált csavar eltávolító készlet
 RO Set extractoare șuruburi deteriorate
 FR Jeu de extracteurs de vis
 IT Kit estrattori per viti bulloni danneggiati
 ES Conjunto de puntas para tornillos desgastados
 CN 紧固件拆卸特殊星型套筒旋头组套

7
PCS
1/4"
6.3mm
AISI
S2
CrV



1/4" (6.3 mm): L=38 mm; TE10, TE15, TE20, TE25, TE27, TE30, TE40

YATO
YT-04581 15/60

EN Heavy duty nut splitter
 PL Zestaw przecinaków do nakrętek
 DE Meißelsatz für Schraubenmütern
 RU Набор зубил для гаек
 CZ Souprava sekáčů na matice
 HU Csavaranya-vágó

RO Set sp. part piulițe
 FR Set de burnis
 IT Set estrattore dado
 ES Juego de tajaderas para tuercas
 CN 螺母破拆组套

4
PCS
HRC
40-45
CrV

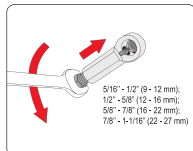

5/16" - 1/2" (9 - 12 mm);
 1/2" - 5/8" (12 - 16 mm);
 5/8" - 7/8" (16 - 22 mm);
 7/8" - 1 1/16" (22 - 27 mm)

YATO
YT-0585 10

EN Roller stud extractor set
 PL Zestaw wykrętek do szpilek
 DE Stehbolzen-Ausdreher Satz
 RU Набор ключей для снятия штифтов
 CZ Vytahovky závitových šteftů
 HU Komplet tűkihúzó készlet
 RO Set demont șuruburi rupte
 FR Extracteurs de goujons à rouleaux
 IT Estrattori a rulli per viti prigioniere
 ES Juego de extractores de espárragos
 CN 螺杆取出器

No.	● [mm]	D [mm]	L [mm]	A [mm]
#1	6	24	60	21
#2	8			
#3	10	28	70	
#4	12			

4
PCS
CrV
50BV30

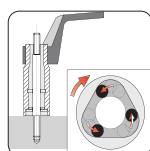
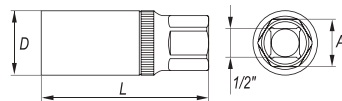

YATO
YT-0620 6/24

- EN Roller stud extractor set
- PL Zestaw wykrętków do szpilek
- DE Stehbolzen-Ausdreher Satz
- RU Набор ключей для снятия штифтов
- CZ Vytahovačky závitových štefů
- HU Komplet tükkihúzó készlet
- RO Set demontat șuruburi ruple
- FR Extracteurs de goujons à rouleaux
- IT Estrattori a rulli per viti prigioniere
- ES Juego de extractores de esparragos
- CN 螺杆取出器

11 PCS 3/8" 9.5 mm 1/2" 12.7 mm

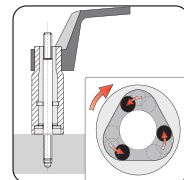

3/8" (9.5 mm): 5, 6; 1/2" (12.7 mm): 7, 8, 9, 10, 10.5, 11, 12; (21 mm): 14, 16 mm

YATO	Ø	
YT-06201	3/8" (9.5mm), 1/2" (12.7 mm)	5

- EN Stud extractor
- PL Wykrętko do śrub szpilek i nakrętek
- DE Stehbolzenausdreher
- RU Шпильковерт универсальный
- CZ Klíč na povolení závrtných šroubů
- HU Sérültefejtő csavar kiszedő
- RO Extractor pt. suruburi
- FR Extracteur de goujon, écrou ou boulon arrondis
- IT Stud estratore
- ES Extractor de esparragos
- CN 断螺丝取出器

1/2" 12.7mm

8.5-19 mm



YATO		
YT-06251		10/30

- EN Stud extractor
- PL Wykrętko do śrub szpilek i nakrętek
- DE Stehbolzenausdreher
- RU Шпильковерт универсальный
- CZ Klíč na povolení závrtných šroubů
- HU Sérültefejtő csavar kiszedő
- RO Extractor pt. suruburi
- FR Extracteur de goujon, écrou ou boulon arrondis
- IT Stud estratore
- ES Extractor de esparragos
- CN 断头螺丝取出器

FOR IMPACT TOOLS DO NARZĘDZI UDAROWYCH

6-11 mm

3/8" 9.5 mm

24 mm



HRC 40-45

CrMo



YATO		
YT-06255		6/36

- EN Stud extractor
- PL Wykrętko do śrub, szpilek i nakrętek
- DE Stehbolzenausdreher
- RU Шпильковерт универсальный
- CZ Klíč na povolení závrtných šroubů
- HU Sérültefejtő csavar kiszedő
- RO Extractor pt. suruburi
- FR Extracteur de goujon, écrou ou boulon arrondis
- IT Stud estratore
- ES Extractor de esparragos
- CN 断头螺丝取出器

FOR IMPACT TOOLS DO NARZĘDZI UDAROWYCH

6-11 mm

1/2" 12.7 mm

24 mm



HRC 40-45

CrMo



YATO		
YT-06256		6/36

- EN Tie rod end lifter
- PL Ściągacz do sworzni kulistych
- DE Universal-Kugelgelenk-Abzieher
- RU Съёмник шаровых опор
- CZ Stahovák kulových čepů řízení
- HU Gömbfej kinyomó
- RO Extractor pt. articulatii sferice
- FR Extracteur de rotue
- IT Estrattore per snodi sferici
- ES Extractor de pernos esféricos
- CN 球头拉拔器

19 mm

100 mm

20-60 mm

Ø 20 mm

40Cr



YATO	W [mm]	L [mm]	Ø [mm]	
YT-06122	19	100	20	20

- EN Tie rod end lifter
- PL Ściągacz do sworzni kulistych
- DE Universal-Kugelgelenk-Abzieher
- RU Съёмник шаровых опор
- CZ Stahovák kulových čepů řízení
- HU Gömbfej kinyomó
- RO Extractor pt. articulatii sferice
- FR Extracteur de rotue
- IT Estrattore per snodi sferici
- ES Extractor de pernos esféricos
- CN 球头拉拔器

19 mm

135 mm

15-50 mm

Ø 17.5 mm



YATO	W [mm]	L [mm]	Ø [mm]	
YT-0612	19	135	17.5	9/18

- EN Tie rod end lifter
- PL Ściągacz do sworzni kulistych
- DE Universal-Kugelgelenk-Abzieher
- RU Струбцина для шаровых опор
- CZ Stahovák kulových čepů řízení
- HU Gömbfej kinyomó
- RO Extractor pt. articulatii sferice
- FR Extracteur de rotue
- IT Estrattore per snodi sferici
- ES Extractor de pernos esféricos
- CN 球头取出器

19 mm

160 mm

35-80 mm

Ø 30 mm



YATO	W [mm]	L [mm]	Ø [mm]	
YT-06123	19	160	30	10

- EN Tie rod end lifter
- PL Ściągacz do sworzni kulistych
- DE Universal-Kugelgelenk-Abzieher
- RU Струбцина для шаровых опор
- CZ Stahovák kulových čepů řízení
- HU Gömbfej kinyomó
- RO Extractor pt. articulatii sferice
- FR Extracteur de rotue
- IT Estrattore per snodi sferici
- ES Extractor de pernos esféricos
- CN 球头拉拔器

16 mm

265 mm

275 mm



YATO	W [mm]	L [mm]	Ø [mm]	
YT-0613	16	265	17	20
YT-0614	16	275	20	20

EN Inner tie rod tool
 PL Klucz do drążków kierowniczych
 DE Spurstangenlenk Lösewerkzeug
 RU Ключ для шарнира рулевой рейки
 CZ Přípravek na axiální táhla
 HU Csukló szerelő

RO Tijă bielete direcție
 FR Clé pour pour rotules de direction
 IT Chiave per il tirante
 ES Extractor mecanismo de dirección
 CN 拉拔器

200 mm

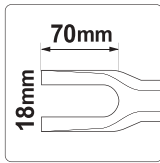

YATO	L [mm]	
YT-0615	200	18/36

EN Inner tie rod tool
 PL Klucz do drążków kierowniczych
 DE Spurstangen-Schlüssel
 RU Ключ для шарнира рулевой рейки
 CZ Přípravek na axiální táhla
 HU Axiál csukló szerelő
 RO Cheie bielete direcție
 FR Clé de biellette de direction
 IT Chiave per il tirante
 ES Extractor rótulas axiales
 CN 大机舵扳手

1 1/2" 12.7mm \varnothing 35-42 mm



YATO	
YT-06160	25

EN Inner tie rod tool
 PL Klucz do drążków kierowniczych
 DE Spurstangen-Schlüssel
 RU Ключ для шарнира рулевой рейки
 CZ Přípravek na axiální táhla
 HU Axiál csukló szerelő
 RO Cheie bielete direcție
 FR Clé de biellette de direction
 IT Chiave per il tirante
 ES Extractor rótulas axiales
 CN 方向机舵扳手

1 1/2" 12.7mm \varnothing 40-47 mm

CrMo



YATO	
YT-061602	30

EN Inner tie rod tool
 PL Klucz do drążków kierowniczych
 DE Spurstangen-Schlüssel
 RU Ключ для шарнира рулевой рейки
 CZ Přípravek na axiální táhla
 HU Axiál csukló szerelő
 RO Cheie bielete direcție
 FR Clé de biellette de direction
 IT Chiave per il tirante
 ES Extractor rótulas axiales
 CN 双四方滤清扳手

1 1/2" 12.7mm \varnothing 27-42 mm

CrMo



YATO	
YT-06162	10/20

EN Inner tie rod tool
 PL Klucz do drążków kierowniczych
 DE Spurstangen-Schlüssel
 RU Ключ для шарнира рулевой рейки
 CZ Přípravek na axiální táhla
 HU Axiál csukló szerelő
 RO Cheie bielete direcție
 FR Clé de biellette de direction
 IT Chiave per il tirante
 ES Extractor rótulas axiales
 CN 大机舵扳手

1 1/2" 12.7mm \varnothing 30-42 mm

CrMo



YATO	
YT-06163	40

EN Track rod end remover and installer set
 PL Zestaw kluczy do drążków kierowniczych
 DE Schlüsselset für Zahnstangenlenkung
 RU Набор ключей для рулевых тяг
 CZ Sada klíčů pro řeben řízení
 HU Kormányrúd telepítő készlet-eltávolító
 RO Set de chei pt bieletele de direcție
 FR Clé pour rotules de direction
 IT Set di chiavi suggerimenti smontaggio tiranti sterzo
 ES Herramienta de llaves para barras de dirección
 CN 轴接头工具组套

4 PCS \varnothing 30-45 mm



\varnothing 30-35mm, 35-40mm, 40-45mm

YATO	
YT-06155	4

EN Tie rod / ball joint tool kit
 PL Ściągacze do drążków
 DE Werkzeugsatz für Bremssattel
 RU Съёмники шаровых опор и рулевых наконечников
 CZ Stahováky táhel řízení
 HU Rúdlehúzó
 RO Set extractoare pt. bielete direcție
 FR Set d'extracteurs pour rotules de direction
 IT Set tiranti per estrattore
 ES Tensores para palancas
 CN 汽修工具

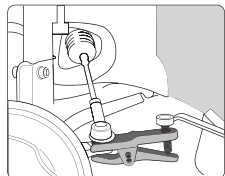

6 PCS



YATO	
YT-06157	5

EN Tie rod / ball joint tool kit
 PL Ściągacze do drążków
 DE Werkzeugsatz für Bremssattel
 RU Съёмники шаровых опор и рулевых наконечников
 CZ Stahováky táhel řízení
 HU Rúdlehúzó
 RO Set extractoare pt. bielete direcție
 FR Set d'extracteurs pour rotules de direction
 IT Set tiranti per estrattore
 ES Tensores para palancas
 CN 球头拉拔器组套

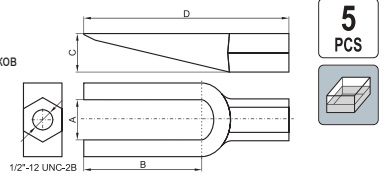

5 PCS

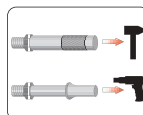

YATO	
YT-0616	10

EN Seal puller
PL Ściągacz do uszczeltek
DE Dichtungs-Abziehwerkzeug
RU Съемник прокладок
CZ Škrabka na těsnění
HU Tömítéslehúzó

RO Extractor pt. garnituri
FR Outil pour extraire les joints
IT Estrattore per guarnizioni
ES Tensor para juntas
CN 密封圈拉拔器

max Ø
85
mm

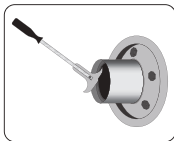

YATO
YT-0642

L [mm]
200

12/48

EN Universal hook and pick set
PL Zestaw haków i skrobaków z rękojeścią
DE Haken- und Schabersatz mit Griff
RU Набор крючков и скребков с ручкой
CZ Sada háků a škrabek s rukojetí
HU Fogantyús kampó- és kaparókészlet
RO Set universal extractoare garnituri
FR Kit de crochets et de grattoirs avec poignée
IT Set di ganci e raschietti con impugnatura
ES Juego de ganchos y raspadores con mango
CN 发动机清理工具

5
PCS

40Cr



200, 225, 23x220, 23x245 mm

YATO
YT-08422

6/24

EN Universal hook set
PL Zestaw haczyków z rękojeścią
DE Hakenset mit Handgriff
RU Набор крючков с рукояткой
CZ Sada háčků s rukojetí
HU Fogantyús kampó készlet

RO Set universal extractoare garnituri
FR Jeu de crochets avec manche
IT Set di ganci con maniglia
ES Set de ganchos para extracción con mango
CN 油封起子

7
PCS

40Cr



162, 205 mm

YATO
YT-08425

6/24

EN Universal hook set
PL Zestaw haczyków z rękojeścią
DE Hakenset mit Handgriff
RU Набор крючков с рукояткой
CZ Sada háčků s rukojetí
HU Fogantyús kampó készlet

RO Set universal extractoare garnituri
FR Jeu de crochets avec manche
IT Set di ganci con maniglia
ES Set de ganchos para extracción con mango
CN 油封起子

9
PCS

40Cr



162, 240 mm

YATO
YT-08426

6/12

EN Long reach hook and pick tool set
PL Zestaw haków długich z rękojeścią
DE Langhakensatz mit Griff
RU Набор длинных крючков с ручкой
CZ Sada dlouhých háků s rukojetí
HU Fogantyús hosszú kampókészlet

RO Set cârlige pt. extras garnituri
FR Kit de longs crochets avec poignée
IT Set di ganci lunghi con impugnatura
ES Juego de ganchos largos con mango
CN 油封起子

4
PCS

240
mm

40Cr



YATO
YT-08429

6/72

EN Long reach hook and pick tool set
PL Zestaw haków długich z rękojeścią
DE Langhakensatz mit Griff
RU Набор длинных крючков с ручкой
CZ Sada dlouhých háků s rukojetí
HU Fogantyús hosszú kampókészlet

RO Set cârlige pt. extras garnituri
FR Kit de longs crochets avec poignée
IT Set di ganci lunghi con impugnatura
ES Juego de ganchos largos con mango
CN 油封起子

6
PCS

240
mm

40Cr



YATO
YT-08428

6/48

- EN Seal remover and hose pick set
 PL Zestaw do demontażu uszczelnień i oringów
 DE Demontageset für Dichtungen und O-Ringe
 RU Набор для снятия уплотнений и уплотнительных колец
 CZ Sada pro demontáž těsnění a těsnících kroužků
 HU O-ring és tömítésleszedő készlet
- RO Set extractoare pt. garnituri
 FR Kit crochet pour joint torique
 IT Kit di strumenti per rimozione di guarnizioni e O-ring
 ES Juego de remoción de sellado y juntas tóricas
 CN 油封钩

6
PCS

SPECIAL SHAPE
SPECJALNY KSZTAŁT



120, 150, 160, 200, 210, 290 mm

YATO 

YT-08432  5

- EN Hook set for o-ring
 PL Zestaw haczyków do uszczelniaaczy
 DE Dichtungs-Haken-Satz
 RU Комплект крючков для герметиков
 HU Kampókészlet tömítésekhez
- RO Set carlige pt. o-ring
 FR Ensemble de crochet à joint d'étanchéité
 IT Set di ganci per sigillanti
 ES Set de ganchos para selladores
 CN 密封拉拔器

8
PCS

SPECIAL SHAPE
SPECJALNY KSZTAŁT



165, 225 mm

YATO 

YT-08431  48

- EN Bearing and bush driver set
 PL Zestaw do osadzania łożysk i uszczelniaaczy
 DE Lager- und Buchsentreiber-Satz
 RU Набор для установки подшипников и сальников
 CZ Sada pro montáž gufer a ložisek
 HU Csapógy és szimering beütő készlet
 RO Set pt. înlocuiri rulment, simering
 FR Outils pour montage des roulements et joint
 IT Set di tamponi per cuscinetti e guarnizioni
 ES Juego de conductores de bujes y sello de rodamientos
 CN 斜型培令套安装器

10
PCS

AI 

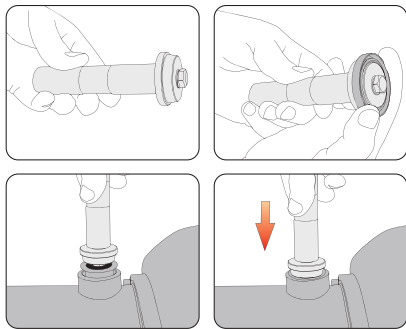

No.	Ø (mm)
01	40
02	44
03	50
04	59
05	63
06	65
07	72
08	76
09	81

YATO 

YT-0638  5/10

- EN Bearing and bush driver set
 PL Zestaw do osadzania łożysk i uszczelniaaczy
 DE Lager- und Buchsentreiber-Satz
 RU Набор для установки подшипников и сальников
 CZ Sada pro montáž gufer a ložisek
 HU Csapógy és szimering beütő készlet
 RO Set pt. înlocuiri rulment, simering
 FR Outils pour montage des roulements et joint
 IT Set di tamponi per cuscinetti e guarnizioni
 ES Juego de conductores de bujes y sello de rodamientos
 CN 斜型培令套安装器

17
PCS

AI 



No.	Ø (mm)	No.	Ø (mm)	No.	Ø (mm)
01	10x12	06	18x20	11	30x34
02	12x14	07	20x22	12	32x36
03	14x16	08	22x24	13	35x40
04	15x17	09	25x27	14	38x42
05	16x18	10	28x30		

YATO 

YT-25415  10

EN Car radio removal tool set
PL Zestaw do demontażu radioodbiorników samochodowych
DE Autoradio Demontage Werkzeugsatz
RU Набор для разборки авто-ресивера

CZ Sada k demontáží autorádií
HU Autórádió kiszereelő készlet
RO Trusa de scule pt. îndepărtat radio
FR Set d'outils pour dépose autoradio

IT Set estrattori per autoradio
ES Juego para el desmontaje de autorradio
CN 收音机拆卸组套

52
PCS

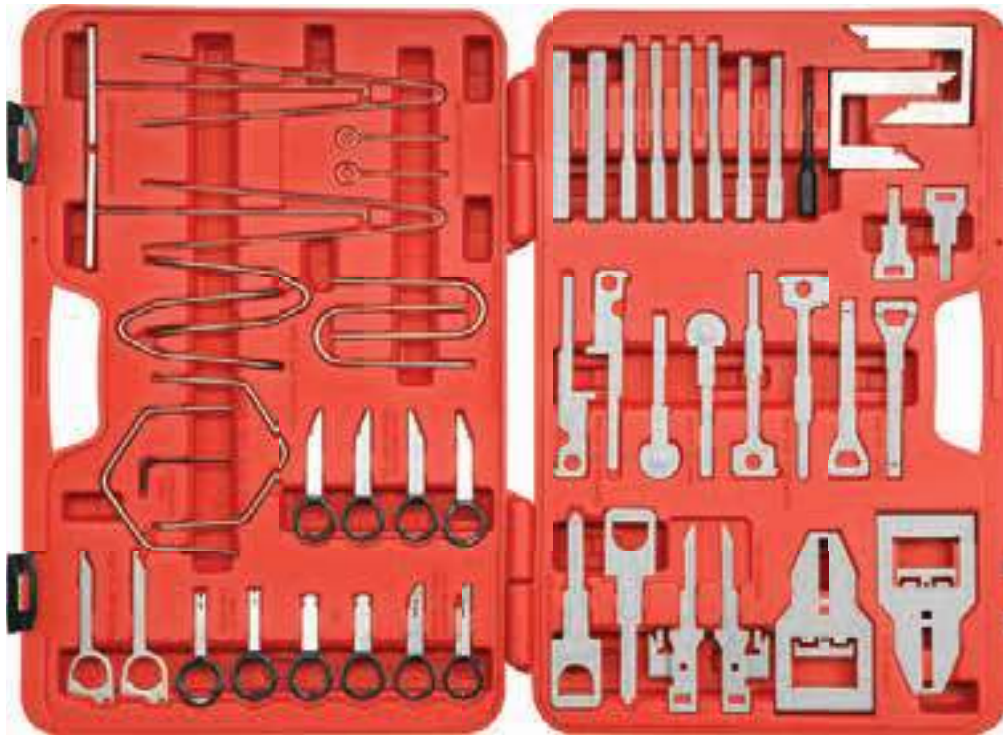

Included: radio removal keys: VW, Audi, Becker, Mercedes (4 PCS); Mercedes, Porsche, Becker (2 PCS); VW (2 PCS); new Becker (2 PCS); new Skoda (2 PCS); Fiat Brava (2 PCS); Mercedes-Benz, BMW (6 PCS); Kenwood II 1998-2001 (2 PCS); Sony II since 2002 (2 PCS); Kenwood III since 2002 (2 PCS); Pioneer, JVC (2 PCS); Sony I until 2001 (2 PCS); Panasonic (2 PCS); Kenwood I until 1998 (2 PCS); Kenwood Mask (2 PCS); new Clarion (2 PCS); old Clarion (2 PCS); Panasonic 2006 (2 PCS); Sony IDIC 2005 (2 PCS); radio removal U-hooks: Ford, VW, Audi, Grundig, Blaupunkt (2 PCS); new Blaupunkt (2 PCS); Opel (2 PCS); special pentagon wrench (BMW); allen hex wrench (BMW, Opel)
W zestawie: klucze do demontażu radia: VW, Audi, Becker, Mercedes (4 szt.); Mercedes, Porsche, Becker (2 szt.); VW (2 szt.); nowy Becker (2 szt.); nowa Skoda (2 szt.); Fiat Brava (2 szt.); Mercedes-Benz, BMW (6 szt.); Kenwood II 1998-2001 (2 szt.); Sony II od 2002 (2 szt.); Kenwood III od 2002 (2 szt.); Pioneer, JVC (2 szt.); Sony I do 2001 (2 szt.); Panasonic (2 szt.); Kenwood I do 1998 (2 szt.); Kenwood Mask (2 szt.); nowy Clarion (2 szt.); stary Clarion (2 szt.); Panasonic 2006 (2 szt.); Sony IDIC 2005 (2 szt.); haki do demontażu radia: Ford, VW, Audi, Grundig, Blaupunkt (2 szt.); nowy Blaupunkt; (2 szt.); Opel (2 szt.); specjalny klucz pięciokątny (BMW); klucz imbusowy (BMW, Opel)

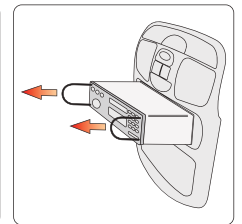
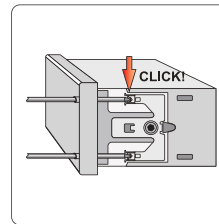
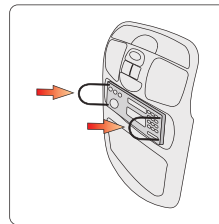

YATO
YT-0838

10

EN Door upholstery remover
PL Ściągacz do spinek tapicerki
DE Abziehvorrichtung für Polstererklammern
RU Съемник крепежа обивки

CZ Uvolňovač čalounění dveří
HU Kárpitkiszedő
RO Dispozitiv pt. scos capse de tapițerie
FR Spatule d'extraction de clips

IT Estrattore per la rimozione di graffette tappezzeria
ES Extractor de grapas de vestidura
CN 胶扣起子

SVCN



YATO	Internal width / Szerokość wewnętrzna [mm]	L [mm]	
YT-1370	6	100	12/120

YATO	Internal width / Szerokość wewnętrzna [mm]	L [mm]	
YT-1371	6.2	115	12/120



YATO	Internal width / Szerokość wewnętrzna [mm]	L [mm]	
YT-1372	10	115	12/120

YATO	Internal width / Szerokość wewnętrzna [mm]	L [mm]	
YT-1373	9.5	134	6/96

EN Scratch awl
PL Szpikulec prosty
DE Einfache Spicknadel
RU Прямое шило
CZ Šídlo rovné
HU Spékelőtű, egyenes

RO Dorn perforare drept
FR Brochette droite
IT Punteruolo piatto
ES Punzón recto
CN 锥子



SVCN



90°

SVCN



EN Hook bodkin
PL Szpikulec hakowy
DE Hakenspicknadel
RU Изогнутое шило
CZ Šídlo háčkové
HU Spékelőtű, horgos

RO Dispozitiv scos sigurante
FR Brochette coudée
IT Gancio punteruolo
ES Punzón encorvado
CN 油封拉拔器



YATO	L [mm]	
YT-1374	120	12/120

YATO	L [mm]	
YT-1375	125	12/120

EN Battery cap tool
 PL Ściągacz do klem akumulatora
 DE Abziehvorrichtung für Akkuklemmen
 RU Стяжка для клемм аккумулятора
 CZ Stahovák svorek akumulátoru
 HU Akkumulátor saru lehűző

RO Extractor pt. clemă acumulator
 FR Tournevis plat pour bouchons de batterie
 IT Batteria clem estrattore
 ES Extractor para los bornes de la batería
 CN 扁铲



YATO	Working width / Szerokość robocza [mm]	L [mm]	
YT-1378	18.5	100	12/120

EN Glass scraper
 PL Skrobak do szyby
 DE Scheibenkratzer
 RU Шабер для стекла
 CZ Škrabka na okna
 HU Jégkaparó
 RO Răzuitor geamuri
 FR Gratteur pour vitres

IT Raschietto per vetro
 ES Rascador para os vidrios
 CN 刮刀



YATO	Working width / Szerokość robocza [mm]	L [mm]	
YT-1379	39	200	6/72

EN Spare blades for glass scraper
 PL Ostrze do skrobaka do szyby
 DE Abbrechklängen
 RU Лезвия для универсальных ножей
 CZ Lomené ostří náhradní
 HU Törhető tartalékpenge

RO Lame de rezervă pt. răzuitor
 FR Lames pour gratteur pour vitres
 IT Lame per raschietto
 ES Filo partido de recambio
 CN 刮刀刀片配件



10
PCS

SK5



For YT-1379
 Dla YT-1379

YATO	Blade size / Rozmiar ostrza [mm]	
YT-13790	19x39	50

EN Flexible spinner handle
 PL Pokrętko elastyczne
 DE Elastischer Dreher

RU Эластичный вороток
 CZ Šroubovák ohebný
 HU Hajlékony csavarhúzó

RO Prelungitor flexibil
 FR Barre élastique
 IT Chiave flessibile

ES Llave flexible
 CN 套筒螺丝批

1/4"
6.3mm

SVCN



YATO	Ø	L [mm]	
YT-1381	1/4" (6.3 mm)	150	6/96

EN Flexible magnetic bit driver
 PL Pokrętko elastyczne do bitów
 DE Elastischer Dreher für Bits

RU Эластичный вороток для разряда битов
 CZ Šroubovák ohebný na bity
 HU Hajlékony csavarhúzó, hosszú

RO Măner flexibil pt. biți
 FR Barre élastique
 IT Chiave flessibile

ES Mango flexible para desarmadores
 CN 批头螺丝批



SVCN



YATO	Ø [mm]	L [mm]	
YT-1382	1/4" (6.3 mm)	380	6/72

EN Flexible magnetic pick up tool
 PL Elastyczny uchwyt magnetyczny
 DE Elastische Magnethalterung
 RU Эластичный магнитный держатель

CZ Ohebný magnetický držák
 HU Hajlékony csavarhúzó, hosszú, mágneses
 RO Măner magnetic flexibil
 FR Capteur magnétique

IT Mango flexible para desarmadores
 ES Mango magnético flexible
 CN 捡拾器



SVCN



YATO	L [mm]	
YT-1385	400	6/72

EN Door upholstery remover
 PL Ściągacz do spinek tapicerki
 DE Abziehvorrichtung für Polstererklammern
 RU Съемник крепежа обивки

CZ Uvolňovač čalounění dveří
 HU Kárpitkiszedő
 RO Dispozitiv pt. scos capse de tapiterie
 FR Spatule d'extraction de clips

IT Estrattore per la rimozione di graffette tappezzeria
 ES Extractor de grapas de vestidura
 CN 胶扣起子



YATO	L [mm]	
YT-0841	230	16/64

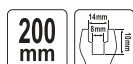

YATO	L [mm]	
YT-0842	200	25/100

EN Panel removal set
PL Ściągacze do tapicerki
DE Abziehvorrichtung für Polsterung
RU Съемник обивки
CZ Sada k demontáži čalounění
HU Kárpitlehúzó

RO Set extractoare tapiterie auto
FR Set d'extracteurs à la tapisserie
IT Leve in plastica per la tappezzeria
ES Tensores para las vestiduras
CN 面板拆卸组套

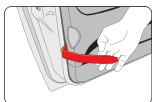

YATO
YT-0836

6/24

EN Panel removal set
PL Ściągacze do tapicerki
DE Abziehvorrichtung für Polsterung
RU Съемник обивки
CZ Sada k demontáži čalounění
HU Kárpitlehúzó

RO Set extractoare tapiterie auto
FR Set d'extracteurs à la tapisserie
IT Leve in plastica per la tappezzeria
ES Tensores para las vestiduras
CN 面板拆卸组套

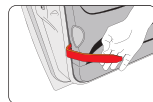

YATO
YT-0837

6/24

EN Panel removal set
PL Ściągacze do tapicerki
DE Abziehvorrichtung für Polsterung
RU Съемник обивки
CZ Sada k demontáži čalounění
HU Kárpitlehúzó

RO Set extractoare tapiterie auto
FR Set d'extracteurs à la tapisserie
IT Leve in plastica per la tappezzeria
ES Tensores para las vestiduras
CN 面板拆卸组套

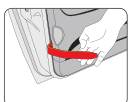

YATO
YT-0844

5/10

EN Panel removal tool kit
PL Zestaw do obsługi tapicerki
DE Servicesatz für Polsterung
RU Набор для обработки обивки
CZ Sada pro práci s čalouněním
HU Kárpiteszedő készlet

RO Set extractoare tapiterie auto
FR Kit d'outils pour démontage de garniture de voiture
IT Kit di strumenti per tappezzeria interni
ES Juego de manipulación de tapicería
CN 汽车面板拆卸工具组套

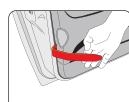

YATO
YT-08442

12

EN Panel removal set
PL Ściągacze do tapicerki
DE Abziehvorrichtung für Polsterung
RU Съемник обивки
CZ Sada k demontáži čalounění
HU Kárpitlehúzó

RO Set extractoare tapiterie auto
FR Set d'extracteurs à la tapisserie
IT Leve in plastica per la tappezzeria
ES Tensores para las vestiduras
CN 撬棍



YATO
YT-08443

10

EN Scraper set
PL Zestaw skrobaków do uszczelceł
DE Dichtungsschaber-Satz
RU Набор скребков для прокладок
CZ Sada diátek do těsnění
HU Tömítés kaparó készlet

RO Set raclete
FR Jeu de racloirs pour joints d'étanchéité
IT Set di raschietti per la rimozione di guarnizioni
ES Juego de rascadores para juntas
CN 铲刀



YATO
YT-08474

5/20

EN Plastic scraper set
PL Zestaw skrobaków plastikowych
DE Satz von Kunst-Stoffschabern
RU Набор пластмассовых шаберов
HU Műanyag vakaró készlet
RO Set de răzuitoare din plastic
FR Kit de grattoirs en plastique
IT Set di raschietto
ES Juego de rascadores de plástico
CN 塑料刮刀



3/4" (19 mm); 7/8" (22 mm); 1" (25 mm); 1 1/2" (37.5 mm)

YATO
YT-0847

L [mm]
265

6/36

EN Plastic chisel set
PL Przecinaki z tworzywa
DE Kunststoff-Meißel-Satz
RU Съемники пластиковые панелей облицовки
CZ Plastový kln pro autoklempife
HU Műanyag véső készlet
RO Set dalti din plastic
FR Outils pour le rembourrage de voiture
IT Scalpelli in plastica
ES Cinceles plásticos para molduras
CN 撬棍

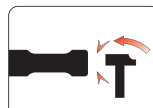

YATO
YT-08477

10/60

EN Lockout wedge set
 PL Kliny montażowe
 DE Zierleistenkeil mit Loch
 RU Клин удаления монтировки
 CZ Sada montážních klinů
 HU Szerelőék készlet
 RO Set pene de montaj
 FR Cales de montage
 IT Cunei di fissaggio
 ES Cuñas plásticas
 CN 塑料刹车块

4 PCS
 Ø 25 mm
 100x50 x25 mm



YATO

YT-67370

12/48

EN Lockout wedge set
 PL Kliny montażowe
 DE Zierleistenkeil mit Loch
 RU Клин удаления монтировки
 CZ Sada montážních klinů
 HU Szerelőék készlet
 RO Set pene de montaj
 FR Cales de montage
 IT Cunei di fissaggio
 ES Cuñas plásticas
 CN 撬棍

5 PCS
 NYLON



YATO

YT-67371

6/24

EN Quick release cut out tool
 PL Nóż do wycinania szyb
 DE Schneidmesser für Scheiben
 RU Нож для вырезания стекол
 CZ Nůž na vyřezávání skel
 HU Szélvédőkivágó kés
 RO Cuițit tăietor de geam
 FR Kit de découpe pare-brise
 IT Tagliolo per il vetro
 ES Cuchilla para cortar cristales
 CN 玻璃橡胶刮除器

X3 BLADES OSTRZA
 QUICK RELEASE SZYBKO-ZŁĄCZE
 AI K5



YATO

YT-0659

20/40

EN Spare blades for cut out tool
 PL Ostrza zapasowe do noża do wycinania szyb
 DE Abbrechklingenn
 RU Лезвия для ножей
 CZ Ostří náhradní
 HU Törhető tartalékpenge
 RO Lame de rezervă pt. cuițit sticlă
 FR Lames
 IT Lame di ricambio per coltello specialistica per tagliare vetri del auto
 ES Filo partido de recambio
 CN 玻璃橡胶刮除器刀片

X3 BLADES OSTRZA
 K5



For YT-0659
 Dia YT-0659
 3/4" (19 mm), 1" (25 mm), 1-1/2" (38 mm)

YATO

YT-06590

10/80

EN Windshield removal set
 PL Zestaw do demontażu szyb samochodowych
 DE Demontagesatz für Autoscheiben
 RU Набор для демонтажа автостекла
 CZ Souprava na demontáž autoskel
 HU Szélvédőcserélő szett

RO Set pt. demontarea geamurilor de mașină
 FR Kit pour démontage de vitres de voiture
 IT Set di strumenti di rimozione parabrezza
 ES Juego para desmontaje de cristales de coches
 CN 风挡玻璃拆卸组套

7 PCS
 HRC 38-42



YATO

YT-0845

10

EN Windscreen wiper arm removal tool
 PL Ściągacz do ramion wycieraczek
 DE Abziehvorrichtung für Scheibenwischerarme
 CZ Stahovák na ramínka stěračů
 HU Ablaktörölkar lehúzó
 RO Extractor pt. brațele ștergătoarelor
 FR Bord aux bras d'essuie-glace
 IT Estrattore di parabrezza tergicristallo braccio
 ES Herramienta para desmontaje de las plumas de los limpiaparabrisas
 CN 雨刷臂拆卸工具

ADJUSTABLE NASTAWNY
 CrMo



YATO

YT-0846

20/120

EN Two leg puller for widescreen wiper arms
 PL Ściągacz dwuramienny do ramion i wycieraczek
 DE Abzieher für Scheibenwischer
 RU Съёмник стеклоочистителя батареи
 CZ Dvouřuční stahovač pro ramena stěračů
 HU Kétkaros húzó az ablaktörölkarokhoz
 RO Extractor braț ștergător
 FR Extracteur d'essuie glaces
 IT Estrattore a due griffe per bracci tergicristalli
 ES Extractor tirador exterior para brazo del limpiaparabrisas
 CN 雨刷臂拉马

max 50 mm
 ADJUSTABLE NASTAWNY



YATO

YT-08461

15/60

EN Two leg puller for battery terminals and widescreen wiper arms
 PL Ściągacz dwuramienny do klem i ramion wycieraczek
 DE Abzieher für Wischerarm und Polklemmen
 RU Съёмник стеклоочистителя терминал батареи дворники
 CZ Stahovák na svorky akumulátoru a ramen stěračů
 HU Akkusaru és ablaktörölkar-lehúzó
 RO Extractor brat stergator, cleme baterie
 FR Extracteur d'essuie glaces et cosse de batterie
 IT Estrattore a due griffe per binding post e bracci dei tergicristalli
 ES Extractor tirador exterior para brazo del limpiaparabrisas, terminal de batería
 CN 电瓶接头拉马

5-30 mm
 ADJUSTABLE NASTAWNY



YATO

YT-25145

Ø [mm]

5-30

48

- EN Two leg puller for battery terminals and widescreen wiper arms
PL Ściągacz dwuramienny do klem i ramion wycieraczek
DE Abzieher für Wischerarm und Polklemmen
RU Съемник стеклоочистителя терминал батареи дворники
CZ Stahovák na svorky akumulátorů a ramen stěračů
HU Akkusaru és ablaktörőkar-lehúzó
RO Extractor brat stergator, cleme baterie
FR Extracteur d'essuie glaces et cosse de batterie
IT Estrattore a due griffe per binding post e bracci dei tergicristalli
ES Extractor tirador exterior para brazo del limpiaparabrisas, terminal de batería
CN 电瓶接头拉马



10-40 mm

ADJUSTABLE
NASTAWNY



YATO	Ø [mm]	
YT-08462	10-40	6/36

- EN Puller for ribbed drive pulley
PL Ściągacz kół pasowych wielorowkowych
DE Riemenscheiben Abzieher Werkzeug Keilriemenscheiben
RU Универсальный съёмник шкива
CZ Staviteľný stahovák drážkových femenic
HU Bordás szíjtárcsa lehúzó
RO Dispozitiv extras fullie
FR Universel extracteur de poulie d'entraînement cannelé
IT Estrattore puleggia motrice a coste
ES Extractor de polea acanalada
CN 皮带接头拉马



40-165 mm

3/8" 9,5 mm

17 mm

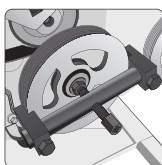

YATO	
YT-25480	10

- EN Vibration damper assembly tool set
PL Zestaw do obsługi tłumika drgań wiatu korbowego
DE Schwingungsdämpfer-Werkzeug-Satz
RU Набор для настройки демпфера вибрации коленчатого вала
CZ Sada na montáž a demontáž tlumiče vibrací klikové hřídele
HU Regzécstillapító rögzítő készlet
RO Trusă fixare amortizor de vibrații
FR Kit d'outils pour amortisseur de vibrations du vilebrequin
IT Set di utensili per smorzatore albero motore
ES Juego de herramientas para amortiguador de vibraciones
CN 曲轴正时固定器组套



1.8 TSI/TFSI: BYT, BZB, CABA, CABB, CABD, CDHA, CDHB, CJED, CJEE, CJSJ; 2.0 TFSI: CAWA, CAWB, CBFA, CCTA, CCZA, CCZB, CCZC, CCZD, CDA, CDAB, CDNB, CDNC, CDND, CESA, CETA, CFKA, CFPA, CGYA, CHHA, CHHB, CHHC, CHJA, CJK, CJSB, CJSJ, CJSK, CJXA, CJB, CJCX, CJK, CJKG, CJKH, CNCB, CNCD, CNCE, CPLA, CPSA, CULA, CULB, CULC, CYBB, CYGA, CYNB, CYP, CYRB, CYRC, CWZA, DAJA, DAJB, DEDA

YATO	
YT-06260	5

- EN Universal pulley puller
PL Ściągacz uniwersalny do kół rozrządu
DE Universal-Riemenscheiben-Abzieher
RU Съёмник шкивов универсальный
CZ Univerzální stahovák ozubených kol
HU Univerzális szíjtárcsa lehúzó
RO Extractor universal pt. roată distribuție
FR Extracteur de poulie universel
IT Estrattore universale per ruote di albero a camme
ES Extractor de poleas universal
CN 正时皮带轴承拉马

17 mm

50-80 mm

3 ARMS
RAMIONA

6 SETTINGS
USTAWIENIA

ADJUSTABLE
NASTAWNY

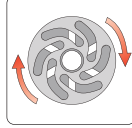

YATO	
YT-06341	10

- EN Spring clamp remover VAG
PL Ściągacz do obejm i sprężyn VAG
DE Auspuff Federklammer entferner / installer für VAG
RU Съёмник пружинных, хомутов систем выпуска VAG
CZ Přípravek na montáž a demontáž svorky výfuku VAG
HU Kipufogó rugó szerelő VAG
RO Dispozitiv montaj / demontaj esapament VAG
FR Tuyau d'échappement printemps pince outil de suppression pour VAG
IT Spring clamp rimozione VAG
ES Abrazadera de resorte herramienta de eliminación para VAG
CN 弹簧撑



17 mm

VAG



YATO	
YT-25331	12/24

- EN Ballancer puller and installer
PL Ściągacz kół pasowych z tłumikiem drgań
DE Riemenscheibenabzieher mit Schwingungsdämpfer
RU Съёмник шкива виброгасителя
CZ Stahovák femenic s tlumičem vibrací
HU Ékszíjtárcsa lehúzó készlet
RO Extractor și instalator de echilibrare
FR Extracteur de poulie de courroie avec amortisseur de vibrations
IT Estrattore per puleggia con smorzatore
ES Extractor de polea de la correa de transmisión con amortiguador de vibraciones
CN 正时皮带盘拆卸器

23 PCS



YATO	
YT-25483	5

5 PCS VAG

- EN Universal pulley puller
PL Ściągacz uniwersalny do kół rozrządu
DE Universal-Riemenscheiben-Abzieher
RU Съёмник шкивов универсальный
CZ Univerzální stahovák ozubených kol
HU Univerzális szíjtárcsa lehúzó
RO Extractor universal pt. roată distribuție
FR Extracteur de poulie universel
IT Estrattore universale per ruote di albero a camme
ES Extractor de poleas universal
CN 正时皮带轴承拉马

24 mm

60-90 mm

3 ARMS
RAMIONA

8 SETTINGS
USTAWIENIA



YATO	
YT-06340	10

- EN Camshaft balancer puller
PL Ściągacz wałki wyrównowazajacego
DE Ausgleichwellen-Abzieher
RU Съёмник балансировочного вала
CZ Stahovák hřídele vyvažovače
HU Kiegyenlítő tengely leszedő
RO Extractor arbore cu came
FR Extracteur de roue d'équilibrage
IT Estrattore per albero di bilanciamento
ES Extractor del eje de equilibrio
CN 大众平衡轴拉拔器

3 PCS

VAG

FOR CAMSHAFT
BALANCER
DO WAŁKI
WYRÓWNO-
WAZAJĄCEGO

FOR GASOLINE
ENGINES
DO SILNIKÓW
BENZYNOWYCH



VAG: Audi: A3 (since 2004), A4 & A5 (since 2008), TT (since 2007); Seat: Alhambra (since 2011), Altea (since 2005), Altea XL & Altea Freetrack (since 2007), Exeo (since 2009), Leon (since 2006), Toledo (since 2005); Volkswagen: Eos (since 2006), Golf (since 2004), Passat (since 2006), Passat CC (since 2009), Tiguan (since 2008)

YATO	
YT-06208	10

EN Camshaft sprocket pulley puller
 PL Ściągacz kół rozrządu
 DE Universal-Abzieher-Satz für Nockenwellenrad
 RU Набор съёмников для шкива распределителя
 CZ Stahovák na řemenice vačkové hřídele
 HU Vezérműtengely ékszíjtárcsa lehúzó
 RO Extractor role distribuție
 FR Extracteur de poulie d'arbres à cames
 IT Estrattore per ruote di albero a camme
 ES Extractor de poleas universal
 CN 凸轮轴链轮拉马

5 PCS 17 mm VAG



YATO
 YT-06342 8

EN Fuel tank sender unit spanner
 PL Klucz pazurowy do pompy paliwa
 DE Tankgeberschlüssel
 RU Ключ для крышки топливного насоса
 CZ Nastavitelný klíč na šrouby palivových nádrží
 HU Üzemanyagcső-lebontó készlet
 RO Cheie reglabila pt. pompa combustibil pe rezervor
 FR Outil de démontage de pompe
 IT Chiave smontaggio galleggiante serbatoio
 ES Llave de tres garras para aforador
 CN 油箱盖拆装工具

24 mm 75-160 mm 3



YATO
 YT-06288 20

EN Transmission line disconnect tool set
 PL Zestaw do rozłączania przewodów
 DE Werkzeugsatz zum Trennen von Kraftstoffleitungen
 RU Набор для рассоединения топливopроводов
 CZ Sada na rozpojování palivového potrubí
 HU Üzemanyagcső-lebontó készlet
 RO Set pt. deconectarea liniilor de combustibil
 FR Outil de déconnexion de ligne de transmission de carburant
 IT Set per scollegare i tubi di carburante
 ES Juego para desconectar conductos de combustible
 CN 油管拆卸组套

8 PCS FOR AIR CONDITIONING DO KLIMATYZACJI FOR FUEL LINES DO PRZEWODÓW PALIWA



YATO
 YT-0630 20

EN Universal pulley puller
 PL Ściągacz uniwersalny do kół rozrządu
 DE Universal-Riemenscheiben-Abzieher
 RU Съёмник шкивов универсальный
 CZ Univerzální stahovák ozubených kol
 HU Univerzális szíjtárcsa lehúzó
 RO Extractor universal pt. roată distribuție
 FR Extracteur de poulie universel
 IT Estrattore universale per ruote di albero a camme
 ES Extractor de poleas universal
 CN 正时皮带轴承拉马

14 mm 40-90 mm



YATO
 YT-06343 20

EN Water pump removal tool set
 PL Zestaw do demontażu pompy wodnej
 DE Demontagesatz für Wasserpumpe
 RU Набор для разборки водяного насоса
 CZ Sada pro demontáž vodního čerpadla
 HU Vízszivattyú leszerelő készlet
 RO Set demontat pompa de apa
 FR Kit de démontage de la pompe à eau
 IT Set per rimozione pompa d'acqua
 ES Juego para desmontar la bomba de agua
 CN 大众水泵拆卸组套

4 PCS



VW: Transporter T5, Tuareg
 AXD, AXE, BAC, BLJ, BLK, BPD, BPC, BPE (2003-)

YATO
 YT-05390 10

EN Transmission line disconnect tool set
 PL Zestaw do rozłączania przewodów
 DE Werkzeugsatz zum Trennen von Kraftstoffleitungen
 RU Набор для рассоединения топливopроводов
 CZ Sada na rozpojování palivového potrubí
 HU Üzemanyagcső-lebontó készlet
 RO Set pt. deconectarea liniilor de combustibil
 FR Outil de déconnexion de ligne de transmission de carburant
 IT Set per scollegare i tubi di carburante
 ES Juego para desconectar conductos de combustible
 CN 油管拆卸组套

23 PCS FOR AIR CONDITIONING DO KLIMATYZACJI FOR FUEL LINES DO PRZEWODÓW PALIWA



For fuel lines: 5/16" (8 mm), 3/8" (10 mm), 1/2" (12.5 mm), 5/8" (15.9 mm), 3/4" (19 mm), 7/8" (22.2 mm)
 For air conditioning: 3/8" (10 mm), 1/2" (12.5 mm), 5/8" (15.9 mm), 3/4" (19 mm)
 Do przewodów paliwa: 5/16" (8 mm), 3/8" (10 mm), 1/2" (12.5 mm), 5/8" (15.9 mm), 3/4" (19 mm), 7/8" (22.2 mm)
 Do klimatyzacji: 3/8" (10 mm), 1/2" (12.5 mm), 5/8" (15.9 mm), 3/4" (19 mm)

YATO
 YT-06301 10

EN Conditioning tool set
PL Zestaw nasadek do klimatyzacji
DE Ansatz-Set für Klimaanlage
RU Набор насадок для системы кондиционирования
CZ Sada zásuvek pro klimatizaci
HU Dugókulcs készlet klíma berendezéshez
RO Set biți pt. aer conditionat
FR Ensemble de douille pour la climatisation
IT Kit di attacchi per impianto aria condizionata
ES Juego de vasos para el aire acondicionado
CN 空调修理组套



1/4" (6.3 mm): SW12, SW15 (L=40 mm); CrV;
1/4" (6.3 mm): 2.2, 3.2 mm (L=50 mm); CrV;
1/4" (6.3 mm);
1/4" (6.3 mm): TS10, TS15, TS20, TS25, TS27, TS30, TS40 (L=25 mm); CrV

YATO	
YT-12007	10/20

EN Lock-ring pliers
PL Szczypce rozporowe do pierścieni osadzczych
DE Spreizzange für Schellen
RU Щипцы распорные для стяжных хомутов
CZ Kleště na hadicové spony
HU Seeger fogó

RO Clește pt. desfacerea colierelor
FR Pince tenaille pour les bagues de retenue
IT Pinza per rondelle elastiche scanalate
ES Alicates para abrazaderas
CN C 型扣钳

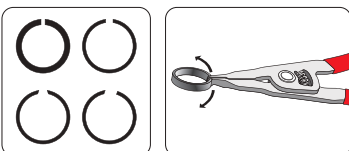

YATO	L [mm]
YT-0607	225

EN Fuel feed pipe remover
PL Szczypce do złączy przewodów paliwowych
DE Zange für Kraftstoffleitungen-Anschlüsse
RU Клещи для разъемов топливных магистралей
CZ Kleště do spojky palivového potrubí
HU Üzemanyagvezeték fogó
RO Clește pt. conducte de combustibil
FR Pince à raccord de carburant
IT Pinza per raccordi di tubi carburante
ES Pinzas para conectores de tubos de combustible
CN 汽车油管钳



YATO	
YT-06082	6/48

EN Digital thermometer
PL Termometr elektroniczny z sondą
DE Elektronisches Thermometer mit Sonde
RU Электронный термометр с зондом
CZ Elektronický teploměr se sondou
HU Elektromos hőmérő szondával
RO Termometru digital
FR Thermomètre électronique avec sonde
IT Termometro elettronico con sonda
ES Termómetro electrónico con sonda
CN 电子数显温度计

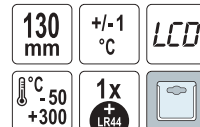

YATO	L [mm]
YT-72971	130

EN Fuel feel pipe pliers
PL Szczypce do złązek paliwowych
DE Zange für Tankverschlüsse
RU Щипцы для топливных соединений
CZ Kleště na spojky palivového systému
HU Üzemanyagvezeték fogó
RO Clește pt. conducte de combustibil
FR Pince tenaille pour connecteurs de carburant
IT Pinza per tubo carburante
ES Alicates para enchufes de combustible
CN 油管钳



YATO	L [mm]
YT-0608	10/40

EN CV boot clamp pliers
PL Szczypce do opasek osłony przegubu
DE Zange für Schellen der Gelenkabdeckung
RU Щипцы для хомутов крепления кожуха шарнира
CZ Kleště na spony manžety kloubu
HU Féltengely bilincs húzó fogó
RO Clește siguranta burdui planetara
FR Pince pour collier à recouvrement de joint
IT Pinza a morsetto per fascette pinzabili
ES Alicates para abrazadera de protección de la junta
CN 重型防尘套夹钳

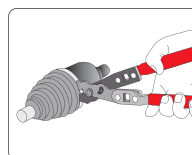
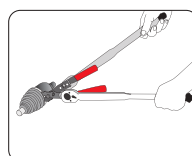

YATO	L [mm]
YT-0606	235

EN CV boot clamp pliers
 PL Szczypce do opasek osłony przegubu
 DE Zange für Schellen der Gelenkabdeckung
 RU Щипцы для хомутов крепления кожуха шарнира
 CZ Kleště na spony manžety kloubu
 HU Féltengely bilincs húzó fogó

RO Cleste siguranta burduf planetara
 FR Pince pour collier à recouvrement de joint
 IT Pinza a morsetto per fascette pinzabili
 ES Alicates para abrazadera de protección de la junta
 CN 重型防尘套夹钳

245 mm



YATO	L [mm]	
YT-06061	245	6/36

EN Hose clamp tool
 PL Szczypce do opasek zaciskowych
 DE Schlauchklemmen-Werkzeug
 RU Клещи натяжные для хомутов
 CZ Kleště na hadicové spony
 HU Tomióbilincs fogó
 RO Presă cleme furturn
 FR Pince de serrage
 IT Pinze per fascette
 ES Pinza para abrazaderas
 CN 喉箍拆卸钳

3/8" 14 mm 0-40 mm



YATO	Ø	
YT-06477	3/8" (9.5 mm)	10/40

EN CV joint clamp banding tool with ratchet
 PL Szczypce do opasek przegubów napędowych z grzechotką
 DE Achsmanschetten-Klemm-Zange mit Ratsche
 RU Приспособление для установки ленточных хомутов шруса
 CZ Kleště pro montáž manžet homokinetických kloubů s ráčnou
 HU Racsnis gumiharang bilincs fogó
 RO Clește cu clichet pt. coliere burduf planetară
 FR Pince pour colliers de soufflets de cardan avec cliquet
 IT Pinza stringi fascette per cuffie giunti omocineticici con cricchetto
 ES Alicata para abrazaderas de juntas homocinéticas con carraca
 CN 防尘套束装钳

max 10 mm CUT OFF ODCIĘCIE
 HARDENED STEEL STAL HARTOWANA



YATO	
YT-06064	6/36

EN Spark plug puller set VAG
 PL Zestaw ściągaczy do cewek zapłonowych VAG
 DE Abzieher-Satz Zündspulen VAG
 RU Набор съемников для катушек зажигания VAG
 CZ Sada stahováků zapalovací svíčky
 HU Gyújtótekercs lehúzó készlet
 RO Set extractoare bobine VAG
 FR Set d'extracteurs des bobines d'allumage
 IT Set per la rimozione rapida bobine di accensione nelle auto VAG
 ES Extractores bobinas de encendido grupo VAG
 CN 四件套火花塞维修工具

T type 1		Volkswagen FSI Golf / Bora 1998, Polo 2002, Touran 2004, New Beetle 2003, Passat 1997, T4+Audi A2 2001
T type 2		Sihiki/engines 6 cyl. 24V, 5 cyl. Golf / Bora 1998, Passat / Touareg 1997, Sharan 1996, Phaeton / Toureg 6 cyl. 2003, T5 z 6 cyl. silnikiem 2004
T type 3		Volkswagen silnik / engines 2.0 z bezp. wtrysk / direct injection, Touran 2004, Passat 2006, Audi z bezp.wtrysk / direct injection A3 2.0 2004, A6 3.2 2005
T type 4		Volkswagen z bezp. wtrysk / direct injection 2.0, Golf / Touran 2004, Passat 2006, Audi z bezp. wtrysk / direct injection, A3 2.0 2004, A6 3.2 2005



4 PCS VAG

VW, Audi, Skoda, Seat

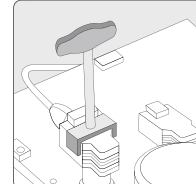

YATO	
YT-06205	10

EN CV boot clamp pliers
 PL Szczypce do opasek osłony przegubu
 DE Zange für Schellen der Gelenkabdeckung
 RU Щипцы для хомутов крепления кожуха шарнира
 CZ Kleště na spony manžety kloubu
 HU Féltengely bilincs húzó fogó
 RO Cleste siguranta burduf planetara
 FR Pince pour collier à recouvrement de joint
 IT Pinza a morsetto per fascette pinzabili
 ES Alicates para abrazadera de protección de la junta
 CN 重型防尘套夹钳

3/8" 270 mm 0-40 mm CrMo



YATO	L [mm]	
YT-06535	270	5/20

EN CV joint clamp banding tool
 PL Szczypce do opasek przegubów napędowych
 DE Achsmanschetten-Klemm-Zange
 RU Клещи для хомутов сшибов
 CZ Kleště pro montáž manžet homokinetických kloubů
 HU Gumiharang bilincs fogó
 RO Clește pt. coliere burduf planetară
 FR Pince pour colliers de soufflets de cardan
 IT Pinza stringi fascette per cuffie giunti omocineticici
 ES Alicata para abrazaderas de juntas homocinéticas
 CN 束装钳

max 10 mm CUT OFF ODCIĘCIE
 HARDENED STEEL STAL HARTOWANA



YATO	
YT-06062	6/36

EN Hose removing pliers
 PL Szczypce do zdejmowania przewodów
 DE Schlauch- und Kabellösezange
 RU Клещи для снятия изляции
 CZ Kleště na demontáž hadic
 HU Tomióbilincs fogó
 RO Clește pt. îndepărtat furturn
 FR Pince pour enlever les fils
 IT Pinza spelacavi universale
 ES Alicata de extracción de mangueras
 CN 油管分离钳

Ø 5-15 mm 5-30 mm



YATO	
YT-0657	6/36

EN Multi-purpose hose & wire pliers
PL Zestaw szczypsc do opasek i przewodów
DE Zangensatz für Schellen und Leitungen
RU Набор щипцов к хомутам и проводам
CZ Souprava kleští na spony a hadice
HU Fogókészlet bilincsekhez és vezetékhez
RO Set clești pt. coliere
FR Pince pour collier de serrage
IT Set pinze per il morsetto
ES Juego de pinzas para abrazaderas y cables
CN 多功能管夹钳



2 PCS
1/4" 6.3mm
3/4" 19mm
217 mm
254 mm

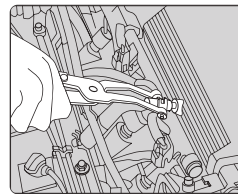

FOR ENGINE AIR PIPE
DO PRZEWODÓW POWIETRZNYCH LISTWY
WTRYSKOWEJ

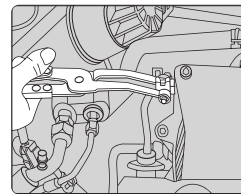

FOR ENGINE INTAKE AIR PIPE
DO PRZEWODÓW GUMOWYCH UKŁADU ZASILANIA

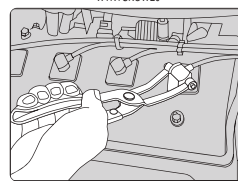

FOR SPARK PLUG LEAD
DO PRZEWODÓW ZAPŁONOWYCH

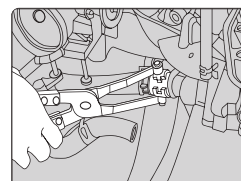

FOR COOLING WATER PIPE
DO PRZEWODÓW GUMOWYCH UKŁADU CHŁODZENIA

YATO	L [mm]	
YT-0645	217, 254	6/24

EN Hose clamp pliers
PL Szczypce do opasek zaciskowych rozprężnych
DE Zange zum Entspannen der Klemmschellen
RU Щипцы к хомутам зажимным распорным
CZ Kleště na samosvorné hadicové spony
HU Vízcsőbilincs fogó
RO Clește pt. coliere furtun
FR Pince pour collier de serrage
IT Set pinze per il morsetto
ES Pinzas para las abrazaderas de expansión
CN 管夹钳

+ SLOT
215 mm
2.0 mm
LOCK BLOKADA
AISI 4130



YATO	L [mm]	
YT-0646	215	12/72

EN Hose clamp pliers
PL Szczypce do opasek zaciskowych rozprężnych
DE Zange zum Entspannen der Klemmschellen
RU Щипцы к хомутам зажимным распорным
CZ Kleště na samosvorné hadicové spony
HU Vízcsőbilincs fogó
RO Clește pt. coliere furtun
FR Pince pour collier de serrage
IT Set pinze per il morsetto
ES Pinzas para las abrazaderas de expansión
CN 管夹钳

V SLOT
215 mm
4.5 mm
LOCK BLOKADA
AISI 4130



YATO	L [mm]	
YT-0647	215	12/72

EN Hose clamp pliers
PL Szczypce do opasek zaciskowych rozprężnych
DE Zange zum Entspannen der Klemmschellen
RU Щипцы к хомутам зажимным распорным
CZ Kleště na samosvorné hadicové spony
HU Vízcsőbilincs fogó
RO Clește pt. coliere furtun
FR Pince pour collier de serrage
IT Set pinze per il morsetto
ES Pinzas para las abrazaderas de expansión
CN 管夹钳

230 mm
4mm
12mm
HRC 40
LOCK BLOKADA



YATO	L [mm]	
YT-0650	230	6/36

EN Hose clamp pliers
PL Szczypce do opasek zaciskowych rozprężnych
DE Zange zum Entspannen der Klemmschellen
RU Щипцы к хомутам зажимным распорным
CZ Kleště na samosvorné hadicové spony
HU Vízcsőbilincs fogó
RO Clește pt. coliere furtun
FR Pince pour collier de serrage
IT Set pinze per il morsetto
ES Pinzas para las abrazaderas de expansión
CN 弯嘴管夹钳

45°
215 mm
4mm
12mm
LOCK BLOKADA
HRC 40



YATO	L [mm]	
YT-0651	215	6/36

EN Exhaust pipe clamp pliers
PL Szczypce do opasek wydechu
DE Auspuffschellen-Sicherungs zange
RU Щипцы для пружинных зажимов
CZ Kleště na spony výfuku
HU Kipufogóbilincs fogó
RO Clește pt. coliere teava de esapament
FR Pince pour collier d'échappement
IT Set pinze per il morsetto
ES Pinzas para bridas del tubo de escape
CN 排气管夹钳



max. 60mm
LOCK BLOKADA
300 mm

Peugeot, Citroën, Renault, Fiat, Ford

YATO	L [mm]	
YT-0652	300	10/20

- EN Valve stem seal pliers
- PL Szczypce do uszczelniaczy zaworowych, dlugie
- DE Lange Zange für Ventildichtringe
- RU Щипцы для замены маслосъемных колпачков
- CZ Kleště na těsnění ventilů, dlouhé
- HU Szelepszár szimering fogó hosszú
- RO Clește cu picior lung pt. sigilat supape
- FR Pince pour joints de queues de soupapes
- IT Pinza per tenuta anello stelo valvola
- ES Pinzas para juntas de vástago válvula
- CN 气门油封钳



270 mm

FOR VALVE STEM SEALS DO USZCZELNIACZY ZAWOROWYCH

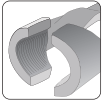

NON-SLIP ANTYPOSLIZGOWY

YATO	L [mm]	
YT-0648	270	12/60

- EN Pliers for band clips with a cord
- PL Szczypce z linką do opasek zaciskowych
- DE Zange für Rohrschellen mit Seil
- RU Щипцы к зажимным хомутам с тросиком
- CZ Kleště s lankem na samosvorné hadicové spony
- HU Flexibilis bowdenes vízcsőbilincs fogó
- RO Clește pt. cleme furtun
- FR Pince pour collier de serrage
- IT Pinza per il montaggio e lo smontaggio delle clips elastiche
- ES Pinzas para bandas de apretadura con cuerda
- CN 延长型弹性管夹钳

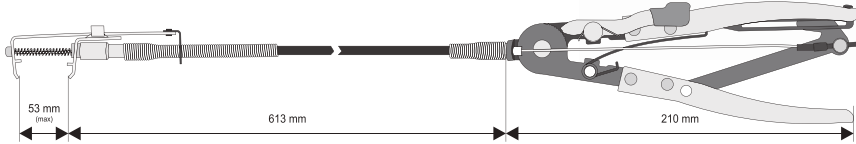

LOCK BLOKADA

CrMo 4140



YATO	
YT-0653	12/36

- EN Pliers for band clips with a cord
- PL Szczypce z linką do opasek zaciskowych
- DE Zange für Rohrschellen mit Seil
- RU Щипцы к зажимным хомутам с тросиком
- CZ Kleště s lankem na samosvorné hadicové spony
- HU Flexibilis bowdenes vízcsőbilincs fogó
- RO Clește pt. cleme furtun
- FR Pince pour collier de serrage
- IT Pinza per il montaggio e lo smontaggio delle clips elastiche
- ES Pinzas para bandas de apretadura con cuerda
- CN 延长型弹性管夹钳



LOCK BLOKADA

CrMo 4140

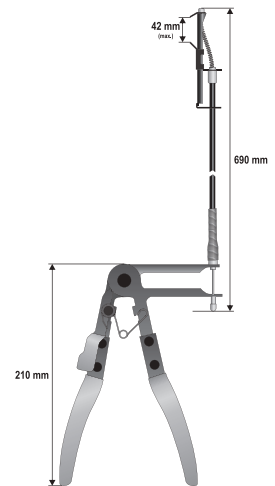

YATO	
YT-0677	25

- EN Hose clip pliers
- PL Szczypce do opasek zaciskowych typu CLIC i CLIC-R
- DE Schlauchklemmzange
- RU Плоскогубцы для зажима шлангов хомуты, CLIC-R
- CZ Kleště na hadicové spony
- HU Tömíbilincs fogó
- RO Clește pt. coliere furtun
- FR Pince pour collier de serrage
- IT Pinza per fascetta a CLIC e CLIC-R
- ES Alicates abrazaderas
- CN 压线钳



170 mm

CLIC CLIC-R



YATO	L [mm]	
YT-06475	170	10/60

- EN Tensioner pulley wrench
- PL Klucz do rolki napinającej
- DE Zahnriemen Spannrollenschlüssel
- RU Ключ для регулировки натяжного
- CZ Klič na napínák
- HU Bordás szij feszítő

- RO Cheie pt. rolă întinzătoare
- FR Clé pour rouleau de tension
- IT Chiave per il rullo tenditore
- ES Llave del tensor de la correa dentada
- CN 滑轮定时扳手

32 mm



YATO	
YT-06273	20/100

EN Universal pulley holder and fan clutch set
PL Klucz do napinania kola pasowego
DE Schlüssel zum Spannen der Riemenscheibe
RU Ключ для натяжения шкива
CZ Klíč k napínání řemenice
HU Szíjtárcsa feszítő kulcs

RO Cheie pt. întindere roată de curea
FR Clé universelle pour poulie
IT Blocca puleggia
ES Llave tensora para polea
CN 多用式皮带轮扳手

11 PCS
6-10 mm
8-11 mm
10-12 mm
11-16 mm

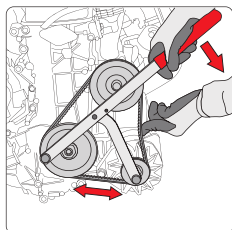

Ø 6-10 mm, Ø 8-11 mm, Ø 10-12 mm, Ø 11-16 mm

YATO
YT-0627 8

EN Serpentine belt tool set
PL Zestaw kluczy do napinaczy
DE Spannrollen-Schlüssel-Satz
RU Набор ключей для натяжения ремня
CZ Sada klíčů na napínací kladky
HU Ékszíj feszítő kulcs készlet
RO Cheie pt. curea de distribuție
FR Jeu de clés pour tendeurs
IT Set di chiavi per tendicinghia
ES Juego de llaves para tensores
CN 惰性皮带扳手调整组

8 PCS
3/8" 9.5 mm
1/2" 12.7 mm
CrV



3/8" (9.5 mm): 15, 16, 18 mm; CrV;
3/8" (9.5 mm): 13, 14, 15 mm; CrV;
590 mm

YATO
YT-06278 6/12

EN Ratcheting serpentine belt tool set
PL Zestaw kluczy z grzechotką do napinaczy
DE Ratschen Spannrollen-Schlüssel-Satz
RU Набор ключей для натяжения и замены поликлинового ремня
CZ Sada ráčnových klíčů na napínací kladky
HU Ékszíj feszítő racsnis kulcs készlet
RO Cheie cu clichet pt. curea accesorii
FR Jeu de clés à cliquet pour tendeurs
IT Set di chiavi con cricchetto per tendicinghia
ES Juego de llaves de carraca para tensores
CN 舵轮扳手组套

15 PCS
3/8" 9.5 mm
1/2" 12.7 mm
3/4" 19 mm
CrV 50BV30
CrV



19 mm: 13, 14, 15, 16, 17, 18, 19 mm (L=26 mm); CrV 50BV30;
19 mm: 3/8", 1/2", 3/4"; 40Cr;
3/8" (9.5 mm): 13, 14, 15 mm; 40Cr;
7/8"x19 mm; CrV;
7/8" (22.2 mm): 360 mm

YATO
YT-06279 10

EN Timing belt double pin wrenches tool set for VAG
PL Zestaw do obsługi rolek napinaczy VAG
DE Kit für die Bedienung von VAG-Spannrollen
RU Комплект для обслуживания роликов натяжителя VAG
CZ Sada pro údržbu napínacích kladek VAG
HU VAG feszítőgörgő szervizelő készlet
RO Trusă chei pt. role Intinzătoare curele VAG
FR Kit d'extraction de coussinet VAG
IT Set di attrezzi per rulli tenditori VAG
ES Juego para rodillos tensores VAG
CN 大众奥迪正时皮带双销扳手套装

6 PCS
VAG



YATO
YT-06275 5

EN Stretch fit belt tool kit
PL Zestaw do obsługi pasków elastycznych wielorowkowych
DE Werkzeugsatz für elastische Keilrippenriemen
RU Набор для использования гибких многоканавочных ремней
CZ Sada pro manipulaci s elastickými vícedrážkovými řemeny
HU Készlet több bordás ékszíj kezeléséhez
RO Set schimbare curele distribuție
FR Ensemble pour le montage et démontage des courroies élastiques à nervures multiples en V
IT Kit per montaggio / smontaggio delle cinghie elastiche
ES Kit de montaje de correas elásticas ranuradas
CN 正时皮带拆装辅助器

2 PCS
FOR ELASTIC STRAPS DO PASKÓW ELASTYCZNYCH
ASSEMBLY DISASSEMBLY MONTAJ DEMONTAJ



YATO
YT-05830 20/80

EN Piston ring compressor
 PL Zaciskacz do pierścieni
 DE Kolbenring-Spannband
 RU Оправка поршневых колец
 CZ Svěrka na kroužky
 HU Gyűrűbepattintó
 RO Presă segmenti auto
 FR Compresseur de segments de piston
 IT Morsetto per anelli
 ES Apretador de anillos
 CN 活塞环压缩机



SK5
 AISI 301

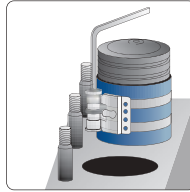

EN Piston rings pliers
 PL Szczypce do pierścieni tłokowych
 DE Kolbenringe Zange
 RU Клещи для установки поршневых колец
 CZ Kleště na pístní kroužky
 HU Dugattyűgyűrű fogók
 RO Clește pt. segmenti auto
 FR Pince pour anneau de piston
 IT Pinze per anelli di pistoni
 ES Alicates de anillo de pistón
 CN 活塞环钳



40-100 mm

YATO	Ø [mm]	H [mm]	
YT-0635	50-125	75	30/60
YT-0636	90-175	100	30/60
YT-0637	90-175	150	20/40

YATO	
YT-06377	5/50

EN Piston ring tool set
 PL Zestaw do obsługi pierścieni tłokowych
 DE Kolbenring-Wartungssatz
 RU Набор для обслуживания поршневых колец
 CZ Sada pro údržbu pístních kroužků
 HU Dugattyűgyűrű-szerelő készlet
 RO Set prese segmenti auto
 FR Kit d'outils d'entretien de segment de piston
 IT Set di attrezzi per fasce elastiche
 ES Kit de ensamblaje de anillos de pistón
 CN 活塞环拆装套装



10 PCS
 50-100 mm

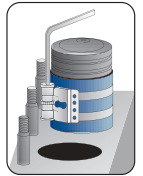

75 x 50-125 mm, 100 x 60-175 mm, 130 x 60-175 mm

YATO	Ø [mm]	
YT-06373	50-125, 60-175, 60-175	4

EN Cylinder honing tool
 PL Honownica do cylindrów
 DE Zylinder-Hongerät
 RU Хонинговальный станок

CZ Valcový honovací stroj
 HU Henger hónoló
 RO Dispozitiv pt. honuit cilindri
 FR Machine à roder des cylindres

IT Levigatrice per cilindri
 ES Herramienta para afilar cilindros
 CN 气缸打磨器

x3 HONES KAMENE
 ADJUSTABLE TENSION REGULOVANÝ NÁDRSK
 FLEXIBLE SHAFT ELASTYČNÝ WALEK



19-63 mm
 205 mm
 28x6 mm

32-89 mm
 230 mm
 51x7 mm

51-177 mm
 305 mm
 76x10 mm

YATO	L [mm]	
YT-05810	205	50/100

YATO	L [mm]	
YT-05811	230	50/100

YATO	L [mm]	
YT-05812	305	5/20

EN Cylinder hone stones
 PL Kamienie wymienne do honownicy
 DE Honsteine für Zylinder-Hongerät
 RU Комплект камней к хону

CZ Výmenné kameny do honovacího stroje
 HU Cserélhető kövek a hónolóhoz
 RO Pietre de schimb pt. dispozitiv de honuit
 FR Pierres interchangeable de la machine à roder

IT Set di pietre di ricambio per levigatrice
 ES Piedras de afilar de cilindro
 CN 磨石

3 PCS

28x6 mm
 For YT-05810
 Dla YT-05810



51x7 mm
 For YT-05811
 Dla YT-05811



76x10 mm
 For YT-05812
 Dla YT-05812



YATO		
YT-05815		50/200

YATO		
YT-05816		50/200



YATO		
YT-05817		50/100

- EN Cylinder hone tool set
- PL Zestaw do honowania cylindrów
- DE Zylinder-Honwerkzeug-Satz
- RU Набор для хонингования цилиндров
- CZ Sada pro honování válců
- HU Hengerhónoló készlet
- RO Set pt. honuit cilindri
- FR Jeu de pierrage de cylindres
- IT Set lappatore per cilindri
- ES Kit de lapeadores de cilindros
- CN 气缸打磨器



7 PCS	∅ 51-177 mm	FLEXIBLE SHAFT ELASTYCZNY WALEK	101x11 mm	102x11 mm
			P100	P220

P100 11x102 mm (3 PCS), P220 11x101 mm (3 PCS), P400 11x101 mm (3 PCS)

YATO 	
YT-05801	10

- EN Cylinder hone tool set
- PL Zestaw do honowania cylindrów
- DE Zylinder-Honwerkzeug-Satz
- RU Набор для хонингования цилиндров
- CZ Sada pro honování válců
- HU Hengerhónoló készlet
- RO Set pt. honuit cilindri
- FR Jeu de pierrage de cylindres
- IT Set lappatore per cilindri
- ES Kit de lapeadores de cilindros
- CN 气缸打磨器



7 PCS	∅ 20-50 mm	∅ 25-70 mm	∅ 32-89 mm	∅ 51-177 mm
	FLEXIBLE SHAFT ELASTYCZNY WALEK	28x5 mm	50x7 mm	76x10 mm
				100x11 mm
			P220	

Cylinder hones / Honowice: 28x5 mm P220 (2 PCS), 50x7 mm P220, 76x10 mm P220; Stones / Kamienie: 100x10 mm P220 (3 PCS)

YATO 	
YT-05802	10

- EN Cylinder hone tool set
- PL Zestaw do honowania cylindrów
- DE Zylinder-Honwerkzeug-Satz
- RU Набор для хонингования цилиндров
- CZ Sada pro honování válců
- HU Hengerhónoló készlet
- RO Set pt. honuit cilindri
- FR Jeu de pierrage de cylindres
- IT Set lappatore per cilindri
- ES Kit de lapeadores de cilindros
- CN 气缸打磨器



14 PCS	∅ 20-50 mm	∅ 25-70 mm	∅ 32-89 mm	FLEXIBLE SHAFT ELASTYCZNY WALEK
	28x5 mm	50x7 mm	P220	

P220 5x28 mm (8 PCS), P220 7x50 mm (3 PCS)

YATO 	
YT-05800	10

- EN Belt gauge
- PL Przyrząd do kontroli naciągu paska rozrządu
- DE Werkzeug Spannungsprüfer
- RU Прибор для проверки натяжения ремней
- CZ Připravek pro kontrolu napnutí rozvodového řemene
- HU Méter szíjfeszességet
- RO Tester întindere curea de distribuție cu gradatie
- FR Controleur de tension de courroie
- IT Strumento per il controllo rapido della tensione cinghia distribuzione
- ES Medidor para determinar la tensión de la correa
- CN 皮带张紧器

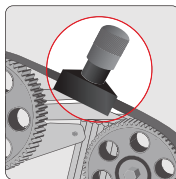

YATO

YT-06019



20

- EN Special socket antechamber injection pump
- PL Nasadka do komory wstępnej wtryskowej
- DE Kerbzahn-Einsatz für Vorkammer-Muttern an Dieselmotoren
- RU Сервисный ключ для форкамер
- CZ Klíč pro vstřikovací čerpadla
- HU Dugókulcs befecskendező szivattyúhoz
- RO Tubulără pt. anticameră pompă de injecție motoare
- FR Douille spéciale pipe d'admission
- IT Bussola per precamera
- ES Llave de vaso con dentado exterior para cámara de precombustión
- CN 奔驰火花塞外套筒



1/2"
12.7mm

28
mm

MERCEDES



- EN VAG high pressure pump pulley remover
- PL Ściągacz pompy wtryskowej VAG
- DE VAG Einspritzpumpenabzieher
- RU Съемник для ТНВД VAG
- CZ Stahovák vstřikovacího čerpadla VAG
- HU VAG befecskendező szivattyú leszedő
- RO Extractor pompă de injecție VAG
- FR Extracteur de pompe à injection VAG
- IT Estrattore per pompa di iniezione VAG
- ES Extractor de la bomba de inyección VAG
- CN 大众皮带盘扳手



15
mm

VAG



VAG
1.4 I, 1.6 I, 2.0 I TDI

YATO

YT-12005

15/60

YATO

YT-17527

20

- EN Twin cam locking tool for petrol and diesel engines
- PL Uniwersalna blokada wałków rozrządu
- DE Universelle Blockade der Steuerwellen
- RU Универсальный набор блокировки распределала
- CZ Univerzální přípravek na zablokování rozvodných hřídelí
- HU Univerzális vezérműtengely rögzítő
- RO Dispozit universal blocare distributie
- FR Outil de blocage d'arbre à cames
- IT Universale strumento di bloccaggio a camme
- ES Bloqueo universal de eje de distribución
- CN 凸轮止锁工具



DOHC
FOR DIESEL ENGINES DO SILNIKÓW DIEŚLA

FOR GASOLINE ENGINES DO SILNIKÓW BENZYNOWYCH

YATO

YT-06008

5

- EN Twin cam locking tool for petrol and diesel engines
- PL Uniwersalna blokada wałków rozrządu
- DE Universelle Blockade der Steuerwellen
- RU Универсальный набор блокировки распределала
- CZ Univerzální přípravek na zablokování rozvodných hřídelí
- HU Univerzális vezérműtengely rögzítő

- RO Dispozit universal blocare distributie
- FR Outil de blocage d'arbre à cames
- IT Universale strumento di bloccaggio a camme
- ES Bloqueo universal de eje de distribución
- CN 双凸齿轮固定器

FOR DIESEL ENGINES DO SILNIKÓW DIEŚLA

FOR GASOLINE ENGINES DO SILNIKÓW BENZYNOWYCH



- EN Diesel engine locking setting kit
- PL Blokada do kół rozrządu
- DE Blockade für Steuerrieder
- RU Блокировка к колесам распределительных механизмов
- CZ Souprava na fixaci rozvodových kol
- HU Diesel motor rögzítő készlet
- RO Set blocat distribuție motoare diesel
- FR Outil de blocage d'arbre à cames
- IT Cinghia di distribuzione di bloccaggio
- ES Bloqueo para las poleas del mecanismo de distribución
- CN 正时皮带更换工具

3
PCS

FOR VALVETRAIN DO UKŁADU ROZRZĄDU

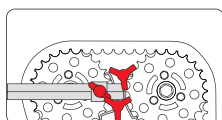
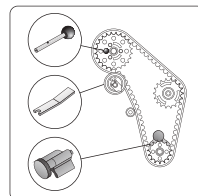

YATO

YT-06011

10/20

YATO

YT-0632

10/50

VW: Lupo, Polo, Golf, Bora, Beetle, Caddy, Sharan, Touran, Transporter (1998-2006);
Audi: A2, A3, A4, A6; Ford: Galaxy (2000-2006); Seat: Arosa, Ibiza, Cordoba, Leon, Toledo, Alhambra (1999-2005); Skoda: Fabia, Octavia (2000-2006)

3 i 4 cyl 1.2, 1.4, 1.9 TDI PD, 2.0 SDI, 2.0 TDI PD

EN Timing locking set
PL Zestaw blokad rozrządu
DE Nockenwellen-Arretierwerkzeugsatz
RU Комплект блокировки газораспределения
CZ Blokovací sada pro opravy rozvodů
HU Vezérműrögítő szerszámkészlet

RO Set blocare distribuție auto
FR Jeu d'outils de calage de distribution
IT Set di bloccaggio distribuzione auto
ES Juego de bloques de distribución
CN 正时工具组套



Peugeot: 208 1.0/1.2 VTI 2008; Citroen: C3 1.0/1.2 VTI 2012
EBO (ZMZ), EB2 (HMZ)

YATO YT-06023 5

EN Timing locking set
PL Zestaw blokad rozrządu
DE Nockenwellen-Arretierwerkzeugsatz
RU Комплект блокировки газораспределения

CZ Blokovací sada pro opravy rozvodů
HU Vezérműrögítő szerszámkészlet
RO Set blocare distribuție auto
FR Jeu d'outils de calage de distribution

IT Set di bloccaggio distribuzione auto
ES Juego de bloques de distribución
CN 正时工具组套



- Camshaft locking pin
- Crankshaft locking pin
- 2 camshaft locking clamps
- Trzpień blokujący wałek rozrządu
- Trzpień blokujący wał korbowy
- 2 zaciski blokujące walki rozrządu

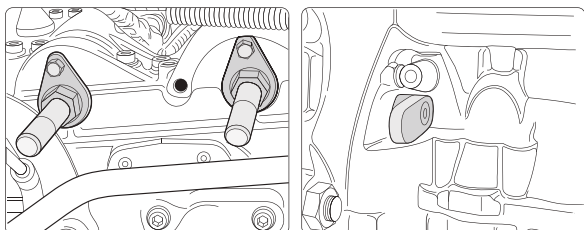

VW, Skoda, Seat 1.2 12V and 1.2 6V (HTP); VW: Polo; Seat: Ibiza, Cordoba; Skoda: Fabia HTP
AZQ, AWY, BMD, BME (02-07)

EN Timing locking set
PL Zestaw blokad rozrządu
DE Nockenwellen-Arretierwerkzeugsatz
RU Комплект блокировки газораспределения
CZ Blokovací sada pro opravy rozvodů
HU Vezérműrögítő szerszámkészlet

RO Set blocare distribuție auto
FR Jeu d'outils de calage de distribution
IT Set di bloccaggio distribuzione auto
ES Juego de bloques de distribución
CN 正时工具组套



Audi: A3 (03-10); Seat: Altea, Ibiza, Leon; Skoda: Fabia II (07-09), Octavia (04-09), Roomster (06-09), Superb (09-10); VW: Eos (06-09), Golf (03-09), Golf Plus (05-09), Jetta (06-09), Passat (05-09), Polo (02-08), Scirocco (09-10), Tiguan (07-09), Touran (03-09)
1.4 FSI (AXU, BKG, BLN), 1.4 TFSI (BLG, BMY, BWK, CAVA, CAVB, CAVC, CAVD, CAVF, CAXA, CAXC, CDGA), 1.6 FSI (BAG, BLF, BLP, BTS)

YATO YT-06017 10

EN Timing locking set
PL Zestaw blokad rozrządu
DE Nockenwellen-Arretierwerkzeugsatz
RU Комплект блокировки газораспределения
CZ Blokovací sada pro opravy rozvodů
HU Vezérműrögítő szerszámkészlet

RO Set blocare distribuție auto
FR Jeu d'outils de calage de distribution
IT Set di bloccaggio distribuzione auto
ES Juego de bloques de distribución
CN 正时工具组套

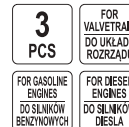

Renault: Twingo, Clio, Kangoo, Megane, Scenic, Laguna, Espace 1.2, 1.4, 1.6, 1.8, 2.0 16V (98-06), 1.5dCi; Nissan: Micra 1.5dCi, Kubistar 1.6 16V (03-06); Opel: Vivaro 2.0 16V (01-06)
Renault: D4F, K4J, K4M, F4P, F4R, F4Rt, F5R740, K9K; Nissan: K9K, K4M; Opel: F4R720

YATO YT-06014 10

EN Timing locking set
PL Zestaw blokad rozrządu
DE Nockenwellen-Arretierwerkzeugsatz
RU Комплект блокировки газораспределения

RO Set blocare distribuție auto
FR Jeu d'outils de calage de distribution
IT Set di bloccaggio distribuzione auto
ES Juego de bloques de distribución
CN 正时工具组套



YATO YT-06012 10

EN Timing locking set
PL Zestaw blokad rozrządu
DE Nockenwellen-Arretierwerkzeugsatz
RU Комплект блокировки газораспределения
CZ Blokovací sada pro opravy rozvodů
HU Vezérműrögítő szerszámkészlet

RO Set blocare distribuție auto
FR Jeu d'outils de calage de distribution
IT Set di bloccaggio distribuzione auto
ES Juego de bloques de distribución
CN 正时工具组套

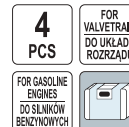

BMW: E30 318iS, E34 520i, E34 525i/525xi, E34 Serie 5, E36 318i/318iS/318ti, Z3 1.9, E36 320i, E36 Serie 3, E36 325i/325xi, E36 Z3 2.2i, E36 M3, E36/7 Z3 2.5i, E36 Z3 3.0i, E36/E46 328i, E39 520i, E39 525i, E39 530i, E46 320i/320Ci, E46 325i/325xi, E46 325Ci, E46 325ti, E46 330i/330xi, E46 330Ci, E53 X5 3.0i, E60 530i, E60/E61 520i, E60/E61 525i/525xi, E85 Z4 2.5i, E83 X3 2.5i, E83 X3 3.0i, E85 Z4 2.2i, E85 Z4 3.0i
M42B18, M44B19, M50B20, M50B24, M50B25, M52B21, S50B30US, M54B22, M54B25, M54B30



YATO YT-06332 10

EN Timing locking set
 PL Zestaw blokad rozrządu
 DE Nockenwellen-Arretierwerkzeugsatz
 RU Комплект блокировки газораспределения
 CZ Blokovací sada pro opravy rozvodů
 HU Vezérműrögzőlítő szerszámkészlet



RO Set blocare distribuție auto
 FR Jeu d'outils de calage de distribution
 IT Set di bloccaggio distribuzione auto
 ES Juego de bloques de distribución
 CN 正时工具组套

 Dacia: Duster (2010-2014), Logan & Logan MCV (2005-2013), Sandero (2008-2013); Nissan: Kubistar (2003-2009), Primastar (2002-2011); Opel: Vivaro (2002-2011); Renault: Avantime (2000-2003), Clio II (1998-2010), Clio III (2005-2013), Espace III (1998-2003), Espace IV (2002-2010), Kangoo (2001-2008), Kangoo II (2008-2013), Laguna (1998-2001), Laguna II (2001-2007), Laguna III (2007-2013), Megane & Megane Scenic (1999-2003), Megane II (2002-2009), Megane III (2008-2013), Modus (2004-2008), Modus & Grand Modus II (2008-2013), Scenic (1999-2003), Scenic & Grand Scenic II (2002-2009), Scenic & Grand Scenic III (2009-2013), Trafic II (2001-2011), Twingo II (2007-2014), Vel Satis (2000-2010)
 Nissan: K9K, K4M; Opel: FR4 720; Renault: D4F, K4J, K4M, F4P F4R, F4RT, F5R740, K9K

EN Timing locking set
 PL Zestaw blokad rozrządu
 DE Nockenwellen-Arretierwerkzeugsatz
 RU Комплект блокировки газораспределения
 CZ Blokovací sada pro opravy rozvodů
 HU Vezérműrögzőlítő szerszámkészlet
 RO Set blocare distribuție auto
 FR Jeu d'outils de calage de distribution
 IT Set di bloccaggio distribuzione auto
 ES Juego de bloques de distribución
 CN 正时工具组套



 Fiat: 500, Panda, Punto, Grande Punto, Albea, Linea, Bravo, Brava, Palio, Idea, Weekend, Siena, Stilo, Marea (97-10); Lancia: Ypsilon, Musa (96-10)
 1.2 16V: 176B9.000, 182B2.000, 188A5.000; 1.4 16V: 843A1.000, 169A3.000, 192B2.000, 198A1.000, 198A4.000, 199A6.000

EN Timing locking set
 PL Zestaw blokad rozrządu
 DE Nockenwellen-Arretierwerkzeugsatz
 RU Комплект блокировки газораспределения
 CZ Blokovací sada pro opravy rozvodů
 HU Vezérműrögzőlítő szerszámkészlet
 RO Set blocare distribuție auto
 FR Jeu d'outils de calage de distribution
 IT Set di bloccaggio distribuzione auto
 ES Juego de bloques de distribución
 CN 正时工具组套

 Opel: Agila, Astra G/H, Corsa, Corsa B, Combo C, Meriva, Tigra B
 1.0 12V, 1.0 16V, 1.2 16V, 1.4 16 V (chain); X10XE, Z10XE, Z10XEP, X12XE, Z12XE, Z14XEP

EN Timing locking set
 PL Zestaw blokad rozrządu
 DE Nockenwellen-Arretierwerkzeugsatz
 RU Комплект блокировки газораспределения
 CZ Blokovací sada pro opravy rozvodů
 HU Vezérműrögzőlítő szerszámkészlet

RO Set blocare distribuție auto
 FR Jeu d'outils de calage de distribution
 IT Set di bloccaggio distribuzione auto
 ES Juego de bloques de distribución
 CN 正时工具组套



 BMW: 520i E60 (04-08), Z4 2.0 E85 (04-08), X3 2.0i E83 (05-08), 118i E87 (04-07), 120i E87 (04-07), 316i E46 (01-05), 316 i Compact E46 (04-05), 318i E46 (01-07), 318i Compact E46 (01-05), 318i E90 (05-08), 320i E90 (05-08), 116i E81/E87 (03-08), 316i E46/E90 (01-08), 316Ci E46 (01-05), 128i E82 (07-08), 130i E81/E87 (05-08), 135iS E82 (07-08), 323i E90/91/92/93 (04-08), 325i/xi E90/91/92/93 (04-08), 328i/xi E90/91/92/93 (04-08), 330i/xi E90/91/92/93 (04-08), 335i/xi E90/91/92/93 (05-08), 523i/Li E60/E61 (04-08), 525 i/Li/xi E60/E61 (04-08), 528i/xi E60/E61 (06-08), 530i/xi E60/E61 (05-08), 535i/xi E60/E61 (06-08), X5 3.0 E70 (06-08), Z4 2.5/3.0 E85/E6 (05-08), 630 E63/E64 (04-08), 730i/Li E65/E66 (04-08), X3 2.5/3.0 E83 (06-08); BMW Mini: R55, R56 Cooper S (06-09), R56 Mini One (07-09); Peugeot: 207, 207 CC, 308 (07-09); Citroën: C4, C4 Picasso (08-09)
 N22/B12: N24-B18A, B20A, B20B; N40/N45/N45T/B16, N51/N52/N52K/N53/N54/N53/N54 (direct injections), N12/N14: EP3 (8FS), EP6 (5FW), EP6DT (5FX), EP6DTS (5FY); OEM: OEM119280, OEM115140, OEM113340, OEM119330



YATO  **YT-06326**  4



4
PCS
 FOR VALVETRAIN DO UKŁADU ROZRZĄDU
 FOR DIESEL ENGINES DO SILNIKÓW DIELA
 FOR GASOLINE ENGINES DO SILNIKÓW BENZYNOWYCH



YATO  **YT-06016**  10



5
PCS
 FOR VALVETRAIN DO UKŁADU ROZRZĄDU
 FOR GASOLINE ENGINES DO SILNIKÓW BENZYNOWYCH



YATO  **YT-06002**  10

5
PCS
 FOR VALVETRAIN DO UKŁADU ROZRZĄDU
 FOR DIESEL ENGINES DO SILNIKÓW BENZYNOWYCH





YATO  **YT-06004**  5

5
PCS
 FOR VALVETRAIN DO UKŁADU ROZRZĄDU
 FOR DIESEL ENGINES DO SILNIKÓW DIELA

EN Timing locking set
PL Zestaw blokad rozrządu
DE Nockenwellen-Arretierwerkzeugsatz
RU Комплект блокировки газораспределения
CZ Blokovací sada pro opravy rozvodů
HU Vezérműrögztű szerszámkészlet

RO Set blocare distribuție auto
FR Jeu d'outils de calage de distribution
IT Set di bloccaggio distribuzione auto
ES Juego de bloques de distribución
CN 正时工具组套

 Audi: A3 (since 2013) 1.2/1.4 TSI; Skoda: Citigo 1.0/1.0 Ecofuel/1.0 Green Tech, Octavia (since 2013); Seat: Leon (since 2013), Mii 1.0/1.0 Ecofuel/1.0 Ecomotive; VW: Golf VII (since 2012), Jetta (since 2012), Up 1.0/1.0 BlueMotion/1.0 Ecofuel

 1.0 CHYA, CHYB, CPGA, 1.2 TFSI: CJZA, CJZB, 1.4 TFSI: CMBA, CXSA, CHPA, 1.4 TGI: CPWA, 1.4 TSI Multi Fuel CPVA, CZDA, CZDB, CZDC, 1.4 Hybrid CRJA

EN Timing locking set
PL Zestaw blokad rozrządu
DE Nockenwellen-Arretierwerkzeugsatz
RU Комплект блокировки газораспределения
CZ Blokovací sada pro opravy rozvodů
HU Vezérműrögztű szerszámkészlet

RO Set blocare distribuție auto
FR Jeu d'outils de calage de distribution
IT Set di bloccaggio distribuzione auto
ES Juego de bloques de distribución
CN 正时工具组套

 Fiat: 500, Panda, Punto (10-16)

 312 A2 000, 312 A4 000, 312 A6 000, 199 B6 000 etc.

EN Timing locking set
PL Zestaw blokad rozrządu
DE Nockenwellen-Arretierwerkzeugsatz
RU Комплект блокировки газораспределения
CZ Blokovací sada pro opravy rozvodů
HU Vezérműrögztű szerszámkészlet

RO Set blocare distribuție auto
FR Jeu d'outils de calage de distribution
IT Set di bloccaggio distribuzione auto
ES Juego de bloques de distribución
CN 正时工具组套

 Opel

 LLWZ20DMH, Z20DM, Z20DMHRA420, Z20SI, Z20S3, Z20S4, Z20S5

EN Timing locking set
PL Zestaw blokad rozrządu
DE Nockenwellen-Arretierwerkzeugsatz
RU Комплект блокировки газораспределения
CZ Blokovací sada pro opravy rozvodů
HU Vezérműrögztű szerszámkészlet

RO Set blocare distribuție auto
FR Jeu d'outils de calage de distribution
IT Set di bloccaggio distribuzione auto
ES Juego de bloques de distribución
CN 正时工具组套

 Audi: A1, A1 Sportback, A3, A3 Cabrio, A3 Saloon, A3 Sportback, A4, A4 Allroad, A4 Quattro, A5, A5 Cabriolet, A5 Coupe, A5 Sportback, A6, TT, Q3, Q5; Seat: Alhambra, Ibiza, Leon, Leon ST; Skoda: Fabia III, Fabia III Estate, Octavia III, Rapid, Rapid Spaceback, Superb III; VW: Golf VI, Golf VII, Golf VII Estate, Golf VII SV/Sportsvan, Passat, Polo, Scirocco, Sharan II, Touran II, Tiguan

 1.4: CUSA, CUSB, CUTA; 1.6: CLHA, CLHB, CRKA, CRKB, CXXA, CXXB; 2.0: CKFB, CKFC, CRBC, CRBD, CRFA, CRFC, CRMB, CRLB, CRLC, CRVA, CRVC, CUAA, CUNA, CUPA, CUUA, CUUB, CUWA, DDA, CNHA, CNHC, CSUA, CSUB, CSUD, CSUE



6
PCS

VAG

FOR VALVETRAIN DO UKŁADU ROZRZĄDU

FOR GASOLINE ENGINES DO SILNIKÓW BENZYNOWYCH



YATO 

YT-06025

4



6
PCS

FOR VALVETRAIN DO UKŁADU ROZRZĄDU

FOR GASOLINE ENGINES DO SILNIKÓW BENZYNOWYCH



YATO 

YT-06331

10



6
PCS

FOR VALVETRAIN DO UKŁADU ROZRZĄDU

FOR DIESEL ENGINES DO SILNIKÓW DIEŚLA



YATO 

YT-060022

10





6
PCS

VAG

FOR VALVETRAIN DO UKŁADU ROZRZĄDU

FOR DIESEL ENGINES DO SILNIKÓW DIEŚLA



YATO 

YT-060176

10

EN Timing locking set
 PL Zestaw blokad rozrządu
 DE Nockenwellen-Arretierwerkzeugsatz
 RU Комплект блокировки газораспределения
 CZ Blokovačí sada pro opravy rozvodů
 HU Vezérműrögzőlő szerszámkészlet
 RO Set blocare distribuție auto
 FR Jeu d'outils de calage de distribution
 IT Set di bloccaggio distribuzione auto
 ES Juego de bloques de distribución
 CN 正时工具组套

6
PCS

FOR VALVETRAIN DO UKŁADU ROZRZĄDU

FOR DIESEL ENGINES DO SILNIKÓW DIELSA



Opel: Astra, Vectra, Signum, Zafira, 1.9 CDTi (04-06); Fiat: 1.9, 2.4 JTD; 16V, 20V; Alfa Romeo: 147, 156, GT 1.9 JTD 16V, 2.4 JTD 20V
 Z19DTH, Z19DT, 192 A5.000, 192 B1.000, 937 A4.000, 937 A5.000

YATO

YT-06013 10

EN Timing locking set
 PL Zestaw blokad rozrządu
 DE Nockenwellen-Arretierwerkzeugsatz
 RU Комплект блокировки газораспределения
 CZ Blokovačí sada pro opravy rozvodů
 HU Vezérműrögzőlő szerszámkészlet
 RO Set blocare distribuție auto
 FR Jeu d'outils de calage de distribution
 IT Set di bloccaggio distribuzione auto
 ES Juego de bloques de distribución
 CN 正时工具组套

6
PCS

1/2"
12,7mm

FOR VALVETRAIN DO UKŁADU ROZRZĄDU

FOR DIESEL ENGINES DO SILNIKÓW DIELSA



BMW: Serie 1 (E81, E82, E87, E88, F20), Serie 3 (E90, E91, E92, E93, F30), Serie 5 (E60, E61, F10, F11), X1 (E84), X3 (E83, F25)
 2.0 N47, N47S (2007-2010)

YATO

YT-06018 10

EN Timing locking set
 PL Zestaw blokad rozrządu
 DE Nockenwellen-Arretierwerkzeugsatz
 RU Комплект блокировки газораспределения
 CZ Blokovačí sada pro opravy rozvodů
 HU Vezérműrögzőlő szerszámkészlet
 RO Set blocare distribuție auto
 FR Jeu d'outils de calage de distribution
 IT Set di bloccaggio distribuzione auto
 ES Juego de bloques de distribución
 CN 正时工具组套



7
PCS

FOR VALVETRAIN DO UKŁADU ROZRZĄDU

FOR GASOLINE ENGINES DO SILNIKÓW BENZYNOWYCH

Opel: Adam, Ampera, Astra J, Corsa D, Meriva B, Mokka, Zafira C Tourer; Chevrolet: Aveo
 1.0 A10 XEP, 1.2 A12 XEL, 1.2 A12 XER, 1.4 A14 XFL, 1.4 A14 XEL, 1.4 A14 XER, 1.4 A14 NEL, 1.4 A14 NET

YATO

YT-06009 5

EN Timing locking set
 PL Zestaw blokad rozrządu
 DE Nockenwellen-Arretierwerkzeugsatz
 RU Комплект блокировки газораспределения
 CZ Blokovačí sada pro opravy rozvodů
 HU Vezérműrögzőlő szerszámkészlet
 RO Set blocare distribuție auto
 FR Jeu d'outils de calage de distribution
 IT Set di bloccaggio distribuzione auto
 ES Juego de bloques de distribución
 CN 正时工具组套



7
PCS

FOR VALVETRAIN DO UKŁADU ROZRZĄDU

FOR GASOLINE ENGINES DO SILNIKÓW BENZYNOWYCH

Opel: Astra G, H, Corsa D, Meriva (06-08), Vectra (06-08), Signum (06-08), Zafira (03-08); Chevrolet: Cruze, Orlando 1.4, 1.6, 1.8; Fiat: Croma; Alfa Romeo: 159
 Opel: 1.6-Z16LEL, Z16LER, Z16LET, Z16XE, Z16XER, 1.8-Z18XER; Chevrolet, Fiat, Alfa Romeo: 939A4.000

YATO

YT-06005 10

EN Timing locking set
 PL Zestaw blokad rozrządu
 DE Nockenwellen-Arretierwerkzeugsatz
 RU Комплект блокировки газораспределения
 CZ Blokovačí sada pro opravy rozvodů
 HU Vezérműrögzőlő szerszámkészlet
 RO Set blocare distribuție auto
 FR Jeu d'outils de calage de distribution
 IT Set di bloccaggio distribuzione auto
 ES Juego de bloques de distribución
 CN 正时工具组套



7
PCS

FOR VALVETRAIN DO UKŁADU ROZRZĄDU

FOR GASOLINE ENGINES DO SILNIKÓW BENZYNOWYCH

Ford: B-Max (since 2010), C-Max (03-12), Fiesta (since 2013), Galaxy (since 2010), Focus (04-15), Grand C-Max (since 2010), Kuga (since 2013), Mondeo (since 2010), S-Max (since 2010), Tourneo Connect (since 2013), Transit Connect (since 2013); Volvo: S60 Cross Country T4 (11-15), S80 GTDi T3 (10-15), V40 GTDi T4 (12-15), V60 GTDi T4F (11-15), V70 T2/T3/T4 (10-15)
 HXJA, HXJB, HXDA, IQDA, IQDB, PNBA, RHBA, SIDA, 1.6Ti-VCT FFV, PNDA, JTWB, JTWA, JTDB, JTDA, JQDB, JQDA, IQJA, B4164T4, B4164T3, B4164T2, B4164T, JQMA, JQMB, JTMA, XTDA, MUDA, JTJA, JTBA, JTBB, KGBA, JOGA

YATO

YT-06029 5



EN Timing locking set
PL Zestaw blokad rozrządu
DE Nockenwellen-Arretierwerkzeugsatz
RU Комплект блокировки газораспределения
CZ Blokovací sada pro opravy rozvodů
HU Vezérműrögztűlő szerszámkészlet

RO Set blocare distribuție auto
FR Jeu d'outils de calage de distribution
IT Set di bloccaggio distribuzione auto
ES Juego de bloques de distribución
CN 正时工具组套

 BMW: 2.0 d & 3.0 d: 118d E8 & 120d E87 (2003-2007), 318d/tD E46/E90/E91 (2000-2008), 320d E46/E90/E91 (1997-2008), 320cd E46/E90/E91 (1997-2008), 325d E90/91/92/93 (2006-2010), 330d E46/E90/91/92/93 & 330cd E46/E90/91/92/93 & 330cd E46/E90/91/92/93 (1998-2008), 335d E90/91/92 (2006-2010), 520d E39/E60/61 (1999-2010), 525d E39/E60/61 (1999-2010), 525xd E39/E60/61 (1999-2010), 530d E39/E60/61 (1998-2010), 530xd (E39/E60/61 (1998-2010), 535d E60/61 (2004-2010), 635d E63/E64 (2004-2010), 730d E38/E65/66 (1998-2008), X3 2.0d E83 (2003-2007), X3 3.0d E83 (2003-2010), X5 3.0d E53/E70 (2000-2010); Land Rover: Freelander 2.0 Td4 (2000-2006); Land Rover/Range Rover: 3.0 Td6 (2002-2006); Opel: Omega B (2001-2003)
 M47, M47TU, M47T2, M57, M57TU, M57TU2, Y25DT

EN Timing locking set
PL Zestaw blokad rozrządu
DE Nockenwellen-Arretierwerkzeugsatz
RU Комплект блокировки газораспределения
CZ Blokovací sada pro opravy rozvodů
HU Vezérműrögztűlő szerszámkészlet

RO Set blocare distribuție auto
FR Jeu d'outils de calage de distribution
IT Set di bloccaggio distribuzione auto
ES Juego de bloques de distribución
CN 正时工具组套

 Opel; Renault: Clio, Espace, Kangoo, Master, Megane, Safrane, Scenic, Spider, R5, R9, R11, R19, R21, R25, Trafic, Twingo
 Opel: DF7, E5F, E6J, E7F, E7J, K7M, F1N, F2N+R, F3N, F3P, F3R, J5R, J5T, J6R, J7R, J7T, DF4, F7P, F7R, F8M, F8Q, F9Q, J8S, G8T, S8U, S9U, S9W; Renault: 1.2, 1.4, 1.6, 1.7, 1.8, 2.0, 2.2, 1.2 16 V, 1.8 16 V, 2.0 16 V, 1.9 D, 1.9 TD, 1.9 dTi, 2.1 D, 2.1 Turbo, 2.2 D, 2.2 TD, 2.5 D, 2.5 TD, 2.8 D, 2.8 Turbo

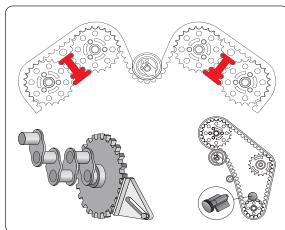

EN Timing locking set
PL Zestaw blokad rozrządu
DE Nockenwellen-Arretierwerkzeugsatz
RU Комплект блокировки газораспределения
CZ Blokovací sada pro opravy rozvodů
HU Vezérműrögztűlő szerszámkészlet

RO Set blocare distribuție auto
FR Jeu d'outils de calage de distribution
IT Set di bloccaggio distribuzione auto
ES Juego de bloques de distribución
CN 正时工具组套



 Citroen: Berlingo, Dispatch, Relay, Synergie, Santia, Xsara, ZX; Fiat: Ducato, Ulysse; Ford: Isuzu; Opel: Astra, Calibra, Cavalier, Omega, Sintra, Vectra, Zafira; Peugeot: 205, 305, 306, 309, 406, 605, 806, Boxer, Expert, Partner 1.9 D, Talbot; Rover: 25, 45, 75, 200, 214, 216, 218, 414, 416, BRM; Saab: 900-9000; Volkswagen: Bora, Golf, Lupo, Polo, Passat
 Citroen: Berlingo 1.9 D, Dispatch 1.9 D/TD-FSO 1.9 D, Relay 1.9 D/TD, Synergie 1.9/2.0 T, Santia 1.9/2.0 D/TD/HDI, Xsara 1.9/2.0 D/HDI, ZX 1.9 D/TD, most diesels; Fiat: Ducato 2.0 D, Ulysse 1.8/2.0 Turbo; Ford: most diesels; Isuzu: 1.5/1.7 diesel engines; Opel: Astra G 1.4/1.6/1.8 16V (>1994), 1.7 TD, 2.0 16 V, Calibra 2.5/2.5/2.6 V6, Cavalier 2.5 V6, Omega B 2.5/2.6/3.0/3.2 V6, Sintra 3.0 V6, Vectra 1.6, 1.8/2.0 16V (>1995), A 2.5/2.6 V6, Zafira 1.6/1.8 16V; 1.6/1.7 diesel engines, 1.2/1.4/1.6/1.8/2.0 OHC petrol engines; Peugeot: 205 1.6/1.8/1.9 D, 305 1.6/1.8/1.9 D, 306 1.8/1.9 D/TD, 309 1.6/1.9 D-4.5 1.6/1.9D, 406 1.9 D, 605 2.0 D/TD, 806 1.9T D, Boxer 1.9/2.0 D/TD, Expert 1.9 D, Partner 1.9 D, Talbot (Express D, Horizon D-J5 D, Solara); Rover: 25 1.4/1.6/1.8/VVC, 45 1.4/1.6/1.8, 75 1.8, 200 Vi, 214 16V, 216 16V/Cabrio/Coupe, 218 Coupe, 414 16V, 416 16V, BRM 1.8V; Volkswagen: Bora 1.9 TDI, Golf 1.9 TDI, Lupo 1.2/1.4/3.0 TDI, Polo 1.4 TDI, Passat 1.9 TDI

EN Timing locking set
PL Zestaw blokad rozrządu
DE Nockenwellen-Arretierwerkzeugsatz
RU Комплект блокировки газораспределения
CZ Blokovací sada pro opravy rozvodů
HU Vezérműrögztűlő szerszámkészlet
RO Set blocare distribuție auto
FR Jeu d'outils de calage de distribution
IT Set di bloccaggio distribuzione auto
ES Juego de bloques de distribución
CN 正时工具组套

 Ford: Galaxy 2.0, Focus 2.0, Mondeo, S-Max 2.0
 MGDA, TNBA, TNWA, TNWB, TPBA, TPWA, XQDA



7
PCS
FOR VALVETRAIN DO UKŁADU ROZRZĄDU
FOR DIESEL ENGINES DO SILNIKÓW DIELSA

YATO
YT-06333 5



7
PCS
FOR VALVETRAIN DO UKŁADU ROZRZĄDU
FOR DIESEL ENGINES DO SILNIKÓW DIELSA
FOR GASOLINE ENGINES DO SILNIKÓW BENZYNOWYCH

YATO
YT-06325 10



8
PCS
AI

YATO
YT-0633 16



8
PCS
FOR VALVETRAIN DO UKŁADU ROZRZĄDU
FOR GASOLINE ENGINES DO SILNIKÓW BENZYNOWYCH

YATO
YT-06026 5

- EN Timing locking set
- PL Zestaw blokad rozrządu
- DE Nockenwellen-Arretierwerkzeugsatz
- RU Комплект блокировки газораспределения
- CZ Blokovací sada pro opravy rozvodů
- HU Vezérműrögztítő szerszámkészlet
- RO Set blocare distribuție auto
- FR Jeu d'outils de calage de distribution
- IT Set di bloccaggio distribuzione auto
- ES Juego de bloques de distribución
- CN 正时工具组套

Ford: B-Max (12-15), C-Max (03-07), C-Max (07-10), C-Max (10-15), Fiesta (08-15), Focus (04-15), Galaxy (10-15), Grand C-Max (10-15), Kuga (13-15), Tourneo Connect (13-15), Grand Tourneo Connect (13-15), S-Max (10-15), Transit Connect (13-15); Mazda: 5 (CW) (10-15), 6 (GH) (10-13); Volvo: S60 (10-11); S80 (09-14), V40 Cross Country (10-14), V60 (10-14), V70 (09-14), XC60 (09-14)

1.6: B4164T, B4164T2, B4164T3, HXDA, HXDB, HXJA, HXJB, IQDA, IQDB, IQJA, IQDA, JQDA, JQDB, JQGA, JQMA, JQMB, JTDA, JTDB, JTJA, JTMA, JTWB, MUDA, PNDA, RVJA, SIDA, U5JA, XTDA; 2.0: B4204T6, B4204T7, B4204T7 (MZRDIDS), MGD A, MZR2.0 (LF), R9DA, TNBA, TNBB, TNWA, TPBA, TPWA, ZQDA

- EN Timing locking set
- PL Zestaw blokad rozrządu
- DE Nockenwellen-Arretierwerkzeugsatz
- RU Комплект блокировки газораспределения
- CZ Blokovací sada pro opravy rozvodů
- HU Vezérműrögztítő szerszámkészlet
- RO Set blocare distribuție auto
- FR Jeu d'outils de calage de distribution
- IT Set di bloccaggio distribuzione auto
- ES Juego de bloques de distribución
- CN 正时工具组套

VAG: Audi: A3 (03-10); Seat: Altea, Ibiza, Leon; Skoda: Fabia II (07-09), Octavia (04-09), Roomster (06-09), Superb (09-10); VW: Eos (06-09), Golf (03-09), Golf Plus (05-09), Jetta (06-09), Passat (05-09), Polo (02-08), Scirocco (09-10), Tiguan (07-09), Touran (03-09)

1.4 FSI: AXU, BKG, BLN; 1.4 TFSI: BLG, BMY, BWK, CAVA, CAVB, CAVC, CAVD, CAVF, CAXA, CAXC, CDGA; 1.6 FSI: BAG, BLF, BLP, BTS

- EN Timing locking set
- PL Zestaw blokad rozrządu
- DE Nockenwellen-Arretierwerkzeugsatz
- RU Комплект блокировки газораспределения
- CZ Blokovací sada pro opravy rozvodů
- HU Vezérműrögztítő szerszámkészlet
- RO Set blocare distribuție auto
- FR Jeu d'outils de calage de distribution
- IT Set di bloccaggio distribuzione auto
- ES Juego de bloques de distribución
- CN 正时工具组套

Fiat: Ducato 1.9D / TD, Punto 1.7D / TD, Tempra 1.9TD, Tipo 1.9D

149B1.000, 160A6.000, 160A7.000, 160D1.000, 176A3.000, 176A5.000, 176B3.000, 230A2.000, 230A3.000, 230A4.000, 280A1.000

- EN Timing locking set
- PL Zestaw blokad rozrządu
- DE Nockenwellen-Arretierwerkzeugsatz
- RU Комплект блокировки газораспределения
- CZ Blokovací sada pro opravy rozvodů
- HU Vezérműrögztítő szerszámkészlet
- RO Set blocare distribuție auto
- FR Jeu d'outils de calage de distribution
- IT Set di bloccaggio distribuzione auto
- ES Juego de bloques de distribución
- CN 正时工具组套

BMW: 316i, 316i Compact, 318i, 320i, 323i, 325i, 328i, 330i, 518i, 520i, 523i, 525i, 528i, 728i, 730i

M52TU, M54, M56, M40, M42, M43, M44, M50, M52



8
PCS

FOR VALVETRAIN DO UKŁADU ROZRZĄDU

FOR GASOLINE ENGINES DO SILNIKÓW BENZYNOWYCH

YATO
YT-06028

5



8
PCS

+/-
0.01
mm

VAG

FOR VALVETRAIN DO UKŁADU ROZRZĄDU

FOR GASOLINE ENGINES DO SILNIKÓW BENZYNOWYCH

YATO
YT-06328

5



8
PCS

FOR VALVETRAIN DO UKŁADU ROZRZĄDU

FOR DIESEL ENGINES DO SILNIKÓW DZIELA

YATO
YT-06323

5



9
PCS

FOR VALVETRAIN DO UKŁADU ROZRZĄDU

FOR GASOLINE ENGINES DO SILNIKÓW BENZYNOWYCH

YATO
YT-06022

1

- EN Timing locking set
- PL Zestaw blokad rozrządu
- DE Nockenwellen-Arretierwerkzeugsatz
- RU Комплект блокировки газораспределения
- CZ Blokovací sada pro opravy rozvodů
- HU Vezérműrögztűlő szerszámkészlet
- RO Set blocare distribuție auto
- FR Jeu d'outils de calage de distribution
- IT Set di bloccaggio distribuzione auto
- ES Juego de bloques de distribución
- CN 正时工具组套



9
PCS

FOR VALVETRAIN
DO UKŁADU
ROZRZĄDU

FOR GASOLINE
ENGINES
DO SILNIKÓW
BENZYNOWYCH

Clio II, Megane / Scenic, Megane II, Scenic II, Laguna, Laguna II, Espace (since 1998)
 1.8 16 V F4P 720, 722, 760; 2.0 Turbo 16 V F4R 700, 701, 712, 713, 714, 715, 720, 722, 730, 732, 740, 741, 744, 746, 770, 771, 776, 780, 784, 786, 787, 790, 791, 792, 794, 795, 796, 797, 820, 830

YATO
YT-06327

5

- EN Timing locking set
- PL Zestaw blokad rozrządu
- DE Nockenwellen-Arretierwerkzeugsatz
- RU Комплект блокировки газораспределения
- CZ Blokovací sada pro opravy rozvodů
- HU Vezérműrögztűlő szerszámkészlet
- RO Set blocare distribuție auto
- FR Jeu d'outils de calage de distribution
- IT Set di bloccaggio distribuzione auto
- ES Juego de bloques de distribución
- CN 正时工具组套



9
PCS

FOR VALVETRAIN
DO UKŁADU
ROZRZĄDU

FOR GASOLINE
ENGINES
DO SILNIKÓW
BENZYNOWYCH

Ford: Cougar, Fiesta/Courier, Focus/C-Max, Fusion, Galaxy, Mondeo, Puma, S-Max, Tourneo Connect, Transit Connect
 IQDA, IQDB, JQDA, JQDB, JQGA, JQJA, JQMA, JQMB, JTBA, JTBB, JTDA, JTDB, JTJA, JTMA, JTWA, JTWB, KGBA, MUDA, PNDA, XTDA

YATO
YT-060261

10

- EN Timing locking set
- PL Zestaw blokad rozrządu
- DE Nockenwellen-Arretierwerkzeugsatz
- RU Комплект блокировки газораспределения
- CZ Blokovací sada pro opravy rozvodů
- HU Vezérműrögztűlő szerszámkészlet
- RO Set blocare distribuție auto
- FR Jeu d'outils de calage de distribution
- IT Set di bloccaggio distribuzione auto
- ES Juego de bloques de distribución
- CN 正时工具组套



9
PCS

FOR VALVETRAIN
DO UKŁADU
ROZRZĄDU

FOR DIESEL
ENGINES
DO SILNIKÓW
DZIEŁA

Nissan: Primastar (2006-), Qashqai (2007-); Renault: Espace/Grand Espace (2006-), Grand Scenic II (2006-), Koleos (2008-), Laguna II (2005-), Laguna III (2007-), Latitude (2010-), Megane II (2006-), Megane III (2009-), Scenic, Trafic (2008-), Vel Satis (2005-)
 Nissan: NV400 (2011-): 2.3 CDTi R9M, X-Trial (2007-); 2.0 DCi M9R; Opel: Movano B (2010-): 2.3 CDTi, Vivaro (2006-): 2.0 CDTi/ecoFlex; Renault: Grand Scenic III (2009-): 2.0DCi M9R, Master III (2010-): 2.3 DCi M9T

YATO
YT-06010

5

EN Timing locking set
 PL Zestaw blokad rozrządu
 DE Nockenwellen-Arretierwerkzeugsatz
 RU Комплект блокировки газораспределения
 CZ Blokovací sada pro opravy rozvodů
 HU Vezérműörgzőlítő szerszámkészlet
 RO Set blocare distribuție auto
 FR Jeu d'outils de calage de distribution
 IT Set di bloccaggio distribuzione auto
 ES Juego de bloques de distribución
 CN 正时工具组套

 Citroën: EP3C (8F01), EP6C (5F01), EP3 (8FS), EP6 (5FW), EP6DT (5FX), EP6CDT (5F04); Peugeot: EP3 (8FS), EP6 (5FW), EP6C (5F01), EP6DT (5FX), EP6DTS (5FY), EP3C (8F01), EP6DTX (5FU), EP6DTS (5FY), EP6CDT (5F04), EP6 (5FX), EP6CDTX (5FU); BMW Mini: N12 1.4 Valvetronic (1.4 VTI, 1.5 VTI), N14 1.6 Direktspritzer (1.6 THP), BMW: 1.4 VTI, 1.5 VTI, N14 (1.6 THP)

EN Timing locking set
 PL Zestaw blokad rozrządu
 DE Nockenwellen-Arretierwerkzeugsatz
 RU Комплект блокировки газораспределения
 CZ Blokovací sada pro opravy rozvodů
 HU Vezérműörgzőlítő szerszámkészlet
 RO Set blocare distribuție auto
 FR Jeu d'outils de calage de distribution
 IT Set di bloccaggio distribuzione auto
 ES Juego de bloques de distribución
 CN 正时工具组套

 Audi: A1/A1 Sportback, A3 Cabrio, A3 Saloon, A3 Sedan, A3/A3 Sportback, A4, Allroad, A4 Quattro, A4/A5 Sportback, A5 Cabriolet, A5 Coupe, A6, TT, Q3, Q5; Seat: Alhambra, Ibiza, Leon, Leon ST; Skoda: Fabia III, Fabia III Estate, Rapid, Rapid Spaceback, Octavia III, Superb III; VW: Golf VI, Golf VII, Golf VII Estate, Golf VII SV/Sportsvan, Golf VII Wagon, Passat, Polo, Scirocco, Sharan II, Touran II, Tiguan



 1.4: CUSA, CUSB, CUTA; 1.6: CLHA, CLHB, CRKA, CRKB, CXXA, CXXB; 2.0: CKFB, CKFC, CNHA, CNHC, CRBC, CRBD, CRFA, CRFC, CRLB, CRLC, CRMB, CRVA, CRVC, CSUA, CSUB, CSUD, CSUE, CUAA, CUNA, CUPA, CUUA, CUUB, CUWA, DDA; OEM#: T10490, T10492, T10051, 3359, T10060A, T10264, T10265

EN Timing locking set
 PL Zestaw blokad rozrządu
 DE Nockenwellen-Arretierwerkzeugsatz
 RU Комплект блокировки газораспределения
 CZ Blokovací sada pro opravy rozvodů
 HU Vezérműörgzőlítő szerszámkészlet
 RO Set blocare distribuție auto
 FR Jeu d'outils de calage de distribution
 IT Set di bloccaggio distribuzione auto
 ES Juego de bloques de distribución
 CN 正时工具组套



 Mercedes: A-Class (2012-2018), B-Class (2012-2019), C-Class (2009-2018), CLA Coupe (2013-2019), CLS (2011-2018), E-Class (2009-2016), GLA (2014-2020>), GLC (2015-2019), GLE (2015-2019), GLK (2008-2015), M-Class (2011-2015), S-Class (2010-2013), S-Class (2013-2017), SLC (2016-2017), SLK (2012-2016), Sprinter (2009-2020>), Vito/Viano (2010-2015), Vito/V-Class (2014-2020>)

 M651: 1.8 (651.901), 2.1 (651.XXX), 2.2 (651.925), ENE (651.925)

EN Timing locking set
 PL Zestaw blokad rozrządu
 DE Nockenwellen-Arretierwerkzeugsatz
 RU Комплект блокировки газораспределения
 CZ Blokovací sada pro opravy rozvodů
 HU Vezérműörgzőlítő szerszámkészlet
 RO Set blocare distribuție auto
 FR Jeu d'outils de calage de distribution
 IT Set di bloccaggio distribuzione auto
 ES Juego de bloques de distribución
 CN 正时工具组套



 Ford: 1.3 TDCi; Fiat: Punto 1.3 JTD Multi-Jet (2003-2007), Panda, Idea, Doblo: 1.3 JTD Multi (2003-2009); Suzuki: Ignis, Wagon, Swift: 1.3 CDTi (2003-2010); Opel: Corsa C, Combo C, Astra H, Tigra B, Meriva (2003-2009)
 188A9.000, 169A1.000, 188A8.000, 188A9.000, Z13DT, Z13DTJ



YATO  **YT-06001**  5

10
PCS
FOR VALVETRAIN DO UKLADU ROZRZADU
FOR GASOLINE ENGINES DO SILNIKOW BENZYNOWYCH 



YATO  **YT-060175**  5

10
PCS
FOR VALVETRAIN DO UKLADU ROZRZADU
FOR DIESEL ENGINES DO SILNIKOW DIESLA 



YATO  **YT-06322**  5

11
PCS
FOR MERCEDES DO MERCEDESA
FOR VALVETRAIN DO UKLADU ROZRZADU
FOR DIESEL ENGINES DO SILNIKOW DIESLA 



YATO  **YT-06003**  5

12
PCS
FOR VALVETRAIN DO UKLADU ROZRZADU
FOR DIESEL ENGINES DO SILNIKOW DIESLA 

- EN Timing locking set
- PL Zestaw blokad rozrządu
- DE Nockenwellen-Arretierwerkzeugsatz
- RU Комплект блокировки газораспределения
- CZ Blokovací sada pro opravy rozvodů
- HU Vezérműrögztűlő szerszámkészlet
- RO Set blocare distribuție auto
- FR Jeu d'outils de calage de distribution
- IT Set di bloccaggio distribuzione auto
- ES Juego de bloques de distribución
- CN 正时工具组套

 Renault: Avantime (2005-2007), Clio (2001-2008), Espace (2000-2008), Kangoo (2000-2008), Laguna (1999-2001), Laguna II (2004-2007), Master (2000-2006), Megane (1999-2008), Modus (2004-2008), Scenic (1999-2008), Traffic (2001-2008), Twingo (2007-2008); Nissan: Almera N16 (2002-2006), Interstar (2002-2006), Kubistar (2003-2008), Micra K12 (2003-2008), Note (2006-2008), Primastar (2002-2007), Primera P12 (2003-2007), Qashqai (2008-2009); Opel: Movano (2000-2008), Vivaro (2001-2008)

 1.5 (K9K), 1.9 (F9Q), 2.2 (G9T), 2.5 (G9U)



12
PCS

FOR VALVETRAIN
DO UKŁADU
ROZRZĄDU

FOR DIESEL
ENGINES
DO SILNIKÓW
DIELSA



YATO 
YT-06006 8

- EN Timing locking set
- PL Zestaw blokad rozrządu
- DE Nockenwellen-Arretierwerkzeugsatz
- RU Комплект блокировки газораспределения
- CZ Blokovací sada pro opravy rozvodů
- HU Vezérműrögztűlő szerszámkészlet
- RO Set blocare distribuție auto
- FR Jeu d'outils de calage de distribution
- IT Set di bloccaggio distribuzione auto
- ES Juego de bloques de distribución
- CN 正时工具组套

 Ford: Fiesta, Puma, Focus (1998-2008), Focus C-Max, Escort, Orion, Mondeo (1998-2000), Cougar, Courier, Transit, Fusion, Sierra, Sierra, Tourneo (1983-2000), Connect, Mazda: 1.8D (199-1999), 121 (1995-2000), 2 (2002-2007), 3 (2003-), 5 (2005-), 6 (2002-), MX-5 (2005-), MPV (2002-2005), Tribute (2001-2004); Volvo: S40 (2004-2010), V50 (2004-2010), C30 (2006-2010)

 Diesel 1.8 D / TD, 1.8 Di, 1.8 TDCi, 2.5 Di / TD / TDCi / Turbo, 1.25 16 V, 1.4 16 V, 1.6 16 V, 1.8 16 V, 2.0 16 V, 2.3 16 V; C9DC, F9DA/B, FFDA, C9DA/B, BHDA/B, BHPA, HCPA, HCPB, P7PA, P9PA, R2PA, R3PA, RWPA, KKDA, G6DA, G6DB, G6DC, RTN, RTP, RTQ, RFK, RFN, RKD, RTJ, RTK, 4EB, 4EC, 4ED, 4FA, 4FB, 4FC, 4FD, 4GA, 4GB, 4GC, 4GD, 4GE, 4HB, 4HC, 4HA, FUJA, FUJB, FXJA, FXJB, FYJA, L8, LF, YF, L3





12
PCS

FOR VALVETRAIN
DO UKŁADU
ROZRZĄDU

FOR DIESEL
ENGINES
DO SILNIKÓW
DIELSA

FOR GASOLINE
ENGINES
DO SILNIKÓW
BENZYNOWYCH



YATO 
YT-06021 4

- EN Timing locking set
- PL Zestaw blokad rozrządu
- DE Nockenwellen-Arretierwerkzeugsatz
- RU Комплект блокировки газораспределения
- CZ Blokovací sada pro opravy rozvodů
- HU Vezérműrögztűlő szerszámkészlet
- RO Set blocare distribuție auto
- FR Jeu d'outils de calage de distribution
- IT Set di bloccaggio distribuzione auto
- ES Juego de bloques de distribución
- CN 正时工具组套

 Chevrolet: Captiva; Opel: Antara, Astra, Insignia; Saab: 9-5

 2.0: LHU/A20NFT, LTG/A20NHT, LDK/A20NHT; 2.4: LE5, LE9, A24XE, A24XF



14
PCS

FOR VALVETRAIN
DO UKŁADU
ROZRZĄDU

FOR GASOLINE
ENGINES
DO SILNIKÓW
BENZYNOWYCH



YATO 
YT-06027 5

- EN Timing locking set
- PL Zestaw blokad rozrządu
- DE Nockenwellen-Arretierwerkzeugsatz
- RU Комплект блокировки газораспределения
- CZ Blokovací sada pro opravy rozvodů
- HU Vezérműrögztűlő szerszámkészlet
- RO Set blocare distribuție auto
- FR Jeu d'outils de calage de distribution
- IT Set di bloccaggio distribuzione auto
- ES Juego de bloques de distribución
- CN 正时工具组套

 Audi: A3 (8P7), A4 (8K2/8K5), A5 (8T3), Q5, TT (8J3); Seat: Alhambra (710); Skoda: Octavia (1Z3/1Z5), Superb II; VW: Beetle (5C1/5C7), Jetta III+IV, Passat (3C5/CC)

 2006-2014 TSI, TFSI (1.8/2.0): CEAA, CGMA, CCZA, CCZB, CCZC, CCZD, CCUA, CAEB, BYJ, BYE, CDA, CDAB, CDNC, CDZA, CADA, CPSA



16
PCS

VAG

FOR VALVETRAIN
DO UKŁADU
ROZRZĄDU

FOR GASOLINE
ENGINES
DO SILNIKÓW
BENZYNOWYCH



YATO 
YT-06024 5

- EN Timing locking set
- PL Zestaw blokad rozrządu
- DE Nockenwellen-Arretierwerkzeugsatz
- RU Комплект блокировки газораспределения
- CZ Blokovací sada pro opravy rozvodů
- HU Vezérműrögztítő szerszámkészlet
- RO Set blocare distribuție auto
- FR Jeu d'outils de calage de distribution
- IT Set di bloccaggio distribuzione auto
- ES Juego de bloques de distribución
- CN 正时工具组套

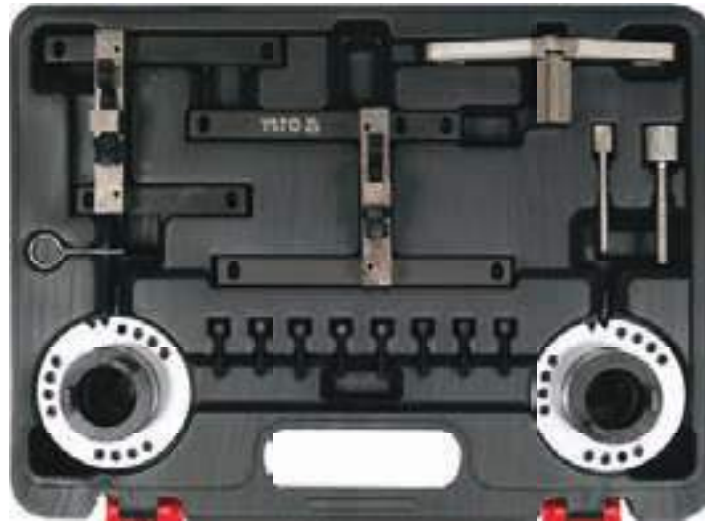

16 PCS	FOR VALVETRAIN DO UKŁADU ROZRZĄDU
FOR GASOLINE ENGINES DO SILNIKÓW BENZYNOWYCH	

 Ford: B-Max, C-Max, EcoSport, Fiesta, Focus, Grand C-Max, Tourneo Connect, Transit Courier, Transit Connect
1.0 EcoBoost: M1DA, M1JA, M2DA, M2GA, P4JA, P4JB, SFJA, SFJB, XMJA, XMJB

YATO 
YT-060262

2

- EN Timing locking set
- PL Zestaw blokad rozrządu
- DE Nockenwellen-Arretierwerkzeugsatz
- RU Комплект блокировки газораспределения
- CZ Blokovací sada pro opravy rozvodů
- HU Vezérműrögztítő szerszámkészlet
- RO Set blocare distribuție auto
- FR Jeu d'outils de calage de distribution
- IT Set di bloccaggio distribuzione auto
- ES Juego de bloques de distribución
- CN 正时工具组套



17 PCS	FOR VALVETRAIN DO UKŁADU ROZRZĄDU
FOR DIESEL ENGINES DO SILNIKÓW DIELA	FOR GASOLINE ENGINES DO SILNIKÓW BENZYNOWYCH
	

 Renault: Clio 1.2/1.4, 1.4/1.6/1.8 16V, Clio Sport 2.0 16V R19 1.4, Clio Williams 2.0 16V R19 1.4 Eco, Espace 2.0 R19 1.8 16V, 2.0 16V, 2.2 TD, Express 1.4, Extra 1.4, Kangoo 1.2/1.4, Laguna 1.6 16V, 1.8/2.0, 1.8/2.0 16V, 2.2 D/TD, 2.5 D/TD, Megane 1.4/1.6/2.0 16V, 2.5D/TD, Rapid 1.4, Safrane 2.0 16V, 2.2 TD, 2.5 20V, Scenic 1.4/1.6/2.0 16V, Trafic 2.5D, Twingo 1.2

YATO 
YT-06324

4

- EN Timing locking set
- PL Zestaw blokad rozrządu
- DE Nockenwellen-Arretierwerkzeugsatz
- RU Комплект блокировки газораспределения
- CZ Blokovací sada pro opravy rozvodů
- HU Vezérműrögztítő szerszámkészlet
- RO Set blocare distribuție auto
- FR Jeu d'outils de calage de distribution
- IT Set di bloccaggio distribuzione auto
- ES Juego de bloques de distribución
- CN 正时工具组套



29 PCS	FOR VALVETRAIN DO UKŁADU ROZRZĄDU
FOR DIESEL ENGINES DO SILNIKÓW DIELA	FOR GASOLINE ENGINES DO SILNIKÓW BENZYNOWYCH
	

 Opel: Agila, Combo C, Corsa, Frontiera, Omega, Sintra, Tigra, Vectra, Zafira
1.3 CDTI 16V, 1.9 CDTI, 2.0 DTI, 2.2 DTI, 1.0 DTI, 1.0 IZU, 1.2 16V (since 1996); 1.4 16V, 1.6 16V, 1.8 16V, 2.0 16V, 2.2 16V (since 1995)

YATO 
YT-06007



2

- EN Timing locking set
- PL Zestaw blokad rozrządu
- DE Nockenwellen-Arretierwerkzeugsatz
- RU Комплект блокировки газораспределения
- CZ Blokovací sada pro opravy rozvodů
- HU Vezérműrögztűlő szerszámkészlet
- RO Set blocare distribuție auto
- FR Jeu d'outils de calage de distribution
- IT Set di bloccaggio distribuzione auto
- ES Juego de bloques de distribución
- CN 正时工具组套



34
PCS

VAG 

YATO 

YT-06015 
4

- EN Injector seat cleaning brush set
- PL Zestaw szczotek do gniazd wtryskiwaczy
- DE Injektorsitz Bürsten
- RU Ерши для чистки гнезд свечей зажигания и форсунок
- CZ Sada kartáčků na čištění sedel vstřikovačů
- HU Befecskendező fészek tisztító készlet
- RO Perii cilindrice pt. curatarea gaurilor
- FR Brosses pour puits d'injecteurs
- IT Set di spazzole per la pulizia della sede dell'iniettore
- ES Juego de cepillos para limpieza de inyectores
- CN 钢丝刷

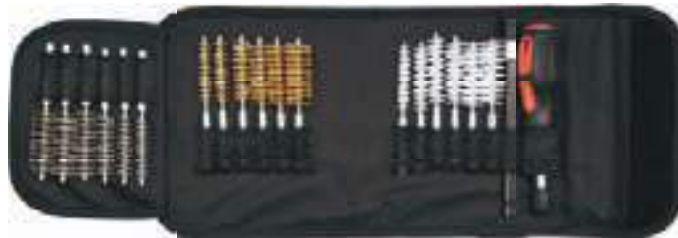

20
PCS

150
mm

1/4"
6.3mm

SS
STAINLESS STEEL
STAL. NIEROZŻEWNA

BRASS
MOSIADZ

NYLON 

YATO 

YT-08195 Ø [mm] 
10/20

Ø 9, 11, 13, 15, 17, 19 mm

- EN Injector seat cleaning brush set
- PL Zestaw szczotek do gniazd wtryskiwaczy
- DE Injektorsitz Bürsten
- RU Ерши для чистки гнезд свечей зажигания и форсунок
- CZ Sada kartáčků na čištění sedel vstřikovačů
- HU Befecskendező fészek tisztító készlet
- RO Perii cilindrice pt. curatarea gaurilor
- FR Brosses pour puits d'injecteurs
- IT Set di spazzole per la pulizia della sede dell'iniettore
- ES Juego de cepillos para limpieza de inyectores
- CN 钢丝刷组套



38
PCS

150
mm

1/4"
6.3mm

SS
STAINLESS STEEL
STAL. NIEROZŻEWNA

BRASS
MOSIADZ

NYLON 

YATO 

YT-08196 Ø [mm] 
10

Ø 8, 9, 10, 11, 12, 13, 14, 15, 16, 17, 18, 19 mm

- EN Diesel injector puller
- PL Ściągacz bezwładnościowy do wtryskiwaczy
- DE Stoßabziehvorrichtung für Einspritzdüse
- RU Ударный съемник форсунок
- CZ Rázový vytahovač vstřikovačů
- HU Diesel porlasztó kisedő
- RO Extractor injectoare
- FR Extracteur à choc d'injecteurs
- IT Martello scorrevole per la rimozione degli iniettori
- ES Tuerca tensora de impacto para inyectores
- CN 柴油喷嘴拔取器



M8 M12 M14

BOSCH
TYPE

LUCAS
TYPE 

YATO 

YT-0617 
20

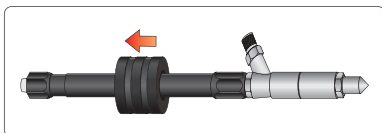

EN Injector puller set
 PL Zestaw do demontażu wtryskiwaczy
 DE Injektoren-Auszieher-Satz
 RU Комплект для снятия форсунок
 CZ Souprava pro demontáž vstříkovačů
 HU Befecskendező készlet
 RO Extractor injectoare
 FR Ensemble pour démonter les injecteur
 IT Kit per estrazione iniettori
 ES Kit de desmontaje de inyectoras
 CN 柴油喷油器拆装工具组套

10 PCS HDI BOSCH SIEMENS



YATO
 YT-05338

4

EN Pneumatic injector puller set
 PL Zestaw pneumatyczny do demontażu wtryskiwaczy
 DE Druckluft Injektoren-Auszieher-Satz
 RU Съемник форсунок пневматический
 CZ Pneumatická sada na demontáž vstříkovačů
 HU Pneumatikus injektor kihúzó készlet
 RO Set extractor pneumatic pt. injectoare
 FR Extracteur d'injecteur pneumatique
 IT Kit estrattore pneumatico per iniettori
 ES Conjunto neumático para desmontaje de inyectoras
 CN 气动喷油嘴拉拔器

21 PCS 0.8 MPa (max.) STANDARD BOSCH DELPHI DENSO SIEMENS



$L_{pa} = 102,0 \pm 3,0$ dB; $L_{max} = 113,0 \pm 3,0$ dB; $a_s = 23,8 \pm 1,5$ m/s²
 M8x1.0, M8x1.25, M10x1.5, M12x1.5, M16x1.5, M17x1.0, M18x0.75, M18x1.5, M20x1.0, M20x1.5, M22x1.5, M25x0.5, M25x1.0, M26x0.75, M27x0.75, M27x1.0 (2 PCS), M29x1.0, M31x0.75

YATO
 YT-05335

2

EN Injector puller set CDI
 PL Ściągacz do wtrysków CDI
 DE Diesel-Injektoren-Auszieher-Satz CDI
 RU Съемник дизельных форсунок CDI
 CZ Přípravek na vytahování vstříkovačů CDI
 HU Porlasztó kihúzó készlet CDI motorhoz
 RO Set extractor pt. injectoare CDI
 FR Coffret extracteur d'injecteur diesel CDI
 IT Estrattore iniettori CDI
 ES Juego de extracción de inyectoras en CDI
 CN 柴油喷嘴拆卸工具

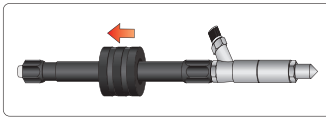

8 PCS



Mercedes: CDI OM611, OM612, OM613

YATO
 YT-06176

5

EN Diesel injector master removal set
 PL Zestaw ściągaczy bezwładnościowych do wtryskiwaczy
 DE Trägheit Abzieher-Satz für Einspritzdüsen
 RU Съемник форсунок с ударным молотком для дизельных двигателей
 CZ Souprava na demontáž vstříkovaču s reverzním kladivem
 HU Injektor kihúzó készlet, csúszókalapáccsal
 RO Set de extractoare pt. injectoare
 FR Coffret extracteur d'injecteur
 IT Set di estrattori ad inerzia per iniettori
 ES Extractor de inyectoras de inyección
 CN 柴油喷嘴维修工具

14 PCS 1/2" 12.7mm BOSCH DELPHI DENSO SIEMENS



YATO
 YT-06174

2

EN Diesel injector master removal set
 PL Zestaw ściągaczy bezwładnościowych do wtryskiwaczy
 DE Trägheit Abzieher-Satz für Einspritzdüsen
 RU Съемник форсунок с ударным молотком для дизельных двигателей
 CZ Souprava na demontáž vstříkovaču s reverzním kladivem
 HU Injektor kihúzó készlet, csúszókalapáccsal
 RO Set de extractoare pt. injectoare
 FR Coffret extracteur d'injecteur
 IT Set di estrattori ad inerzia per iniettori
 ES Extractor de inyectoras de inyección
 CN 柴油喷嘴维修工具

22 PCS 1/2" 12.7mm BOSCH DELPHI DENSO SIEMENS PUMP DIESE DIESEL INJECTORS PUMPY WTRYSKIWACZY 2 HAMMERS MŁOTKI

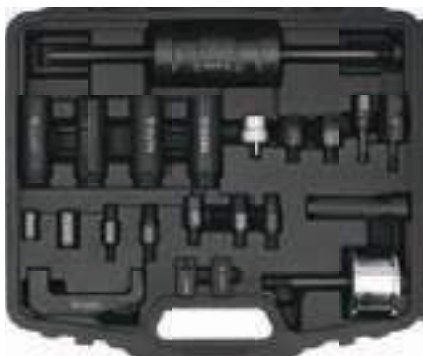
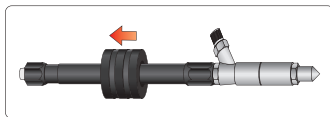

YATO
 YT-06175

1

EN Injector seat cleaning set
 PL Zestaw do czyszczenia gniazd wtryskiwaczy
 DE Einspritzdüsen-Reinigungsset
 RU Набор для чистки инжектора
 CZ Sada na čištění dosedacích sedel vstříkovačů
 HU Befecskendező fészek tisztító készlet
 RO Set de curățare scaun injector
 FR Kit de nettoyage pour injecteurs
 IT Kit per pulizia sedi iniettori
 ES Juego de limpieza para asientos de inyectoras
 CN 喷油器插座清洁组套

19 PCS 1/4" 6.3mm SS STAINLESS STEEL STA. NERZŐACÉL NYLON BRASS MOSIÁZS



Brass: Ø 17, 20, 23 mm;
 Nylon: Ø 16, 17, 18 mm;
 Steel: Ø 7 mm
 Mosiász: Ø 17, 20, 23 mm;
 Nylon: Ø 16, 17, 18 mm;
 Stal: Ø 7 mm

YATO
 YT-17623

10

- EN Injector seat cleaning set
PL Zestaw do czyszczenia gniazd wtryskiwaczy
DE Einspritzdüsen-Reinigungsset
RU Набор для чистки инжектора
CZ Sada na čištění došedacích sedel vstřikovačů
HU Befecskendező fészék tisztító készlet
RO Set de curățare scaun injector
FR Kit de nettoyage pour injecteurs
IT Kit per pulizia sedi iniettori
ES Juego de limpieza para asientos de inyectoros
CN 清洁刷套装

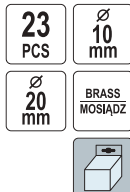

YATO
YT-17622 25

- EN Injector seat and manhole cleaning set
PL Zestaw do obsługi gniazd wtryskiwaczy
DE Wartungssatz für Einspritzdüsen
RU Набор для обслуживания патрубков форсунок
CZ Sada pro údržbu hlízd vstřikovače
HU Befecskendező-aljzat szerelőkészlet
RO Set curățare scaun injector
FR Kit de montage et démontage d'injecteurs
IT Set per pulizia sedi iniettori
ES Juego para casquillos de inyectoros
CN 喷油嘴底座清理工具

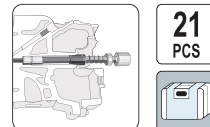

17x17 mm, 17x19 mm;
120° 17x17 mm

YATO
YT-17627 4

- EN Diesel injector copper washer remover install tool
PL Przyrząd do wyciągania podkładek wtryskiwaczy
DE Ausziehvorrichtung für Einspritzdüsenunterlagen
RU Инструмент для снятия шайб форсунок
CZ Nástroj pro demontáž podložek vstřikovačů
HU Befecskendező alátét eltávolító szerszám
RO Dispozitiv îndepărtare saibă injector
FR Extracteur d'injecteur diesel
IT Estrattore per rondelle iniettori
ES Herramienta para quitar arandelas de inyectoros
CN 柴油喷油嘴垫片拆卸器



YATO
YT-17629 10

- EN Glow plug reamer set
PL Zestaw do czyszczenia gniazd świec żarowych
DE Reinigungsset für Glühkerzen
RU Набор для чистки свечей накаливания
CZ Sada k čištění otvorů zážehových svíci
HU Gyújtógyertya aljzat tisztítókészlet
RO Set pt. curățat și rectificat filet bujii incandescente
FR Kit de nettoyage des puits de bougie de préchauffage
IT Kit per pulizia delle bussole delle candele
ES Set de limpieza de asientos de bujías incandescentes
CN 热塞铰刀组套

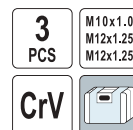

M10 x 1 mm; M12 x 1.25 mm; M12 x 1.25 mm

YATO
YT-05341 10/20

- EN Glow plug reamer set
PL Zestaw do czyszczenia gniazd świec żarowych
DE Reinigungsset für Glühkerzen
RU Набор для чистки свечей накаливания
CZ Sada k čištění otvorů zážehových svíci
HU Gyújtógyertya aljzat tisztítókészlet
RO Set pt. curățat și rectificat filet bujii incandescente
FR Kit de nettoyage des puits de bougie de préchauffage
IT Kit per pulizia delle bussole delle candele
ES Set de limpieza de asientos de bujías incandescentes
CN 预热塞铰刀修复组套



YATO
YT-17712 10

- EN Glow plug puller set
PL Zestaw do demontażu uszkodzonej świecy żarowej
DE Demontagesatz für beschädigte Glühkerzen
RU Набор для снятия поврежденных свечей накаливания
CZ Sada pro demontáž poškozené žhavičí svíčky
HU Izzitógyertya kiszereelő készlet
RO Set extractor bujii incandescente
FR Kit de démontage d'une bougie de préchauffage défectueuse
IT Set per rimozione candele danneggiate
ES Juego de desmontaje de la bujía dañada
CN 预热塞拔卸器

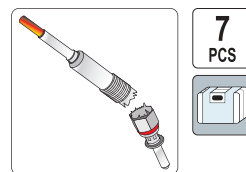



YATO
YT-05343 5

- EN Broken glow plug removal set
- PL Zestaw do demontażu urwaných świec żarowych
- DE Glühkerzen-Demontage-Werkzeug-Satz
- RU Набор инструментов для демонтажа свечей накаливания
- CZ Přípravek pro odvrtání a opravu závitů žhavicích svíček
- HU Törött izzítógyertya-eltávolító készlet
- RO Set extractoare pt. bujii rupte
- FR Kit extracteur bougie de préchauffage
- IT Kit per l'estrazione delle candelette rotte
- ES Kit de extractor de bujías incandescentes
- CN 预热塞修理工具

40 PCS	1/4" 6,3mm	3/8" 9,5mm	HSS	CrV	
------------------	----------------------	----------------------	------------	------------	---



YATO 	
YT-05344	5

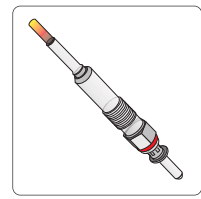

- EN Broken glow plug removal set
- PL Zestaw do demontażu urwaných świec żarowych
- DE Glühkerzen-Demontage-Werkzeug-Satz
- RU Набор инструментов для демонтажа свечей накаливания
- CZ Přípravek pro odvrtání a opravu závitů žhavicích svíček
- HU Törött izzítógyertya-eltávolító készlet
- RO Set extractoare pt. bujii rupte
- FR Kit extracteur bougie de préchauffage
- IT Kit per l'estrazione delle candelette rotte
- ES Kit de extractor de bujías incandescentes
- CN 预热塞修理工具

16 PCS
3/8" 9,5mm
HSS 4241
CrV

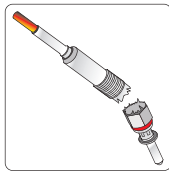
- EN Glow plug heater element removal set
- PL Zestaw do demontażu żarnika świec
- DE Set zur Glühfaden-Demontage
- RU Комплект для снятия свечей накаливания
- CZ Souprava pro odstranění vlákná svíc
- HU Gyújtógyertya kisedő készlet
- RO Set extractor bujii incandescente
- FR Kit extracteur de filament de bougie
- IT Kit per l'estrazione dei filamenti delle candelette
- ES Kit de desmontaje de filamento de vela
- CN 预热塞

22 PCS
HSS



M8 x 1 mm; M10 x 1 mm; M10 x 1.25 mm

YATO 	
YT-05345	10

YATO 	
YT-05342	5



- EN Valve grinding set
- PL Zestaw docieraków ręcznych do zaworów
- DE Handventil-Läppsatz
- RU Набор для ручной притирки клапанов
- CZ Sada přípravků pro lapování ventilů
- HU Manuális szelepcsiszoló készlet
- RO Set pt. slefuit supape
- FR Kit de rodage soupape
- IT Kit di utensili manuali per lappatura valvole
- ES Conjunto de reguladores manuales de válvulas
- CN 气门研磨棒



2 PCS	15-20 mm
30-36 mm	

YATO 	
YT-06187	40

EN Overhead valve spring compressor
PL Przyrząd do demontażu zaworów silnikowych
DE Vorrichtung zur Demontage von Motorventilen
RU Устройство для демонтажа клапанов двигателя
CZ Přípravek na demontáž ventilů motoru
HU Szeleplehűző készlet
RO Dispozitiv pt. demontarea supapelor
FR Outil pour démonter les soupapes de moteur
IT Strumento per la rimozione di valvole motore
ES Instrumento para desmontaje de válvulas de motor
CN 下压式凡尔钳

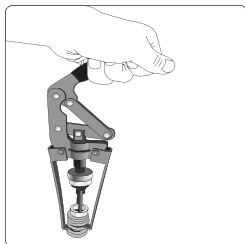

YATO
YT-0618

5/25

EN Overhead valve spring compressor
PL Przyrząd do demontażu zaworów silnikowych
DE Vorrichtung zur Demontage von Motorventilen
RU Устройство для демонтажа клапанов двигателя
CZ Přípravek na demontáž ventilů motoru
HU Szeleplehűző készlet
RO Dispozitiv pt. demontarea supapelor
FR Outil pour démonter les soupapes de moteur
IT Strumento per la rimozione di valvole motore
ES Instrumento para desmontaje de válvulas de motor
CN 气门弹簧压缩器

320 mm

OHV

FOR ENGINE VALVES DO ZAWOROW SILNIKOWYCH



YATO
YT-06184

10/20

EN Exhaust pipe expander set
PL Zestaw rozpiereków do rur wydechowych
DE Auspuffrohr-Aufweitungs-Satz
RU Комплект распорок для выхлопных труб
CZ Sada expandéru do výfuků
HU Kipufogósó tágló készlet

RO Set largire teava esapament
FR Kit élargisseur de tuyau d'échappement
IT Kit di cilindri per tubi di scarico
ES Kit expansor para tubos de escape
CN 排气管扩孔器

3 PCS

17 mm

19 mm

29-42 mm

38-62 mm

54-89 mm



YATO
YT-06166

5

EN Exhaust pipe cutting tool
PL Obcinak do rur wydechowych
DE Auspuffrohrsneider
RU Цепной резак выхлопной трубы
CZ Řezačka výfukového potrubí
HU Kipufogósó vágó
RO Instrument de tăiere a țevilor de esapament
FR Coupeur de tuyau d'échappement
IT Tagliatubi di scarico
ES Cortador de tubos de escape
CN 排气管割刀

max 2.5mm STEEL STAL

18-95 mm

x15

GCr15



YATO
YT-06169

12/24

EN Oxygen sensor crowfoot wrench
PL Klucz do sondy lambda
DE Schlüssel für Lambdasonde
RU Торцовые ключи с внутренним многогранником для зонда лямбда

CZ Klíč na sondy lambda
HU Lambda szonda kulcs
RO Cheie pt. sonda lambda
FR Clé pour sonde lambda

IT Chiave per sonda lambda
ES Llave para la sonda lambda
CN 氧传感器套筒扳手

22 mm

FOR OXYGEN SENSOR DO SONDY LAMBDA



CrMo
SCM440

CrV
50BV30

YATO
YT-1753

15/60

YATO
YT-1754

6/36

EN Socket and oxygen sensor set
PL Klucze nasadowe do sondy lambda
DE Steckschlüssel für Lambdasonde
RU Торцовые ключи с внутренним многогранником для зонда лямбда
CZ Nástrčné klíče na sondy lambda
HU Dugókulcs lambda szondához
RO Tubulare pt. sonda lambda
FR Douille pour sonde lambda
IT Set di riparazione per filetti di sonda lambda
ES Llaves de cubo para la sonda lambda
CN 氧传感器套筒扳手套

3 PCS

22 mm

CrMo SCM440

CrV 50BV30

FOR OXYGEN SENSOR DO SONDY LAMBDA



⌀ 22 mm; L= 50 mm; 6PT; CrMo SCM440;
⌀ 22 mm; L=30 mm; 6PT; CrMo SCM440;
⌀ 22 mm; L=80 mm; 6PT; CrV 50BV30

YATO
YT-1752

20

EN Oxygen sensor extra-long socket
PL Klucz do sondy lambda ekstradługi
DE Lambdasonde-Schlüssel extra lang
RU Ключ для лямбда-зонда удлиненный
CZ Klíč do lambda sondy extra dlouhý
HU Lambdasonda kulcs extra hosszú
RO Cheie pt. sonda lambda
FR Clé pour sonde lambda extra longue
IT Chiave extra lunga per sonda lambda
ES Llave para sonda lambda extra larga
CN 加长含氧感应套筒

EXTRA LONG EKSTRA-DŁUGI

1/2" 12.7 mm

22 mm

150 mm

CrV

FOR OXYGEN SENSOR DO SONDY LAMBDA



YATO
YT-17513

L [mm]

10/60

EN Oxygen flexi head wrench
 PL Klucz łamany do sondy lambda
 DE Gelenkschlüssel für Lambdasonde
 RU Двусторонний ключ для лямбда-зонда
 CZ Lámaný klíč do lambda sondy
 HU Lambda szonda kulcs
 RO Cheie articulata pt. sonda lambda
 FR Clé articulée pour sonde lambda
 IT Chiave pieghevole per sonda lambda
 ES Llave articulada para la sonda lambda
 CN 氧传感扳手



270 mm
 22 mm
 22 mm
 FOR OXYGEN SENSOR DO SONDY LAMBDA
 CrV

YATO	
YT-17515	6/36

EN Oxygen sensor and fuel injectors wrench set
 PL Zestaw nasadek do sondy lambda i wtryskiwaczy
 DE Steckschlüsselsatz für Lambdasonde und Einspritzdüsen
 RU Набор насадок к лямбда-зондам и форсунок
 CZ Sada nástavců na demontáž sondy lambda a vstřikovačů
 HU Dugókészlet lambda szondákhoz és injektorokhoz
 RO Set inelare pt. sonda lambda și injectoare
 FR Douilles pour sonde lambda et injecteurs
 IT Set di attrezzi per sonda lambda e iniettori
 ES Juego de boquillas para la sonda lambda y para inyectores
 CN 氧传感器套筒扳手组套

7 PCS
 1/2" 12.7 mm
 3/8" 9.5 mm
 CrMo SCM440
 CrV 50BV30
 FOR OXYGEN SENSOR DO SONDY LAMBDA
 FOR FUEL INJECTORS DO WTRYSKIWO PALNIWA

EN Injection line socket set
 PL Zestaw kluczy do wtryskiwaczy
 DE Injektorschlüsselsatz
 RU Набор ключей для проводов форсунок
 CZ Sada klíčů pro vstřikovače
 HU Injektor kulcs készlet
 RO Set chei pt. injectoare
 FR Jeu de clés pour injecteurs
 IT Set di chiavi per iniettori
 ES Juego de llaves para inyectores
 CN 油管扳手组套

3 PCS
 1/2" 12.7 mm
 14 mm
 17 mm
 19 mm
 SPECIAL SHAPE SPECIALNY KSZTAŁT
 CrV



YATO	
YT-17619	20



⊗ ⊞ 1/2" (12.7 mm) x 29 mm; L=90 mm; 6PT;
 ⊗ ⊞ 3/8" (9.5 mm) x 22 mm; L=90 mm; 6PT;
 ⊗ ⊞ 1/2" (12.7 mm) x 27 mm; L=78 mm; 12PT;
 ⊗ ⊞ 3/8" (9.5 mm) x 27 mm; L=74 mm; 6PT;
 ⊗ ⊞ 3/8" (9.5 mm) x 22 mm; L=80 mm; 6PT;
 ⊗ ⊞ 1/2" (12.7 mm) x 22 mm; L=50 mm; 6PT;
 ⊗ ⊞ 3/8" (9.5 mm) x 22 mm; L=30 mm; 6PT

YATO	
YT-1751	5

EN Oxygen sensor socket & thread chaser set
 PL Zestaw nasadek obsługi sondy lambda
 DE Wartungssatz für Lambdasonde
 RU Набор для обслуживания лямбда-зонда
 CZ Sada pro práci s lambda sondou
 HU Lambdaszonda szerelő szerszám
 RO Set cheie pt. sonda lambda
 FR Kit de douilles pour sonde lambda
 IT Strumento per la rimozione della sonda Lambda
 ES Juego de vaso para sonda lambda
 CN 氧传感器套筒

5 PCS
 1/2" 12.7 mm
 3/8" 9.5 mm
 M12 x1.25
 M18 x1.5
 CrMo
 CrV
 FOR OXYGEN SENSOR DO SONDY LAMBDA



⊗ ⊞ 22 mm; L=50 mm; 6PT; CrMo;
 ⊗ ⊞ 22 mm; L=30 mm; 6PT; CrMo;
 ⊗ ⊞ 22 mm; L=80 mm; 6PT; CrV

YATO	
YT-17510	20

EN Slotted special socket set
 PL Zestaw nasadek otwartych
 DE Spezial-Steckschlüssel-Einsätze, geschlitzt
 RU Набор головок разрезных
 CZ Sada otevřených hlavíc
 HU Crowafej speciális végig nyitott
 RO Set de chei tubulare pt. injectoare
 FR Ensemble de clés creuses avec fenêtre latérale
 IT Set di attacchi aperti
 ES Conjunto de teclas huecas con ventana lateral
 CN 开槽油管扳手

7 PCS
 3/8" 9.5 mm
 1/2" 12.7 mm
 CrV



⊗ ⊞ 10, 11, 12, 13, 14, 17, 19 mm

YATO	
YT-17508	6/24

EN Flexible crowfoot socket wrench set
PL Zestaw kluczy przegubowych oczkowych otwartych
DE Gelenk-Ringschlüssel-Satz (offen)
RU Набор ключей разрезных с шарниром
CZ Sada otevřených očkových kloubových klíčů
HU Nyitott csőkulcs készlet
RO Set chei inelare semi-deschise cu articulație
FR Set de clés à tête fendue articulée
IT Set di chiavi snodate ad anello aperte
ES Juego de llaves articuladas de anillo abiertas
CN 万向扳手



3/8" (9.5 mm): 12, 14, 16, 17, 18, 19 mm; 40Cr/CrV

YATO	○	
YT-01440	3/8" (9.5 mm)	10

EN Flexible crowfoot socket wrench set
PL Zestaw kluczy przegubowych oczkowych otwartych
DE Gelenk-Ringschlüssel-Satz (offen)
RU Набор ключей разрезных с шарниром
CZ Sada otevřených očkových kloubových klíčů
HU Nyitott csőkulcs készlet
RO Set chei inelare semi-deschise cu articulație
FR Jeu de clés à tête fendue articulée
IT Set di chiavi snodate ad anello aperte
ES Juego de llaves articuladas de anillo abiertas
CN 万向扳手



3/8" (9.5 mm): 8, 9, 10, 11, 12, 13, 14, 15, 16, 17, 18, 19 mm; CrV

YATO	○	
YT-38550	3/8" (9.5 mm)	10

EN Diesel injection socket set
PL Zestaw nasadek do wtrysków w silnikach Diesla
DE Aufsätze für Einspritzungen bei Dieselmotoren
RU Набор насадок к форсункам в дизельных двигателях
CZ Sada nástavců na trysky dieselových motorů
HU Szerszámkészlet Dieselmotor befecskendezőkhöz
RO Set chei pt. injectoare motoare diesel
FR Set des douilles pour injecteurs (diesel)
IT Set di custodie per i motori diesel
ES Juego de tapones para las inyecciones en los motores de Diesel
CN 柴油机加注套筒组套

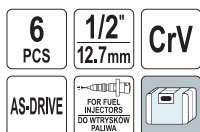

21x90; 22x78; 22x110; 27x78; 28x78; 28x83 mm

YATO	○	
YT-0622	1/2" (12.7 mm)	10

EN Diesel injector and cutter set
PL Zestaw frezów do gniazd wtryskiwaczy Common Rail
DE Frärsersatz für Buchsen der Einspritzdüsen
RU Комплект фрез для гнезд сопел форсунок
CZ Sada fréz na sedla trysek vstřikovačů
HU Marókészlet befecskendező fűvókájának fészkéhez
RO Set freze recondiționat scaun injectoare
FR Alimentation d'un injecteur de Common Rail
IT Set di fresa per sedi iniettori Common Rail
ES Juego de fresas para el asiento de toberas de inyectores
CN 气门较刀

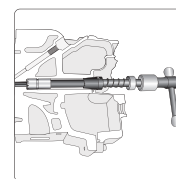

17x17 mm, 17x19 mm, 15x19 mm; CrMoV SKD11;
120° 17x17 mm, 120° 17x21 mm; CrMoV SKD11

YATO	○	
YT-17625		10

EN Reamer set for ABS sensor hole
PL Zestaw frezów do gniazd czujników ABS
DE ABS-Sensoren-Reitbahlen-Satz
RU Набор фрез для гнезд датчиков ABS
CZ Sada výstružníků pro senzory ABS
HU ABS jeladó-foglalat tisztító marófej készlet
RO Set de alezat pt. orificiul senzorului ABS
FR Jeu d'alésours pour puits de capteur ABS
IT Set di fresa per sedi di sensori ABS
ES Juego de fresas para alojamientos de sensores ABS
CN ABS传感器孔较刀



YATO	○	
YT-17626	1/4" (6.3 mm)	50

EN Tooth socket for injection nozzle
PL Zestaw kluczy czopowych do wtryskiwaczy w samochodach ciężarowych
DE Stiftschlüsselsatz für Einspritzdüse in Lastkraftwagen
RU Набор шиповых ключей к форсункам грузовых автомобилей
CZ Sada klíčů na vstřikovače pro nákladní automobily
HU Csapókulcs készlet tehergépkocsik befecskendezőjéhez
RO Set chei tubulare pt. injectoare camioane
FR Set de douilles injecteurs
IT Set di chiavi per iniettori camion
ES Juego de llaves de muñón para los inyectores en camiones
CN 卡车喷嘴套筒组套

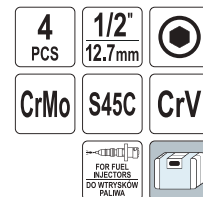

1/2" (12.7 mm); L=72 mm; 4T; CrV;
32 mm; M14 x 1.5 mm; L=70 mm, 4T; S45C;
1/2" (12.7 mm); L=120 mm; 3T; CrMo;
32 mm; L=120 mm, 4T; S45C

YATO	○	
YT-1762	1/2" (12.7 mm)	5

EN Socket key-attachments for Bosch VE-pumps
 PL Zestaw nasadek do pomp wtryskowych Bosch VE
 DE Aufsatz-Set für Bosch VE Einspritzpumpen
 RU Набор насадок для инжекторных насосов Bosch VE
 CZ Sada násad pro vstřikovací čerpadla Bosch VE
 HU Dugókulcs készlet Bosch VE befecskendező szivattyúhoz
 RO Set tubulare speciale pt. pompe injectie Bosch
 FR Jeu de douilles Bosch VE pour pompes d'injection
 IT Kit di attacchi per pompe d'iniezione Bosch VE
 ES Set de accesorios para bombas de inyección Bosch VE
 CN 博世泵套筒

3
PCS

1/2"
12.7mm

FOR
VE PUMPS
DO POMP
TYPY VE

CrV



YATO		
YT-17525	1/2" (12.7 mm)	12/48

EN Camshaft adapter socket set
 PL Zestaw nasadek do regulacji faz rozrządu
 DE Nockenwellen-Adapter-Steckschlüssel-Satz
 RU Набор для регулировки распределительного вала
 CZ Přípravky na nastavení fází časování rozvodů
 HU Vezérműtengely állító dugókulcs készlet
 RO Set chei adaptoare arbore cu came
 FR Jeu d'adaptateurs d'arbre à cames
 IT Set di bussola per sincronizzatore albero a camme
 ES Vasos para girar el árbol de levas
 CN 凸轮轴接头套筒

Audi: A3 (2011-, 2005-2013), A3 Quattro (2009-2013), A4 (2008, 2009-2015, 2016-), A4 Quattro (2009-2015), A5 (2008-2011), A5 Cabriolet (2009), A5 Coupe (2008), A5 Quattro (2009-2016), A6 2.0 TFSI (2012-2014), Tiguan (2016-), Q3 (2012-2015), Q5 (2008; 2009-2016), TT (2010-2014), TT Quattro (2009-2014); Seat: Alhambra (2011), Altea (2011), Altea XL (2009), Exeo (2009), Freerack (2011), Leon (2011); Skoda: Octavia (2009-2013), Superb (2009-2015), Yeti 1.8 TSI (2010-2015); VW: Beetle 2.0 TSI (2012-2016), CC 1.8 TSI/2.0 TSI (2012-2016), EOS 2.0 TSI (2010-2016), Golf GTI 1.8 TSI/2.0 TSI (2009-2013), Jetta GLI 2.0 TSI (2008-2014), Passat 1.8 TSI/2.0 TSI (2009-2015), Passat CC 1.8 TSI/2.0 TSI (2009-2012), Scirocco 2.0 TSI (2009-2016), Sharan 1.8 TSI/2.0 TSI (2011-2016), Tiguan 2.0 TSI (2008-2016)
 Audi: BYT, BZB, CABA, CABB, CABD, CAEA, CAEB, CAED, CBFA, CCTA, CCZA, CCZC, CDAA, CDHA, CDHB, CDNC, CDNC, CESA, CETA, CHJA, CPMA, CPMB, CPSA; Skoda: CCZA; VW: CAWB, CBFA, CCTA, CCZA, CCZB

EN Camshaft joint sleeve
 PL Nasadka do regulacji faz rozrządu
 DE Aufsatz zur Regelung der Nockenwellenphasenverstellung
 RU Насадка для регулировки фаз газораспределения
 CZ Nástavec pro regulaci časování ventilů
 HU Vezérfésállító dugókulcs
 RO Dispozitiv pt. rotii axa cu came
 FR Manchon de déphasage d'arbre à cames
 IT Attacco per sincronizzatore albero a camme
 ES Vaso para girar el árbol de levas
 CN 调节气门正时帽

ø3/8"
9.5 mm

VAG



VAG: Audi: A3 & A3 Sportback (12-16), A3 Cabriolet (13-16), A4 (08-15), A4 Quattro (12-15), A5 (09-11), A5 Sportback (09-16), A5 Cabriolet (09-12), A5 Coupe (13-16), Q5 (05-17), TT (15-18); Seat: Alhambra (11-16), Altea, Altea XL & Altea Freerack (09-16), Exeo (09-16), Leon (09-17), Leon ST (13-17); Skoda: Octavia II (08-13), Octavia III (13-17), Superb II (08-15), Superb III (15-17), Yeti (13-15); VW: Beetle (13-16), CC (12-15), EOS (08-15), Golf V & VI (09-13), Golf VII (12-15), Golf Alltrack (14-17), Jetta VI (11-16), Jetta V (05-11), Passat (11-17), Tiguan (07-15), Touran (14-17)
 1.8 TFSI: CDAA, CDAB, CDHA, CDHB, CJEB, CJEE, CJA, CJSB, CJEB, 2.0 TFSI: CNCD, CNCE, CNDC, CDNB, CDNC, CFKA, CPSA

YATO		
YT-06335	3/8" (9.5 mm)	80

EN Fuel injection test kit
 PL Zestaw diagnostyczny do wtrysku paliwa
 DE Diagnosesatz für Prüfung der Kraftstoffeinspritzung
 RU Пневматический набор к тормозным зажимам
 CZ Souprava k diagnostice vstřikování paliva
 HU Diagnosztikai készlet üzemanyag - befecskendezőkhöz
 RO Set testare injectie
 FR Kit de test de débit d'injecteur
 IT Set diagnostico per iniettori la benzina
 ES Juego de herramientas diagnosticas para la inyección de combustible
 CN 燃料注射测试组套

10
PCS

0.7
MPa
(max.)



YATO		
YT-0670		10

- EN Fuel pressure tester
- PL Miernik ciśnienia paliwa
- DE Kraftstoffmessgerät
- RU Датчик давления топлива
- CZ Měřič tlaku paliva
- HU Üzemanyagnyomás-mérő
- RO Tester presiune combustibil
- FR Kit de testeur de pression d'injection de carburant
- IT Misuratore della pressione del carburante
- ES Medidor de presión de combustible
- CN 燃油压力表



20 PCS	0-1 MPa	0-140 psi
FOR DIESEL ENGINES DO SILNIKÓW DZIELA	FOR GASOLINE ENGINES DO SILNIKÓW BENZYNOWYCH	

YATO  **YT-73025**  6

- EN Compression tester
- PL Miernik ciśnienia sprężania
- DE Druckluftmessgerät
- RU Тестер компрессии
- CZ Měřič přístroj kompresního tlaku
- HU Kompresszió mérő
- RO Kit tester compresie
- FR Testeur de pression adapteur cône
- IT Manometro pressione
- ES Medidor de compresión
- CN 气缸压力表



5 PCS	2.1 MPa
M14 M18	FOR SPARK IGNITION DO ZAPALONU ISKROWEGO
RUBBER ADAPTOR ZŁĄCZACZE GUMOWE	

YATO  **YT-73011**  10

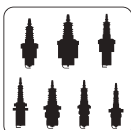







FOR ALL TYPES
DO WSZYSTKICH
TYPOW

- EN Compression pressure gauge in a diesel engine
- PL Miernik ciśnienia sprężania w silnikach diesla
- DE Kompressionsdruckmesser in Dieselmotoren
- RU Измеритель давления компрессии в дизельных двигателях
- CZ Souprava k měření kompresních tlaků v dieselových motorech
- HU Dieselmotorok kompresszióját mérő óra
- RO Tester compresie motoare diesel
- FR Testeur de pression cylindrique diesel
- IT Tester di compressione per motori diesel
- ES Medidor de presión de la compresión en los motores diesel
- CN 柴油机压力测试组套



16 PCS	7.0 MPa
FOR DIESEL ENGINES DO SILNIKÓW DZIELA	

-  70 bar, 500 mm;
-  160 mm;
-  M20x1.5: 75 mm; M22x1.5: 73 mm; M24x1.5: 88 mm; M24x2: 63 mm;
-  M10x1: 83, 91, 102, 113, 119 mm; M10x1.25: 64, 135 mm; M12x1.25: 47 mm; M22x1.5: 118 mm;
- 

YATO  **YT-7307**  5

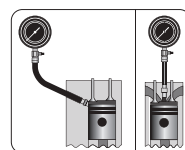

- EN Compression pressure gauge in a diesel engine
- PL Miernik ciśnienia sprężania w silnikach diesla
- DE Kompressionsdruckmesser in Dieselmotoren
- RU Измеритель давления компрессии в дизельных двигателях
- CZ Souprava k měření kompresních tlaků v dieselových motorech
- HU Dieselmotorok kompresszióját mérő óra
- RO Tester compresie motoare diesel
- FR Testeur de pression cylindrique diesel
- IT Tester di compressione per motori diesel
- ES Medidor de presión de la compresión en los motores diesel
- CN 柴油机压力测试组套



19 PCS	7.0 MPa
FOR DIESEL ENGINES DO SILNIKÓW DZIELA	

YATO  **YT-73072**  10

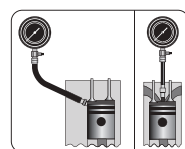

- EN Compression tester
- PL Miernik ciśnienia sprężania
- DE Druckluftmessgerät
- RU Тестер компрессии
- CZ Měřiči přístroj kompresního tlaku
- HU Kompresszió mérő
- RO Kit tester compresie
- FR Testeur de pression adapteur cône
- IT Manometro pressione
- ES Medidor de compresión
- CN 气缸压力表



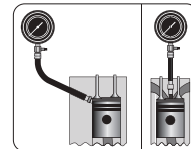

50 PCS	4.0 MPa
FOR DIESEL ENGINES DO SILNIKÓW DZIELA	FOR GASOLINE ENGINES DO SILNIKÓW BENZYNOWYCH
	



YATO  **YT-73012**  4

- EN Engine and transmission oil pressure test kit
- PL Zestaw mierników ciśnienia oleju silnika i skrzyni biegów
- DE Motor- und Öldruck-Test-Set
- RU Набор для измерения давления масла в двигателе и АКПП
- CZ Sada pro měření tlaku motorového a převodového oleje
- HU Motor- és sebességváltó olajnyomás mérő készlet
- RO Kit de testare a presiunii uleiului de motor și transmisie
- FR Kit de test de pression d'huile dans le moteur et la boîte de vitesses
- IT Kit di misuratori di pressione dell'olio nel motore e nel cambio
- ES Juego de manómetros presión de aceite en motor y caja
- CN 机油高低压测试工具



17 PCS	0-2.75 MPa	0-400 psi
0-0.7 MPa	0-100 psi	1.85m 
FOR DIESEL ENGINES DO SILNIKÓW DZIELA	FOR GASOLINE ENGINES DO SILNIKÓW BENZYNOWYCH	



Included: pressure gauges: 0-400 PSI, 0-100 PSI (2 PCS); flexible hose 185 cm; adaptors (14 PCS): 1/8-27 NPT x 2, 3/8-18 NPT (M) x 1/8-27 (F), 1/4-18 NPT (M) x 1/8-27 NPT (F), 1/4-18 NPT (M) x 1/8-27 NPT (M), 1/8-27 NPT (F), 1/8-27 NPT (M) x 1/8-27 NPT (F, elbow), M8 x 1.0 x 1/8-27 NPT (F), M10 x 1.0 x 1/8-27 NPT (F), M12 x 1.75 x 1/8-27 NPT (F), 1/8-28 BSPT x 1/8-27 NPT (F), 1/16-27 NPT (M) x 1/8-27 NPT (F)
 W zestawie: manometry: 0-400 PSI, 0-100 PSI (2 szt.); elastyczny wąż 185 cm; adaptery (14 szt.): 1/8-27 NPT x 2, 3/8-18 NPT (M) x 1/8-27 (F), 1/4-18 NPT (M) x 1/8-27 NPT (F), 1/4-18 NPT (M) x 1/8-27 NPT (M), 1/8-27 NPT (F), 1/8-27 NPT (M) x 1/8-27 NPT (F, kątowny), M8 x 1.0 x 1/8-27 NPT (F), M10 x 1.0 x 1/8-27 NPT (F), M12 x 1.75 x 1/8-27 NPT (F), 1/8-28 BSPT x 1/8-27 NPT (F), 1/16-27 NPT (M) x 1/8-27 NPT (F)

YATO  **YT-73032**  10

- EN Compression tester kit
- PL Miernik ciśnienia sprężania - benzyna
- DE Kompressionsmessgerät - Ottomotoren
- RU Измеритель давления сжатия - бензин
- CZ Kompresní tlakoměr - benzín
- HU Benzin kompresszió mérő
- RO Kit tester compresie
- FR Manomètre de compression pour moteur à essence
- IT Tester di compressione per motori a benzina
- ES Medidor de presión de compresión, gasolina
- CN 汽油压力表





8 PCS	0-2 MPa	0-300 psi
		FOR GASOLINE ENGINES DO SILNIKÓW BENZYNOWYCH 

YATO  **YT-73022**  6

- EN Oil combustion spraying pressure meter
- PL Miernik ciśnienia wtrysku paliwa
- DE Kraftstoff-Einspritzdruckmessgerät
- RU Измеритель давления впрыска топлива
- CZ Měřič tlaku vstřikování paliva
- HU Üzemanyag befecskendező nyomásmérő
- RO Kit masurare presiune injectoare
- FR Manomètre de pression d'injection du carburant
- IT Misuratore della pressione di iniezione del carburante
- ES Medidor de presión de inyección de combustible
- CN 燃油喷射压力表



9 PCS	0-0.7 MPa	0-100 psi
		

YATO  **YT-73024**  10

- EN Oil combustion spraying pressure meter
- PL Miernik ciśnienia wtrysku paliwa
- DE Kraftstoff-Einspritzdruckmessgerät
- RU Измеритель давления впрыска топлива
- CZ Měřič tlaku vstřikování paliva
- HU Üzemanyag befecskendező nyomásmérő
- RO Kit măsurare presiune injectoare
- FR Manomètre de pression d'injection du carburant
- IT Misuratore della pressione di iniezione del carburante
- ES Medidor de presión de inyección de combustible
- CN 燃油喷射压力表





10 PCS **0-0.7** MPa **0-100** psi 

YATO  **YT-73023**  10

- EN Vacuum and fuel pump tester
- PL Wakuometr - miernik pomiaru ciśnienia i podciśnienia
- DE Vakuummessgerät - Druck- und Unterdruckmessgerät
- RU Вакуумметр - прибор для измерения давления и вакуума
- CZ Vakuové měřidlo - zařízení pro měření tlaku a podtlaku
- HU Nyomásmérő és vákuummérő
- RO Tester pompa combustibil
- FR Vacuomètre - manomètre de mesure de pression et de dépression
- IT Vacuometro - misuratore della pressione-depressione
- ES Vacuómetro: medidor de presión y presión negativa
- CN 真空压力表





9 PCS **0-0.1** MPa **0-14** psi 

YATO  **YT-73050**  10



- EN Oil pressure tester
- PL Miernik ciśnienia oleju
- DE Öldruckanzeige
- RU Тестер давления масла с адаптерами
- CZ Tester tlaku oleje
- HU Olajnyomásmérő készlet
- RO Tester presiune ulei
- FR Set de testeurs de pression d'huile
- IT Tester misurazione pressione dell'olio
- ES Manómetro de aceite
- CN 自动波箱压力表

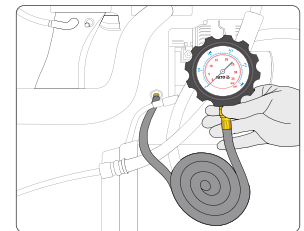

12 PCS **3.5** MPa **185cm** 

FOR ALL TYPES OF ENGINES
DO WSKAZKACH TYPOW SILNIKOW 



YATO  **YT-73030**  10

- EN Oil pressure tester
- PL Miernik ciśnienia oleju
- DE Öldruckanzeige
- RU Тестер давления масла с адаптерами
- CZ Tester tlaku oleje
- HU Olajnyomásmérő készlet
- RO Tester presiune ulei
- FR Set de testeurs de pression d'huile
- IT Tester misurazione pressione dell'olio
- ES Manómetro de aceite
- CN 油压压力表



12 PCS **0-1** MPa **0-140** psi **125cm**  FOR ALL TYPES OF ENGINES DO WSKAZKACH TYPOW SILNIKOW 

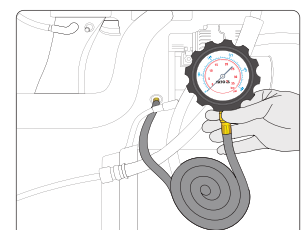

YATO  **YT-73031**  10

Adapters / Adaptery: R1/8 DIN 2999; 1/8" 27 NPT; 1/4" 18 NPT; 3/8" 20 UNF; 1/2" 20 UNF; M10 x 1.0; M12 x 1.5; M14 x 1.5; M16 x 1.5; M18 x 1.5

- EN Cylinder leak detector
- PL Zestaw do pomiaru szczelności cylindrów
- DE Zylinder-Druckverlust-Tester
- RU Набор для измерения герметичности цилиндра
- CZ Sada pro měření těsnosti válců
- HU Kompresszióvégyomás-mérő készlet
- RO Tester etanșeitate cilindri
- FR Ensemble de mesure d'étanchéité des vérins
- IT Kit per la misura di tenuta cilindri
- ES Kit para medir fugas de cilindros
- CN 汽缸测漏表



4 PCS	0.7 MPa	FOR GASOLINE ENGINES DO SIŁNIKÓW BENZYNOWYCH	STANDARD	
-----------------	-------------------	--	----------	--

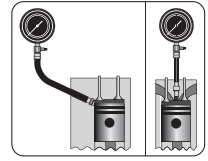

YATO **YT-73055** 5

- EN Common cool gas meter
- PL Zestaw do obsługi systemów klimatyzacji
- DE Bedienungssatz für Klimasysteme
- RU Комплект для эксплуатации систем кондиционирования
- CZ Sada pro obsluhu klimatizačních systémů
- HU Klíma szivárgáskereső készlet
- RO Set Intretinere aer condiționat
- FR Ensemble pour la maintenance des systèmes de climatisation
- IT Kit manutenzione per impianto aria condizionata
- ES Kit de operación de sistemas de aire acondicionado
- CN 冷媒表



6 PCS	x3 145cm
R-134a	0-0.8 MPa
0-120 psi	0-3.4 MPa
0-500 psi	

YATO **YT-72990** 6

- EN Ozone generator
- PL Generator ozonu
- DE Ozon-Generator
- RU Генератор озона
- CZ Generátor ozónu
- HU Ózongenerátor
- RO Generator ozon
- FR Générateur d'ozone
- IT Generatore di ozono
- ES Generador de ozono
- CN 臭氧机

110-230V-50/60Hz	220 W	10 g/h	0-90 min	
------------------	-----------------	------------------	----------	--



YATO [W] **YT-73350** 220 4

- EN Induction heater
- PL Nagrzewnica indukcyjna
- DE Induktionsheizgerät
- RU Индукционный нагреватель
- CZ Indukční ohřivač
- HU Indukciós fűtőkészülék
- RO Încălzitor cu inducție
- FR Appareil de chauffage par induction
- IT Riscaldatore a induzione
- ES Calentador de inducción
- CN 便携式感应加热器



9 PCS
230-240V-50/60Hz
1000 W
LED
x8

Ø 30 mm (2 PCS), Ø 40 mm (2 PCS), Ø 50 mm (2 PCS), wire / przewód (L=750 mm; 2 PCS)

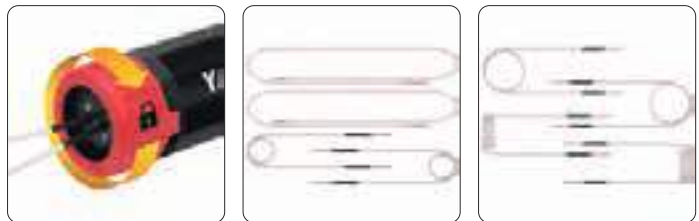

YATO [W] **YT-05880** 1000 6

- EN Induction coil set for induction heater
- PL Zestaw cewek do nagrzewnicy indukcyjnej
- DE Induktions-Spulen-Satz für Induktionsheizgerät
- RU Катушки для индукционного нагревателя
- CZ Sada civek pro indukční ohřivač
- HU Tekerészlet indukciós fűtőkészülékhez
- RO Set bobină pt. încălzitor cu inducție
- FR Kit de bobines pour l'appareil de chauffage par induction
- IT Set di bobine per riscaldatore a induzione
- ES Conjunto de bobinas para calentador de inducción
- CN 感应线圈套装



x8	
----	--

For YT-05880
Dla YT-05880
Ø 30 mm (2 PCS), Ø 40 mm (2 PCS), Ø 50 mm (2 PCS), wire / przewód (L=750 mm; 2 PCS)

YATO **YT-05881** 30

EN Compression tester
PL Miernik ciśnienia sprężania
DE Druckluftmessgerät
RU Тестер компрессии
CZ Měřicí přístroj kompresního tlaku
HU Kompresszió mérő
RO Aparat de măsurareea presiunii
FR Testeur de pression adapteur cône
IT Manometro pressione
ES Medidor de compresión
CN 气缸压力表



2.1 MPa
FOR SPARK IGNITION DO ZAPŁONU ISKROWEGO
RUBBER CONNECTOR ZŁĄCZE GUMOWE

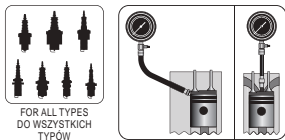

YATO
YT-7300 24/48

EN Compression tester
PL Miernik ciśnienia sprężania
DE Druckluftmessgerät
RU Тестер компрессии
CZ Měřicí přístroj kompresního tlaku
HU Kompresszió mérő
RO Aparat de măsurareea presiunii
FR Testeur de pression adapteur cône
IT Manometro pressione
ES Medidor de compresión
CN 气缸压力表组套

2.1 MPa
FOR SPARK IGNITION DO ZAPŁONU ISKROWEGO
THREADED ADAPTER ZŁĄCZE GWINTOWANE
RUBBER CONNECTOR ZŁĄCZE GUMOWE

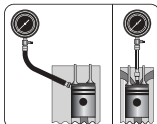

YATO
YT-7302 6/24

EN Flow meter common rail adapter set
PL Przelewowy zestaw diagnostyczny do wtryskiwaczy Common Rail
DE Überlauf-Diagnosesatz für Einspritzdüse Common Rail
RU Диагностический набор к форсункам Common Rail переливной
CZ Souprava na diagnostiku vstříkovačů Common Rail průtoková
HU Diagnosztikai készlet Common Rail injektorokhoz, átfolyós
RO Set diagnostic preaplin pt. injectoare Common Rail
FR Kit de test de débit d'injecteur Common Rail
IT Set controllo portata iniettori Common Rail
ES Juego diagnóstico de flujo para inyectores Common Rail
CN 柴油燃油喷嘴检测工具

31 PCS
FOR 6 CYLINDERS DO 6 CYLINDRÓW



YATO
YT-7306 5

EN Compression tester
PL Miernik ciśnienia sprężania
DE Druckluftmessgerät
RU Тестер компрессии
CZ Měřicí přístroj kompresního tlaku
HU Kompresszió mérő
RO Aparat de măsurareea presiunii
FR Testeur de pression adapteur cône
IT Manometro pressione
ES Medidor de compresión
CN 气缸压力表

2.1 MPa
FOR SPARK IGNITION DO ZAPŁONU ISKROWEGO
THREADED ADAPTER ZŁĄCZE GWINTOWANE

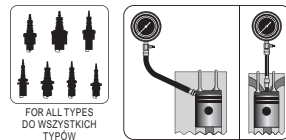

YATO
YT-7301 12/24

EN Injecton nozzle tester
PL Tester wtryskiwaczy
DE Einspritz-Tester
RU Тестер форсунок
CZ Tester vstříkovačů
HU Porlasztó vizsgáló tesztler
RO Tester de duze de injectie
FR Testeur d'injecteur de carburant
IT Tester per iniettori
ES Comprobador de inyectoros
CN 喷嘴校检器

60 MPa (max.)
600 ml
M12
M14
FOR DIESEL ENGINES DO SILNIKÓW DIELA



YATO
YT-72963 4

EN Diesel fuel pump timing set
PL Prząd do regulacji pomp wtryskowych
DE Vorrichtung zur Einspritzpumpeneinstellung
RU Инструмент для регулировки ТНВД
CZ Nástroj pro regulaci vstříkovačů čerpadel
HU Befecskendező szivattyú beállító szerszám
RO Set reglare injectie
FR Outil de réglage des pompes d'injection
IT Strumento di regolazione pompa di iniezione
ES Herramienta de ajuste de bombas de inyección
CN 柴油喷射泵校正器

10 PCS
+/- 0.01 mm



For fuel pump: Bosch, Denso, Lukas, Nippon
Dla pomp: Bosch, Denso, Lukas, Nippon

YATO
YT-05337 5

- EN Combined sockets for alternator
- PL Zestaw do alternatorów ze sprzęgłem
- DE Werkzeugsatz für Lichtmaschine
- RU Набор для альтернатора
- CZ Souprava na opravu alternátoru
- HU Generátor szerszámkészlet
- RO Set chei pt. alternator
- FR Set de clés à l'alternateur avec l'embrayage
- IT Set di chiavi per smontaggio puleggia e alternatore
- ES Enchufes combinados para alternador
- CN 发动机拆卸组套

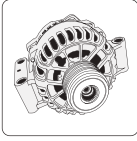

- 1/2" (12.7 mm): M10, HBS, 33T, L=110 mm; CrV; HRC 40-44;
- 1/2" (12.7 mm): T50, HBS, 33T, L=110 mm; CrV; HRC 40-44;
- M8, M10, L=75 mm; 8660; HRC 53-57;
- T40, T50, L=75 mm; 8660; HRC 53-57;
- H8, H10, L=75 mm; 8660; HRC 53-57;
- H15, 33T, L=30 mm; CrV; HRC 40-44;
- H22, 33T, L=30 mm; CrV; HRC 40-44;
- H22, L=30 mm; S45C; HRC 38-42;
- Ø 35 x 30 mm; CrV; HRC 40-44;
- 1/2" (12.7 mm) x 10 mm; CrV; HRC 40-44



13 PCS	1/2" 12.7mm
	CrV
HRC 40-44	S45C
HRC 38-42	8660 HIGH-CARBON STEEL EHL WINDENWELLEN
HRC 53-57	

YATO	○	
YT-0421	1/2" (12.7 mm)	15

- EN Combined sockets for alternator
- PL Zestaw do alternatorów ze sprzęgłem
- DE Werkzeugsatz für Lichtmaschine
- RU Набор для альтернатора
- CZ Souprava na opravu alternátoru
- HU Generátor szerszámkészlet
- RO Set chei pt. alternator
- FR Set de clés à l'alternateur avec l'embrayage
- IT Set di chiavi per smontaggio puleggia e alternatore
- ES Enchufes combinados para alternador
- CN 发动机拆卸组套

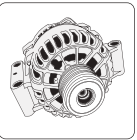

- 1/2" (12.7 mm): M10, HBS, 33T, L=113 mm; CrV; HRC 40-44 / 8660; HRC 53-57;
- 1/2" (12.7 mm): T50, HBS, 33T, L=113 mm; CrV; HRC 40-44 / 8660; HRC 53-57;
- 3/8" (10 mm): M10, HBS, 33T, L=80 mm; CrV; HRC 40-44 / 8660; HRC 53-57;
- 1/2" (12.5 mm): M10, HBS, 33T, L=140 mm; CrV; HRC 40-44;
- M8, M10, L=75 mm; 8660; HRC 53-57;
- T40, T50, L=75 mm; 8660; HRC 53-57;
- H8, H10, L=75 mm; 8660; HRC 53-57;
- M8xH12, L=64 mm; 8660; HRC 53-57;
- H15, 33T, Ø 17 mm, L=30 mm, H15, 33T, Ø 19 mm, L=30 mm, H22, 33T, Ø 19 mm, L=30 mm; CrV; HRC 40-44;
- H17, H22, L=30 mm; S45C; HRC 38-42;
- Ø 35 x 30 mm; S45C; HRC 38-42;
- Ø 38 mm; S45C; HRC 38-42;
- H19x28, H21x28, H22x28; S45C; HRC 38-42;
- 1/2" (12.5 mm) (F) x H10 mm (F); CrV; HRC 40-44



22 PCS	1/2" 12.7mm
CrV	HRC 40-44
S45C	HRC 38-42
8660 HIGH-CARBON STEEL EHL WINDENWELLEN	HRC 53-57

YATO	○	
YT-04211	3/8" (9.5 mm), 1/2" (12.7 mm)	5

- EN Stroboscopic tube
- PL Lampa stroboskopowa
- DE Stroboskoplampe
- RU Стробоскопная лампа
- CZ Stroboskopická lampka
- HU Stroboszkóp lámpa

- RO Lampă stroboscopică
- FR Lampe stroboscopique
- IT Lampada stroboscopica
- ES Tubo estroboscópico
- CN 点火正时灯

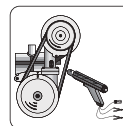

12V	max 8000 min		
		XENON	



0-60°

YATO	
YT-7310	6/12

YATO	
YT-7311	6/12

YATO	
YT-7312	6/12

EN Universal radiator pressure kit
PL Zestaw diagnostyczny do chłodnicy
DE Diagnoseatz für Kühler
RU Диагностический набор к радиатору
CZ Souprava k diagnostice chladiče
HU Diagnosztikai készlet hűtőkhöz
RO Ansamblu pt. diagnosticarea radiatorului
FR Set diagnostique pour radiateur de voiture
IT Set universale tester pressione del radiatore
ES Juego de herramientas diagnosticas para el radiador
CN 万用水箱压力测试组套

14 PCS 0.25 MPa (max.) max°C 200 

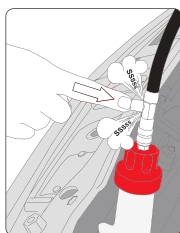
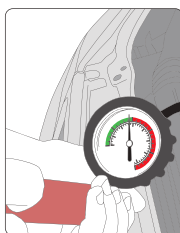
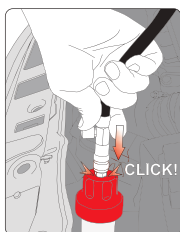

 Acura, Alfa Romeo, Audi, BMW, Chrysler, Citroen, Fiat, Ford, General Motors, GEO, Honda, Infiniti, Isuzu, Jaguar, Jeep, Land Rover, Mazda, Mercedes, Mitsubishi, Nissan, Opel, Peugeot, Porsche, Renault, Saab, Subaru, Suzuki, Toyota, Volkswagen, Volvo

YATO 

YT-0672

4

EN Cooling system vacuum purge and refill kit
PL Zestaw do próżniowego napełniania układu chłodzenia
DE Kühlsystem Vakuum Entleer- und Befüll-Set
RU Комплект для вакуумной заправки системы охлаждения
CZ Sada pro vakuové plnění chladicího systému
HU Vákuumos hűtőrendszer feltöltő
RO Kit încarcare și aerisire sistem aer condiționat
FR Kit d'outils de remplissage sous vide de liquide de refroidissement
IT Kit di riempimento del sistema di raffreddamento sottovuoto
ES Kit de llenado al vacío del sistema de refrigeración
CN 防冻液加注器

3 PCS -1 bar  

EN Water tank leak detector
PL Zestaw do diagnostyki i obsługi układu chłodzenia
DE Diagnose- und Wartungssatz für Kühlkreis
RU Комплект для диагностики и обслуживания системы охлаждения
CZ Sada pro diagnostiku a servis chladicího systému
HU Hűtőrendszer diagnosztikai és szerviz készlet
RO Set diagnosticare sistem răcire
FR Kit de diagnostic de système de refroidissement
IT Kit di diagnostica e utilizzo del sistema di raffreddamento
ES Kit de diagnóstico y manejo del sistema de refrigeración
CN 水箱检测仪

28 PCS 0.25 MPa (max.) 



YATO 

YT-72995

10

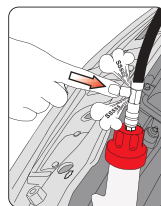
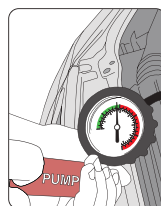
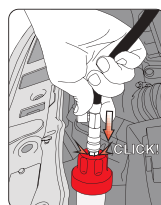

 Acura, Alfa Romeo, Audi: A4, A5, A6; Audi VW (1975-1993); BMW: 345, E32, E34, E36, E38, E39, E46, E60, E63, E64, E65, E90; Buick; Cadillac; Chevrolet; Citroen; Chrysler; Daewoo; Dodge; Eagle; Fiat; Ford: C-Max, Focus, Mondeo, USA versions etc.; General Motors; GMC; Honda; Hummer; Hyundai; Infiniti; International; Isuzu; Jaguar; Jeep; Kia; Land Rover; Lexus; Lincoln; Mazda: M3 etc.; Mercedes-Benz: A, C, E, M, S Class (W140, W168, W210, W211, W215, W216, W220, R230), W123, W124, W201, Vito; Mercury; Mini; Mini Cooper; Mitsubishi; Nissan: Oldsmobile; Opel; Peugeot; Pontiac; Porsche: Cayenne etc.; Renault; Saab; Saturn; Ssangyong; Sterling; Subaru; Suzuki; Toyota: Celica, MR2, Previa, RAV4 etc.; Vauxhall; Volvo; VW: Beate, Golf, Passat (1996, 1997-2002), Sharan (1.8T, 2.8), T4, Vento

YATO 

YT-06721

3

- EN Cooling system vacuum purge and refill kit
- PL Zestaw do próżniowego napełniania układu chłodzenia
- DE Kühlsystem Vakuum Entleer- und Befüll-Set
- RU Комплект для вакуумной заправки системы охлаждения
- CZ Sada pro vakuové plnění chladicího systému
- HU Vákuumos hűtőrendszer feltöltő
- RO Kit încărcare și aerisire sistem aer condiționat
- FR Kit d'outils de remplissage sous vide de liquide de refroidissement
- IT Kit di riempimento del sistema di raffreddamento sottovuoto
- ES Kit de llenado al vacío del sistema de refrigeración
- CN 防冻液加注器



6
PCS

-1
bar

30-48
mm



YATO 

YT-72996



10

- EN Water pump tester
- PL Tester pompy wodnej i układu chłodzenia
- DE Wasserpumpen- und Kühlsystemtester
- RU Тестер водяного насоса системы охлаждения
- CZ Tester vodního čerpadla chladicího systému
- HU Vízpumpa-vizsgáló készlet
- RO Set diagnosticare sistem răcire și pompă de apă
- FR Testeur de pompe à eau et système de refroidissement
- IT Tester della pompa dell'acqua nel sistema di raffreddamento
- ES Probador para bombas de agua y circuito de refrigeración
- CN 水泵测试工具



8
PCS

0-0.1
MPa

0-15
psi



YATO 

YT-73065



10

- EN Hand-held vacuum pump
- PL Pompka podciśnieniowa z akcesoriami
- DE Unterdruckpumpe mit Zubehör
- RU Насос вакуумметрического давления с принадлежностями
- CZ Podtlaková-tlaková pumpa s příslušenstvím
- HU Vákuum- és ac-pumpa mérő, tartozékokkal
- RO Pompa de vidare cu accesorii
- FR Pompe à vide avec les accessoires
- IT Pompa a pressione con accessori
- ES Bomba de subpresión con accesorios
- CN 手持式真空泵

16
PCS

-1-0
bar



YATO 

YT-0673



10

- EN Hand-held vacuum pump
- PL Pompka ciśnieniowo-podciśnieniowa z akcesoriami
- DE Unterdruck-druckpumpe mit Zubehör
- RU Насос вакуумметрического давления с принадлежностями
- CZ Podtlaková-tlaková pumpa s příslušenstvím
- HU Vákuum- és ac-pumpa mérő, tartozékokkal
- RO Pompa de vidare cu accesorii
- FR Pompe à vide avec les accessoires
- IT Pompa a pressione con accessori
- ES Bomba de subpresión-presión con accesorios
- CN 手持式真空泵

22
PCS

-1-3
bar



YATO 

YT-0674



5

EN Flexible line clamp
PL Zestaw zacisków do przewodów z cieczą
DE Schlauchklemmensatz
RU Набор зажимов с фиксатором
CZ Sada hadicových svěrek
HU Flexibilis cső elszorító készlet
RO Set clești blocare furtun
FR Set de pices pour serrer les
IT Set pinze per chiudere momentaneamente i manicotti
ES Juego de alicates apretadores para conductos de líquidos
CN 油管封口钳组套





- 1/4"-3/4" (6.3-19 mm) – for brake and fuel lines
- 1/2"-5/4" (12.5-32 mm) – for flexible hose
- 3/4"-9/4" (19-57 mm) – for radiator hose clamp
- 1/4"-3/4" (6.3-19 mm) – do przewodów hamulcowych i paliwowych
- 1/2"-5/4" (12.5-32 mm) – do przewodów elastycznych
- 3/4"-9/4" (19-57 mm) – do przewodu chłodnicy

YATO  
YT-0840 25/50

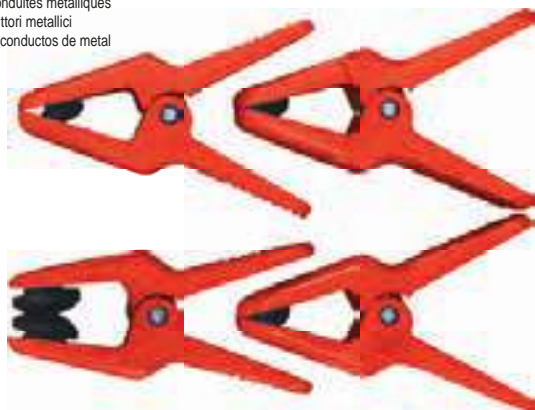

EN Steel line clamp
PL Zaciski do przewodów metalowych
DE Klemmen für Leitungen aus Metall
RU Клеммы для металлических проводов
CZ Svorky pro kovové vodiče
HU Csipesz fém vezetékhez
RO Set pt. blocare conducte de combustibil și frână
FR Pince d'arrêt de conduites métalliques
IT Morsetti per conduttori metallici
ES Abrazaderas para conductos de metal
CN 油管夹



YATO  
YT-08390 10/20

EN Fuel line clamp and stopper kit
PL Zestaw zacisków do przewodów metalowych i elastycznych
DE Satz von Klemmen für flexible Leitungen und Leitungen aus Metall
RU Набор клемм для металлических и гибких проводов
CZ Sada svorek pro kovové a elastické vodiče
HU Csipeszkészlet fém és rugalmas vezetékhez
RO Cleme pt. conducte combustibil si kit opritor
FR Ensemble de pinces d'arrêt de conduites métalliques et en plastique
IT Morsetti per conduttori metallici elastici
ES Juego de abrazaderas para conductos de metal y flexibles
CN 燃油管夹



YATO  
YT-08392 5

EN Flexible line clamp
PL Zestaw zacisków do przewodów z cieczą
DE Schlauchklemmensatz
RU Набор зажимов с фиксатором
CZ Sada hadicových svěrek
HU Flexibilis cső elszorító készlet
RO Set clești blocare furtun
FR Set de pices pour serrer les
IT Set pinze per chiudere momentaneamente i manicotti
ES Juego de alicates apretadores para conductos de líquidos
CN 油管夹

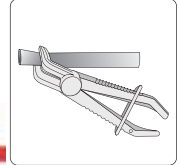



- Max. 13 mm – for brake and fuel lines
- Max. 17 mm – for flexible hose
- Max. 32 mm – for radiator hose clamp
- Max. 13 mm – do przewodów hamulcowych i paliwowych
- Max. 17 mm – do przewodów elastycznych
- Max. 32 mm – do przewodu chłodnicy

YATO  
YT-08403 5/15

EN Steel line clamp
PL Zaciski do przewodów metalowych
DE Klemmen für Leitungen aus Metall
RU Клеммы для металлических проводов
CZ Svorky pro kovové vodiče
HU Csipesz fém vezetékhez
RO Set pt. blocare conducte de combustibil și frână
FR Pince d'arrêt de conduites métalliques
IT Morsetti per conduttori metallici
ES Abrazaderas para conductos de metal
CN 油管夹



YATO  
YT-08391 10

- EN Spark plug socket
- PL Nasadka do świec
- DE Steckschlüssel mit Gummihalterung
- RU Головка свечная
- CZ Nastavec pro svíčky
- HU Gyújtógyertyya toldalék
- RO Cheie de bujii
- FR Douille à bougies
- IT Chiave a bussola per candele
- ES Boquilla de bujías
- CN 火花塞套筒

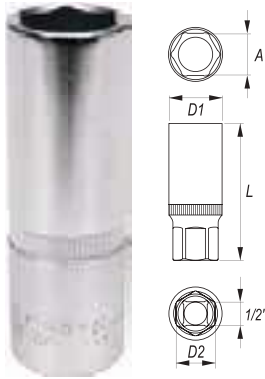

1/2"
12.7mm

DIN 3121 **CrV 50BV30**

AS-DRIVE

- EN Spark plug socket
- PL Nasadka do świec
- DE Steckschlüssel mit Gummihalterung
- RU Головка свечная
- CZ Nastavec pro svíčky
- HU Gyújtógyertyya toldalék
- RO Cheie de bujii
- FR Douille à bougies
- IT Chiave a bussola per candele
- ES Boquilla de bujías
- CN 火花塞套筒



1/2"
12.7mm

CrV 50BV30 **AS-DRIVE**

YATO	Ø	A [mm]	D1 [mm]	D2 [mm]	L [mm]	PCS	ROZM.
YT-1253	1/2" (12.7 mm)	16	22	19	64	10	50/100
YT-1254	1/2" (12.7 mm)	21	27.8	24	64	10	50/100

YATO	Ø	A [mm]	D1 [mm]	D2 [mm]	L [mm]	PCS	ROZM.
YT-12531	1/2" (12.7 mm)	16	22.0	19	64	10/160	
YT-12541	1/2" (12.7 mm)	21	27.8	24	64	10/120	

- EN Spark plug socket
- PL Nasadka do świec
- DE Steckschlüssel mit Gummihalterung
- RU Головка свечная
- CZ Nastavec pro svíčky
- HU Gyújtógyertyya toldalék
- RO Cheie de bujii
- FR Douille à bougies
- IT Chiave a bussola per candele
- ES Boquilla de bujías
- CN 六角火花塞套筒



3/8"
9.5 mm

16 mm **DIN 3121**

CrV 50BV30 **AS-DRIVE**

- EN Spark plug socket
- PL Nasadka do świec
- DE Steckschlüssel mit Gummihalterung
- RU Головка свечная
- CZ Nastavec pro svíčky
- HU Gyújtógyertyya toldalék
- RO Cheie de bujii
- FR Douille à bougies
- IT Chiave a bussola per candele
- ES Boquilla de bujías
- CN 六角火花塞套筒



3/8"
9.5 mm

DIN 3124 **CrV 6140**

AS-DRIVE

YATO	Ø	A [mm]	D1 [mm]	D2 [mm]	L [mm]	PCS	ROZM.
YT-3851	3/8" (9.5 mm)	16	22	19	64	10	50/100

YATO	Ø	A [mm]	D1 [mm]	D2 [mm]	L [mm]	PCS	ROZM.
YT-3841	3/8" (9.5 mm)	18	25.8	19	63	10	50/100

16

- EN Spark plug socket
- PL Nasadka do świec
- DE Steckschlüssel mit Gummihalterung
- RU Головка свечная
- CZ Nastavec pro svíčky
- HU Gyújtógyertyya toldalék
- RO Cheie de bujii
- FR Douille à bougies
- IT Chiave a bussola per candele
- ES Boquilla de bujías
- CN 磁性十二角薄壁火花塞套筒

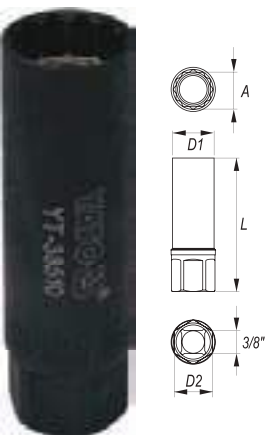

3/8"
9.5 mm

16 mm **14 mm**

THIN WALL CIENKA SCIANKA

AS-DRIVE

- EN Spark plug socket
- PL Nasadka do świec
- DE Steckschlüssel mit Gummihalterung
- RU Головка свечная
- CZ Nastavec pro svíčky
- HU Gyújtógyertyya toldalék
- RO Cheie de bujii
- FR Douille à bougies
- IT Chiave a bussola per candele
- ES Boquilla de bujías
- CN 磁性十二角薄壁火花塞套筒



3/8"
9.5 mm

16 mm **16 mm**

THIN WALL CIENKA SCIANKA

AS-DRIVE

YATO	Ø	A [mm]	D1 [mm]	D2 [mm]	L [mm]	PCS	ROZM.
YT-38510	3/8" (9.5 mm)	14	18	16	63	25/100	

YATO	Ø	A [mm]	D1 [mm]	D2 [mm]	L [mm]	PCS	ROZM.
YT-38511	3/8" (9.5 mm)	16	20	16	62	25/100	

- EN Spark plug socket
PL Nasadka do świec
DE Steckschlüssel mit Gummihalfterung
RU Головка свечная
CZ Nastavec pro svíčky
HU Gyújtógyertya toldalék
RO Cheie de bujii
FR Douille à bougies
IT Chiave a bussola per candele
ES Boquilla de bujías
CN 磁性万向十二角火花塞套筒

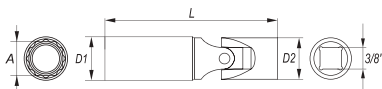
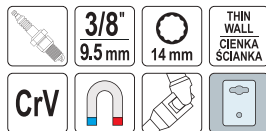

YATO	Ø	A [mm]	D1 [mm]	D2 [mm]	L [mm]	Box
YT-38512	3/8" (9.5 mm)	14	20	19	88	25/100

- EN Spark plug socket
PL Nasadka do świec
DE Steckschlüssel mit Gummihalfterung
RU Головка свечная
CZ Nastavec pro svíčky
HU Gyújtógyertya toldalék
RO Cheie de bujii
FR Douille à bougies
IT Chiave a bussola per candele
ES Boquilla de bujías
CN 火花塞套筒

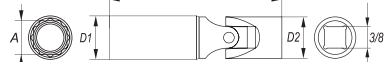
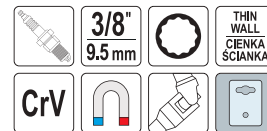

YATO	Ø	A [mm]	D1 [mm]	D2 [mm]	L [mm]	Box
YT-38516	3/8" (9.5 mm)	14	19	19	98	25/100
YT-38517	3/8" (9.5 mm)	16	20	19	98	25/100

- EN Spark plug socket
PL Klucz do świec z przedłużką
DE Kerzenschlüssel mit Verlängerungshebel
RU Ключ свечной с удлинителем
CZ Klíč na svíčky s prodlužovacím nástavcem
HU Gyertyakulcs hosszabbítóval
RO Cheie cu prelungitor, pt. bujii
FR Douille à bougies
IT Chiavi per candele a tubo
ES Llave para las bujías con extensión
CN 加长带磁方向火星



YATO	A [mm]	L [mm]	Box
YT-0817	16	290	10/40

- EN Extra long spark plug socket
PL Nasadka do świec extra długa
DE Zündkerzensteckschlüssel, extra lang
RU Удлиненная насадка для свеч
CZ Násada do svíčky extra dlouhá
HU Gyertyakulcs extra hosszú
RO Cheie bujii lunga
FR Douille pour bougie d'allumage extra longue
IT Chiave a bussola per candele extra lungo
ES Vaso para bujías extra largo
CN 十二角加长火花塞磁钢款



YATO	A [mm]	Box
YT-38521	14	12/48
YT-38522	16	12/48

- EN Spark plug socket
PL Klucz do świec z przedłużką
DE Kerzenschlüssel mit Verlängerungshebel
RU Ключ свечной с удлинителем
CZ Klíč na svíčky s prodlužovacím nástavcem
HU Gyertyakulcs hosszabbítóval
RO Cheie cu prelungitor pt. bujii
FR Douille à bougies
IT Chiavi per candele a tubo
ES Llave para las bujías con extensión
CN 加长带磁方向火星



YATO	A [mm]	Box
YT-08163	14	15/60
YT-08164	16	15/60
YT-0818	18	10/40

- EN Spark plug socket set
PL Zestaw nasadek do świec
DE Satz der Zündkerzenaufsätze
RU Набор головок для свечей накаливания
CZ Sada nástavců na svíčky
HU Gyújtógyertya-kulcs készlet
RO Set chei pt. bujii
FR Ensemble d'embouts pour bougies d'allumage
IT Set di prese per candele di accensione
ES Juego de casquillos para bujías
CN 摇头火花塞组套



3/8" (9.5 mm): 14, 16, 18, 21 mm

YATO	Ø	Box
YT-38520	3/8" (9.5 mm)	5/20

- EN Joined glow plug socket set
PL Zestaw kluczy do świec żarowych
DE Schlüsselset für Glühkerzen
RU Набор ключей к калильным свечам
CZ Sada klíčů na žhavicí svíčky
HU Gyertyakulcs készlet
RO Set chei pt. bujii incandescente
FR Set de douilles à bougies
IT Set chiavi a bussola snodate per candele
ES Juego de llaves para bujías incandescentes
CN 预热火花塞套筒组套

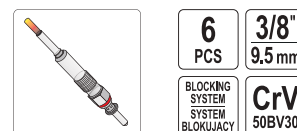

3/8" (9.5 mm): 8, 9, 10, 12, 14, 16 mm

YATO	Ø	Box
YT-0534	3/8" (9.5 mm)	10

EN Joined glow plug socket set
 PL Zestaw kluczy do świec żarowych
 DE Schlüsselsatz für Glühkerzen
 RU Набор ключей к калильным свечам
 CZ Sada klíčů na žhavičí svíčky
 HU Gyertyakulcs készlet
 RO Set chei pt. bujii incandescente
 FR Set de douilles à bougies
 IT Set chiavi a bussola snodate per candele
 ES Juego de llaves para bujías incandescentes
 CN 预热火花塞套筒组套



6 PCS
 3/8" 9.5mm
 CrV



3/8" (9.5 mm): 8, 9, 10, 12, 14, 16 mm

YATO	○	
YT-05339	3/8" (9.5 mm)	10

EN Torque angle gauge
 PL Kałomierz do dokręcania śrub
 DE Winkelmesser zum Anziehen von Schrauben
 RU Угломер для подвёртывания болтов
 CZ Úhloměr k utahování šroubů
 HU Nyomaték szögmérő
 RO Calibrator pt. strâns șuruburi
 FR Rapporteur à serrers les vis
 IT Goniometro per il serraggio controllo
 ES Calibrador para apretar tornillos
 CN 扭力角度规

1/2" 12.7mm 360° CrV



YATO	○	
YT-0593	1/2" (12.7 mm)	12/48

EN Torque angle gauge with magnet
 PL Kałomierz z magnesem do klucza dynamometrycznego
 DE Winkelmesser mit Magnet für Drehmomentschlüssel
 RU Транспортёр с магнитом для динамометрического ключа
 CZ Úhloměr s magnetem na momentový klíč
 HU Mágneses szögmérő nyomatékkulcshoz
 RO Goniometru cu fixare prin magnet
 FR Rapporteur avec aimant pour clé dynamométrique
 IT Goniometro con magnete per chiave dinamometrica
 ES Escuadra para soporte de la llave dinámométrica
 CN 磁性扭力规

1/2" 12.7mm 360° 35 cm
 GRADUATION OF 2 DEGREES
 PODZIAŁKA PO 2 STOPNIE



YATO	○	
YT-05934	1/2" (12.7 mm)	10/40

EN Torque angle gauge with clamp
 PL Kałomierz z uchwytem do klucza dynamometrycznego
 DE Winkellehre mit Griff für Drehmomentschlüssel
 RU Угломер для динамометрического ключа
 CZ Úhloměr s držákem momentového klíče
 HU Fogantyús szögmérő nyomatékkulcshoz
 RO Goniometru cu fixare clemă
 FR Clé de serrage angulaire flexible avec pince, carré
 IT Goniometro per chiave dinamometrica
 ES Escuadra para soporte de la llave dinámométrica
 CN 扭力规

1/2" 12.7mm 360° 50 cm
 GRADUATION OF 2 DEGREES
 PODZIAŁKA PO 2 STOPNIE



YATO	○	
YT-05933	1/2" (12.7 mm)	6/24

EN Metal conduit bender
 PL Giętarzka do przewodów metalowych
 DE Biegevorrichtung für Metallleitungen
 RU Гибочный станок для проводов из металла
 CZ Ohybačka kovových trubek
 HU Hajlító fémvezetékhez
 RO Dispozitiv pt. indoiti tevi
 FR Cintreuse au câble de frein
 IT Piegatrice per fili metallici
 ES Dobladora de tubos de metal
 CN 弯管器

AI



125 mm max ∅ 6.0 mm ∅ 25mm

YATO	L [mm]	
YT-0813	125	24/96



235 mm max ∅ 12 mm ∅ 45mm

YATO	L [mm]	
YT-0814	235	6/48

EN Universal clutch adjustment set
 PL Zestaw do centrowania tarczy sprzęgłowej
 DE Universal-set, um die Kupplungsscheibe einstellen
 RU Комплект для центровки дисков сцепления
 CZ Univerzální sada pro nastavení spojky disk
 HU Kuplung központosító készlet
 RO Trusa pt. centrare ambreiaje
 FR Centreur d'embrayage
 IT Set di centraggio frizione
 ES Herramienta alineación embrague
 CN 离合器对孔校正器

9 PCS ∅ 11-25 mm





∅ 11, 12, 15, 17, 19, 20, 22, 25 mm

YATO		
YT-06311		20



- EN Universal clutch adjustment set
PL Zestaw do centrowania tarczy sprzęgłowej
DE Kupplungs-Zentrier-Werkzeug-Satz
RU Комплект для центровки дисков сцепления
CZ Univerzální sada pro nastavení spojky disk
HU Kuplung központosító készlet
RO Trusa pt. centrare ambreiaje
FR Centreur d'embrayage
IT Set di centraggio frizione
ES Herramienta alineación embrague
CN 离合器对孔校正器



YATO  **YT-06312**  25



- EN Universal clutch adjustment set
PL Zestaw do centrowania tarczy sprzęgłowej
DE Kupplungs-Zentrier-Werkzeug-Satz
RU Комплект для центровки дисков сцепления
CZ Univerzální sada pro nastavení spojky disk
HU Kuplung központosító készlet
RO Trusa pt. centrare ambreiaje
FR Centreur d'embrayage
IT Set di centraggio frizione
ES Herramienta alineación embrague
CN 离合器调整工具



YATO  **YT-06313**  12/24

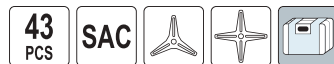

- EN SAC clutch tool set
PL Zestaw do obsługi sprzęgła SAC
DE SAC-Kupplungswartungssatz
RU Набор для обслуживания муфты SAC
CZ Servisní sada pro spojky SAC
HU SAC kuplung szerelő készlet
RO Set unelte ambreiaj SAC
FR Kit de service d'embrayage SAC
IT Set di attrezzi per smontaggio e montaggio della frizione SAC
ES Kit de manejo de embragues SAC
CN 离合器拆装工具



YATO  **YT-06315**  1



- EN DSG mechatronic unit remover
PL Przystroj do demontażu skrzyni biegów DSG
DE Demontagevorrichtung für DSG-Schaltgetriebe
RU Инструмент для разборки коробки передач DSG
CZ Nástroj pro demontáž převodovky DSG
HU DSG sebességváltó szerelő szerszám
RO Părghie indepartare unitate mecatronica DSG
FR Outil de démontage de boîte de vitesses type DSG
IT Leva per sbloccaggio cambio DSG
ES Herramienta de desmontaje de caja de cambios DGS
CN 大众奥迪DSG双离合变速箱阀体拆离器



YATO  **YT-05333**  10/40

- EN DSG double clutch tool set
PL Zestaw do wymiany sprzęgła DSG
DE DSG-Kupplungsaustauschsatz
RU Набор для замены сцепления DSG
CZ Sada na výměnu spojky DSG
HU DSG kuplung szerelő készlet
RO Set de instrumente dublu ambreiaj DSG
FR Kit de remplacement embrayage DSG
IT Set di attrezzi per smontaggio e montaggio della frizione DSG
ES Kit para reemplazo de embragues DGS
CN 大众奥迪双离合变速箱拆卸工具



YATO  **YT-06316**  2

- EN Tubing pipe bending tool pliers
- PL Giętarka do przewodów metalowych
- DE Metall-Rohrbieger
- RU Гибочный станок для металлических проводов
- CZ Ohývačka kovových vodičů
- HU Csőhajlítógó
- RO Cleste pt. indoirea conductelor
- FR Cintreuse de tuyaux métalliques
- IT Piegatrice per fili metallici
- ES Dobladora de tubos de metal
- CN 弯管器



YATO	L [mm]	
YT-08144	255	6/24

- EN Brake fluid tester
- PL Tester płynu hamulcowego
- DE Bremsflüssigkeitstester
- RU Тестер тормозной жидкости
- CZ Tester stavu brzdové kapaliny
- HU Fékfolyadék tesztler
- RO Tester lichid frana
- FR Tester de liquide de frein
- IT Tester del fluido frenante
- ES Liquido de frenos tester
- CN 刹车油检测器



YATO	
YT-72981	28/56

- EN Brake fluid tester
- PL Tester płynu hamulcowego
- DE Bremsflüssigkeitstester
- RU Тестер тормозной жидкости
- CZ Tester stavu brzdové kapaliny
- HU Fékfolyadék tesztler
- RO Tester lichid frana
- FR Tester de liquide de frein
- IT Tester del fluido frenante
- ES Liquido de frenos tester
- CN 刹车油测试仪

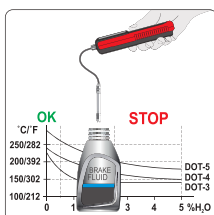
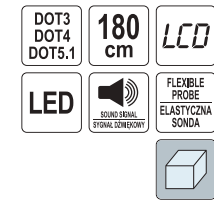

YATO	
YT-72985	10/20

- EN Brake line double flaring tool
- PL Prasa ręczna do przewodów hamulcowych
- DE Handpresse für Bremsleitungen
- RU Ручной пресс для развальцовки тормозных труб
- CZ Ruční list brzdového vedení
- HU Kézi prés fékcsőhöz

- RO Presă pt. bercurt conducte frână
- FR Presse à collet pour tuyaux de freins
- IT Pressa manuale per tubi freno
- ES Prensa manual para cables de freno
- CN 铜管扩孔器



Ø 4.75, 6.35 mm

YATO	
YT-06086	10

- EN Brake fluid tester
- PL Tester płynu hamulcowego
- DE Bremsflüssigkeitstester
- RU Тестер тормозной жидкости
- CZ Tester stavu brzdové kapaliny
- HU Fékfolyadék tesztler

- RO Tester lichid frana
- FR Tester de liquide de frein
- IT Tester del fluido frenante
- ES Liquido de frenos tester
- CN 刹车油检测器



YATO	
YT-72982	12/72

- EN Brake fluid tester
- PL Tester płynu hamulcowego
- DE Bremsflüssigkeitstester
- RU Тестер тормозной жидкости
- CZ Tester stavu brzdové kapaliny
- HU Fékfolyadék tesztler
- RO Tester lichid frana
- FR Tester de liquide de frein
- IT Tester del fluido frenante
- ES Liquido de frenos tester
- CN 刹车油检测器

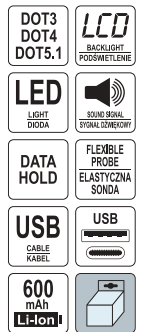

YATO	
YT-72986	28

EN Brake retainer spring tool
PL Ściągacz sprężynek szcęk hamulcowych
DE Montagewerkzeug für Bremsfeder
RU Съемник для тормозных пружин
CZ Stahovač pružin brzdových čelistí
HU Fékrugó szerelő szerszám
RO Dispozitiv pt. montaj arc saboți frână
FR Extracteur de ressorts freins
IT Freno scarpa di fissaggio a molla compressori
ES Herramienta para resorte retenedor de frenos
CN 鼓式刹车弹簧拆卸器



YATO 

YT-0685

12/96

EN Brake spring pliers kit
PL Zestaw do montażu szcęk hamulcowych
DE Bremsbacken-Montage Set
RU Набор инструментов для тормозных пружин
CZ Sada na montáž brzdových čelistí
HU Fogókészlet fékrugóhoz
RO Kit înlocuit saboți frână
FR Set pour le montage des mâchoires de freins
IT Set per montaggio molle freni
ES Juego para resortes de frenos
CN 刹车拆卸工具组套

8
PCS

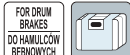

YATO 

YT-0680

4

EN Universal brake tool set
PL Zestaw do obsługi układów hamulcowych
DE Bremsbacken Montageset
RU Набор для обслуживания тормозной системы
CZ Sada pro údržbu brzdového systému
HU Fékrendszer karbantartó készlet
RO Set universal pt. sitem de frânare
FR Kit de maintenance et de montage
IT Kit di manutenzione dell'impianto frenante
ES Kit de mantenimiento del sistema de frenos
CN 制动系统调整工具组套

15
PCS

1/2"
12.7mm

3/8"
9.5mm

CrV



YATO 

YT-06802

4

EN Brake spring pliers kit
PL Zestaw do montażu szcęk hamulcowych
DE Bremsbacken-Montage Set
RU Набор инструментов для тормозных пружин
CZ Sada na montáž brzdových čelistí
HU Fogókészlet fékrugóhoz
RO Kit înlocuit saboți frână
FR Set pour le montage des mâchoires de freins
IT Set per montaggio molle freni
ES Juego para resortes de frenos
CN 刹车拆卸工具组套

3
PCS



YATO 

YT-0684

6/24

EN Interlial bent nose snap ring pliers
PL Szczypce Segera do pierścieni zacisków hamulcowych
DE Bremssattel-Sprengringzange
RU Клеши сегера для тормозных суппортов
CZ Klešiče na pojistné kroužky brzdových svorek, segerovky
HU Seeger-gyűrű fogó
RO Clește pt. siguranță etrier frână
FR Pince seger pour bagues d'étrier de frein
IT Pinza per anelli Seeger per freni
ES Alicates Seeger para anillos de las pinzas de freno
CN 挡圈钳

90°

190
mm

55
mm

BENT
WYGIĘTE



YATO 

L [mm]

YT-06561

190

4/40

EN Brake caliper press tool
PL Separator do hamulców tarczowych
DE Bremssattel-Presswerkzeug
RU Распорка тормозных дисков
CZ Přípravek na zatlačení brzdových pístků
HU Fékmunkahenger visszanyomó
RO Separator etrier frână
FR Séparateur des freins à disque
IT Separatore per pistoncini freno
ES Separador de frenos de discos
CN 棘轮制动卡钳

40-68
mm

116x60
mm

1 2 4
FOR BRAKE
CALIPER PISTONS
DOLZACZKOW
TŁOZCZKOWYCH



YATO 

YT-06805

20

EN Brake caliper press tool
PL Separator do hamulców tarczowych
DE Bremssattel-Presswerkzeug
RU Распорка тормозных дисков
CZ Přípravek na zatlačení brzdových pístků
HU Fékmunkahenger visszanyomó
RO Separator etrier frână
FR Séparateur des freins à disque
IT Separatore per pistoncini freno
ES Separador de frenos de discos
CN 棘轮制动卡钳

40-70
mm

116x55
mm

175x60
mm

1 2 4
FOR BRAKE
CALIPER PISTONS
DOLZACZKOW
TŁOZCZKOWYCH



YATO 

YT-06804

20

EN Brake caliper press tool
 PL Separator do hamulców tarczowych
 DE Bremsattel-Presswerkzeug
 RU Распорка тормозных дисков
 CZ Přípravek na zatlačení brzdových pístků
 HU Fékmunkahenger visszanyomó
 RO Separator etrier frână
 FR Séparateur des freins à disque
 IT Separatore per pistoncini freno
 ES Separador de frenos de discos
 CN 棘轮制动卡钳



YATO
 YT-06101 6/24

EN Disc brake spreader
 PL Separator do hamulców tarczowych
 DE Bremskolbenrücksteller
 RU Распорка тормозных дисков
 CZ Přípravek na zatlačení brzdových pístků
 HU Fékmunkahenger visszanyomó
 RO Dispozitiv pt. impins etrier
 FR Séparateur des freins à disque
 IT Separatore per pistoncini freno
 ES Separador de frenos de discos
 CN 刹车片分离器



YATO
 YT-0610 12/24

EN Disc brake piston tool
 PL Uniwersalny klucz do wkręcania zacisków hamulcowych
 DE Bremskolbenrücksteller universal
 RU Ключ для тормозного поршня
 CZ Univerzální klíč k montáži brzdových třmenů
 HU Féknyereg összenyomó
 RO Dispozitiv pt. impins etrier
 FR Clé universelle pour pinces de frein
 IT Attrezzo per l'arretamento della pinza dei freni
 ES Llave para comprimir pistones del freno de disco
 CN 刹车分泵拆装器



YATO
 YT-06803 12/96

EN Brake caliper piston rewind wind back adaptors
 PL Zestaw adapterów regulowanych do zacisków hamulcowych
 DE Verstellbarer Adaptersatz für Bremssättel
 RU Набор регулируемых адаптеров для тормозных суппортов
 CZ Sada nastavitelných adaptérů pro brzdové třmeny
 HU Állítható féknyereg adapter készlet
 RO Adaptor pt. piston etrier frână
 FR Kit adaptateurs ajustables pour étriers de frein
 IT Kit di adattatori regolabili per pinze di freni
 ES Juego de adaptadores ajustables para pinzas de freno
 CN 可调节分泵调整器

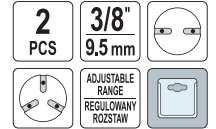

YATO
 YT-06809 10/50

EN Brake socket bit set
 PL Zestaw nasadek do zacisków hamulcowych
 DE Steckschlüssel-Set für Bremssättel
 RU Набор насадок для тормозных суппортов
 CZ Sada násadek k čištění brzdových třmenů
 HU Dugókulcs készlet féknyereg szereléshez
 RO Set chei tubulare pt. etrier frână
 FR Jeux de douilles pour les étriers de frein
 IT Kit di attacchi per pinze di freni
 ES Set de vasos para pinzas de freno
 CN 刹车制动蹄套筒组套



YATO
 YT-06807 10/20

EN Brake socket bit set
 PL Zestaw nasadek do zacisków hamulcowych
 DE Steckschlüssel-Set für Bremssättel
 RU Набор насадок для тормозных суппортов
 CZ Sada násadek k čištění brzdových třmenů
 HU Dugókulcs készlet féknyereg szereléshez
 RO Set chei tubulare pt. etrier frână
 FR Jeux de douilles pour les étriers de frein
 IT Kit di attacchi per pinze di freni
 ES Set de vasos para pinzas de freno
 CN 刹车制动蹄套筒组套



12, 14, 19 mm;
 1/2" (12.5 mm); 10 mm; CrV

YATO
 YT-06806 20

EN Brake socket bit set
 PL Zestaw nasadek do zacisków hamulcowych
 DE Steckschlüssel-Set für Bremssättel
 RU Набор насадок для тормозных суппортов
 CZ Sada násadek k čištění brzdových třmenů
 HU Dugókulcs készlet féknyereg szereléshez
 RO Set chei tubulare pt. etrier frână
 FR Jeux de douilles pour les étriers de frein
 IT Kit di attacchi per pinze di freni
 ES Set de vasos para pinzas de freno
 CN 刹车制动蹄套筒组套

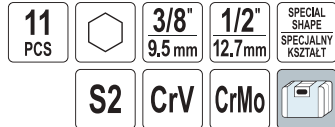

BMW, Mercedes, VAG
 1/2" (12.7 mm): 11.5, 15, 20 mm (10 points/wpustów), 22 mm (7 points/wpustów); CrMo;
 3/8" (9.5 mm): 7, 8, 9 mm; CrMo;
 3/8" (9.5 mm): 7x72, 7x92, 9x50, 11x100 mm; AISI S2 / CrV

YATO
 YT-06808 20

EN Brake cliper socket set
 PL Zestaw narzędzi do zacisków hamulcowych
 DE Bremsattel Werkzeug Satz
 RU Набор специальных головок и бит для тормозных суппортов
 CZ Sada nářadí pro brzdové čelisti
 HU Féknyereg szerelő készlet
 RO Set chei etrier de frana
 FR Jeu d'outils pour étrier de frein
 IT Kit di strumenti per pinze del freno
 ES Juego de herramientas para pinzas de freno
 CN 刹车卡钳套筒工具组套

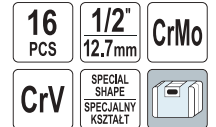

1/2" (12.7 mm): 14, 19 mm (5 points / wpustów); 14, 22 mm (7 points / wpustów); 11.5, 15, 20 mm (10 points / wpustów); CrV;
 1/2" (12.7 mm): 14, 17, 19 mm (L=45 mm); 7, 9, 11 mm (L=78 mm); CrMo;
 1/2" (12.7 mm): M14; (L=45 mm); M18 (L=78 mm); CrMo;
 1/2" (12.7 mm): 14 mm (10 points / wpustów; L=78 mm); CrMo

YATO
 YT-06811 5

- EN Disc brake pad and caliper service tool kit
PL Zestaw ręcznych separatorów do zacisków hamulcowych
DE Werkzeugsatz von manuellen Separatoren für Bremsklappen
RU Набор ручных сепараторов для тормозных зажимов
CZ Ruční sada na montáž kotoučových brzd
HU Fékmunkahenger prés készlet
RO Set de separatoare manuale pt. etrier frâna
FR Set de repousse piston de frein
IT Kit universale regolazione manuale per pistoni freni
ES Juego de separadores manuales para abrazaderas de freno
CN 刹车片分离器组套

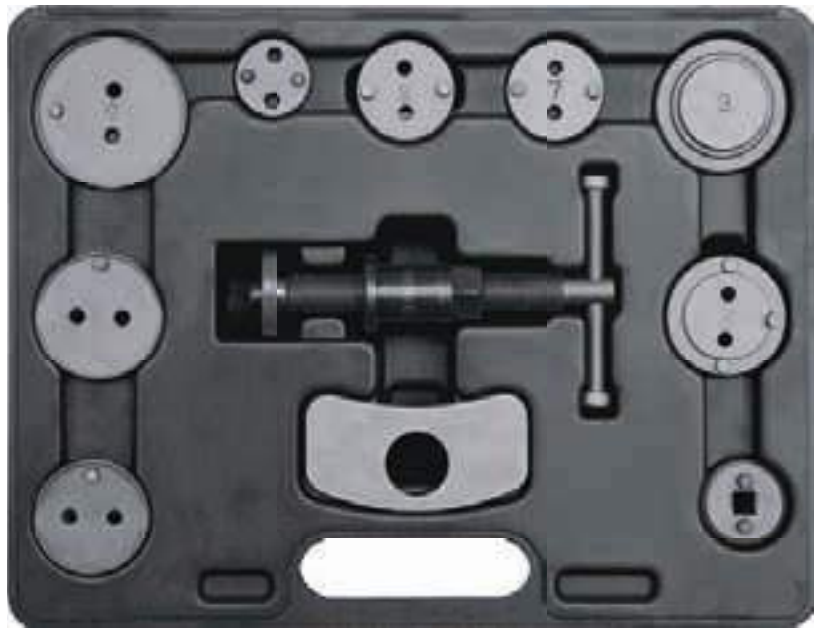
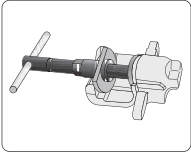

11
PCS



No.	zacisk przedni / front	zacisk tylny / rear
1-1	silownik	
1	płytkę oporową	
5	adapter z gniazdem	
2	Citroen: XM, Xantia	
3	Alfa Romeo, Audi, Austin, BMW, Honda, Jaguar, MB, Mitsubishi, Nissan, Rover, Toyota, VW	
4	Ford, Mazda, Subaru, Alfa Romeo, Saab	
6	Nissan	
7	Audi, Ford, Honda, Nissan, Rover, Saab, Subaru, VW	
8	General Motors	
9	General Motors	

YATO
YT-0681



5

- EN Disc brake pad and caliper service tool kit
PL Zestaw ręcznych separatorów do zacisków hamulcowych
DE Werkzeugsatz von manuellen Separatoren für Bremsklappen
RU Набор ручных сепараторов для тормозных зажимов
CZ Ruční sada na montáž kotoučových brzd
HU Fékmunkahenger prés készlet
RO Set de separatoare manuale pt. etrier frâna
FR Set de repousse piston de frein
IT Kit universale regolazione manuale per pistoni freni
ES Juego de separadores manuales para abrazaderas de freno
CN 刹车片分离器组套

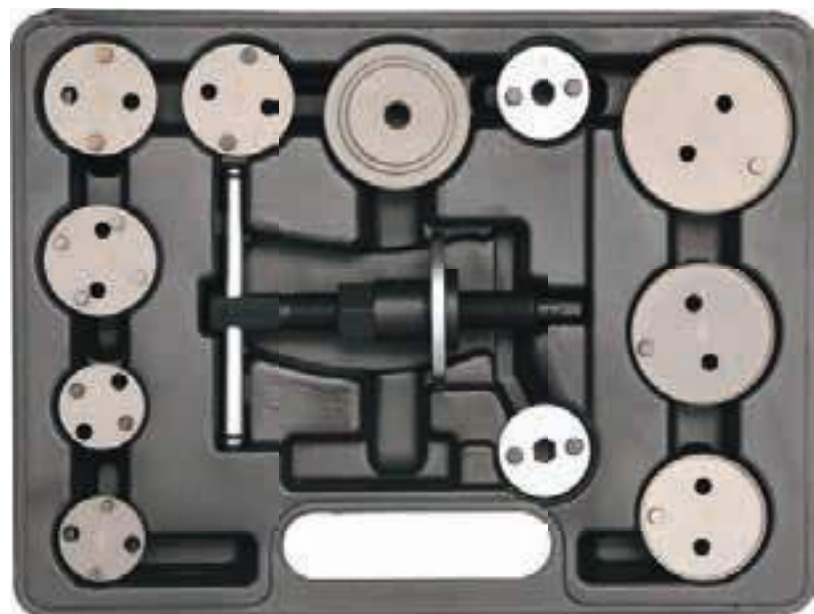
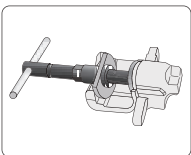

12
PCS



Nr. / No.	Zacisk przedni / Front caliper	Zacisk tylny / Rear caliper
0	General Motors - zaciski / calipers 2 1/2"	
1	Adapter do przedniego zacisku / Front caliper adapter	
2	Citroen XM, Xantia	
3	Opel	
4	Ford, Mazda, Saab, Alfa Romeo 164 2.0, Honda, General Motors	
5	Nissan Maxima	
6	Nissan Primera, VW Golf IV	
7	Audi, Rover, Subaru, Ford, Nissan, Peugeot, Toyota, VW	
8	General Motors - zaciski / calipers 1 7/8"	
9	General Motors - zaciski / calipers 2 1/8"	
11	Adapter do tylnego zacisku / Rear caliper adapter	

YATO
YT-0611



5

- EN Pneumatic brake caliper rewind tool kit
- PL Pneumatyczny zestaw do zacisków hamulcowych
- DE Pneumatik-Bremskolben-Rückstellset
- RU Пневматический набор к тормозным зажимам
- CZ Pneumatická sada k montáži koločoučových brzd
- HU Pneumatikus fékmunkahenger visszanyomó készlet
- RO Trusă pneumatică pt. cilindri etrier
- FR Set pneumatique aux séparateurs de pinces de frein
- IT Set arretratore pneumatico per pistoncini freni
- ES Juego de herramientas neumáticas para pistones de freno
- CN 气动刹车分别调整器

4
PCS

0.8
MPa
(max.)

ADJUSTABLE RANGE
REGULOWANY ROZSTAW

STANDARD

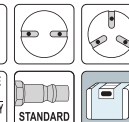

YATO 

YT-06711 

5

- EN Pneumatic brake caliper rewind tool kit
- PL Pneumatyczny zestaw do zacisków hamulcowych
- DE Pneumatik-Bremskolben-Rückstellset
- RU Пневматический набор к тормозным зажимам
- CZ Pneumatická sada k montáži koločoučových brzd
- HU Pneumatikus fékmunkahenger visszanyomó készlet
- RO Trusă pneumatică pt. cilindri etrier
- FR Set pneumatique aux séparateurs de pinces de frein
- IT Set arretratore pneumatico per pistoncini freni
- ES Juego de herramientas neumáticas para pistones de freno
- CN 气动刹车分别调整器

16
PCS

0.75
MPa

STANDARD

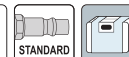
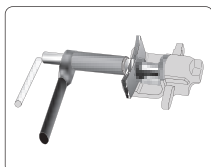
No.	zacisk przedni / front	zacisk tylny / rear
0	General Motors - zaciski 2 1/2" (12.5 mm)	
2	Citroen XM, Xantia	
3	Audi, Alfa Romeo, Fiat, Ford Fiesta, Isuzu, Honda Concerto, Jaguar (F/R), BMW, Mercedes - Benz, Mitsubishi Colt, Nissan: Almera, Stanza, Sunny, Rover, Toyota Camry, Volvo, VW: Passat, Golf GTI	
4	Ford, Mazda, Saab, Alfa Romeo 164 2.0, Honda, General Motors	
5	adapter z gniazdem 3/8" (10 mm)	
6	Nissan Primera, VW Golf IV	
7	Audi, Rover, Subaru, Ford, Nissan, Peugeot, Toyota, VW	
8	General Motors - zaciski 1 7/8" (47.6 mm)	
9	General Motors - zaciski 2 1/8" (54 mm)	
A	Renault	
E	Nissan Maxima	
F	Opel	
K	Citroen	
M	Ford, Cooper	
N	Saab, Honda	

YATO 

YT-0671 

5

- EN Disc brake pad and caliper service tool kit
PL Zestaw ręcznych separatorów do zacisków hamulcowych
DE Werkzeugsatz von manuellen Separatoren für Bremmsklemmen
RU Набор ручных сепараторов для тормозных зажимов
CZ Ruční sada na montáž kotoučových brzd
HU Fékmunkahenger prés készlet
RO Set de separatoare manuale pt. etrier frâna
FR Set de repousse piston de frein
IT Kit universale regolazione manuale per pistoni freni
ES Juego de separadores manuales para abrazaderas de freno
CN 刹车片分离器组套

18
PCS

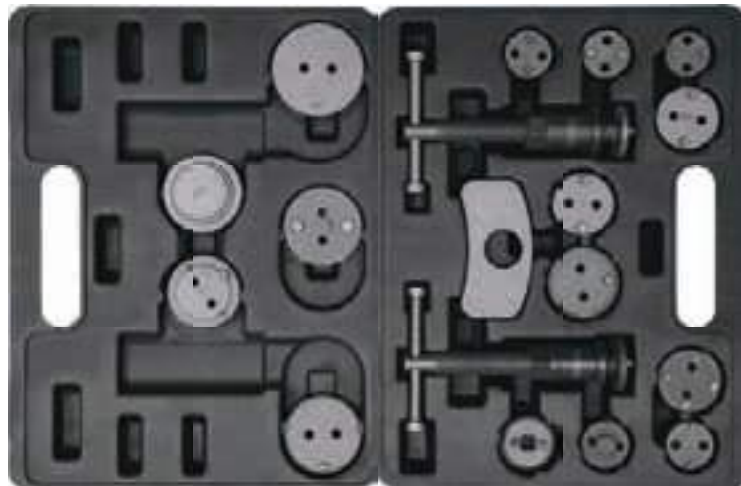
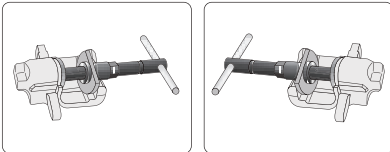

No.	zacisk przedni / front	zacisk tylny / rear
1-1	silowniki z lewym i prawym gwintem	
1	płytki oporowa	
5	3/8"	adapter z gniazdem
0	2 1/2"	General Motors
2	2 1/64"	Citroen XM, Xantia
3	2 5/32"	Audi, Alfa Romeo, Fiat, Ford Fiesta, Honda, Jaguar, BMW, Mercedes, Mitsubishi Colt, Nissan, Rover, Austin, Toyota Camry, Volvo, VW: Passat, Golf GTI
4	1 1/4"	Jaguar
6	1 21/32"	Ford, Mazda, Saab, Alfa Romeo 164 2.0, Honda, General Motors
7	1 21/32"	Nissan Primera, VW Golf IV
8	1 7/8"	Audi, Rover, Subaru, Ford, Nissan, Peugeot, Toyota, VW
9	2 1/8"	General Motors
E	1 21/32"	General Motors, Cadillac
F	1 1/4"	Nissan Maxima
K	2 1/8"	Opel
M	1 1/4"	Citroen
N	1 1/4"	Ford
A	1 3/16"	Saab, Honda
		Renault

YATO
YT-0682



5

- EN Disc brake pad and caliper service tool kit
PL Zestaw ręcznych separatorów do zacisków hamulcowych
DE Werkzeugsatz von manuellen Separatoren für Bremmsklemmen
RU Набор ручных сепараторов для тормозных зажимов
CZ Ruční sada na montáž kotoučových brzd
HU Fékmunkahenger prés készlet
RO Set de separatoare manuale pt. etrier frâna
FR Set de repousse piston de frein
IT Kit universale regolazione manuale per pistoni freni
ES Juego de separadores manuales para abrazaderas de freno
CN 刹车片分离器组套

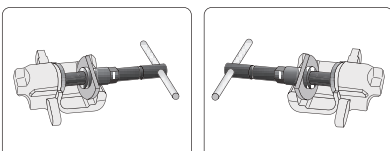

35
PCS

3/8"
9,5 mm



No.	zacisk przedni / front	zacisk tylny / rear
2	2 1/64" (51,0 mm)	Citroen Xantia, Honda Prelude
3	2 5/32" (55,0 mm)	Fiat, Alfa Romeo, Isuzu, Mercedes Benz, BMW, Citroen, Ford, Honda, Jaguar, Nissan, Peugeot, Rover, Toyota, VAG, Volvo
4	1 1/4" (32,0 mm)	Jaguar
5	3/8" (10,0 mm)	Ford, Mazda, Saab, Fiat, Alfa Romeo, General Motors
7	1 21/32" (42,0 mm)	adapter z gniazdem
6	1 21/32" (42,0 mm)	Nissan, VAG, Jaguar S
8	1 7/8" (48,0 mm)	Audi, Rover, Subaru, Ford, Nissan, Peugeot, Toyota, VAG, Saab, Jaguar, GM
9	2 1/8" (54,0 mm)	General Motors
0	2 1/2" (63,5 mm)	General Motors, Cadillac
A	1 1/8" (30,5 mm)	General Motors
B	1 19/30" (41,5 mm)	Renault, BMW, Mini
C	1 19/30" (41,5 mm)	Ford, Lincoln, Subaru
D	2 1/64" (51,0 mm)	Mini, Nissan, Opel, Toyota
E	1 21/32" (42,0 mm)	Renault, Citroen
F	1 1/4" (32,0 mm)	Nissan Maxima
G	3/8" (10,0 mm)	Opel, Fiat
J	1 22/33" (42,5 mm)	Peugeot, GM
K	2 1/8" (54,0 mm)	Fiat, Alfa Romeo, Audi, Citroen, Renault, Peugeot, Ford, Nissan, Saab, VAG, Subaru, Volvo
K1	2 1/8" (54,0 mm)	Citroen, Opel
K2	1 22/33" (50,0 mm)	Citroen, Renault, Audi
P	1 19/30" (41,5 mm)	VAG, BMW, Ford, Lancia, Proton, Renault, Rover, Citroen
M	1 1/4" (32,0 mm)	Ford, Mini, Nissan
N	1 1/4" (32,0 mm)	Saab, Honda, Alfa Romeo, Ford Mondeo, Lancia, Volkswagen
Z	1 3/16" (30,0 mm)	Ford, Mazda, Mitsubishi, Toyota Corolla
1, 11, 12	płytki oporowa	

YATO
YT-06822



5

- EN Brake disc run out kit
- PL Zestaw do pomiaru bicia tarcz hamulcowych
- DE Set zum Prüfen des Bremsschlags von Brems Scheiben
- RU Набор для измерения биения тормозного диска
- CZ Sada pro měření vibrací brzdových kotoučů
- HU Féktárcsa oldalútés mérő készülék
- RO Set pt. masurat uzura discurilor de frana
- FR Kit de mesure pour disque de frein
- IT Misuratore di spessore del disco del freno
- ES Set para medir el desgaste de los discos de freno
- CN 制动盘跳动检测仪

3 PCS +/- 0.01 mm



YATO **YT-72970** 6

- EN Wheel hub grinder
- PL Szczotka do czyszczenia piast
- DE Radnabenschleifer
- RU Щетка для чистки ступиц колеса
- CZ Kartáč na čištění nábojů kol
- HU Kerékagy tisztító tárcsa
- RO Perie pt. curățarea butuc roată
- FR Brosse abrasive pour le nettoyage des moyeux
- IT Pulitore per mozzi ruote
- ES Cepillo abrasivo para limpieza de bujes
- CN 轮毂抛光盘

1/2" 12.7mm Ø 150 mm

FOR IMPACT TOOLS DO NARZĘDZI UDAROWYCH SILICON CARBIDE WĘGLIK KRZEMU



YATO **YT-25380** 45

- EN Spare pad for wheel hub grinder
- PL Sciernica wymienna do szczotki do czyszczenia piast
- DE Ersatzscheibe für Radnabenschleifer
- RU Сменная щетка для чистки ступиц колеса
- CZ Kotouč náhradní na čištění nábojů kol
- HU Cserélhető tisztítókorong
- RO Rezervă pt. dispozitiv curățat butuc roată
- FR Meule de rechange pour brosse de nettoyage des moyeux
- IT Mola di ricambio per pulitore per mozzi ruote
- ES Disco recambio para limpieza de bujes
- CN 备用抛光盘

Ø 150 mm

FOR IMPACT TOOLS DO NARZĘDZI UDAROWYCH

SILICON CARBIDE WĘGLIK KRZEMU



For YT-25380
Dla YT-25380

YATO **YT-25383** 60/120

- EN Stud cleaning tool set
- PL Zestaw do czyszczenia śrub i szpilek
- DE Reinigungsbürsten-Satz für Stehbolzen und Radmutterbolzen
- RU Набор для чистки винтов и шпилек
- CZ Sada pro čištění šroubů a čepů
- HU Tőcsavar és kerékanya csavar tisztító készlet
- RO Set dispozitive pt. curatat filet surub
- FR Kit de nettoyage pour goujons et tiges filetées
- IT Set di spazzole pulizia per prigionieri e bulloni ruota
- ES Juego de herramientas para limpieza de pernos
- CN 螺栓清洁工具

9 PCS 1/2" 12.7mm

1/4" 6.3 mm SDS PLUS

FOR IMPACT TOOLS DO NARZĘDZI UDAROWYCH



12, 13, 14, 16, 22, 28 mm

YATO **YT-25385** 1/2" (12.7 mm) 10

- EN Stud hub cleaner set
- PL Zestaw do czyszczenia piast i szpilek
- DE Stehbolzen-Radnabenschleifer-Satz
- RU Набор насадок для чистки болтов ступицы
- CZ Sada na čištění nábojů a čepů kol
- HU Kerékagy és tí tisztító készlet
- RO Set pt. curățarea butuci roată
- FR Kit de nettoyage pour moyeux et axes
- IT Kit di pulizia dei mozzi della ruota e spille
- ES Juego de limpieza de bujes
- CN 轮毂抛光盘

14 PCS 1/2" 12.7mm

FOR IMPACT TOOLS DO NARZĘDZI UDAROWYCH

HEAVY DUTY NYLON WZMOCNIONY NYLON



YATO **YT-25384** 1/2" (12.7 mm) 10/40

- EN Dial indicator
- PL Czujnik zegarowy
- DE Messuhr
- RU Индикатор часового типа
- CZ Analogový senzor
- HU Óramutató érzékelő
- RO Ceas comparator
- FR Indicateur à cadran
- IT Indicatore a quadrante
- ES Indicador de cuadrante
- CN 百分表

0-10 mm +/- 0.01 mm Ø 55 mm

8 mm



YATO Measuring range / Zakres pomiaru [mm] **YT-72450** 0-10 50

- EN Electronic dial indicator
- PL Czujnik zegarowy elektroniczny
- DE Elektronische Messuhr
- RU Электронный индикатор часового типа
- CZ Elektronický senzor
- HU Elektromos órá érzékelő
- RO Ceas comparator digital
- FR Indicateur à cadran électrique
- IT Indicatore quadrante elettronico
- ES Indicador de cuadrante electrónico
- CN 数显百分表

0-12.7 mm +/- 0.01 mm

Ø 57 mm 8 mm

1x LR44



YATO Measuring range / Zakres pomiaru [mm] **YT-72453** 0-12.7 50

- EN Magnetic indicator stand
- PL Statyw magnetyczny
- DE Magnetständer
- RU Магнитный штатив
- CZ Magnetický stávk
- HU Mágneses állvány
- RO Suport pt. ceas comparator
- FR Trépied magnétique
- IT Supporto magnetico
- ES Soporte magnético
- CN 磁性表座

50x65 x55mm BASE / BAZA max 70 kg



For YT-72450, YT-72453
Dla YT-72450, YT-72453

YATO **YT-72460** 10

EN ABS and brake pressure gauge
PL Tester ciśnienia w układzie hamulcowym i ABS
DE Bremsdruck- und ABS-Tester
RU Тестер давления в тормозной системе и ABS
CZ Tester tlaku v brzdovém systému a ABS
HU ABS- és fék nyomásmérő készülék
RO Tester de presiune pt. sistemul de frânare
FR Testeur de pression de freinage et d'ABS
IT Misuratore pressione del sistema frenante e ABS
ES Probador de presión en el sistema de frenos y ABS
CN ABS刹车压力表

Included: pressure gauges: 0-200 kg/cm², 0-20.6 MPa (2 PCS); adaptors: #1: 7/16, M10x1.5 mm (2 PCS); #2: 7/16, M10x1 mm (2 PCS); #3: 7/16, M7x1 mm (2 PCS); #4: 7/16, M8x1.25 mm (2 PCS); #5: Ø9.34, G3/8, 24T (2 PCS); #6: Ø6.1, G1/4, 28T (2 PCS); #7: Ø10.9, 7/16, 24T (2 PCS); #8: Ø10.9, 7/16, 20T (2 PCS); #9: Ø7.64, 7/16, 24T (2 PCS); #10: M8x1 mm (2 PCS); #11: M10x1 mm (2 PCS); #12: M10x1.25 mm (2 PCS); #13: M6x1 mm (2 PCS); #A: 7/16, M10x1 mm; #B: 7/16, M10x1 mm; #C: Ø9.34, 24T; #D: M12x1 mm; #E: M11x1.5 mm; #F: Ø13, M13x1.5 mm; #G: Ø12.6, 20T; #H: Ø14, 20T; #I: Ø10.9, 24T; #J: Ø14, 18T; #K: M10x1.25; connectors: 90° (2 PCS); 45° (2 PCS); connecting pipe; connecting pipe M8x1.0 mm; angle connecting pipe M4x1.5 mm

W zestawie: manometry: 0-200 kg/cm², 0-20.6 MPa (2 szt.); adaptery: #1: 7/16, M10x1.5 mm (2 szt.); #2: 7/16, M10x1 mm (2 szt.); #3: 7/16, M7x1 mm (2 szt.); #4: 7/16, M8x1.25 mm (2 szt.); #5: Ø9.34, G3/8, 24T (2 szt.); #6: Ø6.1, G1/4, 28T (2 szt.); #7: Ø10.9, 7/16, 24T (2 szt.); #8: Ø10.9, 7/16, 20T (2 szt.); #9: Ø7.64, 7/16, 24T (2 szt.); #10: M8x1 mm (2 szt.); #11: M10x1 mm (2 szt.); #12: M10x1.25 mm (2 szt.); #13: M6x1 mm (2 szt.); #A: 7/16, M10x1 mm; #B: 7/16, M10x1 mm; #C: Ø9.34, 24T; #D: M12x1 mm; #E: M11x1.5 mm; #F: Ø13, M13x1.5 mm; #G: Ø12.6, 20T; #H: Ø14, 20T; #I: Ø10.9, 24T; #J: Ø14, 18T; #K: M10x1.25; złącza: 90° (2 szt.); 45° (2 szt.); rurka łącząca; rurka łącząca M8x1.0 mm; kątowna rurka łącząca M4x1.5 mm



46
PCS
20.6
MPa
(max.)
FOR BRAKING
SYSTEMS
DO UKŁADÓW
HAMULCOWYCH

YATO

YT-73040

5

EN Power steering tester kit
PL Zestaw diagnostyczny do wspomagania układu kierowniczego
DE Diagnoseset für Servolenkung
RU Диагностический комплект для гидроусилителя руля
CZ Sada pro diagnostiku systému posilovače řízení
HU Szervó-kormánytámnyomásmérő készlet

RO Kit tester servodirectie
FR Kit contrôle direction assistée
IT Kit di diagnostica del servosterzo
ES Kit de diagnóstico para dirección asistida
CN 转向机油压力表

15
PCS

14
MPa
(max.)

FOR POWER
STEERING SYSTEM
DO UKŁADÓW
KIEROWNICZEGO



Included: pressure gauge 140 bar / 2000 PSI; flexible hose 250 mm 1/8" NPT x M11 x 1.25; adapters: 1/8" NPT x M16 x 1.5 (2 PCS); 1/8" NPT x M18 x 1.5, 1/8" NPT x M11 x 1.0, M11 x 1.0 x M11 x 1.25, M11 x 1.25 x M18 x 1.5, M11 x 1.25 x M16 x 1.5 (2 PCS); M16 x 1.5 x M11 x 1.25, 1/8" NPT x M16 x 1.5, M11 x 1.25 x 1/8" NPT, 1/8" NPT x M16 x 1.5, M11 x 1.25 x M16 x 1.5

W zestawie: manometr 140 bar / 2000 PSI; elastyczny wąż 250 mm 1/8" NPT x M11 x 1.25; adaptery: 1/8" NPT x M16 x 1.5 (2 PCS); 1/8" NPT x M18 x 1.5, 1/8" NPT x M11 x 1.0, M11 x 1.0 x M11 x 1.25, M11 x 1.25 x M18 x 1.5, M11 x 1.25 x M16 x 1.5 (2 PCS); M16 x 1.5 x M11 x 1.25, 1/8" NPT x M16 x 1.5, M11 x 1.25 x 1/8" NPT, 1/8" NPT x M16 x 1.5, M11 x 1.25 x M16 x 1.5

YATO

YT-73045

10

EN Air brake bleeder
PL Urządzenie pneumatyczne do wymiany płynu hamulcowego
DE Druckluft-Bremsenentlüfter
RU Устройство для замены тормозной жидкости
CZ Sada na odvzdušnění brzdové soustavy a hydraulické spojky
HU Pneumatikus eszköz a fékfolyadék cseréjére
RO Aparat de schimbă lichid frână
FR Purger de frein et d'embrayage pneumatique
IT Strumento per la sostituzione del liquido freni
ES Sangrado del freno de aire comprimido
CN 气动刹车油更换机

$L_{pA} \leq 70$ dB; $L_{wA} \leq 85$ dB; $a_v \leq 2.5$ m/s²



0.27
MPa

5L

6 m

STANDARD



YATO

YT-06845

1

EN Universal hydraulic flaring tool set
PL Prasa hydrauliczna do przewodów hamulcowych i klimatyzacji
DE Hydraulisches Bördelgerät für Bremsleitungen
RU Гидравлический пресс для тормозных проводов и кондиционера
CZ Hydraulický lis pro výrobu brzdového vedení
HU Hidraulikus fék- és légkondicionáló cső peremező készlet

RO Presă hidroalică conducte frână și aer condiționat
FR Presse à collet hydraulique pour tuyaux de frein et de climatisation
IT Pressa idraulica per tubi freno e per aria condizionata
ES Kit de abocardar hidráulico para tubos de freno y de aire acondicionado
CN 制动管子扩孔器

14
PCS

Cu

BRASS
MOSIĄDZ

AI

STEEL
STAL



Flare forming tools / Końcówki do spęczania:

OP1: 4.75 mm (3/16"), 5 mm
DIN: 4.75 mm, 5 mm
OP2: 4.75 mm (3/16"), 5 mm, 6.35 mm (1/4")
OP1: 6.35 mm (1/4")
DIN: 6.35 mm

YATO

YT-06088

5

EN Brake and clutch bleeder bleeding vacuum pump kit
PL Zestaw pneumatyczny do odpowietrzania układu hamulcowego
DE Pneumatischer Bremsen-Entlüftungs Satz
RU Пневматический комплект для прокачки тормозной системы
CZ Pneumatiká sada pro odvzdušnění brzdového systému
HU Pneumatikus fék légtelenítő készlet
RO Kit pompa de vid pt. aerisire frana si ambreiaj
FR Kit de purge d'air pour freins
IT Kit pneumatico per lo spurgo dell'impianto frenante
ES Kit neumático para purgar el sistema de freno
CN 刹车油更换机

0.62
MPa

1L

180cm

STANDARD



YATO

YT-06835

20

EN Brake system filling and bleeding kit
 PL Zestaw do napełniania i odpowietrzania układu hamulcowego
 DE Befüll- und Entlüftungssset für Bremsanlage
 RU Приспособление для удаления воздуха из тормозной системы
 CZ Sada pro plnění a odvzdušňování brzdového systému
 HU Fékrendszer töltő és légtelenítő készlet
 RO Kit de umplere și golirea a sistemului de frânăre
 FR Jeu de remplissage et purge de frein
 IT Kit per rabbocco e spurgo impianto frenante
 ES Juego para llenar y purgar el sistema de frenos
 CN 刹车油更换器

400 ml 1.37 bar (max.) HDPE



- Standard cap 45 mm
- Standardowa pokrywa 45 mm

YATO			
YT-06837			10

EN Coil spring compressor
 PL Ściągacz do sprężyn
 DE Federspanner
 RU Съёмник пружин
 CZ Stahovák pružin
 HU Rugóösszehúzó

2 PCS 1/2" 12.7mm 21 mm

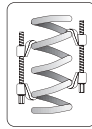

90x200 mm

YATO	Ø [mm]	L [mm]	
YT-0605	90	200	5/10



82x370 mm CrV

YATO	Ø [mm]	L [mm]	
YT-2544	82	370	8

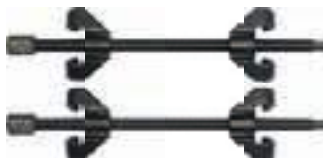

COLD FORGED KÜTE NA ZIMNO

YATO	Ø [mm]	L [mm]	
YT-2546	82	280	8
YT-2547	82	355	8

EN Coil spring compressor
 PL Ściągacz wewnętrzny do sprężyn
 DE Innenabzieher für Federn
 RU Внутренний съёмник для пружин
 CZ Vnitřní stahovák pružin
 HU Belső rugóösszehúzó
 RO Dispozitiv compresat arcuiri
 FR Extracteur interne de ressorts
 IT Estrattore interno per molle
 ES Extractor para muelles interior
 CN 弹簧压缩器

20 mm 145 mm 300 mm DROP FORGED KÜTE



YATO	Ø [mm]	L [mm]	
YT-25472	145	300	6/12

EN Coil spring compressor
 PL Ściągacz do sprężyn
 DE Federspanner
 RU Съёмник пружин
 CZ Stahovák pružin
 HU Rugóösszehúzó

3 PCS 35-280 mm max 1000 kg



YATO			
YT-25450			4

EN Macpherson spring dumper extractor
 PL Ściągacz do sprężyn MacPhersona
 DE Abziehvorrichtung für Federn von MacPherson
 RU Съёмник пружин подвески Макферсона
 CZ Stahovák pružin McPherson
 HU MacPherson rugó összehúzó
 RO Presă de arcuiri
 FR Compresseurs de ressort MacPherson
 IT Estrattore per molle MacPherson
 ES Desmontador para los resortes de MacPherson
 CN 弹簧压缩器

100-250 mm max 2900 kg

CrMo SCM415 3 POINTS OF FORCE / PUNKTY WCIŚCIANIA

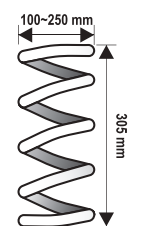

YATO			
YT-2535			2

EN Interchangeable fork spring compressor and removal tool
PL Ściągacz do sprężyn MacPhersona z wymiennymi uchwytami
DE Abziehvorrichtung für MacPherson-Federn mit austauschbaren Halterungen
RU Стяжка для снятия пружин МакФерсона со сменными попукольцами
CZ Stahovák pružin MacPherson s výměnitelnými čelistmi
HU MacPerson rugó összehúzó cserélhető pófkákkal
RO Presă arcuri cu manere interschimbabile
FR Compresseurs de ressort MacPherson
IT Smonta ammortizzatori per sospensioni MacPherson
ES Extractor de resortes MacPherson con mangos intercambiables
CN 免拆式减震弹簧压缩器

7 PCS 65-125 mm 88-160 mm 126-212 mm max 1500 kg



EN Drive nut set
PL Zestaw nasadek do amortyzatorów
DE Stossdämpfer Nutmutter Einsätze
RU Набор головок для амортизаторов
CZ Sada hlavice na uložení tlumiče
HU Lengéscsillapítókiészítő szet
RO Set chei pt. amortizoare
FR Set des embouts aux amortisseurs
IT Set di chiavi per aria condizionata
ES Juego de boquillas de amortiguadores
CN 拆装减震器套件组套

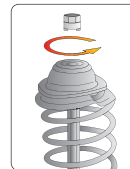

5 PCS

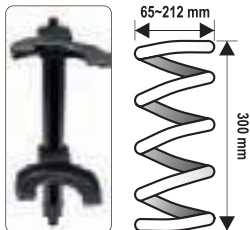
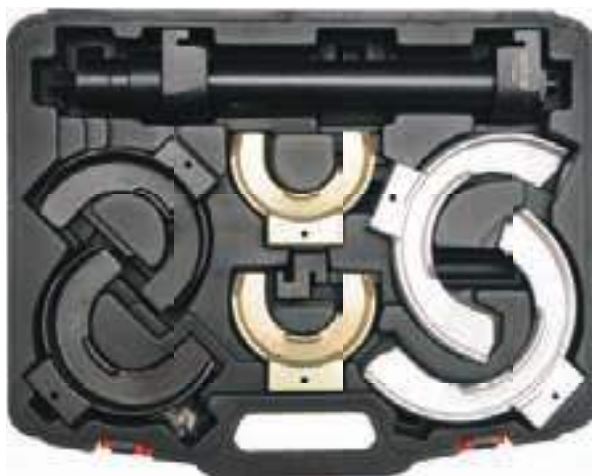

10.5 mm (VW Golf rear), 12.5 mm (VW Golf front), 14.5 mm (VW Polo, Golf, Passat, Audi 80), 14.5 mm (Austin Maestro), 14.0 mm (Mercedes Benz C-Class (W203))

YATO	
YT-2536	1

YATO	Size / Rozmiar [mm]	
YT-0621	10.5, 12.5, 14.5, 14.5, 14	12/48

EN Shock absorber tool set
PL Zestaw kluczy do mocowania amortyzatorów
DE Stoßdämpfer-Schlüssel-Satz
RU Набор ключей для крепления амортизаторов
CZ Sada klíčů na montáž tlumičů
HU Lengéscsillapító szerelő kulcs készlet
RO Set chei pt. fixare amortizoare
FR Jeu d'outils pour amortisseurs
IT Set chiavi per montare ammortizzatori
ES Juego de llaves para instalación de amortiguadores
CN 减震工具组套

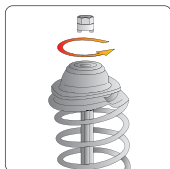

39 PCS CrMo SCM415
CrV 6140 CrV 50BV30
8660

10.5x3.5 mm (VW Golf rear axle), 12.5x3 mm, 12.5x3.5 mm (VW Golf front axle), 14x2.5 mm (Mercedes-Benz: C-Class W203, CLK W209), 14.5x3 mm (Austin Maestro), 14.5x5 mm (Audi 80; VW: Polo, Golf, Passat); CrMo SCM415;
14 mm (Honda, Nissan), 16 mm (Audi, Fiat, Seat, VW), 17 mm (Audi, Fiat, Ford, Seat, VW), 18 mm (Audi, Fiat, Ford, Opel, Peugeot, Renault, Rover, Seat, VW, Japanese cars), 19 mm (Audi, Citroen, Fiat, Opel, Peugeot, Seat, Toyota, VW), 21 mm (Audi, Chrysler, Ford, Mercedes-Benz W203, VW, Japanese cars), 22 mm (Audi, BMW, Citroen, Fiat, Opel, Peugeot, Renault, Seat, VW), 24 mm (Volvo), 27 mm (Audi, Citroen, Peugeot, VW); CrV 50BV30;
4 mm (Nissan), 5.2 mm (Audi, Nissan, VW), 6 mm (Audi, Renault, VW), 6.3 mm (Nissan), 7 mm (Audi, Fiat, Seat, VW), 8 mm (Fiat, Seat), 9 mm (Japanese cars), 10 mm (Fiat, Seat, Volvo), 12 mm (Fiat, Seat); CrV 6140;
D5 (Nissan), D10 (Ford, Nissan); CrV 6140;
8 mm (Mercedes-Benz), 9 mm (Chrysler, Opel/Vauxhall), 10 mm (Chrysler, Ford), 11 mm (Japanese cars); CrV 6140;
T50 (Ford, Nissan), T60 (Ford); steel 8660;
3 mm (Mercedes-Benz, Opel, Renault), 3.5 mm (Chrysler, Citroen, Ford, Peugeot), 4 mm (Citroen, Peugeot); steel 8660;
5 mm (Honda), 6 mm (BMW, Citroen, Fiat, Ford, Peugeot, Renault, Seat, Japanese cars), 7 mm (Audi, Citroen, Fiat, Mercedes-Benz W203, Peugeot, Renault, Seat, VW), 8 mm (Mercedes-Benz); steel 8660;
M12 (Opel/Vauxhall); steel 8660

YATO	
YT-0628	3

EN Tire valve stem inserter
PL Przeciągacz do zaworków gumowych
DE Abziehvorrichtung für Gummiventile
RU Протяжка к резиновым клапанам
CZ Páka k provlékání bezdušových ventilů
HU Szűzfeszesség mérő
RO Dispozitiv pt. supapele cauciucate
FR Levier tire-valve
IT Brocca valvola di gomma
ES Brocha de tracción para las válvulas de goma
CN 气门插入工具

290 mm RUBBER VALVES ZAWORKY GUMOWE



YATO	L [mm]	
YT-0619	290	12/72

EN Wheel balance pliers
 PL Szczypce do wyważania kół
 DE Auswuchtgewicht-Zange

RU Клеши для балансировки колес
 CZ Kleště pro vyvažování kol
 HU Centrifúly szerelő szerszám

RO Clește pt. plumbi roți
 FR Pincés pour les contrepois à agrafe de roue de voiture
 IT Pinze per equilibrio ruota

ES Tenazas de equilibrar ruedas
 CN 平衡钳

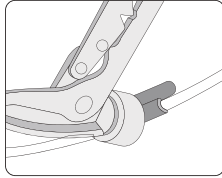
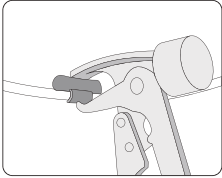
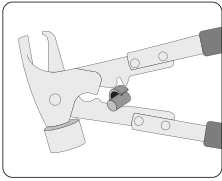

YATO

YT-0643

6/48

EN Deep thin wall impact sockets
 PL Zestaw nasadek udarowych do felg aluminiowych
 DE Alu-Felgen Kraft-Stecknüsse
 RU Набор головок для алюминиевых дисков
 CZ Sada nástrčných klíčů na alu ráfky
 HU Hosszított dugókulcs készlet, könnyűfém felnikhez
 RO Set chei adânci pt. jante aliaj
 FR Set de douilles profondes à choc
 IT Set di chiavi a bussola per dadi ruota di alluminio
 ES Juego de boquillas de percusión para llantas de aluminio
 CN 风动薄壁长套筒

3
PCS

1/2"
12.7mm

17 19 21
mm

26 29 31
mm

AS-DRIVE

CrMo
SCM440



- For service station and tire workshops
- For maximum impact loads
- Drive locks
- Ultra thin walls and nylon cover for working with alu rims
- Anodised colour finish for fast identification of size



- Dla serwisów i warsztatów oponiarskich
- Do największych obciążeń udarowych i tętniących
- Zamki blokujące
- Ultracienkie ścianki i nylonowe pokrycie do pracy z felgami aluminiowymi
- Anodowane, kolorowe wykończenie dla szybkiej identyfikacji rozmiaru

17, 19, 21 mm

YATO

YT-1056

1/2" (12.7 mm)

12/24

EN Deep thin wall impact sockets
 PL Zestaw nasadek udarowych do felg aluminiowych
 DE Alu-Felgen Kraft-Stecknüsse
 RU Набор головок для алюминиевых дисков
 CZ Sada nástrčných klíčů na alu ráfky
 HU Hosszított dugókulcs készlet, könnyűfém felnikhez
 RO Set chei adânci pt. jante aliaj
 FR Set de douilles profondes à choc
 IT Set di chiavi a bussola per dadi ruota di alluminio
 ES Juego de boquillas de percusión para llantas de aluminio
 CN 风动薄壁长套筒

10
PCS

1/2"
12.7mm

CrMo

AS-DRIVE



15, 17, 19, 21, 22, 23, 24 mm; 7/8";
 17 mm (Mercedes); 21 mm (Kia, Hyundai)

YATO

YT-10564

1/2" (12.7 mm)

5

EN Deep aluminium wheel nut socket set
 PL Zestaw nasadek udarowych długich do felg aluminiowych
 DE Alu-Felgen Kraft-Stecknüsse, lang
 RU Набор длинных ударных насадок для алюминиевых дисков
 CZ Sada dlouhých nárazových zásuvek pro hliníkové disky
 HU Hosszított dugókulcs készlet, könnyűfém felnikhez
 RO Set chei adânci pt. jante aliaj
 FR Jeu de douilles à chocs longues pour jantes en aluminium
 IT Kit di punte a percussione lunghe per cerchi in lega
 ES Juego de vasos de impacto largos para llantas de aluminio
 CN 加长轮胎保护套筒

6
PCS

1/2"
12.7mm

150
mm

17 19 21
mm

27 29 31
mm

CrMo

AS-DRIVE



17, 19, 21 mm

YATO

YT-10563

1/2" (12.7 mm)

10

EN Torque limiting extension bar set
 PL Zestaw przedłużek udarowych z ograniczeniem momentu
 DE Schlagverlängerungssatz mit Drehmomentbegrenzung
 RU Набор удлинителей с ограничителем крутящего момента
 CZ Sada prodloužení s kontrolou utahovacího momentu
 HU Nyomatékkorlátozó hosszabbító készlet
 RO Set prelungitoare cu limitare de cuplu
 FR Jeu de barres d'extension à limitation de couple
 IT Set di prolunghe a percussione con limitatore di coppia
 ES Juego de barras de torsión con límite de par de apriete
 CN 扭力接杆

5
PCS

1/2"
12.7mm

100-150
Nm

CrMo



1/2" (12.7): 100, 110, 120, 135, 150 Nm (L=200 mm); CrMo

YATO

YT-10567

1/2" (12.7 mm)

10

EN Emergency wheel nut remover
PL Nasadki udarowe do wykręcania śrub zabezpieczających
DE Schlag-Steckschlüsselsatz für Radsicherungsschrauben
RU Ударные головки для снятия предохранительных винтов
CZ Sada nástřných hlavíc pro demontáž bezpečnostních šroubů
HU Útve-dugókulcs készlet biztonsági csavarok kihajtásához
RO Set tubulare speciale pt. prezoane rotunjite
FR Jeu d'outils à impact pour le dévissage des vis de sécurité
IT Chiavi ad impatto per estrazione viti di sicurezza
ES Vasos de impacto para desenroscar tornillos de seguridad
CN 应急螺母组套

4
PCS



1/2"
12.7mm

17-26
mm

CrMo



17, 18.5, 21.5, 26 mm: CrMo

YATO  
YT-06030 1/2" (12.7 mm) 10/20

EN Locking wheel nut socket set
PL Zestaw nasadek do śrub zabezpieczających
DE Felgenschloss-Schlüssel-Satz
RU Набор насадок для секреток колес
CZ Hlavice na bezpečnostní šrouby kol
HU Kerékszár kulcskészlet
RO Set de chei defacere antifurt roti
FR Jeu de douilles pour écrous antivol
IT Set chiavi a bussola per dadi ruota antifurto
ES Conjunto de vasos para tornillos antirrobo
CN 防盗螺丝套筒组套

21
PCS

1/2"
12.7mm

CrMo



 Opel: Agila, Astra F/G/H, Calibra, Corsa B/C/D, Meriva, Omega B, Signum, Speedster, Tigra A/B, Vectra B/C, Zafira A/B

 #181, #182, #183, #184, #185, #186, #187, #188, #189, #190, #191, #192, #193, #194, #195, #196, #197, #198, #199, #200



YATO  
YT-060306 1/2" (12.7 mm) 5

EN Locking wheel nut socket set
PL Zestaw nasadek do śrub zabezpieczających
DE Felgenschloss-Schlüssel-Satz
RU Набор насадок для секреток колес
CZ Hlavice na bezpečnostní šrouby kol
HU Kerékszár kulcskészlet
RO Set de chei defacere antifurt roti
FR Jeu de douilles pour écrous antivol
IT Set chiavi a bussola per dadi ruota antifurto
ES Conjunto de vasos para tornillos antirrobo
CN 防盗螺丝套筒组套

22
PCS



1/2"
12.7mm

CrMo



 Audi (2002-2012)

 A, B, C, E, F, G, H, I, J, L, M, N, P, Q, R, S, T, V, W, X

YATO  
YT-060304 1/2" (12.7 mm) 20

EN Wheel lock lug nut removal set
PL Zestaw nasadek do wykręcania śrub zabezpieczających
DE Steckschlüsselsatz für Radsicherungsschrauben
RU Набор головок для снятия предохранительных винтов
CZ Sada hlavíc pro demontáž bezpečnostních šroubů
HU Dugókulcs készlet biztonsági csavarok kihajtásához
RO Set pt. prezoane deteriorate
FR Jeu d'outils pour le dévissage des vis de sécurité
IT Set di bussole per svitare bulloni di sicurezza
ES Juego de vasos para destornillar tornillos de seguridad
CN 弹簧锁拆卸套筒



10
PCS

18-25
mm

CrMo



18, 19, 20, 21, 22, 23, 24, 25 mm; CrMo;
17x180 mm, 22x180 mm

YATO  
YT-060302 5

EN Locking wheel nut socket set
PL Zestaw nasadek do śrub zabezpieczających
DE Felgenschloss-Schlüssel-Satz
RU Набор насадок для секреток колес
CZ Hlavice na bezpečnostní šrouby kol
HU Kerékszár kulcskészlet
RO Set de chei defacere antifurt roti
FR Jeu de douilles pour écrous antivol
IT Set chiavi a bussola per dadi ruota antifurto
ES Conjunto de vasos para tornillos antirrobo
CN 防盗螺丝套筒组套

22
PCS

1/2"
12.7mm

CrMo



 BMW: 1 Series F20/F21, 3 Series F30/F31, 4 Series F32/F34/F36, 5 Series F10/F11, 6 Series F12/F13, 7 Series F01/F02/F04

 041, 042, 043, 044, 045, 046, 047, 048, 049, 050, 051, 052, 053, 054, 055, 056, 057, 058, 059, 060

YATO  
YT-060303 1/2" (12.7 mm) 20

EN Locking wheel nut socket set
PL Zestaw nasadek do śrub zabezpieczających
DE Felgenschloss-Schlüssel-Satz
RU Набор насадок для секреток колес
CZ Hlavice na bezpečnostní šrouby kol
HU Kerékszár kulcskészlet
RO Set de chei defacere antifurt roti
FR Jeu de douilles pour écrous antivol
IT Set chiavi a bussola per dadi ruota antifurto
ES Conjunto de vasos para tornillos antirrobo
CN 防盗螺丝套筒组套

22
PCS



1/2"
12.7mm

CrMo



 VW (2006-2011): Beetle, EOS, Golf/Golf GTI, Jetta, Passat, Tiguan

 #521, #522, #523, #524, #525, #526, #527, #528, #529, #530, #531, #532, #533, #534, #535, #536, #537, #538, #539, #540

YATO  
YT-060305 1/2" (12.7 mm) 20



- EN Steering and suspension indicator
 PL Przyrząd do sprawdzania luzów zawieszenia
 DE Vorrichtung zur Kontrolle des Aufhängungsspiels
 RU Инструмент для проверки люфта подвески
 CZ Zařízení pro kontrolu vůle zavěšení
 HU Futómű lazulás ellenőrző
 RO Dispozitiv verificare axe direcție
 FR Dispositif de contrôle du jeu de la suspension
 IT Strumento per il controllo giochi delle sospensioni
 ES Equipo para comprobar juegos en la suspensión
 CN 底盘间隙测试工具

1/2"
12.7mm

∅ 50 mm

390 mm



YATO 	○	
YT-17490	1/2" (12.7 mm)	20

- EN Folding cross wrench
 PL Składany klucz do kół w etui
 DE Radmutternschlüssel
 RU Балонный крестовой разборный ключ с чехлом
 CZ Skládací křížový klíč na maticе
 HU Összecsukható kereszt csavar kulcs
 RO Cheie pliabilă pt. roți
 FR Clé démonte roue en croix démontable
 IT Pierevole cress chiave
 ES llave para las ruedas de automóviles
 CN 可折叠十字扳手

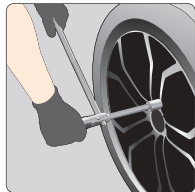

4 PCS



1/2"
12.7mm

CrV

ETUI
FUTERAL



1/2" (12.7 mm): 17, 19, 21, 23 mm

YATO 	○	
YT-08035	1/2" (12.7 mm)	10

- EN Folding cross wrench
 PL Składany klucz do kół
 DE Klappbarer Radschlüssel
 RU Складной ключ для колес
 CZ Skládací klíč na kola
 HU Összecsukható kerékkulcs
- RO Cheie pliabilă pt. roți
 FR Clé à roue pliante
 IT Chiave per ruote pieghevole
 ES Llave de rueda plegable
 CN 可折叠十字扳手

4 PCS

1/2"
12.7mm

CrV





1/2" (12.7 mm): 17, 19, 21, 23 mm

YATO 	○	
YT-08033	1/2" (12.7 mm)	5/10

- EN Cross rim wrench
 PL Krzyżakowy klucz do kół
 DE Kreuzschlüssel
 RU Ключ-крест балонный
 CZ Klíč na kola křížový
 HU Kereszt kerékkulcs
- RO Cheie în cruce pt. roți
 FR Clé en croix aux roues
 IT Chiavi a croce per auto ruota
 ES Llave cruz para ruedas
 CN 十字套筒扳手

CrV 



YATO 	Size / Rozmiar [mm]	
YT-0800	17x19x21x22	10
YT-0801	17x19x21x1/2" (12.7 mm)	10
YT-0802	24x27x32x3/4" (19.0 mm)	3

- EN L-type wheel wrench
 PL Klucz do kół rozsuwany
 DE Teleskop-Radmutternschlüssel
 RU Ключ балонный телескопический
 CZ Teleskopický klíč na kola
 HU Kihúzható kerékkulcs
 RO Cheie pt. roți extensibilă
 FR Clé à roues extensible
 IT Chiave telescopica smontaruota
 ES Llave para ruedas extensible
 CN 轮胎套筒扳手手套



1/2"
12.7mm

385-530 mm

CrV 



1/2" (12.7 mm): 17x19 mm, 21x23 mm

YATO 	○	
YT-08040	1/2" (12.7 mm)	5/10



- EN Tire expander
 PL Rozpierek do opon
 DE Reifenspreizer
 RU Борторасширитель
 CZ Roztahovák pneumatik
 HU Abroncs leszedő szerszám
- RO Dispozitiv depanare anvelope
 FR Écarteur de pneus
 IT Divanatore per pneumatici
 ES Esparcidor de neumáticos
 CN 扩胎器

85-385 mm

450 mm

FOR TIRES DO OPON 



YATO 	L [mm]	
YT-08120	450	9

EN Electric impact wrench
PL Elektryczny klucz udarowy
DE Elektro-Schlagschrauber
RU Электрический гайковерт
CZ Elektrický rázový uťahovák
HU Elektromos ütvecsavarozó

RO Pistol de impact electric
FR Clé à choc électrique
IT Avvitatore elettrico ad impulso
ES llave de impacto eléctrica
CN 电动冲击扳手

230V~
50Hz

450
W

450
Nm

0-3300
min⁻¹

1/4"
6.3 mm

1/2"
12.7 mm

4 m



17, 19, 21, 23 mm



$L_{pa} = 96,0 \pm 3,0$ dB; $L_{wa} = 107,0 \pm 3,0$ dB; $a_n = 17,648 \pm 1,5$ m/s²

YATO	[W]	
YT-82020	450	4

EN Electric impact wrench
PL Elektryczny klucz udarowy
DE Elektro-Schlagschrauber
RU Электрический гайковерт
CZ Elektrický rázový uťahovák
HU Elektromos ütvecsavarozó

RO Pistol de impact electric
FR Clé à choc électrique
IT Avvitatore elettrico ad impulso
ES llave de impacto eléctrica
CN 电动冲击扳手

230V~
50Hz

1020
W

600
Nm

0-2600
min⁻¹

1/4"
6.3 mm

1/2"
12.7 mm

4 m



17, 19, 21, 23 mm



$L_{pa} = 100,0 \pm 3,0$ dB; $L_{wa} = 111,0 \pm 3,0$ dB; $a_n = 18,9 \pm 1,5$ m/s²

YATO	[W]	
YT-82021	1020	3

EN Impact tool set
PL Zestaw narzędzi udarowych
DE Schlagwerkzeugsatz
RU Набор инструментов ударных
CZ Sada příklepových nářadí
HU Ütvecsavarozó szerszámkészlet
RO Set pistol impact
FR Clé à choc avec jeu d'outils
IT Set di chiavi a percussione
ES Juego de herramientas de impacto
CN 锂电冲击扳手套筒组套



21
PCS

18 V
Li-Ion

1/2"
12.7 mm

700
Nm

0-2600
min⁻¹

0-5000
min⁻¹

3.0
Ah

1.5h

LED CHARGE INDICATOR
TISZÁZVÁR NAŁADZANANIA
BATERII



1/2" (12.7 mm): 17, 19, 21 mm (L=87 mm); CrMo;
1/2" (12.7 mm): 12, 13, 14, 15, 16, 17, 18, 19, 20, 21, 22, 23, 24 mm; CrMo;
1/2" (12.7 mm): (L=75 mm); CrMo

$L_{pa} = 86,0 \pm 3,0$ dB; $L_{wa} = 97,0 \pm 3,0$ dB; $a_n = 7,58 \pm 1,5$ m/s²

YATO	○	[V d.c.]	
YT-82807	1/2" (12.7 mm)	18	2

18V
Li-Ion



EN Tire lever
PL Lyzka do opon
DE Reifenmontierhebel

RU Прибор для шиномонтажа
CZ Montážní páka na pneumatiky
HU Gumiabroncs kar

RO Levier pt. roti
FR Cuillère à pneus
IT Leva per pneumatici

ES Desmontable para las llantas
CN 轮胎起子



YATO	L [mm]	
YT-0807	300	20
YT-0808	400	20

YATO	L [mm]	
YT-0809	500	5/20
YT-0810	600	5/20

EN Tire lever
PL Lyzka do opon
DE Reifenmontierhebel

RU Прибор для шиномонтажа
CZ Montážní páka na pneumatiky
HU Gumiabroncs kar

RO Levier pt. roti
FR Cuillère à pneus
IT Leva per pneumatici

ES Desmontable para las llantas
CN 撬棒



YATO	L [mm]	
YT-0811	380	10/50

EN Rectangular telescopic inspection mirror
PL Lusterko inspekcyjne
DE Teleskop Inspektionsspiegel

RU Зеркало инспекционное телескопическое
CZ Zrcátko kontrolní teleskopické
HU Vizsgáló tükör, teleszkópos nyéllel

RO Oglindă telescopica pt. inspectie
FR Miroir d'inspection
IT Telescopio ispezione specchio

ES Espejo rectangular telescópico de inspección
CN 可伸缩矩形检测镜



YATO		
YT-0660		12/144

EN LED lighted telescopic inspection mirror
PL Lusterko inspekcyjne z lampką
DE Prüfspiel mit Beleuchtung

RU Зеркало досмотровое с подсветкой
CZ Inspekční zrcadélko s lampou
HU Vizsgáló tükör, lámpával

RO Oglindă pt. inspecție cu lampă
FR Miroir d'inspection avec lampe
IT Specchio di ispezione con lampada

ES Espejo de control con lámpara
CN 带灯检测镜



YATO		
YT-0663		10/100

EN Telescopic magnetic pick up tool
PL Chwytek teleskopowy z magnesem
DE Teleskop magnet Heber
RU Захват магнитный телескопический

CZ Patka teleskopická magnetická
HU Felszedő mágnes, teleszkópos nyéllel
RO Telescop magnetic
FR Capteur magnétique

IT Telescopio magnete
ES Herramienta levantadora magnética, telescópica
CN 可伸缩拾器



YATO		
YT-0661		12/144

EN Telescopic magnetic pick up tool
PL Chwytek teleskopowy z magnesem
DE Teleskop magnet Heber
RU Захват магнитный телескопический

CZ Patka teleskopická magnetická
HU Felszedő mágnes, teleszkópos nyéllel
RO Telescop magnetic
FR Capteur magnétique

IT Telescopio magnete
ES Herramienta levantadora magnética, telescópica
CN 带灯可伸缩拾器



YATO		
YT-06611		12/144

16

EN 3 in 1 pick up tool
PL Zestaw do podnoszenia 3 w 1
DE 3 in 1 Hebeset
RU Подъемный набор 3 в 1
CZ Zvedací sada 3 v 1
HU 3 az 1-ben felszedő készlet
RO Dispozitiv 3 in 1 pt. recuperat
FR Kit de levage 3 en 1
IT Kit per sollevamento 3 in 1
ES Kit de elevación 3 en 1
CN 带灯拾器

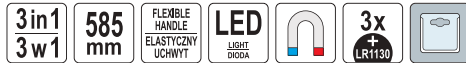

YATO		
YT-06613		10/60

EN Telescopic magnetic pick up tool
PL Chwytek teleskopowy z magnesem
DE Teleskop magnet Heber
RU Захват магнитный телескопический
CZ Patka teleskopická magnetická
HU Felszedő mágnes, teleszkópos nyéllel
RO Telescop magnetic
FR Capteur magnétique
IT Telescopio magnete
ES Herramienta levantadora magnética, telescópica
CN 可伸缩磁性拾器



YATO	L [mm]	
YT-0860	590-990	6/24

EN Telescopic pick up and mirror set
PL Zestaw inspekcyjny: lusterko + chwytak
DE Inspektionsatz: Spiegel + Greifer
RU Проверочный набор + держатель и зеркальце
CZ Inspekční souprava: zrcadlo + držák
HU Teleszkópos ellenőrző készlet
RO Set control: oglindă + telescop magnetic
FR Kit miroir + grappin
IT Set per ispezione: specchio + supporto
ES Juego de inspección: espejo + cuchara de mordazas
CN 检测镜、拾拾器组套

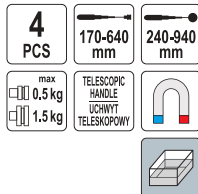

YATO
YT-0662

10/40

EN Inspection set
PL Zestaw inspekcyjny
DE Inspektionsset
RU Инспекционный набор
CZ Inspekční sada
HU Teleszkópos ellenőrző készlet
RO Set de inspecție
FR Jeu d'inspection
IT Strumenti d'ispezione
ES Juego herramientas inspección
CN 套磁性伸缩拾拾器



172-570 mm, 84x53 mm;
181-779 mm, Ø15 mm;
129-648 mm, Ø5 mm;
240-695 mm, Ø50 mm;
283-880 mm, 84x53 mm

YATO
YT-0662

48

EN Magnetic parts tray
PL Miska magnetyczna
DE Magnetschale
RU Магнитный поднос
CZ Miska magnetická
HU Mágneses tálca
RO Tavă magnetică
FR Bol magnétique
IT Ciotola magnetica
ES Bandeja magnética
CN 磁性工具盘



Ø 110 mm

YATO
YT-08295

12/48



Ø 150 mm

YATO
YT-0830

12/48

EN Magnetic parts tray
PL Miska magnetyczna
DE Magnetschale
RU Магнитный поднос
CZ Miska magnetická
HU Mágneses tálca
RO Tavă magnetică
FR Bol magnétique
IT Ciotola magnetica
ES Bandeja magnética
CN 磁性工具盘

152x68 mm



YATO
YT-08312

48

EN Magnetic parts tray
PL Miska magnetyczna
DE Magnetschale
RU Магнитный поднос
CZ Miska magnetická
HU Mágneses tálca
RO Tavă magnetică
FR Bol magnétique
IT Ciotola magnetica
ES Bandeja magnética
CN 磁性工具盘

350x150 mm



YATO
YT-0831

6/12

EN Magnetic parts tray
PL Miska magnetyczna
DE Magnetschale
RU Магнитный поднос
CZ Miska magnetická
HU Mágneses tálca
RO Tavă magnetică
FR Bol magnétique
IT Ciotola magnetica
ES Bandeja magnética
CN 磁性工具盘



Ø 110 mm

0,10 T (TESLA)



YATO
YT-08304

24

EN Magnetic parts tray
PL Miska magnetyczna
DE Magnetschale
RU Магнитный поднос
CZ Miska magnetická
HU Mágneses tálca
RO Tavă magnetică
FR Bol magnétique
IT Ciotola magnetica
ES Bandeja magnética
CN 磁性工具盘



Ø 150 mm

0,10-0,12 T (TESLA)



YATO
YT-08305

20

EN Magnetic parts tray
PL Miska magnetyczna
DE Magnetschale
RU Магнитный поднос
CZ Miska magnetická
HU Mágneses tálca
RO Tavă magnetică
FR Bol magnétique
IT Ciotola magnetica
ES Bandeja magnética
CN 磁性工具盘



2 PCS

Ø 108 mm

Ø 150 mm

0,10 T (TESLA)



YATO
YT-08302

6/24

EN Magnetic parts tray
PL Sortownik magnetyczny
DE Magnet-Sortierbox
RU Сортировщик
CZ Magnetický tříděč
HU Mágneses rendszerező

RO Tava magnetica pt. piese
FR Rangement compartimenté magnétique
IT Separatore magnetico
ES Clasificador magnético
CN 磁力盘

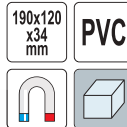

YATO L [mm]
YT-08320 48

EN Magnetic wristband
PL Opaska magnetyczna
DE Magnetisches Armband
RU Магнитный браслет
CZ Magnetický náramek pro kutily
HU Mágneses karkötő
RO Manșetă magnetică
FR Bracelet magnétique
IT Braccialeto magnetico
ES Pulsera magnética
CN 磁性腕带



YATO L [mm]
YT-74050 340 50

EN Magnetic screwdriver rack
PL Uchwyt magnetyczny na wkręćaki
DE Magnetische Halterung für Schraubendreher
RU Магнитный держатель для отверток
CZ Magnetický držák šroubováků
HU Mágneses csavarhúzó tartó

RO Raft magnetic pt. surubelnite
FR Mandrin magnétique pour tournevis
IT Supporto magnetico per punte
ES Soporte magnético para destornilladores
CN 磁性螺丝刀架



YATO L [mm]
YT-08353 350 6/24

EN Magnetic pliers rack
PL Uchwyt magnetyczny na narzędzia
DE Magnetischer Werkzeughalter
RU Магнитный держатель для инструментов
CZ Magnetický držák na nářadí
HU Mágneses szerszámirtó

RO Raft magnetic pt. scule
FR Fixation magnétique pour outils
IT Supporto magnetico per attrezzi
ES Soporte magnético para herramientas
CN 磁性钳子架



YATO L [mm]
YT-08354 350 6/24

EN Magnetic tool holder
PL Listwa magnetyczna
DE Magnet Werkzeughalter
RU Магнитная рейка
CZ Magnetický držák nářadí
HU Mágneses tartó

RO Suport magnetic
FR Barre et porte outil magnétique
IT Striscia magnetica
ES Bandeja de accesorios magnética
CN 磁性工具架



YATO
YT-0835 4/16

EN Magnetic wristband
PL Opaska magnetyczna
DE Magnetisches Armband
RU Магнитный браслет
CZ Magnetický náramek pro kutily
HU Mágneses karkötő
RO Manșetă magnetică
FR Bracelet magnétique
IT Braccialeto magnetico
ES Pulsera magnética
CN 磁性腕带

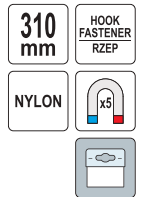

YATO L [mm]
YT-74051 310 50

EN Magnetic holder for tools
PL Uchwyt magnetyczny na narzędzia
DE Magnethalter für Schlagschrauber
RU Магнитный держатель для ударного гайковерта
CZ Magnetický držák nářadí
HU Mágneses tartó
RO Suport magnetic pt. scule pneumatice
FR Support magnétique pour outils pneumatiques
IT Fissaggio magnetico per chiave ad impulsi pneumatica
ES Soporte magnético para llave de impacto
CN 磁性喷枪架

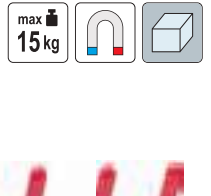

YATO
YT-08707 5/10

EN Workshop seat
PL Taboret warsztatowy
DE Werkstatt-Sitz
RU Табурет рабочий
CZ Dilenský taburet
HU Műhely zsámoly
RO Taburet atelier
FR Tabouret d'atelier
IT Sgabello da officina
ES Taburete de taller
CN 修车凳

450x270
x350 mm
max 140 kg
360°
4x



YATO

YT-08792

1

EN Workshop seat with drawers
PL Taboret warsztatowy z szufladami
DE Werkstatthocker mit Schubladen
RU Табурет для мастерской с выдвижными ящиками
CZ Stolička do dílny se zásuvkami
HU Műhelyszék fiókkal
RO Taburet atelier cu sertare
FR Tabouret d'atelier avec tiroirs
IT Sgabello da officina con cassetti
ES Taburete de taller con cajones
CN 双抽屉修车凳

530x470
x360 mm
2x

max 150 kg
360°
4x

2x
BRAKE
HAMULEC



YATO

YT-08790

1

EN Workshop seat with drawer
PL Taboret warsztatowy z szufladą
DE Werkstatthocker mit Schublade
RU Табурет для мастерской с выдвижным ящиком
CZ Stolička do dílny se zásuvkou
HU Műhelyszék fiókkal
RO Taburet atelier cu sertar
FR Tabouret d'atelier avec un tiroir
IT Sgabello da officina con un cassetto
ES Taburete de taller con cajón
CN 轻型修车凳

440x360
x390 mm
1x

max 150 kg
360°
4x



YATO

YT-08791

2

EN Adjustable roller stool with drawers
PL Siedzisko warsztatowe z szufladami
DE Werkstatt-Sitz mit Schubladen
RU Сиденье для мастерской с выдвижными ящиками
CZ Sedátko do dílny se zásuvkami
HU Műhelyszék fiókkal
RO Scaun atelier reglabil
FR Siège d'atelier avec tiroirs
IT Seggiolino da officina con cassetti
ES Silla de taller con cajones
CN 重型方形修车凳

380x380
x450-560 mm

3x

max 150 kg
360°
4x



YATO

YT-08795

1

EN Adjustable workshop seat
PL Siedzisko warsztatowe teleskopowe
DE Werkstatthocker, teleskopisch
RU Сиденье для мастерской
CZ Nastavitelné dílenské sedátko
HU Teleszkópos műhely zsámoly
RO Scaun atelier reglabil
FR Tabouret d'atelier télescopique
IT Sgabello da officina regolabile
ES Taburete de taller neumático
CN 修车凳

420x420
x410-550 mm

max 140 kg
360°
4x



YATO

YT-08793

1

EN Workshop creeper
PL Leżanka warsztatowa
DE Werkstatt-Liege
RU Лежак ремонтный
CZ Montážní lehátko
HU Fekpad gurulós

RO Targă service
FR Chariot de visite
IT Lettino sottomacchina
ES Camilla para mecánico
CN 修车躺板

100 cm
6x



YATO

YT-0880

1

EN Workshop creeper
PL Leżanka warsztatowa
DE Werkstatt-Liege
RU Лежак ремонтный
CZ Montážní lehátko
HU Fekpad gurulós

RO Targă service
FR Chariot de visite
IT Lettino sottomacchina
ES Camilla para mecánico
CN 修车躺板

91 cm
120 kg
150 kg
6x



YATO

YT-08802

1

EN Kneeling mat
PL Mata pod kolana
DE Kniematte
RU Подставка для колен
CZ Podložka pod kolena
HU Térdalát
RO Covorăș pt. genunchi
FR Tapis de protection des genoux
IT Tappetino per ginocchia
ES Alfombrilla para las rodillas
CN 跪垫

210x450 mm
30 mm
EPE

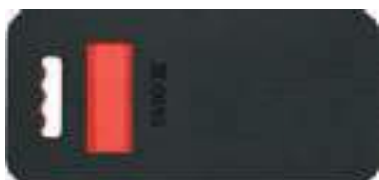

YATO

YT-08280

40

EN Workshop mat set
PL Zestaw mat warsztatowych
DE Werkstattmatten
RU Пенные коврики для мастерской
CZ Pěnové podložky do dílny
HU Hab garázs szőnyegek
RO Covorășe protecție pardoseală
FR Jeu de tapis antidérapants
IT Set di stuoie per officina
ES Baldosas para taller
CN 地垫

6 PCS
60x60 cm

max 12 mm
EVA



YATO

YT-08780

6

EN Automotive circuit tester
 PL Wskaźnik elektryczny samochodowy
 DE KFZ-Spannungsprüfer
 RU Пробник автомобильный
 CZ Automobilová zkoušečka napětí
 HU Autós fáziszeruza
 RO Tester pt. circuite auto
 FR Testeur de tension pour automobile
 IT Cercafase per auto
 ES Comprobador de voltaje para auto
 CN 汽车测电笔



YATO	
YT-2865	25/250

YATO	
YT-2866	10/100

YATO	
YT-28667	25/100

EN Cloth cable wrap tape
 PL Taśma parczana do wiązek kabli
 DE Gewebeband für Kabelbäume
 RU Лента холщевая для кабельных пучков
 CZ Plátěná páska do kabelových svazků
 HU Poliészter kábelkötég szalag
 RO Banda panza pt. izolat cabluri
 FR Ruban adhésif textile
 IT Nastro di tela per cablaggi
 ES Cinchas para haces de cables
 CN 绒布线束胶带



YATO	W [mm]	L [m]	+/- [mm]	
YT-81500	19	15	0.3	10/200
YT-81501	19	25	0.3	10/120

EN Number stamps
 PL Znaczniki cyfrowe
 DE Nummernstempel
 RU Клейма цифровые
 CZ Razidla číselná
 HU Számbeütők
 RO Poansoane cu cifre
 FR Chiffres à frapper
 IT Punzoni marcatori
 ES Marcadores de números
 CN 数字冲模

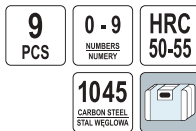

EN Letter stamps
 PL Znaczniki literowe
 DE Buchstabenstempel
 RU Клейма буквенные
 CZ Razidla písmenová
 HU Betűbeütők
 RO Poansoane cu litere
 FR Lettres à frapper
 IT Punzoni marcatori
 ES Marcadores de letras
 CN 字母冲模

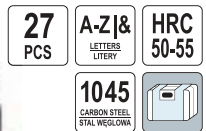

YATO	Digit height / Wysokość cyfr [mm]	pcs / szt.	
YT-6854	6	9	20
YT-6855	8	9	18

YATO	Letter height / Wysokość liter [mm]	pcs / szt.	
YT-6862	6	27	12
YT-6863	8	27	8

EN Lambda sensor thread chaser
 PL Zestaw do naprawy gwintów sondy lambda
 DE Lambdasonden-Gewinde-Reparaturset
 RU Набор для ремонта резьбы лямбды-зонда
 CZ Sada na opravu závitu lambda sondy
 HU Lambda szonda menetjavító készlet
 RO Dispozitiv pt. rectificat filet sonda lambda
 FR Jeu de réparation pour filetage de sonde lambda
 IT Kit di riparazione per filettatura della sonda lambda
 ES Herramienta de reparación de roscas de sonda lambda
 CN 火星塞丝攻组套



EN Oil pan thread repair set
 PL Zestaw naprawy korków do miski olejowej
 DE Reparatursatz für Verschlußstopfen von Ölwannen
 RU Набор для ремонта масляных пробок
 CZ Souprava na opravu vypořičících šroubů olejových van
 HU Olajteknő-csavar javítókészlet
 RO Set pt. reparare buşoane baie de ulei
 FR Kit de réparation de bouchons de vidange d'huile
 IT Set per riparazione dei tappi della coppa olio
 ES Juego de reparación para tapón de cárter de aceite
 CN 油底壳螺丝修复工具



M13, M15, M17, M20;
 M13, M15, M17, M20 (x5 PCS);
 13, 15, 17, 20 mm (x10 PCS)

YATO	
YT-1756	12/96

YATO	
YT-1757	5

- EN Oil pan thread repair set
PL Zestaw naprawczy korków do miski olejowej
DE Reparatursatz für Verschlussstopfen von Ölwanne
RU Набор для ремонта масляных пробок
CZ Souprava na opravu vypouštěcích šroubů olejových van
HU Olajteknő-csavar javítókészlet
RO Set pt. reparare bușoane baie de ulei
FR Kit de réparation de bouchons de vidange d'huile
IT Set per riparazione dei tappi della coppa olio
ES Juego de reparación para tapón de cárter de aceite
CN 油底壳螺丝修复工具

7
PCS



YATO	Thread size / Rozmiar gwintu	
YT-17567	M11x1.5 mm	10/40
YT-17571	M13x1.5 mm	10/40
YT-17568	M14x1.25 mm	10/40
YT-17572	M15x1.5 mm	10/40
YT-17573	M17x1.5 mm	10/40
YT-17569	M18x1.5 mm	10/40
YT-17574	M20x1.5 mm	10/40
YT-17575	M22x1.5 mm	10/40

- EN Thread repair set
PL Zestaw do naprawy gwintów
DE Gewinde-Reparatur-Satz
RU Набор для ремонта резьбы
CZ Sada na opravu závitů
HU Menetjavító készlet
RO Set pt. reparat filete
FR Kit de réparation de filetage
IT Kit di riparazione per filettature
ES Juego para reparar roscas
CN 螺纹修复组套

88
PCS

HSS
4341

SS
STAINLESS STEEL
STAL NIERDZEWNA



YATO	Dimensions / Wymiary	
YT-1769	M6x1x10.8 mm, M8x1.25x10.8 mm, M10x1.5x13.5 mm	5/10

- EN Wire threads
PL Wkłady spiralne do naprawy gwintów
DE Gewindeeinsätze für Gewindereparatur
RU Спиральные вставки для ремонта резьбы
CZ Spirálové vložky na opravu závitů
HU Menetjavító betétek

- RO Inserție spiralată pt. reparare filete
FR Inserts de réparation de filetage
IT Inserti a spirale per riparazione filettature
ES Insertos para reparación de roscas
CN 螺紋套



YATO	Dimensions / Wymiary	pcs / szt.	For / Dla	
YT-1764	M5x0.8x6.7 mm	20	YT-1763, YT-17631	50/250
YT-1765	M6x1x10.8 mm	20	YT-1763, YT-17632, YT-1769	50/250
YT-1766	M8x1.25x10.8 mm	20	YT-1763, YT-17633, YT-1769	50/200
YT-176821	M10x1x15 mm	15	YT-17682	200
YT-176831	M10x1.25x15 mm	15	YT-17683	200
YT-1767	M10x1.5x13.5 mm	15	YT-1763, YT-17634, YT-1769	200

- EN Oil pan thread repair set
PL Zestaw naprawczy korków do miski olejowej
DE Reparatursatz für Verschlussstopfen von Ölwanne
RU Набор для ремонта масляных пробок
CZ Souprava na opravu vypouštěcích šroubů olejových van
HU Olajteknő-csavar javítókészlet
RO Set pt. reparare bușoane baie de ulei
FR Kit de réparation de bouchons de vidange d'huile
IT Set per riparazione dei tappi della coppa olio
ES Juego de reparación para tapón de cárter de aceite
CN 油底壳螺丝修复工具

114
PCS

GCr15



M13x1.25, M13x1.5, M15x1.5, M17x1.5, M20x1.5, M22x1.5; GCr15;
M13x1.25, M13x1.5, M15x1.5, M17x1.5, M20x1.5, M22x1.5 (x6 PCS); A3;
13 mm (24 PCS), 15, 17, 20, 22 mm (x12 PCS); Al

YATO	
YT-17565	5

- EN Thread repair set
PL Zestaw do naprawy gwintów
DE Gewinde-Reparatur-Satz
RU Набор для ремонта резьбы
CZ Sada na opravu závitů
HU Menetjavító készlet
RO Set pt. reparat filete
FR Kit de réparation de filetage
IT Kit di riparazione per filettature
ES Juego para reparar roscas
CN 螺纹修复组套

131
PCS

HSS
4341

SS
STAINLESS STEEL
STAL NIERDZEWNA



YATO	Dimensions / Wymiary	
YT-1763	M5x0.8x6.7 mm, M6x1x10.8 mm, M8x1.25x10.8 mm, M10x1.5x13.5 mm, M12x1.75x16.3 mm	5/10

SS
STAINLESS STEEL
STAL NIERDZEWNA



YATO	Dimensions / Wymiary	pcs / szt.	For / Dla	
YT-176841	M12x1.25x18 mm	10	YT-17684	200
YT-176851	M12x1.5x18 mm	10	YT-17685	200
YT-1768	M12x1.75x16.3 mm	10	YT-1763, YT-17635	25/200
YT-176861	M14x1.25x21 mm	10	YT-17686	200
YT-176871	M14x1.5x21 mm	10	YT-17687	200

- EN Thread repair set
- PL Zestaw do naprawy gwintów
- DE Gewinde-Reparatur-Satz
- RU Набор для ремонта резьбы
- CZ Sada na opravu závitů
- HU Menetjavító készlet
- RO Set pt. reparat filete
- FR Kit de réparation de filetage
- IT Kit di riparazione per filettature
- ES Juego para reparar roscas
- CN 螺纹修复组套



HSS
4241
4341

SS
STAINLESS STEEL
STAL MIERCZEWIA



YATO	Thread size / Rozmiar gwintu	pcs / szt.	
YT-17631	M5x0.8 mm	30	20/40
YT-17632	M6x1.0 mm	30	20/40
YT-17633	M8x1.25 mm	30	20/40
YT-17682	M10x1.0 mm	30	20/40
YT-17683	M10x1.25 mm	30	20/40
YT-17634	M10x1.5 mm	30	20/40
YT-17684	M12x1.25 mm	20	20/40
YT-17685	M12x1.5 mm	20	20/40
YT-17635	M12x1.75 mm	30	20/40
YT-17686	M14x1.25 mm	15	10/30
YT-17687	M14x1.5 mm	15	10/30
YT-17688	M16x2.0 mm	15	10

- EN Spark plug thread repair set
- PL Zestaw naprawy gwintu świecy zapłonowej
- DE Reparatursatz für Zündkerzengewinde
- RU Набор для восстановления резьбы свечи зажигания
- CZ Sada pro opravu závitů zážehové svíčky
- HU Gyújtógyertya menetjavító készlet
- RO Set reparat filet bujie
- FR Kit de réparation du filetage de bougie d'allumage
- IT Kit di riparazione per cavi di candele di accensione
- ES Kit de reparación para rosca de bujía de encendido
- CN 火花塞螺纹修复工具

16 PCS **M14** x1.25 **11.5** mm
M16 x1.25 **17.5** mm



Rethreader tap / Gwintownik: M16x1.25; Spark plug inserts / Wkładki gwintowane: M14x1.25 (15 PCS)

YATO	
YT-17580	20

- EN Internal spark plug thread chaser set
- PL Zestaw gwintowników do świec
- DE Nachschneider-Set für Zündkerzen-Gewinde
- RU Набор метчиков резьбы под свечи накаливания
- CZ Sada na opravu závitů zapalovacích svíček
- HU Gyújtógyertya menetjavító készlet
- RO Set pt. refăcut filete bujii incandescente
- FR Set de tarauds pour filetage de bougie d'allumage
- IT Kit di maschi per candele
- ES Juego de machos rosca para bujías
- CN 火花塞螺纹修复工具

7 PCS **LONG** **DRUDGE** **CrMo**



M8 x 1.0 x 115 mm, M10 x 1.0 x 115 mm, M12 x 1.25 x 135 mm, M12 x 1.25 x 260 mm, M14 x 1.25 x 130 mm, M14 x 1.25 x 260 mm, M18 x 1.5 x 80 mm

YATO	
YT-17708	10

- EN Spark plug thread repair set
- PL Zestaw naprawy gwintu świecy zapłonowej
- DE Reparatursatz für Zündkerzengewinde
- RU Набор для восстановления резьбы свечи зажигания
- CZ Sada pro opravu závitů zážehové svíčky
- HU Gyújtógyertya menetjavító készlet
- RO Set reparat filet bujie
- FR Kit de réparation du filetage de bougie d'allumage
- IT Kit di riparazione per cavi di candele di accensione
- ES Kit de reparación para rosca de bujía de encendido
- CN 火花塞螺纹修复工具

5 PCS **M14** x1.25 **M16** x1.25



Rethreader tap / Gwintownik: M16x1.25; Spark plug inserts / Wkładki gwintowane: M14x1.25 (10, 11, 13, 19 mm)

YATO	
YT-17582	12/96

- EN Spark plug thread repair set
- PL Zestaw naprawy gwintu świecy zapłonowej
- DE Reparatursatz für Zündkerzengewinde
- RU Набор для восстановления резьбы свечи зажигания
- CZ Sada pro opravu závitů zážehové svíčky
- HU Gyújtógyertya menetjavító készlet
- RO Set reparat filet bujie
- FR Kit de réparation du filetage de bougie d'allumage
- IT Kit di riparazione per cavi di candele di accensione
- ES Kit de reparación para rosca de bujía de encendido
- CN 火花塞螺纹修复工具

25 PCS **M14** x1.25 **10** mm
15 mm **3/8"** 9.5 mm **HSS**



YATO	
YT-17581	10

- EN Brake calliper guide bolt repair tool set
- PL Zestaw naprawy prowadnic zacisków hamulcowych
- DE Reparatursatz für Bremssattelführungen
- RU Набор для ремонта направляющих тормозного суппорта
- CZ Sada pro opravu vodítek brzdových třmenů
- HU Féknyereg vezetőpersely szerelő készlet
- RO Set pt. repararea ghidaj etrier
- FR Kit de réparation pour les guides d'étrier de frein
- IT Kit di riparazione per guide di scorrimento delle pinze di freni
- ES Kit de reparación para guías de mordazas de freno
- CN 刹车卡钳螺栓修复工具

12 PCS **M10** x1.25
HSS **VAG**
FORD **OPEL**



Ford, Opel, VAG

YATO	
YT-17588	20

- EN Spark plug thread chaser
PL Zestaw do naprawy gwintów świec
DE Stopfengewinde-Reparaturset
RU Набор для ремонта резьбы свечей
CZ Sada na opravu závitů svíček
HU Gyertyamenet javító készlet
RO Set pt. curăţat filet bujii
FR Kit de réparation pour filet de bougies d'allumage
IT Kit per riparazione di filettature di candele
ES Kit de reparación de roscas de bujía
CN 火星塞丝攻组套

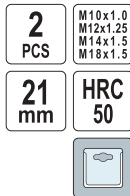

YATO
YT-17697 16/64

- EN Glow plug threads repair kit
PL Zestaw naprawczy gwintów świec żarowych
DE Reparatursatz für Glühkerzengewinde
RU Набор для ремонта резьбы свечи накаливания
CZ Sada pro opravu závitů žhavicích svíček
HU Izzítógyertya menetjavító készlet
RO Set de reparare filete bujii incandescente
FR Kit de réparation pour les filetages des bougies de préchauffage
IT Kit di riparazione per filettature di candele di accensione
ES Kit de reparación para roscas de bujías de calentamiento
CN 预热塞修理工具



Included / W zestawie: reamers / rozwiertaki: M8x1.0, M9x1.0, M10x1.0, M10x1.25, M12x1.25; threaded sleeves / tuleje gwintowane: M8x1.0 (11 mm), M9x1.0 (11 mm), M10x1.25 (12 mm), M10x1.0 (12 mm), M10x1.0 (19 mm), M12x1.25 (12 mm), M12x1.25 (19 mm), M12x1.25 (26 mm) (x5 PCS); taps for threaded sleeves / przyrządy do instalacji wkładek (5 PCS); screws / śruby prowadzące (8 PCS); taps for rethreading the original thread / gwintowniki do poprawy gwintów (5 PCS); taps for new thread / gwintowniki nadwymiarowe (5 PCS)

YATO
YT-17711 5

- EN Rethread tool kit set
PL Zestaw do naprawy gwintów śrub i nakrętek
DE Gewindereparaturatz für Schrauben und Mutter
RU Комплект для ремонта резьбы на винтах и гайках
CZ Sada pro opravu závitů na šroubech a maticích
HU Csavarok és anyák meteteinek javítására szolgáló készlet
- RO Kit pt. reparat filet
FR Kit de réparation de filetage
IT Kit di riparazione delle filettature viti e dadi
ES Kit de reparación de roscas en tornillos y tuercas
CN 螺纹修复工具组套

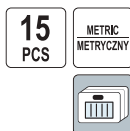

Metric thread file pitches / Pilnik do naprawy gwintów: 0.75, 1.0, 1.25, 1.5, 1.75, 2.0, 2.5, 3.0 mm; Rethreader dies / Narzynyki: 6x1.00, 8x1.25, 10x1.25, 10x1.50, 12x1.25, 12x1.50, 12x1.75 mm; Rethreader taps / Gwintowniki: 6x1.00, 8x1.25, 10x1.25, 10x1.50, 12x1.25, 12x1.50, 12x1.75 mm

YATO
YT-17705 20

- EN Glow plug threads repair kit
PL Zestaw naprawczy gwintów świec żarowych
DE Reparatursatz für Glühkerzengewinde
RU Набор для ремонта резьбы свечи накаливания
CZ Sada pro opravu závitů žhavicích svíček
HU Izzítógyertya menetjavító készlet
RO Set de reparare filete bujii incandescente
FR Kit de réparation pour les filetages des bougies de préchauffage
IT Kit di riparazione per filettature di candele di accensione
ES Kit de reparación para roscas de bujías de calentamiento
CN 预热塞修理工具

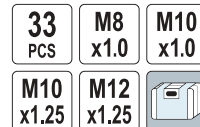

Included / W zestawie: reamers / rozwiertaki: M8x1.0, M10x1.0, M10x1.25, M12x1.0, M12x1.25, M14x1.25; threaded sleeves / tuleje gwintowane: M8x1.0, M10x1.0, M10x1.25, M12x1.25 (x5 PCS); screws / śruby prowadzące (3 PCS); taps for rethreading the original thread / gwintowniki do poprawy gwintów (2 PCS); handle / uchwyty

YATO
YT-17710 10

- EN Brake thread repair set
PL Zestaw naprawczy gwintów zacisku hamulcowego
DE Gewindereparaturatz für Bremssattel
RU Комплект для ремонта резьбы суппорта тормоза
CZ Sada na opravu závitů brzdového třmenu
HU Féknyereg menetjavító készlet
RO Set reparat filete etrier frână
FR Kit de réparation pour filetages d'étriers de frein
IT Kit di riparazione per filettature di pinze di freni
ES Kit de reparación de roscas para pinzas de freno
CN 刹车螺纹修复工具

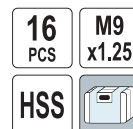

Ford, Opel, VAG

YATO
YT-17700 10

- EN Metric thread file
PL Pilnik do gwintów metrycznych
DE Gewindefeile für metrische Gewinde
RU Напильник для реставрации метрической резьбы
CZ Pilník na opravu metrických závitů
HU Metrikus menetreszelő
RO Pila pt. filet metric
FR Fichier pour filetages métriques
IT Lima per filetti metrici
ES Lima para roscas métricas
CN 修复锉



File pitches / Skoki pilnika: 0.75, 1.0, 1.25, 1.5, 1.75, 2.0, 2.5, 3.0 mm

YATO
YT-17590 10/50

EN Axle spindle rethreading set
 PL Zestaw do naprawy gwintów pólosi
 DE Gewinde-Reparatursatz für Antriebswellen
 RU Набор для восстановления резьбы оси шруса
 CZ Souprava k opravě závitů hnacích hřídelí
 HU Főtengely menettávitó készlet

RO Trusa pt. reparat filetele la planetare
 FR Kit réparation filetage arbre de transmission
 IT Kit di ripristino di filetti dei semiassi
 ES Juego de roscado de husillo de eje
 CN 传动轴螺杆修复组套

8
PCS

5/4"
32 mm



M24x1.5, M24x2.0, M22x1.0, M22x1.5, M20x1.25, M20x1.5, 3/4"x20 UNEF, 13/16"x20 UNEF

YATO

YT-17695

20

EN Axle spindle rethreading set
 PL Zestaw do naprawy gwintów pólosi
 DE Gewinde-Reparatursatz für Antriebswellen
 RU Набор для восстановления резьбы оси шруса
 CZ Souprava k opravě závitů hnacích hřídelí
 HU Főtengely menettávitó készlet
 RO Trusa pt. reparat filetele la planetare
 FR Kit réparation filetage arbre de transmission
 IT Kit di ripristino di filetti dei semiassi
 ES Juego de roscado de husillo de eje
 CN 传动轴螺杆修复组套

10
PCS

40Cr

CrV
50BV30



M20x1.25, M20x1.50, M22x1.00, M22x1.50, M24x1.50, M24x2.00, 13/16"x20 UNEF, 3/4"x20 UNEF; 40Cr; 27 mm; CrV 50BV30

YATO

YT-17605

10

EN Wheel stud thread repair kit
 PL Zestaw do naprawy gwintów śrub kol
 DE Gewinde-Reparatur-Satz für Radbolzen
 RU Набор для восстановления резьбы шпильки колес
 CZ Sada na opravu závitů šroubů kol
 HU Kerécsavar menettávitó készlet
 RO Kit pt. reparat filete roți
 FR Kit de réparation de filetages des boulons de roue
 IT Kit di riparazione filetti per viti delle ruote
 ES Juego de reparación de roscas de tornillos de ruedas
 CN 轮毂螺纹修复工具组套

8
PCS

METRIC
METRYCZNY



M12x1.25, M12x1.5, M14x1.5;
 M12x1.25, M12x1.5,
 M12x1.75, M14x1.5;
 24 mm

YATO

YT-17595

20

EN Internal and external thread chaser set
 PL Zestaw do naprawy gwintów zewnętrznych i wewnętrznych
 DE Außen- und Innengewinde-Reparaturset
 RU Комплект для ремонта наружной и внутренней резьбы
 CZ Sada na opravu vnitřních a vnějších závitů
 HU Külső- és belső menettávitó készlet
 RO Set pt. reparat filet intern și exterior
 FR Jeu de réparation pour filetage externe et interne
 IT Set per riparazione della filettatura interna ed esterna
 ES Juego de reparación para roscas interiores y exteriores
 CN 反向轮毂修理工具

9
PCS

40Cr



M14x1.5, M16x1.5,
 M18x1.5, M20x1.5,
 M22x1.5, M24x1.5,
 M27x2.2, M30x1.5;
 40Cr

YATO

YT-17600

10

EN Injector clamping bolt thread repair kit
 PL Zestaw naprawczy do gwintów śrub mocujących wtryskiwacze
 DE Gewinde-Reparatur Satz für Injektor-Befestigungsschraube
 RU Набор для ремонта резьбы крепежных винтов форсунок
 CZ Sada na opravu závitů upevňovacích šroubů vstřikovače
 HU Menettávitó készlet befecskendezők rögzítőcsavarjainhoz
 RO Kit de reparare a filetelui de strângere a injectorelor
 FR Kit de réparation filetage pour vis de fixation injecteur
 IT Kit per riparazione di filettature delle viti di fissaggio per iniettori
 ES Kit de reparación de roscas de tornillos de fijación de inyectores
 CN 喷油器夹紧螺栓螺纹修复

10
PCS

MERCEDES
M6X1

HSS



YATO

YT-06036

10

EN Pressure gauge
 PL Wskaźnik ciśnienia
 DE Druckanzeige
 RU Манометр
 CZ Tlakomer
 HU Nyomásmérő

RO Manometru
 FR Manomètre
 IT Manometro
 ES Manómetro
 CN 压力计

0-15
bar

0-220
psi

140 mm

FOR TRUCKS
DO NOT
OIL-DRIVEN



YATO

YT-24301

25/100

EN Foot pump with gauge
PL Pompka nożna z manometrem
DE Fusspumpe
RU Насос ножный с манометром
CZ Nožní pumpa s manometrem
HU Lábpumpa nyomásmérővel
RO Pompă de picior cu manometru
FR Pompe à pied avec manomètre
IT Pompa a pedale con manometro
ES Bomba de pierna con manometro
CN 打气筒



0.7 MPa (max.)



YATO
YT-7349

10

EN Foot pump with gauge
PL Pompka nożna z manometrem
DE Fusspumpe
RU Насос ножный с манометром
CZ Nožní pumpa s manometrem
HU Lábpumpa nyomásmérővel
RO Pompă de picior cu manometru
FR Pompe à pied avec manomètre
IT Pompa a pedale con manometro
ES Bomba de pierna con manometro
CN 带压力表双管打气筒



0.7 MPa (max.)



YATO
YT-7350

10

EN Hand pump with manometer
PL Pompka słupkowa z manometrem
DE Hand-Luftpumpe mit Manometer
RU Насос ручной с манометром
CZ Pumpa s manometrem
HU Kézi pumpa manométerrel
RO Pompă de mana cu manometru
FR Pompe manuelle avec manomètre
IT Pompa verticale con manometro
ES Bomba de barrote con manometro
CN 直立式打气筒 (机械錶)



0.8 MPa (max.)
0-120 psi
65 cm



UNIVERSAL DOUBLE HEAD
UNIVERSALNA GŁOWICA
PODWÓJNA



YATO
YT-73521

3

EN Rechargeable air compressor
PL Kompressor bezprzewodowy
DE Kabelloser Kompressor
RU Беспроводной компрессор
CZ Bezdrátový kompresor
HU Vezeték nélküli kompresszor
RO Compresor de aer cu acumulator
FR Compresseur sans-fil
IT Compressore senza fili
ES Compresor inalámbrico
CN 充气泵

120 W 1.0 MPa 25 l/min 11.1V 2200mAh Li-Ion 4h 20min
USB CHARGING LADOWANIE 25 cm LED LIGHTING OŚWIETLENIE



Setups / Ustawienia: 3-150 psi, 0.2-10.3 bar, 20-995 kPa, 0.2-10.5 kg/cm²

YATO
YT-82950

[V d.c.]
11.1 (3.7 x3)

12

EN Car air compressor
PL Kompressor samochodowy
DE Auto-Kompressor
RU Автомобильный компрессор
CZ Automobilový kompresor
HU Autókompresszor
RO Compresor auto
FR Compresseur de voiture
IT Compressore d'auto
ES Compresor de coche
CN 车用充气泵



120 W 1.0 MPa 12V 25 l/min LCD
60 cm 3 m LED



YATO
YT-73470

[W]
120

12



EN Car air compressor
 PL Kompresor samochodowy
 DE Auto-Kompressor
 RU Автомобильный компрессор
 CZ Automobilový kompresor
 HU Autókompresszor

RO Compresor auto
 FR Compresseur de voiture
 IT Compressore d'auto
 ES Compresor de coche
 CN 车用充气泵

180 W
 1.0 MPa
 12V
 40 l/min
 1 m
 3 m



YATO	[W]	
YT-73460	180	8

EN Car air compressor
 PL Kompresor samochodowy
 DE Auto-Kompressor
 RU Автомобильный компрессор
 CZ Automobilový kompresor
 HU Autókompresszor

RO Compresor auto
 FR Compresseur de voiture
 IT Compressore d'auto
 ES Compresor de coche
 CN 车用充气泵

250 W
 1.0 MPa
 12V
 60 l/min
 5 m
 3 m



YATO	[W]	
YT-73462	250	4

EN Car air hose with quick coupler
 PL Waż z szybkozłączem do samochodów
 DE Schlauch mit Schnellkupplung für Autos
 RU Шланг с быстрым соединением для автомобилей
 CZ Vzduchová hadice do auta s rychlospojku
 HU Cépfűzős tömlő gyorscsatlakozóval
 RO Furtun aer cu conector rapid
 FR Tuyau avec connecteur rapide pour voitures
 IT Tubo con attacco rapido per auto
 ES Manguera con conector rápido para automóviles
 CN 车用空气软管

PVC



EN Tire inflator hose
 PL Waż do pompowania kół
 DE Reifen Inflator Schlauch
 RU Шланг накачки колес
 CZ Hadice pro nafukování kol
 HU Kerékfűző tömlő
 RO Furtun pt. umflarea anvelopelor
 FR Tuyau pour gonfler les roues
 IT Tubo per gonfiare le ruote
 ES Manguera para inflar ruedas
 CN 轮胎充气软管

PVC



YATO	L [m]	External diameter / Średnica zewnętrzna [mm]	Internal diameter / Średnica wewnętrzna [mm]	
YT-24270	8	10	6	8
YT-24271	12	10	6	10
YT-24272	18	10	6	7

YATO	L [m]	External diameter / Średnica zewnętrzna [mm]	Internal diameter / Średnica wewnętrzna [mm]	
YT-24280	8	10	6	8
YT-24281	12	10	6	10
YT-24282	18	10	6	7

EN Water hose reel
 PL Waż wodny na zwijaku
 DE Wasserschlauch-Trommel
 RU Шланг на катушке
 CZ Vodní hadice na navijáku
 HU Tömlő dobbal
 RO Tambur pt. furtun
 FR Tuyau d'eau avec enrouleur
 IT Avvolgitubo acqua
 ES Manguera de agua con enrollador
 CN 水软管卷盘

0.8 MPa (max.)
 15 m
 ø11.5mm

 EASILY MOUNT / ŁATWY MONTAZ
 PVC



YATO	
YT-24258	1

EN Air wedge
PL Poduszka montażowa
DE Luft Keil
RU Монтажная подушка
CZ Rozpínací montážní polštář
HU Emelőpárna
RO Perna de aer
FR Coussin élévateur
IT Cuscino di montaggio
ES Cojines elevadores
CN 门窗安装气囊



50 mm ↑ TPU



YATO	Size / Rozmiar [mm]	
YT-67380	150x160	24
YT-67381	165x150	48
YT-67382	190x110	48
YT-67383	270x130	48

EN Air pump wedge set
PL Zestaw poduszek montażowych
DE Montagekissen-Set
RU Набор монтажных подушек
CZ Rozpínací polštářky
HU Szerelőpárna készlet
RO Set perne de aer
FR Coussins d'air pour soulever
IT Set di cuscinetti gonfiabili per montaggio porte e finestre
ES Juego de bolsas de cuña de aire
CN 门窗安装气囊

3 PCS 165x150 mm 190x110 mm 270x130 mm
50 mm ↑ max 135 kg TPU



YATO	
YT-67385	48

EN Tire rack
PL Stojak na kola
DE Reifenständer
RU Стойка для колес
CZ Stojan na pneumatiky
HU Keréktartó állvány
RO Suport pt. depozitare anvelope
FR Support pour roues
IT Supporto verticale per pneumatici
ES Soporte para llantas
CN 轮胎架



max 225 mm max 100 kg (4x25)

YATO	
YT-55690	1

EN Mobile tire rack
PL Mobilny stojak na kola
DE Mobiler Reifenständer
RU Мобильная стойка для хранения шин
CZ Pojízdný stojan na pneumatiky
HU Mobil keréktartó állvány
RO Suport mobil pt. depozitare anvelope
FR Support pour roues mobile
IT Supporto verticale mobile per pneumatici
ES Soporte para llantas móvil
CN 移动式轮胎挂架



max 225 mm max 100 kg (4x25)
4x BRAKE HAMULEC 360° 4x

YATO	
YT-55691	6

EN Oil jug
PL Nalewak warsztatowy
DE Ölkanne
RU Лейка пластиковая с крышкой
CZ Odměrka plastová - konev
HU Olajbetöltő kanna
RO Recipient ulei
FR Broc verseur avec couvercle
IT Serbatoio
ES Jarra con pitorro de aceite
CN 油壶



PE FOR AUTOMOTIVE FLUIDS DO PLYNŃW EKSP. PŁYDACYJNYCH FLEXIBLE SPOUT ELASTYCZNY LEJEK

YATO		
YT-06980	1	48
YT-06983	3	40
YT-06985	5	16

EN Oil jug
PL Nalewak warsztatowy
DE Ölkanne
RU Лейка пластиковая с крышкой
CZ Odměrka plastová - konev
HU Olajbetöltő kanna
RO Recipient ulei
FR Broc verseur avec couvercle
IT Serbatoio
ES Jarra con pitorro de aceite
CN 油壶





10 L PE FOR AUTOMOTIVE FLUIDS DO PLYNŃW EKSP. PŁYDACYJNYCH

YATO		
YT-06987	10	8

EN Funnel
PL Lejek
DE Trichter
RU Воронка гибкая
CZ Nálevka
HU Kétrészes tölcser



RO Pâlnie
FR Entonnoir
IT Imbuto
ES Embudo
CN 漏斗



YATO 	Ø [mm]	
YT-0694	135	192

EN Long funnel
PL Lejek długi
DE Trichter
RU Воронка гибкая
CZ Nálevka
HU Kétrészes tölcser
RO Pâlnie
FR Entonnoir
IT Imbuto
ES Embudo
CN 漏斗





YATO 	L [mm]	Ø [mm]	
YT-0693	455	120	48

EN Operating fluids funnel
PL Lejek do płynów eksploatacyjnych
DE Trichter
RU Воронка гибкая
CZ Nálevka
HU Kétrészes tölcser

RO Pâlnie
FR Entonnoir
IT Imbuto
ES Embudo
CN 漏斗





YATO 	Ø [mm]	
YT-0695	100	180

EN Operating fluids funnel
PL Lejek do płynów eksploatacyjnych
DE Trichter
RU Воронка гибкая
CZ Nálevka
HU Kétrészes tölcser



RO Pâlnie
FR Entonnoir
IT Imbuto
ES Embudo
CN 漏斗



YATO 	Ø [mm]	
YT-0696	240	48

EN Fuel and oil funnel
PL Lejek do paliwa i oleju
DE Trichter
RU Воронка гибкая
CZ Nálevka
HU Kétrészes tölcser
RO Pâlnie
FR Entonnoir
IT Imbuto
ES Embudo
CN 漏斗





YATO 	Ø [mm]	
YT-0692	150	30

EN Oil funnel
PL Lejek do oleju
DE Trichter
RU Воронка гибкая
CZ Nálevka
HU Kétrészes tölcser



RO Pâlnie
FR Entonnoir
IT Imbuto
ES Embudo
CN 漏斗



YATO 	Ø [mm]	
YT-0697	280	48

EN Oil funnel with handle
PL Lejek specjalny z uchwytem
DE Spezialtrichter mit Griff
RU Специальная воронка с ручкой
CZ Speciální trychťyř s rukojetí
HU Speciális tölcser fogantyúval
RO Pâlnie pt. ulei cu maner
FR Entonnoir spécial avec poignée
IT Imbuto speciale con impugnatura
ES Embudo especial con soporte
CN 漏斗



YATO 	Ø [mm]	
YT-06972	20, 125	10/20

EN Manual car oil pump
PL Odsysarka ręczna do oleju
DE Manuelle Öl-Absaugpumpe
RU Ручной насос для откачки масла
CZ Ruční vakuová odsávačka oleje
HU Kézi olajleszívó pumpa
RO Pompă extracție ulei
FR Pompe à vide d'extraction d'huile
IT Aspiratore manuale per olio
ES Bomba manual para extracción de aceite
CN 手动抽油机

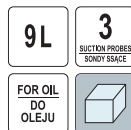

YATO 	
YT-07087	4

EN Waste oil storage container
PL Pojemnik zlewowy do oleju
DE Öl-Auffangkanister
RU Емкость для слива отработанного масла
CZ Nádoba na použitý olej
HU Fáradt olaj gyűjtő

RO Recipient colectare ulei
FR Bidon de collecte d'huile
IT Tanica per cambio olio
ES Bidón cambio de aceite
CN 积油壶



600x330
x110
mm

8L

PE

EN Oil drainer
PL Zlewarka do oleju
DE Öleinfüllanlage
RU Установка для сбора отработанного масла
CZ Sběrná nádoba na olej
HU Olajleeresztő tartály
RO Bazin recuperare ulei uzat
FR Récupérateur d'huile
IT Serbatoio di scarico dell'olio esausto
ES Colector de aceite usado
CN 接油车



20L

∅ 42 cm

75-155 cm

PE

YATO	[l]	[mm]	
YT-06995	8	600x330x110	4

EN Oil drain pan
PL Miska do oleju
DE Ölwanne
RU Поддон для слива масла
CZ Miska na olej
HU Fáradt olaj felfogó edény

RO Vas pt. scurgerea uleiului
FR Bac de récupération d'huile
IT Vaschetta per cambio olio
ES Recipiente para drenaje de aceite
CN 接油盆



7L

PP

YATO	[l]	∅ [mm]	
YT-0699	7	370	24

EN Oil drain pan
PL Miska do oleju
DE Ölwanne
RU Поддон для слива масла
CZ Miska na olej
HU Fáradt olaj felfogó edény

RO Vas pt. scurgerea uleiului
FR Bac de récupération d'huile
IT Vaschetta per cambio olio
ES Recipiente para drenaje de aceite
CN 接油盆



PE

YATO	[l]	∅ [mm]	
YT-0716	10	370	6
YT-0717	15	420	6

EN Oil drain pan / tool tray
PL Miska do oleju / taca warsztatowa
DE Ölwanne / Werkstattschale
RU Поддон для инструментов и слива масла
CZ Miska na olej / dílenský táč
HU Fáradt olaj felfogó edény / műhelytálca
RO Vas de scurgere a uleiului / tavă pt. scule
FR Bac de récupération d'huile / bac à outils
IT Vaschetta per cambio olio / vassoio da officina
ES Recipiente para drenaje de aceite / bandeja de taller
CN 接油盘

8L

360°

∅ 50 mm

PP



YATO	[l]	Size / Rozmiar [mm]	
YT-06992	8	470x137	3

EN Farm jack
PL Podnośnik farmerski
DE Offroad-Wagenheber
RU Домкрат механический реечный
CZ Pákový zvedák
HU Fogaslécés emelő
RO Cric mecanic tip off-road
FR Cric mécanique à levier
IT Binda meccanica per fuoristrada
ES Gato de trinquete
CN 农夫顶

2t

690
115
mm



YATO	[t]	Lifting range / Zakres podnoszenia [mm]	
YT-172601	2	115-690	1

EN Farm jack
PL Podnośnik farmerski
DE Offroad-Wagenheber
RU Домкрат механический реечный
CZ Pákový zvedák
HU Fogaslécés emelő
RO Cric mecanic tip off-road
FR Cric mécanique à levier
IT Binda meccanica per fuoristrada
ES Gato de trinquete
CN 农夫顶

3t

1060
125
mm



YATO	[t]	Lifting range / Zakres podnoszenia [mm]	
YT-17261	3	125-1060	1

EN Farm jack
PL Podnośnik farmerski
DE Offroad-Wagenheber
RU Домкрат механический реечный
CZ Pákový zvedák
HU Fogaslécés emelő
RO Cric mecanic tip off-road
FR Cric mécanique à levier
IT Binda meccanica per fuoristrada
ES Gato de trinquete
CN 农夫顶

3t

1320
125
mm





YATO	[t]	Lifting range / Zakres podnoszenia [mm]	
YT-17262	3	125-1320	1



EN Hydraulic bottle jack
 PL Podnośnik hydrauliczny słupkowy
 DE Hydraulischer Stempelwagenheber
 RU Домкрат гидравлический бутылочный
 CZ Hydraulický pístový zvedák
 HU Hidraulikus palack emelő
 RO Cric hidraulic
 FR Cric bouteille hydraulique
 IT Cric idraulico a bottiglia
 ES Gato hidráulico de botella
 CN 立式液压千斤顶

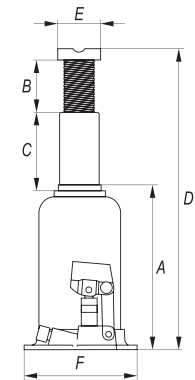
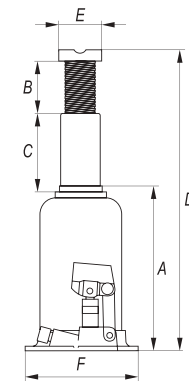

EN Hydraulic bottle jack
 PL Podnośnik hydrauliczny słupkowy
 DE Hydraulischer Stempelwagenheber
 RU Домкрат гидравлический бутылочный
 CZ Hydraulický pístový zvedák
 HU Hidraulikus palack emelő
 RO Cric hidraulic
 FR Cric bouteille hydraulique
 IT Cric idraulico a bottiglia
 ES Gato hidráulico de botella
 CN 立式液压千斤顶



YATO 	[t]	A [mm]	B [mm]	C [mm]	D [mm]	E [mm]	F [mm]	
YT-17000	2	181	48	116	345	25	88x92	6
YT-17001	3	194	60	120	374	27	92x100	6
YT-17002	5	216	60	137	413	29	96x110	4
YT-17003	8	230	80	147	457	32	103x118	2
YT-17004	10	230	80	150	460	36	110x123	2
YT-17005	12	230	80	155	465	40	116x134	2
YT-17006	15	230	82	150	462	43	140x134	2
YT-17007	20	242	60	150	452	45	144x150	2
YT-17008	32	285	-	180	465	69	190x152	1
YT-17009	50	300	-	180	480	83	218x176	1



YATO 	[t]	A [mm]	B [mm]	C [mm]	D [mm]	E [mm]	F [mm]	
YT-17015	2	172	88	112	372	28	103x105	4
YT-1702	5	218	110	146	474	25	110x112	5
YT-17025	8	220	115	153	488	45	124x127.5	2
YT-1704	10	220	115	148	483	48	124x127.5	3
YT-17045	12	230	115	160	505	45	130x136	2
YT-1706	15	228	113	154	508	56	140x142	2
YT-1707	20	241	115	165	521	60	165x161	2
YT-17075	25	240	110	160	510	65	186x174	1
YT-1709	30	244	108	140	510	65	186x174	1



EN Two-piston hydraulic bottle jack
 PL Podnośnik hydrauliczny słupkowy dwutokowy
 DE Hydraulischer Stempelwagenheber
 RU Домкрат бутылочный двухштоковый
 CZ Hydraulický pístový zvedák
 HU Hidraulikus palack emelő
 RO Cric hidraulic
 FR Cric bouteille hydraulique
 IT Cric idraulico a bottiglia
 ES Gato hidráulico de botella
 CN 液压双级千斤顶

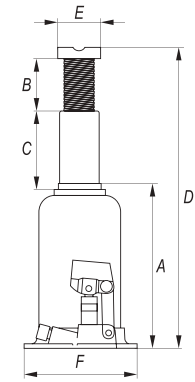
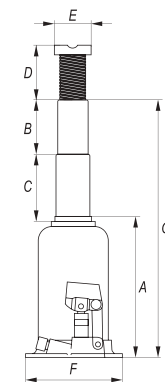

EN Two-piston hydraulic bottle jack
 PL Podnośnik hydrauliczny słupkowy dwutokowy
 DE Hydraulischer Stempelwagenheber
 RU Домкрат бутылочный двухштоковый
 CZ Hydraulický pístový zvedák
 HU Hidraulikus palack emelő
 RO Cric hidraulic
 FR Cric bouteille hydraulique
 IT Cric idraulico a bottiglia
 ES Gato hidráulico de botella
 CN 液压双级千斤顶



YATO 	[t]	A [mm]	B [mm]	C [mm]	D [mm]	E [mm]	F [mm]	
YT-1711	5	230	146	138	500	41	130x136	2
YT-1713	10	125	63	38	215	47	160x165	2

YATO 	[t]	A [mm]	B [mm]	C [mm]	D [mm]	E [mm]	F [mm]	G [mm]	
YT-1714	10	210	120	118	78	48	165x161	520	1
YT-1715	12	235	138	128	98	56	186x174.5	590	1

EN Hydraulic floor jack
PL Podnośnik hydrauliczny
DE Hydraulischer Rangierwagenheber
RU Домкрат гидравлический
CZ Pístový zvedák hydraulický
HU Krokodíl emelő
RO Cric tip crocodil
FR Cric hydraulique
IT Sollevatore idraulico
ES Gato hidráulico
CN 卧式液压千斤顶

2t
359
89 mm



YATO	[t]	
YT-1720	2	1

EN Hydraulic floor jack
PL Podnośnik hydrauliczny
DE Hydraulischer Rangierwagenheber
RU Домкрат гидравлический
CZ Pístový zvedák hydraulický
HU Krokodíl emelő
RO Cric tip crocodil
FR Cric hydraulique
IT Sollevatore idraulico
ES Gato hidráulico
CN 卧式液压千斤顶

2.5t
508
80 mm
DUAL PUMP
PODWÓJNA
POMPA
QUICK LIFT
SZYBKE
PODNOŻENIE
LOW PROFILE
NISKI
PROFIL



YATO	[t]	
YT-17207	2.5	1

EN Hydraulic floor jack
PL Podnośnik hydrauliczny
DE Hydraulischer Rangierwagenheber
RU Домкрат гидравлический
CZ Pístový zvedák hydraulický
HU Krokodíl emelő
RO Cric tip crocodil
FR Cric hydraulique
IT Sollevatore idraulico
ES Gato hidráulico
CN 卧式液压千斤顶

3t
465
130 mm
LOW PROFILE
NISKI
PROFIL



YATO	[t]	
YT-17211	3	1

EN Hydraulic floor jack
PL Podnośnik hydrauliczny
DE Hydraulischer Rangierwagenheber
RU Домкрат гидравлический
CZ Pístový zvedák hydraulický
HU Krokodíl emelő
RO Cric tip crocodil
FR Cric hydraulique
IT Sollevatore idraulico
ES Gato hidráulico
CN 卧式液压千斤顶



YATO	[t]	
YT-17214	3	1

EN Hydraulic floor jack
PL Podnośnik hydrauliczny
DE Hydraulischer Rangierwagenheber
RU Домкрат гидравлический
CZ Pístový zvedák hydraulický
HU Krokodíl emelő
RO Cric tip crocodil
FR Cric hydraulique
IT Sollevatore idraulico
ES Gato hidráulico
CN 卧式液压千斤顶

2.5t
465
100 mm
DUAL PUMP
PODWÓJNA
POMPA
QUICK LIFT
SZYBKE
PODNOŻENIE
AI



ULTRA LIGHT

YATO	[t]	
YT-17205	2.5	1

EN Hydraulic floor jack
PL Podnośnik hydrauliczny
DE Hydraulischer Rangierwagenheber
RU Домкрат гидравлический
CZ Pístový zvedák hydraulický
HU Krokodíl emelő
RO Cric tip crocodil
FR Cric hydraulique
IT Sollevatore idraulico
ES Gato hidráulico
CN 卧式液压千斤顶

2.5t
455
87 mm



YATO	[t]	
YT-1721	2.5	1

EN Hydraulic floor jack
PL Podnośnik hydrauliczny
DE Hydraulischer Rangierwagenheber
RU Домкрат гидравлический
CZ Pístový zvedák hydraulický
HU Krokodíl emelő
RO Cric tip crocodil
FR Cric hydraulique
IT Sollevatore idraulico
ES Gato hidráulico
CN 卧式液压千斤顶

3t
500
145 mm



YATO	[t]	
YT-17213	3	1

EN Hydraulic floor jack
PL Podnośnik hydrauliczny
DE Hydraulischer Rangierwagenheber
RU Домкрат гидравлический
CZ Pístový zvedák hydraulický
HU Krokodíl emelő
RO Cric tip crocodil
FR Cric hydraulique
IT Sollevatore idraulico
ES Gato hidráulico
CN 卧式液压千斤顶

3t
465
130 mm
DUAL PUMP
PODWÓJNA
POMPA
QUICK LIFT
SZYBKE
PODNOŻENIE
LOW PROFILE
NISKI
PROFIL

- EN Vehicle ramp
- PL Najazd samochodowy
- DE Auffahrrampe
- RU Мини эстакада для автомобиля
- CZ Nájezd na auto
- HU Felhajtó rámpa
- RO Rampa auto
- FR Rampe pour voiture
- IT Rampa per veicoli
- ES Rampa para coches
- CN 运送顶

1 PCS 1000 kg 815x305 x200 mm



YATO	Dimensions / Wymiary [mm]	
YT-55670	815x305x200	10

- EN Jack stand
- PL Podstawka pod samochód
- DE Unterstellbock
- RU Подставка автомобильная
- CZ Podstavec pod auto
- HU Gépkocsi alátét
- RO Set capre auto
- FR Chandelle de voiture
- IT Cavalletto auto
- ES Caballete para auto
- CN 汽车安全支架

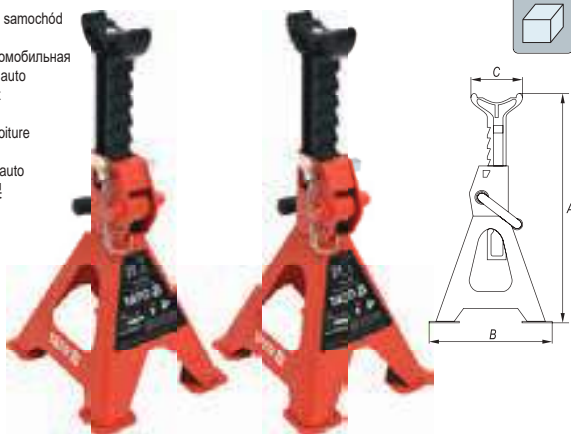

YATO	[t]	A [mm]	B [mm]	C [mm]	pcs / szt.	
YT-17310	2	265-415	190x165	77x40	2	1
YT-17311	3	280-420	182x201	85x29	2	1
YT-17312	6	382-580	258x285	100x29	2	1

- EN Porta power repair kit
- PL Rozpieraek hydrauliczny
- DE Hydraulischer Richt und Ausbeulsatz
- RU Гидравлическая распорная стойка в наборе
- CZ Hydraulický rozpěrák
- HU Hidraulikus bontó

- RO Trusa pompa hidraulica + accesorii
- FR Porta puissance hydraulique
- IT Martinetto idraulico
- ES Gato carrocerero hidráulico
- CN 分离顶

4t



Included: hydraulic cylinder 270x395 mm, expander jaws 0.5T, extensions 115, 170, 250, 470 mm
 W zestawie: siłownik 270x395 mm, szczęki rozpieraeka 0.5 t, przedłużki 115, 170, 250, 470 mm

YATO	[t]	
YT-55500	4	1

- EN Wheel chock
- PL Klin pod kola
- DE Unterlegkeil
- RU Упор противоткатный
- CZ Klin pod kola
- HU Kerékkitámasztó ék
- RO Opritor roată mașină
- FR Cale de roue
- IT Cuneo per ruote
- ES Calzo para ruedas
- CN 轮挡

220x110 x80 mm max 2500 kg PP



YATO	Dimensions / Wymiary [mm]	
YT-55675	220x110x80	48

- EN Dent removal slide hammer
- PL Młotek bezwładnościowy do usuwania wgniecień
- DE Ausbeul-Gleithammer
- RU Инерционный молоток для удаления вмятин
- CZ Setrvačné klavido pro odstraňování promáčklín
- HU Karosszéria egyengető kalapács
- RO Ciocan glisant pt. reparare indoituri caroserie
- FR Marteau à inertie pour enlever les bosses
- IT Martello inerziale per ammaccature
- ES Martillo de inercia para desabollar
- CN 钣金修复工具组套

5 PCS 75 mm 100 mm 125 mm x1 HOOK MARK



YATO	
YT-06172	1

- EN Porta power repair kit
- PL Rozpieraek hydrauliczny
- DE Hydraulischer Richt und Ausbeulsatz
- RU Гидравлическая распорная стойка в наборе
- CZ Hydraulický rozpěrák
- HU Hidraulikus bontó

- RO Trusa pompa hidraulica + accesorii
- FR Porta puissance hydraulique
- IT Martinetto idraulico
- ES Gato carrocerero hidráulico
- CN 分离顶

10t



Included: hydraulic cylinder 355x495 mm, expander jaws 0.5T, extensions 140, 240, 340, 590 mm
 W zestawie: siłownik 355x495 mm, szczęki rozpieraeka 0.5 t, przedłużki 140, 240, 340, 590 mm

YATO	[t]	
YT-55503	10	1

EN Accessories for porta power
PL Pompa do rozprężania hydraulicznego
DE Druckeinheit für hydraulischer Spreizer

RU Ручной насос для гидравлической распорной стойки
CZ Pumpa na hydraulický rozpěrák
HU Szivattyú hidraulikus bontóhoz

RO Pompa hidraulica
FR Pompe hydraulique manuelle
IT Pompa per martinetto idraulico

ES Bomba hidráulica para gato carroceros
CN 分离顶油泵



4t

For YT-55512
Dla YT-55512



10t

For YT-55513
Dla YT-55513

YATO	[t]	
YT-55510	4	1

YATO	[t]	
YT-55511	10	1

EN Accessories for porta power
PL Siłownik do rozprężania hydraulicznego
DE Kraftzylinder für hydraulischer Spreizer

RU Сервомотор для гидравлической распорной стойки
CZ Servomotor na hydraulický rozpěrák
HU Erőátvitel a hidraulikus bontóhoz

RO Accesorii pompa hidraulica
FR Presse hydraulique de la pompe
IT Cilindro per martinetto idraulico

ES Cilindro para gato carroceros
CN 千斤顶



4t

For YT-55510
Dla YT-55510



10t

For YT-55511
Dla YT-55511

YATO	[t]	
YT-55512	4	2

YATO	[t]	
YT-55513	10	2

EN Electronic battery charger
PL Prostownik elektroniczny
DE Elektronisches Ladegerät
RU Электронное зарядное устройство
CZ Elektronická nabíječka
HU Elektronikus akkumulátortöltő
RO Redresor electric
FR Chargeur de batterie voiture
IT Avviatore elettronico
ES Cargador de batería para coche
CN 蓄电池充电器



220-240V-50-60Hz	6V 12V	1 4 A
max 120 Ah	WET MOKRY GEL ZELOWY AGM	MICRO-PROCESSOR MIKRO-PROCESOR
LCD	ALTERNATOR TEST TEST ALTERNATORA	STARTER TEST TEST ROZRUSZNIKA
	x1 HOOK HAK	



YATO	
YT-83033	20

EN Electronic battery charger
PL Prostownik elektroniczny
DE Elektronisches Ladegerät
RU Электронное зарядное устройство
CZ Elektronická nabíječka
HU Elektronikus akkumulátortöltő
RO Redresor electric
FR Chargeur de batterie voiture
IT Avviatore elettronico
ES Cargador de batería para coche
CN 蓄电池充电器



220-240V-50Hz	6V 12V	2 2 A
max 200 Ah	WET MOKRY GEL ZELOWY AGM / EFB	MICRO-PROCESSOR MIKRO-PROCESOR
LCD		

YATO	
YT-83000	20

EN Electronic battery charger
PL Prostownik elektroniczny
DE Elektronisches Ladegerät
RU Электронное зарядное устройство
CZ Elektronická nabíječka
HU Elektronikus akkumulátortöltő
RO Redresor electric
FR Chargeur de batterie voiture
IT Avviatore elettronico
ES Cargador de batería para coche
CN 蓄电池充电器



220-240V-50Hz	6V 12V	2 2 A
max 200 Ah	WET MOKRY GEL ZELOWY AGM / EFB	MICRO-PROCESSOR MIKRO-PROCESOR
LCD		

YATO	
YT-83001	20

EN Electronic battery charger
PL Prostownik elektroniczny
DE Elektronisches Ladegerät
RU Электронное зарядное устройство
CZ Elektronická nabíječka
HU Elektronikus akkumulátortöltő
RO Redresor electric
FR Chargeur de batterie voiture
IT Avviatore elettronico
ES Cargador de batería para coche
CN 蓄电池充电器



220-240V-50Hz	6V 12V	2 2 A
max 200 Ah	WET MOKRY GEL ZELOWY AGM / EFB	MICRO-PROCESSOR MIKRO-PROCESOR
LCD		

YATO	
YT-83002	12

EN Electronic battery charger
PL Prostownik elektroniczny
DE Elektronisches Ladegerät
RU Электронное зарядное устройство
CZ Elektronická nabíječka
HU Elektronikus akkumulátortöltő
RO Redresor electric
FR Chargeur de batterie voiture
IT Avviatore elettronico
ES Cargador de batería para coche
CN 蓄电池充电器



220-240V-50Hz	12V	2 2 A
max 200 Ah	WET MOKRY GEL ZELOWY AGM / EFB	MICRO-PROCESSOR MIKRO-PROCESOR
LCD		

YATO	
YT-83003	8

EN Battery charger with boost function
PL Prostownik z funkcją wspomagania ładowania
DE Ladegerät mit Boost-Funktion
RU Выпрямитель с функцией поддержки зарядки
CZ Nabíječka s funkcí boost
HU Akkumulátortöltő boost funkció
RO Redresor baterie cu funcție boost
FR Chargeur de batterie voiture support boost
IT Caricabatterie con funzione boost
ES Cargador de baterías con función boost
CN 充电器启动机



220-240V-50-60Hz	12V	max 300 Ah
15A	WET MOKRY GEL ZELOWY AGM / EFB / MF	MICRO-PROCESSOR MIKRO-PROCESOR
LED DISPLAY WYSWIETLACZ		

YATO	
YT-83037	8

EN Battery charger with boost function
 PL Prostownik z funkcją wspomagania ładowania
 DE Ladegerät mit Boost-Funktion
 RU Выпрямитель с функцией поддержки зарядки
 CZ Nabíječka s funkcií boost
 HU Akkumulátortöltő boost funkció
 RO Redresor baterie cu funcție boost
 FR Chargeur de batterie voiture support boost
 IT Caricabatterie con funzione boost
 ES Cargador de baterías con función boost
 CN 充电器启动机

230V~50Hz 12V 24V 16A 120-240 Ah WET MOKRY



YATO YT-8304 2

EN Battery charger with boost function
 PL Prostownik z funkcją wspomagania ładowania
 DE Ladegerät mit Boost-Funktion
 RU Выпрямитель с функцией поддержки зарядки
 CZ Nabíječka s funkcií boost
 HU Akkumulátortöltő boost funkció
 RO Redresor baterie cu funcție boost
 FR Chargeur de batterie voiture support boost
 IT Caricabatterie con funzione boost
 ES Cargador de baterías con función boost
 CN 充电器启动机

230V~50Hz 12V 24V 25 A 170-350 Ah WET MOKRY



YATO YT-8305 2

EN Battery charger with boost function
 PL Prostownik z funkcją wspomagania ładowania
 DE Ladegerät mit Boost-Funktion
 RU Выпрямитель с функцией поддержки зарядки
 CZ Nabíječka s funkcií boost
 HU Akkumulátortöltő boost funkció

RO Redresor baterie cu funcție boost
 FR Chargeur de batterie voiture support boost
 IT Caricabatterie con funzione boost
 ES Cargador de baterías con función boost
 CN 充电器启动机

230V~50Hz 12V 24V

15A 12 V 75 A BOOST ROZRUCH

10-300 Ah WET MOKRY GEL ZELOWY AGM

MICRO-PROCESSOR MKRO-PROCESOR



YATO YT-83051 2

EN Battery charger with boost function
 PL Prostownik z funkcją wspomagania ładowania
 DE Ladegerät mit Boost-Funktion
 RU Выпрямитель с функцией поддержки зарядки
 CZ Nabíječka s funkcií boost
 HU Akkumulátortöltő boost funkció

RO Redresor baterie cu funcție boost
 FR Chargeur de batterie voiture support boost
 IT Caricabatterie con funzione boost
 ES Cargador de baterías con función boost
 CN 充电器启动机

230V~50Hz 12V 24V

30A 12 V 145 A BOOST ROZRUCH

50-600 Ah WET MOKRY GEL ZELOWY AGM

MICRO-PROCESSOR MKRO-PROCESOR



YATO YT-83052 2

EN Battery charger with engine start-up supporting function
 PL Prostownik z funkcją wspomagania rozruchu
 DE Ladegerät mit Starthilfe
 RU Выпрямитель с функцией поддержки запуска
 CZ Nabíječky s funkcií startovani motoru
 HU Akkumulátortöltő indító
 RO Robot de pornire
 FR Chargeur de batterie voiture support demarrage
 IT Caricabatterie carrellato con funzione di avviatore rapido
 ES Cargador de baterías arrancador
 CN 充电器启动机

230V~50Hz

12V 27A START ROZRUCH 300A

24V 25A START ROZRUCH 240A

20-600 Ah

WET MOKRY



YATO YT-83060 1

EN Battery charger with engine start-up supporting function
 PL Prostownik z funkcją wspomagania rozruchu
 DE Ladegerät mit Starthilfe
 RU Выпрямитель с функцией поддержки запуска
 CZ Nabíječky s funkcií startovani motoru
 HU Akkumulátortöltő indító
 RO Robot de pornire
 FR Chargeur de batterie voiture support demarrage
 IT Caricabatterie carrellato con funzione di avviatore rapido
 ES Cargador de baterías arrancador
 CN 充电器启动机

230V~50Hz

12V 32A START ROZRUCH 390A

24V 31A START ROZRUCH 360A

20-700 Ah

WET MOKRY



YATO YT-83061 1

EN Battery charger with engine start-up supporting function
 PL Prostownik z funkcją wspomagania rozruchu
 DE Ladegerät mit Starthilfe
 RU Выпрямитель с функцией поддержки запуска
 CZ Nabíječky s funkcií startovani motoru
 HU Akkumulátortöltő indító
 RO Robot de pornire
 FR Chargeur de batterie voiture support demarrage
 IT Caricabatterie carrellato con funzione di avviatore rapido
 ES Cargador de baterías arrancador
 CN 充电器启动机

230V~50Hz

12V 38A START ROZRUCH 540A

24V 35A START ROZRUCH 450A

20-800 Ah

WET MOKRY



YATO YT-83062 1

EN Jump starter with power bank
PL Urządzenie rozruchowe wielofunkcyjne
DE Multifunktions-Startgerät
RU Портативное пуско-зарядное устройство
CZ Multifunkční startovací zdroj a powerbanka
HU Többfunkciós autóindító
RO Acumulator extern pt. pomire motor si incarcare
FR Démarreur de saut de voiture multifonctionnel
IT Avviatore portatile multifunzione
ES Arrancador de batería multifuncional para coche
CN 应急电源



YATO YT-83080 20

EN Jump starter with power bank
PL Urządzenie rozruchowe wielofunkcyjne
DE Multifunktions-Startgerät
RU Портативное пуско-зарядное устройство
CZ Multifunkční startovací zdroj a powerbanka
HU Többfunkciós autóindító
RO Acumulator extern pt. pomire motor si incarcare
FR Démarreur de saut de voiture multifonctionnel
IT Avviatore portatile multifunzione
ES Arrancador de batería multifuncional para coche
CN 应急电源

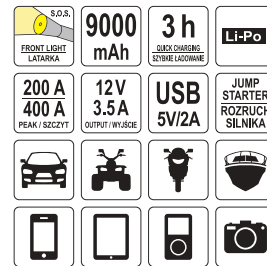

YATO YT-83081 10

EN Jump starter with power bank
PL Urządzenie rozruchowe wielofunkcyjne
DE Multifunktions-Startgerät
RU Портативное пуско-зарядное устройство
CZ Multifunkční startovací zdroj a powerbanka
HU Többfunkciós autóindító
RO Acumulator extern pt. pomire motor si incarcare
FR Démarreur de saut de voiture multifonctionnel
IT Avviatore portatile multifunzione
ES Arrancador de batería multifuncional para coche
CN 应急电源



YATO YT-83082 10

EN Jump starter with power bank
PL Urządzenie rozruchowe wielofunkcyjne
DE Multifunktions-Startgerät
RU Портативное пуско-зарядное устройство
CZ Multifunkční startovací zdroj a powerbanka
HU Többfunkciós autóindító
RO Acumulator extern pt. pomire motor si incarcare
FR Démarreur de saut de voiture multifonctionnel
IT Avviatore portatile multifunzione
ES Arrancador de batería multifuncional para coche
CN 应急电源



YATO YT-83085 10

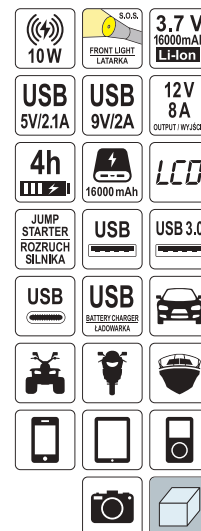

- EN Batteryless jump starter
- PL Urządzenie rozruchowe bezbaterijne
- DE Batterieleser Starthilfe
- RU Безаккумуляторное пусковое устройство
- CZ Startovací zdroj bezbateriový
- HU Elem nélküli indító berendezés
- RO Robot de pomire fără baterie
- FR Démarreur autonome sans batterie
- IT Avviatore auto senza batteria
- ES Arrancador sin batería
- CN 超级电容应急启动电源



BATTERY-LESS BEZ- BATERIJNE	6x 3000F	1500 A PEAK / SZCZYT	USB 5V 1.8A INPUT / WEJŚCIE	USB 5V/2A 9V/1.8A 12V/1.5A OUTPUT / WYJŚCIE	for/dla: 12V
2-10 min	LED DISPLAY WYŚWIETLACZ	JUMP STARTER ROZRUCH SIŁNIKA			

YATO	
YT-83070	2

- EN Power inverter
- PL Przetwornica napięcia
- DE Spannungswandler
- RU Инвертор
- CZ Měníč napětí
- HU Feszültség átalakító
- RO Invertor de tensiune
- FR Convertisseur de tension
- IT Convertitore di potenza
- ES Convertidor de voltaje
- CN 逆变器

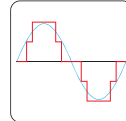

MODIFIED SINE WAVE
SINUSOIDA MÓDYFI-
KOWANA

12V	220-240V 50 Hz	THERMAL PROTECTION ZABEZPIECZENIE TERMICZNE	LOW VOLTAGE LEVEL SIGNAL SYGNAL NISZKIEGO POZIOMU NAPIĘCIA	
-----	-------------------	--	---	--



500 W	1000 W PEAK / SZCZYT
----------	----------------------------

YATO	
YT-81490	12



800 W	1600 W PEAK / SZCZYT
----------	----------------------------

YATO	
YT-81491	12

- EN Jumpstart wires
- PL Przewody rozruchowe
- DE Starterkabel
- RU Пусковые провода
- CZ Startovací kabely
- HU Indító kábelek
- RO Cabluri pomire auto
- FR Câbles de démarrage
- IT Cavi carica batteria
- ES Cables de arranque
- CN 输出线

2.5m	
------	--



YATO	[A]	
YT-83151	200	10

YATO	[A]	
YT-83152	400	10

YATO	[A]	
YT-83153	600	10

- EN Analogue battery tester
- PL Tester akumulatorów analogowy
- DE Analoges Batterieprüfgerät
- RU Аналоговый тестер аккумуляторов
- CZ Analogový tester akumulátorů
- HU Analóg akkuteszter
- RO Tester acumulatori analog
- FR Testeur de charge batterie
- IT Tester analogico per batteria
- ES Tester analógico para acumuladores
- CN 电池测试器

6V	12V	CCA 200- 1000 A
----	-----	-----------------------



YATO	
YT-8310	10

- EN Digital battery tester
- PL Tester akumulatorów cyfrowy
- DE Digitales Batterieprüfgerät
- RU Цифровой тестер аккумуляторов
- CZ Digitální tester autobaterií
- HU Digitális akkuteszter
- RO Tester acumulatori digital
- FR Testeur de batterie digital
- IT Tester digitale per batteria
- ES Comprobador de baterías digital
- CN 电池测试器

12V	CCA 150- 1400 A	LED DISPLAY WYŚWIETLACZ
-----	-----------------------	-------------------------------



YATO	
YT-8311	10

- EN Battery tester
- PL Tester akumulatorów
- DE Batterieprüfgerät
- RU Тестер аккумуляторов
- CZ Tester akumulátorů
- HU Akkuteszter
- RO Tester acumulatori
- FR Testeur de batterie
- IT Tester per batteria
- ES Tester para acumuladores
- CN 电池测试器

12V	BATTERY TEST TEST AKUL- MULATORA	ALTERNATOR TEST TEST ALTERNATORA
-----	---	---



YATO	
YT-83101	12/72

EN Digital battery tester
PL Elektroniczny tester akumulatorów
DE Elektronischer Batterietester
RU Электронный тестер аккумуляторов
CZ Digitální tester autobaterií
HU Elektronikus akkumulátor teszter
RO Tester electronic acumulatori
FR Testeur de batterie électronique
IT Tester elettronico per batterie
ES Comprobador electrónico de baterías
CN 电池检测仪



YATO YT-83113 6/48

EN Digital battery tester
PL Elektroniczny tester akumulatorów
DE Elektronischer Batterietester
RU Электронный тестер аккумуляторов
CZ Digitální tester autobaterií
HU Elektronikus akkumulátor teszter
RO Tester electronic acumulatori
FR Testeur de batterie électronique
IT Tester elettronico per batterie
ES Comprobador electrónico de baterías
CN 电池检测仪



YATO YT-83114 56

EN OBD2 multilingual scan tool
PL Tester diagnostyczny OBD2
DE OBD2-Diagnosegerät
RU Диагностический тестер OBD2
CZ Diagnostický tester OBD2
HU OBD2 hibakód olvasó teszter
RO Tester diagnoza auto OBD2
FR Appareil de diagnostic OBD2
IT Strumento diagnostico OBD2
ES Comprobador de diagnóstico OBD2
CN 多语言汽车读码卡



YATO YT-72977 10/60

EN OBD2 multilingual scan tool
PL Tester diagnostyczny OBD2
DE OBD2-Diagnosegerät
RU Диагностический тестер OBD2
CZ Diagnostický tester OBD2
HU OBD2 hibakód olvasó teszter
RO Tester diagnoza auto OBD2
FR Appareil de diagnostic OBD2
IT Strumento diagnostico OBD2
ES Comprobador de diagnóstico OBD2
CN 多语言汽车读码卡



YATO YT-72978 40

EN Injector tester scan tool
PL Elektroniczny tester wtryskiwaczy silników benzynowych
DE Elektronisches Benzin-Einspritzdüsen-Prüfgerät
RU Электронный тестер для инжекторов бензинового двигателя
CZ Elektronický tester trysek benzinového motoru
HU Elektromos teszter benzinmotor befecskendezőhöz
RO Tester injectoare pt. motoare benzină
FR Testeur électronique d'injecteurs de moteurs à essence
IT Tester elettronico per iniettori per motori a benzina
ES Probador electrónico para inyectoros de motores de gasolina
CN 汽车喷油器测试仪



YATO YT-72960 8/48

EN Refractometer
PL Refraktometr
DE Refraktometer
RU Рефрактометр
CZ Refraktometr
HU Fagyálló fokoló
RO Refractometrul
FR Réfractomètre
IT Rifrattometro
ES Refractometro
CN 冰点仪



YATO YT-06722 25

EN Auto retract electric cable reel
 PL Przedłużacz elektryczny na zwijaku automatycznym
 DE Elektro-Kabelaufroller mit automatischem Einzug
 RU Электрический удлинитель на автоматическом барабане
 CZ Elektrický prodlužovací kabel na automatickém navijáku
 HU Elektromos hosszabbító automatikus csévélével
 RO Prelungitor electric retractabil
 FR Câble de rallonge électrique sur enrouleur automatique
 IT Prolunga elettrica con avvolgicavo automatico
 ES Prolongador eléctrico en enrollador automático
 CN 电卷管器



10 A ~250 V	CABLE H05VV-F KABEL	3G 1.5 mm ²	
	IP34		EASILY MOUNT ŁATWY MONTAŻ
x4 ANCHORS KOTWY			

P_{max} = 2500 W coiled
 P_{max} = 2500 W uncoiled
 P_{max} = 2500 W zwinięty
 P_{max} = 2500 W rozwinięty

YATO	L [m]	
YT-81220	10	4
YT-81221	20	2

EN Chain block
 PL Wyciągarka łańcuchowa
 DE Kettenzug Flaschenzug
 RU Таль цепная
 CZ Zvedák řetězový
 HU Láncos csigasor emelő
 RO Scripete cu lant
 FR Treuil à chaîne
 IT Paranco a catena
 ES Cabría de cadena
 CN 三角手拉葫芦



3m

EN Lever block
 PL Wciągnik łańcuchowy
 DE Kettenzug Hebelzug
 RU Таль ручная рычажная
 CZ Kladkostroj díl
 HU Emelő robusztus
 RO Scripete cu pârghie
 FR Bloc de levier
 IT Paranco a catena
 ES Bloqe de palanca
 CN 手扳葫芦



1.5 m

YATO	Max. load capacity / Maks. obciążenie [kg]	
YT-58950	500	1
YT-58951	1000	1
YT-58953	2000	1
YT-58954	3000	1
YT-58955	5000	1

YATO	Max. lifting capacity / Maks. udźwig [kg]	
YT-58962	750	1
YT-58964	1500	1
YT-58966	3000	1
YT-58967	6000	1

EN Rope winch
 PL Wyciągarka linowa
 DE Handseilwinde
 RU Канатная лебедка
 CZ Lanové vyťahovací zařízení
 HU Drótkételes csőrőlő
 RO Troliu cu cablu orizontal
 FR Treuil à corde
 IT Paranco a corda
 ES Cabría de cuerdas
 CN 绳索拉紧器



1000 daN
 3m
 5.0 mm

YATO	Rope length / Długość liny [m]	Rope diameter / Średnica liny [mm]	
YT-5911	3	5	6

EN Rope winch
 PL Wyciągarka linowa
 DE Handseilwinde
 RU Канатная лебедка
 CZ Lanové vyťahovací zařízení
 HU Drótkételes csőrőlő
 RO Troliu cu cablu orizontal
 FR Treuil à corde
 IT Paranco a corda
 ES Cabría de cuerdas
 CN 绳索拉紧器



1300 daN
 3m
 5.0 mm

YATO	Rope length / Długość liny [m]	Rope diameter / Średnica liny [mm]	
YT-5913	3	5	6

EN Rope winch
 PL Wyciągarka linowa
 DE Handseilwinde
 RU Канатная лебедка
 CZ Lanové vyťahovací zařízení
 HU Drótkételes csőrőlő
 RO Troliu cu cablu orizontal
 FR Treuil à corde
 IT Paranco a corda
 ES Cabría de cuerdas
 CN 绳索拉紧器



1500 daN
 3m
 6.0 mm

YATO	Rope length / Długość liny [m]	Rope diameter / Średnica liny [mm]	
YT-5914	3	6	3

EN Transmission jack
PL Podnośnik skrzyni biegów
DE Hydraulische Getriebeheber
RU Домкрат для коробки передач
CZ Pojízdný zvedák motorů a převodovek
HU Sebességváltó emelő tartó
RO Cric cutii de viteza
FR Levage des moteurs et des boîtes de vitesses
IT Sollevatore scatola del cambio
ES Motor de transmisión telescópica
CN 坡道



max 500 kg
1900 mm
PRECISION VALVE
PRECYZYJNY ZAWÓR

EN Transmission jack
PL Podnośnik skrzyni biegów
DE Hydraulische Getriebeheber
RU Домкрат для коробки передач
CZ Pojízdný zvedák motorů a převodovek
HU Sebességváltó emelő tartó
RO Cric cutii de viteza
FR Levage des moteurs et des boîtes de vitesses
IT Sollevatore scatola del cambio
ES Motor de transmisión telescópica
CN 运送顶



max 500 kg
1945 mm
PRECISION VALVE
PRECYZYJNY ZAWÓR

YATO
YT-55601



1

YATO
YT-55600



1

EN Parts washer
PL Myjka warsztatowa
DE Teilwaschgerät
RU Стенд для очистки деталей
CZ Mycí stůl na součástky
HU Alkatrészmosó
RO Cuva pt. palat piese
FR Fontaine de nettoyage pièces
IT Idropulitrice per officina
ES Lavadora piezas mecánicas
CN 零件清洗机



230V~50Hz
720x480x260 mm
880 mm
80 L
10 l/min
FOR SOLVENT WATER BASED DO PŁYNÓW NA BAZIE WODY



YATO
YT-55808



1

EN Ultrasonic parts cleaner
PL Myjka warsztatowa ultradźwiękowa
DE Ultraschall-Teilereiniger
RU Ультразвуковая мойка
CZ Ultrazvuková čistička dílů
HU Ultrahangos tisztítóberendezés
RO Dispozitiv pt. curățat piese cu ultrasunete
FR Nettoyeur de pièces à ultrasons
IT Pulitore ad ultrasuoni per officine
ES Máquina de limpieza ultrasónicas para taller
CN 超声波清洗机

220-240V~50/60Hz
480W
480W
22 L
500x300x150 mm
530x325x285 mm
40 kHz
0-30 min
0-80 °C
304SUS



YATO
YT-55801

[W]
480



1

EN Ultrasonic parts cleaner
PL Myjka warsztatowa ultradźwiękowa
DE Ultraschall-Teilereiniger
RU Ультразвуковая мойка
CZ Ultrazvuková čistička dílů
HU Ultrahangos tisztítóberendezés
RO Dispozitiv pt. curățat piese cu ultrasunete
FR Nettoyeur de pièces à ultrasons
IT Pulitore ad ultrasuoni per officine
ES Máquina de limpieza ultrasónicas para taller
CN 超声波清洗机

220-240V~50/60Hz
600W
500W
30 L
530x325x325 mm
40 kHz
0-30 min
0-80 °C
304SUS



YATO
YT-55803

[W]
600



1

EN Sandblasting cabinet
 PL Piaskarka kabinowa
 DE Sandstrahlkabine
 RU Пескоструйная камера
 CZ Pískovací box
 HU Homokszóró kabin
 RO Cabină de sablat
 FR Cabine de sablage
 IT Sabbiatrice a cabina
 ES Cabina de chorro de arena
 CN 喷砂机

230V~50Hz 0.82 MPa 90 L 585x490 x490 mm STANDARD



$L_{pA} = 63,5 \pm 3,0$ dB; $L_{wA} = 65,0 \pm 3,0$ dB; $a_h = <2,5$ m/s²

YATO	
YT-55840	1

EN Sandblasting cabinet
 PL Piaskarka kabinowa
 DE Sandstrahlkabine
 RU Пескоструйная камера
 CZ Pískovací box
 HU Homokszóró kabin
 RO Cabină de sablat
 FR Cabine de sablage
 IT Sabbiatrice a cabina
 ES Cabina de chorro de arena
 CN 喷砂机

230V~50Hz 0.82 MPa 220 L 1380x940 x570 mm STANDARD



$L_{pA} = 63,5 \pm 3,0$ dB; $L_{wA} = 65,0 \pm 3,0$ dB; $a_h = <2,5$ m/s²

YATO	
YT-55841	1

EN Nozzle for sandblaster cabinet
 PL Dysze ceramiczne do piaskarki kabinowej
 DE Keramikdüsen für Sandstrahlkabine
 RU Керамические насадки для пескоструйной камеры
 CZ Keramické trysky pro kabinový pískovací stroj
 HU Kerámia fúvókák homokszóró kabinhoz

RO Duze pt. aparat de sablat
 FR Buses en céramique pour cabine de sablage
 IT Ugelli ceramici per sabbiatrice a cabina
 ES Boquillas cerámicas para cabinas de chorro de arena
 CN 四件套喷嘴

4 PCS
4, 5, 6, 7 mm



For YT-55840
 Dla YT-55840

YATO	Ø [mm]	
YT-55844	4, 5, 6, 7	20/200

EN Protective films for sandblasting cabinet
 PL Folie ochronne do piaskarki kabinowej
 DE Schutzfolien für Sandstrahlkabine
 RU Защитные пленки для пескоструйной камеры
 CZ Ochranná fólie průzoru pro pískovací box
 HU Védőfóliák a homokozóhoz

RO Folie protecție pt. cabina de sablat
 FR Film de protection pour cabine de sablage
 IT Pellicola protettiva per cabina sabbiatrice
 ES Películas de protección para cabinas de chorro de arena
 CN 四片装保护片

4 PCS



410x300 mm For YT-55840
 Dla YT-55840

YATO	[mm]	
YT-55845	410x300	50/100

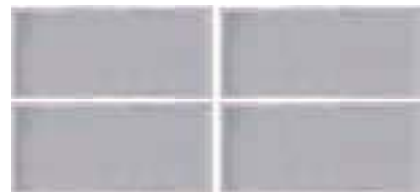

548x250 mm For YT-55841
 Dla YT-55841

YATO	[mm]	
YT-55849	548x250	100

EN Gloves for sandblasting cabinet
 PL Rękawice do piaskarki kabinowej
 DE Handschuhe für Sandstrahlkabine
 RU Перчатки для пескоструйной камеры
 CZ Rukavice do pískovacích boxů
 HU Homokfúvó szekrényhez kesztyű

RO Manusi pt. cabina de sablat
 FR Gants pour cabine de sablage
 IT Guanti per cabina sabbiatrice
 ES Guantes para cabinas de chorro de arena
 CN 手套

1



For YT-55840
 Dla YT-55840

YATO	
YT-55846	25



For YT-55841
 Dla YT-55841

YATO	
YT-55847	25

EN Shop crane
PL Żuraw warsztatowy
DE Werkstattkran
RU Кран подкатной гидравлический
CZ Hydraulický jeřáb
HU Motorkiemelő zsiráf

RO Macara tip girafă pt. atelier
FR Grue d'atelier
IT Gru idraulica
ES Grúa hidráulica para motores
CN 吊机



1000
kg



EN Shop crane
PL Żuraw warsztatowy
DE Werkstattkran
RU Кран подкатной гидравлический
CZ Hydraulický jeřáb
HU Motorkiemelő zsiráf

RO Macara tip girafă pt. atelier
FR Grue d'atelier
IT Gru idraulica
ES Grúa hidráulica para motores
CN 吊机



2000
kg



↑
204cm
max



↑
224cm
max

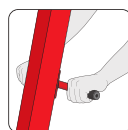
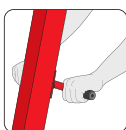

YATO
YT-55556



1

YATO
YT-55557



1

EN Hydraulic shop press
PL Prasa hydrauliczna
DE Hydraulische Werkstattpresse
RU Гидравлический пресс
CZ Hydraulický lis
HU Hidraulikus prés

RO Presă hidraulică
FR Presse hydraulique
IT Pressa idraulica
ES Prensa hidráulica
CN 压力机

12t

695
0
mm

400
mm



YATO
YT-55580



1

EN Hydraulic shop press
PL Prasa hydrauliczna
DE Hydraulische Werkstattpresse
RU Гидравлический пресс
CZ Hydraulický lis
HU Hidraulikus prés

RO Presă hidraulică
FR Presse hydraulique
IT Pressa idraulica
ES Prensa hidráulica
CN 压力机

20t

695
0
mm

490
mm



YATO
YT-55581



1

EN Hydraulic shop press
PL Prasa hydrauliczna
DE Hydraulische Werkstattpresse
RU Гидравлический пресс
CZ Hydraulický lis
HU Hidraulikus prés

RO Presă hidraulică
FR Presse hydraulique
IT Pressa idraulica
ES Prensa hidráulica
CN 压力机

30t

795
0
mm

520
mm



YATO
YT-55582



1

- EN Engine bar with support arm
- PL Belka z poprzeczką do podwieszania silnika
- DE Motorbrücke mit Tragarm
- RU Балка с перекладной для подвески двигателя
- CZ Nosník s příčkou pro zavěšení motoru
- HU Motorfűggesztő gerenda
- RO Suport ridicare motor
- FR Poutre de support moteur avec barre transversale
- IT Ponte per motori con traversa
- ES Barra de soporte del motor con travesa
- CN 引擎支架

90-160 cm max 320 kg 



YATO  1
YT-55567

- EN Engine suspension beam
- PL Belka do podwieszania silnika
- DE Aufnahmevorrichtung des Motors
- RU Балка для вывешивания двигателя
- CZ Nosník k zavěšení motoru
- HU Motorfűggesztő gerenda
- RO Suport ridicare motor
- FR Poutre de suspension de moteur
- IT Fascio sospensione del motore
- ES La viga para suspender el motor
- CN 引擎支架

max 500 kg 150 cm 

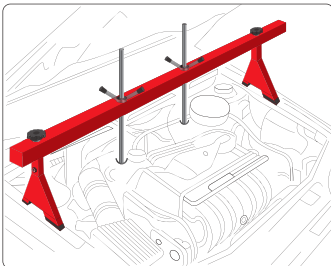
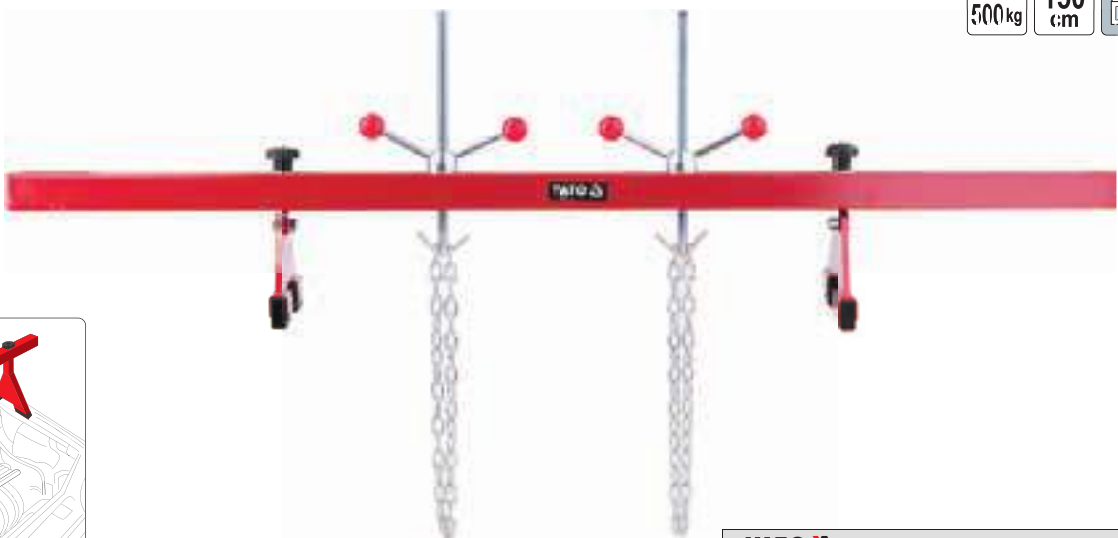

YATO  1
YT-55568

- EN Crane crossbeam
- PL Traversa do żurawia
- DE Traverse zum Kran
- RU Траверса для крана
- CZ Jířňáková traverza
- HU Traverz a zsíráf emelőhöz
- RO Suport ridicare motor
- FR Balancier pour grue d'atelier
- IT Traverse per gru
- ES Viga transversal para grua
- CN 平衡器



315 mm max 680 kg 



YATO  1
YT-55565

- EN Engine stand
- PL Stojak do silnika
- DE Motorständer
- RU Стойка для ремонта двигателя
- CZ Stojan na motor
- HU Motorszerelő állvány
- RO Suport pt. motor
- FR Support moteur
- IT Cavalletto per motore
- ES Soporte de motor
- CN 发动机支架

max 450 kg 0-360° 
4x  STEEL



YATO  1
YT-55570

EN Self locking nuts assortment
PL Zestaw nakrętek metrycznych z zabezpieczeniem
DE Sortiment Muttern metrisch mit Sicherheit
RU Набор гаек самоконтращихся, с нейлоновой вставкой
CZ Šestihránné matice s bezpečností
HU Nuts metrikus menet biztonsági

RO Set piulite autoblocante
FR Hex écrou set avec la sécurité
IT Set di autobloccanti metrica dadi
ES Porcas rosca métrica con a seguridad
CN 螺母组套

146
PCS

MIX

METRIC
METRYCZNY

INTERNAL
SECURITY
WNIEMETRYCZNE
ZABEZPIECZENIE



M4, M5, M6, M8, M10, M12

YATO
YT-06774

5/20

EN Stainless steel nuts assortment
PL Zestaw nakrętek metrycznych nierdzewnych
DE Sortiment Muttern metrisch rostfrei
RU Набор гаек шестигранных нержавеющей
CZ Nerezové oceli šestihránné matice
HU Nuts metrikus menet rozsdamentes

RO Set piulite inox
FR Hex écrou set inoxydable
IT Set di acciaio inossidabile metrica dadi
ES Rosca métrica tuerca inoxidable
CN 螺母

300
PCS

MIX

METRIC
METRYCZNY

SS
STAINLESS STEEL
STAL NERZDZEWNA



M3, M4, M5, M6, M8, M10

YATO
YT-06773

5/20

EN Metric wing nut assortment
PL Zestaw nakrętek motylkowych
DE Sortiment Flügelmuttern
RU Набор гаек типа «барашек»
CZ Křídlaté matice lisované
HU Szárnyas anya

RO Set piulite fluture
FR Assortiment d'écrous papillon
IT Set di metrica dadi
ES Tuercas con orejas
CN 蝶形螺母组套

150
PCS

MIX

METRIC
METRYCZNY



M4, M5, M6, M8, M10

YATO
YT-06776

5/20

EN Metric nuts assortment
PL Zestaw nakrętek metrycznych
DE Sortiment Muttern metrisch
RU Набор гаек
CZ Šestihránné matice
HU Nuts metrikus menet

RO Set piulite
FR Hex écrou set
IT Set di metrica dadi
ES Porcas rosca métrica
CN 螺母组套

300
PCS

MIX

METRIC
METRYCZNY

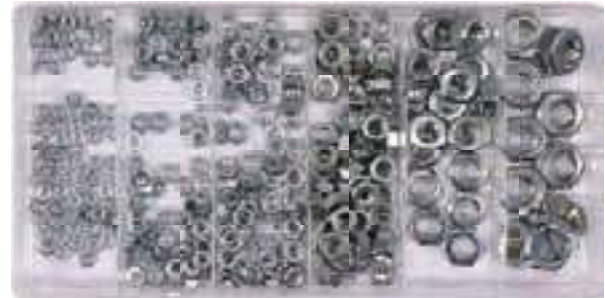

M3, M4, M5, M6, M8, M10

YATO
YT-06772

5/20

EN Hex nut with top assortment
PL Zestaw nakrętek metrycznych kołpakowych
DE Sortiment Muttern metrisch geschlossen
RU Набор гаек копкачковых
HU Nuts metrikus menet zárt

RO Set piulite inchise
FR Hex écrou set fermé
IT Set di dadi campana-metrica
ES Rosca métrica tuercas cerrado
CN 螺母

150
PCS

MIX

METRIC
METRYCZNY



M3, M4, M5, M6, M8, M10

YATO
YT-06775

5/20

EN Aluminium washer set
PL Zestaw podkładek aluminiowych
DE Aluminium Dichting Sortiment
RU Набор алюминиевых шайб
HU Réz alátét készlet

RO Set saibe aluminiu
FR Assortiment de joints en aluminium
IT Set di rondelle in alluminio
ES Juego de cuñas de aluminio
CN 铝垫片

300
PCS

MIX

METRIC
METRYCZNY

AI



5x9x1.0 mm, 8x14x1.5 mm, 12x16x1.0 mm, 14x20x1.5 mm, 18x24x1.5 mm, 22x29x1.5 mm, 6x10x1.0 mm, 9x14x1.0 mm, 12x16x1.5 mm, 14x20x2.0 mm, 20x24.5x1.5 mm, 24x29x1.5 mm, 6x12x1.0 mm, 10x14x1.0 mm, 12x18x1.5 mm, 16x20x1.5 mm, 20x24.5x0.8 mm, 24x32x2.0 mm, 8x12x1.0 mm, 10x14x1.5 mm, 13x18x1.0 mm, 16x22x1.5 mm, 19x26x2.0 mm, 26x34x2.0 mm, 8x14x1.0 mm, 10x16x1.0 mm, 14x18x1.5 mm, 18x22x1.5 mm, 22x27x1.0 mm, 28x36x2.0 mm (x10 PCS)

YATO
YT-06865

5/20

EN Aluminium washer set
 PL Zestaw podkładek aluminiowych
 DE Aluminium Dichttring Sortiment
 RU Набор алюминиевых шайб
 CZ Sada hliníkových podložek
 HU Réz alátét készlet
 RO Set saibe aluminiu
 FR Assortiment de joints en aluminium
 IT Set di rondelle in alluminio
 ES Juego de cuñas de aluminio
 CN 铝垫片

450 PCS **MIX** METRIC METRYCZNY **AI**



10x6x1.0 mm (40 PCS), 12x6x1.2 mm (40 PCS), 12x8x1.0 mm (40 PCS), 14x8x1.0 mm (40 PCS), 14x10x1.0 mm (40 PCS), 16x10x1.0 mm (40 PCS), 16x12x1.5 mm (20 PCS), 18x12x1.5 mm (20 PCS), 18x14x1.5 mm (20 PCS), 20x14x1.5 mm (20 PCS), 20x16x1.5 mm (20 PCS), 22x16x1.5 mm (20 PCS), 22x18x1.5 mm (20 PCS), 24x18x1.5 mm (20 PCS), 26x20x1.5 mm (20 PCS), 27x22x1.5 mm (10 PCS), 29x22x1.5 mm (10 PCS), 29x24x2.0 mm (10 PCS)

YATO YT-068652 24

EN Drain plug gasket assortment
 PL Zestaw podkładek do korków spustowych
 DE Unterlegscheiben-Set für Ablassschrauben
 RU Комплект шайб для сливных пробок
 CZ Sada podložek pro vypouštěcí zátky
 HU Leeresztőcsavar alátétkészlet

RO Set garnituri pt. bușon baie ulei
 FR Rondelles de bouchon de vidange
 IT Kit di rondelle per tappi di scarico
 ES Juego de arandelas para tapones de descarga
 CN 油底垫圈

120 PCS **MIX** NYLON FIBER WŁÓKNO STEEL STAL **AI** **Cu** **NBR**



12x24.7x2 mm, 13.6x24.7x2 mm; Steel+NBR; 13x19x2.3 mm, 16x26x2.3 mm, 18x22x2.3 mm, 19x27x2.3 mm, 24x29x2.3 mm, 14.5x24x2 mm, 13x24x1.5 mm, 12x22x1.5 mm, 14x19.5x1.5 mm; Nylon; 12x22x1.5 mm, 18x28x2 mm, 20x27x1.5 mm, 13x22x2 mm, 14x20x1.5 mm; Fibre / Włókno; 13x18x1.2 mm, 16x22x1.5 mm, 20x26x2.5 mm, 14x20x1.3 mm; Cu; 14x24x2 mm; Al; 12x18x2 mm; Cu crush / Cu dmuchana; 12x20x2mm, 14x21x2.5mm; NBR; (x5 PCS)

YATO YT-068641 12

EN Copper washer set
 PL Zestaw podkładek miedzianych
 DE Kupfer Dichttring Sortiment
 RU Набор медных колец
 CZ Podložky měděné těsnící
 HU Réz tömítés készlet

RO Saibe din cupru
 FR Patins en cuivre
 IT Set di spessori
 ES Arandelas de cobre
 CN 紫铜垫片

220 PCS **MIX** SOFT MATERIAL MIEKKI MATERIAL **Cu**



4x8x1 mm, 5x9x1 mm, 6x10x1 mm, 6x12x1 mm (x25 PCS); 8x12x1 mm, 8x14x1 mm, 10x14x1 mm, 10x16x1 mm, 12x16x1.5 mm, 12x18x1.5 mm, 14x18x1.5 mm, 14x20x1.5 mm, 16x20x1.5 mm, 18x24x1.5 mm, 20x26x1.5 mm, 22x27x1.5 mm (x10 PCS)

YATO YT-068721 24

EN Copper crush washer set
 PL Zestaw podkładek miedzianych dmuchanych
 DE Satz geblasener Kupfer-Passplatten
 RU Комплект медных шайб
 CZ Sada foukaných měděných podložek
 HU Réz alátét készlet

RO Set saibe cupru
 FR Jeu de rondelles en cuivre
 IT Set di rondelle di rame soffiante
 ES Conjunto de arandelas de cobre para tapón cárter
 CN 铜环圈

95 PCS **MIX** **Cu**



8.4x12x1.8 mm (10 PCS), 10.4x15.8x2.0 mm (15 PCS), 12.4x17.8x2.2 mm (15 PCS), 14.4x19.8x2.2 mm (20 PCS), 16.4x21.8x2.0 mm (20 PCS), 18.2x23.8x2.2 mm (10 PCS), 20.2x25.8x2.2 mm (5 PCS)

YATO YT-068713 24

EN Copper washer set
 PL Zestaw podkładek miedzianych
 DE Kupfer Dichttring Sortiment
 RU Набор медных колец
 CZ Podložky měděné těsnící
 HU Réz tömítés készlet

RO Saibe din cupru
 FR Patins en cuivre
 IT Set di spessori
 ES Arandelas de cobre
 CN 紫铜垫片

150 PCS **MIX** **Cu**



5x10x1.0 mm, 6x10x1.0 mm, 7x10x1.0 mm, 8x11x1.0 mm, 10x16x1.0 mm, 10.5x17x1.5 mm, 11x17x1.5 mm, 14x18x1.0 mm, 12x20x1.5 mm, 12.5x20x1.5 mm, 14x20x1.5 mm, 15x20x2.0 mm, 16x22x2.0 mm, 16.5x24x2.0 mm, 17.5x24x2.0 mm (x10 PCS)

YATO YT-06871 5/20

EN Copper washer set
 PL Zestaw podkładek miedzianych
 DE Kupfer Dichttring Sortiment
 RU Набор медных колец
 CZ Podložky měděné těsnící
 HU Réz tömítés készlet

RO Saibe din cupru
 FR Patins en cuivre
 IT Set di spessori
 ES Arandelas de cobre
 CN 紫铜垫片

300 PCS **MIX** METRIC METRYCZNY **Cu** SOFT MATERIAL MIEKKI MATERIAL

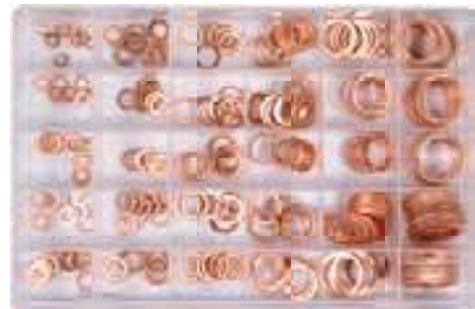

5x9x1.0 mm, 8x14x1.5 mm, 12x16x1.0 mm, 14x20x1.5 mm, 18x24x1.5 mm, 22x29x1.5 mm, 6x10x1.0 mm, 9x14x1.0 mm, 12x16x1.5 mm, 14x20x2.0 mm, 20x24.5x1.5 mm, 24x29x1.5 mm, 6x12x1.0 mm, 10x14x1.0 mm, 12x18x1.5 mm, 16x20x1.5 mm, 20x24.5x0.8 mm, 24x32x2.0 mm, 8x12x1.0 mm, 10x14x1.5 mm, 13x18x1.0 mm, 16x22x1.5 mm, 19x26x2.0 mm, 26x34x2.0 mm, 8x14x1.0 mm, 10x16x1.0 mm, 14x18x1.5 mm, 18x22x1.5 mm, 22x27x1.0 mm, 28x36x2.0 mm (x10 PCS)

YATO YT-06872 5/20

EN Copper washer set
PL Zestaw podkładek miedzianych
DE Kupfer Dichting Sortiment
RU Набор медных колец
CZ Podložky měděné těsnící
HU Réz tömítés készlet

RO Saibe din cupru
FR Patins en cuivre
IT Set di spessori
ES Arandelas de cobre
CN 紫铜垫片

580
PCS
MIX
Cu



4x8x1 mm, 4x9x1 mm, 7x10x1 mm, 8x12x1 mm, 6x12x1 mm, 8x14x1 mm, 10x16x1 mm, 11x17x1 mm, 10.5x17x1 mm, 12x16x1 mm (x30 PCS); 8x16x1 mm, 13x18x1 mm, 14x18x1 mm, 12x19x1 mm, 14x20x1 mm, 16x20x1 mm (x20 PCS); 17x21x1 mm, 17x23x1 mm, 18x22x1 mm, 18x24x1 mm (x15 PCS); 19x26x1 mm, 22x26x1 mm, 24x29x1 mm, 20x28x1 mm, 22x29x1 mm, 26x31x1 mm, 24x32x1 mm, 27x32x1 mm, 26x34x1 mm, 30x36x1 mm (x10 PCS)

YATO
YT-068711 20

EN Aluminum gasket and oil drain plug assortment
PL Zestaw podkładek aluminiowych i korków spustowych
DE Alu-Unterlegscheiben- und Ölablassschrauben-Satz
RU Набор алюминиевых подкладок и пробок
CZ Sada hliníkových podložek a vypouštěčích zátek
HU Alumínium alátét és leeresztőcsavar készlet
RO Set garnituri al. si busoane baie ulei
FR Jeu de rondelles et de bouchons de vidange en aluminium
IT Kit di rondelle in alluminio e tappi di scarico
ES Juego de arandelas de aluminio y tapones de descarga
CN 油封

534
PCS
MIX
Al



6 mm (50 PCS), 8 mm (50 PCS), 10 mm (50 PCS), 12 mm (50 PCS), 13 mm (50 PCS), 14 mm (50 PCS), 15 mm (50 PCS), 16 mm (50 PCS), 18 mm (50 PCS), 20 mm (50 PCS); M10 (5 PCS), M12 (5 PCS), M13 (5 PCS), M14 (5 PCS), M15 (5 PCS), M16 (3 PCS), M18 (3 PCS), M20 (3 PCS)

YATO
YT-06862 12

EN Oil seal washer assortment
PL Zestaw podkładek metalowo-gumowych
DE Satz Metall- und Gummischieben
RU Набор металлопорезиновых шайб
CZ Sada podložek kov-guma
HU Fém-gumi alátétkészlet

RO Set șaibe simeringuri
FR Jeu de rondelles en métal et en caoutchouc
IT Kit di rondelle in metallo e gomma
ES Juego de arandelas metal goma
CN 橡胶复合垫片

150
PCS
MIX
NBR70



M6x1.0 mm (10 PCS), M8x1.9 mm (10 PCS), M10x1.9 mm (10 PCS), M12x1.9 mm (20 PCS), M14x1.9 mm (20 PCS), M16x1.9 mm (20 PCS), M18x1.9 mm (20 PCS), M20x1.9 mm (20 PCS), M22x1.9 mm (10 PCS), M24x1.9 mm (10 PCS)

YATO
YT-068582 24

EN Copper gasket & oil drain plug assortment
PL Zestaw podkładek miedzianych i korków spustowych
DE Ölablassschraube Kupfer Schrauben und O-Ringe
RU Набор медных шайб и сливных пробок поддона двигателя
CZ Sada měděných podložek a zátek pro olejové výpustě
HU Olajteknő csavar és rézalátét készlet
RO Set busoane baie ulei
FR Boulons de carter d'huile & assortiment bagues
IT Set di rondelle in rame a spine
ES Tornillos y juntas para tapon de carter
CN 油封

534
PCS
MIX
Cu



6 mm (50 PCS), 8 mm (50 PCS), 10 mm (50 PCS), 12 mm (50 PCS), 13 mm (50 PCS), 14 mm (50 PCS), 15 mm (50 PCS), 16 mm (50 PCS), 18 mm (50 PCS), 20 mm (50 PCS); M8x1.0 (5 PCS), M10x1.0 (5 PCS), M12x1.5 (5 PCS), M14x1.5 (5 PCS), M16x1.5 (3 PCS), M18x1.5 (3 PCS), M20x1.5 (3 PCS); G1/4 (5 PCS)

YATO
YT-06864 10

EN Oil seal washer assortment
PL Zestaw podkładek metalowo-gumowych
DE Satz Metall- und Gummischieben
RU Набор металлопорезиновых шайб
CZ Sada podložek kov-guma
HU Fém-gumi alátétkészlet

RO Set șaibe simeringuri
FR Jeu de rondelles en métal et en caoutchouc
IT Kit di rondelle in metallo e gomma
ES Juego de arandelas metal goma
CN 橡胶复合垫片

90
PCS
MIX
NBR70



M10x1.9 mm (20 PCS), M12x1.9 mm (20 PCS), M14x1.9 mm (20 PCS), M16x1.9 mm (10 PCS), M18x1.9 mm (5 PCS), M20x1.9 mm (5 PCS), M22x1.9 mm (5 PCS), M24x1.9 mm (5 PCS)

YATO
YT-068581 24

EN Bodywork nuts & screws assortment
PL Zestaw wkrętów i podkładek do karoserii
DE Sortiment Karosseriemuttern mit Schrauben
RU Набор саморезов и металлических клипс для кузовных работ
CZ Tělo matice a šroub kit
HU Karosszéria csavar és anya készlet

RO Set cleme și holșuruburi
FR Assortiment de vis et d'écrous cage
IT Set viti e rondelle al corpo
ES Body kit tornillo
CN 螺丝组套

170
PCS
MIX



M3, M4, M5, M6;
M3x8 mm, M4x16 mm, M5x12 mm, M6x20 mm

YATO
YT-06780 5/20

EN Clevis pin assortment
 PL Zestaw sworzni z iber i otworem
 DE Bolzen mit Kopf
 RU Набор штифтов с отверстиями под шплинт
 CZ Čepy s hlavou
 HU Csapszeget kit

RO Set bolturi pt. securizare
 FR Axe de chape
 IT Set di perni con testa e il foro
 ES Kit de pasador de horquilla
 CN 销柱

60
PCS

5-12
mm

MIX



 5x25 mm, 6x25 mm, 6x30 mm, 6x40 mm, 6x45 mm, 6x50 mm, 6x60 mm, 6x65 mm, 8x25 mm, 8x30 mm, 8x40 mm, 8x45 mm, 8x50 mm, 8x60 mm, 8x65 mm, 8x70 mm, 10x25 mm, 10x40 mm, 10x50 mm, 12x40 mm, 12x50 mm

YATO 

YT-06786  4/16

EN Spring assortment
 PL Zestaw sprężynek
 DE Schraubenfeder Sortiment
 RU Набор пружинко оцинкованных
 CZ Sada pružin
 HU Rugó készlet

RO Set arcuri
 FR Assortiment ressorts
 IT Set di molle
 ES Caja surtido de de resortes
 CN 弹簧组套

200
PCS

MIX



4.0x79.5 mm (12 PCS), 4.5x44.5 mm (8 PCS), 5.0x20.5 mm (10 PCS), 5.5x17.5 mm (10 PCS), 5.5x25.5 mm (10 PCS), 5.5x38.0 mm (10 PCS), 6.5x10.0 mm (10 PCS), 6.5x22.0 mm (10 PCS), 7.0x12.5 mm (10 PCS), 7.0x19.0 mm (10 PCS), 7.0x38.0 mm (10 PCS), 7.0x51.0 mm (12 PCS), 8.0x28.5 mm (8 PCS), 8.0x31.5 mm (10 PCS), 8.0x44.5 mm (12 PCS), 8.5x36.5 mm (10 PCS), 8.5x47.0 mm (12 PCS), 9.0x35.0 mm (8 PCS), 9.5x16.0 mm (6 PCS), 9.5x19.0 mm (12 PCS)

YATO 

YT-06875  5/20

EN Hitch pin assortment set
 PL Zestaw zawleczek sprężystych
 DE Federsplinte Sortiment
 RU Набор шплинтов с фиксацией
 CZ Pružinové závlačky
 HU Rugós csap

RO Set sigurante securizare
 FR Assortiment goupilles beta
 IT Set di spine elastiche
 ES Pasadores surtido beta
 CN R型销

150
PCS

6
SIZES
ROZMÁRY



 2.0x33 mm, 2.0x40 mm, 2.4x31 mm, 2.8x42 mm, 3.5x45 mm, 4.0x75 mm

YATO 

YT-06883  6/24

EN Grease nipple set
 PL Zestaw smarowniczek
 DE Schmiernippel
 RU Набор масленок
 CZ Sady mazacích hlavic
 HU Zsírözömb (zsírözöfj) készlet

RO Set gresoare metalice
 FR Set de graisseurs métriques
 IT Set grasso capezoli
 ES Engrasador
 CN 黄油嘴组套

110
PCS

METRIC
METRYCZNY



M6x1 (60 PCS), M6x1 45° (5 PCS), M6x1 90° (5 PCS), M8x1 (10 PCS), M8x1 45° (5 PCS), M8x1 90° (5 PCS), M10x1 (10 PCS), M10x1 45° (5 PCS), M10x1 90° (5 PCS)

YATO 

YT-06888  5/20

EN Aluminium blind rivet assortment
 PL Zestaw aluminiowych nitów zrywalnych
 DE Aluminium Blindnieten Sortiment
 RU Набор заклепок алюминиевых
 CZ Sada hliníkových nýtů
 HU Alumínium popszegecs készlet

RO Set popnituri aluminiu
 FR Jeu de rivets aveugles en aluminium
 IT Set di rivetto alluminio
 ES Juego de remaches de aluminio
 CN 铆钉

400
PCS

MIX

AI



 2.4, 3.2, 4.0, 4.8 mm

YATO 

YT-36420  5/20

EN Splint pin assortment
 PL Zestaw zawleczek prostych
 DE Splinte Sortiment
 RU Набор шплинтов
 CZ Set závlačky
 HU Sasszeg készlet

RO Pini de siguranță drepti
 FR Goupilles - goupille fendue
 IT Set di perni
 ES Dividir cotter pinos
 CN 开口销

555
PCS

MIX



 1.6x25 mm, 2.4x25 mm, 2.4x38 mm, 3.2x32 mm, 3.2x50 mm, 4.0x64 mm

YATO 

YT-06873  5/10

EN Splint pin assortment
PL Zestaw zawleczek prostych
DE Splinte Sortiment
RU Набор шплинтов
CZ Set závlačky
HU Saszeg készlet

RO Pini de siguranță drepti
FR Goupilles - goupille fendue
IT Set di perni
ES Dividir cotter pinos
CN 开口销组套

1000
PCS

MIX

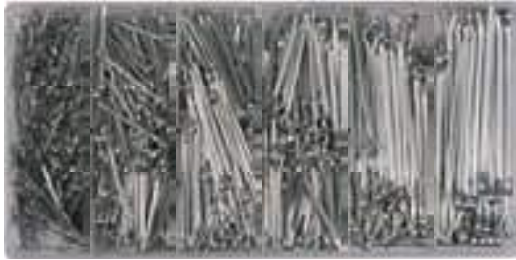

1.5x25 mm, 2.4x25 mm, 2.4x38 mm, 3.0x32 mm, 3.0x50 mm, 4.0x60 mm

YATO

YT-06885



6/12

EN E-ring circlips assortment
PL Zestaw zawleczek typu „E”
DE E-Sicherungsringe Sortiment
RU Набор Э-образных стопорных колец
CZ Otevření pojistný kroužek
HU „E” klip választék készlet

RO Set inele de siguranta tip „E”
FR „E” clip assortment kit
IT Set di spine tipo „E”
ES E-ring anillo de retención variedad
CN 卡簧

300
PCS

1.5-22
mm



1.5 mm, 3 mm, 5 mm, 6 mm, 10 mm, 12 mm, 15 mm, 19 mm, 22 mm

YATO

YT-06884



25

EN Metal tiller tin pin assortment
PL Zestaw zawleczek i sworzni z lbem i otworami
DE Set Splinte und Bolzen mit Kopf und Löchern
RU Набор шплинтов и болтов с головкой и отверстиями
CZ Sada závlaček a šroubů s hlavou a otvory
HU Saszeg és fejes, nyílásos csaszeg készlet

RO Set bolturi cu sigurante
FR Jeu de goupilles et d'axes avec têtes et des trous
IT Kit di copiglie e perni con testa e fori
ES Juego de pasadores y pernos con cabeza y aberturas
CN 八孔销

56
PCS

8-13
mm

MIX



8x50 mm (5 PCS), 9.5x50 mm (15 PCS), 11x64 mm (5 PCS), 13x50 mm (3 PCS), Pins / Zawlecзки: 2x30 mm (5 PCS), 2.5x40 mm (15 PCS), 2.5x40 mm (5 PCS), 3x44 mm (3 PCS)

YATO

YT-06874



20

EN Axle wave washer assortment
PL Zestaw zabezpieczeń osiowych sprężystych
DE Axialer Federschutzsatz
RU Замок осевой пружинный
CZ Sada axiálních pružinových závlaček
HU Rugós tengelybiztosító gyűrbű

RO Set șaibe autoblocante
FR Jeu de protections axiaux à ressorts
IT Kit di protezioni assiali a molla
ES Juego de sujeciones rápidas elásticas para ejes
CN 轴承夹片

260
PCS

MIX

65Mn



M3x10 mm (30 PCS), M4x11.5 mm (30 PCS), M5x14 mm (40 PCS), M6x16 mm (50 PCS), M8x18 mm (50 PCS), M10x20.5 mm (40 PCS), M12x26 mm (20 PCS)

YATO

YT-06860



24

EN Linch-pins assortment
PL Zestaw zawleczek z kółkiem
DE Klappsplint Sortiment
RU Набор шплинтов с кольцом
CZ Kolík pojistný
HU Rugos biztosítoszeg készlet

RO Set pini pt. securizare
FR Assortiment goupille clip
IT Set di perni dalla ruota
ES Pasador clip
CN 弹性销组套

50
PCS

MIX



Ø 4.5x36 mm, Ø 6.0x45 mm, Ø 8.0x45 mm, Ø 11.0x45 mm

YATO

YT-06787



6/12

EN Single ear hose clamp assortment
PL Zestaw obejm zaciskowych z uchem
DE 1-Ohr-Schellensatz
RU Зажимы для шлангов с ушком
CZ Jednoho ucha hadicové svorky
HU Fűles szorítóbilincs készlet

RO Coliere metalice pt. furtun
FR Jeu de colliers de serrage à oreille
IT Set di fascette di fissaggio con orecchio
ES Juego de abrazaderas de una oreja
CN 卡箍套装

170
PCS

MIX



SS304
STAINLESS STEEL
STAL NIERDZEWNA



5.8-7 mm (20 PCS), 7.3-9 mm (20 PCS), 8.8-10.5 mm (20 PCS), 10.8-13.3 mm (20 PCS), 12-14.5 mm (20 PCS), 12.3-14.8 mm (20 PCS), 14.5-17 mm (20 PCS), 16-19.2 mm (15 PCS), 17.8-21 mm (15 PCS)

YATO

YT-067842



20

- EN Hose clamp assortment
 PL Zestaw obejm ślimakowych
 DE Schlauchschelle Sortiment
 RU Набор хомутов
 CZ Spony stahovac na hadice sada
 HU Tömítőbilincs csőszerelés szett
- RO Coliere furtun
 FR Colliers de serrage universels
 IT Fascetta assortmento
 ES Manguera helicoidal instalación de tuberías abrazadera conjunto
 CN 喉箍

26
PCS

16-40
mm

MIX



16, 22, 25, 28, 35, 40 mm

YATO

YT-06782 5/20

- EN Hose clamp assortment
 PL Zestaw obejm skręcanych do przewodów
 DE Schlauchschellen-Set
 RU Набор винтовых зажимов для кабелей
 CZ Sada šroubovaných svorek do hadic
 HU Vezetékbilincs készlet
- RO Set coliere pt. furtun
 FR Jeu de supports à visser pour conducteurs
 IT Kit di clip fermacavi
 ES Juego de abrazaderas atornillables para cables
 CN 喉箍

30
PCS

MIX

6-16
mm



6-8 mm (7 PCS), 7-9 mm (7 PCS), 8-10 mm (5 PCS), 9-11 mm (5 PCS), 10-12 mm (3 PCS), 14-16 mm (3 PCS)

YATO

YT-06783 24

- EN Steel and rubber hose clamps
 PL Zestaw opasek zaciskowych metalowo-gumowych
 DE Gummierter Schlauchschellen Sortiment
 RU Хомуты сантехнические
 CZ Kabelové přičhytky s gumou
 HU Gumbetétes szorítóbilincs készlet
- RO Coliere de furtun din otel si cauciuc
 FR Colliers de serrage en métal et caoutchouc
 IT Set di fascette di fissaggio di metallo e gomma
 ES Abrazaderas con goma
 CN 单耳卡箍套装

18
PCS

MIX

GALVANIZED
STEEL
STAT.
GALVANIZOWANA



6 mm (8 PCS), 8 mm (4 PCS), 10 mm (2 PCS), 13 mm (2 PCS), 16 mm (2 PCS)

YATO

YT-067833 54

- EN Steel and rubber hose clamps
 PL Zestaw opasek zaciskowych metalowo-gumowych
 DE Gummierter Schlauchschellen Sortiment
 RU Хомуты сантехнические
 CZ Kabelové přičhytky s gumou
 HU Gumbetétes szorítóbilincs készlet
- RO Coliere de furtun din otel si cauciuc
 FR Colliers de serrage en métal et caoutchouc
 IT Set di fascette di fissaggio di metallo e gomma
 ES Abrazaderas con goma
 CN 单耳卡箍套装

52
PCS

MIX

SS304
STAINLESS STEEL
STAŁ. NIEODŻYWIANA



6 mm (12 PCS), 8 mm (10 PCS), 10 mm (10 PCS), 13 mm (8 PCS), 16 mm (8 PCS), 19 mm (4 PCS)

YATO

YT-067834 22

- EN Double ear hose clamp assortment
 PL Zestaw obejm zaciskowych z uszami
 DE 2-Ohr-Schellensatz
 RU Набор хомутов с проушинами
 CZ Dvojité ucho hadicové svorky
 HU Füles szorítókészlet
- RO Set cleme furtun
 FR Jeu de serre-câbles à oreilles
 IT Set di fascette di fissaggio con orecchie
 ES Set de abrazaderas con orejetas
 CN 双耳卡箍套装

175
PCS

MIX

GALVANIZED
STEEL
STAT.
OCYNKOWANA



5-7 mm (25 PCS), 7-9 mm (25 PCS), 9-11 mm (25 PCS), 11-13 mm (20 PCS), 13-15 mm (20 PCS), 15-18 mm (20 PCS), 17-20 mm (15 PCS), 20-23 mm (15 PCS), 23-27 mm (10 PCS)

YATO

YT-06784 10

- EN External / internal circlip assortment
 PL Zestaw pierścieni Segera
 DE Seeger-Sicherungsringe
 RU Набор стопорных колец
 CZ Sada vnitřní / vnější kroužky
 HU Seeger gyűrű készlet
- RO Set sigurante tip inel alezaj
 FR Set de bagues Seeger
 IT Set di anelli Seeger
 ES Set de anillos Seeger
 CN 卡簧

225
PCS

MIX



Internal / Wewnętrzne: Ø 11, 13, 14, 16, 19, 20 mm; External / Zewnętrzne: Ø 6, 8, 9, 11, 13, 14, 16, 19, 20, 22, 25, 32 mm

YATO

YT-06882 5/20

EN External circlip assortment
PL Zestaw pierścieni Segera zewnętrznych
DE Aussen-Seegerring Sortiment
RU Набор стопорных колец
CZ Sada pojistné kroužky
HU Külső seeger-gyűrű készlet

RO Set sigurante tip inel alezaj
FR Set de bagues Seeger
IT Set di anelli Seeger
ES Set de anillos Seeger
CN 外置挡圈

300
PCS



Ø 3, 4, 5, 6, 8, 9, 11, 12, 13, 14, 15, 19, 20, 22, 25, 26, 28, 32 mm

YATO
YT-06880

5/20

EN Feather key assortment
PL Zestaw klinów do kół pasowych
DE Keilset für Riemenscheiben
RU Комплект клиньев для шкивов
CZ Sada klínů pro vodící kladky
HU Szíjzárcsa ékkészlet

RO Set pene
FR Jeu de cales pour poulies
IT Set di linguette per pulegge
ES Juego de cuñas de polea
CN 平键

60
PCS

MIX



3x3x20 mm (4 PCS), 3x3x25 mm (4 PCS), 8x10x30 mm (5 PCS), 5x5x20 mm (5 PCS), 8x7x30 mm (5 PCS), 5x5x25 mm (5 PCS), 8x7x40 mm (5 PCS), 5x5x30 mm (5 PCS), 6x6x20 mm (5 PCS), 10x8x40 mm (5 PCS), 6x6x30 mm (5 PCS), 6x6x40 mm (5 PCS), 8x12x40 mm (2 PCS)

YATO
YT-06793

24

EN Steel ball assortment
PL Zestaw kulek stalowych
DE Stahlkugeln-Set
RU Набор стальных шариков
CZ Sada ocelových kuliček
HU Acél golyókészlet

RO Set bile pt. rulmenți
FR Jeu de billes en acier
IT Set di sfere d'acciaio
ES Juego de bolas de acero
CN 轴承钢珠组套

470
PCS

MIX

BEARING
STEEL
STAL
ŁOŻYSKOWA

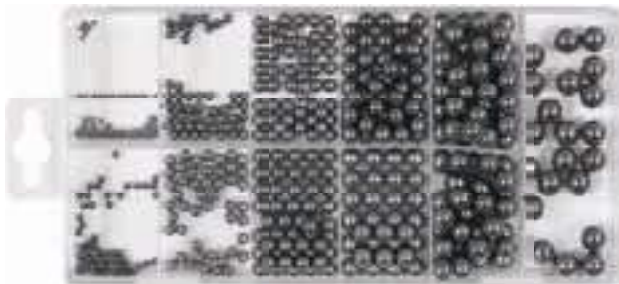

3/32" (2.4 mm, 50 PCS), 1/8" (3.2 mm, 50 PCS), 5/32" (4.0 mm, 50 PCS), 3/16" (4.8 mm, 50 PCS), 7/32" (5.6 mm, 50 PCS), 1/4" (6.3 mm, 50 PCS), 9/32" (7.1 mm, 50 PCS), 5/16" (7.9 mm, 30 PCS), 11/32" (8.7 mm, 50 PCS), 3/8" (9.5 mm, 20 PCS), 13/32" (10.3 mm, 20 PCS)

YATO
YT-06680

5/20

EN Internal circlip assortment
PL Zestaw pierścieni Segera wewnętrznych
DE Innen-Seegerring Sortiment
RU Набор стопорных колец
CZ Sada pojistné kroužky
HU Belső seeger-gyűrű készlet

RO Set sigurante tip inel alezaj
FR Set de bagues Seeger
IT Set di anelli Seeger
ES Set de anillos Seeger
CN 内置挡圈

300
PCS



Ø 3, 4, 5, 6, 8, 9, 11, 12, 13, 14, 15, 19, 20, 22, 25, 26, 28, 32 mm

YATO
YT-06881

5/20

EN Feather keys assortment
PL Zestaw klinów półokrągłych
DE Sortiment Federkeile
RU Шпонки полукруглые
CZ Sada klínů polokruhových
HU Ives hornyok biztosítására

RO Set pene disc pt. imbinari arbore
FR Aspérule clés assortiment
IT Set di cunei semicirculari
ES Surtido de chavetas media luna
CN 键销组套

80
PCS

MIX



3.0x5.0x13 mm, 3.0x6.5x16 mm, 4.0x5.0x13 mm, 4.0x6.5x16 mm, 4.0x7.5x19 mm, 5.0x7.5x19 mm, 5.0x9.0x22 mm, 6.0x9.0x22 mm

YATO
YT-06790

5/20

EN Socket head set screw assortment metric
PL Zestaw śrub imbusowych bez łożka
DE Sortiment Madenschrauben, metrisch
RU Набор винтов установочных с плоским концом
CZ Šroub stavěcí, plochý konec, bez úpravy
HU Set menetes sasszegekkel

RO Set șuruburi fără cap
FR Set clavettes de vis
IT Set di viti esagonali senza testa
ES Conjunto de tornillo chavetas
CN 螺钉组套

160
PCS

MIX



METRIC
METRYCZNY



3x5 mm, 4x5 mm, 5x6 mm, 6x6 mm, 6x6 mm F, 6x10 mm, 8x10 mm, 8x10 mm F, 8x12 mm, 10x10 mm, 10x10 mm F, 10x12 mm

YATO
YT-06777

5/20

EN Rubber grommet assortment
 PL Zestaw przelotek gumowych
 DE Gummi-Durchgangs-Tullen Sortiment
 RU Набор резиновых втулок
 CZ Gumové průchodka
 HU Gumi grommet készlet

RO Set garnituri din cauciuc
 FR Coffret passe-cloison caoutchouc
 IT Gommino angello
 ES Caja surtido de pasamuros de goma
 CN 垫圈组套

180
PCS

MIX

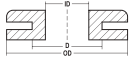
6.3 mm (D=6.3 mm, ID=3.0 mm, OD=8.0 mm; 40 PCS), 7.9 mm (D=7.9 mm, ID=5.0 mm, OD=10.0 mm; 40 PCS), 9.5 mm (D=9.5 mm, ID=6.0 mm, OD=13.0 mm; 40 PCS), 11 mm (D=11.0 mm, ID=9.0 mm, OD=15.0 mm; 25 PCS), 12.7 mm (D=12.7 mm, ID=11.0 mm, OD=15.0 mm; 20 PCS), 15.8 mm (D=15.8 mm, ID=12.0 mm, OD=19.0 mm; 5 PCS), 22 mm (D=22.0 mm, ID=15.0 mm, OD=26.0 mm; 5 PCS), 25.4 mm (D=25.4 mm, ID=17.0 mm, OD=32.0 mm; 5 PCS)

YATO

YT-06878

5/20

EN Roll pin assortment
 PL Zestaw kołków sprężystych
 DE Hohlspannstifte Sortiment
 RU Набор штифтов с пружиной
 CZ Pružné válcové kolíky se štěrbínou
 HU Rugalmas hengeres csapok a nyílásba

RO Set știfturi elastice
 FR Ressorts à rouleaux
 IT Perno del rullo assortimento
 ES Acero pasador elástico
 CN 弹性销

315
PCS

MIX



1.5x5 mm, 1.5x8 mm, 1.5x20 mm, 2x6 mm, 2x12 mm, 2x25 mm, 2.5x16 mm, 2.5x25 mm, 2.5x30 mm, 3x16 mm, 3x25 mm, 3x30 mm, 4x16 mm, 4x25 mm, 4x40 mm, 5x16 mm, 5x25 mm, 5x30 mm, 5.5x16 mm, 5.5x30 mm, 5.5x45 mm, 6x16 mm, 6x30 mm, 6x45 mm, 8x20 mm, 8x40 mm, 8x50 mm, 10x20 mm, 10x40 mm, 10x50 mm

YATO

YT-06785

5/20

EN O-ring assortment
 PL Zestaw O-ringów gumowych
 DE O-Ring Sortiment
 RU Набор резиновых прокладок
 CZ Sada gumových o-kroužků
 HU O gyűrű készlet

RO Garnituri din cauciuc
 FR Set d'o-rings en caoutchouc
 IT Set guarnizioni O-ring
 ES Kit de junta tórica
 CN O型圈组套

225
PCS

HEAT RESISTANT TEMPERATURE-RESISTANT

CHEMICAL PROOF



Ø3x1 mm (20 PCS), Ø4x1 mm (20 PCS), Ø4.5x2 mm (20 PCS), Ø5x2 mm (20 PCS), Ø6x2 mm (20 PCS), Ø6x2.5 mm (20 PCS), Ø6x3 mm (20 PCS), Ø7x2 mm (20 PCS), Ø8x2 mm (20 PCS), Ø9x2 mm (5 PCS), Ø10x2 mm (5 PCS), Ø12x3 mm (5 PCS), Ø13x3 mm (5 PCS), Ø14x2.5 mm (5 PCS), Ø17x2.5 mm (5 PCS), Ø18x4 mm (5 PCS), Ø20x2 mm (5 PCS), Ø22x2 mm (5 PCS)

YATO

YT-06877

5/20

EN O-Rings assortment for air conditioning
 PL Zestaw O-ringów do klimatyzacji
 DE O-Ringe für Klimaanlage
 RU Комплект прокладок для кондиционера
 CZ Gumový kroužek set klimatizace
 HU Gumi gyűrű készlet légkondicionáló

RO Garnituri pt. aer condiționat
 FR Cercle en caoutchouc boîte de kit combinaison
 IT O-Ring assortimento per l'aria condizionata
 ES Kit círculo caucho combinación caja
 CN 氯化丁晴密封圈

225
PCS

MIX

HNBR



Ø3x1 mm (20 PCS), Ø4x1 mm (20 PCS), Ø4.5x2 mm (20 PCS), Ø5x2 mm (20 PCS), Ø6x2 mm (20 PCS), Ø6x2.5 mm (20 PCS), Ø6x3 mm (20 PCS), Ø7x2 mm (20 PCS), Ø8x2 mm (20 PCS), Ø9x2 mm (5 PCS), Ø10x2 mm (5 PCS), Ø12x3 mm (5 PCS), Ø13x3 mm (5 PCS), Ø14x2.5 mm (5 PCS), Ø17x2.5 mm (5 PCS), Ø18x4 mm (5 PCS), Ø20x2 mm (5 PCS), Ø22x2 mm (5 PCS)

YATO

YT-068791

5/20

EN O-Rings assortment for air conditioning
 PL Zestaw O-ringów do klimatyzacji
 DE O-Ringe für Klimaanlage
 RU Комплект прокладок для кондиционера
 CZ Gumový kroužek set klimatizace
 HU Gumi gyűrű készlet légkondicionáló

RO Garnituri pt. aer condiționat
 FR Set d'o-rings en caoutchouc
 IT Set guarnizioni O-ring
 ES Kit de junta tórica
 CN O型圈组套

270
PCS

MIX

HNBR



Ø5.29x1.78 mm (20 PCS), Ø6.07x1.78 mm (20 PCS), Ø7.65x1.78 mm (20 PCS), Ø6.8x1.9 mm (20 PCS), Ø7.8x1.9 mm (20 PCS), Ø8x2 mm (20 PCS), Ø8.8x1.9 mm (20 PCS), Ø10x2 mm (10 PCS), Ø10.82x1.78 mm (15 PCS), Ø10.77x2.62 mm (15 PCS), Ø11x2 mm (15 PCS), Ø12x2 mm (15 PCS), Ø13.9x1.8 mm (10 PCS), Ø13.95x2.62 mm (10 PCS), Ø15x2 mm (10 PCS), Ø17x2 mm (10 PCS), Ø17.04x3.53 mm (10 PCS), Ø17.17x1.78 mm (10 PCS)

YATO

YT-06879

6/24

EN O-ring assortment
 PL Zestaw O-ringów gumowych
 DE O-Ring Sortiment
 RU Набор резиновых прокладок
 CZ Sada gumových o-kroužků
 HU O gyűrű készlet

RO Garnituri din cauciuc
 FR Set d'o-rings en caoutchouc
 IT Set guarnizioni O-ring
 ES Kit de junta tórica
 CN O型圈

419
PCS

MIX

NBR

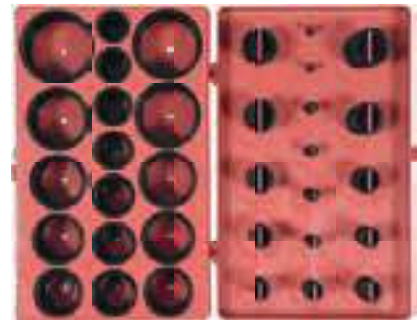
Ø3x1.5 mm (20 PCS), Ø4.4x2 mm (20 PCS), Ø5x2 mm (18 PCS), Ø7x1.5 mm (23 PCS), Ø10x1.5 mm (23 PCS), Ø10x2.5 mm (14 PCS), Ø11x2.5 mm (13 PCS), Ø13x1.5 mm (23 PCS), Ø13x2.5 mm (14 PCS), Ø14x2.5 mm (13 PCS), Ø16x2.5 mm (14 PCS), Ø18x2.5 mm (14 PCS), Ø18x3.5 mm (10 PCS), Ø19x2.5 mm (13 PCS), Ø20x3.5 mm (10 PCS), Ø21x2.5 mm (14 PCS), Ø22x2.5 mm (13 PCS), Ø22x3.5 mm (10 PCS), Ø23.5x3.5 mm (10 PCS), Ø25x3.5 mm (10 PCS), Ø26.5x3.5 mm (10 PCS), Ø28x3.5 mm (10 PCS), Ø30x3.5 mm (10 PCS), Ø31x3.5 mm (10 PCS), 33x3.5 mm (10 PCS), Ø34.5x3.5 mm (10 PCS), Ø36x3.5 mm (10 PCS), Ø38x3.5 mm (10 PCS), Ø41x3.5 mm (10 PCS), Ø44x3.5 mm (10 PCS), Ø47x3.5 mm (10 PCS), Ø50x3.5 mm (10 PCS)

YATO

YT-06876

5/20

EN Electrical clip assortment
PL Zestaw złączy elektrycznych - krokodylki
DE Krokodil-Klemmen-Koriment
RU Набор зажим "крокодил"
CZ Terminal alligator krokodil příchytok
HU Krokodil csipesz készlet

RO Set cleme crocodil pt. electricieni
FR Assortiment pinces crocodile
IT Set di pemi per misure e prove
ES Crocodile clip
CN 夹头组套

28
PCS

MIX



50, 55, 60, 65, 70, 80 mm

YATO

YT-06870



5/20

EN Terminal assortment
PL Zestaw złączy elektrycznych
DE Kabelschuh-Set
RU Набор электрических клемм
CZ Sada elektrických konektorů
HU Elektromos csatlakozókészlet

RO Set conectori electrice
FR Jeu de cosses de câbles
IT Kit di connettori elettrici
ES Juego de conectores eléctricos
CN 接线端子

250
PCS

MIX



Connector blue male / Złącze niebieskie męskie: 6.4 mm (1.5-2.5 mm; 50 PCS), Connector blue female / Złącze niebieskie żeńskie: 6.4 mm (1.5-2.5 mm; 50 PCS), Connector red male / Złącze czerwone męskie: 6.4 mm (0.5-1.5 mm; 50 PCS), Connector red female / Złącze czerwone żeńskie: 6.4 mm (0.5-1.5 mm; 50 PCS), Connector tube red / Złącze rurowe czerwone: (0.5-1.5 mm; 25 PCS), Connector tube blue / Złącze rurowe niebieskie: (0.5-1.5 mm; 25 PCS)

YATO

YT-068911



60

EN Terminal assortment
PL Zestaw złączy elektrycznych
DE Kabelschuh-Set
RU Набор электрических клемм
CZ Sada elektrických konektorů
HU Elektromos csatlakozókészlet

RO Set conectori electrice
FR Jeu de cosses de câbles
IT Kit di connettori elettrici
ES Juego de conectores eléctricos
CN 接线端子

360
PCS

MIX



⊖ ⊞ 05 mm - 2 mm2 (30 PCS), ⊖ ⊞ 06 mm - 2 mm2 (20 PCS), ⊖ ⊞ 2 mm2 (25 PCS);
⊖ ⊞ 09.5 mm - 2 mm2 (20 PCS), ⊖ ⊞ 05 mm - 5.5 mm2 (20 PCS), ⊖ ⊞ 2 mm2 (35 PCS);
mm - 5.5 mm2 (15 PCS), ⊖ ⊞ 09.5 mm - 5.5 mm2 (15 PCS); ⊖ ⊞ 2 mm2 (10 PCS);
⊖ ⊞ 1.25 mm2 (40 PCS), ⊖ ⊞ 2 mm2 (30 PCS), ⊖ ⊞ 5.5 mm2 (15 PCS); ⊖ ⊞ 2 mm2 (35 PCS)
⊖ ⊞ 05 mm - 2 mm2 (30 PCS), ⊖ ⊞ 05 mm - 5.5 mm2 (20 PCS);

YATO

YT-06890



12

EN Terminal assortment
PL Zestaw złączy elektrycznych
DE Kabelschuh-Set
RU Набор электрических клемм
CZ Sada elektrických konektorů
HU Elektromos csatlakozókészlet

RO Set conectori electrice
FR Jeu de cosses de câbles
IT Kit di connettori elettrici
ES Juego de conectores eléctricos
CN 接线端子

160
PCS

MIX



⊖ ⊞ 04 mm (8 PCS), ⊖ ⊞ 04 mm (10 PCS), ⊖ ⊞ 05 mm (4 PCS), ⊖ ⊞ 05 mm (10 PCS), ⊖ ⊞ 06 mm (10 PCS), ⊖ ⊞ 08 mm (4 PCS), ⊖ ⊞ 10 mm (4 PCS);
⊖ ⊞ 0.25-1.5 mm2 (12 PCS), ⊖ ⊞ 1.5-2.5 mm2 (18 PCS), ⊖ ⊞ 4-6 mm2 (12 PCS);
⊖ ⊞ 04 mm (10 PCS);
⊖ ⊞ 1.5-2.5 mm2 (10 PCS);
⊖ ⊞ 1.5-2.5 mm2 (10 PCS);
⊖ ⊞ 1.5-2.5 mm2 (10 PCS), ⊖ ⊞ 4-6 mm2 (5 PCS);
⊖ ⊞ 0.25-1.5 mm2 (4 PCS), ⊖ ⊞ 1.5-2.5 mm2 (4 PCS)

YATO

YT-06891



24

EN Terminal assortment
PL Zestaw złączy elektrycznych
DE Kabelschuh-Set
RU Набор электрических клемм
CZ Sada elektrických konektorů
HU Elektromos csatlakozókészlet

RO Set conectori electrice
FR Jeu de cosses de câbles
IT Kit di connettori elettrici
ES Juego de conectores eléctricos
CN 接线端子

240
PCS

MIX



Connector red female / Złącze czerwone żeńskie: 6.4 mm (0.5-1.5 mm; 20 PCS), Connector red full female / Złącze czerwone pełne żeńskie: 4.8 mm (0.5-1.5 mm; 20 PCS), Connector red male / Złącze czerwone męskie: 4.8 mm (0.5-1.5 mm; 20 PCS), Connector red male male / Złącze czerwone męsko-męskie: 6.4 mm (0.5-1.5 mm; 40 PCS), Connector blue female / Złącze niebieskie żeńskie: 6.4 mm (1.5-2.5 mm; 20 PCS), Connector red full female / Złącze czerwone pełne żeńskie: 6.4 mm (0.5-1.5 mm; 20 PCS), Connector blue full female / Złącze niebieskie pełne żeńskie: 6.4 mm (1.5-2.5 mm; 20 PCS), Connector blue male male / Złącze niebieskie męsko-męskie: 6.4 mm (1.5-2.5 mm; 40 PCS), Connector blue male / Złącze niebieskie męskie: 4.8 mm (1.5-2.4 mm; 20 PCS), Connector blue female / Złącze niebieskie żeńskie: 4.8 mm (1.5-2.5 mm; 20 PCS)

YATO

YT-068912



60

EN Terminal assortment
PL Zestaw złączy elektrycznych
DE Kabelschuh-Set
RU Набор электрических клемм
CZ Sada elektrických konektorů
HU Elektromos csatlakozókészlet

RO Set conectori electrice
FR Jeu de cosses de câbles
IT Kit di connettori elettrici
ES Juego de conectores eléctricos
CN 接线端子

450
PCS

MIX



Connector female / Złącze żeńskie: 2.8 mm, 4.8 mm, 6.4 mm (x50 PCS); Connector male / Złącze męskie: 2.8 mm, 4.8 mm, 6.4 mm (x50 PCS); Connector with hole / Złącze z oczkiem: Ø3.2 mm, Ø5.2 mm, Ø8.2 mm (x50 PCS)

YATO

YT-06863



24

EN Terminal assortment
 PL Zestaw złącz elektrycznych
 DE Kabelschuh-Set
 RU Набор электрических клемм
 CZ Sada elektrických konektorů
 HU Elektromos csatlakozókészlet

RO Set conectori electrice
 FR Jeu de cosses de câbles
 IT Kit di connettori elettrici
 ES Juego de conectores eléctricos
 CN 接线端子

600
PCS
MIX
 BRASS
 MOSIADZ



Connector female / Złącze żeńskie: 2.8 mm, 4.8 mm, 6.4 mm (x100 PCS); Connector male / Złącze męskie: 2.8 mm, 4.8 mm, 6.4 mm (x100 PCS)

YATO **YT-068684** 24

EN Insulated ferrules assortment
 PL Zestaw końcówek i konektorów kablowych
 DE Kabelschuh- und Verbinder-Set
 RU Набор кабельных наконечников и коннекторов
 CZ Sada kabelových koncovek a konektorů
 HU Végződés és csatlakozókészlet

RO Set conectori
 FR Jeu de cosses de câbles
 IT Set di terminali e connettori per cavi
 ES Set de puntas y conectores de cable
 CN 欧式接线端子

685
PCS
MIX
 BRASS
 MOSIADZ



0.5 mm (50 PCS), 0.75 mm (50 PCS), 1 mm (100 PCS), 1.5 mm (250 PCS), 2.5 mm (150 PCS), 4 mm (50 PCS), 6 mm (25 PCS), 10 mm (10 PCS)

YATO **YT-06895** 5/20

EN Wire connector assortment
 PL Zestaw końcówek kablowych
 DE Kabelschuh-Set
 RU Набор кабельных наконечников
 CZ Sada kabelových koncovek
 HU Kábelsaru készlet
 RO Set conectori
 FR Jeu de cosses de câbles
 IT Set di capicorda terminali elettrici
 ES Juego de terminales de cable
 CN 接线端子

65
PCS
MIX
 BRASS
 MOSIADZ



SC6-6 (15 PCS), SC6-8 (10 PCS), SC10-6 (10 PCS), SC10-8 (10 PCS), SC16-6 (5 PCS), SC16-8 (5 PCS), SC25-6 (5 PCS), SC25-8 (5 PCS)

YATO **YT-068915** 100

EN Terminal assortment
 PL Zestaw złącz elektrycznych
 DE Kabelschuh-Set
 RU Набор электрических клемм
 CZ Sada elektrických konektorů
 HU Elektromos csatlakozókészlet

RO Set conectori electrice
 FR Jeu de cosses de câbles
 IT Kit di connettori elettrici
 ES Juego de conectores eléctricos
 CN 接线端子

600
PCS
MIX
 BRASS
 MOSIADZ



PBDD 1-250, PBDD 2-250, PBDD 5-250, FDFD 5-250, RV 5.5-4, RV 5.5-5, RV 5.5-6 (x10 PCS); E1008 red / czerwone, E1508 red / czerwone, E2508 blue / niebieskie (x50 PCS); TE1008 red / czerwone, TE1508 red / czerwone, TE2510 red / czerwone, MDD 1-250, MDD 2-250 (x20 PCS); MDD 5-250, BV 5.5, FDD 5-250 (x10 PCS); FDFD 1-250, FDFD 2-250, RV 1.25-5, RV 2-5, BV 1.25, BV 2 (x15 PCS); RV 1.25-3, RV 1.25-4, RV 2-3, RV 2-4 (x30 PCS); FDD 1-250, FDD 2-250 (x20 PCS)

YATO **YT-068913** 20

EN Terminal assortment
 PL Zestaw złącz elektrycznych
 DE Kabelschuh-Set
 RU Набор электрических клемм
 CZ Sada elektrických konektorů
 HU Elektromos csatlakozókészlet

RO Set conectori electrice
 FR Jeu de cosses de câbles
 IT Kit di connettori elettrici
 ES Juego de conectores eléctricos
 CN 接线端子

750
PCS
MIX
 BRASS
 MOSIADZ



Connector female / Złącze żeńskie: 2.8 mm, 4.8 mm, 6.4 mm (x100 PCS); Connector male / Złącze męskie: 2.8 mm, 4.8 mm, 6.4 mm (x100 PCS); Connector with hole / Złącze z oczkiem: Ø3.2 mm, Ø5.2 mm, Ø6.2 mm, Ø8.2 mm, Ø10.5 mm (x30 PCS)

YATO **YT-068685** 24

EN Crimp bootlace ferrules assortment
 PL Zestaw końcówek kablowych
 DE Aderendhülsen Set
 RU Набор кабельных наконечников
 CZ Sada kabelových koncovek
 HU Kábelsaru készlet

RO Set pini pt. serlizat cabluri fără izolare
 FR Jeu de cosses de câbles
 IT Set di terminali
 ES Juego casquillos de cable
 CN 接线端子

1000
PCS
MIX
 BRASS
 MOSIADZ



0.5 mm (ferrule length / długość okucia: 6 mm), 0.75 mm (ferrule length / długość okucia: 6 mm), 1 mm (ferrule length / długość okucia: 6 mm), 1.5 mm (ferrule length / długość okucia: 7 mm), 2.5 mm (ferrule length / długość okucia: 7 mm) (x200 PCS)

YATO **YT-06896** 100

EN Insulated ferrules assortment
PL Zestaw końcówek i konektorów kablowych
DE Kabelschuh- und Verbinder-Set
RU Набор кабельных наконечников и коннекторов
CZ Sada kabelových koncovek a konektorů
HU Végződések és csatlakozókészlet

RO Set conectori
FR Jeu de cosSES de câbles
IT Set di terminali e connettori per cavi
ES Set de puntas y conectores de cable
CN 欧式接线端子

1200
PCS

MIX



E1012 red / czerwone (25 PCS), E6012 green / zielone (25 PCS), E1008 red / czerwone (200 PCS), E2508 blue / niebieskie (250 PCS), E4010 grey / szare (50 PCS), E1508 black / czarne (250 PCS), E0508 white / białe (200 PCS), E7508 grey / szare (200 PCS)

YATO		
YT-068914		20

EN Terminal connectors
PL Zestaw szybkozłączy elektrycznych
DE Kabelschuhe schnelkupplung kabelklemme
RU Набор экспресс-клемм
CZ Rychlořipojky elektrických konektorů
HU Gyors csatlakozó auto

RO Set conectori electrici rapizi
FR Connecteur rapide
IT Connettori terminali
ES Conector rapido electrico
CN 连接片组套

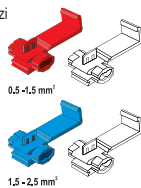

50
PCS

MIX



0.5-1.5 mm² (25 PCS), 1.5-2.5 mm² (25 PCS)

YATO		
YT-06868		5/20

EN Heat-shrink tubing set
PL Zestaw koszulek termokurczliwych
DE Schrumpfschlauch-Set
RU Набор термоусадочных трубок
CZ Sada smršťovacích bužirek
HU Zsugorcsó készlet

RO Set tuburi termocontractabile
FR Jeu de gaines thermorétractables
DE Schrumpfschlauch-Set
IT Kit guaine termorestringenti
ES Kit de tubos termorretráctiles
CN 热收缩管

100
PCS

MIX

max °C
125



Ø1.5x100 mm (30 PCS), Ø2.5x100 mm (30 PCS), Ø4x100 mm (20 PCS), Ø6x100 mm (10 PCS), Ø10x100 mm (6 PCS), Ø13x100 mm (4 PCS)

YATO		
YT-068667		84

EN Crimping tool and terminals set

PL Zestaw złączy elektrycznych z zaciskarką
DE Kabelschuh-Set mit Crimpzange
RU Набор изолированных наконечников с пресс-клещами
CZ Sada elektrických konektorů s kleštěmi
HU Elektromos csatlakozókészlet kímelő fogóval
RO Set sertizat conectori electrici
FR Jeu de cosSES de câbles avec pince à sertir
IT Kit di connettori elettrici con pinze
ES Juego de conectores eléctricos con crimpadora
CN 冷压工具组套

551
PCS



0.5-6.0
mm²



0.5-1.5 mm² (90 PCS), 1.5-2.5 mm² (90 PCS), 2.5-3.5 mm² (30 PCS);

0.5-1.5 mm² (70 PCS), 1.5-2.5 mm² (70 PCS), 2.5-3.5 mm² (30 PCS);

0.5-1.5 mm² (30 PCS), 1.5-2.5 mm² (30 PCS);

0.5-1.5 mm² (30 PCS), 1.5-2.5 mm² (30 PCS)

YATO	mm ²	AWG	
YT-068920	0.5-6	22-10	10

EN Heat-shrink tubing set

PL Zestaw koszulek termokurczliwych
DE Schrumpfschlauch-Set
RU Набор термоусадочных трубок
CZ Sada smršťovacích bužirek
HU Zsugorcsó készlet

RO Set tuburi termocontractabile
FR Jeu de gaines thermorétractables
IT Kit guaine termorestringenti
ES Kit de tubos termorretráctiles
CN 热收缩管

100
PCS

MIX

max °C
125



Ø1.5x100 mm (30 PCS), Ø2.5x100 mm (30 PCS), Ø4x100 mm (20 PCS), Ø6x100 mm (10 PCS), Ø10x100 mm (6 PCS), Ø13x100 mm (4 PCS)

YATO		
YT-068661		84

EN Heat-shrink tubing set
PL Zestaw koszulek termokurczliwych
DE Schrumpfschlauch-Set
RU Набор термоусадочных трубок
CZ Sada smršťovacích bužirek
HU Zsugorcsó készlet

RO Set tuburi termocontractabile
FR Jeu de gaines thermorétractables
IT Kit guaine termorestringenti
ES Kit de tubos termorretráctiles
CN 热收缩管

127
PCS

MIX

max °C
125

max
600V



Ø2x40 mm, Ø2.5x40 mm, Ø3.5x40 mm, Ø5x40 mm, Ø7x80 mm, Ø10x80 mm, Ø13x85 mm

YATO		
YT-06866		84

EN Heat-shrink tubing set
 PL Zestaw koszulek termokurczliwych
 DE Schrumpfschlauch-Set
 RU Набор термоусадочных трубок
 CZ Sada smršťovacích bužírek
 HU Zsugorcső készlet

RO Set tuburi termocontractabile
 FR Jeu de gaines thermorétractables
 IT Kit guaine termorestringenti
 ES Kit de tubos termorretráctiles
 CN 热收缩管

128
PCS

MIX

max °C
125



Ø2.5x8 mm (40 PCS), Ø3.5x80 mm (32 PCS), Ø5x80 mm (24 PCS), Ø7x80 mm (16 PCS), Ø10x80 mm (8 PCS), Ø13x80 mm (8 PCS)

YATO 

YT-068668 24

EN Heat-shrink tubing set
 PL Zestaw koszulek termokurczliwych
 DE Schrumpfschlauch-Set
 RU Набор термоусадочных трубок
 HU Zsugorcső készlet

RO Set tuburi termocontractabile
 FR Jeu de gaines thermorétractables
 IT Kit guaine termorestringenti
 ES Kit de tubos termorretráctiles
 CN 热收缩管

171
PCS

MIX

max °C
125



Ø2x30 mm (100 PCS), Ø4x60 mm (10 PCS), Ø4.5x60 mm (10 PCS), Ø5x60 mm (8 PCS), Ø6x60 mm (6 PCS), Ø8x90 mm (11 PCS), Ø9x90 mm (11 PCS), Ø12x90 mm (7 PCS), Ø18x90 mm (7 PCS), Ø10x1000 mm (1 PCS)

YATO 

YT-068667 24

EN Heat-shrink tubing with glue set
 PL Zestaw koszulek termokurczliwych z klejem
 DE Schrumpfschlauch-Set mit Kleber
 RU Набор термоусадочных трубок с клеем
 CZ Sada smršťovacích bužírek s lepidlem
 HU Ragasztós zsugorcső készlet

RO Set tuburi termocontractabile cu lipici
 FR Jeu de gaines thermorétractables avec adhésif
 IT Kit guaine termorestringenti con adesivo
 ES Kit de tubos termorretráctiles adhesivos
 CN 带胶热收缩套管

270
PCS

MIX

max °C
125



Ø1.6x45 mm (70 PCS), Ø2.4x45 mm (80 PCS), Ø3.2x45 mm (80 PCS), Ø4.8x90 mm (20 PCS), Ø6.3x90 mm (12 PCS), Ø9.5x90 mm (8 PCS)

YATO 

YT-068671 60

EN Heat-shrink tubing with glue set
 PL Zestaw koszulek termokurczliwych z klejem
 DE Schrumpfschlauch-Set mit Kleber
 RU Набор термоусадочных трубок с клеем
 CZ Sada smršťovacích bužírek s lepidlem
 HU Ragasztós zsugorcső készlet

RO Set tuburi termocontractabile cu lipici
 FR Jeu de gaines thermorétractables avec adhésif
 IT Kit guaine termorestringenti con adesivo
 ES Kit de tubos termorretráctiles adhesivos
 CN 带胶热收缩套管

530
PCS

MIX

max °C
125



Ø1.5x45 mm (80 PCS), Ø2x45 mm (160 PCS), Ø3x45 mm (60 PCS), Ø4x45 mm (100 PCS), Ø5x45 mm (30 PCS), 6x45 mm (20 PCS), Ø8x45 mm (20 PCS), Ø10x45 mm (60 PCS)

YATO 

YT-068672 60

EN Heat shrink solder sleeve
 PL Koszulka termokurczliwa z cyną
 DE Wärmeschumpfende Verbinder mit Zinn
 RU Термоусадочная гильза с оловом
 CZ Smršťovací trubička s cínem
 HU Hőre zsugorodó hüvely ónnal
 RO Manșoane termocontractabile
 FR Gaine thermorétractable avec étain
 IT Guaine termorestringenti con stagno
 ES Tubo termorretráctil con estaño
 CN 免压热缩中接焊锡端子

30
PCS

0.25
x0.34
mm²

105
°C





EN Heat shrink solder sleeve
 PL Koszulka termokurczliwa z cyną
 DE Wärmeschumpfende Verbinder mit Zinn
 RU Термоусадочная гильза с оловом
 CZ Smršťovací trubička s cínem
 HU Hőre zsugorodó hüvely ónnal
 RO Manșoane termocontractabile
 FR Gaine thermorétractable avec étain
 IT Guaine termorestringenti con stagno
 ES Tubo termorretráctil con estaño
 CN 免压热缩中接焊锡端子

100
PCS

0.25
x0.34
mm²

105
°C





YATO 

Cross-sectional area / Przekrój przewodu

YT-81440 25/1500

0.25-0.34 mm² / 24-22 AWG

YATO 

Cross-sectional area / Przekrój przewodu

YT-81451 558

0.25-0.34 mm² / 24-22 AWG

EN Heat shrink solder sleeve
PL Koszulka termokurczliwa z cyną
DE Wärmeschumpfende Verbinder mit Zinn
RU Термоусадочная гильза с оловом
CZ Smršťovací trubička s cínem
HU Hőre zsugorodó hüvely ónnal
RO Manșoane termocontractabile
FR Gaine thermorétractable avec étain
IT Guaine termorestringenti con stagno
ES Tubo termorretráctil con estaño
CN 免压热缩中接焊锡端子

30 PCS 0.5 x1.5 mm² 105 °C



YATO Cross-sectional area / Przekrój przewodu
YT-81441 0.5-1.5 mm² / 18-16 AWG 15/900

EN Heat shrink solder sleeve
PL Koszulka termokurczliwa z cyną
DE Wärmeschumpfende Verbinder mit Zinn
RU Термоусадочная гильза с оловом
CZ Smršťovací trubička s cínem
HU Hőre zsugorodó hüvely ónnal
RO Manșoane termocontractabile
FR Gaine thermorétractable avec étain
IT Guaine termorestringenti con stagno
ES Tubo termorretráctil con estaño
CN 免压热缩中接焊锡端子

30 PCS 1.5 x2.5 mm² 105 °C



YATO Cross-sectional area / Przekrój przewodu
YT-81442 1.5-2.5 mm² / 16-14 AWG 5/300

EN Heat shrink solder sleeve
PL Koszulka termokurczliwa z cyną
DE Wärmeschumpfende Verbinder mit Zinn
RU Термоусадочная гильза с оловом
CZ Smršťovací trubička s cínem
HU Hőre zsugorodó hüvely ónnal
RO Manșoane termocontractabile
FR Gaine thermorétractable avec étain
IT Guaine termorestringenti con stagno
ES Tubo termorretráctil con estaño
CN 免压热缩中接焊锡端子

20 PCS 4.0 x6.0 mm² 105 °C



YATO Cross-sectional area / Przekrój przewodu
YT-81443 4-6 mm² / 12-10 AWG 5/300

EN Heat shrink solder sleeve set
PL Zestaw koszulek termokurczliwych z cyną
DE Satz wärmeschumpfender Verbinder mit Zinn
RU Комплект термоусадочных гильз с оловом
CZ Sada smršťovacích trubiček s cínem
HU Hőre zsugorodó hüvelykészlet ónnal

RO Manșoane termocontractabile
FR Jeu de gaines thermorétractables avec étain
IT Set di guaine termorestringenti con stagno
ES Conjunto de tubos termorretráctiles con estaño
CN 免压热缩中接焊锡端子

100 PCS

0.25 x6.0 mm²

105 °C

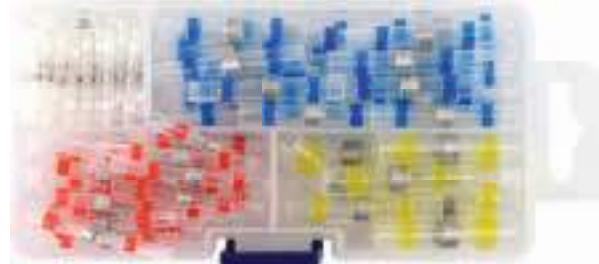

YATO Cross-sectional area / Przekrój przewodu
YT-81450 0.25-6 mm² / 26-10 AWG 150

EN Heat shrink solder sleeve
PL Koszulka termokurczliwa z cyną
DE Wärmeschumpfende Verbinder mit Zinn
RU Термоусадочная гильза с оловом
CZ Smršťovací trubička s cínem
HU Hőre zsugorodó hüvely ónnal
RO Manșoane termocontractabile
FR Gaine thermorétractable avec étain
IT Guaine termorestringenti con stagno
ES Tubo termorretráctil con estaño
CN 免压热缩中接焊锡端子

100 PCS 0.5 x1.5 mm² 105 °C



YATO Cross-sectional area / Przekrój przewodu
YT-81452 0.5-1.5 mm² / 20-16 AWG 378

EN Heat shrink solder sleeve
PL Koszulka termokurczliwa z cyną
DE Wärmeschumpfende Verbinder mit Zinn
RU Термоусадочная гильза с оловом
CZ Smršťovací trubička s cínem
HU Hőre zsugorodó hüvely ónnal
RO Manșoane termocontractabile
FR Gaine thermorétractable avec étain
IT Guaine termorestringenti con stagno
ES Tubo termorretráctil con estaño
CN 免压热缩中接焊锡端子

100 PCS 1.5 x2.5 mm² 105 °C



YATO Cross-sectional area / Przekrój przewodu
YT-81453 1.5-2.5 mm² / 16-14 AWG 130

EN Heat shrink solder sleeve
PL Koszulka termokurczliwa z cyną
DE Wärmeschumpfende Verbinder mit Zinn
RU Термоусадочная гильза с оловом
CZ Smršťovací trubička s cínem
HU Hőre zsugorodó hüvely ónnal
RO Manșoane termocontractabile
FR Gaine thermorétractable avec étain
IT Guaine termorestringenti con stagno
ES Tubo termorretráctil con estaño
CN 免压热缩中接焊锡端子

100 PCS 4.0 x6.0 mm² 105 °C



YATO Cross-sectional area / Przekrój przewodu
YT-81454 4-6 mm² / 12-10 AWG 100

EN Heat shrink solder sleeve set
PL Zestaw koszulek termokurczliwych z cyną
DE Satz wärmeschumpfender Verbinder mit Zinn
RU Комплект термоусадочных гильз с оловом
CZ Sada smršťovacích trubiček s cínem
HU Hőre zsugorodó hüvelykészlet ónnal
RO Manșoane termocontractabile
FR Jeu de gaines thermorétractables avec étain
IT Set di guaine termorestringenti con stagno
ES Kit de capas termorretrácteis com estanho
CN 免压热缩中接焊锡管

220 PCS 0.25 x6.0 mm² 105 °C



YATO Cross-sectional area / Przekrój przewodu
YT-81460 0.25-6 mm² / 24-10 AWG 60

- EN Heat shrink butt connectors set
 PL Zestaw zaciskanych koszulek termokurczliwych
 DE Satz gewellte Schrumpfhüllen
 RU Набор обжимных термоусадочных трубок
 CZ Sada upínacích teplem smršťitelných bužirek
 HU Szigetelt toldóhüvely készlet
 RO Set cuple termocontractabile
 FR Jeu de manchons thermorétractables sertis
 IT Set di giunti termorestringenti con stagno
 ES Juego de tubos termorretráctiles con stagno
 CN 防水热缩端子

200
PCS

0.5
x6.0
mm²



0.5-1.5 mm² (90 PCS), 1.5-2.5 mm² (90 PCS), 4.0-6.0 mm² (20 PCS)

YATO	Cross-sectional area / Przekrój przewodu	
YT-81461	0.5-6 mm ² / 20-10 AWG	60

- EN Back probe kit
 PL Zestaw przewodów i końcówek pomiarowych
 DE Messleitungen und -endstücke
 RU Набор кабелей и измерительных наконечников
 CZ Sada měřicích vodičů a koncovek
 HU Vezeték és mérőfej készlet
- RO Set cabluri și vârfuri pt. măsurare
 FR Kit de cordons et de fiches de test
 IT Set di cavi e terminali di misura
 ES Juego de cables y puntas de medición
 CN 破线测试针

20
PCS

0-30V
A.C.

0-30V
D.C.



YATO		
YT-73079		24

- EN Car fuse assortment
 PL Zestaw bezpieczników
 DE KFZ-Sicherungs-Set
 RU Набор предохранителей
 CZ Sada pojistek
 HU Biztosítékkészlet
- RO Set sigurante
 FR Ensemble de fusible
 IT Kit di fusibili lamellari
 ES Conjunto de fusibles
 CN 保险插片

92
PCS

STANDARD

FUSE
PULLER
SCIGACZ
BEZPECZNIKOW



5 A, 10 A, 15 A, 20 A, 25 A, 30 A (x15 PCS); tester 6-24 V

YATO		
YT-83142		24

- EN Car fuse assortment
 PL Zestaw bezpieczników
 DE KFZ-Sicherungs-Set
 RU Набор предохранителей
 CZ Sada pojistek
 HU Biztosítékkészlet
- RO Set sigurante
 FR Ensemble de fusible
 IT Kit di fusibili lamellari
 ES Conjunto de fusibles
 CN 保险插片

100
PCS

MINI



7.5 A (10 PCS), 10 A (20 PCS), 15 A (20 PCS), 20 A (20 PCS), 25 A (20 PCS), 30 A (10 PCS)

YATO		
YT-83145		12/60

- EN Superseal connectors wiring assortment
 PL Zestaw złączy elektrycznych hermetycznych
 DE Hermetischer Elektrostecker Satz
 RU Набор герметичных электрических разъемов
 CZ Sada hermetických elektrických svorek
 HU Hermetikus elektromos csatlakozókészlet

- RO Set conectori rapizi auto
 FR Jeu de connecteurs électriques hermétiques
 IT Kit di connettori elettrici a tenuta stagna
 ES Set de herméticos conectores eléctricos
 CN 低压电源线束快速接头

424
PCS



1-6
PIN

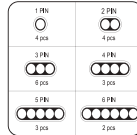

YATO		
YT-06869		6/12

- EN Car fuse assortment
 PL Zestaw bezpieczników
 DE KFZ-Sicherungs-Set
 RU Набор предохранителей
 CZ Sada pojistek
 HU Biztosítékkészlet
- RO Set sigurante
 FR Ensemble de fusible
 IT Kit di fusibili lamellari
 ES Conjunto de fusibles
 CN 保险插片

24
PCS

MAXI



20 A, 30 A, 40 A, 50 A, 60 A, 70 A, 80 A, 100 A (x3 PCS)

YATO		
YT-83140		24

- EN Car fuse assortment
 PL Zestaw bezpieczników
 DE KFZ-Sicherungs-Set
 RU Набор предохранителей
 CZ Sada pojistek
 HU Biztosítékkészlet
- RO Set sigurante
 FR Ensemble de fusible
 IT Kit di fusibili lamellari
 ES Conjunto de fusibles
 CN 保险插片

97
PCS

STANDARD

FUSE
PULLER
SCIGACZ
BEZPECZNIKOW



3 A, 5 A, 7.5 A, 10 A, 15 A, 20 A, 25 A, 30 A (x12 PCS)

YATO		
YT-83141		24

- EN Car fuse assortment
 PL Zestaw bezpieczników
 DE KFZ-Sicherungs-Set
 RU Набор предохранителей
 CZ Sada pojistek
 HU Biztosítékkészlet
- RO Set sigurante
 FR Ensemble de fusible
 IT Kit di fusibili lamellari
 ES Conjunto de fusibles
 CN 120汽用保险片

120
PCS

MINI



5 A, 10 A, 15 A, 20 A, 25 A, 30 A (x20 PCS)

YATO		
YT-83146		12

EN Car fuse assortment
PL Zestaw bezpieczników
DE KFZ-Sicherungs-Set
RU Набор предохранителей
CZ Sada pojistek
HU Biztosítékészlet

RO Set sigurante
FR Ensemble de fusible
IT Kit di fusibili lamellari
ES Conjunto de fusibles
CN 保险插片

88
PCS

STANDARD

MAXI

MINI



Mini: 3 A, 5 A, 7.5 A, 10 A, 15 A, 20 A, 25 A, 30 A (x5 PCS); standard: 3 A, 5 A, 7.5 A, 10 A, 15 A, 20 A, 25 A, 30 A (x5 PCS); max: 20 A, 30 A, 40 A, 50 A, 60 A, 70 A, 80 A, 100 A

YATO 

YT-83147



20

EN Car fuse assortment
PL Zestaw bezpieczników
DE KFZ-Sicherungs-Set
RU Набор предохранителей
CZ Sada pojistek
HU Biztosítékészlet

RO Set sigurante
FR Ensemble de fusible
IT Kit di fusibili lamellari
ES Conjunto de fusibles
CN 120汽车保险片

120
PCS

STANDARD



5 A, 10 A, 15 A, 20 A, 25 A, 30 A (x20 PCS)

YATO 

YT-83144



12

EN Glass fuse assortment
PL Zestaw bezpieczników szklanych
DE Glas-Sicherungssatz
RU Набор стеклянных предохранителей
CZ Sada sklených pojistek
HU Üvegbiztosíték készlet

RO Set sigurante de sticlă
FR Ensemble de fusibles en verre
IT Set di fusibili in vetro
ES Set de fusibles de vidrio
CN 玻璃管保险丝

120
PCS

6x30
mm

GLASS
SZKŁO



5 A, 10 A, 15 A, 20 A, 25 A, 30 A (x20 PCS)

YATO 

YT-83130



5/20

EN Trim clips assortment
PL Zestaw spinek samochodowych
DE Befestigungs-Clip-Satz
RU Набор автомобильного крепежа
CZ Sada přichytek čalounění
HU Kötőelemek szegecsek
RO Set clipsuri auto
FR Ensembles de clips en plastique auto
IT Set di clip per auto
ES Clip de plástico surtido
CN 塑料卡扣

300
PCS

6
TYPES
TYPY



 Renault

YATO 

YT-06651



20

EN Car fuse assortment
PL Zestaw bezpieczników
DE KFZ-Sicherungs-Set
RU Набор предохранителей
CZ Sada pojistek
HU Biztosítékészlet

RO Set sigurante
FR Ensemble de fusible
IT Kit di fusibili lamellari
ES Conjunto de fusibles
CN 保险插片

301
PCS

STANDARD

MINI

FUSE
PULLER
SZÁGACZ
BEZBIECZNIKÓW



Mini: 2 A (6 PCS), 3 A (6 PCS), 5 A (12 PCS), 7.5 A (10 PCS), 10 A (28 PCS), 15 A (24 PCS), 20 A (22 PCS), 25 A (10 PCS), 30 A (14 PCS), 35 A (6 PCS), 40 A (12 PCS); standard: 2 A (6 PCS), 3 A (6 PCS), 5 A (12 PCS), 7.5 A (10 PCS), 10 A (28 PCS), 15 A (24 PCS), 20 A (22 PCS), 25 A (10 PCS), 30 A (14 PCS), 35 A (6 PCS), 40 A (12 PCS); clip

YATO 

YT-83148



20

EN Car fuse assortment
PL Zestaw bezpieczników
DE KFZ-Sicherungs-Set
RU Набор предохранителей
CZ Sada pojistek
HU Biztosítékészlet

RO Set sigurante
FR Ensemble de fusible
IT Kit di fusibili lamellari
ES Conjunto de fusibles
CN 保险插片

121
PCS

MINI

FUSE
PULLER
SZÁGACZ
BEZBIECZNIKÓW



5 A, 10 A, 15 A, 20 A, 25 A, 30 A (x20 PCS)

YATO 

YT-83143



24

EN Trim clips assortment
PL Zestaw spinek samochodowych
DE Befestigungs-Clip-Satz
RU Набор автомобильного крепежа
CZ Sada přichytek čalounění
HU Kötőelemek szegecsek
RO Set clipsuri auto
FR Ensembles de clips en plastique auto
IT Set di clip per auto
ES Clip de plástico surtido
CN 塑料卡扣

360
PCS

18
TYPES
TYPY



 Toyota, Lexus

YATO 

YT-06650



20

EN Trim clips assortment
PL Zestaw spinek samochodowych
DE Befestigungs-Clip-Satz
RU Набор автомобильного крепежа
CZ Sada přichytek čalounění
HU Kötőelemek szegecsek
RO Set clipsuri auto
FR Ensembles de clips en plastique auto
IT Set di clip per auto
ES Clip de plástico surtido
CN 塑料卡扣

300
PCS

6
TYPES
TYPY



 Opel

YATO 

YT-06652



20



EN Trim clips assortment
 PL Zestaw spinek samochodowych
 DE Befestigungs-Clip-Satz
 RU Набор автомобильного крепежа
 CZ Sada příchytek čalounění
 HU Kötőelemek szegecsek
 RO Set clipsuri auto
 FR Ensembles de clips en plastique auto
 IT Set di clip per auto
 ES Clip de plástico surtido
 CN 塑料卡扣

345
PCS

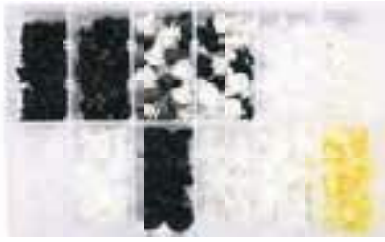
12
TYPES
TYPY

 Peugeot

YATO  
 YT-06653 20



EN Trim clips assortment
 PL Zestaw spinek samochodowych
 DE Befestigungs-Clip-Satz
 RU Набор автомобильного крепежа
 CZ Sada příchytek čalounění
 HU Kötőelemek szegecsek
 RO Set clipsuri auto
 FR Ensembles de clips en plastique auto
 IT Set di clip per auto
 ES Clip de plástico surtido
 CN 塑料卡扣

308
PCS

12
TYPES
TYPY



 Fiat

YATO  
 YT-06654 20

EN Trim clips assortment
 PL Zestaw spinek samochodowych
 DE Befestigungs-Clip-Satz
 RU Набор автомобильного крепежа
 CZ Sada příchytek čalounění
 HU Kötőelemek szegecsek
 RO Set clipsuri auto
 FR Ensembles de clips en plastique auto
 IT Set di clip per auto
 ES Clip de plástico surtido
 CN 塑料卡扣

350
PCS

12
TYPES
TYPY





 Volvo

YATO  
 YT-06655 20

EN Trim clips assortment
 PL Zestaw spinek samochodowych
 DE Befestigungs-Clip-Satz
 RU Набор автомобильного крепежа
 CZ Sada příchytek čalounění
 HU Kötőelemek szegecsek
 RO Set clipsuri auto
 FR Ensembles de clips en plastique auto
 IT Set di clip per auto
 ES Clip de plástico surtido
 CN 塑料卡扣

418
PCS

18
TYPES
TYPY



 Honda

YATO  
 YT-06656 20

EN Trim clips assortment
 PL Zestaw spinek samochodowych
 DE Befestigungs-Clip-Satz
 RU Набор автомобильного крепежа
 CZ Sada příchytek čalounění
 HU Kötőelemek szegecsek
 RO Set clipsuri auto
 FR Ensembles de clips en plastique auto
 IT Set di clip per auto
 ES Clip de plástico surtido
 CN 塑料卡扣

408
PCS

18
TYPES
TYPY





 Nissan

YATO  
 YT-06657 20



EN Trim clips assortment
 PL Zestaw spinek samochodowych
 DE Befestigungs-Clip-Satz
 RU Набор автомобильного крепежа
 CZ Sada příchytek čalounění
 HU Kötőelemek szegecsek
 RO Set clipsuri auto
 FR Ensembles de clips en plastique auto
 IT Set di clip per auto
 ES Clip de plástico surtido
 CN 塑料卡扣

475
PCS

18
TYPES
TYPY



 Mazda

YATO  
 YT-06658 20



EN Trim clips assortment
 PL Zestaw spinek samochodowych
 DE Befestigungs-Clip-Satz
 RU Набор автомобильного крепежа
 CZ Sada příchytek čalounění
 HU Kötőelemek szegecsek
 RO Set clipsuri auto
 FR Ensembles de clips en plastique auto
 IT Set di clip per auto
 ES Clip de plástico surtido
 CN 塑料卡扣

370
PCS

12
TYPES
TYPY





 Mitsubishi

YATO  
 YT-06659 20

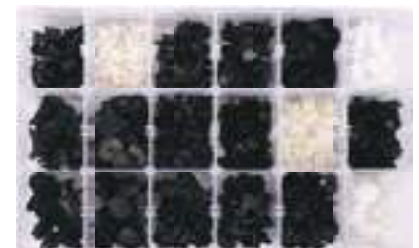

EN Trim clips assortment
 PL Zestaw spinek samochodowych
 DE Befestigungs-Clip-Satz
 RU Набор автомобильного крепежа
 CZ Sada příchytek čalounění
 HU Kötőelemek szegecsek
 RO Set clipsuri auto
 FR Ensembles de clips en plastique auto
 IT Set di clip per auto
 ES Clip de plástico surtido
 CN 塑料卡扣

415
PCS

18
TYPES
TYPY

 Ford

YATO  
 YT-06660 20

17

Welding equipment & accessories
Narzędzia spawalnicze i akcesoria



Welders
Spawarki

508



Spot weld cutter sets
Zestawy rozwiertaków do zgrzewów

511



Welding helmets & accessories
Przyłbice spawalnicze i akcesoria

509-510



Combination edge setters & hole punch pliers
Dziurkarko-felcarki

511



Welding workbenches
Stoliki spawalnicze

511



Magnetic holders
Wsporniki magnetyczne

511-513



EN Inverter welder
 PL Spawarka inwerterowa
 DE Inverter-Schweißgerät
 RU Инверторный сварочный аппарат
 CZ Invertorová svářečka
 HU Inverteres hegesztőgép
 RO Invertor sudura
 FR Poste à souder à onduleur
 IT Saldatrice inverter
 ES Soldadora inverter
 CN 电焊机



 IGBT	 CPU	 MMA
140 A	1.6~3.2 mm ELECTRODE ELEKTRODA	ANTI STICK FUNKCJA PRZECIWNIZWARCOWA
ARC FORCE STABILIZACJA ŁUKU	HOT START GORĄCY START	VRD
	 AUTO	 F WINDING INSULATION CLASS KLASA ISOLACJI ZWIĘZIENIA
		

- Suitable for acid and basic electrodes
- Hot start, anti-stick, self-adaptive arc-force

- Spawanie elektrodami kwasowymi i zasadowymi
- Funkcje ułatwiające zajarzenie łuku, oderwanie przywarłej elektrody oraz utrzymanie łuku

YATO 	Max. welding current / Maks. prąd spawania [A]	
YT-81355	140	1



EN Inverter welder
 PL Spawarka inwerterowa
 DE Inverter-Schweißgerät
 RU Инверторный сварочный аппарат
 CZ Invertorová svářečka
 HU Inverteres hegesztőgép
 RO Invertor sudura
 FR Poste à souder à onduleur
 IT Saldatrice inverter
 ES Soldadora inverter
 CN 电焊机



 IGBT	 CPU	 MMA
180 A	1.6~4.0 mm ELECTRODE ELEKTRODA	ANTI STICK FUNKCJA PRZECIWNIZWARCOWA
ARC FORCE STABILIZACJA ŁUKU	HOT START GORĄCY START	VRD
		 AUTO
 F WINDING INSULATION CLASS KLASA ISOLACJI ZWIĘZIENIA		

- Suitable for acid, basic and cellulosic electrodes
- MMA and TIG Lift welding (TIG welding accessories are not included)
- Adjustable hot start, anti-stick, adjustable arc-force

- Spawanie elektrodami kwasowymi, zasadowymi i celulozowymi
- Spawanie metodami MMA i TIG Lift (akcesoria do spawania TIG nie są dołączone)
- Funkcje ułatwiające zajarzenie łuku, oderwanie przywarłej elektrody oraz utrzymanie łuku

YATO 	Max. welding current / Maks. prąd spawania [A]	
YT-81357	180 (MMA), 180 (TIG lift)	1



EN Inverter welder
 PL Spawarka inwerterowa
 DE Inverter-Schweißgerät
 RU Инверторный сварочный аппарат
 CZ Invertorová svářečka
 HU Inverteres hegesztőgép
 RO Invertor sudura
 FR Poste à souder à onduleur
 IT Saldatrice inverter
 ES Soldadora inverter
 CN 电焊机



 PFC	 IGBT	 CPU
 MMA	200 A	1.6~4.0 mm ELECTRODE ELEKTRODA
ANTI STICK FUNKCJA PRZECIWNIZWARCOWA	ARC FORCE STABILIZACJA ŁUKU	HOT START GORĄCY START
VRD		 PULSE
	 AUTO	 F WINDING INSULATION CLASS KLASA ISOLACJI ZWIĘZIENIA
		

- Suitable for acid, basic and cellulosic electrodes
- MMA and TIG Lift welding (TIG welding accessories are not included)
- Adjustable hot start, anti-stick, adjustable arc-force

- Spawanie elektrodami kwasowymi, zasadowymi i celulozowymi
- Spawanie metodami MMA i TIG Lift (akcesoria do spawania TIG nie są dołączone)
- Funkcje ułatwiające zajarzenie łuku, oderwanie przywarłej elektrody oraz utrzymanie łuku

YATO 	Max. welding current / Maks. prąd spawania [A]	
YT-81358	85 (MMA), 200 (TIG lift)	1

EN Auto-darkening welding helmet
PL Przyłbica spawalnicza samościemniająca
DE Selbstverdunkelnde Schweißmaske
RU Маска сварщика с автозатемнением
CZ Samostmívací svářecí kukla
HU Magától sötétedő hegesztőpajzs
RO Mască de sudură auto-intunecare
FR Masque de soudure automatique
IT Maschera per saldatura autoscurante
ES Pantalla de soldar con oscurecimiento automático
CN 自动变光焊帽



- In accordance with standard EN 379
- Optical class: 1/1/1/1
- Cover lens YT-73924 included
- Zgodność z normą EN 379
- Klasa optyczna: 1/1/1/1
- W zestawie szybki ochronne YT-73924

TRUE COLOR	DIN 5-8/9-13	SHADE ŚCIEMNIANIE	DIN 4	OPTICAL CLASS KLASA OPTYCZNA	4 ARC SENSOR CZUJNIKI ŁUKU
0.3-1.0 ms	SENSITIVITY CZUŁOŚĆ	0.1-1.0s	DELAY OPOŹNIENIE	FILTER TEST TEST FILTRA	DIN 16 UV/IR
SOLAR CELL OGNiWO SŁONECZNE	2x CR2450	LOW BATTERY ALARM Wskaznik poziomU BATERii	4-POINT HEADGEAR WIEŻBA 4-PUNKTOWA	AUTO ON / OFF AUTO WL. WYŁ.	°C -5 +55
MIG/MAG MMA/TIG	GRINDING SZLIFOWANIE	CUTTING CIĘCIE			

4 POINT HEADGEAR
WIEŻBA 4 PUNKTOWA

Lock into a detent when lifted
Blokada w pozycji podniesionej

2-point crown strap adjustment to rise or lower the helmet
2 punktowa regulacja wysokości

3 position slider to adjust the distance from eyes to lens
3 pozycje regulacji odległości od filtra

Regulation at the occipital area
Regulacja pozycji potylicznej

Ratchet with soft rubber grip to adjust size without removing the helmet
Regulacji obwodu za pomocą systemu grzechotkowego

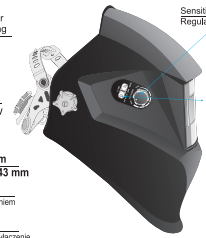
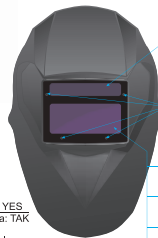
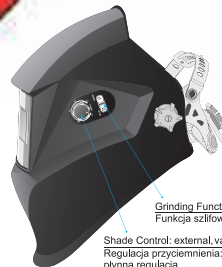
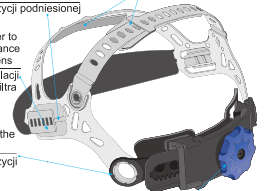

Grinding Function: YES
Funkcja szlifowania: TAK

Shade Control: external, variable
Regulacja przyciemnienia: zewnętrzna, płynna regulacja

Solar cell filter power supply during welding
OgniwO słoneczne zasila filtrO podczas spawania

Arc Sensor: 4
Liczba czujnikÓw łuku: 4

Viewing Area: 98x43 mm
Obszar pola widzenia: 98x43 mm

UV/IR Protection
Ochrona przed promieniowaniem UV/IR

Automatic power on / off
Automatyczne włączenie / wyłączenie

Sensitivity Control
Regulacja czułości

The rate of dimming
Szybkość ściemniania 0.3 - 1.0 ms

YATO

YT-73921

6

EN Auto-darkening welding helmet
PL Przyłbica spawalnicza samościemniająca
DE Selbstverdunkelnde Schweißmaske
RU Маска сварщика с автозатемнением
CZ Samostmívací svářecí kukla
HU Magától sötétedő hegesztőpajzs
RO Mască de sudură auto-intunecare
FR Masque de soudure automatique
IT Maschera per saldatura autoscurante
ES Pantalla de soldar con oscurecimiento automático
CN 自动变光焊帽

TRUE COLOR	DIN 5-8/9-13	SHADE ŚCIEMNIANIE	DIN 4	OPTICAL CLASS KLASA OPTYCZNA	100x68 mm
4 ARC SENSOR CZUJNIKI ŁUKU	1/25000s REACTION TIME CZAS REAKCJI	SENSITIVITY CZUŁOŚĆ	0.2-1.0s DELAY OPOŹNIENIE	FILTER TEST TEST FILTRA	
DIN 16 UV/IR	SOLAR CELL OGNiWO SŁONECZNE	1x CR2450	USB CHARGING ŁADOWANIE	LOW BATTERY ALARM Wskaznik poziomU BATERii	4-POINT HEADGEAR WIEŻBA 4-PUNKTOWA
MIG/MAG MMA/TIG	GRINDING AND WELDING SZLIFOWANIE I SPAWANIE	CUTTING CIĘCIE			

EN Auto-darkening welding helmet
PL Przyłbica spawalnicza samościemniająca
DE Selbstverdunkelnde Schweißmaske
RU Маска сварщика с автозатемнением
CZ Samostmívací svářecí kukla
HU Magától sötétedő hegesztőpajzs
RO Mască de sudură auto-intunecare
FR Masque de soudure automatique
IT Maschera per saldatura autoscurante
ES Pantalla de soldar con oscurecimiento automático
CN 自动变光焊帽

TRUE COLOR	DIN 5-9/9-13	SHADE ŚCIEMNIANIE	DIN 4	OPTICAL CLASS KLASA OPTYCZNA	100x97 mm
4 ARC SENSOR CZUJNIKI ŁUKU	1/25000s REACTION TIME CZAS REAKCJI	SENSITIVITY CZUŁOŚĆ	0.2-1.0s DELAY OPOŹNIENIE	FILTER TEST TEST FILTRA	
DIN 16 UV/IR	SOLAR CELL OGNiWO SŁONECZNE	1x CR2450	LOW BATTERY ALARM Wskaznik poziomU BATERii	4-POINT HEADGEAR WIEŻBA 4-PUNKTOWA	MIG/MAG MMA/TIG
GRINDING AND WELDING SZLIFOWANIE I SPAWANIE	CUTTING CIĘCIE				



YATO
YT-73930

6

YATO
YT-73932

6

- EN Auto-darkening welding helmet
- PL Przyłbica spawalnicza samościemniająca
- DE Selbstverdunkelnde Schweißmaske
- RU Маска сварщика с автозатемнением
- CZ Samostmívací svářecí kukla
- HU Magától sötétedő hegesztőpajzs
- RO Mască de sudură auto-întunecare
- FR Masque de soudure automatique
- IT Maschera per saldatura autoscurante
- ES Pantalla de soldar con oscurecimiento automático
- CN 自动变光焊帽



TRUE COLOR	DIN 5-9/9-13	SHADE SCHEMANNEN	DIN 4	1 1 1 1 OPTICAL CLASS KLASA OPTYCZNA	100x60 mm
4 ARC SENSOR CZUJNIKI ŁUKU	1/25000s REACTION TIME CZAS REAKCJI	SENSITIVITY CZUŁOŚĆ	0,2-1,0s	DELAY OPÓŹNIENIE	FILTER TEST TEST FILTRA
DIN 16 UV/IR	SOLAR CELL OGNIWKO SŁONECZNE	2x CR2032	LOW BATTERY ALARM WISZĄCEK POZIOMU BATERII	4-POINT HEADGEAR WIEŻBA 4-PUNKTOWA	MIG/MAG MMA/TIG
			GRINDING AND WELDING SZLIFOWANIE I SPAWANIE	CUTTING CIĘCIE	

- In accordance with standard EN 379
- Optical class: 1/1/1/1
- Zgodność z normą EN 379
- Klasa optyczna: 1/1/1/1

YATO	YT-73934		6
-------------	-----------------	--	----------

- EN Front cover lens
- PL Szybka ochronna do przyłbicy samościemniającej
- DE Glas für Schweißmaske
- RU Сменная линза для сварочной маски
- CZ Přední krycí sklo ke kukle
- HU Külső védőlemez
- RO Vizor protecție mască sudură
- FR Verre pour masque de soudure
- IT Lente per casco da saldatura
- ES Lente recambio para pantalla soldar
- CN 焊帽镜片



	270x125 mm	PC	
--	-------------------	-----------	--

For YT-73930
Dla YT-73930
TYPE EN 166:2001 F

YATO	YT-73931		200
-------------	-----------------	--	------------

- EN Front cover lens
- PL Szybka ochronna do przyłbicy samościemniającej
- DE Glas für Schweißmaske
- RU Сменная линза для сварочной маски
- CZ Přední krycí sklo ke kukle
- HU Külső védőlemez
- RO Vizor protecție mască sudură
- FR Verre pour masque de soudure
- IT Lente per casco da saldatura
- ES Lente recambio para pantalla soldar
- CN 焊帽镜片

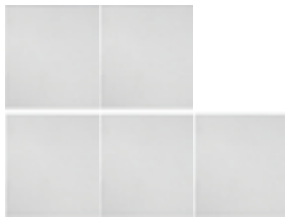

5 PCS		139x122 mm	PC	
--------------	--	-------------------	-----------	--

- EN Front cover lens
- PL Szybka ochronna do przyłbicy samościemniającej
- DE Glas für Schweißmaske
- RU Сменная линза для сварочной маски
- CZ Přední krycí sklo ke kukle
- HU Külső védőlemez
- RO Vizor protecție mască sudură
- FR Verre pour masque de soudure
- IT Lente per casco da saldatura
- ES Lente recambio para pantalla soldar
- CN 焊帽镜片



5 PCS		136x122 mm	PC	
--------------	--	-------------------	-----------	--

For YT-73932
Dla YT-73932
TYPE EN 166:2001 F

For YT-73932
Dla YT-73932
TYPE EN 166:2001 F

YATO	YT-73933		120
-------------	-----------------	--	------------

YATO	YT-73935		120
-------------	-----------------	--	------------

- EN Front cover lens
- PL Szybka ochronna do przyłbicy samościemniającej
- DE Glas für Schweißmaske
- RU Сменная линза для сварочной маски
- CZ Přední krycí sklo ke kukle
- HU Külső védőlemez
- RO Vizor protecție mască sudură
- FR Verre pour masque de soudure
- IT Lente per casco da saldatura
- ES Lente recambio para pantalla soldar
- CN 焊帽镜片



5 PCS		123x98 mm	PC	
--------------	--	------------------	-----------	--

- EN Front cover lens
- PL Szybka ochronna do przyłbicy samościemniającej
- DE Glas für Schweißmaske
- RU Сменная линза для сварочной маски
- CZ Přední krycí sklo ke kukle
- HU Külső védőlemez
- RO Vizor protecție mască sudură
- FR Verre pour masque de soudure
- IT Lente per casco da saldatura
- ES Lente recambio para pantalla soldar
- CN 焊帽镜片



5 PCS		137x120 mm	1.0 mm	PC	
--------------	--	-------------------	---------------	-----------	--

For YT-73921
Dla YT-73921
TYPE FC-11 EN 166:2001 B

For YT-73925, YT-73926, 74484
Dla YT-73925, YT-73926, 74484
TYPE EN 166:2001 F

YATO	YT-73924		20/160
-------------	-----------------	--	---------------

YATO	YT-73929	Filter size / Rozmiar filtra [mm]		20
-------------	-----------------	--	--	-----------

EN Welding workbench
PL Stolik spawalniczy składany
DE Schweißstisch zusammenklappbar
RU Складной сварочный стол
CZ Svářečský stůl skládaný
HU Összecsukható hegesztőasztal
RO Banc de lucru pt. sudura
FR Table de soudage pliante
IT Banco per saldatura pieghevole
ES Mesa de soldadura plegable
CN 焊接工作台

660x590
x830
mm

max
150kg



YATO	Dimensions / Wymiary [mm]	
YT-08950	660x590x830	1

EN Spot weld drill bits set
PL Zestaw wiertel do zgrzewów punktowych
DE Schweißpunkt-Fräasersatz
RU Набор сверл для точечной сварки
CZ Frézy pro bodové sváry
HU Ponthegesztés lefűró készlet
RO Set burghie pt. puncte de sudură
FR Forets à dépointer les points soudure
IT Set di alesatori per punti di saldatura
ES Juego de brocas para puntos de soldadura
CN 点焊钻

3
PCS

COBALT
COATED
POKRYTE
KOBALTEM



Ø 6.5, 8, 10 mm

YATO	Ø [mm]	
YT-28921	6.5, 8, 10	50

EN Combination edge setter / hole punch pliers
PL Dziurkarko-felcarka
DE Kombinierte Absetzange Lochzange
RU Дырокол, кромокгиб
CZ Falcovačka a děrovačka
HU Lyukasztó peremező fogó

RO Cleste pt. fasonat si gaurit tabla
FR Pince spéciale perforatrice carrosserie
IT Combinazione: bordo setter / pinza perforare
ES Solapadora y ponchadora manual
CN 折边冲孔钳



13 mm
22 mm
20 mm
Ø 5 mm



YATO	
YT-21582	10

EN Spot weld cutter & drill bit set
PL Zestaw rozwiertaków do zgrzewów punktowych
DE Schweißpunktfräser-Satz
RU Набор для высверливания точечной сварки
CZ Sada na odvrtání bodových svárů
HU Hegesztőpont maró készlet
RO Set de freze pt. suduri în puncte
FR Jeu de fraises pour points de soudage
IT Set di alesatori per punti di saldatura
ES Juego de puntos de soldadura de la fresa
CN 电焊钻

9
PCS

10
mm

8
mm

HSS



YATO	
YT-28920	10/60

EN Spot weld cutter & drill bit set
PL Zestaw rozwiertaków do zgrzewów punktowych
DE Schweißpunktfräser-Satz
RU Набор для высверливания точечной сварки
CZ Sada na odvrtání bodových svárů
HU Hegesztőpont maró készlet
RO Set de freze pt. suduri în puncte
FR Jeu de fraises pour points de soudage
IT Set di alesatori per punti di saldatura
ES Juego de puntos de soldadura de la fresa
CN 电焊钻

9
PCS

8
mm

10
mm



YATO	
YT-28919	10/60

EN Spot weld drill bits set
PL Zestaw wiertel do zgrzewów punktowych
DE Schweißpunkt-Fräasersatz
RU Набор сверл для точечной сварки
CZ Frézy pro bodové sváry
HU Ponthegesztés lefűró készlet
RO Set burghie pt. puncte de sudură
FR Forets à dépointer les points soudure
IT Set di alesatori per punti di saldatura
ES Juego de brocas para puntos de soldadura
CN 点焊钻

4
PCS

COBALT
COATED
POKRYTE
KOBALTEM

TITANUM
COATED
POWŁOKA
TYTANOWA



Ø 6.5 mm (L=45 mm), Ø 8 mm (L=45 mm, 79 mm), Ø 10 mm (L=45 mm)

YATO	Ø [mm]	
YT-28922	6.5, 8 x2, 10	30

EN Adjustable angle welding magnet
PL Wspornik magnetyczny spawalniczy regulowany
DE Verstellbarer Magnet-Werkstückhalter
RU Регулируемый магнит заварки угла
CZ Polohovací magnetický držák ke svařování
HU Állítható, mágneses, hegesztő támasz

RO Dispozitiv magnetic reglabil pt. sudura
FR Support magnétique de soudure
IT Supporto della saldatura magnetico
ES Soporte magnético de soldadura, ajustable
CN 焊接磁铁



max
2x22,2kg

360°



YATO	Lifting capacity / Udźwig [kg]	Dimensions / Wymiary [mm]	
YT-0862	2x22.5	85x65x22	6

EN Magnetic welding holder
 PL Kątownik magnetyczny spawalniczy
 DE Magnet-Werkstückhalter
 RU Магнитная струбцина заварки
 CZ Magnetický uhelník ke svařování
 HU Mágneses, hegesztő szögvas
 RO Dispozitiv magnetic fixare pt. sudura
 FR Support magnétique de soudure
 IT Angolo magnetico da saldatura
 ES Escuadra magnética de soldadura
 CN 焊接磁铁

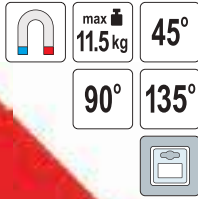

EN Magnetic welding holder
 PL Kątownik magnetyczny spawalniczy
 DE Magnet-Werkstückhalter
 RU Магнитная струбцина заварки
 CZ Magnetický uhelník ke svařování
 HU Mágneses, hegesztő szögvas
 RO Dispozitiv magnetic fixare pt. sudura
 FR Support magnétique de soudure
 IT Angolo magnetico da saldatura
 ES Escuadra magnética de soldadura
 CN 焊接磁铁

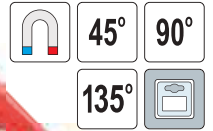

YATO	Lifting capacity / Udźwig [kg]	Hole diameter / Średnica otworu [mm]	Dimensions / Wymiary [mm]	
YT-0864	22.5	28	102x155x17	6/30
YT-0865	34	46	122x190x25	6/18

EN Magnetic welding holder
 PL Kątownik magnetyczny spawalniczy
 DE Magnet-Werkstückhalter
 RU Магнитная струбцина заварки
 CZ Magnetický uhelník ke svařování
 HU Mágneses, hegesztő szögvas
 RO Dispozitiv magnetic fixare pt. sudura
 FR Support magnétique de soudure
 IT Triangolo magnetico da saldatura con interruttore
 ES Escuadra magnética de soldadura
 CN 焊接磁铁

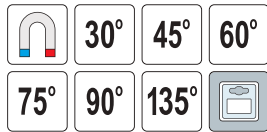

EN Mini welding magnet holder set
 PL Zestaw spawalniczych kątowników magnetycznych mini
 DE Mini-Magnetschweißwinkel-Set
 RU Набор сварочных магнитных угловых профилей мини
 CZ Sada svařovacích magnetických uhelníků mini
 HU Mini mágneses hegesztési derékszög készlet
 RO Set minimagnetici pt. sudura
 FR Kit de cornières magnétiques de soudage mini
 IT Set di posizionatori magnetici mini per saldatura
 ES Juego de escuadras de soldadura magnéticas mini
 CN 迷你磁性电焊架



YATO	Lifting capacity / Udźwig [kg]	Dimensions / Wymiary [mm]	
YT-08677	4.5	43x72x12	12/36

EN Welding magnet holder set
 PL Zestaw spawalniczych kątowników magnetycznych
 DE Magnetschweißwinkel-Set
 RU Набор сварочных магнитных угловых профилей
 CZ Sada svařovacích magnetických uhelníků
 HU Mágneses hegesztési derékszög készlet
 RO Set magnetici pt. sudura
 FR Kit de cornières magnétiques de soudage
 IT Set di posizionatori magnetici per saldatura
 ES Juego de escuadras de soldadura magnéticas
 CN 磁性电焊架

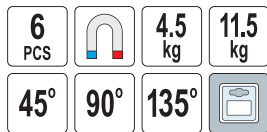

EN Welding magnet holder set
 PL Zestaw spawalniczych kątowników magnetycznych
 DE Magnetschweißwinkel-Set
 RU Набор сварочных магнитных угловых профилей
 CZ Sada svařovacích magnetických uhelníků
 HU Mágneses hegesztési derékszög készlet
 RO Set magnetici pt. sudura
 FR Kit de cornières magnétiques de soudage
 IT Set di posizionatori magnetici per saldatura
 ES Juego de escuadras de soldadura magnéticas
 CN 焊接定位器套装

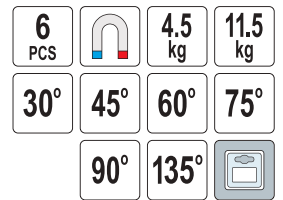

YATO	Lifting capacity / Udźwig [kg]	Dimensions / Wymiary [mm]	
YT-08679	4.5, 11.5	43x72x12, 68x102x14, 82x118x14	10

YATO	Lifting capacity / Udźwig [kg]	Dimensions / Wymiary [mm]	
YT-08678	4.5, 11.5	43x72x12, 82x118x14	6/18

EN Magnetic welding holder set
PL Zestaw magnetycznych uchwytów spawalniczych
DE Magnetschweißhalter-Set
RU Комплект магнитных сварочных ручек
CZ Sada magnetických svařovacích úchytů
HU Mágneses hegesztő tartó készlet

RO Set suporti magnetici sudura
FR Kit positionneur magnétique de soudure
IT Kit di pinze magnetiche per saldatura
ES Set de portaelectrodos magnéticos
CN 焊接磁铁

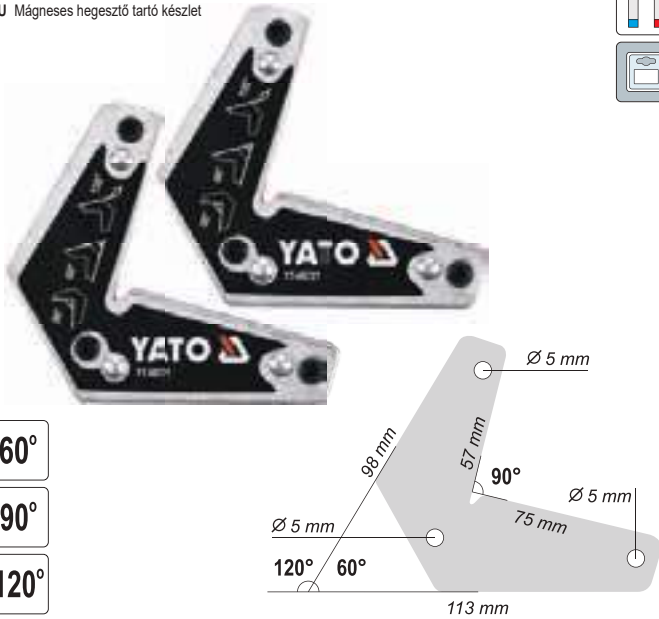

60°

90°

120°

YATO	Lifting capacity / Udźwig [kg]	Size / Rozmiar [mm]	
YT-08721	10	98x113	6/24

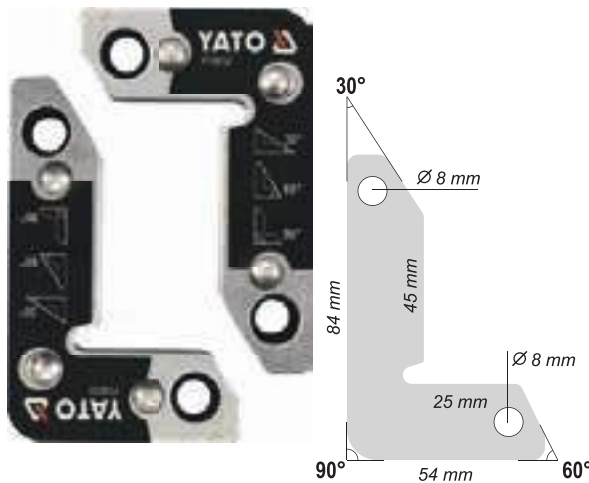

30°

60°

90°

YATO	Lifting capacity / Udźwig [kg]	Size / Rozmiar [mm]	
YT-08722	25	54x84	10/40

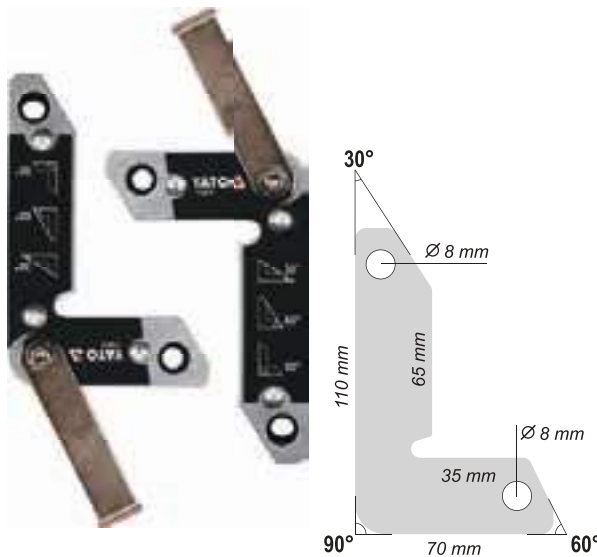

32
kg

30°

60°

90°

YATO	Lifting capacity / Udźwig [kg]	Size / Rozmiar [mm]	
YT-08723	32	70x110	6/24

EN Magnetic welding ground
PL Spawalniczy zacisk uziemiający
DE Schweißerdungsklemme
RU Сварочный зажим заземляющий
CZ Svařovací svorka zemnicí
HU Földelő csatlakozó hegesztőhöz
RO Suport sudura magnetic
FR Pince de masse pour soudure
IT Morsetti di terra per saldatura
ES Pinza de tierra para soldadura
CN 磁性焊接接地夹

85
mm



max
7 kg

max
500 A



YATO
YT-08625

6/24

EN MIG torch magnetic holder
PL Podstawka magnetyczna do uchwytu MIG
DE Magnetsockel für MIG-Halter
RU Магнитная подставка для держателя MIG
CZ Magnetický podstavec k držáku MIG
HU Mágneses alátét MIG fogantyúhoz
RO Suport magnetic pt. portelectrod MIG
FR Base magnétique pour le support MIG
IT Supporto per pistola MIG con base magnetica
ES Base magnética para el soporte MIG
CN 焊枪支架

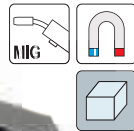

YATO
YT-08710

12

EN TIG torch magnetic holder
PL Podstawka magnetyczna do uchwytu TIG
DE Magnetsockel für TIG-Halter
RU Магнитная подставка для держателя TIG
CZ Magnetický podstavec k držáku TIG
HU Mágneses alátét TIG fogantyúhoz
RO Suport magnetic pt. portelectrod TIG
FR Base magnétique pour le support TIG
IT Supporto per pistola TIG con base magnetica
ES Base magnética para el soporte TIG
CN 氩弧焊焊枪支架















YATO
YT-08711

12

18

Power & gasoline tools
Elektronarz dzia
i narz dzia spalinowe





Cordless tools Narzędzia akumulatorowe		517-531	Demolition hammers Młoty wyburzeniowe		541
Gasoline construction tools Budowlane narzędzia spalinowe		532	Concrete vibrator sets & accessories Wibratory do betonu i akcesoria		542
Straight grinders Szlifierki proste		532	Paint & mortar mixers Mieszarki do zapraw i farb		543
Angle grinders & accessories Szlifierki kątowe i akcesoria		532-536	Circular saws & accessories Pilarki tarczowe i akcesoria		543
Concrete grinders Szlifierki do betonu		536	Miter saws Ukośnice		544-545
Nibblers & accessories Nożyce do blachy i akcesoria		537	Bench tools Elektronarzędzia stołowe		545
Wall chasers Bruzdownice		537	Jig saws Wyrzynarki		545
Concrete cutters Przecinarki do betonu		537	Planers Strugi		546
Tile cutters Przecinarki do ceramiki		537-538	Routers Frezarki		546
Car polishers Polerki samochodowe		538	Belt sanders Szlifierki taśmowe		547
Cut-off machines Przecinarki do metalu		538	Sabre saws Piły szablaste		547
Drilling machines Wiertarki		538-539	Orbital sanders Szlifierki mimośrodowe		547
Drywall screwdrivers Wkrętarki do regipsów		540	Finishing sanders Szlifierki oscylacyjne		547
Diamond drills Wiertnice diamentowe		540	Burnishing machines & accessories Satyniarki i akcesoria		548
Rotary hammers Młotowiertarki		540-541	Drywall sanders & accessories Szlifierki do gładzi i tynków oraz akcesoria		548-549

Painting tools & accessories Narzędzia do malowania i akcesoria		550-551
--	---	---------

Multi-purpose oscillating tools Wielofunkcyjne narzędzia oscylacyjne		551
---	---	-----

Vacuum cleaners & accessories Odkurzacze i akcesoria		552-554
---	---	---------

Wallpaper strippers Parownice do tapet		554
---	---	-----

Knives Noże		554
----------------	---	-----

Hot air guns Opalarki		555-556
--------------------------	---	---------

Blowers Dmuchawy		556
---------------------	--	-----

Glue guns Pistolety do klejenia		556
------------------------------------	---	-----

Generators Generatory		557
--------------------------	---	-----

Portable power stations Przenośne źródła zasilania		557-558
---	---	---------

Heaters Nagrzewnice		558-560
------------------------	---	---------

Dehumidifiers Osuszacze budowlane		560
--------------------------------------	---	-----

Pumps & accessories Pompy i akcesoria		560-564
--	---	---------

Pressure washers Myjki ciśnieniowe		564
---------------------------------------	---	-----

Cordless garden tools & accessories Ogrodowe narzędzia akumulatorowe i akcesoria		564-570
---	---	---------

Cordless pressure washers Akumulatorowe myjki ciśnieniowe	564
Cordless blowers Dmuchawy akumulatorowe	565
Cordless sprayers Spryskiwacze akumulatorowe	565
Cordless grass trimmers & accessories Akumulatorowe wykaszarki i akcesoria	566
Cordless pruning shears Sekatory akumulatorowe	567
Cordless grass and shrub shears Akumulatorowe nożyce do trawy i krzewów	567
Cordless hedge trimmers Akumulatorowe nożyce do żywopłotu	567
Cordless chainsaws Akumulatorowe piłarki łańcuchowe	569
Cordless lawn mowers Kosiarki akumulatorowe	569
Cordless tillers Glebogryzarki akumulatorowe	570

Electric garden tools Ogrodowe narzędzia elektryczne		570-573
---	---	---------

Electric grass trimmers Wykaszarki elektryczne	570
Electric chainsaws Piłarki elektryczne	570
Electric lawn mowers Kosiarki elektryczne	571
Electric tillers Glebogryzarki elektryczne	572
Electric scarifiers Wertykulatory elektryczne	572
Electric brushes Szczotki elektryczne	572
Electric blowers Dmuchawy elektryczne	572
Accessories Akcesoria	573

Gasoline garden tools & accessories Ogrodowe narzędzia spalinowe i akcesoria		573-586
---	---	---------



Gasoline sprayers Opryskiwacze spalinowe	573
Gasoline earth augers & accessories Wiertnice glebowe i akcesoria	573
Gasoline chainsaws Piłarki spalinowe	574
Gasoline brushcutters Kosy spalinowe	574
Gasoline lawn mowers Kosiarki spalinowe	575
Gasoline scarifiers Wertykulatory spalinowe	576
Gasoline tillers Glebogryzarki spalinowe	576
Gasoline sweepers & accessories Zamiatarki spalinowe i akcesoria	577
Gasoline shredders Rozdrabniacze spalinowe	577
Accessories Akcesoria	578

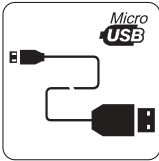

- EN Cordless precision screwdriver set
PL Precyzyjny wkrętak akumulatorowy z bitami
DE Präzisions-Akkuschrauber mit Bits
RU Прецизионная аккумуляторная отвертка с битами
CZ Přesný aku šroubovák s bity
HU Precíz akkumulátoros csavarozó bitfejekkel
RO Set șurubelniță de precizie cu acumulator
FR Tournevis sans-fil de précision avec embouts
IT Cacciavite a batteria di precisione con punte
ES Atornillador de batería preciso con bits
CN 电动钟表批组套







39
PCS

3.6 V
750mAh
Li-Ion

 









 



LED
LIGHT
DIPDA

USB
CABLE
KABEL

CrV 

-  2.5, 3.0, 3.5, 4.0, 4.5 mm (L=28 mm); CrV;
 1.2, 1.6, 2.0, 2.4, 3.0 mm (L=28 mm); CrV;
 PH000, PH00, PH0, PH1 x2 (L=28 mm); CrV;
 PZ0 x2, PZ1 x2 (L=28 mm); CrV;
 T4, T5, T6, T7, T8, T9, T10 (L=28 mm); CrV;
 1.5, 2.0, 2.5, 3.0, 4.0 mm (L=28 mm); CrV;
 S0, S1, S2, S3 (L=28 mm); CrV;
 60 mm; CrV;
 120 mm; CrV

$L_{pA} = 45,6 \pm 3,0$ dB; $L_{wA} = 56,6 \pm 3,0$ dB; $a_h = 0,21 \pm 1,5$ m/s²

YATO 	[V d.c.]	
YT-27930	3.6	8

- EN Cordless mini grinder
PL Miniszlifierka akumulatorowa
DE Akku-Mini-Schleifmaschine
RU Гравер аккумуляторный
CZ Akumulátorová mini bruska
HU Akkus mini köszörű
RO Mini freză cu acumulator
FR Mini meuleuse sans fil
IT Mini smerigliatrice a batteria
ES Miniamoladora a batería
CN 锂电迷你电磨



52
PCS

3.6 V
1500mAh
Li-Ion

 5000-18000
min⁻¹



 2.3 mm
3.2 mm
Ø

LED
LIGHT
DIPDA

USB
CABLE
KABEL

$L_{pA} = 79,0 \pm 3,0$ dB; $L_{wA} = 90,0 \pm 3,0$ dB; $a_h = 1,177 \pm 1,5$ m/s²

YATO 	[V d.c.]	
YT-82763	3.6	20

- EN Mini grinder
PL Miniszlifierka
DE Mini-Schleifmaschine
RU Гравер электрический
CZ Mini bruska
HU Mini köszörű
RO Mini freză electrică
FR Mini meuleuse
IT Mini smerigliatrice
ES Miniamoladora
CN 电磨

83
PCS

220-240V~
50Hz

130
W

 10000-35000
min⁻¹

 2.3 mm
3.2 mm
Ø

LED
LIGHT
DIPDA





$L_{pA} = 80,5 \pm 3,0$ dB; $L_{wA} = 91,5 \pm 3,0$ dB; $a_h = 2,197 \pm 1,5$ m/s²

YATO 	[W]	
YT-82077	130	10

EN Cordless drill/driver
 PL Akumulatorowa wiertarko-wkrętarka
 DE Akku-Bohrschrauber
 RU Аккумуляторная дрель-шуруповёрт
 CZ Akumulátorový vrtací šroubovák
 HU Akkus fűró-csavarozó
 RO Mașină de găurit și înșurubat cu acumulator
 FR Perceuse-visseuse sans-fil
 IT Trapano avvitatore a batteria
 ES Taladro atornillador a batería
 CN 充电式电钻

12V
Li-Ion
30 Nm
0-400 min¹
0-1300 min²
0.8-10mm
2.0 Ah
1h
III



$L_{pa} = 71,50 \pm 5,0$ dB; $L_{wa} = 82,50 \pm 5,0$ dB; $a_n = 2,70 \pm 1,5$ m/s²



YATO	[V d.c.]	
YT-82901	12	5

EN Cordless ratchet
 PL Grzechotka akumulatorowa
 DE Akku-Ratsche
 RU Аккумуляторные импульсная трещотка
 CZ Akumulátorová ráčna
 HU Akkus ütvecsavarozó

RO Antrenor cu acumulator
 FR Clé à cliquet sans-fil
 IT Cricchetto a batteria
 ES Llave de carraca a batería
 CN 充电式扳手

12V
Li-Ion
3/8" 9.5 mm
45 Nm
0-250 min¹
2.0 Ah
1h
III

IMPACT FUNCTION
FUNKCJA UDARU



3/8" (9.5 mm): 12, 13, 14, 17 mm;
 1/2" (12.7 mm)

$L_{pa} = 78,66 \pm 3,0$ dB; $L_{wa} = 89,66 \pm 3,0$ dB; $a_n = 2,898 \pm 1,5$ m/s²

YATO	[V d.c.]	
YT-82902	12	10

EN Cordless polisher
 PL Polerka akumulatorowa
 DE Akku-Polierer
 RU Аккумуляторная полировальная машина
 CZ Akumulátorová leštička
 HU Akkus polírozógép
 RO Aparat de polișat cu acumulator
 FR Polisseuse sans-fil
 IT Lucidatrice a batteria
 ES Pulidora a batería
 CN 充电式抛光机

12V
Li-Ion
5/16" 8 mm
0-2800 min¹
0-8300 min²
80 mm
2.0 Ah
1h
III



$L_{pa} = 78,6 \pm 3,0$ dB; $L_{wa} = 89,6 \pm 3,0$ dB; $a_n = 4,213 \pm 1,5$ m/s²

YATO	[V d.c.]	
YT-82903	12	5

EN Cordless angle grinder
 PL Akumulatorowa szlifierka kątowa
 DE Akku-Winkelschleifer
 RU Аккумуляторная угловая шлифмашина
 CZ Akumulátorová úhlová bruska
 HU Akkus sarokcsiszoló
 RO Polizor unghiular cu acumulator
 FR Meuleuse angulaire sans-fil
 IT Smerigliatrice angolare a batteria
 ES Amoladora angular a batería
 CN 充电式角磨

12V
Li-Ion
19500 min¹
76x10 mm
BRUSHLESS MOTOR
SIŁNIK BEZ SZCZĘTKOWY



• Spindle lock for easy blade change
 • Blokada wrzeciona dla łatwej wymiany tarczy

$L_{pa} = 68,5 \pm 3,0$ dB; $L_{wa} = 79,5 \pm 3,0$ dB; $a_n = 1,23 \pm 1,5$ m/s²

Battery not included
 Ohne Akku / Bez akumulatora
 Bez Gamapeu / Bez aku
 Akumulátor nélkül
 Fără baterie / Sans batterie
 Senza batteria / Sin batería
 没有电池

YATO	[V d.c.]	
YT-82905	12	5

EN Cordless ratchet
 PL Grzechotka akumulatorowa
 DE Akku-Ratsche
 RU Аккумуляторные импульсная трещотка
 CZ Akumulátorová ráčna
 HU Akkus ütvecsavarozó

RO Antrenor fără acumulator
 FR Clé à cliquet sans-fil
 IT Cricchetto a batteria
 ES Llave de carraca a batería
 CN 充电式扳手

12V
Li-Ion
1/2" 12.7 mm
80 Nm
0-170 min¹
IMPACT FUNCTION
FUNKCJA UDARU
BRUSHLESS MOTOR
SIŁNIK BEZ SZCZĘTKOWY



Battery not included
 Ohne Akku / Bez akumulatora
 Bez Gamapeu / Bez aku
 Akumulátor nélkül
 Fără baterie / Sans batterie
 Senza batteria / Sin batería
 没有电池

$L_{pa} = 78,7 \pm 3,0$ dB; $L_{wa} = 89,7 \pm 3,0$ dB; $a_n = 7,373 \pm 1,5$ m/s²

YATO	[V d.c.]	
YT-829021	12	10

EN Cordless sabre saw
 PL Akumulatorowa piła szablasta
 DE Akku-Säbelsäge
 RU Аккумуляторная сабельная пила
 CZ Akumulátorová píla ocaska
 HU Akkus szabályfűrész
 RO Fierăstrău sabie cu acumulator
 FR Scie sabre sans-fil
 IT Sega a gattuccio a batteria
 ES Sierra sable de batería
 CN 充电式往复锯

12V
Li-Ion
0-3000 min¹



2.0 Ah
1h
III

WOOD SHEARING

STEEL STAL

PVC

$L_{pa} = 83,58 \pm 3,0$ dB; $L_{wa} = 94,58 \pm 3,0$ dB; $a_n = 12,86 \pm 1,5 / 10,13 \pm 1,5 / 13,78 \pm 1,5 / 11,92 \pm 1,5$ m/s²

YATO	[V d.c.]	
YT-82904	12	6

EN Battery
PL Akumulator
DE Akkumulator
RU Аккумулятор
CZ Akumulátor
HU Akkumulátor

RO Acumulator
FR Batterie
IT Batteria
ES Batería
CN 锂电池包

12V
Li-Ion
2.0 Ah
1h
[Icon: Battery pack]



YATO [V d.c.] [Icon: Battery pack]
YT-82909 12 40

EN Battery
PL Akumulator
DE Akkumulator
RU Аккумулятор
CZ Akumulátor
HU Akkumulátor

RO Acumulator
FR Batterie
IT Batteria
ES Batería
CN 锂电池包

12V
Li-Ion
4.0 Ah
2h
[Icon: Battery pack]



YATO [V d.c.] [Icon: Battery pack]
YT-82910 12 20

EN Battery charger
PL Ładowarka
DE Ladegerät
RU Зарядное устройство
CZ Nabíječka
HU Töltő

RO Încărcător
FR Chargeur
IT Caricabatteria
ES Cargador
CN 充电器

110-240V~
50-60Hz
for: 12V
Li-Ion
[Icon: Battery pack]



YATO [V d.c.] [Icon: Battery pack]
YT-82912 12 20

EN Cordless drill/driver
PL Akumulatorowa wiertarko-wkrętarka
DE Akku-Bohrschrauber
RU Аккумуляторная дрель-шуруповёрт
CZ Akumulátorový vrtací šroubovák
HU Akkus fűró-csavarozó

RO Mașină de găurit și înșurubat cu acumulator
FR Perceuse-visseuse sans-fil
IT Trapano avvitatore a batteria
ES Taladro atornillador a batería
CN 充电式电钻

18V
Li-Ion
40 Nm
0-440 min¹
0-1650 min²
13 mm
[Icon: Drill bit]
[Icon: Battery pack]

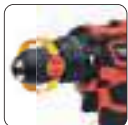

$L_{pA} = 71,0 \pm 3,0$ dB; $L_{wA} = 82,0 \pm 3,0$ dB; $a_p = 3,0 \pm 1,5$ m/s²

YATO	[V d.c.]	Battery capacity / Pojemność akumulatora [mAh]	Battery quantity / Liczba akumulatorów w zestawie	[Icon: Battery pack]
YT-82780	18	2000	1	5
YT-82781	18	-	brak	5

EN Cordless impact drill/driver
PL Akumulatorowa wiertarko-wkrętarka udarowa
DE Akku-Schlagbohrschrauber
RU Аккумуляторная ударная дрель-шуруповёрт
CZ Akumulátorový vrtací šroubovák s příklepem
HU Akkus ütvefűró-csavarozó

RO Mașină de găurit și înșurubat cu percuție cu acumulator
FR Perceuse-visseuse percussion sans-fil
IT Trapano avvitatore a percussione a batteria
ES Taladro atornillador con percusión a batería
CN 充电式冲击钻

18V
Li-Ion
40 Nm
0-440 min¹
0-1650 min²
0-7920 min³
0-29700 min³
13 mm
[Icon: Drill bit]
[Icon: Battery pack]



$L_{pA} = 82,0 \pm 3,0$ dB; $L_{wA} = 93,0 \pm 3,0$ dB; $a_p = 3,0 \pm 1,5 / 9,89 \pm 1,5$ m/s²

YATO	[V d.c.]	Battery capacity / Pojemność akumulatora [mAh]	Battery quantity / Liczba akumulatorów w zestawie	[Icon: Battery pack]
YT-82786	18	2000	1	5
YT-82787	18	-	brak	5

EN Brushless cordless drill/driver
 PL Bezszczotkowa wiertarko-wkrętarka akumulatorowa
 DE Bürstenloser Akku-Bohrschrauber
 RU Бесщеточный аккумуляторный дрель-шурупверт
 CZ Bezkartáčový akumulátorový vrtací šroubovák
 HU Akkus fűró-csavarozó szénkefe nélkül

RO Mașină de găurit și înșurubat cu acumulator, fără perii
 FR Perceuse-visseuse sans-fil sans charbon
 IT Trapano avvitatore senza spazzole a batteria
 ES Taladro atornillador a batería sin escobillas
 CN 充电式无刷电钻

18V
Li-Ion

42 Nm

0-600 min⁻¹
0-2000 min⁻¹

13 mm

BRUSHLESS MOTOR
SILNIK BEZ-SZCZOTKOWY



18V
Li-Ion

$L_{pa} = 74,0 \pm 3,0$ dB; $L_{wa} = 85,0 \pm 3,0$ dB; $a_n = 3,0 \pm 1,5$ m/s²

YATO	[V d.c.]	Battery capacity / Pojemność akumulatora [mAh]	Battery quantity / Liczba akumulatorów w zestawie	Package
YT-82794	18	2000	1	4
YT-82795	18	-	brak	5

EN Brushless cordless drill/driver
 PL Bezszczotkowa wiertarko-wkrętarka akumulatorowa
 DE Bürstenloser Akku-Bohrschrauber
 RU Бесщеточный аккумуляторный дрель-шурупверт
 CZ Bezkartáčový akumulátorový vrtací šroubovák
 HU Akkus fűró-csavarozó szénkefe nélkül
 RO Mașină de găurit și înșurubat cu acumulator, fără perii
 FR Perceuse-visseuse sans-fil sans charbon
 IT Trapano avvitatore senza spazzole a batteria
 ES Taladro atornillador a batería sin escobillas
 CN 充电式无刷电钻

18V
Li-Ion

45 Nm

0-500 min⁻¹
0-1450 min⁻¹

21+1
CLUTCH SETTINGS
POZIŁYCE SPRĘŻENIA

13 mm

BRUSHLESS MOTOR
SILNIK BEZ-SZCZOTKOWY



18V
Li-Ion

$L_{pa} = 82,0 \pm 5,0$ dB; $L_{wa} = 90,0 \pm 5,0$ dB; $a_n = 1,3 \pm 1,5$ m/s²

YATO	[V d.c.]	Battery capacity / Pojemność akumulatora [mAh]	Battery quantity / Liczba akumulatorów w zestawie	Package
YT-8277905	18	2000	1	10
YT-827788	18	2000	1	6
YT-827790	18	-	brak	10

EN Brushless cordless drill/driver
 PL Bezszczotkowa wiertarko-wkrętarka akumulatorowa
 DE Bürstenloser Akku-Bohrschrauber
 RU Бесщеточный аккумуляторный дрель-шурупверт
 CZ Bezkartáčový akumulátorový vrtací šroubovák
 HU Akkus fűró-csavarozó szénkefe nélkül

RO Mașină de găurit și înșurubat cu acumulator, fără perii
 FR Perceuse-visseuse sans-fil sans charbon
 IT Trapano avvitatore senza spazzole a batteria
 ES Taladro atornillador a batería sin escobillas
 CN 充电式无刷电钻

18V
Li-Ion

42 Nm

0-600 min⁻¹
0-2000 min⁻¹

13 mm

BRUSHLESS MOTOR
SILNIK BEZ-SZCZOTKOWY

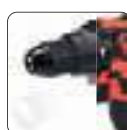

18V
Li-Ion

$L_{pa} = 94,0 \pm 3,0$ dB; $L_{wa} = 95,0 \pm 3,0$ dB; $a_n = 3,0 \pm 1,5 / 9,6 \pm 1,5$ m/s²

YATO	[V d.c.]	Battery capacity / Pojemność akumulatora [mAh]	Battery quantity / Liczba akumulatorów w zestawie	Package
YT-82796	18	2000	1	4
YT-82797	18	-	brak	5

EN Brushless cordless drill/driver
 PL Bezszczotkowa wiertarko-wkrętarka akumulatorowa
 DE Bürstenloser Akku-Bohrschrauber
 RU Бесщеточный аккумуляторный дрель-шурупверт
 CZ Bezkartáčový akumulátorový vrtací šroubovák
 HU Akkus fűró-csavarozó szénkefe nélkül
 RO Mașină de găurit și înșurubat cu acumulator, fără perii
 FR Perceuse-visseuse sans-fil sans charbon
 IT Trapano avvitatore senza spazzole a batteria
 ES Taladro atornillador a batería sin escobillas
 CN 充电式无刷电钻

18V
Li-Ion

75 Nm

0-500 min⁻¹
0-2100 min⁻¹

0-850 min⁻¹
0-29750 min⁻¹

13 mm

BRUSHLESS MOTOR
SILNIK BEZ-SZCZOTKOWY



18V
Li-Ion

$L_{pa} = 87,0 \pm 5,0$ dB; $L_{wa} = 98,0 \pm 5,0$ dB; $a_n = 6,23 \pm 1,5 / 4,37 \pm 1,5$ m/s²

YATO	[V d.c.]	Battery capacity / Pojemność akumulatora [mAh]	Battery quantity / Liczba akumulatorów w zestawie	Package
YT-82791	18	3000	1.5	3
YT-82790	18	3000	1.5	4
YT-82792	18	-	brak	6

EN Brushless cordless drill/driver
PL Bezszczotkowa wiertarko-wkrętarka akumulatorowa
DE Bürstenloser Akku-Bohrschrauber
RU Бесщеточный аккумуляторный дрель-шурупверт
CZ Bezkartáčový akumulátorový vrtací šroubovák
HU Akkus fűrészsavarozó szénkefe nélkül
RO Mașină de găurit și înșurubat fără acumulator, fără perii
FR Perceuse-visseuse sans-fil sans charbon
IT Trapano avvitatore senza spazzole a batteria
ES Taladro atornillador a batería sin escobillas
CN 充电式无刷电钻

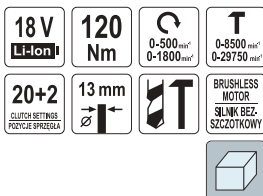

18V
Li-Ion

$L_{pa} = 82,0 \pm 5,0$ dB; $L_{wa} = 90,0 \pm 5,0$ dB; $a_n = 1,3 \pm 1,5 / 11,5 \pm 1,5$ m/s²

YATO [V d.c.]	Battery capacity / Pojemność akumulatora [mAh]	Battery quantity / Liczba akumulatorów w zestawie	Package
YT-8277915	18 4000	2	8
YT-827791	18 -	- brak	8

EN Cordless impact screwdriver
PL Akumulatorowa zakrętkarka udarowa
DE Akku-Schlagschrauber
RU Аккумуляторный ударный винтовёрт
CZ Akumulátorový rázový utahovák
HU Akkus ütvecsavarozó
RO Șurubelniță cu impact cu acumulator
FR Visseuse à choc sans-fil
IT Avvitatore a percussione a batteria
ES Atornillador de impacto a batería
CN 充电式冲击螺丝批

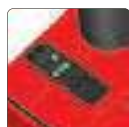

$L_{pa} = 86,0 \pm 3,0$ dB; $L_{wa} = 97,0 \pm 3,0$ dB; $a_n = 7,58 \pm 1,5$ m/s²

YATO [V d.c.]	Package
YT-82802	18 5

EN Cordless impact screwdriver
PL Akumulatorowa zakrętkarka udarowa
DE Akku-Schlagschrauber
RU Аккумуляторный ударный винтовёрт
CZ Akumulátorový rázový utahovák
HU Akkus ütvecsavarozó
RO Șurubelniță cu impact cu acumulator
FR Visseuse à choc sans-fil
IT Avvitatore a percussione a batteria
ES Atornillador de impacto a batería
CN 充电式冲击螺丝批

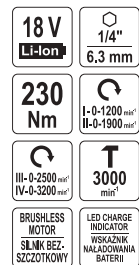

18V
Li-Ion

$L_{pa} = 99,0 \pm 3,0$ dB; $L_{wa} = 107,0 \pm 3,0$ dB; $a_n = 12,9 \pm 1,5$ m/s²

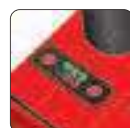

YATO [V d.c.]	Battery capacity / Pojemność akumulatora [mAh]	Battery quantity / Liczba akumulatorów w zestawie	Package
YT-82798	18 4000	2	6
YT-82799	18 -	- brak	6

EN Cordless impact wrench
PL Akumulatorowy klucz udarowy
DE Akku-Drehschlagschrauber
RU Аккумуляторный ударный гайковёрт
CZ Akumulátorový rázový utahovák
HU Akkus ütvecsavarozó
RO Pistol de impact cu acumulator
FR Boulonneuse sans-fil
IT Chiave a percussione a batteria
ES Llave de impacto a batería
CN 充电式冲击扳手

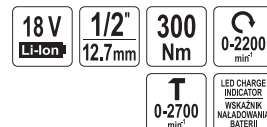

17, 19, 21, 23 mm



$L_{pa} = 84,0 \pm 3,0$ dB; $L_{wa} = 95,0 \pm 3,0$ dB; $a_n = 9,09 \pm 1,5$ m/s²

YATO [V d.c.]	Battery capacity / Pojemność akumulatora [mAh]	Battery quantity / Liczba akumulatorów w zestawie	Package
YT-82804	18 2000	1	4
YT-82805	18 -	- brak	5

EN Cordless impact wrench
 PL Akumulatorowy klucz udarowy
 DE Akku-Dreherschlagschrauber
 RU Аккумуляторный ударный гайковёрт
 CZ Akumulátorový rázový utahovák
 HU Akkus ütvecsavarozó
 RO Pistol de impact fără acumulator
 FR Boulonneuse sans-fil
 IT Chiave a percussione a batteria
 ES Llave de impacto a batería
 CN 充电式冲击扳手

18 V
Li-Ion

1/2"
12,7mm

350 Nm

0-2500
min⁻¹

T
0-3170
min⁻¹

BRUSHLESS MOTOR
SIŁNIK BEZ SZCZOTKOWY



18V
Li-Ion

$L_{pa} = 95,0 \pm 3,0$ dB; $L_{wa} = 103,0 \pm 3,0$ dB; $a_h = 16,1 \pm 1,5$ m/s²

YATO [V d.c.]	Battery capacity / Pojemność akumulatora [mAh]	Battery quantity / Liczba akumulatorów w zestawie	⚡ [h]	⊞
YT-8277925	18 4000	2	-	10
YT-827792	18 -	-	brak	10

EN Cordless impact wrench
 PL Akumulatorowy klucz udarowy
 DE Akku-Dreherschlagschrauber
 RU Аккумуляторный ударный гайковёрт
 CZ Akumulátorový rázový utahovák
 HU Akkus ütvecsavarozó
 RO Pistol de impact cu acumulator
 FR Boulonneuse sans-fil
 IT Chiave a percussione a batteria
 ES Llave de impacto a batería
 CN 充电式冲击扳手

18 V
Li-Ion

1/2"
12,7mm

850 Nm

0-2350
min⁻¹

T
0-2600
min⁻¹

BRUSHLESS MOTOR
SIŁNIK BEZ SZCZOTKOWY



18V
Li-Ion

$L_{pa} = 95,0 \pm 3,0$ dB; $L_{wa} = 103,0 \pm 3,0$ dB; $a_h = 16,1 \pm 1,5$ m/s²

YATO [V d.c.]	Battery capacity / Pojemność akumulatora [mAh]	Battery quantity / Liczba akumulatorów w zestawie	⚡ [h]	⊞
YT-8277935	18 4000	2	-	6
YT-827793	18 -	-	brak	6

EN Cordless impact wrench
 PL Akumulatorowy klucz udarowy
 DE Akku-Dreherschlagschrauber
 RU Аккумуляторный ударный гайковёрт
 CZ Akumulátorový rázový utahovák
 HU Akkus ütvecsavarozó
 RO Pistol de impact cu acumulator
 FR Boulonneuse sans-fil
 IT Chiave a percussione a batteria
 ES Llave de impacto a batería
 CN 充电式冲击扳手

18 V
Li-Ion

1/2"
12,7mm

700 Nm

0-2600
min⁻¹

T
0-5000
min⁻¹

BRUSHLESS MOTOR
SIŁNIK BEZ SZCZOTKOWY

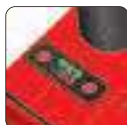

18V
Li-Ion

$L_{pa} = 86,0 \pm 3,0$ dB; $L_{wa} = 97,0 \pm 3,0$ dB; $a_h = 7,58 \pm 1,5$ m/s²

YATO [V d.c.]	Battery capacity / Pojemność akumulatora [mAh]	Battery quantity / Liczba akumulatorów w zestawie	⚡ [h]	⊞
YT-82806	18 3000	1	-	3
YT-828061	18 -	-	brak	6

EN Cordless impact wrench
 PL Akumulatorowy klucz udarowy
 DE Akku-Dreherschlagschrauber
 RU Аккумуляторный ударный гайковёрт
 CZ Akumulátorový rázový utahovák
 HU Akkus ütvecsavarozó
 RO Pistol de impact cu acumulator
 FR Boulonneuse sans-fil
 IT Chiave a percussione a batteria
 ES Llave de impacto a batería
 CN 充电式冲击扳手

18 V
Li-Ion

1/2"
12,7mm

1200 Nm

0-1400
min⁻¹

T
2200
min⁻¹

BRUSHLESS MOTOR
SIŁNIK BEZ SZCZOTKOWY

LED CHARGE INDICATOR
WSKAZNIK NAŁADOWANIA BATERII



18V
Li-Ion

$L_{pa} = 98,0 \pm 3,0$ dB; $L_{wa} = 106,0 \pm 3,0$ dB; $a_h = 19,00 \pm 1,5$ m/s²

YATO [V d.c.]	Battery capacity / Pojemność akumulatora [mAh]	Battery quantity / Liczba akumulatorów w zestawie	⚡ [h]	⊞
YT-828071	18 4000	2	-	4
YT-828072	18 -	-	brak	6

EN Cordless impact wrench
PL Akumulatorowy klucz udarowy
DE Akku-Dreherschlagschrauber
RU Аккумуляторный ударный гайковёрт
CZ Akumulátorový rázový utahovák
HU Akkus ütvecsavarozó
RO Pistol de impact cu acumulator
FR Boulonneuse sans-fil
IT Chiave a percussione a batteria
ES Llave de impacto a batería
CN 充电式冲击扳手

18 V
Li-Ion
3/4"
19 mm
2400 Nm
I-0-1150^{min⁻¹}
II-0-1450^{min⁻¹}
III-0-1650^{min⁻¹}
BRUSHLESS MOTOR
SIŁNIK BEZ-SZCZOTKOWY
LED CHARGE INDICATOR
WSKAZNIK NAŁADOWANIA BATERII



18V
Li-Ion

$L_{pa} = 102,0 \pm 3,0$ dB; $L_{wa} = 110,0 \pm 3,0$ dB; $a_h = 15,3 \pm 1,5$ m/s²



YATO [V d.c.]	Battery capacity / Pojemność akumulatora [mAh]	Battery quantity / Liczba akumulatorów w zestawie [h]	Package
YT-828073	18 6000	3 1	3
YT-828074	18 -	- brak	4

EN Cordless screwdriver
PL Wkrętak akumulatorowy
DE Akku-Schrauber
RU Аккумуляторный шурупверт
CZ Utahovák akumulátorový
HU Akkumulátoros csavarbehajtó
RO Șurubelniță cu acumulator
FR Tournevis sans-fil
IT Avvitatore a batteria
ES Herramienta de resistencia para soldar
CN 充电式螺丝批

3.6 V
Li-Ion
1300mAh
3.0 Nm
230 min⁻¹
WORKING AREA LIGHT
OSWIEPLENIE OBSZARU PRACY
LED CHARGE INDICATOR
WSKAZNIK NAŁADOWANIA BATERII



$L_{pa} = 62,0 \pm 3,0$ dB; $L_{wa} = 73,0 \pm 3,0$ dB; $a_h = 0,39 \pm 1,5$ m/s²



YATO [V d.c.]	Package
YT-82760	3.6 20

EN Cordless impact wrench
PL Akumulatorowy klucz udarowy
DE Akku-Dreherschlagschrauber
RU Аккумуляторный ударный гайковёрт
CZ Akumulátorový rázový utahovák
HU Akkus ütvecsavarozó
RO Pistol de impact cu acumulator
FR Boulonneuse sans-fil
IT Chiave a percussione a batteria
ES Llave de impacto a batería
CN 充电式冲击扳手

18 V
Li-Ion
3/4"
19 mm
2000 Nm
0-1200^{min⁻¹}
1650^{min⁻¹}
BRUSHLESS MOTOR
SIŁNIK BEZ-SZCZOTKOWY
LED CHARGE INDICATOR
WSKAZNIK NAŁADOWANIA BATERII



18V
Li-Ion

$L_{pa} = 73,0 \pm 5,0$ dB; $L_{wa} = 81,0 \pm 5,0$ dB; $a_h = 9,00 \pm 1,5$ m/s²



YATO [V d.c.]	Battery capacity / Pojemność akumulatora [mAh]	Battery quantity / Liczba akumulatorów w zestawie [h]	Package
YT-828075	18 4000	2 1	2
YT-828076	18 -	- brak	4

EN Cordless glue gun
PL Akumulatorowy pistolet do klejenia
DE Heissklebepistole
RU Пистолет для клея
CZ Pistole na lepení
HU Ragasztópisztoly
RO Pistol pt. lipit cu acumulator
FR Pistolet à colle sans-fil
IT Pistola colla
ES Pistola de cola
CN 充电式胶枪

18 V
Li-Ion
25 g/min
3x
≥ 60 min
2.0 Ah
1h



18V
Li-Ion

Fitting glue sticks: see chapter 12
Pasujące wkłady klejowe: patrz rozdział 12

YATO [V d.c.]	Package
YT-82854	18 10

EN Cordless car air compressor
 PL Akumulatorowy kompresor samochodowy
 DE Akku-Auto-Kompressor
 RU Компрессор автомобильный аккумуляторный
 CZ Akumulátorový automobilový kompresor
 HU Autókompresszor akkumulátoros
 RO Compresor auto cu acumulator
 FR Compresseur de voiture sans-fil
 IT Compresore a batteria per auto
 ES Compresor de coche de batería
 CN 无绳车载空气压缩机

36 V
2x 18V
Li-Ion

8 bar

98 l/min

6 L



- Pressure hose
- Tire inflation gun
- Wąż ciśnieniowy
- Pistolet do pompowania kół

18V
Li-Ion

$L_{pA} = 80,0 \pm 3,0$ dB; $L_{wA} = 90,7 \pm 3,0$ dB

YATO	[V d.c.]	Battery capacity / Pojemność akumulatora [mAh]	⚡ [h]	Battery quantity / Liczba akumulatorów w zestawie	
YT-23241	36 (18 x2)	3000	1.5	2	1
YT-23242	36 (18 x2)	-	-	brak	1

EN Cordless inflator
 PL Pompka akumulatorowa
 DE Akku-Luftpumpe
 RU Аккумуляторный насос
 CZ Čerpadlo baterie
 HU Akkumulátor szivattyú
 RO Pistol de umflrat roți cu acumulator
 FR Pompe à air sans-fil
 IT Pompa a batteria
 ES Bomba de batería
 CN 充电式充气泵

18 V
Li-Ion

1.0 MPa

14 l/min

50 cm



$L_{pA} = 77,1 \pm 3,0$ dB; $L_{wA} = 85,1 \pm 3,0$ dB; $a_n = 2,33 \pm 1,5$ m/s²

YATO	[V d.c.]	Battery capacity / Pojemność akumulatora [mAh]	⚡ [h]	Battery quantity / Liczba akumulatorów w zestawie	
YT-82894	18	2000	1	1	5
YT-82895	18	-	-	brak	5

EN Cordless grease gun
 PL Smarownica akumulatorowa
 DE Akku-Fettpresse
 RU Шприц для смазки аккумуляторный
 CZ Akumulátorový mazací lis
 HU Akku zsíröz prés
 RO Pistol de gresat cu acumulator
 FR Pistolet graisseur sans-fil
 IT Lubrificatore a batteria
 ES Lubricador de batería
 CN 无绳黄油枪

18 V
Li-Ion

62 MPa

284 g/min

76 cm

LED LIGHTING OSWETLENIENIE



$L_{pA} = 76,0 \pm 3,0$ dB; $L_{wA} = 86,0 \pm 3,0$ dB; $a_n = 0,5 \pm 1,5$ m/s²

YATO	[V d.c.]	Battery capacity / Pojemność akumulatora [mAh]	⚡ [h]	Battery quantity / Liczba akumulatorów w zestawie	
YT-07020	18	3000	1.5	1	2
YT-07021	18	-	-	brak	2

EN Cordless car air compressor
 PL Akumulatorowy kompresor samochodowy
 DE Akku-Auto-Kompressor
 RU Компрессор автомобильный аккумуляторный
 CZ Akumulátorový automobilový kompresor
 HU Autókompresszor akkumulátoros
 RO Compresor auto cu acumulator
 FR Compresseur de voiture sans-fil
 IT Compresore a batteria per auto
 ES Compresor de coche de batería
 CN 无绳车载空气压缩机

18 V
Li-Ion

12 V

11 bar

LED LIGHTING OSWETLENIENIE

LED BACKLIGHT POŚWIETLENIE



18V
Li-Ion

$L_{pA} = 71,2 \pm 3,0$ dB; $L_{wA} = 82,2 \pm 3,0$ dB; $a_n = 9,75 \pm 1,5$ m/s²

YATO	[V d.c.]	Battery capacity / Pojemność akumulatora [mAh]	⚡ [h]	Battery quantity / Liczba akumulatorów w zestawie	
YT-23247	18	3000	1.5	1	4
YT-23248	18	-	-	brak	4

EN Cordless caulking gun
 PL Akumulatorowy wyciskacz do mas
 DE Akku-Kartuschenpistole
 RU Аккумуляторный пистолет для герметика
 CZ Akumulátorová těsnící pistole
 HU Akkus kinyomó vázas masszázshöz
 RO Pistol silicon cu acumulator
 FR Pistolet à feutrer sans-fil
 IT Pistola applicatrice a batteria
 ES Pistola para masilla a batería
 CN 充电式填缝枪

18 V
Li-Ion

2000 N

0.5-8 mm/s

225mm



18V
Li-Ion

$L_{pA} = 80,0 \pm 3,0$ dB; $L_{wA} = 91,0 \pm 3,0$ dB; $a_n = 1,68 \pm 1,5$ m/s²

YATO	[V d.c.]	Battery capacity / Pojemność akumulatora [mAh]	⚡ [h]	Battery quantity / Liczba akumulatorów w zestawie	
YT-82888	18	4000	2	1	5
YT-82889	18	-	-	brak	5

EN Cordless spray gun
 PL Akumulatorowy pistolet malarski
 DE Akkubetriebene Farbspritzpistole
 RU Аккумуляторный покрасочный пистолет
 CZ Akumulátorová malířská pistole
 HU Akkumulátoros festékszór
 RO Pistol de vopsit cu acumulator
 FR Pistolet à peinture sans-fil
 IT Pistola a batteria per verniciare
 ES Pistola para pintar a batería
 CN 充电式喷枪

18 V
Li-Ion

2.2 mm

1 l/min

1000 ml

4.0 Ah

2h



18V
Li-Ion

$L_{pA} = 72,1 \pm 3,0$ dB; $L_{wA} = 83,1 \pm 3,0$ dB; $a_n = 0,203 \pm 1,5$ m/s²

YATO	[V d.c.]		
YT-82765	18		4

EN Cordless stirrer
PL Mieszarka akumulatorowa
DE Akku-Rührwerk
RU Аккумуляторный миксер
CZ Akumulátorový míchadlo
HU Akkus keverőgép
RO Malaxor cu acumulator
FR Malaxeur sans-fil
IT Miscelatore a batteria
ES Citador de batería
CN 充电式搅拌机



18V
Li-Ion

$L_{pa} = 79,0 \pm 3,0$ dB; $L_{wa} = 90,0 \pm 3,0$ dB; $a_h = 4,76 \pm 1,5$ m/s²

YATO	[V d.c.]	Battery capacity / Pojemność akumulatora [mAh]	⚡ [h]	Battery quantity / Liczba akumulatorów w zestawie	📦
YT-82880	18	2000	1	1	2
YT-82881	18	-	-	brak	2

EN Cordless circular saw
PL Akumulatorowa pilarka tarczowa
DE Akku-Handkreissäge
RU Аккумуляторная циркулярная пила
CZ Akumulátorová okružní pila
HU Akkus körfűrész
RO Fierăstrău circular cu acumulator
FR Scie circulaire sans-fil
IT Sega circolare a batteria
ES Sierra circular a batería
CN 充电式电圆锯

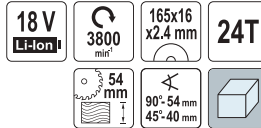

18V
Li-Ion

Fitting blades: see chapter 10
Pasujące tarcze: patrz rozdział 10

$L_{pa} = 85,0 \pm 3,0$ dB; $L_{wa} = 96,0 \pm 3,0$ dB; $a_h = 5,33 \pm 1,5$ m/s²

YATO	[V d.c.]	Battery capacity / Pojemność akumulatora [mAh]	⚡ [h]	Battery quantity / Liczba akumulatorów w zestawie	📦
YT-82810	18	2000	1	1	2
YT-82811	18	-	-	brak	2

EN Cordless sabre saw
PL Akumulatorowa piła szablasta
DE Akku-Säbelsäge
RU Аккумуляторная сабельная пила
CZ Akumulátorová píla oscaká
HU Akkus szabályfűrész
RO Fierăstrău sabie cu acumulator
FR Scie sabre sans-fil
IT Sega a gattuccio a batteria
ES Sierra sable de batería
CN 充电式往复锯



18V
Li-Ion

Fitting blades: see chapter 10
Pasujące brzeszczoły: patrz rozdział 10

$L_{pa} = 81,0 \pm 3,0$ dB; $L_{wa} = 92,0 \pm 3,0$ dB; $a_h = 7,5 \pm 1,5 / 8,3 \pm 1,5$ m/s²

YATO	[V d.c.]	Battery capacity / Pojemność akumulatora [mAh]	⚡ [h]	Battery quantity / Liczba akumulatorów w zestawie	📦
YT-82814	18	2000	1	1	4
YT-82815	18	-	-	brak	4

EN Cordless circular saw
PL Akumulatorowa pilarka tarczowa
DE Akku-Handkreissäge
RU Аккумуляторная циркулярная пила
CZ Akumulátorová okružní pila
HU Akkus körfűrész
RO Fierăstrău circular cu acumulator
FR Scie circulaire sans-fil
IT Sega circolare a batteria
ES Sierra circular a batería
CN 充电式电圆锯



18V
Li-Ion

Fitting blades: YT-60625, YT-60631
Pasujące tarcze: YT-60625, YT-60631

$L_{pa} = 85,9 \pm 3,0$ dB; $L_{wa} = 96,9 \pm 3,0$ dB; $a_h = 1,031 \pm 1,5$ m/s² / $1,179 \pm 1,5$ m/s²

YATO	[V d.c.]	Battery capacity / Pojemność akumulatora [mAh]	⚡ [h]	Battery quantity / Liczba akumulatorów w zestawie	📦
YT-82808	18	3000	1.5	1	2
YT-82809	18	-	-	brak	4

EN Cordless multi-purpose oscillating tool
PL Akumulatorowe wielofunkcyjne narzędzie oscylacyjne
DE Akku-Multifunktionswerkzeug
RU Аккумуляторный многофункциональный инструмент
CZ Akumulátorová multifunkční píla
HU Akkus multifunkcionális vágószerszám
RO Unealtă multifuncțională cu acumulator
FR Découpeur-ponceur multifonctions sans-fil
IT Utensile oscillante multifunzione a batteria
ES Multiherramienta a batería
CN 充电式摆动铲



18V
Li-Ion

$L_{pa} = 77,0 \pm 3,0$ dB; $L_{wa} = 88,0 \pm 3,0$ dB; $a_h = 4,68 \pm 1,5$ m/s²

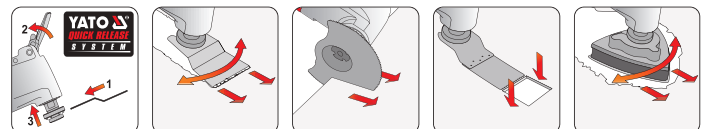

YATO	[V d.c.]	Battery capacity / Pojemność akumulatora [mAh]	⚡ [h]	Battery quantity / Liczba akumulatorów w zestawie	📦
YT-82818	18	2000	1	1	4
YT-82819	18	-	-	brak	4

EN Cordless jig saw
 PL Akumulatorowa wyrzynarka
 DE Akku-Stichsäge
 RU Аккумуляторная лобзиковая пила
 CZ Akumulátorová přímočará pila
 HU Akkus szűrőfűrész
 RO Fierăstrău pendular cu acumulator
 FR Scie sauteuse sans-fil
 IT Seghetto alternativo a batteria
 ES Sierra de calar a batería
 CN 充电式曲线锯



18V
Li-Ion

$L_{pa} = 76,0 \pm 3,0$ dB; $L_{wa} = 87,0 \pm 3,0$ dB; $a_h = 6,28 \pm 1,5 / 5,78 \pm 1,5$ m/s²

YATO	[V d.c.]	Battery capacity / Pojemność akumulatora [mAh]	⌚⚡ [h]	Battery quantity / Liczba akumulatorów w zestawie	📦
YT-82822	18	2000	1	1	4
YT-82823	18	-	-	brak	5

EN Cordless band saw
 PL Akumulatorowa pila taśmowa
 DE Akku-Bandsäge
 RU Аккумуляторная ленточная пила
 CZ Akumulátorová pásová pila
 HU Akkus szalagfűrész
 RO Fierăstrău cu bandă cu acumulator
 FR Scie à ruban sans-fil
 IT Sega a nastro a batteria
 ES Sierra de cinta a batería
 CN 充电式带锯



18V
Li-Ion

$L_{pa} = 82,0 \pm 3,0$ dB; $L_{wa} = 93,0 \pm 3,0$ dB; $a_h = 5,14 \pm 1,5 / 4,65 \pm 1,5$ m/s²

YATO	[V d.c.]	Battery capacity / Pojemność akumulatora [mAh]	⌚⚡ [h]	Battery quantity / Liczba akumulatorów w zestawie	📦
YT-82187	18	4000	3	1	2
YT-82188	18	-	-	brak	2

EN Cordless riveter
 PL Nitownica akumulatorowa
 DE Akku-Blindnietpistole
 RU Аккумуляторный заклепочник
 CZ Akumulátorová nýtovačka
 HU Akkus popszegecsűző
 RO Presă de nituit cu acumulator
 FR Riveteuse sans-fil
 IT Rivettatrice a batteria
 ES Remachadora a batería
 CN 充电式铆钉枪



18V
Li-Ion

$L_{pa} = 81,0 \pm 3,0$ dB; $L_{wa} = 92,0 \pm 3,0$ dB; $a_h = 3,94 \pm 1,5$ m/s²

YATO	[V d.c.]	Battery capacity / Pojemność akumulatora [mAh]	⌚⚡ [h]	Battery quantity / Liczba akumulatorów w zestawie	📦
YT-82955	18	3000	1.5	1	4
YT-82956	18	-	-	brak	6

EN Cordless straight grinder
 PL Akumulatorowa szlifierka prosta
 DE Akku-Geradschleifer
 RU Аккумуляторная прямая шлифмашина
 CZ Akumulátorová přímá bruska
 HU Akkus egyenes csiszoló
 RO Polizor drept fără acumulator
 FR Meuleuse droite sans-fil
 IT Smerigliatrice diritta a batteria
 ES Amoladora recta a batería
 CN 锂电直磨机



18V
Li-Ion

$L_{pa} = 78,0 \pm 3,0$ dB; $L_{wa} = 89,0 \pm 3,0$ dB; $a_h = 2,47 \pm 1,5$ m/s²

YATO	[V d.c.]	📦
YT-82824	18	10

EN Cordless angle grinder
 PL Akumulatorowa szlifierka kątowa
 DE Akku-Winkelschleifer
 RU Аккумуляторная угловая шлифмашина
 CZ Akumulátorová úhlová bruska
 HU Akkus sarokcsiszoló
 RO Polizor unghiular cu acumulator
 FR Meuleuse angulaire sans-fil
 IT Smerigliatrice angolare a batteria
 ES Amoladora angular a batería
 CN 充电式角磨



18V
Li-Ion

$L_{pa} = 88,0 \pm 3,0$ dB; $L_{wa} = 99,0 \pm 3,0$ dB; $a_h = 4,9 \pm 1,5$ m/s²

YATO	[V d.c.]	Battery capacity / Pojemność akumulatora [mAh]	⌚⚡ [h]	Battery quantity / Liczba akumulatorów w zestawie	📦
YT-82828	18	3000	1.5	2	4
YT-82826	18	2000	1	1	4
YT-82827	18	-	-	brak	6

EN Cordless angle grinder
 PL Akumulatorowa szlifierka kątowa
 DE Akku-Winkelschleifer
 RU Аккумуляторная угловая шлифмашина
 CZ Akumulátorová úhlová bruska
 HU Akkus sarokcsiszoló
 RO Polizor unghiular cu acumulator
 FR Meuleuse angulaire sans-fil
 IT Smerigliatrice angolare a batteria
 ES Amoladora angular a batería
 CN 充电式角磨



18V
Li-Ion

$L_{pa} = 89,0 \pm 3,0$ dB; $L_{wa} = 97,0 \pm 3,0$ dB; $a_h = 7,28 \pm 1,5$ m/s²

YATO	[V d.c.]	Battery capacity / Pojemność akumulatora [mAh]	⌚⚡ [h]	Battery quantity / Liczba akumulatorów w zestawie	📦
YT-828295	18	4000	2	2	4
YT-828294	18	4000	2	1	6
YT-828293	18	-	-	brak	8

- EN Cordless grinders kit
PL Zestaw szlifierek akumulatorowych
DE Akku-Schleifgeräte-Set
RU Набор аккумуляторных шлифовальных машин
CZ Sada akumulátorových brusek
HU Akkumulátoros csiszológép készlet
RO Set polizoare cu acumulator
FR Jeu de meuleuses sans-fil
IT Kit di smerigliatrici a batteria
ES Juego de amoladoras a batería
CN 锂电角磨-直磨机套装



18 V Li-Ion	8000-26000 min ⁻¹	6 mm
max Ø 25 mm	Ø 125 mm	3000-8500 min ⁻¹
M14	4.0 Ah	2h
SOFT START MIEKKI START	BRUSHLESS MOTOR SZINK BEZ- SZCZOTKOWY	

18V

Li-Ion

$L_{pA} = 78,0 \pm 3,0$ dB; $L_{wA} = 89,0 \pm 3,0$ dB; $a_n = 2,47 \pm 1,5$ m/s² (Straight grinder / Szlifierka prosta);
 $L_{pA} = 89,0 \pm 3,0$ dB; $L_{wA} = 97,0 \pm 3,0$ dB; $a_n = 7,28 \pm 1,5$ m/s² (Angle grinder / Szlifierka kątowa)

YATO	[V d.c.]	
YT-828296	18	4

- EN Cordless polisher
PL Polerka akumulatorowa
DE Akku-Polierer
RU Аккумуляторная полировальная машина
CZ Akumulátorová leštička
HU Akkus polírozógép
RO Aparat de polișat cu acumulator
FR Polisseuse sans-fil
IT Lucidatrice a batteria
ES Pulidora a batería
CN 充电式抛光机



18 V Li-Ion	2100-5000 min ⁻¹	Ø 125 mm	M8	DUAL ACTION RUCH ORBITALNY
15 mm	SOFT START MIEKKI START	SPEED REGULATOR REGULACJA PRĘDKOŚCI	BRUSHLESS MOTOR SZINK BEZ- SZCZOTKOWY	



18V
Li-Ion

$L_{pA} = 75,0 \pm 3,0$ dB; $L_{wA} = 86,0 \pm 3,0$ dB; $a_n = 4,56 \pm 1,5$ m/s²

YATO	[V d.c.]	Battery capacity / Pojemność akumulatora [mAh]	⌚ [h]	Battery quantity / Liczba akumulatorów w zestawie	
YT-82924	18	4000	3	1	6
YT-82925	18	-	-	brak	6

- EN Cordless random orbital sander
PL Szlifierka oscylacyjna akumulatorowa
DE Akku-Schwingschleifer
RU Аккумуляторная шлифовальная машина
CZ Akumulátorová bruska
HU Akkumulátoros csiszoló
RO Șlefuitor orbital fără acumulator
FR Ponceuse vibrante sans-fil
IT Levigatrice orbitale a batteria
ES Lijadora orbital inalámbrica
CN 充电式砂光机



18 V Li-Ion	0-12000 min ⁻¹	Ø 125 mm
2.0 mm		



Battery not included
Onne Akku / Bez akumulatora
Bez Gamaşeu / Bez aku
Akkumulátor nélkül
Fără baterie / Sans batterie
Senza batteria / Sin batería
没有电池

18V
Li-Ion

Fitting sand papers: see chapter 10
Pasujące papiery ściernie: patrz rozdział 10

$L_{pA} = 73,7 \pm 3,0$ dB; $L_{wA} = 84,7 \pm 3,0$ dB; $a_n = 7,0 \pm 1,5$ m/s²

YATO	[V d.c.]	
YT-82753	18	4

- EN Cordless orbital sander
PL Szlifierka oscylacyjna akumulatorowa
DE Akku-Schwingschleifer
RU Аккумуляторная шлифовальная машина
CZ Akumulátorová bruska
HU Akkumulátoros csiszoló
RO Șlefuitor oscilant fără acumulator
FR Ponceuse vibrante sans-fil
IT Levigatrice orbitale a batteria
ES Lijadora orbital inalámbrica
CN 充电式砂光机

18 V Li-Ion	13000 min ⁻¹	2.0 mm	90x187 mm
----------------	----------------------------	--------	--------------



Battery not included
Onne Akku / Bez akumulatora
Bez Gamaşeu / Bez aku
Akkumulátor nélkül
Fără baterie / Sans batterie
Senza batteria / Sin batería
没有电池

18V
Li-Ion

Fitting sand papers: see chapter 10
Pasujące papiery ściernie: patrz rozdział 10

$L_{pA} = 77,8 \pm 3,0$ dB; $L_{wA} = 88,8 \pm 3,0$ dB; $a_n = 5,45 \pm 1,5$ m/s²

YATO	[V d.c.]	
YT-82751	18	4

- EN Cordless orbital sander
PL Szlifierka oscylacyjna akumulatorowa
DE Akku-Schwingschleifer
RU Аккумуляторная шлифовальная машина
CZ Akumulátorová bruska
HU Akkumulátoros csiszoló
RO Șlefuitor oscilant fără acumulator
FR Ponceuse vibrante sans-fil
IT Levigatrice orbitale a batteria
ES Lijadora orbital inalámbrica
CN 充电式砂光机

18 V Li-Ion	11000 min ⁻¹	Ø 125 mm
2.0 mm		84x184 mm



Battery not included
Onne Akku / Bez akumulatora
Bez Gamaşeu / Bez aku
Akkumulátor nélkül
Fără baterie / Sans batterie
Senza batteria / Sin batería
没有电池

18V
Li-Ion

$L_{pA} = 69,6 \pm 3,0$ dB; $L_{wA} = 80,6 \pm 3,0$ dB; $a_n = 7,34 \pm 1,5$ m/s²

YATO	[V d.c.]	
YT-82755	18	4

EN Cordless polisher
 PL Polerka akumulatorowa
 DE Akku-Polierer
 RU Аккумуляторная полировальная машина
 CZ Akumulátorová leštička
 HU Akkus polírozógép
 RO Aparat de polișat cu acumulator
 FR Polisseuse sans-fil
 IT Lucidatrice a batteria
 ES Pulidora a batería
 CN 充电式抛光机



18 V Li-Ion	1500-5000 min ⁻¹	150 mm	M8	DUAL ACTION RUCH ORBITALNY
16 mm	3.0 Ah	1.5h	SOFT START MIĘKKI START	SPEED REGULATOR REGULACJA PRĘDKOŚCI
BRUSHLESS MOTOR SIŁNIK BEZ- SZCZOTKOWY				



EN Cordless polisher
 PL Polerka akumulatorowa
 DE Akku-Polierer
 RU Аккумуляторная полировальная машина
 CZ Akumulátorová leštička
 HU Akkus polírozógép
 RO Aparat de polișat fără acumulator
 FR Polisseuse sans-fil
 IT Lucidatrice a batteria
 ES Pulidora a batería
 CN 充电式抛光机

18 V Li-Ion	2500 min ⁻¹	254 mm		BRUSHLESS MOTOR SIŁNIK BEZ- SZCZOTKOWY
6.0 mm				
BRUSHLESS MOTOR SIŁNIK BEZ- SZCZOTKOWY				



Battery not included
 Ohne Akku / Bez akumulatora
 Bez Gamapeu / Bez aku
 Akumulátor nélkül
 Fără baterie / Sans batterie
 Senza batteria / Sin batería
 没有电池

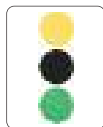

$L_{pa} = 88,0 \pm 3,0$ dB; $L_{wa} = 99,0 \pm 3,0$ dB;
 $a_n = 15,540 \pm 1,5 / 18,859 \pm 1,5$ m/s²

18V
Li-Ion



$L_{pa} = 81,0 \pm 3,0$ dB; $L_{wa} = 92,0 \pm 3,0$ dB; $a_n = 7,73 \pm 1,5$ m/s²

18V
Li-Ion

YATO	[V d.c.]	
YT-82920	18	4

YATO	[V d.c.]	
YT-82922	18	4

EN Cordless rotary hammer
 PL Akumulatorowa młotowiertarka
 DE Akku-Bohrhammer
 RU Аккумуляторный перфоратор
 CZ Akumulátorové vrtací kladivo
 HU Akkus fűrókalapács
 RO Ciocan rotopercutor cu acumulator
 FR Marteau-perforateur rotatif sans-fil
 IT Martello rotativo a batteria
 ES Martillo perforador a batería
 CN 充电式电锤

18 V Li-Ion	SDS PLUS	0-1850 min ⁻¹	0-4800 mm ^T
2.0 J	18 mm	3.0 Ah	1.5h



EN Cordless rotary hammer
 PL Akumulatorowa młotowiertarka
 DE Akku-Bohrhammer
 RU Аккумуляторный перфоратор
 CZ Akumulátorové vrtací kladivo
 HU Akkus fűrókalapács
 RO Ciocan rotopercutor fără acumulator
 FR Marteau-perforateur rotatif sans-fil
 IT Martello rotativo a batteria
 ES Martillo perforador a batería
 CN 充电式电锤

18 V Li-Ion	SDS PLUS	0-1000 min ⁻¹	0-5000 mm ^T
2.4 J	24 mm		



Battery not included
 Ohne Akku / Bez akumulatora
 Bez Gamapeu / Bez aku
 Akumulátor nélkül
 Fără baterie / Sans batterie
 Senza batteria / Sin batería
 没有电池



$L_{pa} = 95,6 \pm 3,0$ dB; $L_{wa} = 104,0 \pm 3,0$ dB; $a_n = 5,677 \pm 1,5 / 6,334 \pm 1,5$ m/s²

18V
Li-Ion

$L_{pa} = 89,0 \pm 3,0 / 89,0 \pm 3,0$ dB; $L_{wa} = 100,0 \pm 3,0 / 100,0 \pm 3,0$ dB; $a_n = 13,286 \pm 1,5 / 9,473 \pm 1,5$ m/s²

18V
Li-Ion

YATO	[V d.c.]	
YT-82770	18	3

YATO	[V d.c.]	
YT-82772	18	4

EN Cordless drywall sander
PL Akumulatorowa szlifierka do gipsu
DE Akku-Gipsschleifer
RU Аккумуляторная шлифовальная машина для гипса
CZ Akumulátorová sádrová bruska
HU Akkus falcsiszoló
RO Șlefuitor pt. pereți cu acumulator
FR Ponceuse murale sans-fil
IT Levigatrice per muro a batteria
ES Lijadora de pared a batería
CN 充电式无刷打磨机

- Vacuum self suction system integrated
- Adapter diameters: 35, 47 mm
- Included 6 pcs sand paper: P60, P80, P120, P150, P180, P240
- Wbudowany system odsysania pyłu
- Średnice adaptera: 35, 47 mm
- W zestawie 6 szt. papieru ściemnego: P60, P80, P120, P150, P180, P240

18V
Li-Ion



Fitting abrasive discs: see chapter 10
Pasujące krążki ściemne: patrz rozdział 10
 $L_{wa} = 87,0 \pm 3,0$ dB; $L_{wb} = 95,0 \pm 3,0$ dB; $a_n = 3,18 \pm 1,5$ m/s²

YATO	[V d.c.]	Battery capacity / Pojemność akumulatora [mAh]	⏱ [h]	Battery quantity / Liczba akumulatorów w zestawie	
YT-82360	18	4000	3	1	2
YT-82361	18	-	-	brak	2

EN Cordless vacuum cleaner
PL Odkurzacz akumulatorowy
DE Akku-Staubsauger
RU Аккумуляторный пылесос
CZ Akumulátorový vysavač
HU Akkumulátoros porszívó
RO Aspirator fără acumulator
FR Aspirateur sans-fil
IT Aspirapolvere a batteria
ES Aspirador a batería
CN 充电式吸尘器



Battery not included
Obrze Akku / Bez akumulatora
Bez Gamapeu / Bez aku
Akumulator nélkül
Fără baterie / Sans batterie
Senza batteria / Sin batería
没有电池

18V
Li-Ion

YATO	[V d.c.]			
YT-85680	18			4

EN Cordless hybrid air fan
PL Akumulatorowy wentylator hybrydowy
DE Akku-Ventilator
RU Аккумуляторный вентилятор гибридный
CZ Bateriový ventilátor
HU Akkumulátoros ventilátor
RO Ventilator fără acumulator
FR Ventilateur sans-fil
IT Ventilatore ibrido a batteria
ES Ventilador a batería
CN 充电式风扇



Battery not included
Obrze Akku / Bez akumulatora
Bez Gamapeu / Bez aku
Akumulator nélkül
Fără baterie / Sans batterie
Senza batteria / Sin batería
没有电池

18V
Li-Ion

YATO	[V d.c.]	
YT-82933	18	2

EN Cordless worksite radio
PL Akumulatorowe radio budowlane
DE Akku-Baustellenradio
RU Аккумуляторное строительное радио
CZ Akumulátorové rádio na stavbu
HU Akkus építkezési rádió
RO Radio pt. atelier fără acumulator
FR Radio d'atelier sans-fil
IT Radio da officina a batteria
ES Radio de obra a batería
CN 蓝牙收音机



Battery not included
Obrze Akku / Bez akumulatora
Bez Gamapeu / Bez aku
Akumulator nélkül
Fără baterie / Sans batterie
Senza batteria / Sin batería
没有电池

18V
Li-Ion

YATO	[V d.c.]	
YT-82940	18	8

EN Cordless transfer pump for oil and water
PL Akumulatorowa pompa do oleju i wody
DE Akku-Pumpe
RU Аккумуляторный перекачивающий насос
CZ Akumulátorové čerpadlo
HU Akkus szivattyú
RO Pompă de apă și ulei cu acumulator
FR Pompe à batterie
IT Pompa a batteria per olio e acqua
ES Bomba de batería
CN 无绳水&机油泵



18V
Li-Ion

YATO	[V d.c.]	Battery capacity / Pojemność akumulatora [mAh]	⏱ [h]	Battery quantity / Liczba akumulatorów w zestawie	
YT-85290	18	3000	1.5	1	2
YT-85291	18	-	-	brak	2

EN Battery
 PL Akumulator
 DE Akkumulator
 RU Аккумулятор
 CZ Akumulátor
 HU Akkumulátor
 RO Acumulator
 FR Batterie
 IT Batteria
 ES Bateria
 CN 锂电池包

18V **2.0**



YATO	[V d.c.]	[mAh]	[min]	
YT-828461	18	2000	60 (YT-82848, YT-82849, YT-828498, YT-828499), 35 (YT-828500, YT-828501), 35 (YT-828502)	20

EN Battery
 PL Akumulator
 DE Akkumulator
 RU Аккумулятор
 CZ Akumulátor
 HU Akkumulátor
 RO Acumulator
 FR Batterie
 IT Batteria
 ES Bateria
 CN 锂电池包

18V **4.0**



YATO	[V d.c.]	[mAh]	[min]	
YT-828463	18	4000	120 (YT-82848, YT-82849, YT-828498, YT-828499), 55 (YT-828500, YT-828501), 32 (YT-828502)	20

EN Battery
 PL Akumulator
 DE Akkumulator
 RU Аккумулятор
 CZ Akumulátor
 HU Akkumulátor
 RO Acumulator
 FR Batterie
 IT Batteria
 ES Bateria
 CN 锂电池包

18V **9.0**



YATO	[V d.c.]	[mAh]	[min]	
YT-828465	18	9000	270 (YT-82848, YT-82849, YT-828498, YT-828499), 120 (YT-828500, YT-828501), 54 (YT-828502)	20

EN Battery
 PL Akumulator
 DE Akkumulator
 RU Аккумулятор
 CZ Akumulátor
 HU Akkumulátor
 RO Acumulator
 FR Batterie
 IT Batteria
 ES Bateria
 CN 锂电池包

18V **3.0**



YATO	[V d.c.]	[mAh]	[min]	
YT-828462	18	3000	90 (YT-82848, YT-82849, YT-828498, YT-828499), 40 (YT-828500, YT-828501), 24 (YT-828502)	20

EN Battery
 PL Akumulator
 DE Akkumulator
 RU Аккумулятор
 CZ Akumulátor
 HU Akkumulátor
 RO Acumulator
 FR Batterie
 IT Batteria
 ES Bateria
 CN 锂电池包

18V **6.0**



YATO	[V d.c.]	[mAh]	[min]	
YT-828464	18	6000	180 (YT-82848, YT-82849, YT-828498, YT-828499), 78 (YT-828500, YT-828501), 36 (YT-828502)	20

EN Battery charger
 PL Ładowarka
 DE Ladegerät
 RU Зарядное устройство
 CZ Nabíječka
 HU Töltő
 RO Încărcător
 FR Chargeur
 IT Caricabatteria
 ES Cargador
 CN 充电器

18V **2.2**



YATO	[V d.c.]	[min]	
YT-828498	18	60 (YT-828461), 90 (YT-828462), 120 (YT-828463), 180 (YT-828464), 270 (YT-828465)	24

EN Battery charger
PL Ładowarka
DE Ladegerät
RU Зарядное устройство
CZ Nabíječka
HU Töltő
RO Încărcător
FR Chargeur
IT Caricabatteria
ES Cargador
CN 充电器

forida: **18V**
Li-Ion

2.4A
x2



YATO	[V d.c.]	⏱ [min]	📦
YT-828499	18	60 (YT-828461), 90 (YT-828462), 120 (YT-828463), 180 (YT-828464), 270 (YT-828465)	16

EN Battery charger
PL Ładowarka
DE Ladegerät
RU Зарядное устройство
CZ Nabíječka
HU Töltő
RO Încărcător
FR Chargeur
IT Caricabatteria
ES Cargador
CN 充电器

forida: **18V**
Li-Ion

4.5
A





YATO	[V d.c.]	⏱ [min]	📦
YT-828500	18	35 (YT-828461), 40 (YT-828462), 55 (YT-828463), 78 (YT-828464), 120 (YT-828465)	24

EN Battery charger
PL Ładowarka
DE Ladegerät
RU Зарядное устройство
CZ Nabíječka
HU Töltő
RO Încărcător
FR Chargeur
IT Caricabatteria
ES Cargador
CN 充电器

forida: **18V**
Li-Ion

4.5A
x2



YATO	[V d.c.]	⏱ [min]	📦
YT-828501	18	35 (YT-828461), 40 (YT-828462), 55 (YT-828463), 78 (YT-828464), 120 (YT-828465)	16

EN Battery charger
PL Ładowarka
DE Ladegerät
RU Зарядное устройство
CZ Nabíječka
HU Töltő
RO Încărcător
FR Chargeur
IT Caricabatteria
ES Cargador
CN 充电器

forida: **18V**
Li-Ion

12A



YATO	[V d.c.]	⏱ [min]	📦
YT-828502	18	35 (YT-828461), 24 (YT-828462), 32 (YT-828463), 36 (YT-828464), 54 (YT-828465)	12

EN Car battery charger
PL Ładowarka samochodowa
DE Autoladegerät
RU Зарядное устройство автомобильное
CZ Automobilová nabíječka
HU Autós töltő
RO Încărcător auto
FR Chargeur de voiture
IT Caricabatteria da auto
ES Cargador para coche
CN 车充

forida: **18V**
Li-Ion

2A

USB



YATO	[V d.c.]	⏱ [min]	📦
YT-828503	18	70 (YT-828461), 100 (YT-828462), 135 (YT-828463), 200 (YT-828464), 300 (YT-828465)	40

EN Solar and car battery charger
PL Ładowarka solarno-samochodowa
DE Solar-Autoladegerät
RU Солнечное автомобильное зарядное устройство
CZ Solární a automobilová nabíječka
HU Napelemes-autós töltő
RO Încărcător solar și auto
FR Chargeur de voiture solaire
IT Caricabatteria da auto solare
ES Cargador solar para coche
CN 车充+太阳能

forida: **18V**
Li-Ion

2A

☀

USB



YATO	[V d.c.]	⏱ [min]	📦
YT-828504	18	70 (YT-828461), 100 (YT-828462), 135 (YT-828463), 200 (YT-828464), 300 (YT-828465)	4

EN Power cutter
 PL Przecinarka spalnowa
 DE Trennschleifer
 RU Бензиновый бензопес
 CZ Rozbrušovací pila
 HU Beton- és fémdarabolók

RO Mașină de debitat
 FR Découpeuse
 IT Troncatrice con motore a combustione interna
 ES La cortadora
 CN 汽油切割机

4 kW	4700 min ⁻¹	93.6 cm ²
1/2" 12.7mm WATER COUPLING PREFACE WOOD	400x25.4 mm	145 mm
40 : 1	1L	



Disc not included
 Tarczy nie dołączono

$L_{pa} = 93,35 \pm 2,5 / 107,95 \pm 2,5$ dB; $L_{wa} = 112,33 \pm 2,5 / 115,5 \pm 2,5$ dB;
 $a_p = 6,99 \pm 1,5 / 7,79 \pm 1,5 / 10,26 \pm 1,5 / 9,77 \pm 1,5$ m/s²

YATO	[kW]	
YT-84820	4	1

EN Petrol demolition hammer
 PL Spalinowy młot wyburzeniowy
 DE Benzin-Abbruchhammer
 RU Бензиновый отбойный молоток
 CZ Benzinové bourací kladivo
 HU Benzines bontókalapács
 RO Ciocan demolator cu benzină
 FR Marteau piqueur essence
 IT Martello demolitore a scoppio
 ES Martillo demoleador a gasolina
 CN 汽油锤

30 mm	1.3 kW	51.7 cm ²	1500 min ⁻¹
20-55J	1.1 L		



$L_{pa} = 83,0 \pm 3,0$ dB; $L_{wa} = 104,0$ dB; $a_p = 31,87 \pm 1,5 / 31,10 \pm 1,5$ m/s²

YATO	[kW]	[KM]
YT-82007	1.3	1.74

EN Petrol rotary hammer
 PL Spalinowy młot udarowo-obrotowy
 DE Benzin Bohr- und Meißelhammer
 RU Бензиновый перфоратор
 CZ Benzinové kombinované kladivo
 HU Benzines forgó bontókalapács
 RO Ciocan rotopercutor cu benzină
 FR Marteau rotatif essence
 IT Martello combinato perforatore demolitore a benzina
 ES Martillo giratorio a gasolina
 CN 汽油锤

SDS MAX	1.3 kW	51.7 cm ²	3200 min ⁻¹
30-35J	1.3 L		



$L_{pa} = 84,0 \pm 3,0$ dB; $L_{wa} = 105,0$ dB; $a_p = 10,76 \pm 1,5 / 18,39 \pm 1,5$ m/s²

YATO	[kW]	[KM]
YT-82138	1.3	1.74

EN Straight grinder
 PL Szlifierka prosta
 DE Geradschleifer
 RU Прямая шлифмашина
 CZ Přímá bruska
 HU Egyenes csiszoló

RO Polizor drept
 FR Meuleuse droite
 IT Smerigliatrice dritta
 ES Amoladora recta
 CN 直磨机

230-240V-50Hz	750 W	10000-30000 min ⁻¹
6.0 mm	3 m	



$L_{pa} = 75,0 \pm 3,0$ dB; $L_{wa} = 85,0 \pm 3,0$ dB; $a_p = 2,5 \pm 1,5$ m/s²

YATO	[W]
YT-82080	750

EN Angle grinder
 PL Szlifierka kątowa
 DE Winkelschleifmaschine
 RU Углошлифовальная машина
 CZ Úhlová bruska
 HU Sarokcsiszoló

RO Polizor unghiular
 FR Meuleuse d'angle
 IT Smerigliatrice angolare
 ES Amoladora angular
 CN 角磨

230V~50Hz	850 W	12000 min ⁻¹	125 mm
M14	3 m		



$L_{pa} = 87,3 \pm 3,0$ dB; $L_{wa} = 98,3 \pm 3,0$ dB; $a_p = 3,378 \pm 1,5 / 4,746 \pm 1,5$ m/s²

YATO	[W]
YT-82097	850

EN Angle grinder
 PL Szlifierka kątowa
 DE Winkelschleifmaschine
 RU Углошлифовальная машина
 CZ Úhlová bruska
 HU Sarokcsiszoló

RO Polizor unghiular
 FR Meuleuse d'angle
 IT Smerigliatrice angolare
 ES Amoladora angular
 CN 角磨

220-240V-50/60Hz	900 W	1300-4000 min ⁻¹	125 mm
INOX	M14	3 m	



$L_{pa} = 97,0 \pm 3,0$ dB; $L_{wa} = 105,0 \pm 3,0$ dB; $a_p = 8,2 \pm 1,5$ m/s²

YATO	[W]
YT-82096	900



EN Angle grinder
PL Szlifierka kątowa
DE Winkelschleifmaschine
RU Углошлифовальная машина
CZ Úhlová bruska
HU Sarokcsiszoló

RO Polizor unghiular
FR Meuleuse d'angle
IT Smerigliatrice angolare
ES Amoladora angular
CN 角磨

230V~50Hz
1100 W
11000 min⁻¹
125 mm
M14
2.5 m



$L_{pa} = 79,0 \pm 3,0$ dB; $L_{wa} = 90,0 \pm 3,0$ dB; $a_n = 3,98 \pm 1,5$ m/s²

YATO 	[W]	
YT-82100	1100	6



EN Angle grinder
PL Szlifierka kątowa
DE Winkelschleifmaschine
RU Углошлифовальная машина
CZ Úhlová bruska
HU Sarokcsiszoló

RO Polizor unghiular
FR Meuleuse d'angle
IT Smerigliatrice angolare
ES Amoladora angular
CN 角磨

230-240V~50Hz
1400 W
3000-12000 min⁻¹
125 mm
M14
3 m



$L_{pa} = 89,3 \pm 3,0$ dB; $L_{wa} = 100,3 \pm 3,0$ dB; $a_n = 6,95 \pm 1,5$ m/s²



YATO 	[W]	
YT-82098	1400	6

EN Angle grinder
PL Szlifierka kątowa
DE Winkelschleifmaschine
RU Углошлифовальная машина
CZ Úhlová bruska
HU Sarokcsiszoló
RO Polizor unghiular
FR Meuleuse d'angle
IT Smerigliatrice angolare
ES Amoladora angular
CN 角磨

230-240V~50Hz
1700 W
10500 min⁻¹
125 mm
M14
SOFT START MIEKKI START
3 m



$L_{pa} = 97,0 \pm 3,0$ dB; $L_{wa} = 105,0 \pm 3,0$ dB; $a_n = 4,5 \pm 1,5 / 6,0 \pm 1,5 / 2,8 \pm 1,5$ m/s²

YATO 	[W]	
YT-821023	1700	6

EN Angle grinder
PL Szlifierka kątowa
DE Winkelschleifmaschine
RU Углошлифовальная машина
CZ Úhlová bruska
HU Sarokcsiszoló



RO Polizor unghiular
FR Meuleuse d'angle
IT Smerigliatrice angolare
ES Amoladora angular
CN 角磨

230-240V~50Hz
1100 W
3000-12000 min⁻¹
125 mm
M14
SOFT START MIEKKI START
3 m



Fitting discs: see chapter 10
Pasujące tarcze: patrz rozdział 10

$L_{pa} = 87,3 \pm 3,0$ dB; $L_{wa} = 95,3 \pm 3,0$ dB; $a_n = 6,743 \pm 1,5$ m/s²

YATO 	[W]	
YT-82101	1100	8



EN Angle grinder
PL Szlifierka kątowa
DE Winkelschleifmaschine
RU Углошлифовальная машина
CZ Úhlová bruska
HU Sarokcsiszoló

RO Polizor unghiular
FR Meuleuse d'angle
IT Smerigliatrice angolare
ES Amoladora angular
CN 角磨

230-240V~50Hz
1400 W
3000-12000 min⁻¹
125 mm
M14
3 m



$L_{pa} = 89,3 \pm 3,0$ dB; $L_{wa} = 100,3 \pm 3,0$ dB; $a_n = 6,95 \pm 1,5$ m/s²



YATO 	[W]	
YT-82099	1400	6

EN Angle grinder
PL Szlifierka kątowa
DE Winkelschleifmaschine
RU Углошлифовальная машина
CZ Úhlová bruska
HU Sarokcsiszoló
RO Polizor unghiular
FR Meuleuse d'angle
IT Smerigliatrice angolare
ES Amoladora angular
CN 角磨

230-240V~50Hz
1700 W
2850-10500 min⁻¹
125 mm
M14
SOFT START MIEKKI START
3 m



$L_{pa} = 97,0 \pm 3,0$ dB; $L_{wa} = 105,0 \pm 3,0$ dB; $a_n = 4,5 \pm 1,5 / 6,0 \pm 1,5 / 2,8 \pm 1,5$ m/s²

YATO 	[W]	
YT-821024	1700	6

EN Angle grinder
 PL Szlifierka kątowna
 DE Winkelschleifmaschine
 RU Углошлифовальная машина
 CZ Úhlová bruska
 HU Sarokcsiszoló

RO Polizor unghiular
 FR Meuleuse d'angle
 IT Smerigliatrice angolare
 ES Amoladora angular
 CN 角磨

220-240V~50Hz
2000 W
 8500 min⁻¹
 180 mm
M14
 3 m



$L_{pa} = 92,5 \pm 3,0$ dB; $L_{wa} = 103,5 \pm 3,0$ dB; $a_n = 7,03 \pm 1,5$ m/s²

YATO	[W]	
YT-82104	2000	4

EN Angle grinder
 PL Szlifierka kątowna
 DE Winkelschleifmaschine
 RU Углошлифовальная машина
 CZ Úhlová bruska
 HU Sarokcsiszoló
 RO Polizor unghiular
 FR Meuleuse d'angle
 IT Smerigliatrice angolare
 ES Amoladora angular
 CN 角磨

230-240V~50Hz
2600 W
 2800-6500 min⁻¹
 230 mm
M14
 SPEED REGULATOR REGULACJA PREDKOŚCI
 CONSTANT SPEED STABILIZACJA PREDKOŚCI
 SOFT START MIEKKI START
 3 m



• Pivot handle
 • Obrótowa rękojeść

$L_{pa} = 93,0 \pm 3,0$ dB; $L_{wa} = 101,0 \pm 3,0$ dB; $a_n = 7,72 \pm 1,5$ m/s²

YATO	[W]	
YT-82106	2600	2

EN Drill stand
 PL Statyw do wiertarki
 DE Bohrmaschinen-Ständer
 RU Стойка для дрели
 CZ Stativ do vrtačky
 HU Fúróállvány
 RO Suport masina de gaurit
 FR Support de forage
 IT Supporto per trapano
 ES Soporte para taladro
 CN 电钻支架



500 mm
 210x210 mm
 60mm
STROKE LENGTH (BLUGOSĆ SIŁKI)
 38-43mm

YATO	H [mm]	
YT-82970	500	3



EN Angle grinder
 PL Szlifierka kątowna
 DE Winkelschleifmaschine
 RU Углошлифовальная машина
 CZ Úhlová bruska
 HU Sarokcsiszoló

RO Polizor unghiular
 FR Meuleuse d'angle
 IT Smerigliatrice angolare
 ES Amoladora angular
 CN 角磨

220-230V~50Hz
2400 W
 6600 min⁻¹
 230 mm
M14
 3 m



$L_{pa} = 91,9 \pm 3,0$ dB; $L_{wa} = 102,9 \pm 3,0$ dB; $a_n = 7,448 \pm 1,5 / 5,2 \pm 1,5$ m/s²

YATO	[W]	
YT-82105	2400	2

EN Angle grinder
 PL Szlifierka kątowna
 DE Winkelschleifmaschine
 RU Углошлифовальная машина
 CZ Úhlová bruska
 HU Sarokcsiszoló

RO Polizor unghiular
 FR Meuleuse d'angle
 IT Smerigliatrice angolare
 ES Amoladora angular
 CN 角磨

230V~50Hz
2800 W
 6600 min⁻¹
 230 mm
M14
 3 m



$L_{pa} = 91,8 \pm 3,0$ dB; $L_{wa} = 102,8 \pm 3,0$ dB; $a_n = 4,478 \pm 1,5 / 4,956 \pm 1,5$ m/s²

YATO	[W]	
YT-82110	2800	2

EN Drill stand
 PL Statyw do wiertarki
 DE Bohrmaschinen-Ständer
 RU Стойка для дрели
 CZ Stativ do vrtačky
 HU Fúróállvány
 RO Suport masina de gaurit
 FR Support de forage
 IT Supporto per trapano
 ES Soporte para taladro
 CN 电钻支架



400 mm
 160x160 mm
 60mm
STROKE LENGTH (BLUGOSĆ SIŁKI)
 38-43mm

YATO	H [mm]	
YT-82971	400	6

EN Angle grinder stand
PL Statyw do szlifierki kątovej
DE Winkelschleif-Trennständer
RU Стойка для угловой шлифовальной машины
CZ Stojan pro úhlovou brusku
HU Állvány sarokcsiszolóhoz
RO Support pt. polizor unghiular
FR Support pour meuleuse d'angle
IT Supporto per smerigliatrice angolare
ES Soporte para amoladora angular
CN 角磨支架



YATO

YT-82972



4

EN Angle grinder stand
PL Statyw do szlifierki kątovej
DE Winkelschleif-Trennständer
RU Стойка для угловой шлифовальной машины
CZ Stojan pro úhlovou brusku
HU Állvány sarokcsiszolóhoz
RO Support pt. polizor unghiular
FR Support pour meuleuse d'angle
IT Supporto per smerigliatrice angolare
ES Soporte para amoladora angular
CN 角磨支架

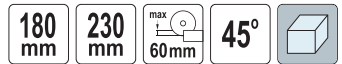

YATO

YT-82976



3

EN Universal guide rail with clamps
PL Prowadnica uniwersalna ze ściskami
DE Universal-Führungsschiene mit Zwingen
RU Шина направляющая универсальная с зажимами
CZ Univerzální vodící lišta se svorkami
HU Univerzális vezetősin kézi körfűrészekhez
RO Șină de ghidaj pt. fierăstrău circular
FR Rail de guidage universel avec pinces
IT Guida universale con morsetti
ES Carril de guía universal con pinzas
CN 电圆锯用导轨组套



YATO

YT-36990

L [mm]

1500



5



EN Dust extraction shroud
PL Osłona przeciwpylowa
DE Staubabsaugung
RU Насадка-пылеуловитель
CZ Nástavec na odsávání prachu
HU Fűrógép porelszívó adapter
RO Sistem de aspirare a prafului
FR Carter d'aspiration
IT Cuffia aspirazione polvere
ES Sistema de aspiración de polvo
CN 防尘罩

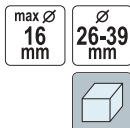

YATO

YT-82980



40

EN Dust extraction shroud
PL Osłona przeciwpylowa
DE Staubabsaugung
RU Насадка-пылеуловитель
CZ Nástavec na odsávání prachu
HU Fűrógép porelszívó adapter
RO Sistem de aspirare a prafului
FR Carter d'aspiration
IT Cuffia aspirazione polvere
ES Sistema de aspiración de polvo
CN 防尘罩

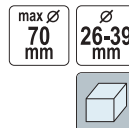

For YT-6045, YT-60374, YT-43979
Dla YT-6045, YT-60374, YT-43979

YATO

YT-82982



30

EN Dust extraction shroud
PL Osłona przeciwpylowa
DE Staubabsaugung
RU Насадка-пылеуловитель
CZ Nástavec na odsávání prachu
HU Fűrógép porelszívó adapter
RO Sistem de aspirare a prafului
FR Carter d'aspiration
IT Cuffia aspirazione polvere
ES Sistema de aspiración de polvo
CN 防尘罩

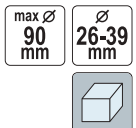

For YT-6046, YT-60375, YT-43981
Dla YT-6046, YT-60375, YT-43981

YATO

YT-82984



18

EN Dust extraction shroud
 PL Osłona przeciwpylowa
 DE Absaughaube
 RU Кожух защитный вытяжной
 CZ Kryt na odsávání prachu
 HU Sarokcsiszoló porszívó adapter
 RO Sistem de aspirare a prafului
 FR Carter d'aspiration
 IT Cuffia aspirazione polvere
 ES Sistema de aspiración de polvo
 CN 角磨机防尘罩

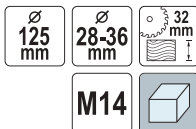

For YT-82098, YT-82099, YT-60470
 Dla YT-82098, YT-82099

YATO	
YT-82986	12

EN Dust extraction shroud
 PL Osłona przeciwpylowa
 DE Absaughaube
 RU Кожух защитный вытяжной
 CZ Kryt na odsávání prachu
 HU Sarokcsiszoló porszívó adapter
 RO Sistem de aspirare a prafului
 FR Carter d'aspiration
 IT Cuffia aspirazione polvere
 ES Sistema de aspiración de polvo
 CN 角磨机防尘罩

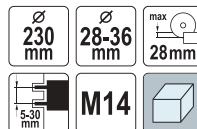

For YT-82098, YT-82099, YT-56961
 Dla YT-82098, YT-82099, YT-56961

YATO	
YT-82988	10

EN Dust extraction shroud
 PL Osłona przeciwpylowa
 DE Absaughaube
 RU Кожух защитный вытяжной
 CZ Kryt na odsávání prachu
 HU Sarokcsiszoló porszívó adapter
 RO Sistem de aspirare a prafului
 FR Carter d'aspiration
 IT Cuffia aspirazione polvere
 ES Sistema de aspiración de polvo
 CN 角磨机防尘罩

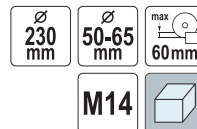

For YT-82110, YT-59965
 Dla YT-82110, YT-59965

YATO	
YT-82990	4

EN Dust extraction shroud
 PL Osłona przeciwpylowa
 DE Absaughaube
 RU Кожух защитный вытяжной
 CZ Kryt na odsávání prachu
 HU Sarokcsiszoló porszívó adapter
 RO Sistem de aspirare a prafului
 FR Carter d'aspiration
 IT Cuffia aspirazione polvere
 ES Sistema de aspiración de polvo
 CN 角磨机防尘罩

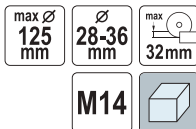

For YT-82094, YT-82097, YT-82100, YT-82101
 Dla YT-82094, YT-82097, YT-82100, YT-82101

YATO	
YT-82992	20

EN Dust extraction shroud
 PL Osłona przeciwpylowa
 DE Absaughaube
 RU Кожух защитный вытяжной
 CZ Kryt na odsávání prachu
 HU Sarokcsiszoló porszívó adapter
 RO Sistem de aspirare a prafului
 FR Carter d'aspiration
 IT Cuffia aspirazione polvere
 ES Sistema de aspiración de polvo
 CN 角磨机防尘罩

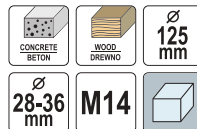

Dla YT-82098, YT-82101
 Pasujące tarcze: YT-60322, YT-83265

YATO	
YT-82994	30

EN Dust extraction shroud
 PL Osłona przeciwpylowa
 DE Absaughaube
 RU Кожух защитный вытяжной
 CZ Kryt na odsávání prachu
 HU Sarokcsiszoló porszívó adapter
 RO Sistem de aspirare a prafului
 FR Carter d'aspiration
 IT Cuffia aspirazione polvere
 ES Sistema de aspiración de polvo
 CN 角磨机防尘罩

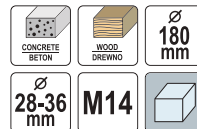

YATO	
YT-82995	10

EN Slider for grinding tiles
 PL Przystawka do szlifowania płytek pod kątem
 DE Kantenschleiferaufsatz für handgeführte Gehrungsschnitte
 RU Насадка для резки плитки под углом
 CZ Nástavec na broušení dlaždic pod úhlem
 HU Sarokcsiszoló tartozék gérvágáskhoz
 RO Ghidaj pt. teșirea plăcilor ceramice
 FR Accessoire pour meuluse d'angle pour coupes d'onglet
 IT Adattatore per smussatura di piastrelle
 ES Adaptador para cortar azulejos en ángulo
 CN 切割支架



YATO	
YT-82985	10

EN Concrete grinder
 PL Szlifierka do betonu
 DE Betonschleifer
 RU Бетоншлифовальная машина
 CZ Bruska na beton
 HU Betoncsiszoló
 RO Șlefuitor pt. beton
 FR Ponceuse à béton
 IT Levigatrice per calcestruzzo
 ES Lijadora de hormigón
 CN 粗刨机



$L_{pa} = 95,0 \pm 3,0$ dB;
 $L_{wa} = 103,0 \pm 3,0$ dB;
 $a_{sA} = < 2,5 \pm 1,5$ m/s²

YATO	[W]	
YT-82163	1500	1

EN Electric nibbler
PL Nożyce elektryczne do blachy
DE Elektrische Blechscher
RU Листовые ножницы по металлу
CZ Elektrický prostřihovač plechu
HU Elektromos lemezvágó olló
RO Foarfecă electrică pt. tablă
FR Grignoteuse électrique
IT Cesoia elettrica per lamiera
ES Cizalla eléctrica para chapa
CN 电冲剪



230-240V~
50Hz
600 W
2000 min⁻¹
max
1,8 mm
STEEL
STAL

EN Spare nibbler blade
PL Ostrze do nożyc elektrycznych
DE Ersatzmesser für elektrische Blechscher
RU Запасное лезвие для электрических ножниц
CZ Razník do prostřihovače plechu
HU Tartalék penge ollóhoz
RO Lama rezervă pt. foarfecă electrică tablă
FR Lame pour cisailles électriques
IT Lama di ricambio per cesoia elettrica
ES Cuchilla para cizalla eléctrica
CN 冲针

2
PCS
5.0 mm
57 mm
HSS

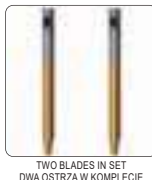

For YT-82395
Dla YT-82395

$L_{pa} = 88,0 \pm 3,0$; $L_{wa} = 99,0 \pm 3,0$; $a_h = 11,57 \pm 1,5$ m/s²

YATO	[W]	
YT-82395	600	5

YATO	Ø [mm]	
YT-82396	5	500

EN Wall chaser
PL Bruzdownica
DE Mauernutfräse
RU Штроборез сетевой
CZ Drážkovací fréza do zdiva
HU Falhoronyarógép
RO Debitator canale zidărie
FR Rainureuse à béton
IT Scanalatrice
ES Máquina de ranurado de pared
CN 开槽机

230-240V~
50Hz
1700 W
10500 min⁻¹
125x2.0x
22.23mm
max
28 mm
5-30 mm
M14
REINFORCED
CONCRETE
ZELBET
3 m



For YT-59962
Dla YT-59962

$L_{pa} = 93,0 \pm 3,0$ dB; $L_{wa} = 105,0 \pm 3,0$ dB; $a_h = 2,8 \pm 1,5$ m/s²

YATO	[W]	
YT-82015	1700	4

EN Wet stone polisher
PL Polerka do kamienia na mokro
DE Nass-Steinpolierer
RU Воздушно-мокрый полировщик для камня
CZ Leštící na kámen za mokra
HU Vizes köcsiszoló
RO Slefuitor umed piatra
FR Polisseuse à pierre humide
IT Lucidatrice per pietra a umido
ES Pulidora para piedra en mojado
CN 水磨机

220-240V~
50/60Hz
1300 W
1300-4200 min⁻¹
100 mm
M14
GRANITE
GRANIT
GRES
TILE
GRES
SPEED
REGULATOR
REGULACJA
PREDKOŚCI
WET
AND DRY
SUCHO
I MOKRO
3 m



$L_{pa} = 85,0 \pm 3,0$ dB; $L_{wa} = 93,0 \pm 3,0$ dB; $a_h = 5,58 \pm 1,5$ m/s²

YATO	[W]	
YT-82161	1300	6

EN Concrete cutter
PL Przecinarka do betonu
DE Betonschneider
RU Электрическая отрезная машина по бетону
CZ Řezačka betonu
HU Betonvágó
RO Cutter pt. beton
FR Decoupeuse beton
IT Troncatrice per cemento
ES Cortador de hormigón
CN 混凝土切割机

220-240V~
50/60Hz
2600 W
4300 min⁻¹
355x25.4 mm
max
125 mm
M10
REINFORCED
CONCRETE
ZELBET
3 m



$L_{pa} = 99,0 \pm 3,0$ dB; $L_{wa} = 110,0 \pm 3,0$ dB; $a_h = 8,22 \pm 1,5$ m/s²

YATO	[W]	
YT-82158	2600	1

EN Electric tile cutter
PL Przecinarka do glazury
DE Fliesenschneider
RU Плиткозрез электрический
CZ Elektrická pila na dlažbu
HU Elektromos csempevago gép
RO Cutter gresie și piatră
FR Scie carrelage
IT Tagliapiastrelle
ES Cortadora de gres
CN 云石机

220-230V~
50Hz
1400 W
12000 min⁻¹
125 mm
125x22.2 x1.6 mm
WET
AND DRY
SUCHO
I MOKRO
CIRCUIT
BREAKER
WYŁACZNIK
ROZMOCOWO-
PRĄDOWY
3 m



$L_{pa} = 102,6 \pm 3,0$ dB; $L_{wa} = 113,6 \pm 3,0$ dB; $a_h = 5,753 \pm 1,5$ m/s²

YATO	[W]	
YT-82159	1400	4

EN Electric tile cutter
 PL Przecinarka do glazury
 DE Fliesenschneider
 RU Плиткорез электрический
 CZ Elektrická pila na dlažbu
 HU Elektromos csempévagó gép
 RO Cutter gresie și piatră
 FR Scie carrelage
 IT Tagliapiastrelle
 ES Cortadora de gres
 CN 云石机

220-240V~50Hz **1400 W** 12250 min⁻¹ 125 mm 1500 mm

ALUMINIUM HIGH QUALITY PROFILE FULLY METAL PROFILE HIGHEST QUALITY

45° 3m



- Vacuum cleaner connection
- Guide rail 1500 mm (3 x 500 mm) with clamps
- Przyłącze do odkurzacza
- Prowadnica 1500 mm (3 x 500 mm) ze ściskami

$L_{pa} = 91,0 \pm 3,0$ dB; $L_{wa} = 102,0 \pm 3,0$ dB; $a_n = 4,46 \pm 1,5$ m/s²

YATO	[W]	
YT-821591	1400	2

EN Car polisher
 PL Polerka samochodowa
 DE Autopoliermaschine
 RU Полировальная машина
 CZ Autoleštička
 HU Polírozógép
 RO Aparat de polișat
 FR Polisseuse de voiture
 IT Lucidatrice per auto
 ES Pulidora para coche
 CN 抛光机

220-240V~50Hz **720 W** 2100-5000 min⁻¹ 150 mm

M8

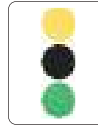

$L_{pa} = 85,0 \pm 3,0$ dB; $L_{wa} = 96,0 \pm 3,0$ dB; $a_n = 5,56 \pm 1,5$ m/s²

YATO	[W]	
YT-82200	720	4

EN Car polisher
 PL Polerka samochodowa
 DE Autopoliermaschine
 RU Полировальная машина
 CZ Autoleštička
 HU Polírozógép
 RO Aparat de polișat
 FR Polisseuse de voiture
 IT Lucidatrice per auto
 ES Pulidora para coche
 CN 抛光机

220-240V~50Hz **1400 W** 600-3500 min⁻¹

180 mm M14 5m



$L_{pa} = 89,5 \pm 3,0$ dB; $L_{wa} = 100,5 \pm 3,0$ dB; $a_n = 1,489 \pm 1,5 / 1,785 \pm 1,5$ m/s²

YATO	[W]	
YT-82196	1400	2

EN Grinding wheel cutter for metal
 PL Przecinarka ściernicowa do metalu
 DE Trennschleifer für Metall
 RU Абразивно-отрезной станок по металлу
 CZ Rozbrušovací pila na kovy
 HU Gyorsdaraboló fémhez
 RO Fierăstrău pt. metal
 FR Scie a métaux
 IT Trapano a percussione
 ES Cortador abrasivo para metales
 CN 型材切割机

230V~50Hz **2450 W** 4000 min⁻¹ 355x25.4 mm

0-45°

SOFT START MIEKKI START

LONG LIFE MOTOR TRWAŁY SILNIK

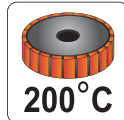

$L_{pa} = 95,8 \pm 3,0$ dB; $L_{wa} = 108,8 \pm 3,0$ dB

YATO	[W]	
YT-82181	2450	1

EN Band saw
 PL Pila taśmowa
 DE Bandsäge
 RU Ленточная пила
 CZ Pásová pila
 HU Szalagfűrész
 RO Fierăstrău cu banda
 FR Scie à ruban
 IT Sega a nastro
 ES Sierra de cinta
 CN 带锯

220-240V~50Hz **1100 W** 0.7-2.4 m/s

14 TPI 1140x12.7x0.6 mm 127 mm

3m



$L_{pa} = 89,0 \pm 3,0$ dB; $L_{wa} = 100,0 \pm 3,0$ dB; $a_n = 6,62 \pm 1,5 / 6,08 \pm 1,5$ m/s²

YATO	[W]	
YT-82185	1100	1

EN Impact drill
 PL Wiertarka udarowa
 DE Schlagbohrmaschine
 RU Ударная дрель
 CZ Příklepová vrtačka
 HU Ütvefűró

220-240V~50Hz **710 W**

0-2800 min⁻¹ 0-44800 min⁻¹

25 mm 13 mm

13 mm

3m



$L_{pa} = 80,0 \pm 3,0$ dB; $L_{wa} = 91,0 \pm 3,0$ dB; $a_n = 2,95 \pm 1,5 / 8,46 \pm 1,5$ m/s²

YATO	[W]	
YT-82034	710	5

EN Impact drill
PL Wiertarka udarowa
DE Schlagbohrmaschine
RU Ударная дрель
CZ Pŕiklepová vrtačka
HU Útvefűró

RO Bormașină cu percúție
FR Perceuse à percussion
IT Trapano a percussione
ES Taladro de percusión
CN 冲击钻



$L_{pA} = 87,0 \pm 3,0$ dB; $L_{wA} = 98,0 \pm 3,0$ dB; $a_h = 2,29 \pm 1,5 / 8,5 \pm 1,5$ m/s²

YATO	[W]	
YT-82036	810	5

EN Impact drill
PL Wiertarka udarowa
DE Schlagbohrmaschine
RU Ударная дрель
CZ Pŕiklepová vrtačka
HU Útvefűró

RO Bormașină cu percúție
FR Perceuse à percussion
IT Trapano a percussione
ES Taladro de percusión
CN 冲击钻

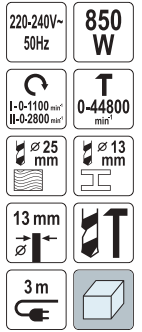

$L_{pA} = 89,0 \pm 3,0$ dB; $L_{wA} = 100,0 \pm 3,0$ dB; $a_h = 2,39 \pm 1,5 / 8,78 \pm 1,5$ m/s²

YATO	[W]	
YT-82037	850	5

EN Impact drill
PL Wiertarka udarowa
DE Schlagbohrmaschine
RU Ударная дрель
CZ Pŕiklepová vrtačka
HU Útvefűró

RO Bormașină cu percúție
FR Perceuse à percussion
IT Trapano a percussione
ES Taladro de percusión
CN 冲击钻



$L_{pA} = 97,0 \pm 3,0$ dB; $L_{wA} = 108,0 \pm 3,0$ dB; $a_h = 2,85 \pm 1,5 / 10,1 \pm 1,5$ m/s²

YATO	[W]	
YT-82044	1050	5

EN Impact drill
PL Wiertarka udarowa
DE Schlagbohrmaschine
RU Ударная дрель
CZ Pŕiklepová vrtačka
HU Útvefűró

RO Bormașină cu percúție
FR Perceuse à percussion
IT Trapano a percussione
ES Taladro de percusión
CN 冲击钻

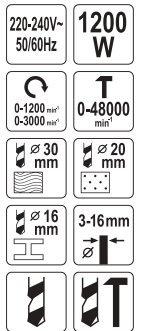

$L_{pA} = 82,0 \pm 5,0$ dB; $L_{wA} = 93,0 \pm 5,0$ dB; $a_h = 12,2 \pm 1,5 / 2,2 \pm 1,5$ m/s²

YATO	[W]	
YT-82045	1200	5

EN Electric drill/driver
PL Wiertarko-wkrętarzka sieciowa
DE Netz-Bohrschrauber
RU Сетевая дрель-шуруповерт
CZ Elektrický vrtací šroubovák
HU Hálózati fűró-csavarozó

RO Mașină de găurit și înșurubat (bormasina) electrică
FR Foret électrique
IT Trapano avvitatore elettrico
ES Taladro atornillador eléctrico
CN 扭力钻



$L_{pA} = 83,1 \pm 3,0$ dB; $L_{wA} = 94,1 \pm 3,0$ dB; $a_h = 3,32 \pm 1,5$ m/s²

YATO	[W]	
YT-82060	300	6

EN Electric drill/driver
PL Wiertarko-wkrętarzka sieciowa
DE Netz-Bohrschrauber
RU Сетевая дрель-шуруповерт
CZ Elektrický vrtací šroubovák
HU Hálózati fűró-csavarozó

RO Mașină de găurit și înșurubat (bormasina) electrică
FR Foret électrique
IT Trapano avvitatore elettrico
ES Taladro atornillador eléctrico
CN 扭力钻

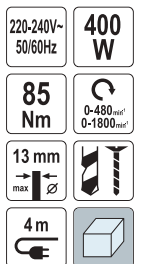

$L_{pA} = 88,0 \pm 5,0$ dB; $L_{wA} = 99,0 \pm 5,0$ dB; $a_h = 6,57 \pm 1,5$ m/s²

YATO	[W]	
YT-82063	400	8

EN Drywall screwdriver
 PL Wkrętarka taśmowa
 DE Trockenbauschrauber
 RU Шуруповёрт для гипсокартона
 CZ Sádrotkartonářský šroubovák
 HU Gipszkarton csavarzó

RO Şurubelniţă pt. gips-carton
 FR Visseuse à placo
 IT Avvitatore per cartongesso
 ES Atornillador para cartón yeso
 CN 墙板螺丝刀

230-240V~50Hz

550 W

0-5500 min⁻¹

1/4" 6.3 mm

25-55 x3.5 mm

3 m



$L_{pa} = 81,9 \pm 3,0$ dB; $L_{wa} = 92,9 \pm 3,0$ dB; $a_n = 0,53 \pm 1,5$ m/s²

YATO	[W]	
YT-82071	550	5

EN Diamond drill
 PL Wiertnica diamentowa
 DE Diamantbohrmaschine
 RU Дрель алмазного сверления
 CZ Diamantová vrtačka
 HU Gyémántfűrőgép

RO Maşină de carolat
 FR Appareil de forage diamant
 IT Perforatrice diamantata
 ES Taladradora de diamante
 CN 水钻

230V~50Hz

2200 W

1200 min⁻¹

∅180 mm

1 1/4" 32 mm

1/4" 6.3 mm WATER COUPLING PREPLACED WOOD

REINFORCED CONCRETE ZELBET



Fitting core drill bits: see chapter 10
 Fitting water tank: YT-86211
 Pasujące wiertła koronowe: patrz rozdział 10
 Pasujaca hidronetka: YT-86211

$L_{pa} = 90,0 \pm 3,0$ dB; $L_{wa} = 103,0 \pm 3,0$ dB; $a_n = 2,90 \pm 1,5$ m/s²

YATO	[W]	
YT-81980	2200	1

EN Diamond drill
 PL Wiertnica diamentowa
 DE Diamantbohrmaschine
 RU Дрель алмазного сверления
 CZ Diamantová vrtačka
 HU Gyémántfűrőgép
 RO Maşină de carolat
 FR Appareil de forage diamant
 IT Perforatrice diamantata
 ES Taladradora de diamante
 CN 水钻



Fitting core drill bits: see chapter 10
 Fitting water tank: YT-86211

Pasujące wiertła koronowe: patrz rozdział 10
 Pasujaca hidronetka: YT-86211

$L_{pa} = 92,4 \pm 3,0$ dB; $L_{wa} = 105,4 \pm 3,0$ dB

YATO	[W]	
YT-81983	2800	1

EN Rotary hammer
 PL Miłotwiertarka
 DE Bohrhämmer
 RU Перфоратор
 CZ Vrtací kladivo
 HU Fűrőkalapács

RO Ciocan rotopercutor
 FR Marteau perforateur
 IT Martello perforatore
 ES Martillo perforador
 CN 电锤

220-240V~50Hz

SDS PLUS

850 W

0-1300 min⁻¹

T 0-5100 min⁻¹

3.3 J

∅30 mm

∅32 mm

∅13 mm

3 m



$L_{pa} = 92,3 \pm 3,0$ dB; $L_{wa} = 103,3 \pm 3,0$ dB; $a_n = 11,964 \pm 1,5 / 10,037 \pm 1,5$ m/s²

YATO	[W]	
YT-82122	850	3

EN Rotary hammer
 PL Miłotwiertarka
 DE Bohrhämmer
 RU Перфоратор
 CZ Vrtací kladivo
 HU Fűrőkalapács

RO Ciocan rotopercutor
 FR Marteau perforateur
 IT Martello perforatore
 ES Martillo perforador
 CN 电锤



$L_{pa} = 95,0 \pm 3,0$ dB; $L_{wa} = 106,0 \pm 3,0$ dB; $a_n = 14,65 \pm 1,5 / 12,77 \pm 1,5$ m/s²

YATO	[W]	
YT-82123	1100	2

EN Rotary hammer
 PL Miłotwiertarka
 DE Bohrhämmer
 RU Перфоратор
 CZ Vrtací kladivo
 HU Fűrőkalapács

RO Ciocan rotopercutor
 FR Marteau perforateur
 IT Martello perforatore
 ES Martillo perforador
 CN 电锤



$L_{pa} = 95,0 \pm 3,0$ dB; $L_{wa} = 109,0 \pm 3,0$; $a_n = 15,91 \pm 1,5 / 12,97 \pm 1,5$ m/s²

YATO	[W]	
YT-82118	1100	2

EN Rotary hammer
PL Młot wiertarka
DE Bohrhammer
RU Перфоратор
CZ Vrtací kladivo
HU Fúrókalapács

RO Ciocan rotopercutor
FR Marteau perforateur
IT Martello perforatore
ES Martillo perforador
CN 电锤



$L_{pa} = 94,6 \pm 3,0$ dB; $L_{wa} = 105,6 \pm 3,0$ dB; $a_h = 19,167 \pm 1,5 / 13,314 \pm 1,5$ m/s²

YATO	[W]	
YT-82127	1500	2

EN Rotary hammer
PL Młot udarowo-obrotowy
DE Bohrhammer
RU Перфоратор
CZ Rotační kladivo
HU Forgókalapács

RO Ciocan rotopercutor
FR Marteau perforateur
IT Martello rotativo
ES Rotomartillo
CN 电锤



$L_{pa} = 96,1 \pm 3,0$ dB; $L_{wa} = 107,1 \pm 3,0$ dB; $a_h = 22,31 \pm 1,5 / 20,91 \pm 1,5$ m/s²

YATO	[W]	
YT-82135	1600	1

EN Demolition hammer
PL Młot wyburzeniowy
DE Abbruchhammer
RU Отбойный молоток
CZ Bourací kladivo
HU Bontókalapács
RO Ciocan demolator
FR Brise-béton
IT Martello demolitore
ES Martillo demoleador
CN 电镐



• Switch lock for continuous operation
• Blokada włącznika do pracy ciągłej

$L_{pa} = 94,0 \pm 3,0$ dB; $L_{wa} = 105,0 \pm 3,0$ dB; $a_h = 14,59 \pm 1,5$ m/s²

YATO	[W]	
YT-82001	1600	1

EN Rotary hammer
PL Młot udarowo-obrotowy
DE Bohrhammer
RU Перфоратор
CZ Rotační kladivo
HU Forgókalapács

RO Ciocan rotopercutor
FR Marteau perforateur
IT Martello rotativo
ES Rotomartillo
CN 电锤



$L_{pa} = 95,0 \pm 3,0$ dB; $L_{wa} = 106,0 \pm 3,0$ dB; $a_h = 20,93 \pm 1,5 / 23,19 \pm 1,5$ m/s²

YATO	[W]	
YT-82131	1300	2

EN Chiselling hammer
PL Młot dłutujący
DE Meißelhammer
RU Отбойный молоток
CZ Sekací kladivo
HU Vésőkalapács
RO Rotopercutor
FR Marteau-piqueur
IT Martello demolitore
ES Martillo demoleador
CN 电镐



$L_{pa} = 83,5 \pm 3,0$ dB; $L_{wa} = 97,5 \pm 2,4$ dB; $a_h = 15,546 \pm 1,5$ m/s²

YATO	[W]	
YT-82133	1150	2

EN Demolition hammer
PL Młot wyburzeniowy
DE Abbruchhammer
RU Отбойный молоток
CZ Bourací kladivo
HU Bontókalapács
RO Ciocan demolator
FR Brise-béton
IT Martello demolitore
ES Martillo demoleador
CN 电镐



• Switch lock for continuous operation
• Blokada włącznika do pracy ciągłej

$L_{pa} = 91,3 \pm 3,0$ dB; $L_{wa} = 100,4 \pm 2,42$ dB; $a_h = 14,59 \pm 1,5$ m/s²

YATO	[W]	
YT-82002	1600	1

- EN Concrete vibrator (motor and poker shaft)
- PL Wibrator do betonu (napęd i bulawa)
- DE Betonrüttler (Antrieb und Rüttelflasche)
- RU Глубинный вибратор для бетона (вал + наконечник)
- CZ Ponočný vibrátor (pohon i hadice)
- HU Betonvibrátor (meghajtás és tömlő)
- RO Vibrator beton (motor si lance)
- FR Vibreur à béton (moteur et arbre à tôle)
- IT Vibratore per calcestruzzo (motore e sonda)
- ES Vibrador de hormigón (motor y cabezal)
- CN 混凝土振动器

230V~50Hz 1200 W 5000 min⁻¹ 35 mm 3.5 m



$L_{pA} < 70$ dB; $L_{wA} < 85$ dB; $a_h < 2,5$ m/s²

YATO	[W]	
YT-82600	1200	1

- EN Concrete vibrator (motor and poker shaft)
- PL Wibrator do betonu (napęd i bulawa)
- DE Betonrüttler (Antrieb und Rüttelflasche)
- RU Глубинный вибратор для бетона (вал + наконечник)
- CZ Ponočný vibrátor (pohon i hadice)
- HU Betonvibrátor (meghajtás és tömlő)
- RO Vibrator beton (motor si lance)
- FR Vibreur à béton (moteur et arbre à tôle)
- IT Vibratore per calcestruzzo (motore e sonda)
- ES Vibrador de hormigón (motor y cabezal)
- CN 混凝土振动器

230V~50Hz 2300 W 4000 min⁻¹ 35 mm 4 m



$L_{pA} < 70$ dB; $L_{wA} < 85$ dB; $a_h < 2,5$ m/s²

YATO	[W]	
YT-82601	2300	1

- EN Cordless concrete vibrator (motor and poker shaft)
- PL Akumulatorowy wibrator do betonu (napęd i bulawa)
- DE Akku-Betonrüttler (Antrieb und Rüttelflasche)
- RU Аккумуляторный глубинный вибратор для бетона (вал + наконечник)
- CZ Akumulátorový ponočný vibrátor (pohon i hadice)
- HU Akkumulátoros betonvibrátor (meghajtás és tömlő)
- RO Vibrator beton fără acumulator (motor si lance)
- FR Vibreur à béton sans-fil (moteur et arbre à tôle)
- IT Vibratore per calcestruzzo a batteria (motore e sonda)
- ES Vibrador de hormigón a batería (motor y cabezal)
- CN 充电式混凝土振动器

18 V Li-Ion 3100 min⁻¹ 12500 min⁻¹ 1.2 m 25 mm



Battery not included
 Ohne Akku / Bez akumulatora
 Без аккумулятора / Bez aku
 Akkumulátor nélkül
 Fără baterie / Sans batterie
 Senza batteria / Sin batería
 没有电池

18V Li-Ion

$L_{pA} = 63,0 \pm 3,0$ dB; $L_{wA} = 74,0 \pm 3,0$ dB; $a_h = 3,2 \pm 1,5$ m/s²

YATO	[V d.c.]	
YT-82604	18	4

- EN Vibrating concrete screed
- PL Listwa wibracyjna do betonu
- DE Beton-Rüttelbohle
- RU Виброрейка для уплотнения бетона
- CZ Vibrační lišta do betonu
- HU Vibrációs betonlemez
- RO Rigla vibrantă electrică
- FR Règle vibrante à béton
- IT Staggia vibrante
- ES Regla vibrante para hormigón
- CN 电动振平尺



230V~50Hz 240 W 6000/10000 min⁻¹ 1m AI IPX4 FOLDABLE HANDLE SKŁADANY UCHWYT

$L_{pA} = 88,0 \pm 3,0$ dB; $L_{wA} = 96,0 \pm 3,0$ dB; $a_h = 4,3 \pm 1,5$ m/s²

YATO	[W]	Profile length / Długość profilu [m]	
YT-82611	240	1	1

- EN Vibrating screed replacement blade
- PL Profil wymienny do listwy wibracyjnej
- DE Ersatzprofil für Rüttelbohle
- RU Профиль для виброрейки
- CZ Výměnný profil pro vibrační lišty
- HU Tartalék lécc vibrációs betonlemezhez
- RO Bară de schimb pt. sață vibrantă
- FR Profilé de remplacement pour règle vibrante
- IT Profilo di ricambio per staggia vibrante
- ES Perfil de repuesto para regla vibrante
- CN 振平尺



AI

For YT-82611
 Dla YT-82611

YATO	L [m]	
YT-82612	2	1
YT-82613	3	1

- EN Poker shaft
- PL Waż do wibrowania betonu
- DE Rüttelflasche
- RU Вал пикий для вибратора бетона
- CZ Hadice k ponočnému vibrátoru
- HU Betonvibrátor tömlő
- RO Lance pt. vibrator beton
- FR Tuyau de vibration pour béton
- IT Testa per vibratore per calcestruzzo
- ES Cabezal de vibrador de hormigón
- CN 振动棒



35 mm 3 m For YT-82600 Dla YT-82600



35 mm 4 m For YT-82601 Dla YT-82601



25 mm 1.2 m For YT-82604 Dla YT-82604

YATO	L [m]	
YT-82595	3	1

YATO	L [m]	
YT-82596	4	1

YATO	L [m]	
YT-82597	1.2	4

EN Electric paddle mixer
PL Mieszarka do zapraw
DE Mörtelmischgerät
RU Строительный миксер
CZ Michadlo na maltu
HU Habarcskeverő
RO Malaxor pt. mortar
FR Mélangeur a mortier
IT Trapano miscelatore
ES Mezcladora de mortero
CN 手持式搅拌机

220-240V~50/60Hz **1600 W** 180-480_{rev}/300-750_{rev} 160 mm 140L M14



$L_{pa} = 87,0 \pm 3,0$ dB; $L_{wa} = 98,0 \pm 3,0$ dB; $a_n = 5,23 \pm 1,5$ m/s²

YATO	[W]	
YT-82607	1600	2

EN Plunge saw
PL Zagłębiarka
DE Tauchsäge
RU Погружная пила
CZ Ponorná pila
HU Merülőfűrész
RO Fierăstrău circular
FR Scie plongeante
IT Sega circolare a tuffo
ES Sierra de inmersión
CN 轨道锯



220-230V~50Hz **1300 W** 2000-5000 min⁻¹ 165x20 x2.4 mm 90°/55mm 45°/38mm CUTTING DEPTH: 450mm / 17.7" / 450mm / 17.7"

$L_{pa} = 89,0 \pm 3,0$ dB; $L_{wa} = 100,0 \pm 3,0$ dB; $a_n = 1,4 \pm 1,5$ m/s²

YATO	[W]	
YT-82168	1300	2

EN Guide rail for plunge saw
PL Prowadnica do zagłębiarki
DE Führungsschiene für Tauchsäge
RU Направляющая шина для погружной пилы
CZ Vodičí lišta pro ponornou pilu
HU Vezetősín merülőfűrészhez

RO Sina de ghidare pt. ferăstrău circular
FR Rail de guidage pour scie plongeante
IT Guida per seghe circolari
ES Carril de guía para sierra de incisión
CN 导轨

1.4 m

ALUMINUM HIGH QUALITY PROFILE, WYSOKI JAKOŚCI ALUMINIOWY PROFIL, WYSOKI JAKOŚCI

POSSIBILITY OF COMBINATION, MOŻLIWOŚĆ ŁĄCZENIA



For YT-82168
Dla YT-82168

YATO	L [mm]	
YT-82169	1400	5

EN Circular saw
PL Piłarka tarczowa
DE Handkreissäge
RU Циркулярная пила
CZ Okružní pila
HU Kézi körfűrész
RO Fierăstrău circular de mână
FR Scie circulaire
IT Sega circolare
ES Sierra circular
CN 电圆锯

220-240V~50Hz **1500 W** 4800 min⁻¹ 185x20 x2.8 mm 65 mm 90°-65 mm 45°-45 mm 3 m



Fitting blades: see chapter 10
Pasujące tarcze: patrz rozdział 10

$L_{pa} = 95,1 \pm 3,0$ dB; $L_{wa} = 106,1 \pm 3,0$ dB; $a_n = 2,86 \pm 1,5$ m/s²

YATO	[W]	
YT-82152	1500	2

EN Electric paddle mixer
PL Mieszarka do zapraw
DE Mörtelmischgerät
RU Строительный миксер
CZ Michadlo na maltu
HU Habarcskeverő
RO Malaxor pt. mortar
FR Mélangeur a mortier
IT Trapano miscelatore
ES Mezcladora de mortero
CN 低速钻

220-230V~50/60Hz **1200 W** 0-1000 min⁻¹ max 130 mm 3-16 mm 40 mm 16 mm 3 m



• Screwdriving: max T40 x 400 mm
• Wkręcanie: maks. T40 x 400 mm

$L_{pa} = 71,63 \pm 3,0$ dB; $L_{wa} = 82,63 \pm 3,0$ dB; $a_n = 3,148 \pm 1,5$ m/s²

YATO	[W]	
YT-82055	1200	4

EN Circular saw
PL Piłarka tarczowa
DE Handkreissäge
RU Циркулярная пила
CZ Okružní pila
HU Kézi körfűrész
RO Fierăstrău circular de mână
FR Scie circulaire
IT Sega circolare
ES Sierra circular
CN 电圆锯

220-240V~50Hz **1500 W** 5500 min⁻¹ 185x20 x2.8 mm 63 mm 90°-63 mm 45°-44 mm 3 m



Fitting blades: see chapter 10
Pasujące tarcze: patrz rozdział 10

$L_{pa} = 95,0 \pm 3,0$ dB; $L_{wa} = 106,0 \pm 3,0$ dB; $a_n = 3,526 \pm 1,5 / 2,905 \pm 1,5$ m/s²

YATO	[W]	
YT-82151	1500	2

EN Circular saw
PL Piłarka tarczowa
DE Handkreissäge
RU Циркулярная пила
CZ Okružní pila
HU Kézi körfűrész
RO Fierăstrău circular de mână
FR Scie circulaire
IT Sega circolare
ES Sierra circular
CN 电圆锯

220-240V~50Hz **2800 W** 4800 min⁻¹ 235x25.4 x3.0 mm 85 mm 90°-85 mm 45°-60 mm HIGH CUTTING RANGE, DUŻY ZAKRES CIĘCIA 3 m



Fitting blades: see chapter 10
Pasujące tarcze: patrz rozdział 10

$L_{pa} = 99,0 \pm 3,0$ dB; $L_{wa} = 110,0 \pm 3,0$ dB; $a_n = 1,847 \pm 1,5$ m/s²

YATO	[W]	
YT-82154	2800	2

EN Cordless miter saw
 PL Ukośnica akumulatorowa
 DE Akku-Paneelsäge
 RU Аккумуляторная торцовочная пила
 CZ Akumulátorová pokosová píla
 HU Akkus sines gérvágó
 RO Fierăstrău circular de banc cu acumulator
 FR Scie à onglet sans-fil
 IT Troncatrice a batteria
 ES Ingletadora telescópica a batería
 CN 充电式斜切锯

18 V Li-Ion	3600 min ⁻¹	185x30 x1.8 mm	40T
90°/51mm CUTTING DEPTH REBOROSIC CEECA	90°/203mm 45°/152mm CUTTING LENGTH REBOROSIC CEECA	II CLASS / KLASA	



18V
Li-Ion

Fitting blades: see chapter 10
 Pasujące tarcze: patrz rozdział 10

L_{pa} = 83,14 ± 3,0 dB; L_{wa} = 96,14 ± 3,0 dB

YATO [V d.c.]	Battery capacity / Pojemność akumulatora [mAh]	[h]	Battery quantity / Liczba akumulatorów w zestawie	
YT-82816	18	4000	2	1
YT-82817	18	-	-	brak

EN Miter saw
 PL Ukośnica
 DE Paneelsäge
 RU Панельная пила
 CZ Pokosová píla
 HU Sines gérvágó
 RO Fierăstrău circular staționar
 FR Scie à onglet
 IT Troncatrice
 ES Ingletadora telescópica
 CN 斜切锯

220-240V-50Hz	1800 W	255x25.4 x1.4 mm	36T
METAL	2500 min ⁻¹	90°/5mm 45°/3mm CUTTING DEPTH REBOROSIC CEECA	90°/305mm 45°/210mm CUTTING LENGTH REBOROSIC CEECA
WOOD CUTTING	3800 min ⁻¹	90°/70mm 45°/40mm CUTTING DEPTH REBOROSIC CEECA	90°/305mm 45°/210mm CUTTING LENGTH REBOROSIC CEECA
II CLASS / KLASA	3 m		



Fitting blades: see chapter 10
 Pasujące tarcze: patrz rozdział 10

L_{pa} = 93,0 ± 3,0 dB; L_{wa} = 105,0 ± 3,0 dB

YATO [W]	
YT-82174	1800

EN Miter saw
 PL Ukośnica
 DE Paneelsäge
 RU Панельная пила
 CZ Pokosová píla
 HU Sines gérvágó
 RO Fierăstrău circular staționar
 FR Scie à onglet
 IT Troncatrice
 ES Ingletadora telescópica
 CN 斜切锯

220-240V-50Hz	1500 W	4500 min ⁻¹	185x20 x2.8 mm
24T	90°/210mm 45°/145mm CUTTING DEPTH REBOROSIC CEECA	90°/60mm 45°/38mm CUTTING LENGTH REBOROSIC CEECA	II CLASS / KLASA
3 m			



Fitting blades: see chapter 10
 Pasujące tarcze: patrz rozdział 10

L_{pa} = 93,6 ± 3,0 dB; L_{wa} = 106,6 ± 3,0 dB

YATO [W]	
YT-82172	1500

EN Miter saw
 PL Ukośnica
 DE Paneelsäge
 RU Панельная пила
 CZ Pokosová píla
 HU Sines gérvágó

RO Fierăstrău circular staționar
 FR Scie à onglet
 IT Troncatrice
 ES Ingletadora telescópica
 CN 斜切锯

220-240V-50Hz	1800 W	5000 min ⁻¹	255x30 x2.8 mm
24T	90°/70mm 45°/35mm CUTTING DEPTH REBOROSIC CEECA	90°/305mm 45°/210mm CUTTING LENGTH REBOROSIC CEECA	II CLASS / KLASA
3 m			



Fitting blades: see chapter 10
 Pasujące tarcze: patrz rozdział 10

L_{pa} = 94,3 ± 3,0 dB; L_{wa} = 107,3 ± 3,0 dB

YATO [W]	
YT-82173	1800

EN Miter saw
PL Ukośnica
DE Paneelsäge
RU Панельная пила
CZ Pokosová pila
HU Sínes gérvágó

RO Fierăstrău circular staționar
FR Scie à onglet
IT Troncatrice
ES Ingletadora telescópica
CN 斜切锯

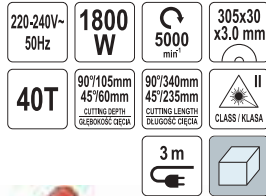

Fitting blades: see chapter 10
Pasujące tarcze: patrz rozdział 10

$L_{PA} = 90,7 \pm 3,0$ dB; $L_{WA} = 103,7 \pm 3,0$ dB

YATO	[W]	
YT-82175	1800	1

EN Electric table saw
PL Pilarka stolowa do drewna
DE Tischkreissäge für Holz
RU Настольной пила для древесины
CZ Stolní pilka do dřeva
HU Asztali körfűrész fához

RO Ferestrău circular pt. lemn
FR Scie sur table
IT Sega circolare da banco
ES Máquina cortadora para madera
CN 台锯



Fitting blades: see chapter 10
Pasujące tarcze: patrz rozdział 10

$L_{PA} = 91,0 \pm 3,0$ dB; $L_{WA} = 104,0 \pm 3,0$ dB

YATO	[W]	
YT-82165	1800	1

EN Thicknesser
PL Grubościówka
DE Dickenhobelmaschine
RU Рейсмусовый станок
CZ Tloušťkovací frézka
HU Vastagsági gyalugép
RO Mașină de degroșat
FR Raboteuse d'épaisseur
IT Piala a spessore
ES Regresadora
CN 刨削机



$L_{PA} = 86,5 \pm 3,0$ dB; $L_{WA} = 99,5 \pm 3,0$ dB

YATO	[W]	
YT-82148	1800	1

EN Jig saw
PL Wyrzynarka
DE Stichsäge
RU Электрический лобзик
CZ Přímočará pila
HU Szűrőfűrész
RO Fierăstrău pendular
FR Scie sauteuse
IT Seghetto alternativo
ES Sierra de calar
CN 曲线锯

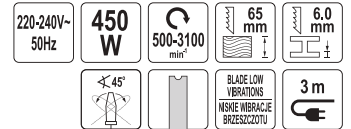

$L_{PA} = 86,0 \pm 3,0$ dB;
 $L_{WA} = 97,0 \pm 3,0$ dB;
 $a_w = 8,27 \pm 1,5 / 10,65 \pm 1,5$ m/s²

YATO	[W]	
YT-82274	450	8

EN Jig saw
PL Wyrzynarka
DE Stichsäge
RU Электрический лобзик
CZ Přímočará pila
HU Szűrőfűrész
RO Fierăstrău pendular
FR Scie sauteuse
IT Seghetto alternativo
ES Sierra de calar
CN 曲线锯



$L_{PA} = 89,0 \pm 3,0$ dB;
 $L_{WA} = 100,0 \pm 3,0$ dB;
 $a_w = 8,87 \pm 1,5 / 5,51 \pm 1,5$ m/s²

YATO	[W]	
YT-82267	750	5

EN Cordless planer
 PL Strug akumulatorowy
 DE Akku-Hobel
 RU Аккумуляторный рубанок
 CZ Akumulátorový hoblík
 HU Akkus gyalu
 RO Rindea fără acumulator
 FR Rabot sans-fil
 IT Piaella a batteria
 ES Garlopa a batería
 CN 锂电电刨

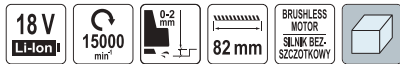

Battery not included
 Ohne Akku / Bez akumulatora
 Bez ămpăsurii / Bez aku
 Akkumulátor nélkül
 Fără baterie / Sans batterie
 Senza batteria / Sin bateria
 没有电池

18V
Li-Ion

$L_{pa} = 84,0 \pm 3,0$ dB; $L_{wa} = 95,0 \pm 3,0$ dB; $a_h = 5,22 \pm 1,5$ m/s²

YATO	[V d.c.]	
YT-82192	18	6

EN Electric planer
 PL Strug elektryczny
 DE Elektrohobel
 RU Электрорубанок
 CZ Elektrický hoblík
 HU Elektro

RO Rindea electrica
 FR Rabot
 IT Piaella elettrica
 ES Garlopa electrica
 CN 电刨



$L_{pa} = 84,0 \pm 3,0$ dB; $L_{wa} = 95,0 \pm 3,0$ dB; $a_h = 7,11 \pm 1,5$ m/s²

YATO	[W]	
YT-82141	1300	2

EN Router
 PL Frezarka górnoprzecionowa
 DE Oberfräse
 RU Фрезер вертикальный
 CZ Horní frézka
 HU Felsőmaró
 RO Freză electrică pt. lemn
 FR Défonceuse
 IT Fresatrice verticale
 ES Fresadora de superficie
 CN 电木铣

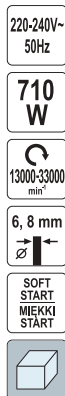

$L_{pa} = 92,0 \pm 3,0$ dB; $L_{wa} = 102,0 \pm 3,0$ dB; $a_h = 2,388 \pm 1,5$ m/s²

YATO	[W]	
YT-82390	710	4



EN Electric planer
 PL Strug elektryczny
 DE Elektrohobel
 RU Электрорубанок
 CZ Elektrický hoblík
 HU Elektromos gyalu

RO Rindea electrica
 FR Rabot électrique
 IT Piaella elettrica
 ES Garlopa electrica
 CN 电刨

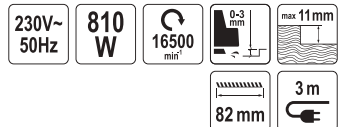

$L_{pa} = 87,0 \pm 3,0$ dB; $L_{wa} = 98,0 \pm 3,0$ dB; $a_h = 7,68 \pm 1,5$ m/s²

YATO	[W]	
YT-82141	810	6

EN Cordless router
 PL Akumulatorowa frezarka górnoprzecionowa
 DE Akku-Oberfräse
 RU Аккумуляторная фрезерная машина
 CZ Akumulátorová horní frézka
 HU Akkus felsőmaró
 RO Freză pt. lemn fără acumulator
 FR Défonceuse sans-fil
 IT Fresatrice verticale a batteria
 ES Fresadora de superficie a batería
 CN 电木铣

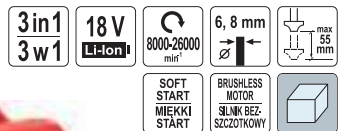

$L_{pa} = 78,0 \pm 3,0$ dB;
 $L_{wa} = 89,0 \pm 3,0$ dB;
 $a_h = 2,47 \pm 1,5$ m/s²

18V
Li-Ion

Battery not included
 Ohne Akku / Bez akumulatora
 Bez ămpăsurii / Bez aku
 Akkumulátor nélkül
 Fără baterie / Sans batterie
 Senza batteria / Sin bateria
 没有电池

- Planer
- Straight grinder
- Edge trimmer
- Frezarka
- Szlifierka prosta
- Frezarka krawędziowa

YATO	[V d.c.]	
YT-82194	18	6

EN Router
 PL Frezarka górnoprzecionowa
 DE Oberfräse
 RU Фрезер вертикальный
 CZ Horní frézka
 HU Felsőmaró

RO Freză electrică pt. lemn
 FR Défonceuse
 IT Fresatrice verticale
 ES Fresadora de superficie
 CN 电木铣

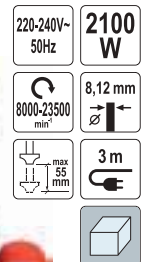

Fitting router bits: see chapter 10
 Pasujące frezy: patrz rozdział 10

$L_{pa} = 94,0 \pm 3,0$ dB; $L_{wa} = 105,0 \pm 3,0$ dB; $a_h = 3,41 \pm 1,5$ m/s²

YATO	[W]	
YT-82380	2100	2

EN Belt sander
PL Szlifierka taśmowa
DE Bandschleifer
RU Ленточная шлифмашина
CZ Pásová bruska
HU Szalagcsiszoló

RO Șlefuitor cu bandă
FR Ponceuse à bande
IT Levigatrice a nastro
ES Lijadora de banda
CN 砂带机

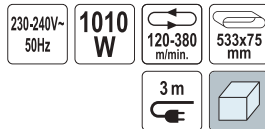

Fitting abrasive bands: see chapter 10
Pasujące pasy ściernie: patrz rozdział 10

$L_{pa} = 90,0 \pm 3,0$ dB; $L_{wa} = 101,0 \pm 3,0$ dB; $a_n = 5,1 \pm 1,5$ m/s²

YATO	[W]	
YT-82240	1010	4

EN Sabre saw
PL Pila szablasta
DE Säbelsäge
RU Сабельная пила
CZ Pila ocaska
HU Szablyafűrész

RO Fierăstrău sabie
FR Scie sabre
IT Sega a gattuccio
ES Sierra de sable
CN 往复锯

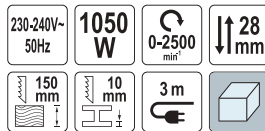

$L_{pa} = 92,2 \pm 3,0$ dB; $L_{wa} = 103,2 \pm 3,0$ dB; $a_n = 25,65 \pm 1,5$ m/s²

YATO	[W]	
YT-82281	1050	4

EN Orbital sander
PL Szlifierka mimośrodowa
DE Exzentrische Schleifmaschine
RU Экцентриковая шлифовальная машина
CZ Excentrická bruska
HU Excenter csiszoló
RO Șlefuitor orbital
FR Ponceuse orbitale
IT Smerigliatrice eccentrica
ES Pulidor excéntrico
CN 砂光机

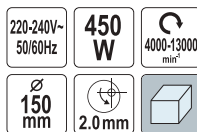

$L_{pa} = 82,0 \pm 3,0$ dB; $L_{wa} = 90,0 \pm 3,0$ dB; $a_n = 12,5 \pm 1,5$ m/s²

YATO	[W]	
YT-82207	450	6

EN Belt sander
PL Szlifierka taśmowa
DE Bandschleifer
RU Ленточная шлифмашина
CZ Pásová bruska
HU Szalagcsiszoló

RO Șlefuitor cu bandă
FR Ponceuse à bande
IT Levigatrice a nastro
ES Lijadora de banda
CN 砂带机



Fitting abrasive bands: see chapter 10
Pasujące pasy ściernie: patrz rozdział 10

$L_{pa} = 88 \pm 3$ dB; $L_{wa} = 99 \pm 3$ dB; $a_n = 6,47 \pm 1,5$ m/s²

YATO	[W]	
YT-82242	1200	2

EN Orbital sander
PL Szlifierka mimośrodowa
DE Exzentrische Schleifmaschine
RU Экцентриковая шлифовальная машина
CZ Excentrická bruska
HU Excenter csiszoló
RO Șlefuitor orbital
FR Ponceuse orbitale
IT Smerigliatrice eccentrica
ES Pulidor excéntrico
CN 砂光机



$L_{pa} = 80,0 \pm 3,0$ dB; $L_{wa} = 91,0 \pm 3,0$ dB; $a_n = 3,7 \pm 1,5$ m/s²

YATO	[W]	
YT-82206	350	6

EN Finishing sander
PL Szlifierka oscylacyjna
DE Schwingschleifer
RU Виброшлифмашина
CZ Oscilační bruska
HU Vibrációs csiszológép



$L_{pa} = 82,0 \pm 3,0$ dB; $L_{wa} = 93,0 \pm 3,0$ dB; $a_n = 5,4 \pm 1,5$ m/s²

YATO	[W]	
YT-82230	260	4

EN Burnishing machine
 PL Satyniarka
 DE Satiniermaschine
 RU Щеточная шлифмашина
 CZ Saténovací bruska
 HU Palástcsiszoló
 RO Mașină de șlefuit
 FR Ponceuse à tambour
 IT Satinatrice
 ES Satinadora
 CN 拉丝抛光机

1300 W	230V~50Hz	900-3700 min⁻¹	∅120/19 x100 mm
		3 m	



$L_{pa} = 88,0 \pm 3,0$ dB; $L_{wa} = 99,0 \pm 3,0$ dB; $a_h = 8,85 \pm 1,5$ m/s²



• Included wheel drums: nylon and steel wire
 • W zestawie szczotki: nylonowa i druciana

EN Wheel drum for burnishing machine
 PL Szczotka do satyniarki
 DE Rundbürste für Satiniermaschine
 RU Щетка для щеточной шлифмашины
 CZ Válec do saténovací brusky
 HU Palástcsiszoló kefe
 RO Rezervă pt. mașină de șlefuit
 FR Brosse pour ponceuse à tambour
 IT Spazzola per satinatrice
 ES Rodillo abrasivo para satinadora
 CN 拉丝轮

	∅120/19 x100 mm	PVC



For YT-81953
 Dla YT-81953

• For removing paint coatings from wooden surfaces, e.g. creased patio boards
 • Do usuwania powłok malarskich z powierzchni drewnianych, np. desek tarasowych ryflowanych

YATO	[W]	
YT-81954	20	2

EN Wheel drum for burnishing machine
 PL Szczotka do satyniarki
 DE Rundbürste für Satiniermaschine
 RU Щетка для щеточной шлифмашины
 CZ Válec do saténovací brusky
 HU Palástcsiszoló kefe
 RO Rezervă pt. mașină de șlefuit
 FR Brosse pour ponceuse à tambour
 IT Spazzola per satinatrice
 ES Rodillo abrasivo para satinadora
 CN 拉丝轮

	∅120/19 x100 mm	STEEL WIRE DRUT STALOWY



For YT-81953
 Dla YT-81953

• For removing rust and paint
 • Do usuwania rdzy i powłok malarskich

YATO	[W]	
YT-81955	20	2

EN Wheel drum for burnishing machine
 PL Szczotka do satyniarki
 DE Rundbürste für Satiniermaschine
 RU Щетка для щеточной шлифмашины
 CZ Válec do saténovací brusky
 HU Palástcsiszoló kefe
 RO Rezervă pt. mașină de șlefuit
 FR Brosse pour ponceuse à tambour
 IT Spazzola per satinatrice
 ES Rodillo abrasivo para satinadora
 CN 拉丝轮

		∅120/19 x100 mm



For YT-81953, YT-81956
 Dla YT-81953, YT-81956

YATO	[W]	
YT-81957	20	2

EN Wheel drum for burnishing machine
 PL Szczotka do satyniarki
 DE Rundbürste für Satiniermaschine
 RU Щетка для щеточной шлифмашины
 CZ Válec do saténovací brusky
 HU Palástcsiszoló kefe
 RO Rezervă pt. mașină de șlefuit
 FR Brosse pour ponceuse à tambour
 IT Spazzola per satinatrice
 ES Rodillo abrasivo para satinadora
 CN 拉丝轮

		∅120/19 x100 mm



For YT-81953, YT-81956
 Dla YT-81953, YT-81956

YATO	[W]	
YT-81958	20	2

EN Drywall sander
 PL Szlifierka do tynków
 DE Wandschleifer
 RU Шлифмашина
 CZ Brúška muriva
 HU Kézi csiszoló fal

RO Mașină de șlefuit
 FR Ponceuse à platre filaire
 IT Levigatrice per intonaco
 ES Lijadora pared manual
 CN 干墙打磨机

230V~50Hz	1220 W	1500-2300 min⁻¹	∅225 mm
∅210 215 225 mm	x6 P60-P240	P60 P80 P100 P120 P180 P240	



• Vacuum self suction system integrated
 • Wbudowany system odsysania pyłu

Fitting sand papers: see chapter 10
 Pasujące papiery ściernie: patrz rozdział 10

$L_{pa} = 85,0 \pm 3,0$ dB; $L_{wa} = 96,0 \pm 3,0$ dB; $a_h = 4,83 \pm 1,5$ m/s²

YATO	[W]	
YT-82340	1220	2

EN Plaster smoothing and rendering machine
 PL Zacieraczka do tynków gipsowych i cementowych
 DE Putzglättmaschine für Gips- und Zementputz
 RU Машина для затирки штукатурки
 CZ Hladíčka na sádrové a cementové omítky
 HU Vakolat simító gép
 RO Masina de netezire tencuieli
 FR Truelle électrique pour enduit de plâtre et de ciment
 IT Frattazzatrice per intonaci a base di gesso e intonaci cementizi
 ES Lijadora de yeso y hormigón
 CN 旋转电动抹子

220-240V~50Hz	750 W	110 min⁻¹	∅375 mm
WET WORK PRACA NA MOKRO			



$L_{pa} = 88,6 \pm 3,0$ dB; $L_{wa} = 99,6 \pm 3,0$ dB; $a_h = 1,528 \pm 1,5$ m/s²

YATO	[W]	
YT-82330	750	2

EN Drywall sander
PL Szlifierka na wysięgniku do ścian
DE Wandschleifmaschine mit Ausleger
RU Шлифовальная машина для стен
CZ Bruska na stěny s ramenem
HU Hosszúszerű falcsiszoló
RO Șlefuitor cu braț pt. pereți
FR Ponceuse pour cloison sèche
IT Levigatrice telescopica per muri
ES Pulidor para paredes en un brazo
CN 干墙打磨机



- Vacuum self suction system integrated
- Wbudowany system odsysania pyłu



Fitting sand papers: see chapter 10
Pasujące papiery ściernie: patrz rozdział 10

$L_{pa} = 88,0 \pm 3,0$ dB; $L_{wa} = 99,0 \pm 3,0$ dB; $a_n = 3,48 \pm 1,5 / 3,51 \pm 1,5$ m/s²

YATO	[W]	2
YT-82350	710	

EN Drywall sander
PL Szlifierka na wysięgniku do ścian
DE Wandschleifmaschine mit Ausleger
RU Шлифовальная машина для стен
CZ Bruska na stěny s ramenem
HU Hosszúszerű falcsiszoló
RO Șlefuitor cu braț pt. pereți
FR Ponceuse pour cloison sèche
IT Levigatrice telescopica per muri
ES Pulidor para paredes en un brazo
CN 干墙打磨机



- Vacuum self suction system integrated
- Wbudowany system odsysania pyłu



Fitting abrasive discs: see chapter 10
Pasujące krążki ściernie: patrz rozdział 10

$L_{pa} = 86,0 \pm 3,0$ dB; $L_{wa} = 97,0 \pm 3,0$ dB; $a_n = 7,91 \pm 1,5$ m/s²

YATO	[W]	2
YT-82355	820	

EN Extension pole for plaster smoothing machine
PL Przedłużka do zacieraczki
DE Teleskopstange für Putzglättmaschine
RU Телескопический удлинитель для затирочной машины
CZ Tyč prodlužovací pro hladičku na omítky
HU Vakolatásimító hosszabbító
RO Prelungitor pt. mașina de netezit tencuieli
FR Extension pour truelle électrique
IT Prolunga per frattazzatrice
ES Extensión para lijadora
CN 延长杆



For YT-82330
Dla YT-82330

YATO	L [mm]	10
YT-82332	800-1500	

EN Disc for smoothing render and cement floors
PL Dysk do zacierania tynków cementowych i posadzek
DE Kellenscheibe für Zementputz und Fußbodenkellen
RU Диск для затирочной машины
CZ Kotouč pro stěrkování cementových omítek a podlah
HU Cementvakolat és aljzatsimító tárcsa
RO Disc pt. netezirea tencuielilor și a pardoselilor de ciment
FR Plaque de truelle rotative pour enduits de ciment et sols
IT Disco frattazzatrice per intonaci cementizi e pavimentazioni
ES Disco de lija para cemento y suelos
CN 铁盘



For YT-82330
Dla YT-82330

YATO	Ø [mm]	8
YT-82333	375	

EN Sand paper for plaster smoothing machine
PL Papier ścierny do zacieraczki
DE Schleifpapier für Putzglättmaschine
RU Наждачная бумага для затирочной машины
CZ Brusný papír pro hladičku na omítky
HU Csiszolópapír vakolatásimítóhoz
RO Disc abraziv pt. mașina de netezire a tencuielii
FR Papier abrasif pour truelle électrique
IT Carta vetrata per frattazzatrice
ES Papel abrasivo para lijadora
CN 砂纸



For YT-82330
Dla YT-82330

YATO	Grit / Ziarnistość	Ø [mm]	20
YT-82334	P24	400	

EN Disc for smoothing sand and cement render
PL Dysk do zacierania tynków cementowo-wapiennych
DE Kelle zum Glätten von Zement-Kalk-Putz
RU Диск для затирочной машины
CZ Kotouč pro stěrkování cemento-vápnenných omítek
HU Mész-cement vakolatásimító tárcsa
RO Disc pt. netezirea tencuielilor și a pardoselilor de ciment
FR Plaque de truelle rotative pour enduit chaux-ciment
IT Disco frattazzatrice per intonaci calce-cemento
ES Disco de lija para cemento y cal
CN 塑料盘



For YT-82330
Dla YT-82330

YATO	Ø [mm]	20
YT-82335	375	

EN Hook and loop fastener disc for sponge and sand paper
PL Dysk z rzepem do gąbki i papieru ściernego
DE Klettscheibe für Schwamm und Schleifpapier
RU Диск на липучке для губки и наждачной бумаги
CZ Kotouč se suchým zipem pro houby a brusný papír
HU Tépőzáras rögzítőtárcsa szivacsos és csiszolópapírhoz
RO Disc de fixare pt. burete și șmirghel
FR Disque velcro pour éponge et papier de verre
IT Disco con velcro per spugna e carta vetrata
ES Disco con velcro para esponja i papel abrasivo
CN 底盘



For YT-82330
Dla YT-82330

YATO	Ø [mm]	15
YT-82336	375	

EN Sponge disc for rendering gypsum walls
PL Dysk gąbkowy do zacierania tynków gipsowych
DE Schwammsscheibe zum Glätten von Gipsputz
RU Диск губчатый для затирочной машины
CZ Hubkový kotouč pro stěrkování sádrových omítek
HU Szivacos tárcsa gipsvakolat simításhoz
RO Disc burete pt. finisarea pereților din gips
FR Disque éponge pour enduits de gypse
IT Disco spugna frattazzatrice per intonaci a base di gesso
ES Disco de esponja para yeso
CN 清洁海绵盘



For YT-82330
Dla YT-82330

YATO	Ø [mm]	56
YT-82337	390	

EN Electric spray gun
 PL Elektryczny pistolet malarski
 DE Elektro Farbspritzpistole
 RU Электрический пульверизатор
 CZ Elektrická pistole malířská
 HU Elektromos festékszóró pisztolyé
 RO Pistol electric de vopsit
 FR Pistolet à peinture électrique
 IT Pistola elettrica per verniciare
 ES Pistola de pintar electric
 CN 电动喷枪



230V~50Hz **500 W**
 1.8 mm **0.4 l/min**
 1000 ml

$L_{pa} = 102,0 \pm 3,0$ dB; $L_{wa} = 113,0 \pm 3,0$ dB; $a_n = 2,12 \pm 1,5$ m/s²

YATO	[W]	
YT-82550	500	4

EN Electric spray gun
 PL Elektryczny pistolet malarski
 DE Elektro Farbspritzpistole
 RU Электрический пульверизатор
 CZ Elektrická pistole malířská
 HU Elektromos festékszóró pisztolyé
 RO Pistol electric de vopsit
 FR Pistolet à peinture électrique
 IT Pistola elettrica per verniciare
 ES Pistola de pintar electric
 CN 电动喷枪



220-240V~50Hz **600 W**
 2.6 mm **1.0 l/min**
 1000 ml

$L_{pa} = 80,4 \pm 3,0$ dB; $L_{wa} = 91,4 \pm 3,0$ dB; $a_n = 0,67 \pm 1,5$ m/s²

YATO	[W]	
YT-82553	600	6

EN Airless paint sprayer
 PL Agregat malarski
 DE Farbsprüngerät
 RU Краскопульты
 CZ Stříkací zařízení
 HU Festékszóró rendszer
 RO Pompa vopsit airless
 FR Pistolet à peinture
 IT Unità di verniciatura
 ES Bomba de piston para spray de pintura airless
 CN 高压无气喷涂机



230V~50Hz **480 W**
 22.7 MPa **AIRLESS BEZ-POWETRZYNY**
 15 m

- For wall paints
- Do farb ściennych

$L_{pa} = 73,9 \pm 3,0$ dB; $L_{wa} = 81,0 \pm 3,0$ dB; $a_n = \leq 2,5$ m/s²

YATO	[W]	
YT-82562	480	1

EN Airless paint sprayer
 PL Agregat malarski
 DE Farbsprüngerät
 RU Краскопульты
 CZ Stříkací zařízení
 HU Festékszóró rendszer

RO Pompa vopsit airless
 FR Pistolet à peinture
 IT Unità di verniciatura
 ES Bomba de piston para spray de pintura airless
 CN 高压无气喷涂机



220-240V~50Hz **650 W**
 1.1 l/min **20.7 MPa**
 310 mm **AIRLESS BEZ-POWETRZYNY**
 7.5 m

- For wall paints
- Do farb ściennych

$L_{pa} = 93,3 \pm 3,0$ dB; $L_{wa} = 104,3 \pm 3,0$ dB; $a_n = \leq 2,5$ m/s²

YATO	[W]	
YT-82560	650	1

EN HVLP paint sprayer
 PL Agregat malarski HVLP
 DE HVLP-Aggregat für Farbspritzen
 RU Краскопульт HVLP для распыления краски
 CZ Malířský postřikovač HVLP
 HU Festékszóró rendszer HVLP
 RO Pompa vopsit HVLP
 FR Agrégat de peinture par pulvérisation HVLP
 IT Unità di verniciatura HVLP
 ES Bomba de piston para spray de pintura HVLP
 CN 拉杆式喷枪



220-230V~50/60Hz **1380 W**
 800 ml **HVLP**
 5 m **TELESCOPIC HANDLE UCHWYT TELESKOPOWY**
 EASY CLEAN ŁATWIE CZYSZCZENIE **3 m**

- For wall paints
- Do farb ściennych

$L_{pa} = 85,2 \pm 3,0$ dB; $L_{wa} = 96,2 \pm 3,0$ dB; $a_n = < 1,5$ m/s²

YATO	[W]	
YT-82555	1380	2

EN Nozzle
 PL Dysza
 DE Duese
 RU Корно
 CZ Tryska
 HU Szórófej
 RO Duză
 FR Buse pour pistolet à peinture
 IT Ugello regolabile per verniciatura
 ES Boquilla
 CN 喷嘴柱

5 PCS **513** **515** **517** **519** **521**



For YT-82560, YT-82562
 Dla YT-82560, YT-82562

YATO	
YT-82563	20

EN Nozzle
 PL Dysza
 DE Duese
 RU Корно
 CZ Tryska
 HU Szórófej
 RO Duză
 FR Buse pour pistolet à peinture
 IT Ugello regolabile per verniciatura
 ES Boquilla
 CN 喷嘴柱

3 PCS **517**



For YT-82560, YT-82562
 Dla YT-82560, YT-82562

YATO	
YT-82564	20

EN Pressure hose for paint
PL Wąż ciśnieniowy do farby
DE Schlauch für Farbe
RU Шланг высокого давления
CZ Střikací hadice
HU Permetező tömlő
RO Furtun pt. pompă de vopsit
FR Tuyau de pulvérisation
IT Tubo flessibile di pressione per verniciatura
ES Manguera de rociado
CN 高压输漆管



83 MPa
max °C 65
15 m

For YT-82562
Dla YT-82562

YATO	
YT-82565	5

EN Airless spray gun extension
PL Przedłużka do pistoletu natryskowego
DE Sprühpistole Erweiterung
RU Удлинитель для пистолета-распылителя
CZ Prodlužovák pro postřikovací pistoli
HU Toldósár szórópisztolyhoz
RO Prelungitor pistol airless
FR Extension de pistolet de pulvérisation de peinture
IT Prolunga per pistola a spruzzo
ES Extensión de pistola pulverizadora de pintura
CN 延长杆



3 PCS
300 mm
450 mm
600 mm
AI

YATO	L [mm]	
YT-82567	300, 450, 600	10

EN Spray gun
PL Pistolet malarski
DE Sprühpistole
RU Пистолет-распылитель
CZ Střikací pistole
HU Szórópisztoly
RO Pistol pt. pompă de vopsit
FR Pistolet à peinture
IT Pistola per verniciare
ES Pistola rociadora
CN 无气喷枪+过滤网



22.7 MPa
3 FILTERS FILTER

For YT-82560, YT-82562
Dla YT-82560, YT-82562

YATO	
YT-82566	20

EN Airless spray gun extension
PL Przedłużka do pistoletu natryskowego
DE Sprühpistole Erweiterung
RU Удлинитель для пистолета-распылителя
CZ Prodlužovák pro postřikovací pistoli
HU Toldósár szórópisztolyhoz
RO Prelungitor pistol airless
FR Extension de pistolet de pulvérisation de peinture
IT Prolunga per pistola a spruzzo
ES Extensión de pistola pulverizadora de pintura
CN 延长杆



2 PCS
1000 mm
1800 mm
AI

YATO	L [mm]	
YT-82568	1000, 1800	25

EN Multi-purpose oscillating tool
PL Wielofunkcyjne narzędzie oscylacyjne
DE Multifunktionales Oszillationswerkzeug
RU Многофункциональный инструмент
CZ Multifunkční oscilační nářadí
HU Multifunkciós rezgő szerszám

RO Unealtă multifuncțională oscilantă
FR Outil multifonctions oscillant
IT Oscillante strumento multifunzione
ES Herramienta oscilatoria multiusos
CN 多功能锯

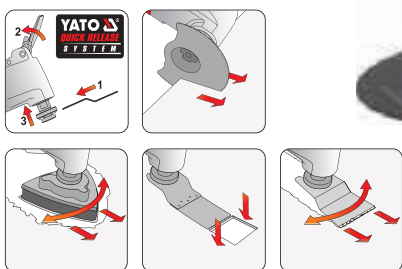

230-240V~50Hz
300 W
15000-22000 mm²
2 m

$L_{pA} = 89,2 \pm 3,0$ dB; $L_{wA} = 100,2 \pm 3,0$ dB; $a_p = 4,464 \pm 1,5$ m/s²

YATO	[W]	
YT-82220	300	4

EN Multi-purpose oscillating tool
PL Wielofunkcyjne narzędzie oscylacyjne
DE Multifunktionales Oszillationswerkzeug
RU Многофункциональный инструмент
CZ Multifunkční oscilační nářadí
HU Multifunkciós rezgő szerszám

RO Unealtă multifuncțională oscilantă
FR Outil multifonctions oscillant
IT Oscillante strumento multifunzione
ES Herramienta oscilatoria multiusos
CN 多功能锯

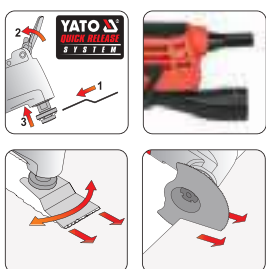

230-240V~50Hz
500 W
8000-16000 mm²

• Additional vacuum system
• Opcjonalny system odsysania



$L_{pA} = 106,4 \pm 3,0$ dB; $L_{wA} = 117,4 \pm 3,0$ dB; $a_p = 12,71 \pm 1,5$ m/s²

YATO	[W]	
YT-82223	500	5

EN Industrial vacuum cleaner
 PL Odkurzacz przemysłowy
 DE Industriesauger
 RU Пылосос промышленный
 CZ Průmyslový vysavač
 HU Ipari porszívó
 RO Aspirator industrial
 FR Aspirateur eau et poussières
 IT Aspirapolvere industriale
 ES Aspirador industrial
 CN 吸尘器

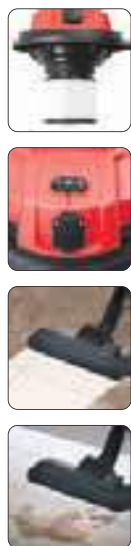
220-240V-50/60Hz
1400 W
 18 kPa
20 L
 WET AND DRY SUCHO I MOKRO
 max 2000 W
IPX4
 4.5 m



YATO  [W] 
 YT-85700 1400 1

EN Industrial vacuum cleaner
 PL Odkurzacz przemysłowy
 DE Industriesauger
 RU Пылосос промышленный
 CZ Průmyslový vysavač
 HU Ipari porszívó
 RO Aspirator industrial
 FR Aspirateur eau et poussières
 IT Aspirapolvere industriale
 ES Aspirador industrial
 CN 吸尘器

220-240V-50/60Hz
1400 W
 18 kPa
30 L
 WET AND DRY SUCHO I MOKRO
 max 2000 W
IPX4
 4.5 m

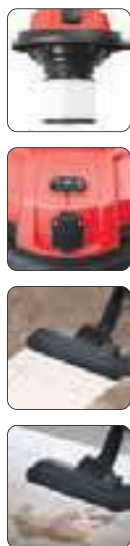



YATO  [W] 
 YT-85701 1400 1

EN Industrial vacuum cleaner
 PL Odkurzacz przemysłowy
 DE Industriesauger
 RU Пылосос промышленный
 CZ Průmyslový vysavač
 HU Ipari porszívó
 RO Aspirator industrial
 FR Aspirateur eau et poussières
 IT Aspirapolvere industriale
 ES Aspirador industrial
 CN 吸尘器

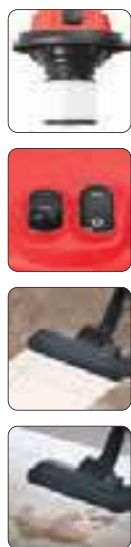
220-240V-50/60Hz
2400 W
 18 kPa
70 L
 WET AND DRY SUCHO I MOKRO
 ADJUSTABLE POWER REGULACJA MOCY
IPX4
 6 m



YATO  [W] 
 YT-85710 2400 1

EN Industrial vacuum cleaner
 PL Odkurzacz przemysłowy
 DE Industriesauger
 RU Пылосос промышленный
 CZ Průmyslový vysavač
 HU Ipari porszívó
 RO Aspirator industrial
 FR Aspirateur eau et poussières
 IT Aspirapolvere industriale
 ES Aspirador industrial
 CN 多功能吸尘器

220-240V-50/60Hz
1600 W
 18 kPa
30 L
 WET AND DRY SUCHO I MOKRO
 BLOW FUNCTION FUNKCJA Dmuchawy
 max 2000 W
IPX4
 5 m

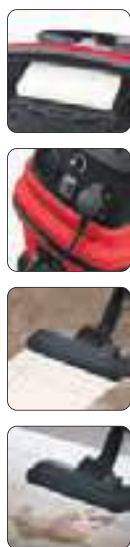

YATO  [W] 
 YT-85715 1600 1

EN Industrial vacuum cleaner
PL Odkurzacz przemysłowy
DE Industriesauger
RU Пылесос промышленный
CZ Průmyslový vysavač
HU Ipari porszívó
RO Aspirator industrial
FR Aspirateur eau et poussières
IT Aspirapolvere industriale
ES Aspirador industrial
CN 吸尘器

220-240V~
50-60Hz
1600
W
30 L
HEPA
2000 W
IPX4
7.5 m

- Self cleaning filter
- HEPA filter
- Automatyyczny otrząsacz filtra
- Filtr HEPA



YATO	[W]	
YT-85716	1600 / 3600	1

EN Synthetic vacuum bags
PL Worki do odkurzacza syntetyczne
DE Staubsaugbeutel, synthetisch
RU Синтетический пылесборник
CZ Sáčky do vysavačů syntetické
HU Szentetikus porzsák
RO Sac sintetic pt. aspirator
FR Sac synthétique pour aspirateur
IT Sacchetti sintetici per aspirapolvere
ES Bolsas sintéticas para aspiradoras
CN 合成吸尘器袋

3
PCS



YATO	For / Dla	
YT-85730	YT-85710	20
YT-85731	YT-85701	20
YT-85733	78874	20
YT-85735	YT-85700, 78872	24

EN Synthetic vacuum bag
PL Worek do odkurzacza syntetyczny
DE Staubsaugbeutel, synthetisch
RU Синтетический мешок для пылесоса
CZ Syntetický sáček do vysavače
HU Szentetikus porzsák
RO Sac sintetic pt. aspirator
FR Sac synthétique pour aspirateur
IT Sacchetto per aspirapolvere sintetico
ES Bolsa sintética para aspiradora
CN 合成吸尘器袋

1
PCS



For YT-85715
Dla YT-85715

YATO		
YT-85741		100

EN Multifunctional vacuum cleaner for pond
PL Odkurzacz wielofunkcyjny do oczka wodnego
DE Multifunktions-Teichsauger
RU Водный пылесос для пруда
CZ Multifunkční vysavač do vodního očka
HU Többfunkciós vízszívó porszívó
RO Aspirator multifunctional pt. iazuri
FR Aspirateur multifonction pour étangs
IT Aspirapolvere multifunzione per laghetti artificiali
ES Aspiradora multiuso para estanques
CN 水池吸尘器

220-240V~
50/60Hz
1400
W
18
kPa
30 L
WET
AND DRY
SUCHO
I MOKRO
BLOW
FUNCTION
FUNKCIA
DMUCHAWY
IPX4
4.5 m

- Wet and dry floor nozzle (width: 30 cm)
- Round brush (rotating head)
- Crevice nozzle
- Nozzle for cleaning pond
- Long hose (430 cm)
- Drainage hose (200 cm)
- Plastic tubes (4 PCS)
- Pond debris bag
- Cloth filter
- Sponge filter

- Dysza podłogowa do odkurzania na sucho i mokro (szerokość: 30 cm)
- Szczotka okrągła (obracana głowica)
- Dysza szczelinowa
- Dysza do czyszczenia oczka wodnego
- Długi wąż (430 cm)
- Wąż drenazowy (200 cm)
- Rury z tworzywa sztucznego (4 szt.)
- Torba na zanieczyszczenia
- Filtr materiałowy
- Filtr piankowy



YATO	[W]	
YT-85720	1400	1

EN Synthetic vacuum bag
PL Worek do odkurzacza syntetyczny
DE Staubsaugbeutel, synthetisch
RU Синтетический мешок для пылесоса
CZ Syntetický sáček do vysavače
HU Szentetikus porzsák
RO Sac sintetic pt. aspirator
FR Sac synthétique pour aspirateur
IT Sacchetto per aspirapolvere sintetico
ES Bolsa sintética para aspiradora
CN 合成吸尘器袋

1
PCS



For YT-85715
Dla YT-85715

YATO		
YT-85740		100

EN Synthetic vacuum bag
PL Worek do odkurzacza syntetyczny
DE Staubsaugbeutel, synthetisch
RU Синтетический мешок для пылесоса
CZ Syntetický sáček do vysavače
HU Szentetikus porzsák
RO Sac sintetic pt. aspirator
FR Sac synthétique pour aspirateur
IT Sacchetto per aspirapolvere sintetico
ES Bolsa sintética para aspiradora
CN 合成吸尘器袋

1
PCS



For YT-85716
Dla YT-85716

YATO		
YT-85744		100

EN Paper vacuum bags
 PL Worki do odkurzacza papierowe
 DE Staubsaugerbeutel, papier
 RU Бумажные пылесборники
 CZ Sáčky do vysavačů papírové
 HU Papír porzsák
 RO Sac hartie pt aspirator
 FR Sacs en papier pour aspirateur
 IT Sacchetti di carta per aspirapolvere
 ES Bolsas de papel para aspiradoras
 CN 纸质吸尘器袋



4
PCS

EN Vacuum filter
 PL Filtr do odkurzacza
 DE Staubsaugerfilter
 RU Фильтр для пылесоса
 CZ Filtr do vysavače
 HU Porszívó szűrő
 RO Filtru aspirator
 FR Filtre pour aspirateur
 IT Filtro per aspirapolvere
 ES Filtro para aspiradoras
 CN 吸尘器过滤器



1
PCS

YATO	For / Dla	
YT-85732	YT-85701, 78874	24
YT-85736	YT-85700, 78872	24

YATO	For / Dla	
YT-85738	YT-85700, YT-85701	1
YT-85739	YT-85710	1

EN Sponge filter and cloth filter
 PL Filtr piankowy i filtr materiałowy
 DE Schaumstoff- und Gewebefilter
 RU Тканевый фильтр
 CZ Pěnový filtr a látkový filtr
 HU Habszivő és szövet szűrő
 RO Filtru de burete și filtru de pânză
 FR Filtre en mousse et en tissu
 IT Filtro in schiuma e filtro in tessuto
 ES Filtro de espuma y filtro de tela
 CN 尘袋&过滤海绵套装



For YT-85720
 Dla YT-85720

EN Vacuum filter
 PL Filtr do odkurzacza
 DE Staubsaugerfilter
 RU Фильтр для пылесоса
 CZ Filtr do vysavače
 HU Porszívó szűrő
 RO Filtru aspirator
 FR Filtre pour aspirateur
 IT Filtro per aspirapolvere
 ES Filtro para aspiradoras
 CN 吸尘器过滤器



1
PCS
HEPA

For YT-85715
 Dla YT-85715

YATO		
YT-85750		20

YATO		
YT-85742		100

EN Vacuum filter
 PL Filtr do odkurzacza
 DE Staubsaugerfilter
 RU Фильтр для пылесоса
 CZ Filtr do vysavače
 HU Porszívó szűrő
 RO Filtru aspirator
 FR Filtre pour aspirateur
 IT Filtro per aspirapolvere
 ES Filtro para aspiradoras
 CN 吸尘器过滤器



For YT-85715
 Dla YT-85715

EN Vacuum filter
 PL Filtr do odkurzacza
 DE Staubsaugerfilter
 RU Фильтр для пылесоса
 CZ Filtr do vysavače
 HU Porszívó szűrő
 RO Filtru aspirator
 FR Filtre pour aspirateur
 IT Filtro per aspirapolvere
 ES Filtro para aspiradoras
 CN 吸尘器过滤器



1
PCS
HEPA

For YT-85716
 Dla YT-85716

YATO		
YT-85743		100

YATO		
YT-85745		22

EN Wall paper stripper
 PL Parownica do usuwania tapet
 DE Dampftapetenablöser
 RU Паровой аппарат для снятия обоев
 CZ Parní odstraňovač tapet
 HU Tapétaeltávolító
 RO Aparat de dezlipit tapet
 FR Décolleuse à papiers peints
 IT Vaporizzatore per la rimozione di carta da parati
 ES Separador de fondos de pantalla
 CN 剥墙纸机



230-240V-50Hz
2000
W
 100°C
4.5L
 IPX4
 3m

EN Hot knife for polystyrene foam
 PL Nóż termiczny do styropianu
 DE Thermomesser für Styropor
 RU Термонож для пенопласта
 CZ Termický nůž na polystyrén
 HU Polisztirolvágó hőkés

RO Cuțit termic pt. polistiren
 FR Couteau thermique pour polystyrène
 IT Coltello a caldo per taglio polistirolo
 ES Cuchillo térmico para poliestireno
 CN 热切割刀

230V~50Hz
150
W
 max °C
550
 max
200
mm
x2
BLADES
OSTRZA
LED
LIGHT
DIOIDA

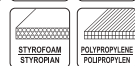

• Included blades: 150, 200 mm
 • W zestawie ostrza: 150, 200 mm

YATO	[W]	Max. cutting length / Maks. długość cięcia [mm]	
YT-82191	150	150, 200	10

EN Hot knife for polystyrene foam
 PL Nóż termiczny do styropianu
 DE Thermomesser für Styropor
 RU Термонож для пенопласта
 CZ Termický nůž na polystyrén
 HU Polisztirolvágó hőkés

RO Cuțit termic pt. polistiren
 FR Couteau thermique pour polystyrène
 IT Coltello a caldo per taglio polistirolo
 ES Cuchillo térmico para poliestireno
 CN 热切割刀

230V~50Hz
220
W
 70-450
°C
LED
LIGHT
DIOIDA
 STYROFOAM
STYROPIAN
 POLYPROPYLENE
POLIPROPILEN

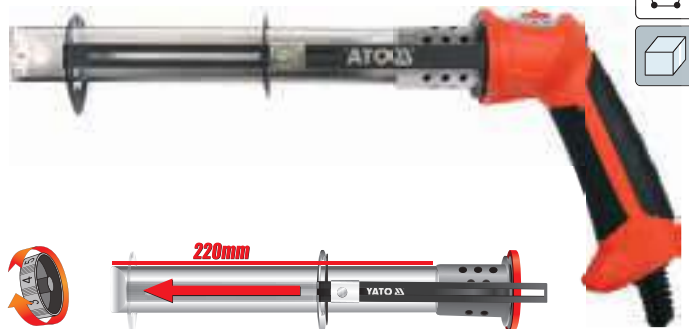

YATO	[W]	Max. cutting length / Maks. długość cięcia [mm]	
YT-82190	220	220	10



EN Cordless heat gun
PL Opalarka akumulatorowa
DE Akku-Heissluftgebläse
RU Фен технический аккумуляторный
CZ Akumulátorová opalovací pistole
HU Akkus hőlégfúvó
RO Pistol aer cald fără acumulator
FR Décapeur thermique sans-fil
IT Pistola termica a batteria
ES Pistola de calor a batería
CN 热风枪



18 V
Li-Ion
550 °C
100 l/min

18V
Li-Ion

Battery not included
Ohne Akku / Bez akumulatora
Bez baterie / Bez aku
Akumulátor nélkül
Fără baterie / Sans batterie
Senza batteria / Sin batería
没有电池

YATO 	[V d.c.]	
YT-82285	18	10

EN Hot air gun with accessories
PL Opalarka z akcesoriami
DE Heissluftpistole
RU Строительный фен в наборе
CZ Opalovací stroj s příslušenstvím
HU Hőlégfúvó tartozékokkal

RO Pistol cu aer cald cu accesorii
FR Décapeur thermique avec accessoires
IT Pistola termica con accessori
ES Secadora con accesorios
CN 热风枪

230-240V~50Hz
2000 W
550 °C
500 l/min



YATO 	[W]	
YT-82291	2000	5

EN Hot air gun with accessories
PL Opalarka z akcesoriami
DE Heissluftpistole
RU Строительный фен в наборе
CZ Opalovací stroj s příslušenstvím
HU Hőlégfúvó tartozékokkal

RO Pistol cu aer cald cu accesorii
FR Décapeur thermique avec accessoires
IT Pistola termica con accessori
ES Secadora con accesorios
CN 热风枪

230-240V~50Hz
2000 W
600 °C
500 l/min



YATO 	[W]	
YT-82293	2000	5

EN Hot air gun
PL Opalarka
DE Heissluftpistole
RU Строительный фен
CZ Opalovací stroj
HU Hőlégfúvó

RO Pistol cu aer cald
FR Décapeur thermique
IT Pistola termica
ES Secadora
CN 热风枪

230-240V~50Hz
2000 W
550 °C
500 l/min



YATO 	[W]	
YT-82288	2000	10

EN Hot air gun with accessories
PL Opalarka z akcesoriami
DE Heissluftpistole
RU Строительный фен в наборе
CZ Opalovací stroj s příslušenstvím
HU Hőlégfúvó tartozékokkal

RO Pistol cu aer cald cu accesorii
FR Décapeur thermique avec accessoires
IT Pistola termica con accessori
ES Secadora con accesorios
CN 热风枪

230-240V~50Hz
2000 W
550 °C
500 l/min
LED



YATO 	[W]	
YT-82292	2000	5

EN Hot air gun with accessories
PL Opalarka z akcesoriami
DE Heissluftpistole
RU Строительный фен в наборе
CZ Opalovací stroj s příslušenstvím
HU Hőlégfúvó tartozékokkal

RO Pistol cu aer cald cu accesorii
FR Décapeur thermique avec accessoires
IT Pistola termica con accessori
ES Secadora con accesorios
CN 热风枪

220-240V~50Hz
2000 W
450/600 °C
250-500 l/min
1.8 m



YATO 	[W]	
YT-82294	2000	5

EN Hot air gun with accessories
 PL Opalarka z akcesoriami
 DE Heissluftpistole
 RU Строительный фен в наборе
 CZ Opalovací stroj s příslušenstvím
 HU Hőlégfúvó tartozékokkal
 RO Pistol cu aer cald cu accesorii
 FR Décapeur thermique avec accessoires
 IT Pistola termica con accessori
 ES Secadora con accesorios
 CN 热风枪

220-240V~50Hz
2000 W
 50-600 °C
 250-500 l/min
 TEMPERATURE REGULATION
 REGULACJA TEMPERATURY
 1.8 m

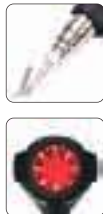

YATO	[W]	
YT-82295	2000	5

EN Hot air gun with accessories
 PL Opalarka z akcesoriami
 DE Heissluftpistole
 RU Строительный фен в наборе
 CZ Opalovací stroj s příslušenstvím
 HU Hőlégfúvó tartozékokkal
 RO Pistol cu aer cald cu accesorii
 FR Décapeur thermique avec accessoires
 IT Pistola termica con accessori
 ES Secadora con accesorios
 CN 热风枪

220-240V~50Hz
1600 W
 50-650 °C
 250-500 l/min
 LCD
 TEMPERATURE REGULATION
 REGULACJA TEMPERATURY
 1.8 m



YATO	[W]	
YT-82296	1500-1600	5

EN Hot air gun accessories set
 PL Zestaw akcesoriów do opalarki
 DE Heißluftpistolen-Zubehörsatz
 RU Набор принадлежностей для строительного фена
 CZ Sada příslušenství pro horkovzdušnou pistoli
 HU Hőlégfúvó tartozékcsészlet
 RO Set accesorii pt. pistol aer cald
 FR Accessoires de décapeur thermique
 IT Set di accessori per pistola termica
 ES Juego de accesorios para pistola de aire caliente
 CN 喷嘴五件套

5 PCS



For YT-82294, YT-82295, YT-82296
 Dla YT-82294, YT-82295, YT-82296

YATO		
YT-82301	50	

EN Blower
 PL Dmuchawa
 DE Gebläse
 RU Воздуходувка
 CZ Zahradní fukar
 HU Légfúvó
 RO Sulfantă
 FR Souffleur
 IT Soffiatore
 ES Soplador
 CN 吹吸机

$L_{pA} = 82,1 \pm 2,5$ dB;
 $L_{wA} = 95,0 \pm 2,5$ dB;
 $ah = 2,994 \pm 1,5$ m³/s



220-240V~50/60Hz
600 W
 6000-16000 min³
4 m³/min
 SUCTION FUNCTION
 FUNKCJA ZASYSANIA
 BLOW FUNCTION
 FUNKCJA Dmuchawy
 2 m



YATO	[W]	
YT-85170	600	4

EN Electric glue gun
 PL Pistolet do klejenia
 DE Heissklebepistole
 RU Пистолет для клея
 CZ Pistole na lepení
 HU Ragasztópisztoly
 RO Pistol pt. lipit cu batoane
 FR Électrique pistolet à colle
 IT Pistola colla
 ES Pistola de cola
 CN 热胶枪

230-240V~50Hz
30(450) W
 100-200 °C
 3-5 min
20 g/min
 11 mm
 1.5 m



Fitting glue sticks: see chapter 12
 Pasujące wkłady klejowe: patrz rozdział 12

YATO	[W]	Ø [mm]	[g/min]	
YT-82403	30 (450)	11	20	6

EN Electric glue gun
 PL Pistolet do klejenia
 DE Heissklebepistole
 RU Пистолет для клея
 CZ Pistole na lepení
 HU Ragasztópisztoly
 RO Pistol pt. lipit cu batoane
 FR Pistolet à colle
 IT Pistola colla
 ES Pistola de cola
 CN 热胶枪

230V~50Hz
35(400) W
 150-200 °C
 3-6 min
15 g/min
 2x
 Ø 11 mm



Fitting glue sticks: see chapter 12
 Pasujące wkłady klejowe: patrz rozdział 12

YATO	[W]	Ø [mm]	[g/min]	
YT-82401	35 (400)	11	15	12/24

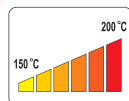

EN Electric glue gun
 PL Pistolet do klejenia
 DE Heissklebepistole
 RU Пистолет для клея
 CZ Pistole na lepení
 HU Ragasztópisztoly
 RO Pistol pt. lipit cu batoane
 FR Pistolet à colle
 IT Pistola colla
 ES Pistola de cola
 CN 热胶枪

230V~50Hz
20(80) W
 180-200 °C
 3-5 min
15 g/min
 3x
 Ø 11 mm



Fitting glue sticks: see chapter 12
 Pasujące wkłady klejowe: patrz rozdział 12

YATO	[W]	Ø [mm]	[g/min]	
YT-82402	20 (80)	11	15	12/48

EN Gasoline generator
PL Generator prądowłórczy
DE Stromgenerator
RU Генератор тока
CZ Generátor vytvářející proud
HU Áramfejlesztő generátorhoz

RO Generator de curent
FR Groupe électrogène
IT Generatore di corrente
ES Generador de corriente
CN 发电机

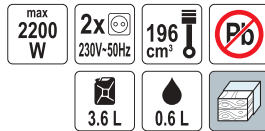

$L_{pA} = 72,7 \pm 2,03$ dB; $L_{wA} = 92,2 \pm 2,03$ dB

YATO
YT-85451 1

EN Gasoline generator
PL Generator prądowłórczy
DE Stromgenerator
RU Генератор тока
CZ Generátor vytvářející proud
HU Áramfejlesztő generátorhoz

RO Generator de curent
FR Groupe électrogène
IT Generatore di corrente
ES Generador de corriente
CN 发电机

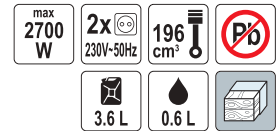

$L_{pA} = 73,6 \pm 2,0$ dB; $L_{wA} = 93,2 \pm 2,0$ dB

YATO
YT-85453 1

EN Gasoline generator
PL Generator prądowłórczy
DE Stromgenerator
RU Генератор тока
CZ Generátor vytvářející proud
HU Áramfejlesztő generátorhoz

RO Generator de curent
FR Groupe électrogène
IT Generatore di corrente
ES Generador de corriente
CN 发电机



$L_{pA} = 75,0 \pm 2,62$ dB; $L_{wA} = 93,7 \pm 2,62$ dB

YATO
YT-85460 1

EN Inverter generator
PL Generator prądowłórczy inwerterowy
DE Inverter-Stromgenerator
RU Инверторный генератор
CZ Invertorový generátor
HU Inverteres áramfejlesztő

RO Generator de curent
FR Générateur à onduleur
IT Generatore di corrente inverter
ES Generador inverter
CN 逆变发电机

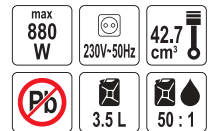

ULTRA LIGHT
8.5 kg

$L_{pA} = 70,46 \pm 0$ dB; $L_{wA} = 90,46 \pm 0$ dB

YATO
YT-85481 1

EN Portable power station
PL Przenośna stacja zasilania
DE Tragbares Kraftwerk
RU Портативная электростанция
CZ Přenosná nabíjecí stanice
HU Hordozható töltőállomás
RO Stație de încărcare portabilă
FR Centrale électrique portable
IT Stazione di alimentazione portatile
ES Fuente de alimentación portátil
CN 便携式储能电源

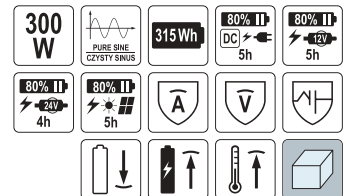

YATO
YT-83090 [W] 300 2

EN Portable power station
 PL Przenośna stacja zasilania
 DE Tragbares Kraftwerk
 RU Портативная электростанция
 CZ Přenosná nabíjecí stanice
 HU Hordozható töltőállomás
 RO Stație de încărcare portabilă
 FR Centrale électrique portable
 IT Stazione di alimentazione portatile
 ES Fuente de alimentación portátil
 CN 便携式储能电源

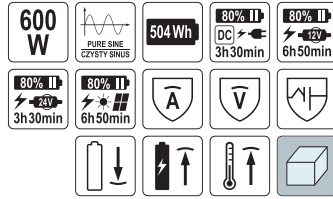

YATO [W]
 YT-83091 600 2

EN Portable power station
 PL Przenośna stacja zasilania
 DE Tragbares Kraftwerk
 RU Портативная электростанция
 CZ Přenosná nabíjecí stanice
 HU Hordozható töltőállomás
 RO Stație de încărcare portabilă
 FR Centrale électrique portable
 IT Stazione di alimentazione portatile
 ES Fuente de alimentación portátil
 CN 便携式储能电源

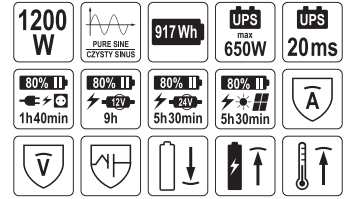

YATO [W]
 YT-83092 1200 1

EN Electric heater
 PL Nagrzewnica elektryczna
 DE Elektrisches Heizgerät
 RU Электрический обогреватель
 CZ Elektrický ohřivač
 HU Elektromos hőlégfűvő
 RO Aerotermă electrică
 FR Chauffage électrique
 IT Riscaldatore elettrico
 ES Calentador eléctrico
 CN 用电取暖器

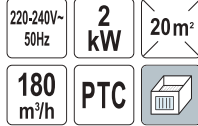

YATO [W]
 YT-99700 2000 8

EN Electric heater
 PL Nagrzewnica elektryczna
 DE Elektrisches Heizgerät
 RU Электрический обогреватель
 CZ Elektrický ohřivač
 HU Elektromos hőlégfűvő
 RO Aerotermă electrică
 FR Chauffage électrique
 IT Riscaldatore elettrico
 ES Calentador eléctrico
 CN 用电取暖器

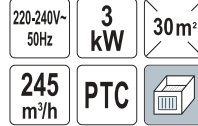

YATO [W]
 YT-99705 3000 1

EN Electric heater
 PL Nagrzewnica elektryczna
 DE Elektrisches Heizgerät
 RU Электрический обогреватель
 CZ Elektrický ohřivač
 HU Elektromos hőlégfűvő
 RO Aerotermă electrică
 FR Chauffage électrique
 IT Riscaldatore elettrico
 ES Calentador eléctrico
 CN 用电取暖器

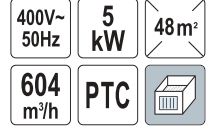

YATO [W]
 YT-99710 5000 1

EN Electric heater
 PL Nagrzewnica elektryczna
 DE Elektrisches Heizgerät
 RU Электрический обогреватель
 CZ Elektrický ohřivač
 HU Elektromos hőlégfűvő
 RO Aerotermă electrică
 FR Chauffage électrique
 IT Riscaldatore elettrico
 ES Calentador eléctrico
 CN 用电取暖器



YATO [W]
 YT-99690 2000 1

EN Electric heater
 PL Nagrzewnica elektryczna
 DE Elektrisches Heizgerät
 RU Электрический обогреватель
 CZ Elektrický ohřivač
 HU Elektromos hőlégfűvő
 RO Aerotermă electrică
 FR Chauffage électrique
 IT Riscaldatore elettrico
 ES Calentador eléctrico
 CN 用电取暖器

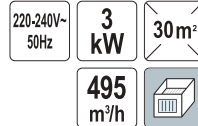

YATO [W]
 YT-99693 3000 1

EN Electric heater
 PL Nagrzewnica elektryczna
 DE Elektrisches Heizgerät
 RU Электрический обогреватель
 CZ Elektrický ohřivač
 HU Elektromos hőlégfűvő
 RO Aerotermă electrică
 FR Chauffage électrique
 IT Riscaldatore elettrico
 ES Calentador eléctrico
 CN 用电取暖器

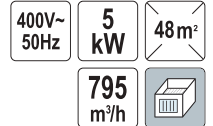



YATO [W]
 YT-99695 5000 1

EN Electric heater
PL Nagrzewnica elektryczna
DE Elektrisches Heizgerät
RU Электрический обогреватель
CZ Elektrický ohřivač
HU Elektromos hőlégtűvő
RO Aerotermă electrică
FR Chauffage électrique
IT Riscaldatore elettrico
ES Calentador eléctrico
CN 用电取暖器



220-240V~50Hz **3 kW** 30m² 322 m³/h PTC 

YATO 	[W]	
YT-99720	3000	1

EN Gas fired heater
PL Nagrzewnica gazowa
DE Gasheizgerät
RU Газовый обогреватель
CZ Plynový ohřivač
HU Gáztűzelésű hőlégtűvő
RO Încalzitor cu gaz
FR Chauffage à gaz
IT Riscaldatore a gas
ES Calentador de aire por gas
CN 燃气取暖器

220-240V~50Hz **15 kW** 70 MPa 320 m³/h 



YATO 	[kW]	
YT-99730*	15	1

EN Gas fired heater
PL Nagrzewnica gazowa
DE Gasheizgerät
RU Газовый обогреватель
CZ Plynový ohřivač
HU Gáztűzelésű hőlégtűvő
RO Încalzitor cu gaz
FR Chauffage à gaz
IT Riscaldatore a gas
ES Calentador de aire por gas
CN 燃气取暖器

220-240V~50Hz **30 kW** 70 MPa 650 m³/h 



YATO 	[kW]	
YT-99733*	30	1

EN Direct oil fired heater
PL Nagrzewnica olejowa
DE Ölheizgerät
RU Масляный обогреватель
CZ Olejový ohřivač
HU Olajfűtés
RO Încalzitor motorină
FR Chauffage à huile
IT Riscaldatore a olio
ES Calentador de aire aceite
CN 燃油取暖器

220-240V~50Hz **30 kW** 750 m³/h
2.4 kg/h 38 L 



YATO 	[kW]	
YT-99740*	30	1

EN Direct oil fired heater
PL Nagrzewnica olejowa
DE Ölheizgerät
RU Масляный обогреватель
CZ Olejový ohřivač
HU Olajfűtés
RO Încalzitor motorină
FR Chauffage à huile
IT Riscaldatore a olio
ES Calentador de aire aceite
CN 燃油取暖器

220-240V~50Hz **50 kW** 1100 m³/h
4.0 kg/h 50 L 



YATO 	[kW]	
YT-99743*	50	1

EN Direct oil fired heater
 PL Nagrzewnica olejowa
 DE Ölheizgerät
 RU Масляный обогреватель
 CZ Olejový ohřivač
 HU Olajfűtés
 RO Încălzitor motorină
 FR Chauffage à huile
 IT Riscaldatore a olio
 ES Calentador de aire aceite
 CN 燃油取暖器

220-240V-50Hz 20 kW 200m² 600 m³/h 1.65 kg/h 38 L



YATO	[kW]	
YT-99738*	20	1

EN Dehumidifier
 PL Osuszacz budowlany
 DE Bautrockner
 RU Строительный осушитель воздуха
 CZ Stavební vysoušeč
 HU Építőipari párálanító
 RO Dezhumidificator pt. constructii
 FR Déshumidificateur de chantier
 IT Deumidificatore
 ES Deshumidificador de obra
 CN 工业除湿机



220-240V-50Hz max 900 W
 50L/24h 30°C R_s 80% 300 m³/h
 50-120 m² 7 L
 24h R290
 AUTOMATIC DEFROST AUTOMATYCZNE ODSZRAMIANIE IP22
 LCD

YATO	[W]	
YT-99650	750 (27°C; Rh 60%) / 900 (30°C; Rh 80%)	1

EN Gasoline water pump
 PL Spalinowa pompa wodna
 DE Benzin-Wasserpumpe
 RU Бензиновая мотопомпа
 CZ Benzinové vodní čerpadlo
 HU Benzinmotoros szivattyú
 RO Motorpompă de apă
 FR Pompe à eau à essence
 IT Motopompa per acqua a benzina
 ES Bomba de agua a gasolina
 CN 汽油水泵机

4.0 kW 3600 min⁻¹ 208 cm³ 50 mm 2" 25 m 8 m 3.6 L



L_{PA} = 82,1 ± 3,0 dB; L_{WA} = 95,4 ± 3,0 dB

YATO		
YT-85401	1	

EN Gasoline water pump
 PL Spalinowa pompa wodna
 DE Benzin-Wasserpumpe
 RU Бензиновая мотопомпа
 CZ Benzinové vodní čerpadlo
 HU Benzinmotoros szivattyú
 RO Motorpompă de apă
 FR Pompe à eau à essence
 IT Motopompa per acqua a benzina
 ES Bomba de agua a gasolina
 CN 汽油水泵机

4.0 kW 3600 min⁻¹ 208 cm³ 80 mm 3" 20 m 8 m 3.6 L



L_{PA} = 81,9 ± 3,0 dB; L_{WA} = 95,0 ± 3,0 dB

YATO		
YT-85402	1	

EN Gasoline water pump
 PL Spalinowa pompa wodna
 DE Benzin-Wasserpumpe
 RU Бензиновая мотопомпа
 CZ Benzinové vodní čerpadlo
 HU Benzinmotoros szivattyú
 RO Motorpompă de apă
 FR Pompe à eau à essence
 IT Motopompa per acqua a benzina
 ES Bomba de agua a gasolina
 CN 汽油水泵机

4.0 kW 3600 min⁻¹ 208 cm³ 100mm 4" 20 m 8 m 3.6 L



L_{PA} = 81,9 ± 3,0 dB; L_{WA} = 94,9 ± 3,0 dB

YATO		
YT-85403	1	

EN Submersible pump for dirty water and wastewater
PL Pompa zatapialna do wody brudnej i ścieków
DE Tauchpumpe für Schmutzwasser
RU Погружной насос для грязной воды
CZ Ponorné čerpadlo pro odpadní vody
HU Bűvárszivattyú szennyvíz
RO Pompă submersibilă pt. apă murdară
FR Pompe submersible pour eaux usees
IT Pompa sommersa per acque reflue
ES Bomba sumergible para aguas residuales
CN 污水切割泵



230V~
50Hz

400 W

Q max
12000
l/h

Δ	Q [l/h]
3	12000
4	9000
5	6000
6	3000
7	1500
7.5	500

YATO	[W]	[l/h]	H max. [m]	
YT-85349	400	12000	7.5	1

EN Submersible pump for dirty water and wastewater
PL Pompa zatapialna do wody brudnej i ścieków
DE Tauchpumpe für Schmutzwasser
RU Погружной насос для грязной воды
CZ Ponorné čerpadlo pro odpadní vody
HU Bűvárszivattyú szennyvíz
RO Pompă submersibilă pt. apă murdară
FR Pompe submersible pour eaux usees
IT Pompa sommersa per acque reflue
ES Bomba sumergible para aguas residuales
CN 污水切割泵



230V~
50Hz

750 W

Q max
16000
l/h

Δ	Q [l/h]
0	16000
1	15000
2	14000
3	13500
4	12500
5	11500
6	11000
7	10500
8	9500
9	8000
10	5500
11	3500
12	2000
13	500



YATO	[W]	[l/h]	H max. [m]	
YT-85350	750	16000	13	1

EN Dirty water submersible pump
PL Pompa zatapialna do wody brudnej
DE Tauchpumpe für Schmutzwasser
RU Погружной насос для грязной воды
CZ Ponorné čerpadlo pro špinavú vodu
HU Bűvárszivattyú
RO Pompă submersibilă
FR Pompe submersible pour eaux polluées
IT Pompa sommersa per acque reflue
ES Bomba sumergible para agua sucia
CN 清污两用潜水泵



220-240V~
50Hz

400 W

Q max
11000
l/h

Δ	Q [l/h]
0	11000
1	10500
2	10000
3	9500
4	9000
5	8000
6	7000
7	6000
8	5000
9	4000
10	3000
11	2000
12	1000

YATO	[W]	[l/h]	H max. [m]	
YT-85330	400	11000	5.8	4

EN Deep well pump
PL Pompa głębinowa
DE Tiefbrunnenpumpe
RU Глубинный насос
CZ Čerpadlo do vrtaných studní
HU Bűvárszivattyú
RO Pompă submersibilă
FR Pompe de puits profond
IT Pompa sommergibile
ES Bomba agua sumergible
CN 深井泵



230V~
50Hz

370 W

Q max
5400
l/min

20 m



YATO	[W]	[l/h]	
YT-85300	370	5400	1

EN Deep well pump
PL Pompa głębinowa
DE Tiefbrunnenpumpe
RU Глубинный насос
CZ Čerpadlo do vrtaných studní
HU Bűvárszivattyú
RO Pompă submersibilă
FR Pompe de puits profond
IT Pompa sommergibile
ES Bomba agua sumergible
CN 深井泵



230V~
50Hz

550 W

Q max
6000
l/h

20 m



YATO	[W]	[l/h]	
YT-85301	550	6000	1

EN Dirty water submersible pump
PL Pompa zatapialna do wody brudnej
DE Tauchpumpe für Schmutzwasser
RU Погружной насос для грязной воды
CZ Ponorné čerpadlo pro špinavú vodu
HU Bűvárszivattyú
RO Pompă submersibilă
FR Pompe submersible pour eaux polluées
IT Pompa sommersa per acque reflue
ES Bomba sumergible para agua sucia
CN 清污两用潜水泵



220-240V~
50Hz

900 W

Q max
18000
l/h



Δ	Q [l/h]
0	18000
1	17000
2	16000
3	15000
4	14000
5	12000
6	11000
7	10000
8	8000
9	7000
10	6000
11	5000
12	4000
13	3000
14	2000
15	100

YATO	[W]	[l/h]	H max. [m]	
YT-85333	900	18000	8.9	4

EN Submersible pump for rainwater
 PL Pompa zatapialna do deszczówki
 DE Tauchpumpe für Regenwassernutzung
 RU Погружной насос для дождевой воды
 CZ Ponorné čerpadlo na dešťovou vodu
 HU Merülő szivattyú esővízhez
 RO Pompă submersibilă pt. apă de ploaie
 FR Pompe submersible pour eau de pluie
 IT Pompa sommersa per acqua piovana
 ES Bomba sumergible para aguas pluviales
 CN 雨水泵

- Float switch
- High pressure
- For clean water

- Wyłącznik pływakowy
- Wysokociśnieniowa
- Do wody czystej

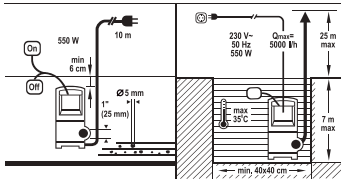
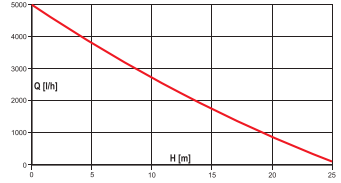

230V~50Hz 550 W
 Q max 5000 l/h
 25m
 7m
 2.5 bar (max.)
 max °C 35
 IPX8
 10m

YATO	[W]	[l/h]	H max. [m]	
YT-85286	550	5000	25	4

EN Submersible pump for rainwater
 PL Pompa zatapialna do deszczówki
 DE Tauchpumpe für Regenwassernutzung
 RU Погружной насос для дождевой воды
 CZ Ponorné čerpadlo na dešťovou vodu
 HU Merülő szivattyú esővízhez
 RO Pompă submersibilă pt. apă de ploaie
 FR Pompe submersible pour eau de pluie
 IT Pompa sommersa per acqua piovana
 ES Bomba sumergible para água da chuva
 CN 雨水泵

- Sensor switch
- High pressure
- For clean water

- Wyłącznik automatyczny
- Wysokociśnieniowa
- Do wody czystej

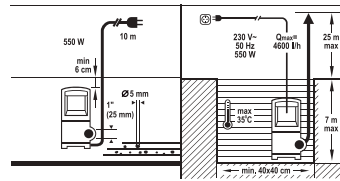
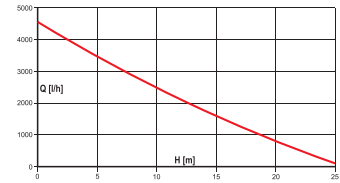

230V~50Hz 550 W
 Q max 4600 l/h
 25m
 7m
 2.5 bar (max.)
 max °C 35
 IPX8
 10m
 AUTO ON / OFF
 AUTO WL. WYL.

YATO	[W]	[l/h]	H max. [m]	
YT-85287	550	4600	25	4

EN Dirty water submersible pump
 PL Pompa zatapialna do wody brudnej
 DE Tauchpumpe für Schmutzwasser
 RU Погружной насос для грязной воды
 CZ Ponorné čerpadlo pro špinavú vodu
 HU Bűvárszivattyú
 RO Pompă submersibilă
 FR Pompe submersible pour eaux polluées
 IT Pompa sommersa per acque reflue
 ES Bomba sumergible para agua sucia
 CN 不锈钢潜水泵 (内置式开关)

Δ	Q [l/h]
0	11000
1	10500
2	10000
3	9500
4	9000
5	8500
6	8000
7	7500
8	7000
9	6500
10	6000
11	5000
12	4000
13	3000
14	2000
15	1000



230V~50Hz 750 W
 Q max 11000 l/h

YATO	[W]	[l/h]	H max. [m]	
YT-85341	750	11000	8.5	3

EN Dirty water submersible pump
 PL Pompa zatapialna do wody brudnej
 DE Tauchpumpe für Schmutzwasser
 RU Погружной насос для грязной воды
 CZ Ponorné čerpadlo pro špinavú vodu
 HU Bűvárszivattyú
 RO Pompă submersibilă
 FR Pompe submersible pour eaux polluées
 IT Pompa sommersa per acque reflue
 ES Bomba sumergible para aguas sucias
 CN 不锈钢潜水泵 (浮球开关)

Δ	Q [l/h]
0	17000
1	16500
2	16000
3	15000
4	14000
5	13000
6	12000
7	11000
8	10000
9	9000
10	8000
11	7000
12	6000
13	5000
14	4000
15	3000
16	2000
17	1000



230V~50Hz 1100 W
 Q max 17000 l/h

YATO	[W]	[l/h]	H max. [m]	
YT-85343	1100	17000	10	3

EN Brass straight connection
 PL Króciec mosiężny do pomp
 DE Messingstutzen für Pumpen
 RU Латунный патрубок для насосов
 CZ Mosazná přípojka pro čerpadla
 HU Sárgaréz csatlakozó szivattyúkhöz
 RO Conector alama
 FR Raccord de pompe en laiton
 IT Raccordo in ottone per pompe
 ES Conector de latón para bombas
 CN 铜接头

1" 25mm BRASS MOSIADZ



YATO	
YT-85395	10/80

EN Drill pump
 PL Pompka na wiertarkę
 DE Bohrerpumpe
 RU Насос для дрели
 CZ Čerpadlo na vrtačku
 HU Szivattyú fúróra
 RO Pompă transfer lichide
 FR Pompe pour perceuse
 IT Pompa per trapano
 ES Bomba para taladradora
 CN 手转泵



Q max 2.4 m³/h
 3.0m
 3400 min³ (max.)
 8mm
 STANDARD

YATO	
YT-89000	6/60

EN Garden pump with filter
PL Pompa ogrodowa z filtrem
DE Gartenpumpe mit Filter
RU Насос садовый с фильтром
CZ Zahradní čerpadlo s filtrem
HU Kerti szivattyú szűrővel
RO Pompă de grădină cu filtru
FR Pompe de jardin à filtre intégré
IT Pompa da giardino con filtro
ES Bomba de jardín con filtro
CN 花园泵

230V~50Hz	850 W	Q max 3600 l/h	38 m	8 m	3.8 bar (max.)
	1" 25mm	max °C 35	IPX4	1.2 m	



- Built-in pre-filter
- Current pressure built-in gauge
- Waterproof housing
- Comfortable carry handle
- For clean water

- Wbudowany filtr wstępny
- Wbudowany manometr bieżącego ciśnienia
- Wodoszczelna obudowa
- Wygodny uchwyt do przenoszenia
- Do wody czystej

$L_{pA} = 60,89 \pm 3,0$ dB; $L_{wA} = 72,01 \pm 3,0$ dB

YATO	[W]	[l/h]	H max. [m]	
YT-85363	850	3600	38	1

EN Electronic hydrophore pump with filter
PL Hydrofor elektroniczny z filtrem
DE Elektronisches Hauswasserwerk mit Filter
RU Гидрофор электронный с фильтром
CZ Elektronická domácí vodárna s filtrem
HU Elektronikus hidrofor szűrővel
RO Hidrofor electronic cu filtru
FR Groupe de surpression électrique avec filtre
IT Pompa autoclave elettronica con filtro
ES Grupo de presión electrónico con filtro
CN 花园泵

230V~50Hz	850 W	Q max 3600 l/h	38 m	8 m	3.8 bar (max.)
	1" 25mm	max °C 35	IPX4	LCD	1.2 m
		AUTO ON / OFF AUTO WŁ. WYŁ.			



- Built-in pre-filter
- 24 h automatic working mode
- Current pressure built-in gauge
- Automatic hydrophore working mode
- Protection against dry running
- Waterproof housing
- Comfortable carry handle
- For clean water

- Wbudowany filtr wstępny
- Automatyczny tryb pracy 24 h
- Wbudowany manometr bieżącego ciśnienia
- Automatyczny hydroforowy tryb pracy
- Zabezpieczenie przed suchobiegami
- Wodoszczelna obudowa
- Wygodny uchwyt do przenoszenia
- Do wody czystej



$L_{pA} = 60,89 \pm 3,0$ dB; $L_{wA} = 72,01 \pm 3,0$ dB

YATO	[W]	[l/h]	H max. [m]	
YT-85371	850	3600	38	1

EN Hydrophore pump
PL Hydrofor
DE Hauswasserwerk
RU Гидрофор
CZ Vodárna domácí
HU Hidrofor
RO Hidrofor
FR Groupe de surpression
IT Pompa autoclave
ES Grupo de presión
CN 花园泵



$L_{pA} = 69,43 \pm 1,49$ dB; $L_{wA} = 82,35 \pm 1,49$ dB

EN Garden pump with filter
PL Pompa ogrodowa z filtrem
DE Gartenpumpe mit Filter
RU Насос садовый с фильтром
CZ Zahradní čerpadlo s filtrem
HU Kerti szivattyú szűrővel
RO Pompă de grădină cu filtru
FR Pompe de jardin à filtre intégré
IT Pompa da giardino con filtro
ES Bomba de jardín con filtro
CN 花园泵

230V~50Hz	1300 W	Q max 5000 l/h	53 m	8 m	5.3 bar (max.)
	1" 25mm	max °C 35	IPX4	1.2 m	



- Built-in pre-filter
- Current pressure built-in gauge
- Waterproof housing
- Comfortable carry handle
- For clean water

- Wbudowany filtr wstępny
- Wbudowany manometr bieżącego ciśnienia
- Wodoszczelna obudowa
- Wygodny uchwyt do przenoszenia
- Do wody czystej

$L_{pA} = 63,69 \pm 3,0$ dB; $L_{wA} = 74,97 \pm 1,0$ dB

YATO	[W]	[l/h]	H max. [m]	
YT-85364	1300	5000	53	1

EN Electronic hydrophore pump with filter
PL Hydrofor elektroniczny z filtrem
DE Elektronisches Hauswasserwerk mit Filter
RU Гидрофор электронный с фильтром
CZ Elektronická domácí vodárna s filtrem
HU Elektronikus hidrofor szűrővel
RO Hidrofor electronic cu filtru
FR Groupe de surpression électrique avec filtre
IT Pompa autoclave elettronica con filtro
ES Grupo de presión electrónico con filtro
CN 花园泵

230V~50Hz	1300 W	Q max 5000 l/h	53 m	8 m	5.3 bar (max.)
	1" 25mm	max °C 35	IPX4	LCD	1.2 m
		AUTO ON / OFF AUTO WŁ. WYŁ.			



- Built-in pre-filter
- 24 h automatic working mode
- Current pressure built-in gauge
- Automatic hydrophore working mode
- Protection against dry running
- Waterproof housing
- Comfortable carry handle
- For clean water

- Wbudowany filtr wstępny
- Automatyczny tryb pracy 24 h
- Wbudowany manometr bieżącego ciśnienia
- Automatyczny hydroforowy tryb pracy
- Zabezpieczenie przed suchobiegami
- Wodoszczelna obudowa
- Wygodny uchwyt do przenoszenia
- Do wody czystej



$L_{pA} = 63,69 \pm 3,0$ dB; $L_{wA} = 74,97 \pm 1,0$ dB

YATO	[W]	[l/h]	H max. [m]	
YT-85372	1300	5000	53	1

230V~50Hz	1200 W	1" 25mm	4000 l/h
50 m	9 m	max °C 35	19 L
IPX4	INOX		

YATO	[W]	[l/h]	H max. [m]	
YT-85370	1200	4000	50	1

EN Cordless submersible garden pump
 PL Akumulatorowa pompa ogrodowa zatajalna
 DE Akku-Garten-Tauchpumpe
 RU Аккумуляторный садовый насос
 CZ Akumulátorové zahradní čerpadlo
 HU Akkumulátoros kerti merülő szivattyú
 RO Pompă submersibilă fără acumulator
 FR Pompe de jardin submersible sans-fil
 IT Pompa sommersa da giardino a batteria
 ES Bomba de batería sumergible para jardín
 CN 充电式潜水泵

18 V
Li-Ion
2 bar
2500 l/h
21 m
1.5 m
max °C 35
IPX8

18V
Li-Ion

Battery not included
 Ohne Akku / Bez akumulatora
 Bez Gamapevu / Bez aku
 Akkumulátor nélkül
 Fără baterie / Sans batterie
 Senza batteria / Sin batería
 没有电池



L_{wa} = <70 dB

YATO	[V d.c.]	
YT-85281	18	4

EN Cordless barrel pump
 PL Akumulatorowa pompa do deszczówki
 DE Akku-Regenfasspumpe
 RU Аккумуляторный насос для дождевой воды
 CZ Akumulátorové čerpadlo na dešťovou vodu
 HU Akkumulátoros esővíz szivattyú
 RO Pompă submersibilă fără acumulator
 FR Pompe à eau de pluie sans-fil
 IT Pompa per acqua piovana a batteria
 ES Bomba de batería para aguas pluviales
 CN 充电式潜水泵

18 V
Li-Ion
2 bar
19 mm
2100 l/h
21 m
1.5 m
max °C 35
IPX8



Battery not included
 Ohne Akku / Bez akumulatora
 Bez Gamapevu / Bez aku
 Akkumulátor nélkül
 Fără baterie / Sans batterie
 Senza batteria / Sin batería
 没有电池

L_{wa} = <70 dB

YATO	[V d.c.]	
YT-85283	18	4

EN High pressure washer
 PL Myjka ciśnieniowa
 DE Hochdruckreiniger
 RU Мойка высокого давления
 CZ Tlakový mycí stroj
 HU Vízszóró
 RO Aparat de spălat cu presiune
 FR Nettoyeur haute pression
 IT Idropulitrice
 ES Lavadora de presión
 CN 高压清洗机

230-240V~
50Hz
1500 W
12 MPa (max.)
8.0 MPa
5 l/min
IPX5



L_{pa} = 77,3 ± 3,0 dB; L_{wa} = 84,3 ± 3,0 dB; a_v = 2,08 ± 1,5 m/s²

YATO	[W]	
YT-85910	1500	1

EN High pressure washer
 PL Myjka ciśnieniowa
 DE Hochdruckreiniger
 RU Мойка высокого давления
 CZ Tlakový mycí stroj
 HU Vízszóró
 RO Aparat de spălat cu presiune
 FR Nettoyeur haute pression
 IT Idropulitrice
 ES Lavadora de presión
 CN 高压清洗机

220-240V~
50Hz
2000 W
15 MPa (max.)
10 MPa
6 l/min
IPX5



L_{pa} = 85,8 ± 3,0 dB; L_{wa} = 95,39 ± 3,0 dB; a_v = 2,64 m/s²

YATO	[W]	
YT-85915	2000	1

EN Cordless pressure washer
 PL Akumulatorowa myjka ciśnieniowa
 DE Akku-Hochdruckreiniger
 RU Аккумуляторная мойка высокого давления
 CZ Bateriový tlakový čistič
 HU Akkumulátoros mosó
 RO Aparat de spălat cu presiune fără acumulator
 FR Nettoyeur à haute pression sans-fil
 IT Idropulitrice a batteria
 ES Limpiadora a vapor a batería
 CN 高压清洗机

18 V
Li-Ion
IN (max.) 0.5 MPa
OUT 2.3 MPa
6 m
SUCTION FUNCTION
FUNKCIJA ZASYSANIA



18V
Li-Ion

Battery not included
 Ohne Akku / Bez akumulatora
 Bez Gamapevu / Bez aku
 Akkumulátor nélkül
 Fără baterie / Sans batterie
 Senza batteria / Sin batería
 没有电池

YATO	[V d.c.]	
YT-85930	18	6

EN Cordless leaf vacuum / blower
PL Akumulatorowy odkurzacz / dmuchawa do liści
DE Akku-Laubsauger / Laubbläser
RU Аккумуляторная воздуходувка-пылесос
CZ Akumulátorový vysavač / fukar na listí
HU Akkumulátoros lombszívó / lombfúvó
RO Sulfantă / aspirator fără acumulator
FR Aspirateur / souffleur de feuilles sans-fil
IT Aspiratore / soffiatore per foglie a batteria
ES Aspirador / soplador de hojas de batería
CN 锂电无刷吹吸机

- Leaves compress volume function 8:1
- Blowing air speed: 230 km/h
- Funkcja zmniejszania objętości liści 8:1
- Prędkość wydmuchiwanego powietrza: 230 km/h



2in1
2w1
36V
2x 18V
Li-Ion
6000-12500
min⁻¹
8
m³/min
45L

Battery not included
Ohne Akku / Bez akumulatora
Bez baterije / Bez aku
Акумулятор некіл
Fără baterie / Sans batterie
Senza batteria / Sin batería
没有电池

18V
Li-Ion

$L_{pA} = 80,5 \pm 3,0$ dB; $L_{wA} = 92,7 \pm 3,0$ dB; $a_n = 2,37 \pm 1,5$ m/s²

YATO	[V d.c.]	
YT-85175	36 (18 x2)	1

EN Cordless leaf blower
PL Akumulatorowa dmuchawa do liści
DE Akku-Laubbläser
RU Аккумуляторная воздуходувка
CZ Akumulátorový fukar na listí
HU Akkumulátoros lombfúvó
RO Sulfantă cu acumulator
FR Souffleur de feuilles sans-fil
IT Soffiatore per foglie a batteria
ES Soplador de hojas de batería
CN 吹风机

18V
Li-Ion
13000
min⁻¹
16000
min⁻¹
400-570
m³/h
100-126
km/h
TURBO



18V
Li-Ion

$L_{pA} = 76,3 \pm 3,0$ dB; $L_{wA} = 90,9 \pm 2,67$ dB; $a_n = 0,49 \pm 1,5$ m/s²

YATO	[V d.c.]	Battery capacity / Pojemność akumulatora [mAh]	Battery quantity / Liczba akumulatorów w zestawie
YT-85176	18	4000	2
YT-85177	18	-	brak

EN Cordless backpack sprayer
PL Akumulatorowy opryskiwacz plecakowy
DE Akku-Drucksprüher
RU Аккумуляторный ранцевый опрыскиватель
CZ Aku postřikovač
HU Akkumulátoros hátipermetező
RO Pulverizator fără acumulator
FR Pulvérisateur à batterie
IT Pompa irroratrice a spalla a batteria
ES Pulverizador de mochila a batería
CN 充电式喷雾器

- Water tank
- Sprayer
- Hydronetka
- Opryskiwacz

Battery not included
Ohne Akku / Bez akumulatora
Bez baterije / Bez aku
Акумулятор некіл
Fără baterie / Sans batterie
Senza batteria / Sin batería
没有电池



18V
Li-Ion

$L_{pA} = 60,0 \pm 3,0$ dB; $L_{wA} = 70,0 \pm 3,0$ dB; $a_n = 0,74 \pm 1,5$ m/s²

YATO	[V d.c.]	
YT-86211	18	1

EN Cordless leaf vacuum / blower
PL Akumulatorowy odkurzacz / dmuchawa do liści
DE Akku-Laubsauger / Laubbläser
RU Аккумуляторная воздуходувка-пылесос
CZ Akumulátorový vysavač / fukar na listí
HU Akkumulátoros lombszívó / lombfúvó
RO Sulfantă / aspirator fără acumulator
FR Aspirateur / souffleur de feuilles sans-fil
IT Aspiratore / soffiatore per foglie a batteria
ES Aspirador / soplador de hojas de batería
CN 锂电无刷吹吸机

- Vacuuming
- Blowing
- Shredding
- Blowing air speed: 270 km/h

- Odkurzanie
- Dmuchanie
- Rozdrabnianie
- Prędkość wydmuchiwanego powietrza: 270 km/h



3in1
3w1
36V
2x 18V
Li-Ion
6000-17000
min⁻¹
308-700
m³/h
270
km/h
45L
BRUSHLESS MOTOR
SIŁNIK BEZ
SZCZOTKOWY

Battery not included
Ohne Akku / Bez akumulatora
Bez baterije / Bez aku
Акумулятор некіл
Fără baterie / Sans batterie
Senza batteria / Sin batería
没有电池

18V
Li-Ion

$L_{pA} = 87,6 \pm 3,0$ dB; $L_{wA} = 96,5 \pm 3,0$ dB; $a_n = 1,69 \pm 1,5$ m/s²

YATO	[V d.c.]	
YT-85173	36 (18 x2)	2

EN Cordless leaf blower
PL Akumulatorowa dmuchawa do liści
DE Akku-Laubbläser
RU Аккумуляторная воздуходувка
CZ Akumulátorový fukar na listí
HU Akkumulátoros lombfúvó
RO Sulfantă fără acumulator
FR Souffleur de feuilles sans-fil
IT Soffiatore per foglie a batteria
ES Soplador de hojas de batería
CN 吹风机

36V
2x 18V
Li-Ion
19000
min⁻¹
900
m³/h
200
km/h
TURBO
SOFT GRIP
MIĘKKI
UCHWYT



18V
Li-Ion

$L_{pA} = 76,3 \pm 3,0$ dB; $L_{wA} = 90,9 \pm 2,67$ dB; $a_n = 0,49 \pm 2,67$ m/s²

YATO	[V d.c.]	
YT-85179	36 (18 x2)	2

EN Battery sprayer with solar panel
PL Opryskiwacz akumulatorowo-solarny
DE Solar-Akku-Sprühergerät
RU Опрыскиватель аккумуляторный на солнечной батарее
CZ Postřikovač bateriový-solární
HU Akkumulátoros-napelemes permetező
RO Vermorel cu alimentare solara
FR Pulvérisateur à batterie et à dos solaire
IT Pompa irroratrice a batteria e ad energia solare
ES Pulverizador solar a batería
CN 电动太阳能喷雾器



12V
0.15-0.4
MPa
3.1
l/min
16L
8.0
Ah
PP
SS
STAINLESS STEEL
STAL NIERZEWNA

YATO	[V d.c.]	
YT-86220	12	1

EN Cordless telescopic pole saw
 PL Akumulatorowa okreszywarka na wysięgniku
 DE Akku-Teleskop-Hochentaster
 RU Аккумуляторный телескопический высоторез
 CZ Akumulátorová teleskopická vyvívavací pila
 HU Akkus magassági ágvágó fűrész
 RO Drujbă telescopică cu acumulator
 FR Elagueuse sur perche télescopique sans-fil
 IT Decescopugiatore telescopico a batteria
 ES Sierra de pértiga telescópica a batería
 CN 充电式高枝锯

18V
Li-Ion

2500 min⁻¹

5 m/s

8" / 20 cm

280 / 200 cm

EASY TRANSPORT
LATVY TRANSPORT

18V
Li-Ion

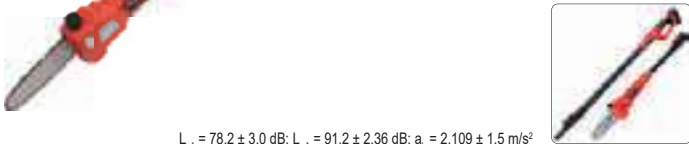

$L_{pa} = 78,2 \pm 3,0$ dB; $L_{wa} = 91,2 \pm 2,36$ dB; $a_p = 2,109 \pm 1,5$ m/s²

YATO	[V d.c.]	Battery capacity / Pojemność akumulatora [mAh]	⚡ [h]	Battery quantity / Liczba akumulatorów w zestawie	
YT-82836	18	2000	1	1	2
YT-82837	18	-	-	brak	2

EN Cordless garden multi tool
 PL Akumulatorowe wielofunkcyjne narzędzie ogrodowe
 DE Akku-Garten-Multifunktionsgerät
 RU Многофункциональный аккумуляторный садовый инструмент
 CZ Akumulátorové multifunkční zahradní nářadí
 HU Többfunkciós akkumulátoros kerti szerszám
 RO Fierăstrău multifuncțional de grădină cu acumulator
 FR Outil multifonction de jardin sans-fil
 IT Utensile multifunzione da giardinaggio a batteria
 ES Herramienta de jardín multifuncional a batería
 CN 园林多功能机

2in1 / 2 w 1

18V
Li-Ion

2500 min⁻¹

8" / 20 cm

4.5 m/s

1500 min⁻¹

415 mm

AUTOMATIC OIL LUBRICATION SYSTEM / AUTOMATYCZNE SMAROWANIE UKŁADU TŁACZEGO

QUICK CHAIN TENSION SYSTEM / SYSTEM SZYBEGO NAPIĘCIANIA ŁAŃCZYCA

ROTATING HANDLE / OBROTOWY UCHWYT

18V
Li-Ion

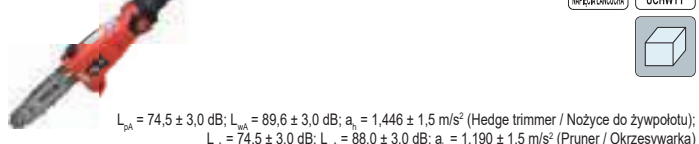

$L_{pa} = 74,5 \pm 3,0$ dB; $L_{wa} = 89,6 \pm 3,0$ dB; $a_p = 1,446 \pm 1,5$ m/s² (Hedge trimmer / Nożyce do żywopłotu);
 $L_{pa} = 74,5 \pm 3,0$ dB; $L_{wa} = 88,0 \pm 3,0$ dB; $a_p = 1,190 \pm 1,5$ m/s² (Pruner / Okreszywarka)

YATO	[V d.c.]	Battery capacity / Pojemność akumulatora [mAh]	⚡ [h]	Battery quantity / Liczba akumulatorów w zestawie	
YT-828390	18	2000	1	1	2
YT-828391	18	-	-	brak	2

EN Pole saw
 PL Okreszywarka na wysięgniku
 DE Teleskop-Hochentaster
 RU Телескопический высоторез
 CZ Teleskopická vyvívavací pila
 HU Magassági ágvágó fűrész
 RO Fierăstrău cu lanț telescopic
 FR Elagueuse sur perche télescopique
 IT Decescopugiatore telescopico
 ES Sierra de pértiga telescópica
 CN 高枝锯

220-240V-50Hz

710 W

4500 min⁻¹

10" / 25 cm

9.5 m/s

40

0.05" / 1.3 mm

255 / 188 cm

AUTOMATIC OIL LUBRICATION SYSTEM / AUTOMATYCZNE SMAROWANIE UKŁADU TŁACZEGO

QUICK CHAIN TENSION SYSTEM / SYSTEM SZYBEGO NAPIĘCIANIA ŁAŃCZYCA

HEAD ANGLE ADJUSTMENT / REGULACJA KĄTA GŁOWICY

TELESCOPIC HANDLE / UCHWYT TELESKOPOWY

SOFT GRIP / MIEKKI UCHWYT



$L_{pa} = 88,7 \pm 3,0$; $L_{wa} = 100,3 \pm 3,0$; $a_p = 1,353 \pm 1,5 / 2,134 \pm 1,5$ m/s²

YATO	[W]	
YT-84800	710	2

EN Cordless grass trimmer
 PL Akumulatorowa podkaszarka do trawy
 DE Akku-Rasentrimmer
 RU Аккумуляторный триммер
 CZ Akumulátorová strunová sekačka
 HU Akkus szegélynyíró
 RO Trimmer de gazon cu acumulator
 FR Débroussaillouse sans-fil
 IT Tagliabordi a batteria
 ES Desbrozadora a batería
 CN 充电式打草机

18V
Li-Ion

7200 min⁻¹

250/300 mm

137 / 108 cm

18V
Li-Ion



$L_{pa} = 85,0 \pm 3,0$ dB; $L_{wa} = 93,0 \pm 3,0$ dB; $a_p = 2,5 \pm 1,5$ m/s²

YATO	[V d.c.]	Battery capacity / Pojemność akumulatora [mAh]	⚡ [h]	Battery quantity / Liczba akumulatorów w zestawie	
YT-82830	18	2000	1	1	2
YT-82831	18	-	-	brak	2

EN Cordless grass trimmer
 PL Akumulatorowa podkaszarka do trawy
 DE Akku-Rasentrimmer
 RU Аккумуляторный триммер
 CZ Akumulátorová strunová sekačka
 HU Akkus szegélynyíró
 RO Trimmer de gazon fără acumulator
 FR Débroussaillouse sans-fil
 IT Tagliabordi a batteria
 ES Desbrozadora a batería
 CN 充电式打草机

18V
Li-Ion

9000 min⁻¹

240 mm

1.6 mm / 3 m

440 / 170 mm

CUTTING LINE ZYLKA TNACA

PLASTIC BLADE / PLASTIKOWE OSTRZE

x20



Battery not included
 Ohne Akku / Bez akumulatora
 Bez baterie / Bez aku
 Akumulator năkălă
 Fără baterie / Sans batterie
 Senza batteria / Sin baterie
 没有电池

$L_{pa} = 81,0 \pm 3,0$ dB; $L_{wa} = 88,0 \pm 2,12$ dB; $a_p = \leq 2,5$ m/s²

YATO	[V d.c.]	
YT-85015	18	4

EN Nylon blades
 PL Nożyki nylonowe
 DE Nylonmesser Set
 RU Сменные ножи для триммера
 CZ Náhradní nože pro vyvířače
 HU Nylon kések
 RO Lame din nailon pt. trimmer
 FR Lames en nylon
 IT Piedi di nylon
 ES Cuchillas de nylon
 CN 尼龙打草刀片

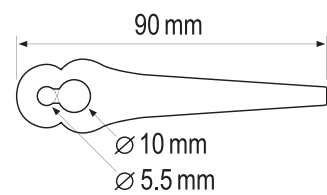

20 PCS

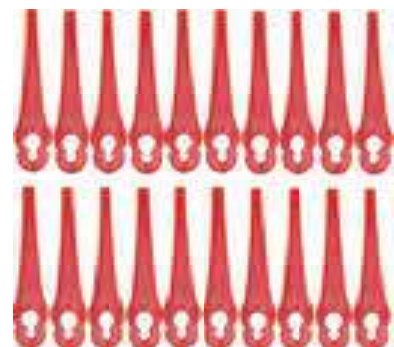

For YT-85015
 Dla YT-85015

YATO		
YT-85016	250	

EN Cordless brush cutter
PL Kosa akumulatorowa
DE Akku-Motorsense
RU Аккумуляторная коса
CZ Akumulátorový křovinořez
HU Akkus fűkasza
RO Motocoasă fără acumulator
FR Débroussaillouse sans-fil
IT Decespugliatore a batteria
ES Desbrozadora a batería
CN 充电式打草机



Battery not included
Olive Akku / Bez akumulatora
Bez Gamapeu / Bez aku
Akumulator nélkül
Fără baterie / Sans batterie
Senza batteria / Sin batería
沒有電池

18V
Li-Ion

$L_{pa} = 79,1 \pm 3,0 / 83,0 \pm 3,0$ dB; $L_{wa} = 88,4 \pm 2,31 / 92,5 \pm 1,92$ dB; $a_s = 1,35 \pm 1,5 / 1,11 \pm 1,5$ m/s²

YATO	[V d.c.]	
YT-85010	36 (18 x2)	1

EN Cordless grass and shrub shears
PL Akumulatorowe nożyce do trawy i krzewów
DE Akku-Gras- und Strauchschere
RU Аккумуляторные ножницы для травы и кустов
CZ Akumulátorové nůžky na trávu a keře
HU Akkumulátoros fű- és bokornyíró
RO Foarfecă pt. iarbă și gard viu cu acumulator
FR Cisaie à gazon et taille-buissons sans-fil
IT Cesoia per erba e arbusti a batteria
ES Tijeras a batería para hierba y arbustos
CN 修枝剪草机

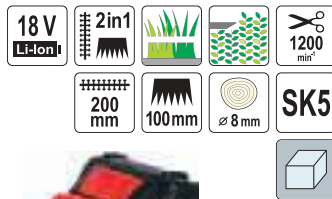

18V
Li-Ion

YATO	[V d.c.]	Battery capacity / Pojemność akumulatora [mAh]	⌚⚡ [h]	Battery quantity / Liczba akumulatorów w zestawie
YT-828355	18	2000	1	1
YT-828356	18	-	-	brak

EN Cordless pruning shears
PL Akumulatorowy sekatör
DE Akku-Astscherer
RU Секатор аккумуляторный
CZ Akumulátorové zahradní nůžky
HU Akkumulátoros metszőolló
RO Foarfecă pomi cu acumulator
FR Sécateur électrique sans-fil
IT Cesoia da potatura a batteria
ES Tijeras de poda eléctricas a batería
CN 充电式无刷园林剪



18V
Li-Ion

$L_{pa} = 67,0 \pm 3,0$ dB; $L_{wa} = 78,0 \pm 3,0$ dB; $a_s = 1,5 \pm 1,5$ m/s²

YATO	[V d.c.]	Battery capacity / Pojemność akumulatora [mAh]	⌚⚡ [h]	Battery quantity / Liczba akumulatorów w zestawie
YT-828377	18	2000	1	1
YT-828378	18	-	-	brak

EN Cutting blade for pruning shears
PL Ostrze tnące do sekatora
DE Ersatzklinge für Gartenschere
RU Лезвие сменное для секатора
CZ Nůž do zahradních nůžek
HU Metszőollóhoz tartalék penge
RO Lama rezerva pt. foarfeca crengi
FR Lame de rechange pour sécateurs
IT Lama di ricambio per cesoie
ES Hoja de recambio para podadera
CN 园林剪刀片



For YT-828377, YT-828378
Dla YT-828377, YT-828378

YATO	
YT-828375	300

EN Cordless hedge trimmer
PL Akumulatorowe nożyce do żywoplotu
DE Akku-Heckenschere
RU Аккумуляторный кусторез
CZ Akumulátorové nůžky na živý plot
HU Akkus sövényvágó
RO Foarfecă de tăiat gard viu cu acumulator
FR Taille-haie sans-fil
IT Tagliasiepi a batteria
ES Cortasetos inalámbrico
CN 锂电绿篱机



18V
Li-Ion

$L_{pa} = 84,4 \pm 3,0$ dB; $L_{wa} = 92,0 \pm 3,0$ dB; $a_s = 2,27 \pm 1,5$ m/s²

YATO	[V d.c.]	Battery capacity / Pojemność akumulatora [mAh]	⌚⚡ [h]	Battery quantity / Liczba akumulatorów w zestawie
YT-828331	18	2000	1	1
YT-828332	18	-	-	brak

EN Cordless hedge trimmer
 PL Akumulatorowe nożyce do żywoplotu
 DE Akku-Heckenschere
 RU Аккумуляторный кусторез
 CZ Akumulatorové nůžky na živý plot
 HU Akkus sövényvágó
 RO Foarfecă de tăiat gard viu cu acumulator
 FR Taille-haie sans-fil
 IT Tagliasiepi a batteria
 ES Cortasetos inalámbrico
 CN 锂电绿篱机

18V Li-Ion
 1550 min²
 550 mm
 ø 16 mm
 ROTATING HANDLE OBROTOWY UCHWYT
 SOFT GRIP MIEKKI UCHWYT



$L_{pa} = 84,4 \pm 3,0$ dB; $L_{wa} = 92,0 \pm 3,0$ dB; $a_h = 2,27 \pm 1,5$ m/s²

YATO	[V d.c.]	Battery capacity / Pojemność akumulatora [mAh]	Battery quantity / Liczba akumulatorów w zestawie
YT-828333	18	2000	1
YT-828334	18	-	brak

EN Cordless hedge trimmer
 PL Akumulatorowe nożyce do żywoplotu
 DE Akku-Heckenschere
 RU Аккумуляторный кусторез
 CZ Akumulatorové nůžky na živý plot
 HU Akkus sövényvágó
 RO Foarfecă de tăiat gard viu fără acumulator
 FR Taille-haie sans-fil
 IT Tagliasiepi a batteria
 ES Cortasetos inalámbrico
 CN 锂电绿篱机

36V 2x 18V Li-Ion
 1550 min²
 550 mm
 ø 28 mm
 BRUSHLESS MOTOR ŚLANKI BEZ SZCZOTKOWY
 ROTATING HANDLE OBROTOWY UCHWYT



$L_{pa} = 82,7 \pm 3,0$ dB; $L_{wa} = 90,5 \pm 2,02$ dB; $a_h = 4,08 \pm 1,5 / 3,09 \pm 1,5$ m/s²

YATO	[V d.c.]
YT-828353	36 (18 x2)

Battery not included
 Ohne Akku / Bez akumulatora
 Bez ładowarki / Bez aku
 Akumulator rēkūt
 Fără baterie / Sans batterie
 Senza batteria / Sin bateria
 没有电池

EN Cordless hedge trimmer
 PL Akumulatorowe nożyce do żywoplotu
 DE Akku-Heckenschere
 RU Аккумуляторный кусторез
 CZ Akumulatorové nůžky na živý plot
 HU Akkus sövényvágó
 RO Foarfecă de tăiat gard viu cu acumulator
 FR Taille-haie sans-fil
 IT Tagliasiepi a batteria
 ES Cortasetos inalámbrico
 CN 锂电绿篱机

18V Li-Ion
 1050 min²
 560mm 22"
 SOFT GRIP MIEKKI UCHWYT



$L_{pa} = 80,0 \pm 3,0$ dB; $L_{wa} = 87,0 \pm 3,0$ dB; $a_h = 3,5 \pm 1,5$ m/s²

YATO	[V d.c.]	Battery capacity / Pojemność akumulatora [mAh]	Battery quantity / Liczba akumulatorów w zestawie
YT-82832	18	2000	1
YT-82833	18	-	brak

EN Electric hedge trimmer
 PL Elektryczne nożyce do żywoplotu
 DE Elektrische Heckenschere
 RU Электрический кусторез
 CZ Elektrické nůžky na živý plot
 HU Elektromos sövényvágó
 RO Foarfecă electrică pt. gard viu
 FR Taille-haie électrique
 IT Tagliasiepi elettrico
 ES Cortasetos eléctrico
 CN 篱笆剪

230-240V~50Hz
 600 W
 1700 min²
 510 mm
 ø 16 mm
 SOFT GRIP MIEKKI UCHWYT



$L_{pa} = 91,0 \pm 3,0$ dB(A); $L_{wa} = 98,9 \pm 3,0$ dB(A); $a_h = 3,344 \pm 1,5 / 4,308 \pm 1,5$ m/s²

YATO	[W]
YT-84770	600

EN Cordless hedge trimmer
 PL Akumulatorowe nożyce do żywoplotu
 DE Akku-Teleskop-Heckenschere
 RU Аккумуляторный телескопический кусторез
 CZ Akumulatorové teleskopické nůžky na živý plot
 HU Akkus magassági sövényvágó
 RO Foarfecă gard viu telescopică cu acumulator
 FR Taille-haie télescopique sans-fil
 IT Tagliasiepi telescopico a batteria
 ES Tijera cortasetos telescópicas a batería
 CN 锂电绿篱机

18V Li-Ion
 2100 min²
 420 mm
 274 / 207 cm
 EASY TRANSPORT ŁATWY TRANSPORT



$L_{pa} = 77,3 \pm 3,0$ dB; $L_{wa} = 88,1 \pm 3,0$ dB; $a_h = 1,5 \pm 1,5$ m/s²

YATO	[V d.c.]	Battery capacity / Pojemność akumulatora [mAh]	Battery quantity / Liczba akumulatorów w zestawie
YT-82834	18	2000	1
YT-82835	18	-	brak

EN Pole hedge trimmer
 PL Nożyce do żywoplotu na wysięgniku
 DE Teleskop-Heckenschere
 RU Телескопический кусторез
 CZ Teleskopické nůžky na živý plot
 HU Magassági sövényvágó
 RO Foarfecă de tăiat gard viu telescopica
 FR Taille-haie télescopique
 IT Tagliasiepi telescopico
 ES Tijera cortasetos telescópicas
 CN 高枝绿篱机

230-240V~50Hz
 600 W
 1500 min²
 510 mm
 ø 20 mm
 274 / 207 cm

65Mn
 HEAD ANGLE ADJUSTMENT REGULACJA KĄTA GŁOWICY
 TELESCOPIC HANDLE UCHWYT TELESKOPOWY
 SOFT GRIP MIEKKI UCHWYT



$L_{pa} = 84,7 \pm 3,0$; $L_{wa} = 96,0 \pm 3,0$; $a_h = 2,74 \pm 1,5 / 2,84 \pm 1,5$ m/s²

YATO	[W]
YT-84790	600

EN Cordless mini chainsaw
PL Akumulatorowa minipilarka łańcuchowa
DE Mini Akku-Kettensäge
RU Аккумуляторная цепная мини пила
CZ Akumulatorová mini řetězová pila
HU Akkus mini láncfűrész
RO Mini drujbă cu acumulator
FR Mini-tronçonneuse sans-fil
IT Mini motosega a batteria
ES Mini motosierra inalámbrica
CN 充电式无刷单手锯



18V
Li-Ion

$L_{pa} = 78,0 \pm 3,0$ dB; $L_{wa} = 89,0 \pm 3,0$ dB; $a_n = 3,425 \pm 1,5$ m/s²

YATO [V d.c.]	Battery capacity / Pojemność akumulatora [mAh]	Battery quantity / Liczba akumulatorów w zestawie
YT-828135	18 2000	1 4
YT-828136	18 -	- brak 4

EN Cordless chainsaw
PL Akumulatorowa pilarka łańcuchowa
DE Akku-Kettensäge
RU Аккумуляторная цепная пила
CZ Akumulatorová řetězová pila
HU Akkus láncfűrész
RO Drujbă cu acumulator
FR Tronçonneuse sans-fil
IT Motosega a batteria
ES Inalámbrico motosierra
CN 锂电电链锯套装



18V
Li-Ion

$L_{pa} = 97,0 \pm 3,0$ dB; $L_{wa} = 102,0 \pm 2,66$ dB; $a_n = 5,407 \pm 1,5 / 4,137 \pm 1,5$ m/s²

YATO [V d.c.]	Battery capacity / Pojemność akumulatora [mAh]	Battery quantity / Liczba akumulatorów w zestawie
YT-828137	18 4000	2 1
YT-828138	18 -	- brak 2

EN Brushless cordless chainsaw
PL Bezszczotkowa pilarka łańcuchowa akumulatorowa
DE Bürstenlose Akku-Kettensäge
RU Бесщеточная аккумуляторная цепная пила
CZ Akumulatorová bezkartáčová řetězová pila
HU Szénkefe nélküli akkus láncfűrész
RO Drujbă cu acumulator, fără peni
FR Tronçonneuse sans-fil sans charbon
IT Motosega a batteria senza spazzole
ES Motosierra a batería sin escobillas
CN 锂电链锯

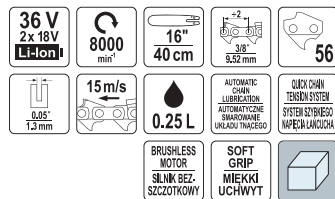

18V
Li-Ion

$L_{pa} = 95,5 \pm 3,0$ dB(A); $L_{wa} = 102,4 \pm 2,54$ dB(A); $a_n = 3,25 \pm 1,5 / 5,19 \pm 1,5$ m/s²

YATO [V d.c.]	Battery capacity / Pojemność akumulatora [mAh]	Battery quantity / Liczba akumulatorów w zestawie
YT-828131	36 (18 x2) 4000	2 2 2
YT-828132	36 (18 x2) -	- brak 2

EN Cordless mini chainsaw
PL Akumulatorowa minipilarka łańcuchowa
DE Mini Akku-Kettensäge
RU Аккумуляторная цепная мини пила
CZ Akumulatorová mini řetězová pila
HU Akkus mini láncfűrész
RO Mini drujbă cu acumulator
FR Mini-tronçonneuse sans-fil
IT Mini motosega a batteria
ES Mini motosierra inalámbrica
CN 充电式无刷单手锯

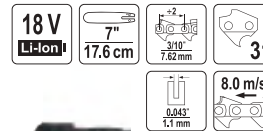

18V
Li-Ion

$L_{pa} = 78,0 \pm 3,0$ dB; $L_{wa} = 95,0 \pm 3,0$ dB; $a_n = 1,4 \pm 0,5$ m/s²

YATO [V d.c.]	Battery capacity / Pojemność akumulatora [mAh]	Battery quantity / Liczba akumulatorów w zestawie
YT-828133	18 2000	1 4
YT-828134	18 -	- brak 4

EN Cordless chainsaw
PL Akumulatorowa pilarka łańcuchowa
DE Akku-Kettensäge
RU Аккумуляторная цепная пила
CZ Akumulatorová řetězová pila
HU Akkus láncfűrész
RO Drujbă cu acumulator
FR Tronçonneuse sans-fil
IT Motosega a batteria
ES Inalámbrico motosierra
CN 锂电电链锯套装

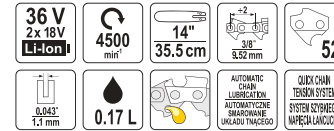

18V
Li-Ion

$L_{pa} = 81,9 \pm 3,0$ dB; $L_{wa} = 92,8 \pm 2,6$ dB; $a_n = 2,57 \pm 1,5 / 4,92 \pm 1,5$ m/s²

YATO [V d.c.]	Battery capacity / Pojemność akumulatora [mAh]	Battery quantity / Liczba akumulatorów w zestawie
YT-82812	36 (18 x2) 2000	1 2 2
YT-82813	36 (18 x2) -	- brak 2

EN Cordless lawn mower
PL Kosiarka akumulatorowa
DE Akku-Rasenmäher
RU Аккумуляторная газонокосилка
CZ Akumulatorová sekačka
HU Akumulatoros fűnyíró
RO Mașină de tuns iarba cu acumulator
FR Tondeuse sans-fil
IT Rasaerba a batteria
ES Cortacésped de batería
CN 锂电草坪机套装



18V
Li-Ion

$L_{pa} = 77,9 \pm 3,0$ dB; $L_{wa} = 90,2 \pm 1,85$ dB; $a_n = 0,5 \pm 1,5$ m/s²

YATO [V d.c.]	Battery capacity / Pojemność akumulatora [mAh]	Battery quantity / Liczba akumulatorów w zestawie
YT-85220	36 (18 x2) 2000	1 2 1
YT-85221	36 (18 x2) -	- brak 1

EN Cordless lawn mower
 PL Kosiarka akumulatorowa
 DE Akku-Rasenmäher
 RU Аккумуляторная газонокосилка
 CZ Akumulátorová sekačka
 HU Akkumulátoros fűnyíró
 RO Mașină de tuns iarba cu acumulator
 FR Tondeuse sans-fil
 IT Rasaerba a batteria
 ES Cortacésped de batería
 CN 锂电草坪机套装



36 V
2x 18V
Li-Ion

2900
min⁻¹

75
↑
25
↓
mm

370
mm

35 L

AUTO & ECO
MODE
TRIM EKO &
AUTOMATYCZNY

BRUSHLESS
MOTOR
SIŁNIK BEZ
SZCZOTKOWY

FOLDABLE
HANDLE
SKŁADANY
UCHWYT

SOFT
GRIP
MIĘKKI
UCHWYT

18V
Li-Ion

$L_{pA} = 76,1 \pm 3,0$ dB(A); $L_{wA} = 89,2 \pm 2,31$ dB(A); $a_n = 0,54 \pm 1,5 / 0,68 \pm 1,5$ m/s²

YATO	[V d.c.]	Battery capacity / Pojemność akumulatora [mAh]	⚡ [h]	Battery quantity / Liczba akumulatorów w zestawie
YT-85222	36 (18 x2)	4000	2	2
YT-85223	36 (18 x2)	-	-	brak

EN Cordless tiller
 PL Glebogryzarka akumulatorowa
 DE Akku-Bodenhacke
 RU Аккумуляторный культиватор
 CZ Akumulátorový kultivátor
 HU Akkumulátoros kapálógép
 RO Motosapă fără acumulator
 FR Motobineuse sans-fil
 IT Motozappa a batteria
 ES Motozadora de batería
 CN 松土机



18 V
Li-Ion

270
min⁻¹

160
mm

155
mm

18V
Li-Ion

Battery not included
 Ohne Akku / Bez akumulatora
 Bez baterii / Bez aku
 Akumulátor nélkül
 Fără baterie / Sans batterie
 Senza batteria / Sin batería
 没有电池

$L_{pA} = 81,5 \pm 3,0$ dB; $L_{wA} = 86,4 \pm 0,58$ dB; $a_n = 2,722 \pm 1,5 / 2,138 \pm 1,5$ m/s²

YATO	[V d.c.]	
YT-85271	18	1

EN Electric grass trimmer
 PL Podkaszarka elektryczna
 DE Elektro-Rasentrimmer
 RU Электрический триммер
 CZ Elektrická sekačka
 HU Elektromos fűnyíró
 RO Trimmer electric
 FR Coupe-herbe
 IT Decespugliatore elettrico
 ES Segadora eléctrica
 CN 打草机



230-240V-
50Hz

550
W

10000
min⁻¹

300
mm

1.6 mm
6 m

126
↑
106
↓
cm

2
POSITIONS
POZYCJE

HEAD ANGLE
ADJUSTMENT
REGULACJA
KĄTA GŁOWICY

$L_{pA} = 73,45 \pm 1,52$ dB; $L_{wA} = 93,17 \pm 1,52$ dB; $a_n = 4,556 \pm 1,5 / 4,306 \pm 1,5$ m/s²

YATO	[W]	
YT-85234	550	4

EN Cordless lawn mower
 PL Kosiarka akumulatorowa
 DE Akku-Rasenmäher
 RU Аккумуляторная газонокосилка
 CZ Akumulátorová sekačka
 HU Akkumulátoros fűnyíró
 RO Mașină de tuns iarba cu acumulator
 FR Tondeuse sans-fil
 IT Rasaerba a batteria
 ES Cortacésped de batería
 CN 锂电草坪机套装



36 V
2x 18V
Li-Ion

2900
min⁻¹

75
↑
25
↓
mm

430
mm

50 L

AUTO & ECO
MODE
TRIM EKO &
AUTOMATYCZNY

BRUSHLESS
MOTOR
SIŁNIK BEZ
SZCZOTKOWY

FOLDABLE
HANDLE
SKŁADANY
UCHWYT

SOFT
GRIP
MIĘKKI
UCHWYT

18V
Li-Ion

$L_{pA} = 72,8 \pm 3,0$ dB(A); $L_{wA} = 87,1 \pm 2,95$ dB(A); $a_n = 0,34 \pm 1,5 / 0,37 \pm 1,5$ m/s²

YATO	[V d.c.]	Battery capacity / Pojemność akumulatora [mAh]	⚡ [h]	Battery quantity / Liczba akumulatorów w zestawie
YT-85224	36 (18 x2)	4000	2	2
YT-85225	36 (18 x2)	-	-	brak

EN Electric grass trimmer
 PL Podkaszarka elektryczna
 DE Elektro-Rasentrimmer
 RU Электрический триммер
 CZ Elektrická sekačka
 HU Elektromos fűnyíró
 RO Trimmer electric
 FR Coupe-herbe
 IT Decespugliatore elettrico
 ES Segadora eléctrica
 CN 打草机



230-240V-
50Hz

250
W

12500
min⁻¹

220
mm

1.2 mm
6 m

$L_{pA} = 70,21 \pm 0,88$ dB; $L_{wA} = 90,18 \pm 0,88$ dB; $a_n = 1,853 \pm 1,5 / 2,835 \pm 1,5$ m/s²

YATO	[W]	
YT-85230	250	12

EN Electric chainsaw 2 in 1
 PL Elektryczna piła łańcuchowa 2 w 1
 DE 2 in 1 elektrische Kettensäge
 RU Электрическая цепная пила 2 в 1
 CZ Elektrická řetězová pila 2 v 1
 HU 2 az 1-ben elektromos láncfűrész
 RO Fierăstrău electric cu lanț 2 în 1
 FR Tronçonneuse électrique 2 en 1
 IT Motosega elettrica 2 in 1
 ES 2 en 1 sierra de cadena eléctrica
 CN 2合1电链锯



• Chainsaw
 • Pole chainsaw
 • Pila łańcuchowa
 • Okrzesywarka

2in1
2w1

230-240V-
50Hz

750
W

10"
25 cm

12 m/s

170
↑
110
↓
cm

40

0,043
1,1 mm

QUICK CHAIN
TENSION SYSTEM
SYSTEM SZYBIEGO
NAPĘCZANIA ŁAŃCUSZA

AUTOMATIC
CHAIN
LUBRICATION
AUTOMATYCZNE
SMAROWANIE
ŁAŃCUSZA

SOFT
GRIP
MIĘKKI
UCHWYT

$L_{pA} = 89,5 \pm 3,0$ dB; $L_{wA} = 102,7 \pm 2,47$ dB; $a_n = 2,67 \pm 1,5 / 3,32 \pm 1,5$ m/s²

YATO	[W]	
YT-84877	750	1

EN Electric chainsaw
PL Elektryczna pilarka łańcuchowa
DE Elektrische Kettensäge
RU Электрическая цепная пила
CZ Elektrická řetězová pila
HU Elektromos láncfűrészt
RO Fierăstrău electric cu lanț
FR Tronçonneuse électrique
IT Motosega elettrica
ES Sierra de cadena eléctrica
CN 电链锯

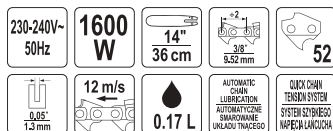

$L_{PA} = 96,0 \pm 3,0$ dB; $L_{WA} = 104,3 \pm 2,64$ dB; $a_n = 5,15 \pm 1,5 / 5,08 \pm 1,5$ m/s²

YATO	[W]	
YT-84868	1600	2

EN Electric chainsaw
PL Elektryczna pilarka łańcuchowa
DE Elektrische Kettensäge
RU Электрическая цепная пила
CZ Elektrická řetězová pila
HU Elektromos láncfűrészt
RO Fierăstrău electric cu lanț
FR Tronçonneuse électrique
IT Motosega elettrica
ES Sierra de cadena eléctrica
CN 电链锯

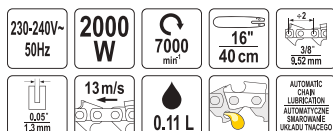

$L_{PA} = 90,2 \pm 3,0$ dB; $L_{WA} = 103,2 \pm 3,0$ dB; $a_n = 8,393 \pm 1,5 / 6,002 \pm 1,5$ m/s²

YATO	[W]	
YT-84870	2000	2

EN Electric lawn mower
PL Kosiarka elektryczna
DE Elektro-Rasenmäher
RU Электрическая газонокосилка
CZ Elektrická sekačka
HU Elektromos fűnyíró
RO Mașină electrică pt. tuns iarba
FR Tondeuse électrique
IT Rasaerba elettrico
ES Cortacésped eléctrico
CN 电动草坪机



$L_{PA} = 82,3 \pm 3,0$ dB; $L_{WA} = 93,1 \pm 1,91$ dB; $a_n = 2,72 \pm 1,5$ m/s²

YATO	[W]	
YT-85200	1300	1

EN Electric chainsaw
PL Elektryczna pilarka łańcuchowa
DE Elektrische Kettensäge
RU Электрическая цепная пила
CZ Elektrická řetězová pila
HU Elektromos láncfűrészt
RO Fierăstrău electric cu lanț
FR Tronçonneuse électrique
IT Motosega elettrica
ES Sierra de cadena eléctrica
CN 电链锯

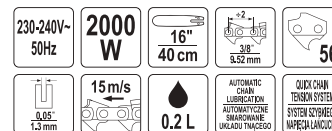

$L_{PA} = 96,9 \pm 3,0$ dB; $L_{WA} = 104,9 \pm 2,36$ dB; $a_n = 6,36 \pm 1,5 / 5,65 \pm 1,5$ m/s²

YATO	[W]	
YT-84871	2000	2

EN Electric chainsaw
PL Elektryczna pilarka łańcuchowa
DE Elektrische Kettensäge
RU Электрическая цепная пила
CZ Elektrická řetězová pila
HU Elektromos láncfűrészt
RO Fierăstrău electric cu lanț
FR Tronçonneuse électrique
IT Motosega elettrica
ES Sierra de cadena eléctrica
CN 电链锯

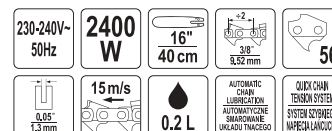

$L_{PA} = 96,5 \pm 3,0$ dB; $L_{WA} = 104,5 \pm 2,36$ dB; $a_n = 6,55 \pm 1,5 / 6,02 \pm 1,5$ m/s²

YATO	[W]	
YT-84872	2400	2

EN Electric lawn mower
PL Kosiarka elektryczna
DE Elektro-Rasenmäher
RU Электрическая газонокосилка
CZ Elektrická sekačka
HU Elektromos fűnyíró
RO Mașină electrică pt. tuns iarba
FR Tondeuse électrique
IT Rasaerba elettrico
ES Cortacésped eléctrico
CN 电动草坪机



$L_{PA} = 82,8 \pm 3,0$ dB; $L_{WA} = 93,7 \pm 2,4$ dB; $a_n = 3,15 \pm 1,5$ m/s²

YATO	[W]	
YT-85205	1800	1

EN Electric lawn mower
 PL Kosiarka elektryczna
 DE Elektro-Rasenmäher
 RU Электрическая газонокосилка
 CZ Elektrická sekačka
 HU Elektromos fűnyíró
 RO Mașină electrică pt. tuns iarba
 FR Tondeuse électrique
 IT Rasaerba elettrico
 ES Cortacésped eléctrico
 CN 电动草坪机



230V-50/60Hz	2000 W
3300 min ⁻¹	430 mm
60 70 40 50 20 30 mm	50 L
160 mm 240 mm	

$L_{pa} = 83,6 \pm 3,0$ dB; $L_{wa} = 94,6 \pm 1,8$ dB; $a_n = 3,45 \pm 1,5$ m/s²

YATO	[W]	
YT-85208	2000	1

EN Electric tiller
 PL Glebogryzarka elektryczna
 DE Elektro-Bodenhacke
 RU Электрический культиватор
 CZ Elektrický kultivátor
 HU Elektromos kapálógép
 RO Motosapă electrică
 FR Motobineuse électrique
 IT Motozappa elettrico
 ES Motoazada eléctrica
 CN 松土机



230-240V-50Hz	1500 W
220 mm	450 mm
205 mm	

$L_{pa} = 80,4 \pm 3,0$ dB; $L_{wa} = 91,57 \pm 1,28$ dB;
 $a_n = 0,968 \pm 1,5 / 0,947 \pm 1,5$ m/s²

YATO	[W]	
YT-84850	1500	1

EN Electric scarifier
 PL Wertykulator elektryczny
 DE Elektrischer Vertikutierer
 RU Электрический скарификатор
 CZ Elektrický vertikutátor
 HU Elektromos gyepszellőztető
 RO Scarificator electric
 FR Scarificateur électrique
 IT Scarificatore elettrico
 ES Escarificador eléctrico
 CN 电动松土机



230-240V-50Hz	1800 W
3500 min ⁻¹	max 12mm
380 mm	45 L
INTERCHANGEABLE ROLLERS INCREASE INCH	
x16	x24

$L_{pa} = 90,2 \pm 3,0$ dB; $L_{wa} = 105,17 \pm 3,0$ dB;
 $a_n = 1,679 \pm 1,5$ m/s²

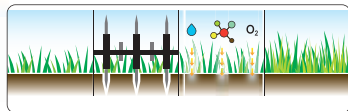

YATO	[W]	
YT-84840	1800	1

EN Electric weed sweeper
 PL Elektryczna szczotka do chwastów
 DE Elektrische Unkrautbürste
 RU Электрическая щетка для сорняков
 CZ Elektrický kartáč k odstraňování plevelu
 HU Elektromos gyomeltávolító kefe
 RO Perie electrică pt. buruieni
 FR Brosse de désherbage électrique
 IT Spazzola elettrica per erbacce
 ES Cepillo eléctrico para malas hierbas
 CN 电动杂草清洁器



230-240V-50Hz	400 W
1800 min ⁻¹	110 mm
SOFT GRIP MIEKKI UCHWYT	TELESCOPIC HANDLE UCHWYT TELESKOPOWY
ADJUSTABLE ADDITIONAL HANDLE REGULOWANY UCHWYT DODATKOWY	

$L_{pa} = 83,0 \pm 3,0$ dB; $L_{wa} = 91,0 \pm 3,0$ dB; $a_n = 2,2 \pm 1,5$ m/s²

YATO	[W]	
YT-85800	400	6

EN Electric multi-brush
 PL Szczotka elektryczna
 DE Elektrische Bürste
 RU Электрическая щетка
 CZ Elektrický kartáč
 HU Elektromos kefe
 RO Perie electrică
 FR Brosse rotative électrique
 IT Spazzola elettrica
 ES Cepillo eléctrico
 CN 电动多功能刷



230-240V-50Hz	500 W
750-1300 min ⁻¹	100 mm
SOFT GRIP MIEKKI UCHWYT	TELESCOPIC HANDLE UCHWYT TELESKOPOWY
ADJUSTABLE ADDITIONAL HANDLE REGULOWANY UCHWYT DODATKOWY	

$L_{pa} = 83,7 \pm 3,0$ dB; $L_{wa} = 94,7 \pm 3,0$ dB; $a_n = 3,39 \pm 1,5$ m/s²

YATO	[W]	
YT-85803	500	2

EN Leaf vacuum / blower
 PL Odkurzacz / dmuchawa do liści
 DE Laubsauger / Laubbläser
 RU Воздуходувка-пылесос
 CZ Vysavač / fukar na listí
 HU Lombszívó / lombfúvó
 RO Sulfantă / aspirator
 FR Aspirateur / souffleur de feuilles
 IT Aspiratore / soffiatore per foglie
 ES Aspirador / soplador de hojas
 CN 电动吹吸机



3 in 1	230-240V-50Hz
3 w 1	3000 W
11500-15500 min ⁻¹	100-300 km/h
10-16 m ³ /min	45 L
15:1	

$L_{pa} = 90,8 \pm 3,0$ dB; $L_{wa} = 102,3 \pm 2,1$ dB; $a_n = 2,702 \pm 1,5$ m/s²

YATO	[W]	
YT-85182	3000	1

EN Leaf vacuum / blower
PL Odkurzacz / dmuchawa do liści
DE Laubsauger / Laubbläser
RU Водуходука-пылесос
CZ Vysavač / fukar na listí
HU Lombszívó / lombfúvó
RO Sufiantă / aspirator
FR Aspirateur / souffleur de feuilles
IT Aspiratore / soffiatore per foglie
ES Aspirador / soplador de hojas
CN 电动吹吸机

- Vacuuming
- Blowing
- Shredding
- Odkurzanie
- Dmuchanie
- Rozdrabnianie



3 in 1
3 w 1
220-240V~
50Hz
3500 W
9000-15000 min⁻¹
13.2 m³/min
270 km/h
35 L

$L_{pA} = 90,2 \pm 3,0$ dB; $L_{wA} = 102,4 \pm 3,0$ dB; $a_n = 4,27 \pm 1,5$ m/s²

YATO	[W]	
YT-85180	3500	1

EN Gasoline backpack sprayer
PL Opryskiwacz plecakowy spalinowy
DE Benzin Motorsprüher
RU Опрыскиватель бензиновый
CZ Motorový rosič
HU Benzines permetező
RO Pulverizatoare pe benzina
FR Pulvérisateur a essence
IT Pompa irroratrice a spalla a motore
ES Pulverizador de gasolina
CN 汽油喷雾器

2.13 kW
2.9 KM
41.5 cm³
20 L
17 m³/min
12 m



$L_{pA} = 99,0 \pm 3,0$ dB; $L_{wA} = 111,0 \pm 3,0$ dB; $a_n = 0,8 \pm 1,5 / 0,9 \pm 1,5$ m/s²

YATO	[kW]	[KM]	
YT-86240	2.13	2.9	1

EN Soil drill bit
PL Wierćto glebowe
DE Erdbohrer
RU Шнек для бензобура
CZ Půdní vrták
HU Talajfúró szár
RO Burghiu pt. pamant
FR Foret pour tarière
IT Punta per trivella
ES Broca ahoyadora
CN 地钻钻头



YATO	Ø [mm]	L [mm]	
YT-84670	100	785	1
YT-84671	150	785	1
YT-84672	200	785	1

EN Blade for lawn mower
PL Nóż do kosiarki
DE Ersatzmesser für Rasenmäher
RU Нож для косилки
CZ Nůž do sekačky
HU Fűnyíró kés
RO Lamă pt. mașină tuns iarba
FR Lame de tondeuse
IT Lama per rasaerba
ES Cuchillas para cortacésped
CN 割草机刀片

5.5 mm
9.5 mm

320 mm
For YT-85200
Dla YT-85200



YATO	L [mm]	
YT-85160	320	80

380 mm
For YT-85205
Dla YT-85205



YATO	L [mm]	
YT-85161	380	50

430 mm
For YT-85208
Dla YT-85208



YATO	L [mm]	
YT-85162	430	50

EN Gasoline earth auger
PL Wiertnica spalinowa
DE Benzin Erdlochbohrer
RU Бензобур
CZ Zemní vrtací stroj benzínový
HU Benzines talajfúró
RO Motoburghiu de pamant
FR Tarière à moteur
IT Mototrivella a scoppio
ES Ahoyadora
CN 地钻

- Tool-free drill exchange
- Balanced and easy to operate
- Beznarzędziowa wymiana wiertel
- Dobrze wyważona i łatwa w obsłudze



1.4 kW

51.2 cm³

320 min⁻¹ (max.)

40 : 1

ANTI-VIBRATION SYSTEM ANTY-WIBRACYJNY

50 cm

100 mm

150 mm

200 mm

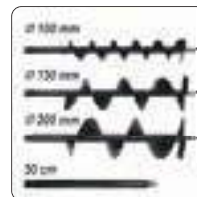

$L_{pA} = 103,8 \pm 3,00$ dB; $L_{wA} = 107,54 \pm 3,00$ dB; $a_n = 12,469 \pm 1,5$ m/s²

YATO	[kW]	[KM]	
YT-84660	1.4	1.9	1

EN Soil drill bit extension
PL Przedłużka do wiertła glebowego
DE Verlängerung für Erdbohrer
RU Удлинитель шнека для бензобура
CZ Nástavec pro půdní vrták
HU Talajfúró szár hosszabbító
RO Extensie burghiu pt. pamant
FR Extension pour foret de sol
IT Prolunga per trivella per terreno
ES Extensión de broca ahoyadora
CN 接杆





500 mm





YATO	L [mm]	
YT-84675	500	20

EN Gasoline chainsaw
 PL Pilarka spalinowa
 DE Benzin-Kettensäge
 RU Бензопила
 CZ Benzinová motorová pila
 HU Benzín láncfűrész
 RO Drujbă pe benzină
 FR Tronçonneuse à essence
 IT Motosega a benzina
 ES Motosierra de gasolina
 CN 油锯







0.75 kW	1.0 KM	25.4 cm ³	8500 min ⁻¹	12" 30 cm	
 45	 0.05" 1.3 mm	AUTOMATIC OIL-LUBRICATION AUTOMATISCHE SMAROLANIE UKŁADÓ TŁACZĄCY		 0.2 L	 40 : 1

$L_{PA} = 95,4 \pm 3,0$ dB; $L_{WA} = 108,4 \pm 3,0$ dB; $a_h = 7,199 \pm 1,5 / 7,492 \pm 1,5$ m/s²

YATO 	[kW]	[KM]	L [mm]	
YT-84893	0.75	1	300	2

EN Gasoline chainsaw
 PL Pilarka spalinowa
 DE Benzin-Kettensäge
 RU Бензопила
 CZ Benzinová motorová pila
 HU Benzín láncfűrész
 RO Drujbă pe benzină
 FR Tronçonneuse à essence
 IT Motosega a benzina
 ES Motosierra de gasolina
 CN 油锯







1.3 kW	1.7 KM	37.2 cm ³	8000 min ⁻¹	14" 36 cm	
 0.05" 1.3 mm		ANTIVIBRATION SYSTEM SYSTEM ANTI-VIBRACYJNY		 0.17 L	 40 : 1

$L_{PA} = 93,35 \pm 1,08$ dB; $L_{WA} = 112,33 \pm 1,08$ dB; $a_h = 5,600 \pm 1,5 / 4,884 \pm 1,5$ m/s²

YATO 	[kW]	[KM]	L [mm]	
YT-84895	1.3	1.7	330	1

EN Gasoline chainsaw
 PL Pilarka spalinowa
 DE Benzin-Kettensäge
 RU Бензопила
 CZ Benzinová motorová pila
 HU Benzín láncfűrész
 RO Drujbă pe benzină
 FR Tronçonneuse à essence
 IT Motosega a benzina
 ES Motosierra de gasolina
 CN 油锯







1.8 kW	2.4 KM	45.1 cm ³	8500 min ⁻¹	16" 40 cm	
 0.05" 1.3 mm		ANTIVIBRATION SYSTEM SYSTEM ANTI-VIBRACYJNY		 0.24 L	 40 : 1

$L_{PA} = 89,69 \pm 1,37$ dB; $L_{WA} = 109,19 \pm 1,37$ dB; $a_h = 5,650 \pm 1,5 / 6,027 \pm 1,5$ m/s²

YATO 	[kW]	[KM]	L [mm]	
YT-84901	1.8	2.4	360	1

EN Gasoline chainsaw
 PL Pilarka spalinowa
 DE Benzin-Kettensäge
 RU Бензопила
 CZ Benzinová motorová pila
 HU Benzín láncfűrész
 RO Drujbă pe benzină
 FR Tronçonneuse à essence
 IT Motosega a benzina
 ES Motosierra de gasolina
 CN 油锯





2.5 kW	3.4 KM	56.5 cm ³	8500 min ⁻¹	20" 50 cm	
 0.05" 1.3 mm		ANTIVIBRATION SYSTEM SYSTEM ANTI-VIBRACYJNY		 0.24 L	 40 : 1

$L_{PA} = 94,59 \pm 1,34$ dB; $L_{WA} = 113,46 \pm 1,34$ dB; $a_h = 7,234 \pm 1,5 / 9,528 \pm 1,5$ m/s²

YATO 	[kW]	[KM]	L [mm]	
YT-84910	2.5	3.4	480	1



EN Gasoline brushcutter
 PL Kosa spalinowa
 DE Benzin-Motorsense
 RU Бензиновый триммер
 CZ Benzinový křovinořez
 HU Benzines fűkasza
 RO Motocoasă pe benzină
 FR Débroussaileuse à essence
 IT Decespuigliatore a benzina
 ES Desbrozadora de gasolina
 CN 汽油割灌机



1.25 kW	1.7 KM	42.7 cm ³	430 mm	255x25.4 mm
 0.85 L	 40 : 1	ANTIVIBRATION SYSTEM SYSTEM ANTI-VIBRACYJNY		EASY START LĄTWEY ROZRUCH



$L_{PA} = 96,3 \pm 3,0$ dB; $L_{WA} = 110,3 \pm 3,0$ dB; $a_h = 3,992 \pm 1,5 / 10,403 \pm 1,5$ m/s²

YATO 	[kW]	[KM]	
YT-85003	1.25	1.7	1

EN Gasoline lawn mower
PL Kosiarka spalinowa
DE Benzin-Rasenmäher
RU Бензиновая газонокосилка
CZ Benzinová sekačka
HU Benzines fűnyíró
RO Mașină de tuns iarbă pe benzină
FR Tondeuse à essence
IT Rasaerba a benzina
ES Cortacésped de gasolina
CN 汽油草坪机

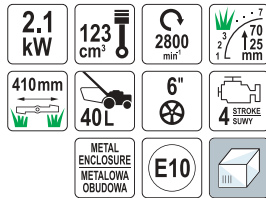

LONCIN

$L_{pA} = 82,2 \pm 3,0$ dB; $L_{wA} = 93,78 \pm 1,61$ dB; $a_n = 4,832 \pm 1,5$ m/s²

YATO	[kW]	[KM]	
YT-85520	2.1	2.86	1

EN Gasoline lawn mower
PL Kosiarka spalinowa
DE Benzin-Rasenmäher
RU Бензиновая газонокосилка
CZ Benzinová sekačka
HU Benzines fűnyíró
RO Mașină de tuns iarbă pe benzină
FR Tondeuse à essence
IT Rasaerba a benzina
ES Cortacésped de gasolina
CN 汽油草坪机

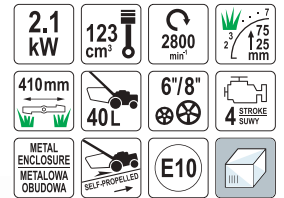

LONCIN

$L_{pA} = 82,2 \pm 3,0$ dB; $L_{wA} = 93,78 \pm 1,61$ dB; $a_n = 4,832 \pm 1,5$ m/s²

YATO	[kW]	[KM]	
YT-85521	2.1	2.86	1

EN Gasoline lawn mower
PL Kosiarka spalinowa
DE Benzin-Rasenmäher
RU Бензиновая газонокосилка
CZ Benzinová sekačka
HU Benzines fűnyíró
RO Mașină de tuns iarbă pe benzină
FR Tondeuse à essence
IT Rasaerba a benzina
ES Cortacésped de gasolina
CN 汽油草坪机

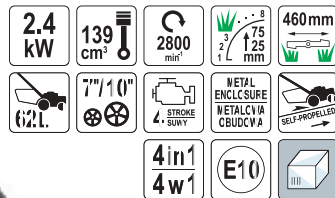

LONCIN

$L_{pA} = 81,0 \pm 3,0$ dB; $L_{wA} = 94,46 \pm 0,93$ dB; $a_n = 7,618 \pm 1,5$ m/s²

YATO	[kW]	[KM]	
YT-85525	2.4	3.26	1

* 4 in 1: rear collection, side discharge, mulching, rear discharge

* 4 w 1: zbiór do kosza, wyrzut boczny, mulczowanie, wyrzut tylny

EN Gasoline lawn mower
PL Kosiarka spalinowa
DE Benzin-Rasenmäher
RU Бензиновая газонокосилка
CZ Benzinová sekačka
HU Benzines fűnyíró
RO Mașină de tuns iarbă pe benzină
FR Tondeuse à essence
IT Rasaerba a benzina
ES Cortacésped de gasolina
CN 汽油草坪机



LONCIN

$L_{pA} = 80,1 \pm 3,0$ dB; $L_{wA} = 94,62 \pm 1,17$ dB; $a_n = 5,177 \pm 1,5$ m/s²

YATO	[kW]	[KM]	
YT-85528	3.5	4.76	1

* 4 in 1: rear collection, side discharge, mulching, rear discharge

* 4 w 1: zbiór do kosza, wyrzut boczny, mulczowanie, wyrzut tylny

EN Gasoline lawn mower
PL Kosiarka spalinowa
DE Benzin-Rasenmäher
RU Бензиновая газонокосилка
CZ Benzinová sekačka
HU Benzines fűnyíró
RO Mașină de tuns iarbă pe benzină
FR Tondeuse à essence
IT Rasaerba a benzina
ES Cortacésped de gasolina
CN 汽油草坪机

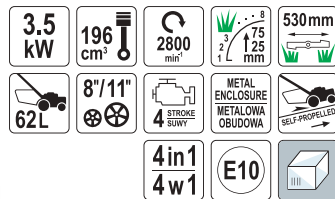

LONCIN

$L_{pA} = 83,0 \pm 3,0$ dB; $L_{wA} = 95,35 \pm 1,69$ dB; $a_n = 4,067 \pm 1,5$ m/s²

YATO	[kW]	[KM]	
YT-85532	3.5	4.76	1

* 4 in 1: rear collection, side discharge, mulching, rear discharge

* 4 w 1: zbiór do kosza, wyrzut boczny, mulczowanie, wyrzut tylny

EN Gasoline lawn mower
PL Kosiarka spalinowa
DE Benzin-Rasenmäher
RU Бензиновая газонокосилка
CZ Benzinová sekačka
HU Benzines fűnyíró
RO Mașină de tuns iarbă pe benzină
FR Tondeuse à essence
IT Rasaerba a benzina
ES Cortacésped de gasolina
CN 汽油草坪机



LONCIN

$L_{pA} = 90,5 \pm 2,5$ dB; $L_{wA} = 95,5 \pm 2,5$ dB; $a_n = 4,6 \pm 1,5$ m/s²

YATO	[kW]	[KM]	
YT-85533	4.5	6.12	1

* 4 in 1: rear collection, side discharge, mulching, rear discharge

* 4 w 1: zbiór do kosza, wyrzut boczny, mulczowanie, wyrzut tylny

EN Gasoline lawn mower
 PL Kosiarka spalinowa
 DE Benzin-Rasenmäher
 RU Бензиновая газонокосилка
 CZ Benzinová sekačka
 HU Benzines fűnyíró
 RO Mașină de tuns iarbă pe benzină
 FR Tondeuse à essence
 IT Rasaerba a benzina
 ES Cortacésped de gasolina
 CN 汽油草坪机

- 4 in 1: rear collection, side discharge, mulching, rear discharge
- 4 w 1: zbiór do kosza, wyrzut boczny, mulczowanie, wyrzut tylny

4.5 kW	224 cm ³	2800 min ⁻¹	560 mm
62L	8"/11"	METAL ENCLOSURE METALOWA OBUDOWA	SELF-PROPELLED
4 in 1	4 w 1	E10	



LONCIN

L_{pa} = 84,5 ± 3,0 dB; L_{wk} = 95,7 ± 2,46 dB; a_n = 6,61 ± 1,5 m/s²

YATO	[kW]	[KM]	
YT-85537	4.5	6.12	1

EN Tractor - gasoline lawn mower
 PL Traktor - kosiarka spalinowa
 DE Benzin-Rasentraktor
 RU Садовый трактор-газонокосилка
 CZ Traktor - benzinová sekačka
 HU Benzines fűnyíró traktor
 RO Tractor - mașină de tuns iarbă pe benzină
 FR Tracteur - tondeuse à essence
 IT Trattorino - rasaerba a benzina
 ES Tractor - cortacésped de gasolina
 CN 自走式汽油草坪机

- Gearbox type: mechanical
- Gears: 5 forward gears, neutral, reverse gear
- 3 in 1: rear collection, side discharge, mulching
- Typ skrzyni biegów: mechaniczna
- Biegi: 5 biegów do przodu, neutralny, wsteczny
- 3 w 1: zbiór do kosza, wyrzut boczny, mulczowanie

8.8 kW	432 cm ³	3600 min ⁻¹	760 mm	170 L
10"/15"	4 STROKE SUWY	METAL ENCLOSURE METALOWA OBUDOWA	E-START	E10

LONCIN



L_{pa} = 78,8 ± 3,0 dB; L_{wk} = 100,4 ± 2,03 dB; a_n = 4,74 ± 1,5 / 0,64 ± 1,5 m/s²

YATO	[kW]	[KM]	
YT-85550	8.8	11.97	1

EN Gasoline tiller
 PL Glebogryzarka spalinowa
 DE Benzin-Bodenhacke
 RU Бензиновый культиватор
 CZ Motorový kultivátor
 HU Benzines kapálógép
 RO Motosapă pe benzină
 FR Motobineuse à essence
 IT Motozappa a benzina
 ES Motoazada gasolina
 CN 汽油旋耕机

2.9 kW	166 cm ³	3000 min ⁻¹	360/600 mm	6"
4 STROKE SUWY	METAL ENCLOSURE METALOWA OBUDOWA	E10		



LONCIN

L_{pa} = 90,2 ± 2,15 dB; L_{wk} = 93,0 ± 1,5 dB; a_n = 4,1 ± 1,5 / 5,2 ± 1,5 m/s²

YATO	[kW]	[KM]	
YT-85590	2.9	3.94	1

EN Gasoline lawn mower
 PL Kosiarka spalinowa
 DE Benzin-Rasenmäher
 RU Бензиновая газонокосилка
 CZ Benzinová sekačka
 HU Benzines fűnyíró
 RO Mașină de tuns iarbă pe benzină
 FR Tondeuse à essence
 IT Rasaerba a benzina
 ES Cortacésped de gasolina
 CN 汽油草坪机

- 4 in 1: rear collection, side discharge, mulching, rear discharge
- 4 w 1: zbiór do kosza, wyrzut boczny, mulczowanie, wyrzut tylny

3.5 kW	196 cm ³	2800 min ⁻¹	530 mm
62L	7"/10"	METAL ENCLOSURE METALOWA OBUDOWA	SELF-PROPELLED
4 in 1	4 w 1	E10	



LONCIN

L_{pa} = 90,7 ± 3,0 dB; L_{wk} = 95,35 ± 1,69 dB; a_n = 5,165 ± 1,5 m/s²

YATO	[kW]	[KM]	
YT-85545	3.5	4.76	1

EN Gasoline scarifier
 PL Wertykulator spalinowy
 DE Benzin-Vertikutierer
 RU Бензиновый скарификатор
 CZ Benzinový vertikutátor
 HU Benzinmotoros gyepszellőtető
 RO Scarificator pe benzină
 FR Scarificateur à essence
 IT Scarificatore a benzina
 ES Escarificador de gasolina
 CN 汽油松耙机

4.1 kW	196 cm ³	3600 min ⁻¹	380 mm	40 L
7"/8"	4 STROKE SUWY	METAL ENCLOSURE METALOWA OBUDOWA	INTERCHANGEABLE ROLLERS WYWIENE WALKI	2 in 1 2 w 1 E10



LONCIN

L_{pa} = 86,8 ± 3,0 / 89,1 ± 3,0 dB; L_{wk} = 99,63 ± 3,0 / 100,42 ± 3,0 dB; a_n = 5,382 ± 1,5 / 4,926 ± 1,5 m/s²

YATO	[kW]	[KM]	
YT-85570	4.1	5.58	1

EN Gasoline tiller
 PL Glebogryzarka spalinowa
 DE Benzin-Bodenhacke
 RU Бензиновый культиватор
 CZ Motorový kultivátor
 HU Benzines kapálógép
 RO Motosapă pe benzină
 FR Motobineuse à essence
 IT Motozappa a benzina
 ES Motoazada gasolina
 CN 汽油旋耕机

3.6 kW	173 cm ³	600 mm	170 mm	600 mm
x6 BLADES OSTRZA	270 mm	1.5 L	0.6 L	



L_{pa} = 77,9 ± 0,199 dB; L_{wk} = 92,58 ± 0,199 dB; a_n = 3,10 ± 1,5 / 3,02 ± 1,5 m/s²

YATO	[kW]	[KM]	
YT-84860	3.6	4.08	1

EN Gasoline tiller
PL Glebogryzarka spalinowa
DE Benzin-Bodenhacke
RU Бензиновый культиватор
CZ Motorový kultivátor
HU Benzines kapálógép
RO Motosapă pe benzina
FR Motobineuse à essence
IT Motozappa a benzina
ES Motoazada gasolina
CN 汽油旋耕机



4.1 kW

196 cm²

3600 min⁻¹

350/850 mm

4 STROKE SUWY

METAL ENCLOSURE METALOWA OBUDOWA

E10



LONCIN

$L_{pA} = 80,2 \pm 3,0$ dB; $L_{wA} = 95,2 \pm 3,0$ dB; $a_n = 8,95 \pm 1,5$ m/s²

YATO	[kW]	[KM]	
YT-85591	4.1	5.58	1

EN Gasoline sweeper
PL Zamiatarka spalinowa
DE Benzin-Kehrmaschine
RU Подметальная машина бензиновая
CZ Benzinový zametací kartáč
HU Benzinmotoros seprőgép
RO Mașină de măturat pe benzină
FR Balayeuse à essence
IT Spazzatrice a benzina
ES Barredora de gasolina
CN 汽油扫雪机



3.5 kW

196 cm²

1000 mm

2800 min⁻¹

4 STROKE SUWY

METAL ENCLOSURE METALOWA OBUDOWA

E10



- Gearbox: 3 speeds forward, reverse gear
- Option of installing a dust collector or a plow

- Skrzynia biegów: 3 prędkości do przodu, bieg wsteczny
- Możliwość zamontowania zbieracza lub plugu

LONCIN

$L_{pA} = 80,9 \pm 3,0$ dB; $L_{wA} = 94,41 \pm 3,0$ dB; $a_n = 4,646 \pm 1,5$ m/s²

YATO	[kW]	[KM]	
YT-85600	3.5	4.76	1

EN Plow for sweeper
PL Plug do zmiatarki
DE Pflug für Kehrmaschine
RU Отвал для подметальной машины
CZ Radlice pro zametací kartáč
HU Toldólap seprőgéphez
RO Plug pt. mașină de măturat
FR Charrue pour balayeuse
IT Lama da neve per spazzatrice
ES Quitanieves para barredora
CN 雪铲



1000 mm

METAL ENCLOSURE METALOWA OBUDOWA



For YT-85600
Dla YT-85600

YATO	Working width / Szerokość robocza [mm]	
YT-85606	1000	1

EN Gasoline tiller
PL Glebogryzarka spalinowa
DE Benzin-Bodenhacke
RU Бензиновый культиватор
CZ Motorový kultivátor
HU Benzines kapálógép
RO Motosapă pe benzina
FR Motobineuse à essence
IT Motozappa a benzina
ES Motoazada gasolina
CN 汽油旋耕机



4.1 kW

196 cm²

480 mm

4 STROKE SUWY

METAL ENCLOSURE METALOWA OBUDOWA

E10



LONCIN

$L_{pA} = 80,2 \pm 3,0$ dB; $L_{wA} = 95,2 \pm 3,0$ dB; $a_n = 8,95 \pm 1,5$ m/s²

YATO	[kW]	[KM]	
YT-85592	4.1	5.58	1

EN Collector for sweeper
PL Zbieracz do zmiatarki
DE Sammler für Kehrmaschine
RU Контейнер для подметальной машины
CZ Sběrná nádoba pro zametací kartáč
HU Gyűjtődoboz seprőgéphez
RO Colector pt. mașină de măturat
FR Collecteur pour balayeuse
IT Raccogliitore per spazzatrice
ES Caja de recogida para barredora
CN 灰箱



1000 mm

METAL ENCLOSURE METALOWA OBUDOWA



For YT-85600
Dla YT-85600

YATO	Working width / Szerokość robocza [mm]	
YT-85605	1000	1

EN Gasoline shredder
PL Rozdrabniacz spalinowy
DE Benzin-Häcksler
RU Бензиновый измельчитель веток
CZ Benzinový drtič
HU Benzinmotoros ágaprító
RO Tocător pe benzină
FR Broyeur à essence
IT Trituratore a benzina
ES Trituradora de gasolina
CN 汽油碎枝机



3.5 kW

196 cm²

3000 min⁻¹

Ø45mm

30L

4 STROKE SUWY

E10



LONCIN

$L_{pA} = 97,0 \pm 3,0$ dB; $L_{wA} = 107,0 \pm 3,0$ dB

YATO	[kW]	[KM]	
YT-85580	3.5	4.76	1

- EN Blade for lawn mower
 PL Nóż do kosiarńki
 DE Ersatzmesser für Rasenmäher
 RU Нож для косилки
 CZ Nůž do sekačky
 HU Fűnyíró kés
- RO Lamă pt. mașină tuns iarba
 FR Lame de tondeuse
 IT Lama per rasaerba
 ES Cuchillas para cortacésped
 CN 割草机刀片



YATO	L [mm]	For / Dla	
YT-855470	410	YT-85520, YT-85521	40
YT-855471	460	YT-85525	40
YT-855472	510	YT-85528	20
YT-855473	530	YT-85532, YT-85533, YT-85545	20
YT-855474	560	YT-85537	15

- EN Aeration roller
 PL Walek do aeracji
 DE Belüftungswalze
 RU Вал-рыхлитель
 CZ Provdzdušovací válec
 HU Szellőztető henger
- RO Rolă de aerare
 FR Rouleau d'aération
 IT Rullo di aerazione
 ES Rodillo para aireación
 CN 滚轮组件

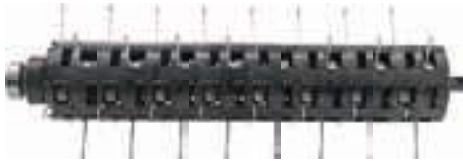

For YT-85570
 Dla YT-85570

YATO	Working width / Szerokość robocza [mm]	
YT-855477	380	8

- EN Wheel for lawn mower and scarifier
 PL Kolo do kosiarńki i wertykulatora
 DE Rasenmäher- und Vertikutierer-Rad
 RU Колесо для газонокосилки и скарификатора
 CZ Kolo pro sekačku a vertikutátor
 HU Fűnyíró és gyepszellőztető kerék
 RO Roată pt. mașină tuns iarba și scarificator
 FR Roue pour tondeuse et scarificateur
 IT Ruota per rasaerba e scarificatore
 ES Rueda para cortacésped y escarificador
 CN 割草机轮



YATO	Ø	For / Dla	
YT-855481	7" (178 mm)	YT-85525, YT-85570	25
YT-855482	8" (200 mm)	YT-85528, YT-85532, YT-85533, YT-85537, YT-85545, YT-85570	25

- EN Spark plug
 PL Świeca zapłonowa
 DE Zündkerze
- RU Свеча зажигания
 CZ Zapalovací svíčka
 HU Gyújtógyertya
- RO Bujie
 FR Bougie d'allumage
 IT Candela di accensione
- ES Bujía de encendido
 CN 火花塞



19 mm
 For YT-85520, YT-85521, YT-85525, YT-85533, YT-85537, YT-85590, YT-85591, YT-85592
 Dla YT-85520, YT-85521, YT-85525, YT-85533, YT-85537, YT-85590, YT-85591, YT-85592

YATO	Thread length / Długość gwintu [mm]	
YT-855487	19	2

- EN Lawn mower air filter
 PL Filtr do kosiarńki
 DE Luftfilter für Rasenmäher
 RU Фильтр воздушный газонокосилки
 CZ Filtr do sekačky na trávu
 HU Fűnyíró szűrő
 RO Filtru de aer pt. mașina de tuns iarba
 FR Filtre à air pour tondeuse
 IT Filtro aria per rasaerba
 ES Filtro para cortacésped
 CN 空气滤芯



For YT-85520, YT-85521, YT-85525
 Dla YT-85520, YT-85521, YT-85525

YATO	
YT-855490	500

- EN Scarifier roller
 PL Walek do wertykulacji
 DE Vertikutierwalze
 RU Вал-скарификатор
 CZ Vertikulační válec
 HU Talajazító henger
- RO Rolă scarificatoare
 FR Rouleau scarificateur
 IT Rullo scarificatore
 ES Rodillo para escarificación
 CN 滚轮组件



For YT-85570
 Dla YT-85570

YATO	Working width / Szerokość robocza [mm]	
YT-855478	380	8

- EN Lawn mower wheel
 PL Kolo do kosiarńki
 DE Rasenmäherrad
 RU Колесо для газонокосилки
 CZ Kolo sekačky na trávu
 HU Fűnyíró kerék
 RO Roată pt. mașină tuns iarba
 FR Roue pour tondeuse
 IT Ruota per rasaerba
 ES Rueda para cortacésped
 CN 割草机轮



For YT-85520, YT-85521
 Dla YT-85520, YT-85521

YATO	Diameter / Średnica	
YT-855480	6" (155 mm)	50

- EN Lawn mower wheel
 PL Kolo do kosiarńki
 DE Rasenmäherrad
 RU Колесо для газонокосилки
 CZ Kolo sekačky na trávu
 HU Fűnyíró kerék
 RO Roată pt. mașină tuns iarba
 FR Roue pour tondeuse
 IT Ruota per rasaerba
 ES Rueda para cortacésped
 CN 割草机轮



YATO	Ø	For / Dla	
YT-855483	10" (247 mm)	YT-85525	10
YT-855484	11" (275 mm)	YT-85528, YT-85532, YT-85533, YT-85537, YT-85545	10

12.7 mm
 For YT-85528, YT-85532, YT-85545, YT-85580, YT-85600
 Dla YT-85528, YT-85532, YT-85545, YT-85580, YT-85600

YATO	Thread length / Długość gwintu [mm]	
YT-855488	12.7	2

- EN Replacement air filter
 PL Zapasowy filtr powietrza
 DE Ersatz-Luftfilter
 RU Запасной воздушный фильтр
 CZ Náhradní vzduchový filtr
 HU Tartalék légszűrő
 RO Filtru de aer de schimb
 FR Filtre à air de rechange
 IT Filtro aria di ricambio
 ES Filtro de aire de repuesto
 CN 空气滤芯



For YT-85528, YT-85532, YT-85545, YT-85580, YT-85600
 Dla YT-85528, YT-85532, YT-85545, YT-85580, YT-85600

YATO	
YT-855491	300

EN Air filter for tiller
PL Filtr do glebogryzarki
DE Luftfilter für Bodenhacke
RU Воздушный фильтр на двигатель мотоблока
CZ Filtr pro kultivátor
HU Benzines kapálógép szűrő
RO Filtru de aer pt. motosapă
FR Filtre à air pour motobineuse
IT Filtro aria per motozappa
ES Filtro para motoazada
CN 空气滤芯



For YT-85590
Dla YT-85590

YATO
YT-855492 300

EN Lawn mower air filter
PL Filtr do kosiarzki
DE Luftfilter für Rasenmäher
RU Фильтр воздушный газонокосилки
CZ Filtr do sekačky na trávu
HU Fűnyíró szűrő
RO Filtru de aer pt. mașina de tuns iarba
FR Filtre à air pour tondeuse
IT Filtro aria per rasaerba
ES Filtro para cortacésped
CN 空气滤芯



For YT-85533, YT-85537
Dla YT-85533, YT-85537

YATO
YT-855493 150

EN Air filter for tiller
PL Filtr do glebogryzarki
DE Luftfilter für Bodenhacke
RU Воздушный фильтр на двигатель мотоблока
CZ Filtr pro kultivátor
HU Benzines kapálógép szűrő
RO Filtru de aer pt. motosapă
FR Filtre à air pour motobineuse
IT Filtro aria per motozappa
ES Filtro para motoazada
CN 空气滤芯



For YT-85591, YT-85592
Dla YT-85591, YT-85592

YATO
YT-855494 150

EN Trimmer head
PL Glowica żyłkowa
DE Trimmerkopf
RU Головка с леской
CZ Strunová hlava
HU Damil fej
RO Cap trimmer
FR Tête de coupe
IT Testina di taglio a filo
ES Cabezal de hilo
CN 铝制打草头

2.2-3.0 mm 200-430 mm 30 ≤ cm² AI



For YT-85001, YT-85003, YT-85010
Dla YT-85001, YT-85003, YT-85010

YATO
YT-85111 10/40

EN Trimmer head
PL Glowica żyłkowa
DE Trimmerkopf
RU Головка с леской
CZ Strunová hlava
HU Damil fej
RO Cap trimmer
FR Tête de coupe
IT Testina di taglio a filo
ES Cabezal de hilo
CN 铝制打草头

2.2-3.0 mm M12x1.75L X4 ADAPTER 30 ≤ cm²



For YT-85001, YT-85003, YT-85010
Dla YT-85001, YT-85003, YT-85010

YATO
YT-85121 10/40

EN Trimmer head
PL Glowica żyłkowa
DE Trimmerkopf
RU Головка с леской
CZ Strunová hlava
HU Damil fej
RO Cap trimmer
FR Tête de coupe
IT Testina di taglio a filo
ES Cabezal de hilo
CN 铝制打草头

2.0-3.0 mm 300-430 mm 30 ≤ cm²



For YT-85001, YT-85003, YT-85010
Dla YT-85001, YT-85003, YT-85010

YATO
YT-85135 25/100

EN TCT blade for brushcutters
PL Tarcza tnąca do kosi spalinowej
DE Sägeblatt für Motorsensen
RU Режущий диск для косы
CZ Pílový kotouč do křovinořezy
HU Fűkasza vágókorong
RO Disc pt. motocoasa
FR Lame disque pour débroussaillageuse
IT Disco da taglio per decespugliatore
ES Disco de corte para desbrozadora
CN 多孔割草片

255x25.4 mm 30 ≤ cm² 40T



For YT-85001, YT-85003, YT-85010
Dla YT-85001, YT-85003, YT-85010

YATO
YT-85150 20/40

EN 3-tooth brushcutter blade
PL Tarcza tnąca trójzębna
DE 3-Zahn Dickichtmesser
RU Нож трехлопастной
CZ Zací nůž 3-zubý
HU 3 fogú vágókés
RO Lamă pt. motocoasă cu 3 dinți
FR Lame 3 dents pour débroussaillageuse
IT Disco per decespugliatore a 3 denti
ES Cuchilla de 3 puntas para desbrozadora
CN 三齿割草片

255x25.4 x1.6 mm 30 ≤ cm²



For YT-85001, YT-85003, YT-85010
Dla YT-85001, YT-85003, YT-85010

YATO
YT-85155 25/50

EN Brushcutter wire brush
PL Szczotka druciana do kosi
DE Drahtbürste für Motorsense
RU Щетка для мотокосы
CZ Drátěný kartáč na křovinořez
HU Drótkefetárcsa fűkaszához
RO Perie circulară cu toroane pt. motocoasă
FR Brosse métallique pour débroussaillageuse
IT Spazzola metallica per decespugliatore
ES Cepillo de alambre para desbrozadora
CN 除草盘

STEEL WIRE DRUT STALOWY



YATO	Ø [mm]	Ød [mm]	max. c [min.°]	
YT-85141	150	25.4	10000	30
YT-85142	200	25.4	10000	20

EN Guide bar
 PL Prowadnica
 DE Führungsschiene
 RU Шина для пил
 CZ Vodicí lišta na řetězové pile
 HU Lánvezető

RO Lamă de ghidaj
 FR Guide de tronçonneuse
 IT Barra per motosega
 ES Barra guía
 CN 导板

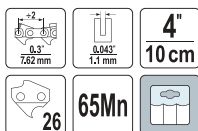

For YT-828135, YT-828136
 Dla YT-828135, YT-828136

YATO	L	Links quantity / Liczba ogniw	For chainsaws / Do pilarek	
YT-84914	4" (100 mm)	26	YT-828135, YT-828136	250

EN Chainsaw guide bar
 PL Prowadnica do pilarek
 DE Führungsschiene für Kettensägen
 RU Шина для бензопил
 CZ Vodicí lišta k řetězové pile
 HU Lánvezető

RO Lamă pt. drijbă
 FR Guide de tronçonneuse
 IT Barra per motosega
 ES Barra guía motosierra
 CN 导板

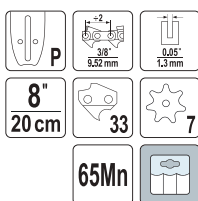

For YT-849479
 Dla YT-849479

YATO	Mounting type / Rodzaj mocowania	L	Links quantity / Liczba ogniw	For chains / Do łańcuchów	
YT-84923	P	8" (200 mm)	33	YT-849479	20

EN Chainsaw guide bar
 PL Prowadnica do pilarek
 DE Führungsschiene für Kettensägen
 RU Шина для бензопил
 CZ Vodicí lišta k řetězové pile
 HU Lánvezető

RO Lamă pt. drijbă
 FR Guide de tronçonneuse
 IT Barra per motosega
 ES Barra guía motosierra
 CN 导板

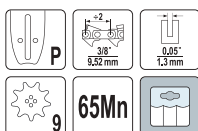

YATO	Mounting type / Rodzaj mocowania	L	Links quantity / Liczba ogniw	For chains / Do łańcuchów	For chainsaws / Do pilarek	
YT-84925	P	10" (250 mm)	40	YT-84948, YT-84960	-	20
YT-84927	P	12" (300 mm)	44	YT-84949, YT-849495, YT-84960	YT-85090, YT-828137, YT-828138	20
YT-84931	P	14" (360 mm)	52	YT-84951, YT-84960	YT-84985, 79675	20
YT-84935	P	16" (400 mm)	56	YT-84953, YT-84960	YT-84870	20
YT-849355	P	18" (450 mm)	62	YT-84956, YT-84960	-	20

EN Chainsaw guide bar
 PL Prowadnica do pilarek
 DE Führungsschiene für Kettensägen
 RU Шина для бензопил
 CZ Vodicí lišta k řetězové pile
 HU Lánvezető

RO Lamă pt. drijbă
 FR Guide de tronçonneuse
 IT Barra per motosega
 ES Barra guía motosierra
 CN 导板

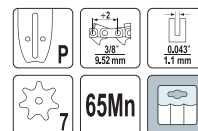

YATO	Mounting type / Rodzaj mocowania	L	Links quantity / Liczba ogniw	For chains / Do łańcuchów	For chainsaws / Do pilarek	
YT-84915	P	8" (200 mm)	33	YT-849470	-	20
YT-84916	P	10" (250 mm)	40	YT-849472	-	20
YT-84917	P	12" (300 mm)	45	YT-849474	-	20
YT-84918	P	14" (360 mm)	52	YT-849475	YT-82812, YT-82813	20
YT-84919	P	16" (400 mm)	56	YT-849477	-	20

EN Chainsaw guide bar
 PL Prowadnica do pilarek
 DE Führungsschiene für Kettensägen
 RU Шина для бензопил
 CZ Vodicí lišta k řetězové pile
 HU Lánvezető

RO Lamă pt. drijbă
 FR Guide de tronçonneuse
 IT Barra per motosega
 ES Barra guía motosierra
 CN 导板

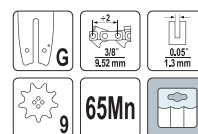

YATO	Mounting type / Rodzaj mocowania	L	Links quantity / Liczba ogniw	For chains / Do łańcuchów	
YT-849299	G	12" (300 mm)	44	YT-84949	20
YT-84930	G	14" (360 mm)	50	YT-84950, YT-84960	20
YT-849301	G	16" (400 mm)	55	YT-849529	20

EN Chainsaw guide bar
 PL Prowadnica do pilarek
 DE Führungsschiene für Kettensägen
 RU Шина для бензопил
 CZ Vodicí lišta k řetězové pile
 HU Lánvezető

RO Lamă pt. drijbă
 FR Guide de tronçonneuse
 IT Barra per motosega
 ES Barra guía motosierra
 CN 导板



YATO	Mounting type / Rodzaj mocowania	L	Links quantity / Liczba ogniw	For chains / Do łańcuchów	
YT-849381	U	12" (300 mm)	45	YT-849495	20
YT-849382	U	14" (360 mm)	52	YT-84951	20
YT-849383	U	16" (400 mm)	56	YT-84953, YT-84954	20

EN Chainsaw guide bar
PL Prowadnica do pilarek
DE Führungsschiene für Kettensägen
RU Шина для бензопил
CZ Vodicí lišta k řetězové pile
HU Lánvezető

RO Lamă pt. drijbă
FR Guide de tronçonneuse
IT Barra per motosega
ES Barra guía motosierra
CN 导板

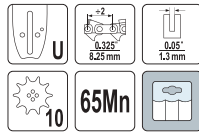

YATO	Mounting type / Rodzaj mocowania	L	Links quantity / Liczba ogniw	For chains / Do łańcuchów	For chainsaws / Do pilarek	
YT-849329	U	13" (330 mm)	56	YT-849449	-	20
YT-849333	U	20" (500 mm)	78	YT-849453	YT-84905	20

EN Chainsaw guide bar
PL Prowadnica do pilarek
DE Führungsschiene für Kettensägen
RU Шина для бензопил
CZ Vodicí lišta k řetězové pile
HU Lánvezető

RO Lamă pt. drijbă
FR Guide de tronçonneuse
IT Barra per motosega
ES Barra guía motosierra
CN 导板

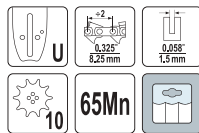

YATO	Mounting type / Rodzaj mocowania	L	Links quantity / Liczba ogniw	For chains / Do łańcuchów	
YT-84929	U	13" (330 mm)	56	YT-84940	20
YT-84938	U	20" (500 mm)	78	YT-84944	20

EN Chainsaw guide bar
PL Prowadnica do pilarek
DE Führungsschiene für Kettensägen
RU Шина для бензопил
CZ Vodicí lišta k řetězové pile
HU Lánvezető

RO Lamă pt. drijbă
FR Guide de tronçonneuse
IT Barra per motosega
ES Barra guía motosierra
CN 导板

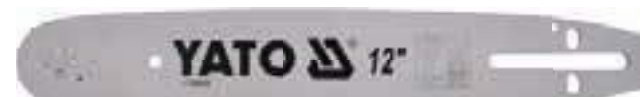
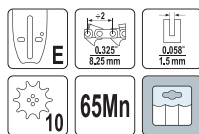

YATO	Mounting type / Rodzaj mocowania	L	Links quantity / Liczba ogniw	For chains / Do łańcuchów	
YT-84928	E	12" (300 mm)	50	YT-849395, YT-84963	20
YT-849311	E	14" (360 mm)	60	YT-849405, YT-84963	20

EN Chainsaw guide bar
PL Prowadnica do pilarek
DE Führungsschiene für Kettensägen
RU Шина для бензопил
CZ Vodicí lišta k řetězové pile
HU Lánvezető

RO Lamă pt. drijbă
FR Guide de tronçonneuse
IT Barra per motosega
ES Barra guía motosierra
CN 导板

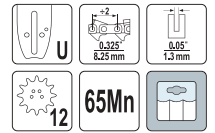

YATO	Mounting type / Rodzaj mocowania	L	Links quantity / Liczba ogniw	For chains / Do łańcuchów	
YT-84933	U	15" (380 mm)	64	YT-84945, YT-84962	20
YT-849331	U	16" (400 mm)	66	YT-849451	20
YT-849332	U	18" (450 mm)	72	YT-849452	20

EN Chainsaw guide bar
PL Prowadnica do pilarek
DE Führungsschiene für Kettensägen
RU Шина для бензопил
CZ Vodicí lišta k řetězové pile
HU Lánvezető

RO Lamă pt. drijbă
FR Guide de tronçonneuse
IT Barra per motosega
ES Barra guía motosierra
CN 导板

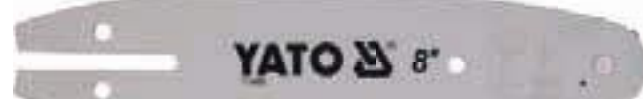
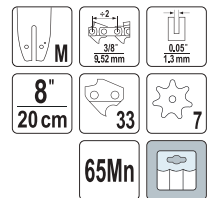

For YT-82836, YT-82837, YT-849479
Dla YT-82836, YT-82837, YT-849479

YATO	L	Links quantity / Liczba ogniw	
YT-84921	8" (200 mm)	33	20

EN Chainsaw guide bar
PL Prowadnica do pilarek
DE Führungsschiene für Kettensägen
RU Шина для бензопил
CZ Vodicí lišta k řetězové pile
HU Lánvezető

RO Lamă pt. drijbă
FR Guide de tronçonneuse
IT Barra per motosega
ES Barra guía motosierra
CN 导板

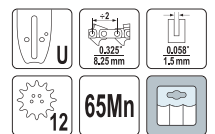

YATO	Mounting type / Rodzaj mocowania	L	Links quantity / Liczba ogniw	For chains / Do łańcuchów	For chainsaws / Do pilarek	
YT-84934	U	15" (380 mm)	64	YT-84941, YT-84963	-	20
YT-849351	U	16" (400 mm)	66	YT-84942, YT-84963	-	20
YT-84936	U	18" (450 mm)	72	YT-84943, YT-84963	YT-84900	20
YT-84937	U	20" (500 mm)	76	YT-84944, YT-84963	YT-84910	20

- EN Chain regulating plate
- PL Płytki regulująca napięcie łańcucha
- DE Einstellplatte für Kettenspannung
- RU Пластина натяжитель цепи
- CZ Destička pro nastavení napnutí řetězu
- HU Lánzfeszesség szabályozó lemez
- RO Placă de reglare a lanțului
- FR Plaque de réglage de la tension de la chaîne
- IT Piastra tendicatena
- ES Placa reguladora del apriete de cadena
- CN 链条张力调节片

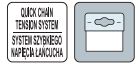

For guide bars A041/P
Do prowadnic A041/P

- EN Chain for chainsaw
- PL Łańcuch tnący do pilarek
- DE Kette für Kettensägen
- RU Цепь для бензопилы
- CZ Řetěz pro řetězové pily
- HU Láncláncfűrész
- RO Lanț pt. drijbă
- FR Chaîne de tronçonneuse
- IT Catena motosega
- ES Cadena de motosierra
- CN 链条



YATO	L	Links quantity / Liczba ogniw	For guide bars / Do prowadnic	For chainsaws / Do pilarek	
YT-849470	8" (200 mm)	33	YT-84915	-	50
YT-849472	10" (250 mm)	40	YT-84916	-	50
YT-849474	12" (300 mm)	45	YT-84917	-	50
YT-849475	14" (360 mm)	52	YT-84918	YT-82812, YT-82813	50
YT-849477	16" (400 mm)	56	YT-84919	-	50

- EN Chain for chainsaw
- PL Łańcuch tnący do pilarek
- DE Kette für Kettensägen
- RU Цепь для бензопилы
- CZ Řetěz pro řetězové pily
- HU Láncláncfűrész
- RO Lanț pt. drijbă
- FR Chaîne de tronçonneuse
- IT Catena motosega
- ES Cadena de motosierra
- CN 链条

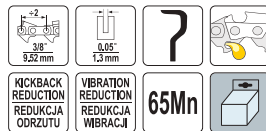

YATO	L	Links quantity / Liczba ogniw	For guide bars / Do prowadnic	For chainsaws / Do pilarek	
YT-849479	8" (200 mm)	33	YT-84921, YT-84923	YT-82836, YT-82837	50
YT-84948	10" (250 mm)	40	YT-84925	-	50
YT-84949	12" (300 mm)	44	YT-849299, YT-84927	-	50
YT-849495	12" (300 mm)	45	YT-849381, YT-849299, YT-84927	YT-84893, YT-828137, YT-828138	50
YT-84950	14" (360 mm)	50	YT-84930	-	50
YT-84951	14" (360 mm)	52	YT-84931, YT-849382	YT-84868, YT-84895, 79675	50
YT-849529	16" (400 mm)	55	YT-849301	-	50
YT-84953	16" (400 mm)	56	YT-84935, YT-849383	YT-84870, YT-84871, YT-84872	50
YT-84954	16" (400 mm)	57	YT-849383	-	50
YT-84956	18" (450 mm)	62	YT-849355	-	50

YATO	L	
YT-84939	200	

- EN Chain for chainsaw
- PL Łańcuch tnący do pilarek
- DE Kette für Kettensägen
- RU Цепь для бензопилы
- CZ Řetěz pro řetězové pily
- HU Láncláncfűrész
- RO Lanț pt. drijbă
- FR Chaîne de tronçonneuse
- IT Catena motosega
- ES Cadena de motosierra
- CN 链条

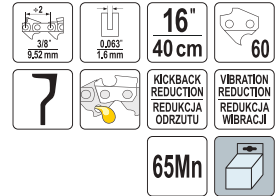

YATO	L	
YT-84955	16" (400 mm)	50

- EN Chain for chainsaw
- PL Łańcuch tnący do pilarek
- DE Kette für Kettensägen
- RU Цепь для бензопилы
- CZ Řetěz pro řetězové pily
- HU Láncláncfűrész
- RO Lanț pt. drijbă
- FR Chaîne de tronçonneuse
- IT Catena motosega
- ES Cadena de motosierra
- CN 链条



YATO	L	Links quantity / Liczba ogniw	For guide bars / Do prowadnic	For chainsaws / Do pilarek	
YT-849449	13" (330 mm)	56	YT-849329	-	50
YT-84945	15" (380 mm)	64	YT-84933	-	50
YT-849451	16" (400 mm)	66	YT-849331	-	50
YT-849452	18" (450 mm)	72	YT-849332	-	50
YT-849453	20" (500 mm)	78	YT-849333	YT-84905	50

- EN Chain for chainsaw
- PL Łańcuch tnący do pilarek
- DE Kette für Kettensägen
- RU Цепь для бензопилы
- CZ Řetěz pro řetězové pily
- HU Láncláncfűrész
- RO Lanț pt. drijbă
- FR Chaîne de tronçonneuse
- IT Catena motosega
- ES Cadena de motosierra
- CN 链条



YATO	L	Links quantity / Liczba ogniw	For guide bars / Do prowadnic	For chainsaws / Do pilarek	
YT-849395	12" (300 mm)	50	YT-84928	-	50
YT-84940	13" (330 mm)	56	YT-84929	-	50
YT-849405	14" (360 mm)	60	YT-849311	-	50
YT-84941	15" (380 mm)	64	YT-84934	-	50
YT-84942	16" (400 mm)	66	YT-849351	-	50
YT-84943	18" (450 mm)	72	YT-84936	YT-84900	50
YT-84944	20" (500 mm)	76	YT-84937	YT-84910	50
YT-849441	20" (500 mm)	78	YT-84938	-	50

EN Chain for chainsaw
PL Łańcuch tnący do pilarek
DE Kette für Kettensägen
RU Цепь для бензопилы
CZ Retěz pro řetězové pily
HU Láncláncfűrész
RO Lanț pt. drujbă
FR Chaîne de tronçonneuse
IT Catena motosega
ES Cadena de motosierra
CN 链条卷



For YT-82812, YT-82813
Dla YT-82812, YT-82813

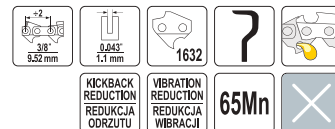

EN Chain for chainsaw
PL Łańcuch tnący do pilarek
DE Kette für Kettensägen
RU Цепь для бензопилы
CZ Retěz pro řetězové pily
HU Láncláncfűrész
RO Lanț pt. drujbă
FR Chaîne de tronçonneuse
IT Catena motosega
ES Cadena de motosierra
CN 链条卷



For YT-84930, YT-84931, YT-84935
Dla YT-84930, YT-84931, YT-84935

Alpina, Dolmar, Husqvarna, McCulloch, Oleo-Mac, Partner

YATO	Links quantity / Liczba ogniw	
YT-84960	1632	1

EN Chain for chainsaw
PL Łańcuch tnący do pilarek
DE Kette für Kettensägen
RU Цепь для бензопилы
CZ Retěz pro řetězové pily
HU Láncláncfűrész
RO Lanț pt. drujbă
FR Chaîne de tronçonneuse
IT Catena motosega
ES Cadena de motosierra
CN 链条卷



For YT-84905, YT-84933
Dla YT-84905, YT-84933

Dolmar, Husqvarna, Jonsered, Makita, Oleo-Mac, Partner

YATO	Links quantity / Liczba ogniw	
YT-84962	1846	1

EN Spare link for chainsaw
PL Zestaw ogniw do łańcucha do pilarek
DE Kettenglieder
RU Набор звеньев для цепи
CZ Spojky řetězu pro řetězové pily
HU Láncfűrész láncszem

RO Nituri lanț drujbă
FR Lien de rechange pour tronçonneuse
IT Set di maglie di catena
ES Repuesto para sierra de cadena
CN 连接片

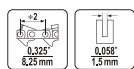

For YT-84940, YT-84941, YT-84942, YT-84943, YT-84944, YT-84963
Dla YT-84940, YT-84941, YT-84942, YT-84943, YT-84944, YT-84963

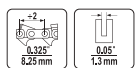

For YT-84945, YT-84962
Dla YT-84945, YT-84962

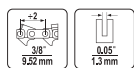

For YT-84950, YT-84951, YT-84953, YT-84954, YT-84960
Dla YT-84950, YT-84951, YT-84953, YT-84954, YT-84960

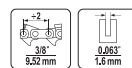

For YT-84955
Dla YT-84955

YATO	
YT-84975	120

YATO	
YT-84976	100

YATO	
YT-84977	120

YATO	
YT-84978	100

EN Chainsaw chain spinner
 PL Nitownica do łańcuchów do pilarek
 DE Sägeketten-Vernietgerät
 RU Станок для клепания цепей
 CZ Nýtovačka pilových řetězů
 HU Szegecselő készülék fűrészláncához

RO Mașină pt. nituit și desfăcut lanț drijbă
 FR Riveteuse d'établi pour chaînes de tronçonneuses
 IT Imbutitore per motoseghe
 ES Remachadora banco cadenas de motosierra
 CN 接链器

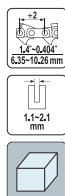

YATO
 YT-84970 4

EN Chain sharpener
 PL Ostrzałka do łańcuchów
 DE Sägekettschärfgerät
 RU Станок для заточки цепей
 CZ Bruska na řetězy
 HU Lánccélező
 RO Mașină de ascuțit lanț drijbă
 FR Affûteuse de chaîne
 IT Affilacatene
 ES Afilador para cadenas
 CN 电动磨链机



$L_{BA} = 63,5 \pm 3,0$ dB; $L_{WA} = 76,5 \pm 3,0$ dB



YATO
 YT-84990 4

EN Chainsaw chain breaker
 PL Rozkuwarka do łańcuchów do pilarek
 DE Sägeketten-Entnietgerät
 RU Станок для расклепки цепей
 CZ Roznýtovačka pilových řetězů
 HU Szegecskinyomó fűrészláncához
 RO Mașina desfăcut lanț drijbă
 FR Dériveteuse pour chaîne de tronçonneuse
 IT Spezzacatena per motoseghe
 ES Rompe cadenas de motosierra
 CN 截链器

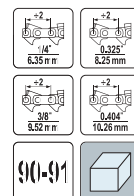

YATO
 YT-84971 4

EN Replacement wheel for chainsaw sharpening tool
 PL Kamień do ostrzałki łańcuchów
 DE Schleifscheibe für Kettenschärfgerät
 RU Камень для заточки цепей
 CZ Kámen do brusky pilových řetězů
 HU Lánccélező kő
 RO Roata schimb pt. aparat ascuțit lanț drijbă
 FR Pierre à aiguiser les chaînes
 IT Mola affilacatene
 ES Sierra para afiladora de cadenas
 CN 磨轮





For YT-84990
 Dla YT-84990

YATO
 YT-84991 100



- EN Flat depth-gauge file
PL Piłnik płaski do szlifowania ograniczników głębokości
DE Flachfeile zum Schleifen von Tiefenschlägen
RU Плоский напильник для шлифования ограничителей глубины
CZ Plochy pilník k broušení hloubkových dorazů
HU Lapos reszelő mélységhatárolók csiszolásához
RO Pila pt. ascuțit lanț drijbă
FR Lime plate pour jauge de profondeur de ponçage
IT Lima piatta per affilatura di fermi di profondità
ES Lima plana para esmerilar topes de profundidad
CN 扁锉



YATO 	L [mm]	
YT-85022	250	200

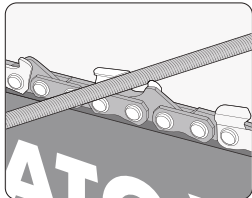

- EN Round chain saw file set
PL Zestaw pilników okrągłych do ostrzenia łańcuchów
DE Rundfeileinsatz zum schärfen von Ketten
RU Набор круглых напильников для заточки цепей
CZ Sada kulatých pilníků k ostření řetězů
HU Kerek reszelőkészlet láncélezéshez
RO Set pile rotunde pt. lanț drijbă
FR Limes rondes pour affûtage de chaînes
IT Kit di lime tonde per affilatura catene
ES Juego de limas redondas para afilar cadenas
CN 链锯锉



YATO 	Ø [mm]	For / Dla	
YT-85025	4.0	3/8"	4/200
YT-85026	4.5	3/8", 0.325"	4/200
YT-85027	4.8	0.325"	4/200

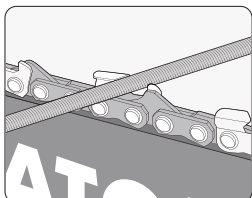

- EN Chain saw file with guide
PL Prowadnik z pilnikiem do ostrzenia łańcuchów
DE Führungsschiene mit Kettenschärffeile
RU Направляющая с напильником для заточки цепей
CZ Vodítko s pilníkem k ostření řetězů
HU Vezető láncélező reszelővel
RO Pila lanț drijbă cu ghidaj
FR Guide avec lime pour affûtage de chaîne
IT Guida con lima tonda per affilatura catene
ES Guía con lima para afilar cadenas
CN 链锯锉3件套

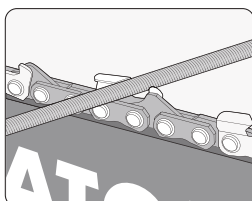

YATO 	Ø [mm]	For / Dla	
YT-85030	4.0	3/8"	4/100
YT-85031	4.5	3/8", 0.325"	4/100
YT-85032	4.8	0.325"	4/100

- EN Chain saw file with guide
PL Prowadnik z pilnikiem do ostrzenia łańcuchów
DE Führungsschiene mit Kettenschärffeile
RU Направляющая с напильником для заточки цепей
CZ Vodítko s pilníkem k ostření řetězů
HU Vezető láncélező reszelővel
RO Pila lanț drijbă cu ghidaj
FR Guide avec lime pour affûtage de chaîne
IT Guida con lima tonda per affilatura catene
ES Guía con lima para afilar cadenas
CN 链锯锉刀塑柄架



YATO 	Ø [mm]	For / Dla	
YT-85035	4.0	3/8"	200
YT-85036	4.5	3/8", 0.325"	200
YT-85037	4.8	0.325"	200

- EN Chain sharpening set
 PL Zestaw do ostrzenia łańcucha
 DE Kettenschärfset
 RU Набор для заточки цепи
- CZ Sada k ostření řetězu
 HU Lánccélező készlet
 RO Set ascuțit lanț drijba
 FR Kit d'affûtage de chaîne
- IT Kit per affilatura catene
 ES Set para afilar cadenas
 CN 鏈鋸鏈刀布袋套裝



4 PCS

25° 30° 35°

BEARING STEEL STAL ŁOŻYSKOWA

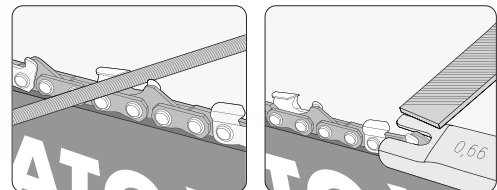
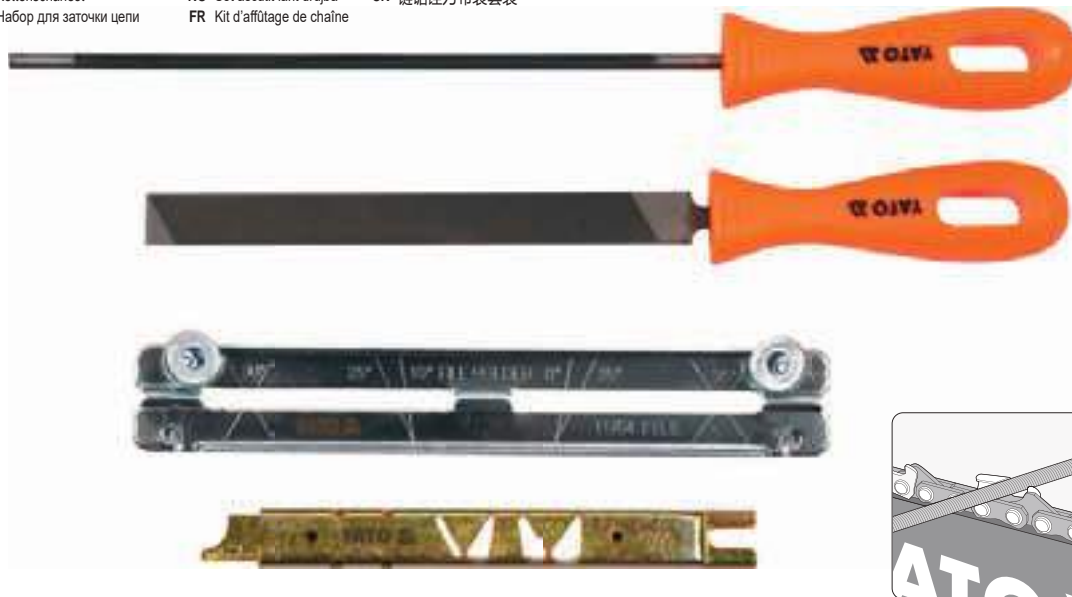
PP

YATO 	Ø [mm]	For / Dla	
YT-85040	4.0	3/8"	50
YT-85041	4.5	3/8", 0.325"	50
YT-85042	4.8	0.325"	50

- EN Guide for depth-gauge
 PL Przymiar do szlifowania ograniczników głębokości
 DE Schleiflehre für Schleifen von Tiefenanschlägen
 RU Измеритель для шлифования ограничителей глубины
 CZ Měřítko k broušení hloubkových dorazů
 HU Csiszolásablom mélységzabályozóhoz
 RO Ghidaj pt. ascuțit dinti lanț drijba
 FR Jauge de profondeur de ponçage
 IT Indicatore per affilatura di fermi di profondità
 ES Medida para esmerilar topes de profundidad
 CN 鏈條打磨深度尺

0.65 mm

10° 30° 35°







YATO 	L [mm]	For / Dla	
YT-85051	150	YT-85022	200

- EN Handle for round chain sharpening file
 PL Rękojeść do pilnika okrągłego
 DE Griff für Rundfeile
- RU Ручка для круглого напильника
 CZ Rukojeť do kulatého pilníku
 HU Markolat kerek reszelőhöz
- RO Maner pt. pila rotunda de ascuțit lanț
 FR Poignée de lime ronde
 IT Impugnatura per lima tonda
- ES Mango de lima redonda
 CN 塑料手柄

PP





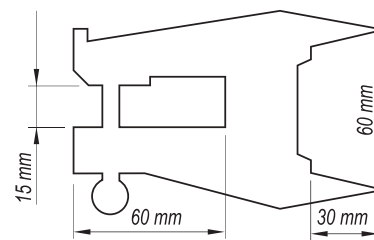

YATO 	Ø [mm]	For / Dla	
YT-85060	4.0	3/8" / YT-85025	500
YT-85061	4.5	3/8", 0.325" / YT-85026	500
YT-85062	4.8	0.325" / YT-85027	500

YATO 	Ø [mm]	For / Dla	
YT-85065	4.0	3/8" / YT-85025	200
YT-85066	4.5	3/8", 0.325" / YT-85026	200
YT-85067	4.8	0.325" / YT-85027	200

- EN Logger filing vice
 PL Imadło do mocowania prowadnicy
 DE Schraubstock zur Befestigung der Führungsschiene
 RU Тиски для крепления направляющей
 CZ Svěrák k uchopení vodící lišty
 HU Vezetőörgztő satu
 RO Presa pt. nituit lanț drijba
 FR Étau pour maintenir le guide
 IT Morsa per fissaggio della guida
 ES Tornillo de banco para fijar la guía
 CN 导板支架



YATO 	
YT-85075	2/60

 **ENERG** Y UA
енергия · енерґія IE IA

YATO YT-99730

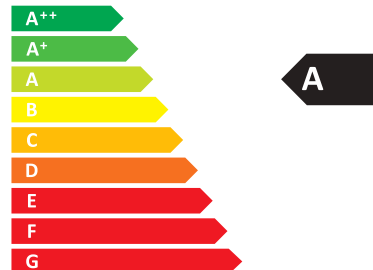

15,0
kW



ENERGIA · ЕНЕРГИЯ · ΕΝΕΡΓΕΙΑ · ENERGIJA · ENERGY · ENERGIE · ENERGI

2015/1186

 **ENERG** Y UA
енергия · енерґія IE IA

YATO YT-99733

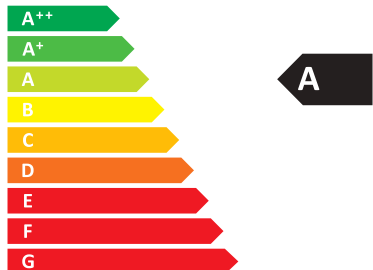

30,0
kW



ENERGIA · ЕНЕРГИЯ · ΕΝΕΡΓΕΙΑ · ENERGIJA · ENERGY · ENERGIE · ENERGI

2015/1186

 **ENERG** Y UA
енергия · енерґія IE IA

YATO YT-99740

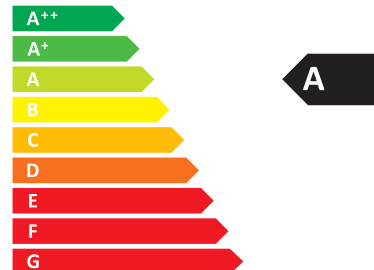

30,0
kW



ENERGIA · ЕНЕРГИЯ · ΕΝΕΡΓΕΙΑ · ENERGIJA · ENERGY · ENERGIE · ENERGI

2015/1186

 **ENERG** Y UA
енергия · енерґія IE IA

YATO YT-99743

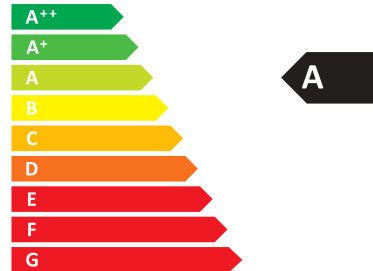

50,0
kW

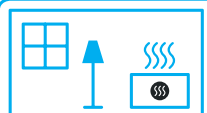

ENERGIA · ЕНЕРГИЯ · ΕΝΕΡΓΕΙΑ · ENERGIJA · ENERGY · ENERGIE · ENERGI

2015/1186

 **ENERG** Y UA
енергия · енерґія IE IA

YATO YT-99738

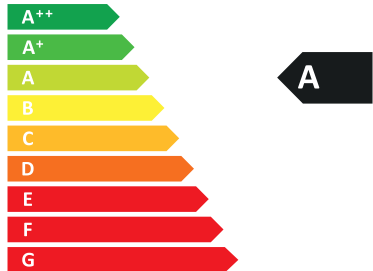

20,0
kW



ENERGIA · ЕНЕРГИЯ · ΕΝΕΡΓΕΙΑ · ENERGIJA · ENERGY · ENERGIE · ENERGI

2015/1186

 **ENERG** Y UA
енергия · енерґія IE IA

YATO YT-99739

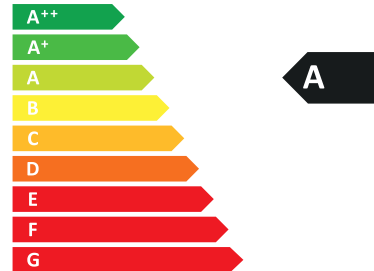

30,0
kW

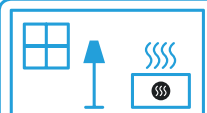

ENERGIA · ЕНЕРГИЯ · ΕΝΕΡΓΕΙΑ · ENERGIJA · ENERGY · ENERGIE · ENERGI

2015/1186

19

Accessories
Akcesoria



Tool belts
Pasy na narzędzia

590-591



Tool boxes
Skrzynki narzędziowe

596-601



Tool pockets
Kieszenie na narzędzia

591-592



Folding hand trucks
Wózki magazynowe

602



Tool bags
Torby narzędziowe

592-593



Floor conveyors
Transport poziomy

603



Hermetic tool boxes
Walizki narzędziowe hermetyczne

594-596



Tool lanyards
Linki do narzędzi

603



EN Tool belt
 PL Pas narzędziowy
 DE Werkzeuggürtel
 RU Инструмент пояса
 CZ Opasek s nářadím
 HU Szerszám öv

RO Centura scule
 FR Ceinture à outils
 IT Cintura porta utensili
 ES Cinturón para herramientas
 CN 工具袋

600D
 POLYESTER
 POLIESTER



- Tool belt
- 4 large pockets
- 2 hammer holders
- 6 small pockets
- Pas narzędziowy
- 4 duże kieszenie
- 2 uchwyty na młotki
- 6 kieszonek

EN Tool belt
 PL Pas narzędziowy
 DE Werkzeuggürtel
 RU Инструмент пояса
 HU Szerszám öv

RO Centura scule
 FR Ceinture à outils
 IT Cintura porta utensili
 ES Cinturón para herramientas
 CN 工具袋

600D
 POLYESTER
 POLIESTER



- Tool belt
- 4 big patch pockets
- Measuring tape holder
- 10 small pockets
- Pas narzędziowy
- 4 duże nakładane kieszenie
- Uchwyt na taśmę mierniczą
- 10 kieszonek

YATO 
 YT-74001 10

YATO 
 YT-74002 10

EN Tooling belt with harness
 PL Pas narzędziowy na szelkach
 DE Werkzeuggurt mit Hosenträger
 RU Инструментальный пояс с ляжками
 CZ Opasek na nářadí
 HU Szerszám öv

RO Curea port scule
 FR Ceinture à outils avec harnais
 IT Cintura portautensili con bretelle
 ES Cinturón para herramientas con arnés
 CN 背带式组合工具袋

600D
 POLYESTER
 POLIESTER

DETACHABLE
 HARNESS
 ODPINNA
 UPRZĄŻ



EN Tooling belt with harness
 PL Pas narzędziowy na szelkach
 DE Werkzeuggurt mit Hosenträger
 RU Инструментальный пояс с ляжками
 HU Szerszám öv

RO Curea port scule
 FR Ceinture à outils avec harnais
 IT Cintura portautensili con bretelle
 ES Cinturón para herramientas con arnés
 CN 背带式组合工具袋

600D
 POLYESTER
 POLIESTER

DETACHABLE
 HARNESS
 ODPINNA
 UPRZĄŻ



- Harness
- Tool bags
- Hammer holder
- Nails pouch
- Szelki (uprząż)
- Sakwy
- Uchwyt na młotek
- Torba na gwoździe

YATO 
 YT-74070 10



- Harness
- Tool bag
- 2 drill holsters
- Hammer holder
- Nails pouch
- Szelki (uprząż)
- Sakwa
- 2 kabury na elektronarzędzia
- Uchwyt na młotek
- Torba na gwoździe

YATO 
 YT-74071 10

EN Heavy duty nail & tool pouch
PL Pas z kieszeniami na gwoździe i narzędzia
DE Werkzeuggürtel mit Nägelund Schraubentaschen
RU Ремень с сумками для гвоздей и инструментов

CZ Pás na nářadí pětikapsový
HU Szeg és szerszámtartó öv
RO Centura port scule
FR Ceinture porte-outils clous

IT Cintura con le tasche per chiodi e utensili
ES Cinturón porta herramientas y accesorios varios
CN 重型工具袋

21
POCKETS
WIESZCIE

130
cm

HEAVY DUTY
NYLON
WZMOCNIONY
NYLON



YATO
YT-7400



10

EN Pouch belt
PL Pas na kieszenie na narzędzia
DE Gürtel für Werkzeugtaschen

RU Пояс для карманов для инструмента
CZ Opasek na monterské kapsáře
HU Öv erszényhez

RO Curea
FR Ceinture porte-outils
IT Cintura con le tasche porta utensili

ES Cinturón para bolsas de herramientas
CN 工具腰帶

90-120
cm

HEAVY DUTY
NYLON
WZMOCNIONY
NYLON



YATO
YT-7409



50/100

EN Nail and tool pouch
PL Kieszeń na gwoździe i narzędzia
DE Gürtelwerkzeugtasche
RU Сумка для инструментов и гвоздей
CZ Kapsář na hřebíky a nářadí
HU Szerszámtartó erszény
RO Buzunar pt. scule si cuie
FR Sac à outils et clous
IT Borsa per chiodi e attrezzi
ES Cartuchera porta herramientas
CN 钉子袋

8
POCKETS
WIESZCIE

HEAVY DUTY
NYLON
WZMOCNIONY
NYLON



EN Drill pouch
PL Kabura na wiertarkę
DE Schrauber-Holster
RU Поясная сумка для дрели
CZ Pouzdro na vrtačku
HU Szerszám pisztolytáska
RO Suport bormășină pt. centura
FR Étui pour perceuse
IT Fondina per trapano
ES Cartuchera porta taladro
CN 电钻通用挂袋

600D
POLYESTER
PCLESTER



YATO
YT-7410



20/40

YATO
YT-74141



60

EN Drill pouch
PL Kabura na wiertarkę
DE Schrauber-Holster
RU Поясная сумка для дрели
CZ Pouzdro na vrtačku
HU Szerszám pisztolytáska
RO Suport bormășină pt. centura
FR Étui pour perceuse
IT Fondina per trapano
ES Cartuchera porta taladro
CN 电钻通用挂袋

HEAVY DUTY
NYLON
WZMOCNIONY
NYLON



EN Drill pouch
PL Kabura na wiertarkę
DE Schrauber-Holster
RU Поясная сумка для дрели
CZ Pouzdro na vrtačku
HU Szerszám pisztolytáska
RO Suport bormășină pt. centura
FR Étui pour perceuse
IT Fondina per trapano
ES Cartuchera porta taladro
CN 电钻通用挂袋

HEAVY DUTY
NYLON
WZMOCNIONY
NYLON



YATO
YT-7413



10/40

YATO
YT-7414



48/96

EN Nail and tool pouch
 PL Kieszeń na gwoździe i narzędzia
 DE Gürtelwerkzeugtasche
 RU Сумка для инструментов и гвоздей
 CZ Kapsář na hřebíky a nářadí
 HU Szerszámtartó erszény
 RO Buzunar pt. scule si cuie
 FR Sac à outils et clous
 IT Borsa per chiodi e attrezzi
 ES Cartuchera porta herramientas
 CN 钉子袋



YATO
 YT-7416 20/40

EN Nail and tool pouch
 PL Kieszeń na gwoździe i narzędzia
 DE Gürtelwerkzeugtasche
 RU Сумка для инструментов и гвоздей
 CZ Kapsář na hřebíky a nářadí
 HU Szerszámtartó erszény
 RO Buzunar pt. scule si cuie
 FR Sac à outils et clous
 IT Borsa per chiodi e attrezzi
 ES Cartuchera porta herramientas
 CN 钉子袋



YATO
 YT-7417 39/156

EN Tool pouch
 PL Sakwa narzędziowa
 DE Werkzeugtasche
 RU Сумка для инструментов
 CZ Kapsa na nářadí
 HU Szerszámtáska
 RO Geanta pt. scule
 FR Pochette à outils
 IT Borsa porta attrezzi
 ES Bolsa para herramientas
 CN 工具包



YATO
 YT-74172 24

EN Nail pocket + hammer loop
 PL Kieszeń z uchwytem na młotek
 DE Hammer und Nägel-Gürteltasche
 RU Карман-держатель для молотка
 CZ Kapsář za opasek na kladivo
 HU Szeg tartó erszény kalapáccstartóval
 RO Suport pt. ciocan
 FR Pochette à outils + porte-marteau
 IT Tasca porta martello
 ES Bolsa con el soporte para martillo
 CN 锤头钉子袋



YATO
 YT-7419 40/80

EN Mobile phone pouch
 PL Kieszeń na telefon komórkowy
 DE Handy-Gürteltasche
 RU Карман для мобильного телефона
 CZ Pouzdro za opasek na mobilní telefon
 HU Mobil telefon tartó
 RO Suport pt. telefon
 FR Pochette à téléphone portable
 IT Tasca porta cellulare
 ES Bolsa de teléfono móvil
 CN 手机袋

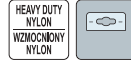

YATO
 YT-7420 27/54

EN Tool bag
 PL Torba narzędziowa
 DE Werkzeugtasche
 RU Сумка для инструментов
 CZ Brašna na nářadí
 HU Szerszámtáska
 RO Geantă pt. scule
 FR Sac à outils
 IT Borsa porta attrezzi
 ES Bolsa para herramientas
 CN 工具包



YATO
 YT-74360 8

EN Tool bag
 PL Torba narzędziowa
 DE Werkzeugtasche
 RU Сумка для инструментов
 CZ Brašna na nářadí
 HU Szerszámtáska
 RO Geantă pt. scule
 FR Sac à outils
 IT Borsa porta attrezzi
 ES Bolsa para herramientas
 CN 工具包



YATO
 YT-74361 6

EN Tool bag
 PL Torba narzędziowa
 DE Werkzeugtasche
 RU Сумка для инструментов
 CZ Brašna na nářadí
 HU Szerszámtáska
 RO Geantă pt. scule
 FR Sac à outils
 IT Borsa porta attrezzi
 ES Bolsa para herramientas
 CN 工具包



YATO
 YT-74351 4

EN Tool bag
PL Torba narzędziowa
DE Werkzeugtasche
RU Сумка для инструментов
CZ Brašna na nářadí
HU Szerszámtáska
RO Geantă pt. scule
FR Sac à outils
IT Borsa porta attrezzi
ES Bolsa para herramientas
CN 工具包

50
POCKETS
KIESZENIE

HEAVY DUTY
NYLON
WZMOCNIONY
NYLON

STEEL
EDGES
STALOWE
KRAWĘDZIE

EASY OPEN
ŁATWE
OTWIERANIE

EASY CLOSE
ŁATWE
ZAMYKANIE



YATO
YT-7430 12

EN Tool bag
PL Torba narzędziowa
DE Werkzeugtasche
RU Сумка для инструментов
CZ Brašna na nářadí
HU Szerszámtáska
RO Geantă pt. scule
FR Sac à outils
IT Borsa porta attrezzi
ES Bolsa para herramientas
CN 工具包

16
POCKETS
KIESZENIE

HEAVY DUTY
NYLON
WZMOCNIONY
NYLON



YATO
YT-7433 12

EN Tool bag
PL Torba narzędziowa
DE Werkzeugtasche
RU Сумка для инструментов
CZ Brašna na nářadí
HU Szerszámtáska
RO Geantă pt. scule
FR Sac à outils
IT Borsa porta attrezzi
ES Bolsa para herramientas
CN 工具包

31x13
x31
cm

600D
POLYESTER
POLYESTER



YATO
YT-74333 30

EN Open tote tool bag
PL Pojemnik narzędziowy
DE Werkzeugtrage
RU Переноска для инструментов
CZ Otevřená taška na nářadí
HU Nyitott szerszámtáska
RO Geantă pt. scule
FR Sac à outils ouvert
IT Borsa porta attrezzi aperta
ES Bolsa de herramientas abierta
CN 工具包



16
POCKETS
KIESZENIE

YATO
YT-74370 6



9
POCKETS
KIESZENIE

YATO
YT-74371 6

600D
POLYESTER
POLYESTER



17
POCKETS
KIESZENIE

YATO
YT-74372 6



11
POCKETS
KIESZENIE

YATO
YT-74373 6

EN Open tote tool bag
PL Pojemnik narzędziowy
DE Werkzeugtrage
RU Переноска для инструментов
CZ Otevřená taška na nářadí
HU Nyitott szerszámtáska
RO Geantă pt. scule
FR Sac à outils ouvert
IT Borsa porta attrezzi aperta
ES Bolsa de herramientas abierta
CN 工具包

31
POCKETS
KIESZENIE

HEAVY DUTY
NYLON
WZMOCNIONY
NYLON



YATO
YT-7435 4

EN Waterproof bag
PL Worek wodoszczelny
DE Wasserdichter Seesack
RU Водонепроницаемая сумка
CZ Vodotěsný vak
HU Vízhatlan táská
RO Geantă impermeabilă
FR Sac étanche
IT Sacca impermeabile
ES Bolsa impermeable
CN 防水包



YATO

YT-74290	10	50
YT-74291	20	40

IPX6

PVC

EN Tool bag with foldable chair
PL Torba narzędziowa z krzesłem
DE Werkzeugtasche mit Klappstuhl
RU Стул складной с сумкой для инструментов
CZ Brašna na nářadí se stoličkou
HU Őszecsukható szék tartózsébbel
RO Scaun rabatabil cu geantă
FR Sac à outils avec tabouret
IT Sedia pieghevole con borsa porta attrezzi
ES Bolsa para herramientas con silla
CN 带包折叠椅

22
POCKETS
KIESZENIE

max **90**
kg

HEAVY DUTY
NYLON
WZMOCNIONY
NYLON



YATO
YT-7446 10

EN Hermetic toolbox
 PL Walizka narzędziowa hermetyczna
 DE Hermetischer Werkzeugkoffer
 RU Герметичный инструментальный чемодан
 CZ Kufř na nářadí hermetický
 HU Hermetikus szerszámosláda
 RO Cutie scule ermetica
 FR Valise à outils étanche
 IT Valigetta portautensili a tenuta stagna
 ES Caja de herramientas hermetica
 CN 安全箱

232x192
x111
mm

DECOMPRESSION
VALVE
ZAWÓR
DEKOMPRESYJNY

SHOCK-
PROOF
ODPORNA
NA WSTRZĄSY

FOAM
INSERT
WKŁAD
GĄBKOWY

IP55

PP



YATO	External dimensions / Wymiary zewnątrzne [mm]	Internal dimensions / Wymiary wewnętrzne [mm]	
YT-08900	232x192x111	208x144x92	12

EN Hermetic toolbox
 PL Walizka narzędziowa hermetyczna
 DE Hermetischer Werkzeugkoffer
 RU Герметичный инструментальный чемодан
 CZ Kufř na nářadí hermetický
 HU Hermetikus szerszámosláda
 RO Cutie scule ermetica
 FR Valise à outils étanche
 IT Valigetta portautensili a tenuta stagna
 ES Caja de herramientas hermetica
 CN 安全箱

339x295
x152
mm

DECOMPRESSION
VALVE
ZAWÓR
DEKOMPRESYJNY

SHOCK-
PROOF
ODPORNA
NA WSTRZĄSY

FOAM
INSERT
WKŁAD
GĄBKOWY

IP55

PP



YATO	External dimensions / Wymiary zewnątrzne [mm]	Internal dimensions / Wymiary wewnętrzne [mm]	
YT-08902	345x295x152	300x225x132	4

EN Hermetic toolbox
 PL Walizka narzędziowa hermetyczna
 DE Hermetischer Werkzeugkoffer
 RU Герметичный инструментальный чемодан
 CZ Kufř na nářadí hermetický
 HU Hermetikus szerszámosláda
 RO Cutie scule ermetica
 FR Valise à outils étanche
 IT Valigetta portautensili a tenuta stagna
 ES Caja de herramientas hermetica
 CN 安全箱

470x357
x176
mm

DECOMPRESSION
VALVE
ZAWÓR
DEKOMPRESYJNY

SHOCK-
PROOF
ODPORNA
NA WSTRZĄSY

FOAM
INSERT
WKŁAD
GĄBKOWY

IP55

PP



YATO	External dimensions / Wymiary zewnątrzne [mm]	Internal dimensions / Wymiary wewnętrzne [mm]	
YT-08904	470x357x176	425x284x155	2

EN Hermetic toolbox
 PL Walizka narzędziowa hermetyczna
 DE Hermetischer Werkzeugkoffer
 RU Герметичный инструментальный чемодан
 CZ Kufř na nářadí hermetický
 HU Hermetikus szerszámosláda
 RO Cutie scule ermetica
 FR Valise à outils étanche
 IT Valigetta portautensili a tenuta stagna
 ES Caja de herramientas hermetica
 CN 安全箱

270x246
x124
mm

DECOMPRESSION
VALVE
ZAWÓR
DEKOMPRESYJNY

SHOCK-
PROOF
ODPORNA
NA WSTRZĄSY

FOAM
INSERT
WKŁAD
GĄBKOWY

IP55

PP



YATO	External dimensions / Wymiary zewnątrzne [mm]	Internal dimensions / Wymiary wewnętrzne [mm]	
YT-08901	270x246x124	235x181x105	8

EN Hermetic toolbox
 PL Walizka narzędziowa hermetyczna
 DE Hermetischer Werkzeugkoffer
 RU Герметичный инструментальный чемодан
 CZ Kufř na nářadí hermetický
 HU Hermetikus szerszámosláda
 RO Cutie scule ermetica
 FR Valise à outils étanche
 IT Valigetta portautensili a tenuta stagna
 ES Caja de herramientas hermetica
 CN 安全箱

406x330
x174
mm

DECOMPRESSION
VALVE
ZAWÓR
DEKOMPRESYJNY

SHOCK-
PROOF
ODPORNA
NA WSTRZĄSY

FOAM
INSERT
WKŁAD
GĄBKOWY

IP55

PP



YATO	External dimensions / Wymiary zewnątrzne [mm]	Internal dimensions / Wymiary wewnętrzne [mm]	
YT-08903	406x330x174	371x258x152	2

EN Hermetic toolbox
 PL Walizka narzędziowa hermetyczna
 DE Hermetischer Werkzeugkoffer
 RU Герметичный инструментальный чемодан
 CZ Kufř na nářadí hermetický
 HU Hermetikus szerszámosláda
 RO Cutie scule ermetica
 FR Valise à outils étanche
 IT Valigetta portautensili a tenuta stagna
 ES Caja de herramientas hermetica
 CN 安全箱

569x425
x215
mm

DECOMPRESSION
VALVE
ZAWÓR
DEKOMPRESYJNY

SHOCK-
PROOF
ODPORNA
NA WSTRZĄSY

FOAM
INSERT
WKŁAD
GĄBKOWY

IP55

PP



YATO	External dimensions / Wymiary zewnątrzne [mm]	Internal dimensions / Wymiary wewnętrzne [mm]	
YT-08906	569x425x215	505x350x140	2

EN Hermetic toolbox
PL Walizka narzędziowa hermetyczna
DE Hermetischer Werkzeugkoffer
RU Герметичный инструментальный чемодан
CZ Kufř na nářadí hermetický
HU Hermetikus szerszámosláda
RO Cutie scule ermetica
FR Valise à outils étanche
IT Valigetta portautensili a tenuta stagna
ES Caja de herramientas hermetica
CN 安全箱

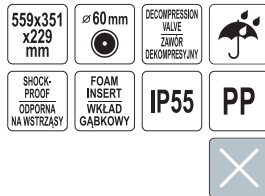

YATO	External dimensions / Wymiary zewnętrzne [mm]	Internal dimensions / Wymiary wewnętrzne [mm]	
YT-08905	559x351x229	501x279x193	1

EN Hermetic toolbox
PL Walizka narzędziowa hermetyczna
DE Hermetischer Werkzeugkoffer
RU Герметичный инструментальный чемодан
CZ Kufř na nářadí hermetický
HU Hermetikus szerszámosláda
RO Cutie scule ermetica
FR Valise à outils étanche
IT Valigetta portautensili a tenuta stagna
ES Caja de herramientas hermetica
CN 安全箱



YATO	External dimensions / Wymiary zewnętrzne [mm]	Internal dimensions / Wymiary wewnętrzne [mm]	
YT-08908	270x246x175	233x178x155	8

EN Hermetic toolbox
PL Walizka narzędziowa hermetyczna
DE Hermetischer Werkzeugkoffer
RU Герметичный инструментальный чемодан
CZ Kufř na nářadí hermetický
HU Hermetikus szerszámosláda
RO Cutie scule ermetica
FR Valise à outils étanche
IT Valigetta portautensili a tenuta stagna
ES Caja de herramientas hermetica
CN 安全箱



YATO	External dimensions / Wymiary zewnętrzne [mm]	Internal dimensions / Wymiary wewnętrzne [mm]	
YT-08916	550x438x125	479x333x97	6

EN Hermetic toolbox
PL Walizka narzędziowa hermetyczna
DE Hermetischer Werkzeugkoffer
RU Герметичный инструментальный чемодан
CZ Kufř na nářadí hermetický
HU Hermetikus szerszámosláda
RO Cutie scule ermetica
FR Valise à outils étanche
IT Valigetta portautensili a tenuta stagna
ES Caja de herramientas hermetica
CN 安全箱



YATO	External dimensions / Wymiary zewnętrzne [mm]	Internal dimensions / Wymiary wewnętrzne [mm]	
YT-08907	430x244x341	344x146x297	2

EN Hermetic toolbox
PL Walizka narzędziowa hermetyczna
DE Hermetischer Werkzeugkoffer
RU Герметичный инструментальный чемодан
CZ Kufř na nářadí hermetický
HU Hermetikus szerszámosláda
RO Cutie scule ermetica
FR Valise à outils étanche
IT Valigetta portautensili a tenuta stagna
ES Caja de herramientas hermetica
CN 安全箱



YATO	External dimensions / Wymiary zewnętrzne [mm]	Internal dimensions / Wymiary wewnętrzne [mm]	
YT-08915	360x290x165	330x234x152	4

EN Hermetic toolbox
PL Walizka narzędziowa hermetyczna
DE Hermetischer Werkzeugkoffer
RU Герметичный инструментальный чемодан
CZ Kufř na nářadí hermetický
HU Hermetikus szerszámosláda
RO Cutie scule ermetica
FR Valise à outils étanche
IT Valigetta portautensili a tenuta stagna
ES Caja de herramientas hermetica
CN 安全箱



YATO	External dimensions / Wymiary zewnętrzne [mm]	Internal dimensions / Wymiary wewnętrzne [mm]	
YT-08917	610x430x310	547x350x290	1

EN Hermetic toolbox
 PL Walizka narzędziowa hermetyczna
 DE Hermetischer Werkzeugkoffer
 RU Герметичный инструментальный чемодан
 CZ Kufr na nářadí hermetický
 HU Hermetikus szerszámosláda
 RO Cutie scule ermetica
 FR Valise à outils étanche
 IT Valigetta portautensili a tenuta stagna
 ES Caja de herramientas hermética
 CN 安全箱

715x430 x185 mm
 647x350 x120 mm INSIDE WEWNĄTRZ
 DECOMPRESSION VALVE ZAWÓR DEKOMPRESYJNY

 SHOCK-PROOF ODPORNA NA WSTRZĄSY
 FOAM INSERT WKŁAD GĄBKOWY
 IP55
 PP



YATO	External dimensions / Wymiary zewnętrzne [mm]	Internal dimensions / Wymiary wewnętrzne [mm]	
YT-08918	715x430x185	647x350x120	1

EN Organizer with bins
 PL Organizer z kuwetami
 DE Organizer mit Fächern
 RU Органайзер с контейнерами
 CZ Organizař na nářadí s přiřrádkami
 HU Szerszámrendező kivehető rekeszekkel
 RO Organizator cu compartimente
 FR Organisateur avec conteneurs
 IT Organizer con contenitori
 ES Organizador con recipientes
 CN 工具箱

490x420 x115 mm

 PP
 AI



YATO	
YT-08960	4

EN System organizer
 PL Organizer systemowy
 DE System-Sortimentskasten
 RU Системный органайзер
 CZ Systémový organizař
 HU Csavartartó doboz

RO Modul organizator
 FR Organisateur outils système
 IT Portautensili modulare
 ES Organizador modular
 CN 工具箱

257x180 x66 mm



YATO	
YT-09177	6

EN Hermetic toolbox
 PL Walizka narzędziowa hermetyczna
 DE Hermetischer Werkzeugkoffer
 RU Герметичный инструментальный чемодан
 CZ Kufr na nářadí hermetický
 HU Hermetikus szerszámosláda
 RO Cutie scule ermetica
 FR Valise à outils étanche
 IT Valigetta portautensili a tenuta stagna
 ES Caja de herramientas hermética
 CN 安全箱

845x620 x490 mm
 757x528 x452 mm INSIDE WEWNĄTRZ
 DECOMPRESSION VALVE ZAWÓR DEKOMPRESYJNY

 SHOCK-PROOF ODPORNA NA WSTRZĄSY
 FOAM INSERT WKŁAD GĄBKOWY
 IP55
 PP



YATO	External dimensions / Wymiary zewnętrzne [mm]	Internal dimensions / Wymiary wewnętrzne [mm]	
YT-08919	845x620x490	757x528x452	1

EN Toolbox
 PL Skrzynka narzędziowa
 DE Werkzeugkoffer
 RU Ящик для инструментов
 CZ Skříňka na nářadí
 HU Szerszámosláda
 RO Cutie pt. scule
 FR Boite à outils
 IT Casseta degli attrezzi
 ES Caja de herramientas
 CN 工具箱

560x305 x165 mm

 PP
 AI



YATO	
YT-08970	3

EN System organizer
 PL Organizer systemowy
 DE System-Sortimentskasten
 RU Системный органайзер
 CZ Systémový organizař
 HU Rendszer szervező

RO Modul organizator
 FR Organisateur outils système
 IT Portautensili modulare
 ES Organizador modular
 CN 工具箱

263x363 x77 mm
 M



YATO	
YT-09182	1

EN System organizer
PL Organizator systemowy
DE System-Sortimentskasten
RU Системный органайзер
CZ Systémový organizér
HU Csavartartó doboz

RO Modul organizator
FR Organisateur outils système
IT Portautensili modulari
ES Organizador modular
CN 工具箱

452x296
x79
mm



YATO
YT-09178



1

EN System organizer
PL Organizator systemowy
DE System-Sortimentskasten
RU Системный органайзер
HU Csavartartó doboz

RO Modul organizator
FR Organisateur outils système
IT Portautensili modulari
ES Organizador modular
CN 工具箱

452x358
x110
mm



YATO
YT-09179



1

EN System organizer
PL Organizator systemowy
DE System-Sortimentskasten
RU Системный органайзер
CZ Systémový organizér
HU Csavartartó doboz

RO Modul organizator
FR Organisateur outils système
IT Portautensili modulari
ES Organizador modular
CN 工具箱

531x379
x77
mm



YATO
YT-09181



1

EN System organizer
PL Organizator systemowy
DE System-Sortimentskasten
RU Системный органайзер
CZ Systémový organizér
HU Csavartartó doboz

RO Modul organizator
FR Organisateur outils système
IT Portautensili modulari
ES Organizador modular
CN 工具箱

585x387
x131
mm



YATO
YT-09180



1

EN System tote tool box
PL Pojemnik systemowy
DE System-Werkzeugcontainer
RU Ящик системный для инструментов
CZ Systémový box
HU Szerszámdoboz

RO Modul lada scule
FR Boîte à outils système
IT Contenitore portautensili modulari
ES Caja de herramientas modular
CN 工具箱

576x359
x237
mm



YATO
YT-09168



1

EN System tote tool box
PL Pojemnik systemowy
DE System-Werkzeugcontainer
RU Ящик системный для инструментов
CZ Systémový box
HU Szerszámdoboz
RO Modul lada scule
FR Boîte à outils système
IT Contenitore portautensili modulari
ES Caja de herramientas modular
CN 工具箱

450x310
x129
mm



YATO
YT-091681

Series / Seria
S1/S12



1

EN Power tool box
PL Skrzynka na elektronarzędzia
DE Koffer für Elektrowerkzeuge
RU Ящик для электроинструментов
CZ Box na elektronářadí
HU Szerszámoszláda elektromos szerszámközhöz
RO Cutie pt. scule electrice
FR Boîte à outils électriques
IT Cassetta porta attrezzi elettrici
ES Caja para herramientas eléctricas
CN 电动工具箱

450x322
x126
mm



YATO
YT-09170



1

EN Power tool box
PL Skrzynka na elektronarzędzia
DE Koffer für Elektrowerkzeuge
RU Ящик для электроинструментов
CZ Box na elektronářadí
HU Szerszámoszláda elektromos szerszámközhöz
RO Cutie pt. scule electrice
FR Boîte à outils électriques
IT Cassetta porta attrezzi elettrici
ES Caja para herramientas eléctricas
CN 电动工具箱

450x322
x126
mm



YATO
YT-09171

Series / Seria
S1/S12



1

EN Toolbox
 PL Skrzynka narzędziowa
 DE Werkzeugkoffer
 RU Ящик для инструментов
 CZ Skříňka na nářadí
 HU Szerszámosláda

RO Cutie pt. scule
 FR Boîte à outils
 IT Cassetta degli attrezzi
 ES Caja de herramientas
 CN 工具箱

450x260
x240
mm 







EN Toolbox
 PL Skrzynka narzędziowa
 DE Werkzeugkoffer
 RU Ящик для инструментов
 CZ Skříňka na nářadí
 HU Szerszámosláda

RO Cutie pt. scule
 FR Boîte à outils
 IT Cassetta degli attrezzi
 ES Caja de herramientas
 CN 工具箱

650x270
x272
mm 



YATO  
 YT-09183 1

YATO  
 YT-09184 1

EN Tool box with drawers
 PL Skrzynka z szufladami
 DE Werkzeugkiste mit Schubladen
 RU Ящик для инструментов с ящиками
 CZ Skříňka na nářadí se zásuvkami
 HU Fiókos szerszámosláda
 RO Cutie scule cu sertare
 FR Boîte à outils avec tiroirs
 IT Cassetta porta attrezzi con cassette
 ES Caja de herramientas con cajones
 CN 带抽屉工具箱



450x313
x245
mm  x2 





EN Tool box with drawers
 PL Skrzynka z szufladami
 DE Werkzeugkiste mit Schubladen
 RU Ящик для инструментов с ящиками
 CZ Skříňka na nářadí se zásuvkami
 HU Fiókos szerszámosláda
 RO Cutie scule cu sertare
 FR Boîte à outils avec tiroirs
 IT Cassetta porta attrezzi con cassette
 ES Caja de herramientas con cajones
 CN 带抽屉工具箱

450x320
x240
mm  x3 



YATO  Drawer quantity / Liczba szuflad Series / Seria 
 YT-08973 2 S1/S12 1

YATO  Drawer quantity / Liczba szuflad Series / Seria 
 YT-08974 3 S1/S12 1

EN System tool box with organizers
 PL Skrzynia z organizerami
 DE Box mit Organizern
 RU Ящик с органайзерами
 CZ Box s organizéry
 HU Láda szervezőkkel
 RO Cutie scule modulara cu organizator
 FR Boîte de rangement
 IT Cassa portautensili con organizer
 ES Caja con organizador
 CN 工具箱

241x450
x321
mm 



EN System tool box
 PL Skrzynia systemowa
 DE System-Werkzeugkoffer
 RU Системный ящик для инструментов
 CZ Systémová skříň
 HU Szerszámosláda

RO Modul cutie scule
 FR Boîte à outils modulaire
 IT Cassetta portautensili modulare
 ES Caja de herramientas modular
 CN 工具箱

585x385
x190
mm 





YATO  
 YT-09163 1

YATO  
 YT-09169 1

EN System tool box
PL Skrzynia systemowa
DE System-Werkzeugkoffer
RU Системный ящик для инструментов
CZ Systémová skříň
HU Szerszámoszláda
RO Modul cutie scule
FR Boîte à outils modulaire
IT Cassetta portautensili modulare
ES Caja de herramientas modular
CN 工具箱

584x385
x165
mm



YATO  Series / Seria 
YT-091692 S1/S12 1

EN System tool box
PL Skrzynia systemowa
DE System-Werkzeugkoffer
RU Системный ящик для инструментов
CZ Systémová skříň
HU Szerszámoszláda
RO Modul cutie scule
FR Boîte à outils modulaire
IT Cassetta portautensili modulare
ES Caja de herramientas modular
CN 工具箱

450x332
x170
mm



YATO  Series / Seria 
YT-091844 S1/S12 1

EN System tool box
PL Skrzynia systemowa
DE System-Werkzeugkoffer
RU Системный ящик для инструментов
CZ Systémová skříň
HU Szerszámoszláda
RO Modul cutie scule
FR Boîte à outils modulaire
IT Cassetta portautensili modulare
ES Caja de herramientas modular
CN 工具箱

584x385
x295
mm



YATO  Series / Seria 
YT-091691 S1/S12 1

EN System tool box
PL Skrzynia systemowa
DE System-Werkzeugkoffer
RU Системный ящик для инструментов
CZ Systémová skříň
HU Szerszámoszláda

RO Modul cutie scule
FR Boîte à outils modulaire
IT Cassetta portautensili modulare
ES Caja de herramientas modular
CN 工具箱

241x450
x321
mm



YATO  Series / Seria 
YT-09164 1

EN System tool box
PL Skrzynia systemowa
DE System-Werkzeugkoffer
RU Системный ящик для инструментов
CZ Systémová skříň
HU Szerszámoszláda

RO Modul cutie scule
FR Boîte à outils modulaire
IT Cassetta portautensili modulare
ES Caja de herramientas modular
CN 工具箱

585x385
x320
mm



YATO  Series / Seria 
YT-09167 1

EN System tool box on wheels
PL Skrzynia systemowa na kołach
DE System-Werkzeugkasten auf Rädern
RU Системный ящик на колесах
CZ Systémová skříň na kolech
HU Kerekes szerszámoszláda
RO Modul cutie scule cu roti
FR Boîte à outils modulaire roulante
IT Cassetta portautensili modulare con ruote
ES Caja de herramientas modular con ruedas
CN 工具箱

347x450
x381
mm



2x 



YATO  Series / Seria 
YT-09165 1

EN System tool box on wheels
 PL Skrzynia systemowa na kołach
 DE System-Werkzeugkasten auf Rädern
 RU Системный ящик на колесах
 CZ Systémová skříň na kolech
 HU Kerekes szerszámosláda
 RO Modul cutie scule cu roti
 FR Boîte à outils modulaire roulante
 IT Cassetta portautensili modulare con ruote
 ES Caja de herramientas modular con ruedas
 CN 工具箱



585x425
x410
mm

2x 



EN System tool box on wheels
 PL Skrzynia systemowa na kołach
 DE System-Werkzeugkasten auf Rädern
 RU Системный ящик на колесах
 CZ Systémová skříň na kolech
 HU Kerekes szerszámosláda
 RO Modul cutie scule cu roti
 FR Boîte à outils modulaire roulante
 IT Cassetta portautensili modulare con ruote
 ES Caja de herramientas modular con ruedas
 CN 工具箱







660x643
x483
mm

1038
660
mm

2x 



YATO  
 YT-09166 1

YATO  Series / Seria 
 YT-09159 S1/S12 1

EN Tool box set
 PL Zestaw skrzynek
 DE Werkzeugkoffer-Set
 RU Набор ящиков
 CZ Sada skříněk
 HU Ládakészlet
 RO Set cutii scule tip troller
 FR Jeu de caisses à outils
 IT Kit di cassetta porta attrezzi
 ES Juego de cajas de herramientas
 CN 工具箱



2
PCS

585x425
x645
mm

2x 



EN Tool box set
 PL Zestaw skrzynek
 DE Werkzeugkoffer-Set
 RU Набор ящиков
 CZ Sada skříněk
 HU Ládakészlet
 RO Set cutii scule
 FR Jeu de caisses à outils
 IT Kit di cassetta porta attrezzi
 ES Juego de cajas de herramientas
 CN 工具箱



3
PCS

421x450
x323
mm



YATO  
 YT-09162 1

YATO  
 YT-09175 1

EN Tool box set
 PL Zestaw skrzynek
 DE Werkzeugkoffer-Set
 RU Набор ящиков
 CZ Sada skříněk
 HU Ládakészlet
 RO Set cutii scule tip troller
 FR Jeu de caisses à outils
 IT Kit di cassetta porta attrezzi
 ES Juego de cajas de herramientas
 CN 工具箱



3
PCS

585x425
x810
mm

2x 



EN Tool box set
 PL Zestaw skrzynek
 DE Werkzeugkoffer-Set
 RU Набор ящиков
 CZ Sada skříněk
 HU Ládakészlet
 RO Set cutii scule tip troller
 FR Jeu de caisses à outils
 IT Kit di cassetta porta attrezzi
 ES Juego de cajas de herramientas
 CN 工具箱



3
PCS



685x450
x380
mm

975
685
mm

2x 



YATO  
 YT-09161 1

YATO  Series / Seria 
 YT-09173 S12 1

EN Tool box set
PL Zestaw skrzynek
DE Werkzeugkoffer-Set
RU Набор ящиков
CZ Sada skříňek
HU Ládakészlet
RO Set cutii scule tip troller
FR Jeu de caisses à outils
IT Kit di cassetta porta attrezzi
ES Juego de cajas de herramientas
CN 工具箱



4
PCS

722x450
x380
mm

EN System tool box on wheels
PL Skrzynia systemowa na kołach
DE System-Werkzeugkasten auf Rädern
RU Системный ящик на колесах
CZ Systémová skříň na kolech
HU Kerekes szerszámosláda
RO Modul cutie scule cu roti
FR Boîte à outils modulaire roulante
IT Cassetta portautensili modulare con ruote
ES Caja de herramientas modular con ruedas
CN 工具箱

600x400
x345
mm

2x



YATO

YT-09174

1

YATO

YT-09158

Series / Seria
S1/S12

1

EN Tool box with wheels
PL Skrzynia na kółkach
DE Kasten auf Rädern
RU Ящик на колесах
CZ Skříňka na kolečkách
HU Kerekes szállító platform
RO Troller scule
FR Caisse à outils roulante
IT Cassa portautensili con ruote
ES Caja con ruedas
CN 工具箱

793x385
x322
mm

2x



YATO

YT-09185

1

EN Platform on wheels
PL Platforma na kołach
DE Plattform mit Rollen
RU Платформа на колесах
CZ Přepravní plošina na kolečkách
HU Kerekes szállító platform
RO Platforma cu roti
FR Plateforme à roulettes
IT Piattaforma con ruote
ES Plataforma con ruedas
CN 平板搬运车

507x326
x143
mm

4x

360°



YATO

YT-09190

Series / Seria
S12

1

EN Two-parts tool box with wheels
PL Skrzynka dwupoziomowa na kółkach
DE Werkzeugkoffer mit zwei Etagen auf Rädern
RU Двухуровневый ящик на колесах
CZ Dvoupatrová skříňka na kolečkách
HU Kétszintes kerekes láda
RO Troller scule
FR Caisse double à outils roulante
IT Cassetta portautensili a due livelli con ruote
ES Caja dos niveles con ruedas
CN 工具箱

495x350
x710
mm

2x

1



YATO

YT-09160

1

EN Tool box set with platform
PL Zestaw skrzynek na platformie
DE Werkzeugkastensatz auf Plattform
RU Набор ящиков на платформе
CZ Sada skříňek na nářadí na plošnině
HU Moduláris mobil ládakészlet
RO Set cutie de scule cu platformă
FR Jeu de caisses à outils avec plateforme
IT Kit di cassetta porta attrezzi con piattaforma
ES Juego de cajas de herramientas en plataforma
CN 可搬运工具箱

4
PCS

507x326
x745
mm

4x

360°



YATO

YT-09191

Series / Seria
S12

1

EN Folding hand truck
 PL Składany wózek magazynowy
 DE Klappbare Transportkarre
 RU Складная бытовая тележка
 CZ Skládací hliníkový rudi
 HU Összecsukható kézikocsi
 RO Cărucior transport pliabil
 FR Chariot de main pliable
 IT Carrello di magazzino pieghevole
 ES Carretilla de mano plegable
 CN 可折叠手推车

max **60 kg**

AI

TELESCOPIC HANDLE
 ÜZMINTÉL
 TELESKOPOWY

TPR

EN Folding hand truck
 PL Składany wózek magazynowy
 DE Klappbare Transportkarre
 RU Складная бытовая тележка
 CZ Skládací hliníkový rudi
 HU Összecsukható kézikocsi
 RO Cărucior transport pliabil
 FR Chariot de main pliable
 IT Carrello di magazzino pieghevole
 ES Carretilla de mano plegable
 CN 可折叠手推车

max **60 kg**

AI

TELESCOPIC HANDLE
 ÜZMINTÉL
 TELESKOPOWY

TPR

EN Folding hand truck
 PL Składany wózek magazynowy
 DE Klappbare Transportkarre
 RU Складная бытовая тележка
 CZ Skládací hliníkový rudi
 HU Összecsukható kézikocsi
 RO Cărucior transport pliabil
 FR Chariot de main pliable
 IT Carrello di magazzino pieghevole
 ES Carretilla de mano plegable
 CN 可折叠手推车

2 in 1
2 w 1

max **137 kg**

max **68 kg**

360°
2x



YATO	Loading plate size / Rozmiar płyty ładunkowej [mm]	
YT-37410	390x280	1

YATO	Loading plate size / Rozmiar płyty ładunkowej [mm]	
YT-37411	390x280	1

YATO	Loading plate size / Rozmiar płyty ładunkowej [mm]	
YT-37412	390x280	1

EN Lifting and moving straps
PL Pasy do przenoszenia mebli
DE Gürtel zum Bewegen von Heben
RU Ремни для переноски мебели
CZ Pohyblivé pásy pro zvedání nábytku
HU Emelő mozgó pántok
RO Curele pt. mutat obiecte
FR Sangles de levage et de déplacement
IT Cinghie per trasporto di mobili
ES Cinturones para llevar muebles
CN 双人手抬带

2 PCS **8x280** cm **PP** 



YATO 

YT-74260

 18/36

EN Lifting and moving straps
PL Pasy do przenoszenia mebli
DE Gürtel zum Bewegen von Heben
RU Ремни для переноски мебели
CZ Pohyblivé pásy pro zvedání nábytku
HU Emelő mozgó pántok
RO Curele pt. mutat obiecte
FR Sangles de levage et de déplacement
IT Cinghie per trasporto di mobili
ES Cinturones para llevar muebles
CN 双人搬运带

4 PCS **8x280** cm **PP** 

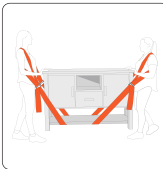

YATO 

YT-74262

 8/16

EN Furniture transport roller set
PL Zestaw rolek do transportu mebli
DE Möbel-Transportroller-Set
RU Набор для перемещения мебели
CZ Sada na stěhování nábytku
HU Bútor szállító készlet
RO Set transport si ridicat mobila
FR Paire de roues et de poussoir de transporteur mobile
IT Set di rulli per trasporto di mobili
ES Muebles transporte conjunto
CN 搬运器

5 PCS **max 300kg** 



YATO 

YT-37490

 6

EN Lifting and moving straps
PL Pasy do przenoszenia mebli
DE Gürtel zum Bewegen von Heben
RU Ремни для переноски мебели
CZ Pohyblivé pásy pro zvedání nábytku
HU Emelő mozgó pántok
RO Curele pt. mutat obiecte
FR Sangles de levage et de déplacement
IT Cinghie per trasporto di mobili
ES Cinturones para llevar muebles
CN 双人搬运带

3 PCS **5x370** cm **PP** 

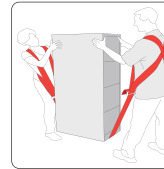

YATO 

YT-74261

 10/20

EN Lifting and moving straps
PL Pasy do przenoszenia ładunku
DE Gürtel zum Bewegen von Heben
RU Такелажный ремень для переноски грузов
CZ Pásy pro ruční přenášení nákladu
HU Emelő mozgó pánt
RO Curele pt. mutat obiecte
FR Sangles de levage et de déplacement
IT Cinghia per trasporto di carico
ES Cinta de levantamiento e movimiento
CN 环保手提带

8x180 cm **PP** 



YATO 

YT-74263

 25/100

EN Lanyard with safety breakaway buckles
PL Linka zabezpieczająca narzędzia
DE Sicherungsleine für Werkzeuge
RU Тросик для предохранения инструментов
CZ Zabezpečovací lanko k nářadí
HU Szerszámrögzítő kötél
RO Cablu siguranta extensibil
FR Cordon de sécurité de l'outil
IT Cavo di ancoraggio per utensile
ES Cable de seguridad para herramientas
CN 弹簧安全绳

52-170 cm 



YATO 

Ø [mm]

Max. load capacity / Maks. obciążenie [kg]



YT-74008	1.0	2	24/144
YT-74009	1.5	3	24/144

20

Health & safety articles
Artykuły BHP





Safety glasses
Okulary ochronne
606-607 

Ear plugs
Zatyczki do uszu
614 

Corrective protection glasses
Okulary ochronne korekcyjne
607 

Hearing protectors
Nauszniki przeciwhałasowe
614-616 

Safety goggles
Gogle ochronne
607-608 

Safety helmets
Kaski ochronne
616 

Magnifiers
Lupy
608 

Working shoes
Buty robocze
617-619 

Working gloves
Rękawice robocze
609-610 

Safety sandals
Sandale robocze 617
Low-cut safety shoes
Półbuty robocze 617
Middle-cut safety shoes
Trzewiki robocze 618
Safety rain boots
Kalosze robocze 619
Shoes accessories
Akcesoria do obuwia 619

Working aprons
Fartuchy robocze
611 

Working socks
Skarpety robocze
619 

Safety support belts
Pasy antyprzeciążeniowe
611 

Working clothes
Odzież robocza
620-632 

Safety harness & accessories
Szelki bezpieczeństwa i akcesoria
611-612 

Knee pads
Nakolanniki
612-613 

T-shirts and shirts
Koszulki i koszule 620
Working jackets
Bluzy i kurtki robocze 623
Working trousers
Spodnie robocze 626
Work bib pants
Spodnie robocze ogrodniczki 630
Rainsuits
Komplety przeciwdeszczowe 632

Disposable dust masks
Półmaski filtrujące
613 

EN Safety glasses
 PL Okulary ochronne
 DE Schutzbrille
 RU Очки защитные
 CZ Ochranné brýle
 HU Védőszemüveg
 RO Ochelari de protectie
 FR Lunette de protection
 IT Occhiali protettivi
 ES Gafa de seguridad
 CN 劳保眼镜



1
OPTICAL CLASS
KLASA OPTYCZNA

 Uv

YATO 
 YT-7360  12/240



1
OPTICAL CLASS
KLASA OPTYCZNA

 Uv

YATO 
 YT-7361  12/240



1
OPTICAL CLASS
KLASA OPTYCZNA



 Uv

YATO 
 YT-7363  12/240



1
OPTICAL CLASS
KLASA OPTYCZNA



 Uv

YATO 
 YT-7365  12/240





1
OPTICAL CLASS
KLASA OPTYCZNA

 Uv

YATO 
 YT-7367  12/240





1
OPTICAL CLASS
KLASA OPTYCZNA

YATO 
 YT-7369  12/240





1
OPTICAL CLASS
KLASA OPTYCZNA

YATO 
 YT-7371  12/240





1
OPTICAL CLASS
KLASA OPTYCZNA

YATO 
 YT-73631  12/300





1
OPTICAL CLASS
KLASA OPTYCZNA

YATO 
 YT-73761  12/300





1
OPTICAL CLASS
KLASA OPTYCZNA

 Uv

YATO 
 YT-7362  12/240





1
OPTICAL CLASS
KLASA OPTYCZNA

YATO 
 YT-7364  12/240





1
OPTICAL CLASS
KLASA OPTYCZNA

YATO 
 YT-7366  12/240





1
OPTICAL CLASS
KLASA OPTYCZNA

YATO 
 YT-7368  12/240





1
OPTICAL CLASS
KLASA OPTYCZNA

YATO 
 YT-7376  12/240



1
OPTICAL CLASS
KLASA OPTYCZNA



 Uv

YATO 
 YT-73641  12/300



1
OPTICAL CLASS
KLASA OPTYCZNA



 Uv

YATO 
 YT-73760  12/300



1
OPTICAL CLASS
KLASA OPTYCZNA



 Uv 

YATO 
 YT-73602  12/240



2
OPTICAL CLASS
KLASA OPTYCZNA



YATO 
 YT-73634  10/100

EN Safety glasses
PL Okulary ochronne
DE Schutzbrille
RU Очки защитные
CZ Ochranné brýle
HU Védőszemüveg

RO Ochelari de protecție
FR Lunette de protection
IT Occhiali protettivi
ES Gafa de seguridad
CN 劳保眼镜

1
OPTICAL CLASS
KLASA OPTYCZNA

PC

EVA



TYPE 92218SR EN 166:2001 F

YATO
YT-73700 12/240

EN Safety glasses
PL Okulary ochronne
DE Schutzbrille
RU Очки защитные
CZ Ochranné brýle
HU Védőszemüveg

RO Ochelari de protecție
FR Lunette de protection
IT Occhiali protettivi
ES Gafa de seguridad
CN 劳保眼镜

1
OPTICAL CLASS
KLASA OPTYCZNA

PC

EVA



TYPE 92281 EN 166:2001 F

YATO
YT-73603 12/240

EN Safety glasses
PL Okulary ochronne
DE Schutzbrille
RU Очки защитные
CZ Ochranné brýle
HU Védőszemüveg

RO Ochelari de protecție
FR Lunette de protection
IT Occhiali protettivi
ES Gafa de seguridad
CN 劳保眼镜

1
OPTICAL CLASS
KLASA OPTYCZNA

PC

EVA



TYPE 92218SR EN 166:2001 F

YATO
YT-73701 12/240

EN Safety glasses
PL Okulary ochronne
DE Schutzbrille
RU Очки защитные
CZ Ochranné brýle
HU Védőszemüveg
RO Ochelari de protecție
FR Lunette de protection
IT Occhiali protettivi
ES Gafa de seguridad
CN 劳保眼镜

1
OPTICAL CLASS
KLASA OPTYCZNA

PC

TPR

EVA



TYPE 90960FA-RX EN 166:2001 FT

YATO
YT-73621 12/300

EN Safety glasses
PL Okulary ochronne
DE Schutzbrille
RU Очки защитные
CZ Ochranné brýle
HU Védőszemüveg
RO Ochelari de protecție
FR Lunette de protection
IT Occhiali protettivi
ES Gafa de seguridad
CN 劳保眼镜

1
OPTICAL CLASS
KLASA OPTYCZNA

PC

TPR

EVA



TYPE 90960FA-RX EN 166:2001 FT

YATO
YT-73702 12/300

EN Safety glasses
PL Okulary ochronne
DE Schutzbrille
RU Очки защитные
CZ Ochranné brýle
HU Védőszemüveg
RO Ochelari de protecție
FR Lunette de protection
IT Occhiali protettivi
ES Gafa de seguridad
CN 劳保眼镜

1
OPTICAL CLASS
KLASA OPTYCZNA

PC

TPR

EVA



TYPE 90960FA-RX EN 166:2001 FT

YATO
YT-73703 12/300

EN Corrective protection glasses
PL Okulary ochronne korekcyjne
DE Korrekturschutzbrille

RU Защитные корректирующие очки
CZ Ochranné brýle
HU Védőszemüveg

RO Ochelari de protecție
FR Lunette de protection
IT Occhiali di sicurezza da vista

ES Gafa de seguridad
CN 雙光老花眼鏡

1
OPTICAL CLASS
KLASA OPTYCZNA

BIFOCAL
DWI-
OGNISKOWE

PC



TYPE 9844BI 166:2001 F

YATO	Correction / Korekcja	
YT-73611	+1.0 D	12/300
YT-73612	+1.5 D	12/300
YT-73613	+2.0 D	12/300
YT-73614	+2.5 D	12/300
YT-73615	+3.0 D	12/300

EN Safety goggles
PL Gogle ochronne
DE Schutzbrille
RU Очки защитные
CZ Ochranné brýle
HU Védőszemüveg
RO Ochelari de protecție
FR Lunette de protection
IT Occhiali protettivi
ES Gafa de seguridad
CN 劳保眼镜

1
OPTICAL CLASS
KLASA OPTYCZNA

PC

EVA

ANTI-FOG
COATING
POWŁOKA
ANTYPAROWA

SCRATCH
PROTECTION
OCHRONA
PRZED
ZARYSOWANIEM



TYPE 92275 EN 166:2001 F

YATO
YT-73765 12/240

EN Safety goggles
PL Gogle ochronne
DE Schutzbrille
RU Очки защитные
CZ Ochranné brýle
HU Védőszemüveg
RO Ochelari de protecție
FR Lunette de protection
IT Occhiali protettivi
ES Gafa de seguridad
CN 劳保眼镜

1
OPTICAL CLASS
KLASA OPTYCZNA

PC

EVA



ANTI-FOG
COATING
POWŁOKA
ANTYPAROWA

SCRATCH
PROTECTION
OCHRONA
PRZED
ZARYSOWANIEM



TYPE 92275 EN 166:2001 F

YATO
YT-73766 12/240

EN Safety goggles
PL Gogle ochronne
DE Schutzbrille
RU Очки защитные
CZ Ochranné brýle
HU Védőszemüveg

RO Ochelari de protecție
FR Lunette de protection
IT Occhiali protettivi
ES Gafa de seguridad
CN 劳保眼镜

1
OPTICAL CLASS
KLASA OPTYCZNA

PC

SCRATCH
PROTECTION
OCHRONA
PRZED
ZARYSOWANIEM



TYPE 2876 EN 166:2001 F

YATO
YT-7377 12/120

EN Safety goggles
PL Gogle ochronne
DE Schutzbrille
RU Очки защитные
CZ Ochranné brýle
HU Védőszemüveg

RO Ochelari de protectie
FR Lunette de protection
IT Occhiali protettivi
ES Gafa de seguridad
CN 劳保眼镜

1
OPTICAL CLASS
KLASA OPTYCZNA

PC

SCRATCH PROTECTION
OCZRONA PRZED ZARYSIOWANIEM

EN Safety goggles with indirect ventilation
PL Gogle ochronne z wywietrznikami
DE Schutzbrille mit Lüftung
RU Защитные очки с вентиляцией
CZ Ochranné brýle s ventilací
HU Védőszemüveg szellőzőnyílásokkal
RO Ochelari de protectie cu ventilatie
FR Lunette de protection avec aération
IT Occhiali protettivi con valvole di aerazione
ES Gafa de seguridad con ventilación
CN 防护眼镜

1
OPTICAL CLASS
KLASA OPTYCZNA

PC

PVC

EN Safety goggles
PL Gogle ochronne
DE Schutzbrille
RU Очки защитные
CZ Ochranné brýle
HU Védőszemüveg

RO Ochelari de protectie
FR Lunette de protection
IT Occhiali protettivi
ES Gafa de seguridad
CN 劳保眼镜

1
OPTICAL CLASS
KLASA OPTYCZNA

PC

SCRATCH PROTECTION
OCZRONA PRZED ZARYSIOWANIEM



TYPE SG90A EN 166:2001 F

YATO

YT-7380

20/200



TYPE SG90B-1 EN 166:2001 B

YATO

YT-7381

20/200



TYPE SG-60 EN 166:2001 B

YATO

YT-7382

10/100

EN Safety goggles
PL Gogle ochronne
DE Schutzbrille
RU Очки защитные
CZ Ochranné brýle
HU Védőszemüveg
RO Ochelari de protectie
FR Lunette de protection
IT Occhiali protettivi
ES Gafa de seguridad
CN 劳保眼镜

1
OPTICAL CLASS
KLASA OPTYCZNA

PC

PVC

SCRATCH PROTECTION
OCZRONA PRZED ZARYSIOWANIEM

EN Safety goggles with indirect ventilation
PL Gogle ochronne z wywietrznikami
DE Schutzbrille mit Lüftung
RU Защитные очки с вентиляцией
CZ Ochranné brýle s ventilací
HU Védőszemüveg szellőzőnyílásokkal
RO Ochelari de protectie cu ventilatie
FR Lunette de protection avec aération
IT Occhiali protettivi con valvole di aerazione
ES Gafa de seguridad con ventilación
CN 防护眼镜

1
OPTICAL CLASS
KLASA OPTYCZNA

PC

PVC

SCRATCH PROTECTION
OCZRONA PRZED ZARYSIOWANIEM

EN Safety goggles with indirect ventilation
PL Gogle ochronne z wywietrznikami
DE Schutzbrille mit Lüftung
RU Защитные очки с вентиляцией
CZ Ochranné brýle s ventilací
HU Védőszemüveg szellőzőnyílásokkal
RO Ochelari de protectie cu ventilatie
FR Lunette de protection avec aération
IT Occhiali protettivi con valvole di aerazione
ES Gafa de seguridad con ventilación
CN 防护眼镜

1
OPTICAL CLASS
KLASA OPTYCZNA

PC

PVC

SCRATCH PROTECTION
OCZRONA PRZED ZARYSIOWANIEM



TYPE B421 EN 166:2001 B

YATO

YT-73830

10/100



TYPE KM2101 EN 166:2001 F

YATO

YT-73831

10/100



TYPE KM2101 EN 166:2001 F

YATO

YT-73832

10/100

EN Magnifier with LED light
PL Lupa z oświetleniem mocowane na głowie
DE Stirnlupe mit Beleuchtung
RU Лупы с подсветкой с креплением на голову
CZ Lupa s osvětlením upevněné na hlavě
HU Fejre rögzíthető nagyító lámpával
RO Ochelari cu lupa si LED
FR Loupes à fixer à la tête avec éclairage
IT Lenti d'ingrandimento da testa con luce
ES Lupa para cabeza con luz
CN 头戴式放大镜

10x
15x
20x 25x

2 LED

ABS

3x
+
LR1130



Battery not included
Baterii nie dołączono



YATO

YT-73840

60

EN Magnifier with LED light
PL Lupa z oświetleniem mocowane na głowie
DE Stirnlupe mit Beleuchtung
RU Лупы с подсветкой с креплением на голову
CZ Lupa s osvětlením upevněné na hlavě
HU Fejre rögzíthető nagyító lámpával
RO Ochelari cu lupa si LED
FR Loupes à fixer à la tête avec éclairage
IT Lenti d'ingrandimento da testa con luce
ES Lupa para cabeza con luz
CN 头戴式放大镜

1x
1.5x 2x
2.5x 3.5x

2 LED

ABS

3x
+
LR1130



Battery not included
Baterii nie dołączono



YATO

YT-73842

40

EN Working gloves
PL Rękawice robocze
DE Arbeitshandschuhe
RU Рабочие перчатки
CZ Pracovní rukavice
HU Munkakesztyű
RO Mănuși de lucru
FR Gants de travail
IT Guanti da lavoro
ES Guantes de trabajo
CN 劳保手套

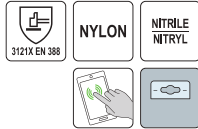

YATO	Size / Rozmiar	
YT-74754	8	12/144
YT-74755	9	12/144
YT-74756	10	12/144

EN Working gloves
PL Rękawice robocze
DE Arbeitshandschuhe
RU Рабочие перчатки
CZ Pracovní rukavice
HU Munkakesztyű
RO Mănuși de lucru
FR Gants de travail
IT Guanti da lavoro
ES Guantes de trabajo
CN 劳保手套

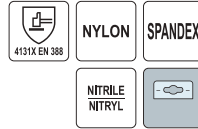

YATO	Size / Rozmiar	
YT-74757	8	12/120
YT-74758	9	12/120
YT-74759	10	12/120

EN Working gloves
PL Rękawice robocze
DE Arbeitshandschuhe
RU Рабочие перчатки
CZ Pracovní rukavice
HU Munkakesztyű
RO Mănuși de lucru
FR Gants de travail
IT Guanti da lavoro
ES Guantes de trabajo
CN 劳保手套

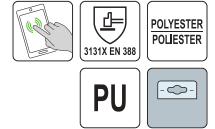

YATO	Size / Rozmiar	
YT-74751	8	12/144
YT-74752	9	12/144
YT-74753	10	12/144

EN Working gloves
PL Rękawice robocze
DE Arbeitshandschuhe
RU Рабочие перчатки
CZ Pracovní rukavice
HU Munkakesztyű
RO Mănuși de lucru
FR Gants de travail
IT Guanti da lavoro
ES Guantes de trabajo
CN 劳保手套



YATO	Size / Rozmiar	
YT-74699	9	50/100
YT-7470	10	50/100

EN Working gloves
PL Rękawice robocze
DE Arbeitshandschuhe
RU Рабочие перчатки
CZ Pracovní rukavice
HU Munkakesztyű
RO Mănuși de lucru
FR Gants de travail
IT Guanti da lavoro
ES Guantes de trabajo
CN 劳保手套



YATO	Size / Rozmiar	
YT-74719	9	50/100
YT-7472	10	50/100

EN Working gloves
PL Rękawice robocze
DE Arbeitshandschuhe
RU Рабочие перчатки
CZ Pracovní rukavice
HU Munkakesztyű
RO Mănuși de lucru
FR Gants de travail
IT Guanti da lavoro
ES Guantes de trabajo
CN 劳保手套



YATO	Size / Rozmiar	
YT-74728	8	50/100
YT-74729	9	50/100
YT-7473	10	50/100

EN Working gloves
PL Rękawice robocze
DE Arbeitshandschuhe
RU Рабочие перчатки
CZ Pracovní rukavice
HU Munkakesztyű

RO Mănuși de lucru
FR Gants de travail
IT Guanti da lavoro
ES Guantes de trabajo
CN 劳保手套



NYLON

NITRILE NITRYL



YATO	Size / Rozmiar	
YT-74739	9	50/100
YT-7474	10	10/100

EN Working gloves
PL Rękawice robocze
DE Arbeitshandschuhe
RU Рабочие перчатки
CZ Pracovní rukavice
HU Munkakesztyű

RO Mănuși de lucru
FR Gants de travail
IT Guanti da lavoro
ES Guantes de trabajo
CN 劳保手套



PE

NITRILE NITRYL



YATO	Size / Rozmiar	
YT-7480	9	12/120
YT-7481	10	12/120

EN Working gloves
PL Rękawice robocze
DE Arbeitshandschuhe
RU Рабочие перчатки
CZ Pracovní rukavice
HU Munkakesztyű

RO Mănuși de lucru
FR Gants de travail
IT Guanti da lavoro
ES Guantes de trabajo
CN 劳保手套



HPPE

PU



YATO	Size / Rozmiar	
YT-74771	9	12/120
YT-74772	10	12/120

EN Assembly gloves
PL Rękawice ochronne
DE Schutzhandschuhe
RU Защитные перчатки
CZ Ochranné rukavice
HU Védőkesztyű

RO Mănuși protecție
FR Gants de protection
IT Guanti di protezione
ES Guantes de protección
CN 防护手套



COTTON BAWELNA



YATO	Size / Rozmiar	
YT-74639	8	10/120
YT-746391	9	10/120
YT-74640	10	10/120

EN Working gloves
PL Rękawice robocze
DE Arbeitshandschuhe
RU Рабочие перчатки
CZ Pracovní rukavice
HU Munkakesztyű

RO Mănuși de lucru
FR Gants de travail
IT Guanti da lavoro
ES Guantes de trabajo
CN 劳保手套



COTTON BAWELNA



YATO	Size / Rozmiar	
YT-746418	8	10/120
YT-746419	9	10/120
YT-74642	10	10/120

EN Assembly gloves
PL Rękawice ochronne
DE Schutzhandschuhe
RU Защитные перчатки
CZ Ochranné rukavice
HU Védőkesztyű

RO Mănuși protecție
FR Gants de protection
IT Guanti di protezione
ES Guantes de protección
CN 防护手套



2122X EN 388



YATO	Size / Rozmiar	
YT-74645	10	10/120

EN Assembly gloves
 PL Rękawice ochronne
 DE Schutzhandschuhe
 RU Защитные перчатки
 CZ Ochranné rukavice
 HU Védőkesztyű

RO Mănuși protecție
 FR Gants de protection
 IT Guanti di protezione
 ES Guantes de protección
 CN 防护手套



YATO	Size / Rozmiar	
YT-74647	10	10/120

EN Assembly gloves
 PL Rękawice ochronne
 DE Schutzhandschuhe
 RU Защитные перчатки
 CZ Ochranné rukavice
 HU Védőkesztyű

RO Mănuși protecție
 FR Gants de protection
 IT Guanti di protezione
 ES Guantes de protección
 CN 防护手套



YATO	Size / Rozmiar	
YT-746402	9	10/120
YT-746403	10	10/120

EN Assembly gloves
 PL Rękawice ochronne
 DE Schutzhandschuhe
 RU Защитные перчатки
 CZ Ochranné rukavice
 HU Védőkesztyű

RO Mănuși protecție
 FR Gants de protection
 IT Guanti di protezione
 ES Guantes de protección
 CN 防护手套



YATO	Size / Rozmiar	
YT-74650	10	10/120

EN Working gloves
 PL Rękawice robocze
 DE Arbeitshandschuhe
 RU Рабочие перчатки
 CZ Pracovní rukavice
 HU Munkakesztyű

RO Mănuși de lucru
 FR Gants de travail
 IT Guanti da lavoro
 ES Guantes de trabajo
 CN 劳保手套



YATO	Size / Rozmiar	
YT-74658	8	12/72
YT-74659	9	12/72
YT-74660	10	12/72
YT-746600	11	12/120

EN Working gloves
 PL Rękawice robocze
 DE Arbeitshandschuhe
 RU Рабочие перчатки
 CZ Pracovní rukavice
 HU Munkakesztyű

RO Mănuși de lucru
 FR Gants de travail
 IT Guanti da lavoro
 ES Guantes de trabajo
 CN 劳保手套



YATO	Size / Rozmiar	
YT-74661	9	12/72
YT-74662	10	12/72
YT-746621	11	12/120

EN Working gloves
 PL Rękawice robocze
 DE Arbeitshandschuhe
 RU Рабочие перчатки
 CZ Pracovní rukavice
 HU Munkakesztyű

RO Mănuși de lucru
 FR Gants de travail
 IT Guanti da lavoro
 ES Guantes de trabajo
 CN 劳保手套



YATO	Size / Rozmiar	
YT-74663	9	12/72
YT-74664	10	12/72
YT-746641	11	12/120

EN Working gloves
 PL Rękawice robocze
 DE Arbeitshandschuhe
 RU Рабочие перчатки
 CZ Pracovní rukavice
 HU Munkakesztyű

RO Mănuși de lucru
 FR Gants de travail
 IT Guanti da lavoro
 ES Guantes de trabajo
 CN 劳保手套



YATO	Size / Rozmiar	
YT-746648	8	12/72
YT-74665	9	12/72
YT-74666	10	12/72
YT-746681	11	12/120

EN Welding gloves
 PL Rękawice spawalnicze
 DE Schweißhandschuhe
 RU Сварочные перчатки
 CZ Svářečské rukavice
 HU Hegesztőkesztyű
 RO Manusi pt. sudura
 FR Gants de soudure
 IT Guanti per saldatura
 ES Guantes de soldador
 CN 焊接手套

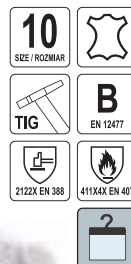

YATO	Size / Rozmiar	
YT-74820	10	12/120

EN Welding gloves
 PL Rękawice spawalnicze
 DE Schweißhandschuhe
 RU Сварочные перчатки
 CZ Svářečské rukavice
 HU Hegesztőkesztyű
 RO Manusi pt. sudura
 FR Gants de soudure
 IT Guanti per saldatura
 ES Guantes de soldador
 CN 焊接手套



YATO	Size / Rozmiar	
YT-74824	10	12/72

EN Tool apron
PL Fartuch roboczy
DE Werkzeugschürze
RU Фартук для инструментов
CZ Zásleka na nářadí
HU Kertész kötény
RO Sort pt. scule
FR Outil tablier
IT Grembiule da lavoro
ES Delantal para herramientas
CN 围裙



YATO Size / Rozmiar
YT-74060 60

EN High visibility elastic adjustable safety support belt
PL Pas antyprzeżycienny elastyczny odblaskowy
DE Elastische reflektierende Industriegurt
RU Эластичный поддерживающий пояс с высокой видимостью
CZ Reflexní elastický opasek
HU Hivis rugalmas deréktámasztó öv
RO Curea de siguranță elastică reglabilă, reflectorizantă
FR Élastique salut-vis de sécurité retour ceinture de soutien
IT Cintura di sovraccarico ad alta visibilità
ES Cinturón de soporte elástico ajustable de alta visibilidad
CN 护腰带



YATO Size / Rozmiar
YT-74241 XL 50
YT-742411 XXL 50

EN High visibility elastic adjustable safety support belt
PL Pas antyprzeżycienny elastyczny odblaskowy
DE Elastische reflektierende Industriegurt
RU Эластичный поддерживающий пояс с высокой видимостью
CZ Reflexní elastický opasek
HU Hivis rugalmas deréktámasztó öv
RO Curea de siguranță elastică reglabilă, reflectorizantă
FR Élastique salut-vis de sécurité retour ceinture de soutien
IT Cintura di sovraccarico ad alta visibilità
ES Cinturón de soporte elástico ajustable de alta visibilidad
CN 护腰带



YATO Size / Rozmiar
YT-74242 XL 50
YT-742421 XXL 50

EN Safety harness for working at height
PL Szelki bezpieczeństwa z pasem biodrowym
DE Sicherheitsgurt für Arbeiten in Höhe
RU Страхочная привязь для работы на высоте
CZ Celotělový úvazek
HU Biztonsági heveder
RO Centura de siguranță tip ham
FR Arnés de seguridad
IT Imbracatura di sicurezza con cosciale
ES Harnais de sécurité
CN 高空作业安全带



YATO
YT-74218 5

EN Harness and lanyard set
PL Zesław szelki i amortyzator
DE Auffanggurt mit Abseilgerät Set
RU Комплект для работ на высоте
CZ Sada šle a tlumič
HU Teljes testheveder és energiaelnyelő kántár szett
RO Set ham cu amortizor sustinere
FR Kit harnais de protection anti-chutes et amortisseur
IT Set di imbracatura di sicurezza e ammortizzatore
ES Arnés y amortiguador, juego
CN 安全绳



YATO
YT-74235 10

EN Safety harness for working at height
PL Szelki bezpieczeństwa z pasem biodrowym
DE Sicherheitsgurt für Arbeiten in Höhe
RU Страхочная привязь для работы на высоте
CZ Celotělový úvazek
HU Biztonsági heveder
RO Centura de siguranță tip ham
FR Arnés de seguridad
IT Imbracatura di sicurezza con cosciale
ES Harnais de sécurité
CN 高空作业安全带

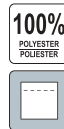

YATO
YT-74220 10

EN Safety harness for working at height
PL Szelki bezpieczeństwa z pasem biodrowym
DE Sicherheitsgurt für Arbeiten in Höhe
RU Страхочная привязь для работы на высоте
CZ Celotělový úvazek
HU Biztonsági heveder
RO Centura de siguranță tip ham
FR Arnés de seguridad
IT Imbracatura di sicurezza con cosciale
ES Harnais de sécurité
CN 高空作业安全带

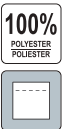

YATO
YT-74221 20

EN Single shock absorber with rope
 PL Amortyzator z linką
 DE Abseilgerät mit Seil
 RU Амортизатор с тросиком
 CZ Tlumič s lanem
 HU Energiaelnyelő kántár kötéllel
 RO Cordelină de siguranță cu amortizor
 FR Amortisseur avec câble d'attache
 IT Ammortizzatore con cordino
 ES Amortiguador con cable
 CN 安全绳



YATO 

YT-74236



EN Shock absorber
 PL Amortyzator bezpieczeństwa
 DE Verbindungsmittel mit Bandfalldämpfer
 RU Строп с амортизатором
 CZ Tlumič pádu s karabinou
 HU Segédkötél hevederszalag
 RO Amortizor de siguranță
 FR Cordes de sécurité avec amortisseur de chute
 IT Ammortizzatore di sicurezza
 ES Amortiguador de caída
 CN 高空作业挂绳



YATO 

YT-74225



EN Carabiner hook
 PL Karabińczyk
 DE Karabinerhaken
 RU Карабин
 CZ Karabina
 HU Karabiner
 RO Carabină
 FR Mousqueton
 IT Moschettone
 ES Mosquetón
 CN 弹簧钩



YATO 

YT-74229



EN Knee pads
 PL Nakolanniki
 DE Knieschützer
 RU Наколенники
 CZ Chrániče kolen
 HU Térdvédő
 RO Genunchiere
 FR Genouillères
 IT Protettore per ginocchio
 ES Rodilleras
 CN 护膝



YATO 

YT-74612



EN Shock absorber
 PL Amortyzator bezpieczeństwa
 DE Verbindungsmittel mit Bandfalldämpfer
 RU Строп с амортизатором
 CZ Tlumič pádu s karabinou
 HU Energiaelnyelő hevederszalag
 RO Amortizor de siguranță
 FR Cordes de sécurité avec amortisseur de chute
 IT Ammortizzatore di sicurezza
 ES Amortiguador de caída
 CN 安全绳



YATO 

YT-74227



EN Stranded hooks
 PL Linka pomocnicza z karabińczykami
 DE Hilfsseil mit Karabinerhaken
 RU Вспомогательный тросик с карабинами
 CZ Pomocné lano s karabinami
 HU Segédkötél karabinekkel
 RO Franghie de sustinere
 FR Câble de secours avec mousquetons
 IT Cordino con moschettoni
 ES Cable auxiliar con mosquetones
 CN 安全绳



YATO 

YT-74231



EN Carabiner hook
 PL Karabińczyk
 DE Karabinerhaken
 RU Карабин
 CZ Karabina
 HU Karabiner
 RO Carabină
 FR Mousqueton
 IT Moschettone
 ES Mosquetón
 CN 大钩



YATO 

YT-74230



EN Gel knee pads
 PL Nakolanniki żelowe
 DE Gel-Knieschoner
 RU Гелевые наколенники
 CZ Nákolenníky gelové
 HU Zselés térdvédő
 RO Genunchiere silicon
 FR Genouillères gel
 IT Ginocchio in gel
 ES Rodilleras de gel
 CN 护膝



YATO 

YT-7460



EN Gel knee pads
PL Nakolanniki żelowe
DE Gel-Knieschoner
RU Гелевые наколенники
CZ Nákolenníky gelové
HU Zselés térdvédő
RO Genunchiere silicon
FR Genouillères gel
IT Ginocchiere in gel
ES Rodilleras de gel
CN 护膝

600D
POLYESTER
POLIESTER

EVA

PVC

GEL
SUPPORT
COURONA



YT-7461

12

EN Gel knee pads
PL Nakolanniki żelowe
DE Gel-Knieschoner
RU Гелевые наколенники
CZ Nákolenníky gelové
HU Zselés térdvédő
RO Genunchiere silicon
FR Genouillères gel
IT Ginocchiere in gel
ES Rodilleras de gel
CN 护膝

600D
POLYESTER
POLIESTER

PVC

GEL
SUPPORT
COURONA



YT-74615

10

EN Dust mask
PL Półmaska filtrująca
DE Staubschutzmaske
RU Респиратор противоаэрозольный
CZ Maska protiprašná
HU Légzészvédő maszk
RO Mască de praf
FR Masque anti-poussière
IT Mascherina filtrante
ES Mascarilla para polvo
CN 防尘面罩



2
PCS

FFP1

3
PCS

FFP1



YT-74852



50



YT-7485



25/50



FFP1

3
PCS

FFP1

3
PCS

FFP1

3
PCS

FFP1



YT-74862



50



YT-7486



25/50



YT-74870



50



YT-7488



50/50



3
PCS

FFP2

3
PCS

FFP2

2
PCS

FFP2

FFP2



YT-74917



50



YT-7492



15/50



YT-74919



50



YT-74949



50

EN Ear plugs
 PL Zatycki do uszu
 DE Ohrstöpsel
 RU беруши
 CZ Zátkové chrániče sluchu
 HU Fül dugó
 RO Antifoane tip dop
 FR Bouchons anti-bruit
 IT Tappi per orecchie
 ES Tapones para los oídos
 CN 耳塞

x5 **5-11 mm** **SNR 38dB**



YATO	Ø [mm]	Pairs / Pary	
YT-7451	5-11	5	25/500

EN Ear plugs
 PL Zatycki do uszu
 DE Ohrstöpsel
 RU беруши
 CZ Zátkové chrániče sluchu
 HU Fül dugó
 RO Antifoane tip dop
 FR Bouchons anti-bruit
 IT Tappi per orecchie
 ES Tapones para los oídos
 CN 耳塞

x5 **8-12 mm** **SNR 32dB**

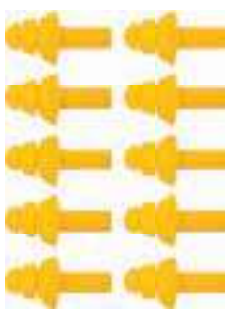

YATO	Ø [mm]	Pairs / Pary	
YT-7455	8-12	5	25/500

EN Ear plugs
 PL Zatycki do uszu
 DE Ohrstöpsel
 RU беруши
 CZ Zátkové chrániče sluchu
 HU Fül dugó
 RO Antifoane tip dop
 FR Bouchons anti-bruit
 IT Tappi per orecchie
 ES Tapones para los oídos
 CN 耳塞

x5 **10-14 mm** **SNR 31dB**

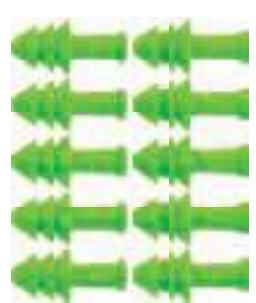

YATO	Ø [mm]	Pairs / Pary	
YT-74551	7-12	5	40/800

EN Ear plugs
 PL Zatycki do uszu
 DE Ohrstöpsel
 RU беруши
 CZ Zátkové chrániče sluchu
 HU Fül dugó
 RO Antifoane tip dop
 FR Bouchons anti-bruit
 IT Tappi per orecchie
 ES Tapones para los oídos
 CN 耳塞

x200 **5-11 mm** **SNR 38dB**



YATO	Ø [mm]	Pairs / Pary	
YT-74510	5-11	200	20

EN Ear plugs
 PL Zatycki do uszu
 DE Ohrstöpsel
 RU беруши
 CZ Zátkové chrániče sluchu
 HU Fül dugó
 RO Antifoane tip dop
 FR Bouchons anti-bruit
 IT Tappi per orecchie
 ES Tapones para los oídos
 CN 耳塞

x50 **8-12 mm**

SNR 28dB



YATO	Ø [mm]	Pairs / Pary	
YT-7456	8-12	50	20

EN Ear plugs
 PL Zatycki do uszu na paląku
 DE Ohrstöpsel
 RU беруши
 CZ Zátkové chrániče sluchu
 HU Fül dugó
 RO Antifoane interne
 FR Bouchons anti-bruit
 IT Tappi per orecchie
 ES Tapones para los oídos
 CN 耳塞

SNR 29dB



YATO	
YT-7458	25/500

EN Earplug dispenser
 PL Dozownik z zatyckami do uszu
 DE Spender mit Ohrstöpseln
 RU Дозатор для берушей
 CZ Dávkovač zátkových chráničů sluchu
 HU Fülvédő-adagoló
 RO Dozator de antifoane
 FR Distributeur de bouchons d'oreille
 IT Distributore di tappi antirumore
 ES Dispensador de tapones para los oídos
 CN 耳塞分配器

500 PCS

SNR 38dB

5-11 mm



YATO	Ø [mm]	Pairs / Pary	
YT-74520	5-11	250	4

EN Refill bag for earplug dispenser
 PL Zatycki do uszu do dozownika
 DE Ohrstöpsel für Spender
 RU беруши для дозатора
 CZ Zátkové chrániče sluchu pro dávkovač
 HU Fülvédők adagolóba
 RO Antifoane rezervă pt. dispenser
 FR Bouchons d'oreille pour le distributeur
 IT Tappi antirumore per il distributore
 ES Tapones para los oídos para el dispensador
 CN 耳塞

500 PCS

SNR 38dB

5-11 mm



For YT-74520
 Dla YT-74520

YATO	Ø [mm]	Pairs / Pary	
YT-74521	5-11	250	20

EN Safety earmuffs
 PL Nauszniki przeciwhałasowe
 DE Gehörschutz
 RU Противошумные наушники
 CZ Chrániče sluchu
 HU Hallásvédő fültek
 RO Căști antifonice
 FR Casque anti-bruit
 IT Cuffie antirumore
 ES Auriculares de protección auditiva
 CN 耳罩



SNR 28dB



YATO	
YT-74624	20

EN Safety earmuffs
PL Nauszniki przeciwhałasowe
DE Gehörschutz
RU Противошумные наушники
CZ Chráníče sluchu
HU Hallásvédő fültok
RO Căști antifonice
FR Casque anti-bruit
IT Cuffie antirumore
ES Auriculares de protección auditiva
CN 耳罩

SNR
31dB 



YATO 

YT-74631

 20

EN Safety earmuffs
PL Nauszniki przeciwhałasowe
DE Gehörschutz
RU Противошумные наушники
CZ Chráníče sluchu
HU Hallásvédő fültok
RO Căști antifonice
FR Casque anti-bruit
IT Cuffie antirumore
ES Auriculares de protección auditiva
CN 耳罩

SNR
26dB 



YATO 

YT-7462

 40

EN Safety earmuffs
PL Nauszniki przeciwhałasowe
DE Gehörschutz
RU Противошумные наушники
CZ Chráníče sluchu
HU Hallásvédő fültok
RO Căști antifonice
FR Casque anti-bruit
IT Cuffie antirumore
ES Auriculares de protección auditiva
CN 耳罩

SNR
27dB 



YATO 

YT-74621

 60

EN Safety earmuffs
PL Nauszniki przeciwhałasowe
DE Gehörschutz
RU Противошумные наушники
CZ Chráníče sluchu
HU Hallásvédő fültok
RO Căști antifonice
FR Casque anti-bruit
IT Cuffie antirumore
ES Auriculares de protección auditiva
CN 耳罩

SNR
26dB 



YATO 

YT-74632

 40

EN Safety earmuffs
PL Nauszniki przeciwhałasowe
DE Gehörschutz
RU Противошумные наушники
CZ Chráníče sluchu
HU Hallásvédő fültok
RO Căști antifonice
FR Casque anti-bruit
IT Cuffie antirumore
ES Auriculares de protección auditiva
CN 耳罩

SNR
32dB 



YATO 

YT-74633

 24

EN Safety earmuffs
PL Nauszniki przeciwhałasowe
DE Gehörschutz
RU Противошумные наушники
CZ Chráníče sluchu
HU Hallásvédő fültok
RO Căști antifonice
FR Casque anti-bruit
IT Cuffie antirumore
ES Auriculares de protección auditiva
CN 耳罩

SNR
34dB 



YATO 

YT-74630

 20

EN Combined eye & ear protection muffs
PL Nauszniki zintegrowane z okularami
DE Kapselgehörschutz mit Brille integriert
RU Противошумные наушники с очками
CZ Chráníče uší integrované s brýlemi
HU Szemüveggel integrált fülvédő
RO Set ochelari protectie + antifoane
FR Protège-oreilles combiné aux lunettes
IT Cuffie antirumore con occhiali integrati
ES Orejeras de seguridad con gafas
CN 二合一护眼护耳防护套

SNR
23.9dB **ABS** **PC** **1**
OPTICAL GLASS
KLASA OPTYCZNA
 **Juv** **SCRATCH PROTECTION**
OCZYNNA PRZED ZARYSOWANIEM 

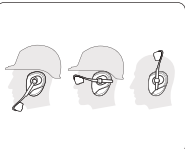

YATO 

YT-74635

 24

EN Combined eye & ear protection muffs
PL Nauszniki zintegrowane z okularami
DE Kapselgehörschutz mit Brille integriert
RU Противошумные наушники с очками
CZ Chráníče uší integrované s brýlemi
HU Szemüveggel integrált fülvédő
RO Set ochelari protectie + antifoane
FR Protège-oreilles combiné aux lunettes
IT Cuffie antirumore con occhiali integrati
ES Orejeras de seguridad con gafas
CN 二合一护眼护耳防护套

SNR
23.9dB **ABS** **PC** **1**
OPTICAL GLASS
KLASA OPTYCZNA
 **Juv** **SCRATCH PROTECTION**
OCZYNNA PRZED ZARYSOWANIEM 

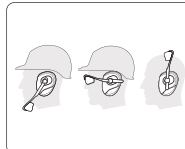

YATO 

YT-74636

 24

EN Electronic earmuffs
 PL Nauszniki przeciwhałasowe elektroniczne
 DE Elektronischer Gehörschutz
 RU Электронные противошумные наушники
 CZ Elektronické protihlukové chrániče sluchu
 HU Elektronikus fültök
 RO Căști antifon electronice
 FR Casque anti-bruit électronique
 IT Cuffie protettive elettroniche
 ES Casco antiruido electrónico
 CN 电子耳罩

SNR 28 dB	3.7 V 750mAh Li-Po	3.5h
30h 	BUILT-IN MICROPHONES WŁĄCZANE MIKROFONY	WIRELESS TECHNOLOGY BEZPRZEWODOWA
LOW VOICE AMPLIFICATION WZMACNIACZ GŁOSNOŚCI	SMART EAR PROTECTION INTELEKTYWNA OCHRONA SŁUCHU	LOW BATTERY ALARM WSKAZNIK POZIOMU BATERII
USB 	AUX ∅ 3,5 mm	AUTO POWER OFF AUTOMATYCZNE WYŁĄCZANIE



YATO **YT-74625** 20

EN Electronic earmuffs
 PL Nauszniki przeciwhałasowe elektroniczne
 DE Elektronischer Gehörschutz
 RU Электронные противошумные наушники
 CZ Elektronické protihlukové chrániče sluchu
 HU Elektronikus fültök
 RO Căști antifon electronice
 FR Casque anti-bruit électronique
 IT Cuffie protettive elettroniche
 ES Casco antiruido electrónico
 CN 电子耳罩

SNR 29 dB	3.7 V 750mAh Li-Po	3.5h
30h 	BUILT-IN MICROPHONES WŁĄCZANE MIKROFONY	WIRELESS TECHNOLOGY BEZPRZEWODOWA
LOW BATTERY ALARM WSKAZNIK POZIOMU BATERII	USB 	AUX ∅ 3,5 mm
	AUTO POWER OFF AUTOMATYCZNE WYŁĄCZANIE	



YATO **YT-74626** 20

EN Replacement grey lens
 PL Szkiełka wymienne szare
 DE Wechselgläser grau
 RU Сменные стекла, серые
 CZ Výměnná skla šedá
 HU Szürke pótlencse
 RO Lentile gri de rezervă
 FR Verres gris interchangeables
 IT Lenti per occhiali grigi
 ES Lentes reemplazables, color gris
 CN 镜片

1 OPTICAL CLASS KLASA OPTYCZNA	PC	Juv 	SCRATCH PROTECTION OCHRONA PRZED ZARYSOWANIEM	
---	-----------	----------------	---	--



For YT-74635, YT-74636
 Dla YT-74635, YT-74636

YATO **YT-74637** 30/600

EN Replacement transparent lens
 PL Szkiełka wymienne bezbarwne
 DE Wechselgläser klar
 RU Сменные стекла, бесцветные
 CZ Výměnná skla bezbarvá
 HU Színezetlen pótlencse
 RO Lentile transparente de rezervă
 FR Verres transparents interchangeables
 IT Lenti per occhiali trasparenti
 ES Lentes reemplazables, transparentes
 CN 镜片

1 OPTICAL CLASS KLASA OPTYCZNA	PC	Juv 	SCRATCH PROTECTION OCHRONA PRZED ZARYSOWANIEM	
---	-----------	----------------	---	--



For YT-74635, YT-74636
 Dla YT-74635, YT-74636

YATO **YT-74638** 30/600

EN Safety helmet
 PL Kask ochronny
 DE Schutzhelm
 RU Каска защитная
 CZ Ochranná přilba
 HU Védősisak
 RO Cască de protecție
 FR Casque de sécurité
 IT Casco di protezione
 ES Casco de protección
 CN 安全帽



ABS	
------------	--

YATO	Color / Kolor	
YT-73970	pomarańczowy	30
YT-73971	żółty	30
YT-73972	biały	30
YT-73973	czerwony	30
YT-73974	niebieski	30
YT-73975	zielony	30

EN Safety sandals
PL Sandały robocze
DE Arbeitshalschuhe
RU Полуботинки рабочие
CZ Pracovní polobotky
HU Munkavédelmi félcipő
RO Sandale de protecție
FR Sandale de sécurité
IT Sandalo da lavoro
ES Zapato de trabajo
CN 劳保鞋

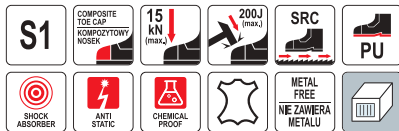

- Composite toe cap
- PU overcup
- Insole & mesh coated EVA
- Shock absorber
- Kompozytowy nosek
- Podeszwa z poliuretanu z noskiem
- Wkładka i wyściółka z materiału EVA
- Amortyzator drgań

SEGURA

YATO	Size / Rozmiar	
YT-80460	36	10
YT-80461	37	10
YT-80462	38	10
YT-80463	39	10
YT-80464	40	10
YT-80465	41	10

YATO	Size / Rozmiar	
YT-80466	42	10
YT-80467	43	10
YT-80468	44	10
YT-80469	45	10
YT-80470	46	10
YT-80471	47	10

EN Low-cut safety shoes
PL Półbuty robocze
DE Arbeitshalschuhe
RU Полуботинки рабочие
CZ Pracovní polobotky
HU Munkavédelmi cipő
RO Pantofi de lucru
FR Chaussure de sécurité
IT Scarpe antinfortunistiche
ES Zapato de seguridad
CN 低帮安全鞋



- Steel toe cap
- PU sole
- Insole & mesh coated EVA
- Shock absorber
- Stalowy nosek
- Podeszwa z poliuretanu
- Wkładka i wyściółka z materiału EVA
- Amortyzator drgań

PUNO

YATO	Size / Rozmiar	
YT-80521	39	10
YT-80522	40	10
YT-80523	41	10
YT-80524	42	10
YT-80525	43	10

YATO	Size / Rozmiar	
YT-80526	44	10
YT-80527	45	10
YT-80528	46	10
YT-80529	47	10

EN Low-cut safety shoes
PL Półbuty robocze
DE Arbeitshalschuhe
RU Полуботинки рабочие
CZ Pracovní polobotky
HU Munkavédelmi cipő
RO Pantofi de lucru
FR Chaussure de sécurité
IT Scarpe antinfortunistiche
ES Zapato de seguridad
CN 低帮安全鞋



- Steel toe cap
- PU sole
- Insole & mesh coated EVA
- Shock absorber
- Stalowy nosek
- Podeszwa z poliuretanu
- Wkładka i wyściółka z materiału EVA
- Amortyzator drgań

PUEBLE

YATO	Size / Rozmiar	
YT-80583	39	10
YT-80584	40	10
YT-80585	41	10
YT-80586	42	10
YT-80587	43	10

YATO	Size / Rozmiar	
YT-80588	44	10
YT-80589	45	10
YT-80590	46	10
YT-80591	47	10

EN Low-cut safety shoes
PL Półbuty robocze
DE Arbeitshalschuhe
RU Полуботинки рабочие
CZ Pracovní polobotky
HU Munkavédelmi cipő
RO Pantofi de lucru
FR Chaussure de sécurité
IT Scarpe antinfortunistiche
ES Zapato de seguridad
CN 低帮安全鞋



- Steel toe cap
- Puncture-resistant flexible composite midsole
- Breathable and comfortable lining
- Stalowy nosek
- Elastyczna wkładka antyprzebiwoia z tworzywa sztucznego
- Oddychająca i komfortowa wyściółka

PRIME

YATO	Size / Rozmiar	
YT-80530	39	10
YT-80531	40	10
YT-80532	41	10
YT-80533	42	10
YT-80534	43	10

YATO	Size / Rozmiar	
YT-80535	44	10
YT-80536	45	10
YT-80537	46	10
YT-80538	47	10

EN Sport safety shoes
PL Buty ochronne sportowe
DE Sportschutzschuhe
RU Спортивная защитная обувь
CZ Sportovní ochranné boty
HU Sport védőcipő
RO Pantofi sport de lucru
FR Chaussures de sécurité sport
IT Scarpe antinfortunistiche sportive
ES Calzado de seguridad deportivo
CN 安全鞋



- Steel toe cap
- Puncture-resistant flexible composite midsole
- Comfortable EVA foam insole
- Stalowy nosek
- Elastyczna wkładka antyprzebiwoia z tworzywa sztucznego
- Komfortowa wkładka wewnętrzna z pianki EVA

PAERIS

YATO	Size / Rozmiar	
YT-80641	39	10
YT-80642	40	10
YT-80643	41	10
YT-80644	42	10
YT-80645	43	10

YATO	Size / Rozmiar	
YT-80646	44	10
YT-80647	45	10
YT-80648	46	10
YT-80649	47	10

EN Sport safety shoes
PL Buty ochronne sportowe
DE Sportschutzschuhe
RU Спортивная защитная обувь
CZ Sportovní ochranné boty
HU Sport védőcipő
RO Pantofi sport de lucru
FR Chaussures de sécurité sport
IT Scarpe antinfortunistiche sportive
ES Calzado de seguridad deportivo
CN 安全鞋



- Steel toe cap
- Puncture-resistant flexible composite midsole
- Comfortable EVA foam insole
- Stalowy nosek
- Elastyczna wkładka antyprzebiwoia z tworzywa sztucznego
- Komfortowa wkładka wewnętrzna z pianki EVA

PACS

YATO	Size / Rozmiar	
YT-80629	36	10
YT-80630	37	10
YT-80631	38	10
YT-80632	39	10
YT-80633	40	10
YT-80634	41	10

YATO	Size / Rozmiar	
YT-80635	42	10
YT-80636	43	10
YT-80637	44	10
YT-80638	45	10
YT-80639	46	10
YT-80640	47	10

EN Sport safety shoes
 PL Buty ochronne sportowe
 DE Sportschuhschuhe
 RU Спортивная защитная обувь
 CZ Sportovní ochranné boty
 HU Sport védőcipő
 RO Pantofi sport de lucru
 FR Chaussures de sécurité sport
 IT Scarpe antinfortunistiche sportive
 ES Calzado de seguridad deportivo
 CN 安全鞋

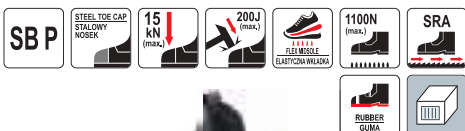

- Steel toe cap
- Puncture-resistant flexible composite midsole
- Comfortable EVA foam insole
- Stalowy nosek
- Elastyczna wkładka antyprzebiwcowa z tworzywa sztucznego
- Komfortowa wkładka wewnętrzna z pianki EVA

PUBS

YATO	Size / Rozmiar	
YT-80620	39	10
YT-80621	40	10
YT-80622	41	10
YT-80623	42	10
YT-80624	43	10

YATO	Size / Rozmiar	
YT-80625	44	10
YT-80626	45	10
YT-80627	46	10
YT-80628	47	10

EN Low-cut safety shoes
 PL Półbuty robocze
 DE Arbeitshalbschuhe
 RU Полуботинки рабочие
 CZ Pracovní polobotky
 HU Munkavédelmi cipő
 RO Pantofi de lucru
 FR Chaussure de sécurité
 IT Scarpe antinfortunistiche
 ES Zapato de seguridad
 CN 低帮安全鞋



- Composite toe cap
- Puncture-resistant flexible composite midsole
- Kompozytowy nosek
- Elastyczna wkładka antyprzebiwcowa z tworzywa sztucznego

PARAN

YATO	Size / Rozmiar	
YT-80650	39	10
YT-80651	40	10
YT-80652	41	10
YT-80653	42	10
YT-80654	43	10

YATO	Size / Rozmiar	
YT-80655	44	10
YT-80656	45	10
YT-80657	46	10
YT-80658	47	10

EN Middle-cut safety shoes
 PL Trzewiki robocze
 DE Mittelhohe Sicherheitsschuhe
 RU Ботинки рабочие
 CZ Bezpečnostní obuv středního stříhu
 HU Munkavédelmi bakancs
 RO Ghete de lucru
 FR Chaussure de sécurité mi-hautes
 IT Scarpe antinfortunistiche alte
 ES Botas de seguridad
 CN 劳保鞋



- Steel toe cap
- PU sole
- Insole & mesh coated EVA
- Shock absorber
- Stalowy nosek
- Podeszwa z poliuretanu
- Wkładka i wyściółka z materiału EVA
- Amortyzator drgań

TRAT

YATO	Size / Rozmiar	
YT-80733	39	10
YT-80734	40	10
YT-80735	41	10
YT-80736	42	10
YT-80737	43	10

YATO	Size / Rozmiar	
YT-80738	44	10
YT-80739	45	10
YT-80740	46	10
YT-80741	47	10

EN Sport safety shoes
 PL Buty ochronne sportowe
 DE Sportschuhschuhe
 RU Спортивная защитная обувь
 CZ Sportovní ochranné boty
 HU Sport védőcipő
 RO Pantofi sport de lucru
 FR Chaussures de sécurité sport
 IT Scarpe antinfortunistiche sportive
 ES Calzado de seguridad deportivo
 CN 防护运动鞋



- Composite toe cap
- Puncture-resistant flexible composite midsole
- Kompozytowy nosek
- Elastyczna wkładka antyprzebiwcowa z tworzywa sztucznego

POMPA

YATO	Size / Rozmiar	
YT-80509	39	10
YT-80510	40	10
YT-80511	41	10
YT-80512	42	10
YT-80513	43	10

YATO	Size / Rozmiar	
YT-80514	44	10
YT-80515	45	10
YT-80516	46	10
YT-80517	47	10

EN Middle-cut safety shoes
 PL Trzewiki robocze
 DE Mittelhohe Sicherheitsschuhe
 RU Ботинки рабочие
 CZ Bezpečnostní obuv středního stříhu
 HU Munkavédelmi bakancs
 RO Ghete de lucru
 FR Chaussure de sécurité mi-hautes
 IT Scarpe antinfortunistiche alte
 ES Botas de seguridad
 CN 劳保鞋



- Composite toe cap
- Puncture-resistant flexible composite midsole
- Kompozytowy nosek
- Elastyczna wkładka antyprzebiwcowa z tworzywa sztucznego

TARAN

YATO	Size / Rozmiar	
YT-80750	39	10
YT-80751	40	10
YT-80752	41	10
YT-80753	42	10
YT-80754	43	10

YATO	Size / Rozmiar	
YT-80755	44	10
YT-80756	45	10
YT-80757	46	10
YT-80758	47	10

EN Middle-cut safety shoes
 PL Trzewiki robocze
 DE Mittelhohe Sicherheitsschuhe
 RU Ботинки рабочие
 CZ Bezpečnostní obuv středního stříhu
 HU Munkavédelmi bakancs
 RO Ghete de lucru
 FR Chaussure de sécurité mi-hautes
 IT Scarpe antinfortunistiche alte
 ES Botas de seguridad
 CN 劳保鞋



- Steel toe cap
- PU sole
- Insole & mesh coated EVA
- Shock absorber
- Stalowy nosek
- Podeszwa z poliuretanu
- Wkładka i wyściółka z materiału EVA
- Amortyzator drgań

TEZU

YATO	Size / Rozmiar	
YT-80841	39	10
YT-80842	40	10
YT-80843	41	10
YT-80844	42	10
YT-80845	43	10

YATO	Size / Rozmiar	
YT-80846	44	10
YT-80847	45	10
YT-80848	46	10
YT-80849	47	10

EN Middle-cut safety shoes
PL Trzewiki robocze
DE Mittelhohe Sicherheitsschuhe
RU Ботинки рабочие
CZ Bezpečnostní obuv středního střihu
HU Munkavédelmi bakancs
RO Ghete de lucru
FR Chaussure de sécurité mi-hautes
IT Scarpe antinfortunistiche alte
ES Botas de seguridad
CN 劳保鞋



- Steel toe cap
- PU sole
- Insole & mesh coated EVA
- Shock absorber
- Stalowy nosek
- Podeszwa z poliuretanu
- Wkładka i wyściółka z materiału EVA
- Amortyzator drgań

TWER

YATO	Size / Rozmiar	Box
YT-80783	39	10
YT-80784	40	10
YT-80785	41	10
YT-80786	42	10
YT-80787	43	10

YATO	Size / Rozmiar	Box
YT-80788	44	10
YT-80789	45	10
YT-80790	46	10
YT-80791	47	10

EN Safety rain boots
PL Kalosze z metalowym podnoskiem
DE Gummistiefel mit Metall-Zehenschutzkappe
RU Резиновые сапоги с металлическим подноском
CZ Holinky s kovovou špičkou
HU Fém ormerevítés gumicsizma
RO Cizme de protecție din cauciuc
FR Bottes en caoutchouc de sécurité
IT Stivali di gomma con puntale in metallo
ES Botas de goma con punta metálica
CN 安全雨鞋

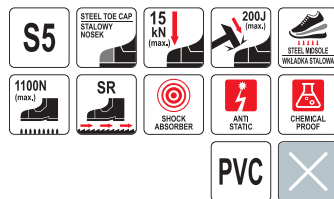

- Steel toe cap
- Knee high PVC boots
- Cleated PVC outsole
- Shock absorber
- Stalowy nosek
- Cholewka z PVC do kolana
- Wyrzeźbiona podeszwa z PVC
- Amortyzator drgań

PORTLAND

YATO	Size / Rozmiar	Box
YT-80881	39	8
YT-80882	40	8
YT-80883	41	8
YT-80884	42	8

YATO	Size / Rozmiar	Box
YT-80885	43	8
YT-80886	44	8
YT-80887	45	8
YT-80888	46	8

EN Premium shoe insoles
PL Wkładki do butów premium
DE Premium-Schuheinlagen
RU Стельки для обуви
CZ Vložky do bot premium
HU Prémium talbatétek
RO Branturi premium pt. pantofi
FR Semelles de chaussures premium
IT Solette premium per scarpe
ES Plantillas premium para botas
CN 鞋垫



YATO	Size / Rozmiar	L [cm]	Box
YT-808701	39	26.0	7/70
YT-808702	40	27.0	7/70
YT-808703	41	27.5	7/70
YT-808704	42	28.0	7/70
YT-808705	43	28.5	7/70

YATO	Size / Rozmiar	L [cm]	Box
YT-808706	44	29.0	7/70
YT-808707	45	30.0	7/70
YT-808708	46	30.5	7/70
YT-808709	47	31.0	7/70

EN Work socks
PL Skarpety robocze
DE Arbeitssocken
RU Рабочие носки
CZ Ponožky pracovní
HU Munkazokni
RO Șosete de lucru
FR Chaussettes de travail
IT Calzini da lavoro
ES Calcetines de trabajo
CN 长工作袜



75% cotton, 22% polyester, 3% spandex
75% bawełna, 22% poliester, 3% spandex

YATO	Size / Rozmiar	Box
YT-78340	39-42	4/40
YT-78341	43-46	4/40

EN Work socks
PL Skarpety robocze
DE Arbeitssocken
RU Рабочие носки
CZ Ponožky pracovní
HU Munkazokni
RO Șosete de lucru
FR Chaussettes de travail
IT Calzini da lavoro
ES Calcetines de trabajo
CN 短工作袜



75% cotton, 22% polyester, 3% spandex
75% bawełna, 22% poliester, 3% spandex

YATO	Size / Rozmiar	Box
YT-78342	39-42	4/40
YT-78343	43-46	4/40

EN T-shirt
PL Koszulka
DE T-Shirt
RU Фырбонка
CZ Tričko
HU Póló
RO Tricou
FR Tee-shirt
IT T-shirt
ES Camiseta
CN T恤衫



100% cotton
100% bawełna

BASIC

YATO	Size / Rozmiar	
YT-78470	S	40
YT-78471	M	40
YT-78472	L	40
YT-78473	XL	40
YT-78474	XXL	40
YT-78475	XXXL	40

EN T-shirt
PL Koszulka
DE T-Shirt
RU Фырбонка
CZ Tričko
HU Póló
RO Tricou
FR Tee-shirt
IT T-shirt
ES Camiseta
CN T恤衫



100% cotton
100% bawełna

BASIC

YATO	Size / Rozmiar	
YT-78482	S	40
YT-78483	M	40
YT-78484	L	40
YT-78485	XL	40
YT-78486	XXL	40
YT-78487	XXXL	40

EN T-shirt
PL Koszulka
DE T-Shirt
RU Фырбонка
CZ Tričko
HU Póló
RO Tricou
FR Tee-shirt
IT T-shirt
ES Camiseta
CN T恤衫



100% cotton
100% bawełna

BASIC

YATO	Size / Rozmiar	
YT-78494	S	40
YT-78495	M	40
YT-78496	L	40
YT-78497	XL	40
YT-78498	XXL	40
YT-78499	XXXL	40

EN T-shirt
PL Koszulka
DE T-Shirt
RU Фырбонка
CZ Tričko
HU Póló
RO Tricou
FR Tee-shirt
IT T-shirt
ES Camiseta
CN T恤衫

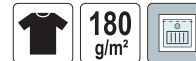

100% cotton
100% bawełna

BASIC

YATO	Size / Rozmiar	
YT-78476	S	40
YT-78477	M	40
YT-78478	L	40
YT-78479	XL	40
YT-78480	XXL	40
YT-78481	XXXL	40

EN T-shirt
PL Koszulka
DE T-Shirt
RU Фырбонка
CZ Tričko
HU Póló
RO Tricou
FR Tee-shirt
IT T-shirt
ES Camiseta
CN T恤衫

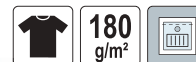

100% cotton
100% bawełna

BASIC

YATO	Size / Rozmiar	
YT-78488	S	40
YT-78489	M	40
YT-78490	L	40
YT-78491	XL	40
YT-78492	XXL	40
YT-78493	XXXL	40

EN T-shirt
PL Koszulka
DE T-Shirt
RU Фырбонка
CZ Tričko
HU Póló
RO Tricou
FR Tee-shirt
IT T-shirt
ES Camiseta
CN T恤衫

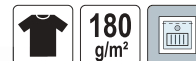

95% cotton, 5% viscose
95% bawełna, 5% wiskoza

BASIC



YATO	Size / Rozmiar	
YT-78500	S	40
YT-78501	M	40
YT-78502	L	40
YT-78503	XL	40
YT-78504	XXL	40
YT-78505	XXXL	40

EN T-shirt
PL Koszulka
DE T-Shirt
RU Фyтбoлka
CZ Tričko
HU Póló
RO Tricou
FR Tee-shirt
IT T-shirt
ES Camiseta
CN T恤衫



95% cotton, 5% elastane
95% bawełna, 5% elastan

TALL



YATO 	Size / Rozmiar	
YT-78420	S	40
YT-78421	M	40
YT-78422	L	40
YT-78423	XL	40
YT-78424	XXL	40
YT-78425	XXXL	40

EN T-shirt
PL Koszulka
DE T-Shirt
RU Фyтбoлka
CZ Tričko
HU Póló
RO Tricou
FR Tee-shirt
IT T-shirt
ES Camiseta
CN T恤衫



95% cotton, 5% elastane
95% bawełna, 5% elastan

TALL



YATO 	Size / Rozmiar	
YT-78426	S	40
YT-78427	M	40
YT-78428	L	40
YT-78429	XL	40
YT-78430	XXL	40
YT-78431	XXXL	40

EN T-shirt
PL Koszulka
DE T-Shirt
RU Фyтбoлka
CZ Tričko
HU Póló
RO Tricou
FR Tee-shirt
IT T-shirt
ES Camiseta
CN T恤衫



95% cotton, 5% elastane
95% bawełna, 5% elastan

TALL



YATO 	Size / Rozmiar	
YT-78432	S	40
YT-78433	M	40
YT-78434	L	40
YT-78435	XL	40
YT-78436	XXL	40
YT-78437	XXXL	40

EN T-shirt
PL Koszulka
DE T-Shirt
RU Фyтбoлka
CZ Tričko
HU Póló
RO Tricou
FR Tee-shirt
IT T-shirt
ES Camiseta
CN T恤衫



95% cotton, 5% elastane
95% bawełna, 5% elastan

TALL



YATO 	Size / Rozmiar	
YT-78438	S	40
YT-78439	M	40
YT-78440	L	40
YT-78441	XL	40
YT-78442	XXL	40
YT-78443	XXXL	40

EN T-shirt
PL Koszulka
DE T-Shirt
RU Фyтбoлka
CZ Tričko
HU Póló
RO Tricou
FR Tee-shirt
IT T-shirt
ES Camiseta
CN T恤衫



95% cotton, 5% elastane
95% bawełna, 5% elastan

TALL



YATO 	Size / Rozmiar	
YT-78444	S	40
YT-78445	M	40
YT-78446	L	40
YT-78447	XL	40
YT-78448	XXL	40
YT-78449	XXXL	40

EN T-shirt
PL Koszulka
DE T-Shirt
RU Фyтбoлka
CZ Tričko
HU Póló
RO Tricou
FR Tee-shirt
IT T-shirt
ES Camiseta
CN T恤衫



90% cotton, 5% elastane, 5% viscose
90% bawełna, 5% elastan, 5% wiskoza

TALL



YATO 	Size / Rozmiar	
YT-78450	S	40
YT-78451	M	40
YT-78452	L	40
YT-78453	XL	40
YT-78454	XXL	40
YT-78455	XXXL	40

EN Polo shirt
 PL Koszulka polo
 DE Polo-Shirt
 RU Футболка (рубашка) поло
 CZ Polokošile
 HU Galléros póló
 RO Tricou polo
 FR Polo
 IT Maglietta polo
 ES Polo
 CN Polo衫



100% cotton
 100% bawełna

SOFT



YATO 	Size / Rozmiar	
YT-78600	S	40
YT-78601	M	40
YT-78602	L	40
YT-78603	XL	40
YT-78604	XXL	40
YT-78605	XXXL	40

EN Polo shirt
 PL Koszulka polo
 DE Polo-Shirt
 RU Футболка (рубашка) поло
 CZ Polokošile
 HU Galléros póló
 RO Tricou polo
 FR Polo
 IT Maglietta polo
 ES Polo
 CN Polo衫



100% cotton
 100% bawełna

SOFT

YATO 	Size / Rozmiar	
YT-78606	S	40
YT-78607	M	40
YT-78608	L	40
YT-78609	XL	40
YT-78610	XXL	40
YT-78611	XXXL	40

EN Polo shirt
 PL Koszulka polo
 DE Polo-Shirt
 RU Футболка (рубашка) поло
 CZ Polokošile
 HU Galléros póló
 RO Tricou polo
 FR Polo
 IT Maglietta polo
 ES Polo
 CN Polo衫



100% cotton
 100% bawełna

SOFT



YATO 	Size / Rozmiar	
YT-78612	S	40
YT-78613	M	40
YT-78614	L	40
YT-78615	XL	40
YT-78616	XXL	40
YT-78617	XXXL	40

EN Polo shirt
 PL Koszulka polo
 DE Polo-Shirt
 RU Футболка (рубашка) поло
 CZ Polokošile
 HU Galléros póló
 RO Tricou polo
 FR Polo
 IT Maglietta polo
 ES Polo
 CN Polo衫



100% cotton
 100% bawełna

SOFT



YATO 	Size / Rozmiar	
YT-78618	S	40
YT-78619	M	40
YT-78620	L	40
YT-78621	XL	40
YT-78622	XXL	40
YT-78623	XXXL	40

EN Polo shirt
 PL Koszulka polo
 DE Polo-Shirt
 RU Футболка (рубашка) поло
 CZ Polokošile
 HU Galléros póló
 RO Tricou polo
 FR Polo
 IT Maglietta polo
 ES Polo
 CN Polo衫



100% cotton
 100% bawełna

SOFT



YATO 	Size / Rozmiar	
YT-78624	S	40
YT-78625	M	40
YT-78626	L	40
YT-78627	XL	40
YT-78628	XXL	40
YT-78629	XXXL	40

EN Polo shirt
 PL Koszulka polo
 DE Polo-Shirt
 RU Футболка (рубашка) поло
 CZ Polokošile
 HU Galléros póló
 RO Tricou polo
 FR Polo
 IT Maglietta polo
 ES Polo
 CN Polo衫



95% cotton, 5% viscose
 95% bawełna, 5% wiskoza

SOFT

YATO 	Size / Rozmiar	
YT-78630	S	40
YT-78631	M	40
YT-78632	L	40
YT-78633	XL	40
YT-78634	XXL	40
YT-78635	XXXL	40

EN Long sleeve T-shirt
PL Koszulka z długim rękawem
DE Langarm-Shirt
RU Футболка с длинным рукавом
CZ Tričko s dlouhým rukávem
HU Hosszú ujjú póló
RO Tricou cu maneca lunga
FR Tee-shirt à manches longues
IT T-shirt a manica lunga
ES Camiseta de manga larga
CN 长袖T恤



220
g/m²



100% cotton
100% bawełna

LONGSLEEVES

YATO	Size / Rozmiar	
YT-78830	S	40
YT-78831	M	40
YT-78832	L	40
YT-78833	XL	40
YT-78834	XXL	40
YT-78835	XXXL	40

EN Flannel shirt
PL Koszulka flanelowa
DE Flannelhemd
RU Фланелевая рубашка
CZ Flanelová košile
HU Flanel ing
RO Cămașă de flanel
FR Chemise de flanelle
IT Camicia in flanela
ES Camisa de franela
CN 棉绒衬衫



170
g/m²



100% cotton
100% bawełna

FLANNEL

YATO	Size / Rozmiar	
YT-78800	S	40
YT-78801	M	40
YT-78802	L	40
YT-78803	XL	40
YT-78804	XXL	40
YT-78805	XXXL	40

EN Flannel shirt
PL Koszulka flanelowa
DE Flannelhemd
RU Фланелевая рубашка
CZ Flanelová košile
HU Flanel ing
RO Cămașă de flanel
FR Chemise de flanelle
IT Camicia in flanela
ES Camisa de franela
CN 棉绒衬衫



170
g/m²



100% cotton
100% bawełna

FLANNEL

YATO	Size / Rozmiar	
YT-78806	S	40
YT-78807	M	40
YT-78808	L	40
YT-78809	XL	40
YT-78810	XXL	40
YT-78811	XXXL	40

EN Flannel shirt
PL Koszulka flanelowa
DE Flannelhemd
RU Фланелевая рубашка
CZ Flanelová košile
HU Flanel ing
RO Cămașă de flanel
FR Chemise de flanelle
IT Camicia in flanela
ES Camisa de franela
CN 棉绒衬衫



170
g/m²



100% cotton
100% bawełna

FLANNEL

YATO	Size / Rozmiar	
YT-78812	S	40
YT-78813	M	40
YT-78814	L	40
YT-78815	XL	40
YT-78816	XXL	40
YT-78817	XXXL	40

EN Softshell jacket
PL Kurtka softshell
DE Softshelljacke
RU Softshell куртка
CZ Softshellová bunda
HU Softshell dzseki
RO Jacheta softshell
FR Veste softshell
IT Giacca softshell
ES Chaqueta softshell
CN 冲锋衣



320
g/m²



96% polyester, 4% spandex
96% poliester, 4% spandex



OBSIDIAN

YATO	Size / Rozmiar	
YT-79550	S	10
YT-79551	M	10
YT-79552	L	10
YT-79553	XL	10
YT-79554	XXL	10
YT-79555	XXXL	10

EN Softshell jacket
PL Kurtka softshell
DE Softshelljacke
RU Softshell куртка
CZ Softshellová bunda
HU Softshell dzseki
RO Jacheta softshell
FR Veste softshell
IT Giacca softshell
ES Chaqueta softshell
CN 冲锋衣



320
g/m²



96% polyester, 4% spandex
96% poliester, 4% spandex



STRATUS

YATO	Size / Rozmiar	
YT-79560	S	10
YT-79561	M	10
YT-79562	L	10
YT-79563	XL	10
YT-79564	XXL	10
YT-79565	XXXL	10

EN Softshell jacket
 PL Kurtka softshell
 DE Softshelljacke
 RU Softshell куртка
 CZ Softshellová bunda
 HU Softshell dzseki
 RO Jacheta softshell
 FR Veste softshell
 IT Giacca softshell
 ES Chaqueta softshell
 CN 冲锋衣



96% polyester, 4% spandex
 96% poliester, 4% spandex



320 g/m² SOFTSHELL

TPU LAMINATED LAMINOWANIE

8000 mm

3000 g/m²

3 POCKETS / KESZENE

2 PVC

NIMBOSTRATUS

YATO	Size / Rozmiar	
YT-79540	S	10
YT-79541	M	10
YT-79542	L	10
YT-79543	XL	10
YT-79544	XXL	10
YT-79545	XXXL	10

EN Hoodie
 PL Bluza z kapturem
 DE Kapuzenpullover
 RU Толстовка с капюшоном
 CZ Mikina s kapucí
 HU Kapucnis melegítő felső
 RO Hanorac cu gluga
 FR Blouson à capuche
 IT Felpa con cappuccio
 ES Sudadera con capucha
 CN 连帽卫衣



80% cotton, 20% polyester
 80% baweina, 20% poliester



300 g/m²

3 POCKETS / KESZENE

2 PVC

LABRADOR

YATO	Size / Rozmiar	
YT-79210	S	20
YT-79211	M	20
YT-79212	L	20
YT-79213	XL	20
YT-79214	XXL	20

EN Hoodie
 PL Bluza z kapturem
 DE Kapuzenpullover
 RU Толстовка с капюшоном
 CZ Mikina s kapucí
 HU Kapucnis melegítő felső
 RO Hanorac cu gluga
 FR Blouson à capuche
 IT Felpa con cappuccio
 ES Sudadera con capucha
 CN 连帽卫衣



80% cotton, 20% polyester
 80% baweina, 20% poliester



300 g/m²

2 POCKETS / KESZENE

2 PVC

ROTTWEILER

YATO	Size / Rozmiar	
YT-79215	S	20
YT-79216	M	20
YT-79217	L	20
YT-79218	XL	20
YT-79219	XXL	20

EN Hoodie
 PL Bluza z kapturem
 DE Kapuzenpullover
 RU Толстовка с капюшоном
 CZ Mikina s kapucí
 HU Kapucnis melegítő felső
 RO Hanorac cu gluga
 FR Blouson à capuche
 IT Felpa con cappuccio
 ES Sudadera con capucha
 CN 连帽卫衣



80% cotton, 20% polyester
 80% baweina, 20% poliester



300 g/m²

2 POCKETS / KESZENE

2 PVC

MORO

YATO	Size / Rozmiar	
YT-79220	S	20
YT-79221	M	20
YT-79222	L	20
YT-79223	XL	20
YT-79224	XXL	20

EN Fleece jacket
 PL Bluza polarowa
 DE Fleecejacke
 RU Толстовка флисовая
 CZ Fleeceová mikina
 HU Fleece dzseki
 RO Jachetă polar
 FR Veste polaire
 IT Felpa in pile
 ES Chaqueta polar
 CN 摇粒绒夹克



100% polyester
 100% poliester



280 g/m²

3 POCKETS / KESZENE

2 PVC

SOFT ROSE

YATO	Size / Rozmiar	
YT-79200	S	10
YT-79201	M	10
YT-79202	L	10
YT-79203	XL	10
YT-79204	XXL	10
YT-79205	XXXL	10

EN Fleece jacket
 PL Bluza polarowa
 DE Fleecejacke
 RU Толстовка флисовая
 CZ Fleeceová mikina
 HU Fleece dzseki
 RO Jachetă polar
 FR Veste polaire
 IT Felpa in pile
 ES Chaqueta polar
 CN 摇粒绒夹克



100% polyester
 100% poliester



420 g/m²

3 POCKETS / KESZENE

MAX HEAVY

YATO	Size / Rozmiar	
YT-79520	S	10
YT-79521	M	10
YT-79522	L	10
YT-79523	XL	10
YT-79524	XXL	10
YT-79525	XXXL	10

EN Working jacket
PL Bluza robocza
DE Arbeitsjacke
RU Рабочая рубашка
CZ Pracovní blůza
HU Munkaruha felső
RO Bluză de lucru
FR Blouson de travail
IT Felpa da lavoro
ES Blusa de trabajo
CN 工作服

65% polyester, 35% cotton
65% poliester, 35% bawełna

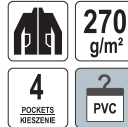

DAV

YATO	Size / Rozmiar	
YT-80280	S	10
YT-80281	M	10
YT-80282	L	10
YT-80283	XL	10
YT-80284	XXL	10

EN Working jacket
PL Bluza robocza
DE Arbeitsjacke
RU Рабочая рубашка
CZ Pracovní blůza
HU Munkaruha felső
RO Bluză de lucru
FR Blouson de travail
IT Felpa da lavoro
ES Blusa de trabajo
CN 工作服

65% polyester, 35% cotton
65% poliester, 35% bawełna

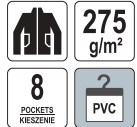

DUERO

YATO	Size / Rozmiar	
YT-8020	S	20
YT-8021	M	10
YT-8022	L	10
YT-8023	XL	10
YT-8024	XXL	10

EN Working jacket
PL Bluza robocza
DE Arbeitsjacke
RU Рабочая рубашка
CZ Pracovní blůza
HU Munkaruha felső
RO Bluză de lucru
FR Blouson de travail
IT Felpa da lavoro
ES Blusa de trabajo
CN 劳保夹克

65% polyester, 35% cotton
65% poliester, 35% bawełna

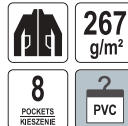

BASALT

YATO	Size / Rozmiar	
YT-80140	S	10
YT-80141	M	10
YT-80142	L	10
YT-80143	L/XL	10
YT-80144	XL	10
YT-80145	XXL	10

EN Work jacket
PL Bluza robocza
DE Arbeitsjacke
RU Рабочая рубашка
CZ Pracovní blůza
HU Munkaruha felső
RO Bluză de lucru
FR Blouson de travail
IT Felpa da lavoro
ES Blusa de trabajo
CN 劳保夹克

100% brushed cotton
100% szczotkowana bawełna

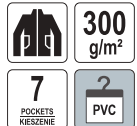

COMFY

YATO	Size / Rozmiar	
YT-79230	S	10
YT-79231	M	10
YT-79232	L	10
YT-79233	L/XL	10
YT-79234	XL	10
YT-79235	XXL	10

EN Working jacket
PL Bluza robocza
DE Arbeitsjacke
RU Рабочая рубашка
CZ Pracovní blůza
HU Munkaruha felső
RO Bluză de lucru
FR Blouson de travail
IT Felpa da lavoro
ES Blusa de trabajo
CN 劳保夹克

100% cotton
100% bawełna

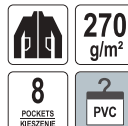

PALEA

YATO	Size / Rozmiar	
YT-80158	S	10
YT-80159	M	10
YT-80160	L	10
YT-80161	L/XL	10
YT-80162	XL	10
YT-80163	XXL	10

EN Working jacket
PL Bluza robocza
DE Arbeitsjacke
RU Рабочая рубашка
CZ Pracovní blůza
HU Munkaruha felső
RO Bluză de lucru
FR Blouson de travail
IT Felpa da lavoro
ES Blusa de trabajo
CN 劳保夹克

65% polyester, 35% cotton
65% poliester, 35% bawełna

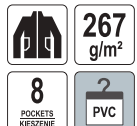

PEGMA

YATO	Size / Rozmiar	
YT-80176	S	10
YT-80177	M	10
YT-80178	L	10
YT-80179	L/XL	10
YT-80180	XL	10
YT-80181	XXL	10

EN Working jacket
 PL Bluza robocza
 DE Arbeitsjacke
 RU Рабочая рубашка
 CZ Pracovní blůza
 HU Munkaruha felső
 RO Bluză de lucru
 FR Blouson de travail
 IT Felpa da lavoro
 ES Blusa de trabajo
 CN 劳保夹克



245
g/m²
 5
POCKETS
KIESZENÉ
 2
PVC

65% polyester, 35% cotton
 65% poliester, 35% bawełna



DORIA

YATO	Size / Rozmiar	
YT-80395	S	10
YT-80396	M	10
YT-80397	L	10
YT-80398	L/XL	10
YT-80399	XL	10
YT-80400	XXL	10

EN Working shorts
 PL Spodnie robocze krótkie
 DE Kurze Arbeitshose
 RU Рабочие шорты
 CZ Pracovní šortky
 HU Munkaruha rövid nadrág
 RO Pantaloni scurți de lucru
 FR Pantalon de travail court
 IT Pantaloni da lavoro corti
 ES Pantalónes cortos de trabajo
 CN 工装短裤



245
g/m²
 7
POCKETS
KIESZENÉ
 2
PVC

65% polyester, 35% cotton
 65% poliester, 35% bawełna



DORIA

YATO	Size / Rozmiar	
YT-80924	S	10
YT-80925	M	10
YT-80926	L	10
YT-80927	L/XL	10
YT-80928	XL	10
YT-80929	XXL	10

EN Working shorts
 PL Spodnie robocze krótkie
 DE Kurze Arbeitshose
 RU Рабочие шорты
 CZ Pracovní šortky
 HU Munkaruha rövid nadrág
 RO Pantaloni scurți de lucru
 FR Pantalon de travail court
 IT Pantaloni da lavoro corti
 ES Pantalónes cortos de trabajo
 CN 工装短裤



245
g/m²
 10
POCKETS
KIESZENÉ
 2
PVC

100% cotton
 100% bawełna



DIM

YATO	Size / Rozmiar	
YT-80936	S	10
YT-80937	M	10
YT-80938	L	10
YT-80939	L/XL	10
YT-80940	XL	10
YT-80941	XXL	10

EN Working jacket
 PL Bluza robocza
 DE Arbeitsjacke
 RU Рабочая рубашка
 CZ Pracovní blůza
 HU Munkaruha felső
 RO Bluză de lucru
 FR Blouson de travail
 IT Felpa da lavoro
 ES Blusa de trabajo
 CN 劳保夹克



190
g/m²
 8
POCKETS
KIESZENÉ
 2
PVC

65% polyester, 35% cotton
 65% poliester, 35% bawełna



ANDESITE

YATO	Size / Rozmiar	
YT-80900	S	10
YT-80901	M	10
YT-80902	L	10
YT-80903	L/XL	10
YT-80904	XL	10
YT-80905	XXL	10

EN Working shorts
 PL Spodnie robocze krótkie
 DE Kurze Arbeitshose
 RU Рабочие шорты
 CZ Pracovní šortky
 HU Munkaruha rövid nadrág
 RO Pantaloni scurți de lucru
 FR Pantalon de travail court
 IT Pantaloni da lavoro corti
 ES Pantalónes cortos de trabajo
 CN 工装短裤



245
g/m²
 10
POCKETS
KIESZENÉ
 2
PVC

100% cotton
 100% bawełna



ASH

YATO	Size / Rozmiar	
YT-80930	S	10
YT-80931	M	10
YT-80932	L	10
YT-80933	L/XL	10
YT-80934	XL	10
YT-80935	XXL	10

EN Working trousers
 PL Spodnie robocze
 DE Arbeitshose
 RU Рабочие брюки
 CZ Pracovní kalhoty
 HU Munkaruha nadrág
 RO Pantaloni de lucru
 FR Pantalon de travail
 IT Pantaloni da lavoro
 ES Pantalón de trabajo
 CN 工作裤



350
g/m²
 4
POCKETS
KIESZENÉ
 2
PVC

52% polyester, 41% cotton, 7% spandex
 52% poliester, 41% bawełna, 7% spandex



IDONEUS

YATO	Size / Rozmiar	
YT-79040	S	20
YT-79041	M	20
YT-79042	L	20
YT-79043	XL	20
YT-79044	XXL	20
YT-79045	XXXL	20



EN Working trousers
PL Spodnie robocze
DE Arbeitshose
RU Рабочие брюки
CZ Pracovní kalhoty
HU Munkaruha nadrág
RO Pantaloni de lucru
FR Pantalon de travail
IT Pantalone da lavoro
ES Pantalón de trabajo
CN 工作裤



Main fabric: 65% polyester,
35% cotton; inserts fabric:
94% polyamide, 6% elastane
Materiał główny: 65% poliester,
35% bawełna; materiał wstawek:
94% poliamid, 6% elastan

SERWAL



YATO 	Size / Rozmiar	
YT-79090	S	10
YT-79091	M	10
YT-79092	L	10
YT-79093	XL	10
YT-79094	XXL	10
YT-79095	XXXL	10



EN Working trousers
PL Spodnie robocze
DE Arbeitshose
RU Рабочие брюки
CZ Pracovní kalhoty
HU Munkaruha nadrág
RO Pantaloni de lucru
FR Pantalon de travail
IT Pantalone da lavoro
ES Pantalón de trabajo
CN 工作裤



Main fabric: 65% polyester,
35% cotton; inserts fabric:
94% polyamide, 6% elastane
Materiał główny: 65% poliester,
35% bawełna; materiał wstawek:
94% poliamid, 6% elastan

SERWAL



YATO 	Size / Rozmiar	
YT-79100	S	10
YT-79101	M	10
YT-79102	L	10
YT-79103	XL	10
YT-79104	XXL	10
YT-79105	XXXL	10



EN Working trousers
PL Spodnie robocze
DE Arbeitshose
RU Рабочие брюки
CZ Pracovní kalhoty
HU Munkaruha nadrág
RO Pantaloni de lucru
FR Pantalon de travail
IT Pantalone da lavoro
ES Pantalón de trabajo
CN 工作裤



Main fabric: 65% polyester,
35% cotton; inserts fabric:
94% polyamide, 6% elastane
Materiał główny: 65% poliester,
35% bawełna; materiał wstawek:
94% poliamid, 6% elastan

SERWAL



YATO 	Size / Rozmiar	
YT-79110	S	10
YT-79111	M	10
YT-79112	L	10
YT-79113	XL	10
YT-79114	XXL	10
YT-79115	XXXL	10



EN Working trousers
PL Spodnie robocze
DE Arbeitshose
RU Рабочие брюки
CZ Pracovní kalhoty
HU Munkaruha nadrág
RO Pantaloni de lucru
FR Pantalon de travail
IT Pantalone da lavoro
ES Pantalón de trabajo
CN 工作裤



Main fabric: 65% polyester,
35% cotton; inserts fabric:
94% polyamide, 6% elastane
Materiał główny: 65% poliester,
35% bawełna; materiał wstawek:
94% poliamid, 6% elastan

SERWAL



YATO 	Size / Rozmiar	
YT-79120	S	10
YT-79121	M	10
YT-79122	L	10
YT-79123	XL	10
YT-79124	XXL	10
YT-79125	XXXL	10



EN Working trousers
PL Spodnie robocze
DE Arbeitshose
RU Рабочие брюки
CZ Pracovní kalhoty
HU Munkaruha nadrág
RO Pantaloni de lucru
FR Pantalon de travail
IT Pantalone da lavoro
ES Pantalón de trabajo
CN 工作裤



Main fabric: 65% polyester,
35% cotton; inserts fabric:
94% polyamide, 6% elastane
Materiał główny: 65% poliester,
35% bawełna; materiał wstawek:
94% poliamid, 6% elastan

SERWAL



YATO 	Size / Rozmiar	
YT-79130	S	10
YT-79131	M	10
YT-79132	L	10
YT-79133	XL	10
YT-79134	XXL	10
YT-79135	XXXL	10



EN Working trousers
PL Spodnie robocze
DE Arbeitshose
RU Рабочие брюки
CZ Pracovní kalhoty
HU Munkaruha nadrág
RO Pantaloni de lucru
FR Pantalon de travail
IT Pantalone da lavoro
ES Pantalón de trabajo
CN 工作裤



Main fabric: 65% polyester,
35% cotton; inserts fabric:
94% polyamide, 6% elastane
Materiał główny: 65% poliester,
35% bawełna; materiał wstawek:
94% poliamid, 6% elastan

SERWAL



YATO 	Size / Rozmiar	
YT-79140	S	10
YT-79141	M	10
YT-79142	L	10
YT-79143	XL	10
YT-79144	XXL	10
YT-79145	XXXL	10

EN Working trousers
 PL Spodnie robocze
 DE Arbeitshose
 RU Рабочие брюки
 CZ Pracovní kalhoty
 HU Munkaruha nadrág
 RO Pantaloni de lucru
 FR Pantalon de travail
 IT Pantalone da lavoro
 ES Pantalón de trabajo
 CN 工作裤



325 g/m²
17
 POKETS
 KIESZENE
SPANDEX
2
 PVC



71% cotton, 25.5% polyester, 2% viscose, 1.5% spandex
 71% bawełna, 25.5% poliester, 2% wiskoza, 1.5% spandex

YATO	Size / Rozmiar	
YT-79070	S	10
YT-79071	M	10
YT-79072	L	10
YT-79073	L/XL	10
YT-79074	XL	10
YT-79075	XXL	10

EN Working trousers
 PL Spodnie robocze
 DE Arbeitshose
 RU Рабочие брюки
 CZ Pracovní kalhoty
 HU Munkaruha nadrág
 RO Pantaloni de lucru
 FR Pantalon de travail
 IT Pantalone da lavoro
 ES Pantalón de trabajo
 CN 工作裤



325 g/m²
SPANDEX
17
 POKETS
 KIESZENE
2
 PVC



71% cotton, 25.5% polyester, 2% viscose, 1.5% spandex
 71% bawełna, 25.5% poliester, 2% wiskoza, 1.5% spandex

YATO	Size / Rozmiar	
YT-79060	S	10
YT-79061	M	10
YT-79062	L	10
YT-79063	L/XL	10
YT-79064	XL	10
YT-79065	XXL	10

EN Working trousers
 PL Spodnie robocze
 DE Arbeitshose
 RU Рабочие брюки
 CZ Pracovní kalhoty
 HU Munkaruha nadrág
 RO Pantaloni de lucru
 FR Pantalon de travail
 IT Pantalone da lavoro
 ES Pantalón de trabajo
 CN 工作裤



300 g/m²
14
 POKETS
 KIESZENE
SPANDEX
2
 PVC



97% cotton, 3% spandex
 97% bawełna, 3% spandex

YATO	Size / Rozmiar	
YT-79360	S	10
YT-79361	M	10
YT-79362	L	10
YT-79363	L/XL	10
YT-79364	XL	10
YT-79365	XXL	10

REBAR

EN Working trousers
 PL Spodnie robocze
 DE Arbeitshose
 RU Рабочие брюки
 CZ Pracovní kalhoty
 HU Munkaruha nadrág
 RO Pantaloni de lucru
 FR Pantalon de travail
 IT Pantalone da lavoro
 ES Pantalón de trabajo
 CN 工作裤



325 g/m²
17
 POKETS
 KIESZENE
SPANDEX
2
 PVC



71% cotton, 25.5% polyester, 2% viscose, 1.5% spandex
 71% bawełna, 25.5% poliester, 2% wiskoza, 1.5% spandex

YATO	Size / Rozmiar	
YT-79050	S	10
YT-79051	M	10
YT-79052	L	10
YT-79053	L/XL	10
YT-79054	XL	10
YT-79055	XXL	10

EN Working trousers
 PL Spodnie robocze
 DE Arbeitshose
 RU Рабочие брюки
 CZ Pracovní kalhoty
 HU Munkaruha nadrág
 RO Pantaloni de lucru
 FR Pantalon de travail
 IT Pantalone da lavoro
 ES Pantalón de trabajo
 CN 工作裤



450 g/m²
10
 POKETS
 KIESZENE
SPANDEX
2
 PVC



72% cotton, 25% polyester, 3% spandex
 72% bawełna, 25% poliester, 3% spandex

YATO	Size / Rozmiar	
YT-79080	S	10
YT-79081	M	10
YT-79082	L	10
YT-79083	XL	10
YT-79084	XXL	10
YT-79085	XXXL	10

MARA

EN Stretch work trousers
 PL Spodnie z elastanem
 DE Hose mit Elasthan
 RU Брюки с эластаном
 CZ Kalhoty s elastanem
 HU Elasztános nadrág
 RO Pantaloni de lucru cu elasthan
 FR Pantalon élasthane
 IT Pantaloni con elastan
 ES Pantalones con elastano
 CN 冲锋裤



240 g/m²
9
 POKETS
 KIESZENE
STRETCH STRECCZ
2
 PVC



64% polyester, 34% cotton, 2% elastane
 64% poliester, 34% bawełna, 2% elastan

YATO	Size / Rozmiar	
YT-79440	S	10
YT-79441	M	10
YT-79442	L	10
YT-79443	XL	10
YT-79444	XXL	10
YT-79445	XXXL	10

ONYX

EN Working trousers
PL Spodnie robocze
DE Arbeitshose
RU Рабочие брюки
CZ Pracovní kalhoty
HU Munkaruha nadrág
RO Pantaloni de lucru
FR Pantalon de travail
IT Pantalone da lavoro
ES Pantalón de trabajo
CN 工作裤



275
g/m²



65% polyester, 35% cotton
65% poliester, 35% bawełna



DUERO

YATO	Size / Rozmiar	
YT-8025	S	10
YT-8026	M	10
YT-8027	L	20
YT-8028	XL	10
YT-8029	XXL	10

EN Working trousers
PL Spodnie robocze
DE Arbeitshose
RU Рабочие брюки
CZ Pracovní kalhoty
HU Munkaruha nadrág
RO Pantaloni de lucru
FR Pantalon de travail
IT Pantalone da lavoro
ES Pantalón de trabajo
CN 工作裤



270
g/m²



65% polyester, 35% cotton
65% poliester, 35% bawełna



DAN

YATO	Size / Rozmiar	
YT-80285	S	10
YT-80286	M	10
YT-80287	L	10
YT-80288	XL	10
YT-80289	XXL	10

EN Working trousers
PL Spodnie robocze
DE Arbeitshose
RU Рабочие брюки
CZ Pracovní kalhoty
HU Munkaruha nadrág
RO Pantaloni de lucru
FR Pantalon de travail
IT Pantalone da lavoro
ES Pantalón de trabajo
CN 工作裤



267
g/m²



65% polyester, 35% cotton
65% poliester, 35% bawełna



BASALT

YATO	Size / Rozmiar	
YT-80146	S	10
YT-80147	M	10
YT-80148	L	10
YT-80149	L/XL	10
YT-80150	XL	10
YT-80151	XXL	10

EN Working trousers
PL Spodnie robocze
DE Arbeitshose
RU Рабочие брюки
CZ Pracovní kalhoty
HU Munkaruha nadrág
RO Pantaloni de lucru
FR Pantalon de travail
IT Pantalone da lavoro
ES Pantalón de trabajo
CN 工作裤



300
g/m²



100% brushed cotton
100% szczotkowana bawełna



COMFY

YATO	Size / Rozmiar	
YT-79240	S	10
YT-79241	M	10
YT-79242	L	10
YT-79243	L/XL	10
YT-79244	XL	10
YT-79245	XXL	10

EN Working trousers
PL Spodnie robocze
DE Arbeitshose
RU Рабочие брюки
CZ Pracovní kalhoty
HU Munkaruha nadrág
RO Pantaloni de lucru
FR Pantalon de travail
IT Pantalone da lavoro
ES Pantalón de trabajo
CN 工作裤

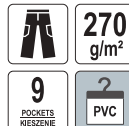

270
g/m²



100% cotton
100% bawełna



PALEA

YATO	Size / Rozmiar	
YT-80164	S	10
YT-80165	M	10
YT-80166	L	10
YT-80167	L/XL	10
YT-80168	XL	10
YT-80169	XXL	10

EN Working trousers
PL Spodnie robocze
DE Arbeitshose
RU Рабочие брюки
CZ Pracovní kalhoty
HU Munkaruha nadrág
RO Pantaloni de lucru
FR Pantalon de travail
IT Pantalone da lavoro
ES Pantalón de trabajo
CN 工作裤



267
g/m²



65% polyester, 35% cotton
65% poliester, 35% bawełna



PEGMA

YATO	Size / Rozmiar	
YT-80182	S	10
YT-80183	M	10
YT-80184	L	10
YT-80185	L/XL	10
YT-80186	XL	10
YT-80187	XXL	10

EN Working trousers
 PL Spodnie robocze
 DE Arbeitshose
 RU Рабочие брюки
 CZ Pracovní kalhoty
 HU Munkaruha nadrág
 RO Pantaloni de lucru
 FR Pantalon de travail
 IT Pantalone da lavoro
 ES Pantalón de trabajo
 CN 工作裤

245
g/m²

5
POCKETS
KIESZENIE

2
PVC



65% polyester, 35% cotton
 65% poliester, 35% baweina



DORIA

YATO	Size / Rozmiar	
YT-80401	S	10
YT-80402	M	10
YT-80403	L	10
YT-80404	L/XL	10
YT-80405	XL	10
YT-80406	XXL	10

EN Working trousers
 PL Spodnie robocze
 DE Arbeitshose
 RU Рабочие брюки
 CZ Pracovní kalhoty
 HU Munkaruha nadrág
 RO Pantaloni de lucru
 FR Pantalon de travail
 IT Pantalone da lavoro
 ES Pantalón de trabajo
 CN 工作裤

190
g/m²

9
POCKETS
KIESZENIE

2
PVC



65% polyester, 35% cotton
 65% poliester, 35% baweina



ANDESITE

YATO	Size / Rozmiar	
YT-80906	S	10
YT-80907	M	10
YT-80908	L	10
YT-80909	L/XL	10
YT-80910	XL	10
YT-80911	XXL	10

EN Reflective winter trousers with padding
 PL Spodnie robocze ocieplane, odblaskowe
 DE Warme Warnschutzhose mit Reflektionsstreifen
 RU Утепленные рабочие светоотражающие брюки
 CZ Oteplené pracovní kalhoty reflexní
 HU Bélelt fényvisszaverő munkanadrág
 RO Pantaloni impermeabili reflectorizanti pt. iarnă
 FR Pantalon de travail isolant et réfléchissant
 IT Pantaloni da lavoro imbottiti, ad alta visibilità
 ES Pantalones acolchados de trabajo, reflectantes
 CN 荧光棉长裤

400
g/m²

PU
COATING
POWLOKA

5000 mm

5000 g/m²

6
POCKETS
KIESZENIE



100% polyester
 100% poliester

YATO	Size / Rozmiar	
YT-80955	S	10
YT-80956	M	10
YT-80957	L	10
YT-80958	XL	10
YT-80959	XXL	10

EN Work bib pants
 PL Spodnie robocze ogrodniczki
 DE Arbeitshose
 RU Рабочий полукombineзон
 CZ Pracovní kalhoty lačové
 HU Kertész nadrág
 RO Pantaloni de lucru cu pieptar
 FR Salopette de travail
 IT Salopette da lavoro
 ES Pantalón de trabajo tipo jardinero
 CN 工作服

275
g/m²

11
POCKETS
KIESZENIE

2
PVC



65% polyester, 35% cotton
 65% poliester, 35% baweina



DUERO

YATO	Size / Rozmiar	
YT-8030	S	10
YT-8031	M	10
YT-8032	L	10
YT-8033	XL	10
YT-8034	XXL	10

EN Work bib pants
PL Spodnie robocze ogrodniczki
DE Arbeitsslatzhose
RU Рабочий полукombineзон
CZ Pracovní kalhoty lačlové
HU Kertész nadrág
RO Pantaloni de lucru cu pieptar
FR Salopette de travail
IT Salopette da lavoro
ES Pantalón de trabajo tipo jardinero
CN 背带裤



65% polyester, 35% cotton
65% polyester, 35% bawełna



DAW

YATO	Size / Rozmiar	
YT-80290	S	10
YT-80291	M	10
YT-80292	L	10
YT-80293	XL	10
YT-80294	XXL	10

EN Work bib pants
PL Spodnie robocze ogrodniczki
DE Arbeitsslatzhose
RU Рабочий полукombineзон
CZ Pracovní kalhoty lačlové
HU Kertész nadrág
RO Pantaloni de lucru cu pieptar
FR Salopette de travail
IT Salopette da lavoro
ES Pantalón de trabajo tipo jardinero
CN 背带裤



65% polyester, 35% cotton
65% polyester, 35% bawełna



BASALT

YATO	Size / Rozmiar	
YT-80152	S	10
YT-80153	M	10
YT-80154	L	10
YT-80155	L/XL	10
YT-80156	XL	10
YT-80157	XXL	10

EN Work bib pants
PL Spodnie robocze ogrodniczki
DE Arbeitsslatzhose
RU Рабочий полукombineзон
CZ Pracovní kalhoty lačlové
HU Kertész nadrág
RO Pantaloni de lucru cu pieptar
FR Salopette de travail
IT Salopette da lavoro
ES Pantalón de trabajo tipo jardinero
CN 背带裤

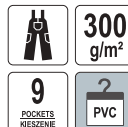

100% brushed cotton
100% szczotkowana bawełna



COMFY

YATO	Size / Rozmiar	
YT-79250	S	10
YT-79251	M	10
YT-79252	L	10
YT-79253	L/XL	10
YT-79254	XL	10
YT-79255	XXL	10

EN Work bib pants
PL Spodnie robocze ogrodniczki
DE Arbeitsslatzhose
RU Рабочий полукombineзон
CZ Pracovní kalhoty lačlové
HU Kertész nadrág
RO Pantaloni de lucru cu pieptar
FR Salopette de travail
IT Salopette da lavoro
ES Pantalón de trabajo tipo jardinero
CN 背带裤

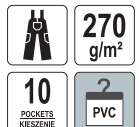

100% cotton
100% bawełna



PALEA

YATO	Size / Rozmiar	
YT-80170	S	10
YT-80171	M	10
YT-80172	L	10
YT-80173	L/XL	10
YT-80174	XL	10
YT-80175	XXL	10

EN Work bib pants
 PL Spodnie robocze ogrodniczki
 DE Arbeitsslatzhose
 RU Рабочий полукомбинезон
 CZ Pracovní kalhoty lačlové
 HU Kertész nadrág
 RO Pantaloni de lucru cu pieptar
 FR Salopette de travail
 IT Salopette da lavoro
 ES Pantalón de trabajo tipo jardinero
 CN 背带裤



 **267**
g/m²



11
POCKETS
KIESZENIE

 **2**
PVC

65% polyester, 35% cotton
 65% poliester, 35% bawełna



PEGMA

YATO 	Size / Rozmiar	
YT-80188	S	10
YT-80189	M	10
YT-80190	L	10
YT-80191	L/XL	10
YT-80192	XL	10
YT-80193	XXL	10

EN Work bib pants
 PL Spodnie robocze ogrodniczki
 DE Arbeitsslatzhose
 RU Рабочий полукомбинезон
 CZ Pracovní kalhoty lačlové
 HU Kertész nadrág
 RO Pantaloni de lucru cu pieptar
 FR Salopette de travail
 IT Salopette da lavoro
 ES Pantalón de trabajo tipo jardinero
 CN 背带裤



 **245**
g/m²



7
POCKETS
KIESZENIE

 **2**
PVC

65% polyester, 35% cotton
 65% poliester, 35% bawełna



DORIA

YATO 	Size / Rozmiar	
YT-80407	S	10
YT-80408	M	10
YT-80409	L	10
YT-80410	L/XL	10
YT-80411	XL	10
YT-80412	XXL	10

EN Work bib pants
 PL Spodnie robocze ogrodniczki
 DE Arbeitsslatzhose
 RU Рабочий полукомбинезон
 CZ Pracovní kalhoty lačlové
 HU Kertész nadrág
 RO Pantaloni de lucru cu pieptar
 FR Salopette de travail
 IT Salopette da lavoro
 ES Pantalón de trabajo tipo jardinero
 CN 背带裤



 **190**
g/m²



13
POCKETS
KIESZENIE

 **2**
PVC

65% polyester, 35% cotton
 65% poliester, 35% bawełna



ANDESITE

YATO 	Size / Rozmiar	
YT-80912	S	10
YT-80913	M	10
YT-80914	L	10
YT-80915	L/XL	10
YT-80916	XL	10
YT-80917	XXL	10

EN Rainsuit
 PL Zestaw przeciwdeszczowy
 DE Regenschutz-Set
 RU Противодождевой набор
 CZ Protidešťová sada
 HU Esővédő szett
 RO Costum impermeabil
 FR Kit anti pluie
 IT Tuta impermeabile
 ES Juego impermeable
 CN 男式雨衣套装



200
g/m²



PU
COATING
POWLOKA

3
POCKETS
KIESZENIE

 **2**
PVC

100% polyester
 100% poliester



YATO 	Size / Rozmiar	
YT-79710	S	10
YT-79711	M	10
YT-79712	L	10
YT-79713	XL	10
YT-79714	XXL	10
YT-79715	XXXL	10

Memo



21

Electric products Artykuły elektryczne



Ceiling & wall lamps
Oprawy sufitowe i ścienne

636



Flashlights
Latarki

645-650



Floodlights & accessories
Naświetlacze i akcesoria

636-640



Infrared heaters & accessories
Promienniki podczerwieni i akcesoria

650-651



Solar lamps
Oprawy solarne

640



Travel adapters
Adaptory podróżne

652



Workshop lightning
Oświetlenie warsztatowe

641-645



Extension cords
Przedłużacze elektryczne

652-653



EN Wall lamp
 PL Lampa naścienna
 DE Wandleuchte
 RU Светильник настенный
 CZ Nástěnné svítidlo
 HU Fali lámpa
 RO Lampă de perete
 FR Applique
 IT Lampada da parete
 ES Lámpara de pared
 CN 户外壁灯

220-240V~
50Hz

GU10
max. 35W

IP44



A++
A+
A

Outdoor lamp
 Lampa zewnętrzna

YATO
 YT-81900 20

EN Wall lamp
 PL Lampa naścienna
 DE Wandleuchte
 RU Светильник настенный
 CZ Nástěnné svítidlo
 HU Fali lámpa
 RO Lampă de perete
 FR Applique
 IT Lampada da parete
 ES Lámpara de pared
 CN 户外壁灯

220-240V~
50Hz

GU10
max. 35W

IP44



A++
A+
A

Outdoor lamp
 Lampa zewnętrzna

YATO
 YT-81901 20

EN Wall lamp
 PL Lampa naścienna
 DE Wandleuchte
 RU Светильник настенный
 CZ Nástěnné svítidlo
 HU Fali lámpa
 RO Lampă de perete
 FR Applique
 IT Lampada da parete
 ES Lámpara de pared
 CN 户外壁灯

220-240V~
50Hz

GU10
max. 2x35W

IP44



A++
A+
A

Outdoor lamp
 Lampa zewnętrzna

YATO
 YT-81902 12

EN Wall lamp
 PL Lampa naścienna
 DE Wandleuchte
 RU Светильник настенный
 CZ Nástěnné svítidlo
 HU Fali lámpa
 RO Lampă de perete
 FR Applique
 IT Lampada da parete
 ES Lámpara de pared
 CN 户外壁灯

220-240V~
50Hz

GU10
max. 2x35W

IP44



A++
A+
A

Outdoor lamp
 Lampa zewnętrzna

YATO
 YT-81903 12

EN Garden light with spike
 PL Reflektor ogrodowy ze szpikulcem
 DE Gartenleuchte mit Erdspiess
 RU Светильник садовый
 CZ Zahradní svítidlo
 HU Kerti tüske fényvető
 RO Lampă gradină cu pivot
 FR Lampe de jardin
 IT Lampada da giardino con punta
 ES Reflector de jardín
 CN 地插灯

220-240V~
50Hz

GU10
max. 35W

AI

IP54



Outdoor lamp
 Lampa zewnętrzna



A++
A+
A

YATO
 YT-81775 8

EN LED floodlight
 PL Reflektor LED
 DE LED-Arbeitsleuchte
 RU Светодиодный прожектор
 CZ LED reflektor
 HU Diódás reflektor
 RO Reflector LED
 FR Projecteur LED
 IT Riflettore LED
 ES Reflector LED
 CN LED投光灯

230V~
50/60Hz

10 W

950 lm

6500K

30000h

IP65



SMD
LED



E A ↑ G

YATO
 YT-818221 20

EN LED floodlight
 PL Reflektor LED
 DE LED-Arbeitsleuchte
 RU Светодиодный прожектор
 CZ LED reflektor
 HU Diódás reflektor
 RO Reflector LED
 FR Projecteur LED
 IT Riflettore LED
 ES Reflector LED
 CN LED投光灯

230V~
50/60Hz

20 W

1900 lm

6500K

30000h

IP65



SMD
LED



E A ↑ G

YATO
 YT-818231 16

EN LED floodlight
 PL Reflektor LED
 DE LED-Arbeitsleuchte
 RU Светодиодный прожектор
 CZ LED reflektor
 HU Diódás reflektor
 RO Reflector LED
 FR Projecteur LED
 IT Riflettore LED
 ES Reflector LED
 CN LED投光灯

230V~
50/60Hz

30 W

2850 lm

6500K

30000h

IP65



SMD
LED



E A ↑ G

YATO
 YT-818241 10

EN LED floodlight
 PL Reflektor LED
 DE LED-Arbeitsleuchte
 RU Светодиодный прожектор
 CZ LED reflektor
 HU Diódás reflektor
 RO Reflector LED
 FR Projecteur LED
 IT Riflettore LED
 ES Reflector LED
 CN LED投光灯

230V~
50/60Hz

50 W

4750 lm

6500K

30000h

IP65



SMD
LED



E A ↑ G

YATO
 YT-818251 8

EN LED floodlight with motion sensor
PL Reflektor LED z czujnikiem ruchu
DE LED-Leuchte mit Bewegungsmelder
RU Светодиодный прожектор с датчиком движения
CZ LED reflektor se snímačem pohybu
HU Diódás reflektor mozgásérzékelővel
RO Reflector LED cu senzor de mișcare
FR Projecteur LED avec détecteur de mouvement
IT Riflettore LED con sensore
ES Reflector de diodos con sensor de movimiento
CN 泛光灯

230V~50/60Hz
20 W
1900 lm
6500K
10±2m
30000h
IP54

SMD
LED



YATO
YT-818271 16

EN LED floodlight with motion sensor
PL Reflektor LED z czujnikiem ruchu
DE LED-Leuchte mit Bewegungsmelder
RU Светодиодный прожектор с датчиком движения
CZ LED reflektor se snímačem pohybu
HU Diódás reflektor mozgásérzékelővel
RO Reflector LED cu senzor de mișcare
FR Projecteur LED avec détecteur de mouvement
IT Riflettore LED con sensore
ES Reflector de diodos con sensor de movimiento
CN 泛光灯

230V~50/60Hz
50 W
4750 lm
6500K
10±2m
30000h
IP54

SMD
LED



YATO
YT-818291 8

EN LED floodlight
PL Reflektor LED
DE LED-Arbeitsleuchte
RU Светодиодный прожектор
CZ LED reflektor
HU Diódás reflektor
RO Reflector LED
FR Projecteur LED
IT Riflettore LED
ES Reflector LED
CN LED投光灯

230V~50/60Hz
30 W
2850 lm
6500K
30000h
IP65
CABLE H05RN-F KABEL
1.5 m

SMD
LED



YATO
YT-818381 10

EN LED floodlight
PL Reflektor LED
DE LED-Arbeitsleuchte
RU Светодиодный прожектор
CZ LED reflektor
HU Diódás reflektor
RO Reflector LED
FR Projecteur LED
IT Riflettore LED
ES Reflector LED
CN LED投光灯

230V~50/60Hz
50 W
4750 lm
6500K
30000h
IP65
CABLE H05RN-F KABEL
1.5 m

SMD
LED



YATO
YT-818391 8

EN Hybrid floodlight
PL Reflektor sieciowo-akumulatorowy
DE Netz- und Akku-Scheinwerfer
RU Аккумуляторно-сетевой прожектор
CZ Síťovo-bateriový reflektor
HU Hálózati-akkumulátoros reflektor
RO Proiecteur hibrid
FR Projecteur LED avec trépied
IT Faro LED a batteria
ES Lámpara reflector de pie con cable y batería
CN 三脚架工作灯

CRI 70
7.4 V 4000mAh Li-Ion
5000 lm
6h
1-5h
1,8 0,96 m
CABLE H05RN-F KABEL
2x 0,75 mm²
5m





SMD
LED

YATO
YT-81811 2

EN LED floodlight with tripod
 PL Reflektor LED na stojaku
 DE LED-Stativ-Leuchte
 RU Светодиодный прожектор на стойке
 CZ LED reflektor na stojanu
 HU Állványos diódás reflektor
 RO Reflector LED cu stativ
 FR Projecteur LED sur trépied
 IT Faro LED con treppiede
 ES Reflector de diodos con tripie
 CN 带支架投光灯





230V~ 50/60Hz	20 W
1900 lm	6500K
 30000 h	1,2 m 
IP65	CABLE H05RN-F KABEL
2 m	

SMD
LED



EN LED floodlight with tripod
 PL Reflektor LED na stojaku
 DE LED-Stativ-Leuchte
 RU Светодиодный прожектор на стойке
 CZ LED reflektor na stojanu
 HU Állványos diódás reflektor
 RO Reflector LED cu stativ
 FR Projecteur LED sur trépied
 IT Faro LED con treppiede
 ES Reflector de diodos con tripie
 CN 带支架投光灯



230V~ 50/60Hz	30 W
2850 lm	6500K
 30000 h	1,2 m 
IP65	CABLE H05RN-F KABEL
2 m	

SMD
LED



YATO 

YT-818141



6

YATO 

YT-818161



6

EN LED floodlight with tripod
 PL Reflektor LED na stojaku
 DE LED-Stativ-Leuchte
 RU Светодиодный прожектор на стойке
 CZ LED reflektor na stojanu
 HU Állványos diódás reflektor
 RO Reflector LED cu stativ
 FR Projecteur LED sur trépied
 IT Faro LED con treppiede
 ES Reflector de diodos con tripie
 CN 带支架投光灯





230V~ 50/60Hz	20W x2
1900 lm x2	6500K
 30000 h	1,2 m 
IP65	CABLE H05RN-F KABEL
2 m	

SMD
LED



EN LED floodlight with tripod
 PL Reflektor LED na stojaku
 DE LED-Stativ-Leuchte
 RU Светодиодный прожектор на стойке
 CZ LED reflektor na stojanu
 HU Állványos diódás reflektor
 RO Reflector LED cu stativ
 FR Projecteur LED sur trépied
 IT Faro LED con treppiede
 ES Reflector de diodos con tripie
 CN 带支架投光灯



230V~ 50/60Hz	30W x2
2850 lm x2	6500K
 30000 h	1,2 m 
IP65	CABLE H05RN-F KABEL
2 m	

SMD
LED



YATO 

YT-818151



4

YATO 

YT-818171



4

EN Workshop LED lamp
PL Lampa warsztatowa LED
DE LED Arbeitsleuchte
RU Светодиодная лампа для мастерской
CZ LED pracovní lamp
HU LED szerezőlámpa
RO Lampă LED pt. atelier
FR Lanterne d'atelier LED
IT Lampada da lavoro LED
ES Lámpara de trabajo LED
CN 工作灯



220-240V-50Hz
50 W
3800 lm
3000 W
5000K
CRI 80
360°
30000 h
IP44
1.5 m

SMD LED



YATO

YT-08495

4

EN Workshop LED lamp
PL Lampa warsztatowa LED
DE LED Arbeitsleuchte
RU Светодиодная лампа для мастерской
CZ LED pracovní lamp
HU LED szerezőlámpa
RO Lampă LED pt. atelier
FR Lanterne d'atelier LED
IT Lampada da lavoro LED
ES Lámpara de trabajo LED
CN 工作灯



220-240V-50Hz
100 W
7500 lm
3000 W
5000K
CRI 80
360°
30000 h
IP44
1.5 m

SMD LED



YATO

YT-08496

4

EN Cordless floodlight
PL Reflektor akumulatorowy
DE Akku-Strahler
RU Аккумуляторный прожектор
CZ Reflektor akumulátorový
HU Akkumulátoros reflektor
RO Reflector fără acumulator
FR Projecteur sans-fil
IT Faro a batteria
ES Reflector a batería
CN 泛光灯

• 2 lighting modes: 50%, 100%
• 2 tryby świecenia: 50%, 100%

Battery not included
Ohne Akku / Bez akumulatora
Bez baterije / Bez aku
Akkumulátor nélkül
Fără baterie / Sans batterie
Senza batteria / Sin batería
没有电池



18 V
Li-Ion
1600 lm
2 LIGHTING MODES
TRZY TRYBY ŚWIECENIA
METAL FRAME
NETFLCWA
RAHKA
TRANSPORT HANDLE
SCHWYŁ
TRANSPORTOWY



18V
Li-Ion

YATO

[V d.c.]

YT-82961

18

6

EN LED rechargeable floodlight
PL Reflektor LED akumulatorowy
DE Akku-LED-Strahler
RU Светодиодный аккумуляторный прожектор
CZ LED bateriový reflektor
HU Újratölthető reflektor LED

RO Reflector LED cu acumulator
FR Projecteur a LED rechargeable
IT Faro LED a batteria
ES Reflector recargable LED
CN 充电工作灯



5W
3.7 V
2000mAh
Li-Ion
300 lm
7000K
5.5h
3.5-4h
5 LIGHTING MODES
TRZY TRYBY ŚWIECENIA
IP54
USB
BATTERY CHARGER
ŁADOWNIK

COB LED



YATO

YT-81819

40

EN LED rechargeable floodlight
PL Reflektor LED akumulatorowy
DE Akku-LED-Strahler
RU Светодиодный аккумуляторный прожектор
CZ LED bateriový reflektor
HU Újratölthető reflektor LED
RO Reflector LED cu acumulator
FR Projecteur a LED rechargeable
IT Riflettore LED
ES Reflector recargable LED
CN 充电工作灯

A++
A+
A



10 W
3.7 V
4400mAh
Li-Ion
800 lm
6000K
5.5h
2.5h
4400 mAh
USB

COB LED

EN LED floodlight
PL Reflektor LED
DE LED-Arbeitsleuchte
RU Светодиодный прожектор
CZ LED reflektor
HU Diódás reflektor
RO Reflector LED
FR Projecteur LED
IT Riflettore LED
ES Reflector LED
CN LED投光灯

A++
A+
A



10 W
6V
680 lm
4x AA
3 LIGHTING MODES
TRZY TRYBY ŚWIECENIA
PA6

COB LED

• 3 lighting modes: 100%, 30%, strobe
• 3 tryby świecenia: 100%, 30%, pulsowanie

YATO

YT-81820

6/12

YATO

YT-81821

8/16

EN Portable floodlight with speaker
 PL Reflektor przenośny z głośnikiem
 DE Tragbarer Strahler mit Lautsprecher
 RU Переносной звуковой прожектор
 CZ Přenosný reflektor s reproduktorem
 HU Hordozható reflektor hangszóróval
 RO Projector portabil cu difuzor
 FR Projecteur LED portable avec haut-parleur
 IT Faro portatile con altoparlante
 ES Reflector portátil con altavoz
 CN 蓝牙音响灯

15W x2
 3.7 V 4400mAh Li-Ion
 2000 lm
 5/16" 8 mm
 6 LIGHTING MODES, 170° SWINGING
 5h
 2.5-12h
 4400 mAh
 IP44
 USB BATTERY CHARGER LAZAROWKA

COB LED



Compatible with YT-81809
 Kompatybilny z YT-81809

YATO		
YT-81808	H [mm]	24

EN Aluminium tripod
 PL Statyw aluminiowy
 DE Aluminium-Stativ
 RU Алюминиевый штатив
 CZ Hliníkový statív
 HU Alumínium állvány
 RO Trépied aluminiu
 FR Trépied en aluminium
 IT Tripode in alluminio
 ES Trípode de aluminio
 CN 三角架

100 33.5 cm
 5/16" 8 mm
 AI ANTI-SLIP PADS ANTY-POŚLIZGOWE PODKŁADKI



For YT-81808
 Dla YT-81808

YATO		
YT-81809	H [mm]	21

EN Solar LED floodlight with motion detector
 PL Reflektor solarny LED z czujnikiem ruchu
 DE Solar-Diodenscheinwerfer mit Bewegungsmelder
 RU Настенный светильник на солнечной батарее с датчиком движения
 CZ LED solární reflektor se snímačem pohybu
 HU Napelemes reflektor LED mozgásérzékelővel
 RO Reflector solar LED cu senzor de mișcare
 FR LED projecteur solaire avec détecteur de mouvement
 IT Lampada solare a LED con sensore di movimento
 ES LED solar reflector con sensor de movimiento
 CN 带感应太阳能投光灯

4W
 3.7 V 2200mAh Li-Ion
 380 lm
 4000K
 6h
 3h
 10m
 IP44

SMD LED



A++
 A+
 A

YATO		
YT-81860		12

EN Solar LED wall lamp
 PL Lampa ścienna solarna LED
 DE LED Solar-Wandleuchte
 RU Настінний світильник
 CZ LED solární svítidla
 HU Fali lámpa napelemes LED
 RO Lampă solara pt. perete
 FR Lampe solaire LED
 IT Lampada da parete LED solare
 ES Luz de pared de LED solar
 CN 太阳能感应壁灯

120 lm
 3.7 V 900mAh Li-Ion
 8h
 12h
 3m
 IP65

SMD LED



A++
 A+
 A

YATO		
YT-81855		12/48

EN Solar LED wall lamp
 PL Lampa ścienna solarna LED
 DE LED Solar-Wandleuchte
 RU Настінний світильник
 CZ LED solární svítidla
 HU Fali lámpa napelemes LED
 RO Lampă solara pt. perete
 FR Lampe solaire LED
 IT Lampada da parete LED solare
 ES Luz de pared de LED solar
 CN 太阳能感应壁灯

3.7 V 900mAh Li-Ion
 120 lm
 8h
 12h
 3m
 IP65
 SMD LED



YATO		
YT-81856		12/48

A++
 A+
 A

EN Rechargeable worklight
PL Lampa warsztatowa akumulatorowa
DE Akku-Werkstattleuchte
RU Аккумуляторная рабочая лампа
CZ Akumulátorová dílenská lampa
HU Akkumulátoros műhelylámpa
RO Lampă de atelier cu acumulator
FR Kit éclairage mécanicien
IT Lampada officina a batteria
ES Linterna para taller recargable
CN 三合一手电筒组套

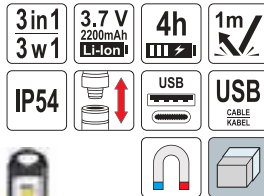

POWER LED



YATO
YT-08521

10

EN Workshop LED battery lamp
PL Lampa warsztatowa LED akumulatorowa
DE Akku-LED-Werkstattlampe
RU Фонарик аккумуляторный для мастерской
CZ Aku LED pracovní svítlna
HU Akkumulátoros LED szerelőlámpa
RO Lampă LED cu acumulator
FR Lampe d'inspection LED rechargeable
IT Lampada da lavoro a LED ricaricabile
ES Lámpara de trabajo LED recargable
CN 工作灯

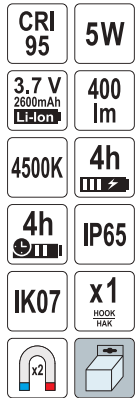

COB LED



A++
A+
A

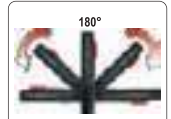
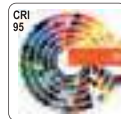

YATO
YT-08509

12

EN Workshop LED battery lamp
PL Lampa warsztatowa LED akumulatorowa
DE Akku-LED-Werkstattlampe
RU Фонарик аккумуляторный для мастерской
CZ Aku LED pracovní svítlna
HU Akkumulátoros LED szerelőlámpa
RO Lampă LED cu acumulator
FR Lampe d'inspection LED rechargeable
IT Lampada da lavoro a LED ricaricabile
ES Lámpara de trabajo LED recargable
CN 工作灯

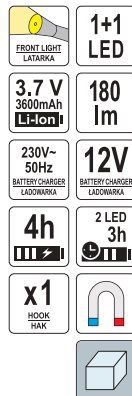

COB LED



A++
A+
A



YATO
YT-08502

10

EN Workshop LED battery lamp
PL Lampa warsztatowa LED akumulatorowa
DE Akku-LED-Werkstattlampe
RU Фонарик аккумуляторный для мастерской
CZ Aku LED pracovní svítlna
HU Akkumulátoros LED szerelőlámpa
RO Lampă LED cu acumulator
FR Lampe d'inspection LED rechargeable
IT Lampada da lavoro a LED ricaricabile
ES Lámpara de trabajo LED recargable
CN 工作灯



COB LED



YATO
YT-08558

12

EN Workshop LED battery lamp
 PL Lampa warsztatowa LED akumulatorowa
 DE Akku-LED-Werkstattlampe
 RU Фонарик аккумуляторный для мастерской
 CZ Aku LED pracovní svítidla
 HU Akkumulátoros LED szerelőlámpa
 RO Lampă LED cu acumulator
 FR Lampe d'inspection LED rechargeable
 IT Lampada da lavoro a LED ricaricabile
 ES Lámpara de trabajo LED recargable
 CN 工作灯

A++
 A+
 A

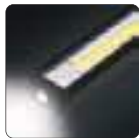
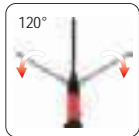

FRONT LIGHT
LATARSKA

5+3
W

3.7 V
2600mAh
Li-Ion

600/260
lm

6500K

4h

2.5-5.5h
POLYCARBONATE
DIFFUSER
KŁOSZ
Z POLIWĘGLANU

USB
BATTERY CHARGER
ŁADOWNIKA

USB
BATTERY CHARGER
ŁADOWNIKA

COB
LED

EN Workshop LED battery lamp
 PL Lampa warsztatowa LED akumulatorowa
 DE Akku-LED-Werkstattlampe
 RU Фонарик аккумуляторный для мастерской
 CZ Aku LED pracovní svítidla
 HU Akkumulátoros LED szerelőlámpa
 RO Lampă LED cu acumulator
 FR Lampe d'inspection LED rechargeable
 IT Lampada da lavoro a LED ricaricabile
 ES Lámpara de trabajo LED recargable
 CN 工作灯

A++
 A+
 A



FRONT LIGHT
LATARSKA

7+3
W

60-600
lm

120
lm

6500K

3.7 V
2600mAh
Li-Ion

4-5h

1.5-16.5h

IP54

LED CHARGE
INDICATOR
WYSKAZNIK
NAŁADOWNIANIA
BATERII

x1
HOOK
HAK

POLYCARBONATE
DIFFUSER
KŁOSZ
Z POLIWĘGLANU

USB
BATTERY CHARGER
ŁADOWNIKA

USB
BATTERY CHARGER
ŁADOWNIKA

COB
LED

YATO YT-08518 12

YATO YT-08519 20

EN Workshop LED battery lamp
 PL Lampa warsztatowa LED akumulatorowa
 DE Akku-LED-Werkstattlampe
 RU Фонарик аккумуляторный для мастерской
 CZ Aku LED pracovní svítidla
 HU Akkumulátoros LED szerelőlámpa
 RO Lampă LED cu acumulator
 FR Lampe d'inspection LED rechargeable
 IT Lampada da lavoro a LED ricaricabile
 ES Lámpara de trabajo LED recargable
 CN 工作灯



5+5
W

3.7 V
2600mAh
Li-Ion

50/500
lm

6500K

4h

2-16h

2m

IP54

IK07

x1
HOOK
HAK

USB
CABLE
KABEL

USB
BATTERY CHARGER
ŁADOWNIKA

COB
LED

EN Workshop LED battery lamp
 PL Lampa warsztatowa LED akumulatorowa
 DE Akku-LED-Werkstattlampe
 RU Фонарик аккумуляторный для мастерской
 CZ Aku LED pracovní svítidla
 HU Akkumulátoros LED szerelőlámpa
 RO Lampă LED cu acumulator
 FR Lampe d'inspection LED rechargeable
 IT Lampada da lavoro a LED ricaricabile
 ES Lámpara de trabajo LED recargable
 CN 工作灯



FRONT LIGHT
LATARSKA

3.5+3
W

3.7 V
2600mAh
Li-Ion

330
lm

6000K

4h

4h

USB
BATTERY CHARGER
ŁADOWNIKA

USB
IP54

IK07

x2
HOOKS
HAKI

POLYCARBONATE
DIFFUSER
KŁOSZ
Z POLIWĘGLANU

x3

SMD
LED

YATO YT-08527 12

YATO YT-085081 12

EN Workshop LED battery lamp
PL Lampa warsztatowa LED akumulatorowa
DE Akku-LED-Werkstattlampe
RU Фонарик аккумуляторный для мастерской
CZ Aku LED pracovní svítidla
HU Akkumulátoros LED szerelőlámpa
RO Lampă LED cu acumulator
FR Lampe d'inspection LED rechargeable
IT Lampada da lavoro a LED ricaricabile
ES Lámpara de trabajo LED recargable
CN 工作灯



LED



YATO

YT-08507

12

EN Workshop LED battery lamp
PL Lampa warsztatowa LED akumulatorowa
DE Akku-LED-Werkstattlampe
RU Фонарик аккумуляторный для мастерской
CZ Aku LED pracovní svítidla
HU Akkumulátoros LED szerelőlámpa
RO Lampă LED cu acumulator
FR Lampe d'inspection LED rechargeable
IT Lampada da lavoro a LED ricaricabile
ES Lámpara de trabajo LED recargable
CN 工作灯



COB
LED



YATO

YT-08504

10

EN Workshop LED battery lamp
PL Lampa warsztatowa LED akumulatorowa
DE Akku-LED-Werkstattlampe
RU Фонарик аккумуляторный для мастерской
CZ Aku LED pracovní svítidla
HU Akkumulátoros LED szerelőlámpa
RO Lampă LED cu acumulator
FR Lampe d'inspection LED rechargeable
IT Lampada da lavoro a LED ricaricabile
ES Lámpara de trabajo LED recargable
CN 工作灯

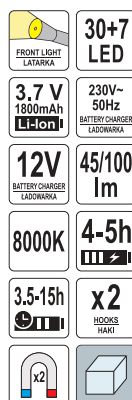

LED

YATO

YT-085051

10

EN Workshop LED battery lamp
PL Lampa warsztatowa LED akumulatorowa
DE Akku-LED-Werkstattlampe
RU Фонарик аккумуляторный для мастерской
CZ Aku LED pracovní svítidla
HU Akkumulátoros LED szerelőlámpa
RO Lampă LED cu acumulator
FR Lampe d'inspection LED rechargeable
IT Lampada da lavoro a LED ricaricabile
ES Lámpara de trabajo LED recargable
CN 工作灯



COB SMD
LED



YATO

YT-08524

12

EN LED workshop lamp
 PL Lampa warsztatowa LED
 DE LED-Werkstattlampe
 RU Светодиодный светильник для мастерской
 CZ Montážní lampa LED
 HU LED szerelőlámpa
 RO Lampă cu LED
 FR Lampe d'inspection a LED
 IT Lampada da lavoro a LED
 ES Lámpara de trabajo LED
 CN 笔式可充电工作灯



60+1 LED
3.7 V
 1800mAh
Li-Ion

AC
 BATTERY CHARGER
 ŁADOWNIKA

12V
 BATTERY CHARGER
 ŁADOWNIKA

4h
3h

x1
 HOOK
 HAK

LED

EN LED workshop lamp
 PL Lampa warsztatowa LED
 DE LED-Werkstattlampe
 RU Светодиодный светильник для мастерской
 CZ Montážní lampa LED
 HU LED szerelőlámpa
 RO Lampă cu LED
 FR Lampe d'inspection a LED
 IT Lampada da lavoro a LED
 ES Lámpara de trabajo LED
 CN 笔式可充电工作灯



8+1 LED
 FRONT LIGHT
 LATARKA

280 lm
3x
 AA

9 LED
4h

3
 LIGHTING MODES
 TRYBY SWIECENIA

x1
 HOOK
 HAK

SMD
LED

A++
A+
A



YATO **YT-08520** 5/20

YATO **YT-08513** 50

EN LED workshop lamp
 PL Lampa warsztatowa LED
 DE LED-Werkstattlampe
 RU Светодиодный светильник для мастерской
 CZ Montážní lampa LED
 HU LED szerelőlámpa
 RO Lampă cu LED
 FR Lampe d'inspection a LED
 IT Lampada da lavoro a LED
 ES Lámpara de trabajo LED
 CN 笔式可充电工作灯



8 LED
80 lm
3x
 AAA

8 LED
20h

A++
A+
A

SMD
LED

YATO **YT-08514** 12/72

EN LED workshop lamp
 PL Lampa warsztatowa LED
 DE LED-Werkstattlampe
 RU Светодиодный светильник для мастерской
 CZ Montážní lampa LED
 HU LED szerelőlámpa
 RO Lampă cu LED
 FR Lampe d'inspection a LED
 IT Lampada da lavoro a LED
 ES Lámpara de trabajo LED
 CN 笔式可充电工作灯



3W
200 lm
 RED FLASH
 CZERWONE
 MIGANIE

IP44
3x
 AAA

COB
LED

YATO **YT-08511** 20/80

EN LED workshop lamp
 PL Lampa warsztatowa LED
 DE LED-Werkstattlampe
 RU Светодиодный светильник для мастерской
 CZ Montážní lampa LED
 HU LED szerelőlámpa
 RO Lampă cu LED
 FR Lampe d'inspection a LED
 IT Lampada da lavoro a LED
 ES Lámpara de trabajo LED
 CN 笔式可充电工作灯



3W
400 lm
 RED FLASH
 CZERWONE
 MIGANIE

IP44
3x
 AA

COB
LED

YATO **YT-08522** 12/48

EN Multipurpose lamp
PL Lampka wielofunkcyjna
DE Multifunktions-Lampe
RU Многофункциональная лампа
CZ Multifunkční lampička
HU Multifunkciós lámpa
RO Lampa multifuncțională
FR Lampe multifonction
IT Lampada multifunzione
ES Lámpara multifuncional
CN 工作灯



3W 3.7 V 700mAh Li-Pol 100 lm 7000K 1.5h
2-3h IP54 USB BATTERY CHARGER LADONAWKA

COB
LED

YATO
YT-08516 15/60

EN Under bonnet work lamp
PL Lampka do oświetlania komory silnika
DE Motorhauben-Leuchte
RU Лампа освещения моторного отсека
CZ Dílenská lampa pro osvětlení motorového prostoru
HU Motor tér megvilágító lámpa
RO Lampă de lucru pt. compartimentul motor
FR Lampe pour compartiment moteur
IT Lampada sottocofano
ES Lámpara para capó de coche
CN 引擎盖检修灯

120 LED 60 LED 120 LED 7.4 V 1800mAh Li-Ion AC 12V
750 lm 4.5-5h 3.5-8h x2 HOOKS HAKI

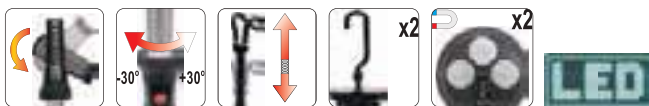

YATO
YT-08529 4

EN UV LED flashlight and glasses set
PL Zestaw latarka UV LED i okulary
DE UV LED Taschenlampe mit UV Schutzbrille
RU Комплект для проверки утечек хладагента - УФ фонарь с очками
CZ UV LED svítilna + brýle
HU UV LED zseblámpa + szemüveg
RO Set lanternă LED UV și ochelari
FR UV LED lampe de poche avec lunettes
IT Lampada UV LED con occhiali
ES UV LED linterna con gafas para
CN 手电筒

51 LED UV 395 nm
3x AAA



UV
LED

YATO
YT-08581 40

EN UV LED flashlight and glasses set
PL Zestaw latarka UV LED i okulary
DE UV LED Taschenlampe mit UV Schutzbrille
RU Комплект для проверки утечек хладагента - УФ фонарь с очками
CZ UV LED svítilna + brýle
HU UV LED zseblámpa + szemüveg
RO Set lanternă LED UV și ochelari
FR UV LED lampe de poche avec lunettes
IT Lampada UV LED con occhiali
ES UV LED linterna con gafas para
CN 紫外线手电筒和防护眼镜

100 LED UV 395 nm
6x AA



UV
LED

YATO
YT-08582 12

EN UV LED flashlight and glasses set
PL Zestaw latarka UV LED i okulary
DE UV LED Taschenlampe mit UV Schutzbrille
RU Комплект для проверки утечек хладагента - УФ фонарь с очками
CZ UV LED svítilna + brýle
HU UV LED zseblámpa + szemüveg
RO Set lanternă LED UV și ochelari
FR UV LED lampe de poche avec lunettes
IT Lampada UV LED con occhiali
ES UV LED linterna con gafas para
CN 紫外线手电筒和防护眼镜

1W UV 395 nm 3.7 V 1500mAh Li-Ion
6-8h 3.5-4h ZOOM USB



UV
LED

YATO
YT-08587 12

EN UV LED flashlight and glasses set
PL Zestaw latarka UV LED i okulary
DE UV LED Taschenlampe mit UV Schutzbrille
RU Комплект для проверки утечек хладагента - УФ фонарь с очками
CZ UV LED svítilna + brýle
HU UV LED zseblámpa + szemüveg
RO Set lanternă LED UV și ochelari
FR UV LED lampe de poche avec lunettes
IT Lampada UV LED con occhiali
ES UV LED linterna con gafas para
CN 紫外线手电筒和防护眼镜

3W UV 395 nm 3.7 V 1500mAh Li-Ion
6-8h 3.5-4h FLASH MANGANIE USB



UV
LED

YATO
YT-08588 12

EN LED flashlight
 PL Latarka LED
 DE LED Taschenlampe
 RU Светодиодный фонарь
 CZ LED svítilna
 HU LED zseblámpa
 RO Lanternă cu LED
 FR Lampe torche LED
 IT Torcia LED
 ES Linterna LED
 CN 手电筒



FRONT LIGHT
LATARKA

2W

200 lm

IPX4

IK07

3x AAA

x1 HOOK HAK

x2

POWER SMD LED



YATO	[W]	[lm]	
YT-08555	2	200 / 70 / 45	50

EN LED flashlight
 PL Latarka LED
 DE LED Taschenlampe
 RU Светодиодный фонарь
 CZ LED svítilna
 HU LED zseblámpa
 RO Lanternă cu LED
 FR Lampe torche LED
 IT Torcia LED
 ES Linterna LED
 CN 手电筒



FRONT LIGHT
LATARKA

5W

3.7 V 1500mAh Li-Po

500 lm

3h

2-9h

1500 mAh

IPX4

IK07

x1 HOOK HAK

USB BATTERY CHARGER LADONARKA

x2

POWER SMD LED



YATO	[W]	[lm]	
YT-08556	5+1	500 / 200 / 60	50

EN LED flashlight
 PL Latarka LED
 DE LED Taschenlampe
 RU Светодиодный фонарь
 CZ LED svítilna
 HU LED zseblámpa
 RO Lanternă cu LED
 FR Lampe torche LED
 IT Torcia LED
 ES Linterna LED
 CN 手电筒



FRONT LIGHT
LATARKA

5W

3.7 V 2000mAh Li-Po

500 lm

4h

2h - 5h 30' - 20'

IP54

IK07

USB CABLE KABEL

USB

COB SMD LED



YATO	[W]	[lm]	
YT-08557	5+0.9	500 / 250 / 90	50

EN LED flashlight
 PL Latarka LED
 DE LED Taschenlampe
 RU Светодиодный фонарь
 CZ LED svítilna
 HU LED zseblámpa
 RO Lanternă cu LED
 FR Lampe torche LED
 IT Torcia LED
 ES Linterna LED
 CN 手电筒



5W

UV

3.7 V 2000mAh Li-Ion

200/300 lm

7000K

5.5h

2-3h

IP54

USB BATTERY CHARGER LADONARKA

COB LED

A++
A+
A



YATO	[W]	[lm]	
YT-08580	5	200 / 300	50

EN LED flashlight
 PL Latarka LED
 DE LED Taschenlampe
 RU Светодиодный фонарь
 CZ LED svítilna
 HU LED zseblámpa

RO Lanternă cu LED
 FR Lampe torche LED
 IT Torcia LED
 ES Linterna LED
 CN 手电筒

10 W

1000 lm

350m

3 LIGHTING MODES TRYBY SVIŠENIA

ZOOM

IPX4

6 V 4x CR14



POWER LED

YATO	[W]	[lm]	
YT-08567	10	1000	8/16

EN LED flashlight
 PL Latarka LED
 DE LED Taschenlampe
 RU Светодиодный фонарь
 CZ LED svítilna
 HU LED zseblámpa

RO Lanternă cu LED
 FR Lampe torche LED
 IT Torcia LED
 ES Linterna LED
 CN 手电筒

6W

500 lm

200m

3 LIGHTING MODES TRYBY SVIŠENIA

ZOOM

3.7 V 2200mAh Li-Ion

4h

USB BATTERY CHARGER LADONARKA

IPX7



POWER LED

YATO	[W]	[lm]	
YT-08568	6	500	6/24

EN LED flashlight
PL Latarka LED
DE LED Taschenlampe
RU Светодиодный фонарь
CZ LED svítilna
HU LED zseblámpa
RO Lanternă cu LED
FR Lampe torche LED
IT Torcia LED
ES linterna LED
CN 手电筒



5W 3.7 V 700mAh Li-Ion 3h 350 lm 150m 4 LIGHTING MODES TRYBY ŚWIĘCENIA ZOOM IPX4 USB CHARGING ŁADOWANIE

POWER LED

YATO	[W]	[lm]	
YT-08569	5	350	12/96

EN LED flashlight
PL Latarka LED
DE LED Taschenlampe
RU Светодиодный фонарь
CZ LED svítilna
HU LED zseblámpa
RO Lanternă cu LED
FR Lampe torche LED
IT Torcia LED
ES linterna LED
CN 手电筒



3W 100 lm ZOOM IP64 1x AA

POWER LED

YATO	[W]	[lm]	
YT-08571	3	100	24/96

EN LED flashlight
PL Latarka LED
DE LED Taschenlampe
RU Светодиодный фонарь
CZ LED svítilna
HU LED zseblámpa

RO Lanterna cu LED
FR Lampe torche LED
IT Torcia LED
ES linterna LED
CN 手电筒



10 W 3.7 V 4000mAh Li-Ion 1000 lm 920m 4 LIGHTING MODES TRYBY ŚWIĘCENIA 3h 6h 4000 mAh ZOOM IPX7 IK07 USB CABLE KABEL

SMD

LED

YATO	[W]	[lm]	
YT-085602	10	1000 / 6000 / 300 / 30	6/24

EN LED flashlight
PL Latarka LED
DE LED Taschenlampe
RU Светодиодный фонарь
CZ LED svítilna
HU LED zseblámpa

RO Lanterna cu LED
FR Lampe torche LED
IT Torcia LED
ES linterna LED
CN 手电筒



50 W 7.4 V 2600mAh Li-Ion 9x AA 5000 lm 280m 4 LIGHTING MODES TRYBY ŚWIĘCENIA 5h 8h IPX4 IK07 USB CABLE KABEL

COB

LED

YATO	[W]	[lm]	
YT-085607	50	5000 / 2500 / 500	6/12

EN LED flashlight
PL Latarka LED
DE LED Taschenlampe
RU Светодиодный фонарь
CZ LED svítilna
HU LED zseblámpa

RO Lanternă cu LED
FR Lampe torche LED
IT Torcia LED
ES linterna LED
CN 手电筒

• Glass breaker
• Bottle opener

• Wybijać do szyby
• Otwieracz do butelek



10 W 3.7 V 2200mAh Li-Ion 900 lm 200m 5 LIGHTING MODES TRYBY ŚWIĘCENIA ZOOM 5-6h 3-7h 2200 mAh IP64 USB BATTERY CHARGER ŁADOWNIKA

POWER LED

YATO	[W]	[lm]	
YT-08559	10	900	30

EN LED flashlight
PL Latarka LED
DE LED Taschenlampe
RU Светодиодный фонарь
CZ LED svítilna
HU LED zseblámpa

RO Lanternă cu LED
FR Lampe torche LED
IT Torcia LED
ES linterna LED
CN 手电筒



LED

YATO			
YT-08570			24/192

EN LED flashlight
PL Latarka LED
DE LED Taschenlampe
RU Светодиодный фонарь
CZ LED svítilna
HU LED zseblámpa

RO Lanterna cu LED
FR Lampe torche LED
IT Torcia LED
ES linterna LED
CN 手电筒



25 W 3.7 V 5000mAh Li-Ion 6x AA 2500 lm 180m 4 LIGHTING MODES TRYBY ŚWIĘCENIA 6h 8h IPX4 IK07 USB CABLE KABEL

COB

LED

YATO	[W]	[lm]	
YT-085606	25	2500 / 1250 / 250	6/12

EN LED flashlight
PL Latarka LED
DE LED Taschenlampe
RU Светодиодный фонарь
CZ LED svítilna
HU LED zseblámpa

RO Lanternă cu LED
FR Lampe torche LED
IT Torcia LED
ES linterna LED
CN 手电筒



100 W 7.4 V 5000mAh Li-Ion 8000 lm 3 LIGHTING MODES TRYBY ŚWIĘCENIA 1.5-15h 5000 mAh IPX4 IK07 USB CABLE KABEL

COB

LED

YATO	[W]	[lm]	
YT-085601	100	8000 / 4500 / 1150	5/20

EN Spotlight
 PL Latarka szperacz
 DE Suchscheinwerfer
 RU Проекторный фонарь
 CZ Ruční svítilna
 HU Keresőlámpa

RO Lanterna
 FR Projecteur de recherche
 IT Faro torcia
 ES Reflector linterna
 CN 多功能探照灯

3.7 V
3000mAh
Li-Ion

380/200
lm

500m

6
LIGHTING MODES
TRYBY SWIECENIA

6h

4h

x1
HOOK
HAK

USB
CABLE
KABEL

USB



**POWER
LED**

YATO	[lm]	
YT-08547	380/200	24

EN Spotlight
 PL Latarka szperacz
 DE Suchscheinwerfer
 RU Проекторный фонарь
 CZ Ruční svítilna
 HU Keresőlámpa

RO Lanterna
 FR Projecteur de recherche
 IT Faro torcia
 ES Reflector linterna
 CN 多功能探照灯

3.7 V
4400mAh
Li-Ion

530
lm

500m

11
LIGHTING MODES
TRYBY SWIECENIA

5h

3h

4400 mAh

IP54

x1
HOOK
HAK

USB
BATTERY CHARGER
ŁADOWNIK



**POWER
LED**

YATO	[lm]	
YT-08579	530/170	10

EN Spotlight
 PL Latarka szperacz
 DE Suchscheinwerfer
 RU Проекторный фонарь
 CZ Ruční svítilna
 HU Keresőlámpa
 RO Lanterna
 FR Projecteur de recherche
 IT Faro torcia
 ES Reflector linterna
 CN 多功能探照灯

16+10
W

3.7 V
8000mAh
Li-Ion

600/1000
lm

244m

9
LIGHTING MODES
TRYBY SWIECENIA

FLASH
MIGANIE

6h

4.5-25h

8000 mAh

IP54

IK07

USB
CABLE
KABEL

ABS
PC
TPE



**POWER COB
LED**

YATO	[W]	[lm]	
YT-08548	16 (POWER LED - LUXEON V2), 10 (COB LED)	600 (POWER LED), 1000 (COB LED)	10

EN Spotlight
 PL Latarka szperacz
 DE Suchscheinwerfer
 RU Проекторный фонарь
 CZ Ruční svítilna
 HU Keresőlámpa
 RO Lanterna
 FR Projecteur de recherche
 IT Faro torcia
 ES Reflector linterna
 CN 多功能探照灯

10
W

900
lm

200m

FLASH
MIGANIE

IP68

4x
AA



**POWER
LED**

YATO	[W]	[lm]	
YT-08550	10	900/450	10/20

EN Spotlight
 PL Latarka szperacz
 DE Suchscheinwerfer
 RU Проекторный фонарь
 CZ Ruční svítilna
 HU Keresőlámpa
 RO Lanterna
 FR Projecteur de recherche
 IT Faro torcia
 ES Reflector linterna
 CN 多功能探照灯

15
W

3.7 V
4400mAh
Li-Ion

1200
lm

250m

FLASH
MIGANIE

6h

5-6h

4400 mAh

IP68

USB
BATTERY CHARGER
ŁADOWNIK



**POWER
LED**

YATO	[W]	[lm]	
YT-08551	15	1200/600	10/20

EN LED headlamp
 PL Latarka czolowa LED
 DE LED Kopflampe
 RU Налобный светодиодный фонарь
 CZ Čelová lampa LED
 HU LED fejlámpa
 RO Lanterna cu LED pt. cap
 FR Lampe frontale LED
 IT Lampada da testa LED
 ES Lámpara LED de cabeza
 CN 头灯

2in1
2w1

3W

3.7 V
700mAh
Li-Pol

350
lm

47m

3
LIGHTING MODES
TRYBY SWIECENIA

FLASH
MIGANIE

2h

1.5-4h

IPX4

IK07

USB

ULTRA LIGHT
ULTRALIGHTKI



**POWER
LED**

YATO	[lm]	
YT-08597	350 (wysoki), 120 (niski)	10/60

EN LED headlamp
PL Latarka czołowa LED
DE LED Kopflampe
RU Налобный светодиодный фонарь
CZ Čelová lampa LED
HU LED fejlámpa
RO Lanterna cu LED pt. cap
FR Lampe frontale LED
IT Lampada da testa LED
ES Lámpara LED de cabeza
CN 头灯



POWER LED

YATO	[W]	[lm]	
YT-08590	3	100	50/100

EN LED headlamp
PL Latarka czołowa LED
DE LED Kopflampe
RU Налобный светодиодный фонарь
CZ Čelová lampa LED
HU LED fejlámpa
RO Lanterna cu LED pt. cap
FR Lampe frontale LED
IT Lampada da testa LED
ES Lámpara LED de cabeza
CN 头灯



POWER LED

YATO	[W]	[lm]	
YT-08591	10	450	6/24

EN LED headlamp
PL Latarka czołowa LED
DE LED Kopflampe
RU Налобный светодиодный фонарь
CZ Čelová lampa LED
HU LED fejlámpa

RO Lanterna cu LED pt. cap
FR Lampe frontale LED
IT Lampada da testa LED
ES Lámpara LED de cabeza
CN 头灯



POWER SMD LED

YATO	[lm]	
YT-08595	500	12/72

EN LED headlamp
PL Latarka czołowa LED
DE LED Kopflampe
RU Налобный светодиодный фонарь
CZ Čelová lampa LED
HU LED fejlámpa
RO Lanterna cu LED pt. cap
FR Lampe frontale LED
IT Lampada da testa LED
ES Lámpara LED de cabeza
CN 头灯

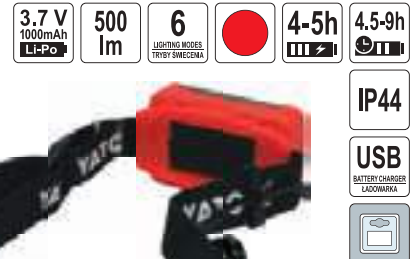

POWER SMD LED

YATO	[lm]	
YT-08596	500	12/72

EN LED headlamp
PL Latarka czołowa LED
DE LED Kopflampe
RU Налобный светодиодный фонарь
CZ Čelová lampa LED
HU LED fejlámpa
RO Lanterna cu LED pt. cap
FR Lampe frontale LED
IT Lampada da testa LED
ES Lámpara LED de cabeza
CN 头灯

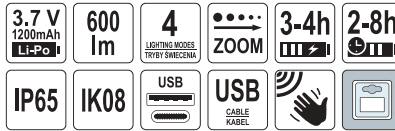

POWER LED

YATO	[lm]	
YT-085941	600	24

EN LED headlamp
PL Latarka czołowa LED
DE LED Kopflampe
RU Налобный светодиодный фонарь
CZ Čelová lampa LED
HU LED fejlámpa
RO Lanterna cu LED pt. cap
FR Lampe frontale LED
IT Lampada da testa LED
ES Lámpara LED de cabeza
CN 头灯



POWER COB LED

YATO	[lm]	
YT-085942	100 (COB LED), 1000 (POWER LED)	24

EN LED headlamp
PL Latarka czołowa LED
DE LED Kopflampe
RU Налобный светодиодный фонарь
CZ Čelová lampa LED
HU LED fejlámpa
RO Lanterna cu LED pt. cap
FR Lampe frontale LED
IT Lampada da testa LED
ES Lámpara LED de cabeza
CN 头灯

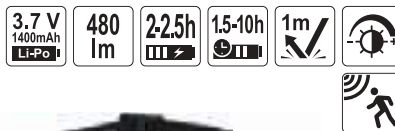

COB LED

YATO	[lm]	
YT-08592	480 (300 lm - POWER 100%, 90 lm - POWER 30%, 250 lm - COB 100%, 480 lm - POWER + COB)	6/24

EN LED headlamp
PL Latarka czołowa LED
DE LED Kopflampe
RU Налобный светодиодный фонарь
CZ Čelová lampa LED
HU LED fejlámpa

RO Lanterna cu LED pt. cap
FR Lampe frontale LED
IT Lampada da testa LED
ES Lámpara LED de cabeza
CN 头灯



COB LED

YATO	[lm]	
YT-08593	500 (400 lm - POWER 100%, 120 lm - POWER 30%, 200 lm - COB 100%, 500 lm - POWER + COB)	6/24

EN LED headlamp
 PL Latarka czołowa LED
 DE LED Kopflampe
 RU Напольный светодиодный фонарь
 CZ Čelová lampa LED
 HU LED fejlámpa

RO Lanterna cu LED pt. cap
 FR Lampe frontale LED
 IT Lampada da testa LED
 ES Lámpara LED de cabeza
 CN 头灯

3.7 V
2200mAh
Li-Pol

800
lm

4h

1.5-5h

1m

IP54

USB
BATTERY CHARGER
ŁADOWNIKA



COB
LED

YATO	[lm]	
YT-08594	800 (600 lm - POWER 100%, 250 lm - POWER 30%, 250 lm - COB 100%, 800 lm - POWER + COB)	6/24

EN LED headlamp for colour match
 PL Lampka czołowa LED do doborzenia kolorów
 DE LED-Stirnleuchte für Farbanpassung
 RU Светодиодный налобный фонарь для подбора цвета
 CZ LED čelovka pro barevné sladění
 HU LED homloklámpa színválasztáshoz
 RO Lanterna cap cu LED pt. potrivirea culorilor
 FR Lampe frontale LED adaptation de couleurs
 IT Torcia frontale a LED per selezionare colori
 ES Lámpara frontal LED para seleccionar colores
 CN 头灯-用于比对颜色

CRI 96

3.7 V
1500mAh
Li-Ion

160
lm

2700K
4500K
6500K

3h

IP65

IK07

USB
CHARGING
ŁADOWNIK



COB
LED

YATO	[lm]	
YT-08490	160	40

EN LED headlamp
 PL Latarka czołowa LED
 DE LED Kopflampe
 RU Напольный светодиодный фонарь
 CZ Čelová lampa LED
 HU LED fejlámpa
 RO Lanterna cu LED pt. cap
 FR Lampe frontale LED
 IT Lampada da testa LED
 ES Lámpara LED de cabeza
 CN 头灯

2+1.5
W

3.7 V
500mAh
Li-Pol

200/150
lm

21m

4
LIGHTING MODES
TRYBY ŚWIECENIA

1.5h

2-20h

IP54

IK07

USB



SMD
LED

YATO	[lm]	
YT-08598	200 (wysoki), 40 (niski), 150 (latarka)	10/100

EN Neck lamp
 PL Latarka na szyję
 DE Halslampe
 RU Фонарь на шею
 CZ Svítilna na krk
 HU Nyaklámpa
 RO Lanterna pt. gat
 FR Lampe torche tour du cou
 IT Torcia da collo
 ES Linterna para el cuello
 CN 脖子灯

3.7 V
2000mAh
Li-Ion

150lm
x2

4h

3.5-6.5h

1/4"
6,3mm

USB
BATTERY CHARGER
ŁADOWNIK



SMD
LED

YATO	[lm]	
YT-08599	150 x2	6/12

EN Infrared heater
 PL Promiennik podczerwieni
 DE Infrarotstrahler
 RU Инфракрасный обогреватель
 CZ Infrazářič
 HU Infravörös melegítő
 RO Încălzitor cu infraroșu
 FR Radiateur infrarouge
 IT Riscaldatore a infrarossi
 ES Radiador infrarrojo
 CN 取暖器

220-240V~
50/60Hz

1500
W

9-12
m²

1 s

5000 h

HALOGEN
HALOGENOWY

AI

IP44

1.9 m



YATO	[W]	
YT-99500	1500	1

EN Infrared heater
 PL Promiennik podczerwieni
 DE Infrarotstrahler
 RU Инфракрасный обогреватель
 CZ Infrazářič
 HU Infravörös melegítő
 RO Încălzitor cu infraroșu
 FR Radiateur infrarouge
 IT Riscaldatore a infrarossi
 ES Radiador infrarrojo
 CN 取暖器

220-240V~
50/60Hz

1500
W

12-18
m²

1 s

5000 h

HALOGEN
HALOGENOWY

AI

IP44

1.9 m



YATO	[W]	
YT-99501	1500	1

EN Infrared heater
PL Promiennik podczerwieni
DE Infrarotstrahler
RU Инфракрасный обогреватель
CZ Infrazářič
HU Infravörös melegítő
RO Încălzitor cu infraroșu
FR Radiateur infrarouge
IT Riscaldatore a infrarossi
ES Radiador infrarrojo
CN 取暖器



YATO	[W]	
YT-99520	800	4

EN Infrared heater
PL Promiennik podczerwieni
DE Infrarotstrahler
RU Инфракрасный обогреватель
CZ Infrazářič
HU Infravörös melegítő
RO Încălzitor cu infraroșu
FR Radiateur infrarouge
IT Riscaldatore a infrarossi
ES Radiador infrarrojo
CN 取暖器

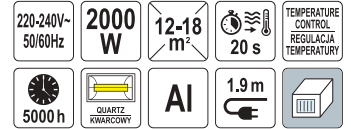

Compatible with YT-99570, YT-99571
Kompatybilny z YT-99570, YT-99571

YATO	[W]	
YT-99530	2000	1

EN Infrared heater
PL Promiennik podczerwieni
DE Infrarotstrahler
RU Инфракрасный обогреватель
CZ Infrazářič
HU Infravörös melegítő

RO Încălzitor cu infraroșu
FR Radiateur infrarouge
IT Riscaldatore a infrarossi
ES Radiador infrarrojo
CN 取暖器

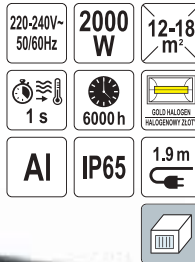

Compatible with YT-99570, YT-99571
Kompatybilny z YT-99570, YT-99571

YATO	[W]	
YT-99531	2000	6

EN Infrared heater
PL Promiennik podczerwieni
DE Infrarotstrahler
RU Инфракрасный обогреватель
CZ Infrazářič
HU Infravörös melegítő

RO Încălzitor cu infraroșu
FR Radiateur infrarouge
IT Riscaldatore a infrarossi
ES Radiador infrarrojo
CN 取暖器

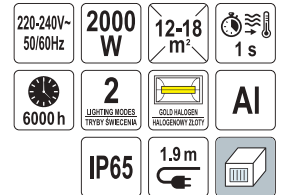

Compatible with YT-99570, YT-99571
Kompatybilny z YT-99570, YT-99571

YATO	[W]	
YT-99532	2000	6

EN Infrared heater
PL Promiennik podczerwieni
DE Infrarotstrahler
RU Инфракрасный обогреватель
CZ Infrazářič
HU Infravörös melegítő
RO Încălzitor cu infraroșu
FR Radiateur infrarouge
IT Riscaldatore a infrarossi
ES Radiador infrarrojo
CN 取暖器



Compatible with YT-99570, YT-99571
Kompatybilny z YT-99570, YT-99571

YATO	[W]	
YT-99536	2000	4

EN Stand for infrared heater
PL Statyw do promienników podczerwieni
DE Infrarotstrahlergestell
RU Подставка для инфракрасных обогревателей
CZ Stojan pro infrazářiče
HU Állvány infravörös melegítőhöz
RO Stand pt. încălzitor cu infraroșu
FR Trépied pour illuminateur infrarouge
IT Treppiede per irradiatore a raggi infrarossi
ES Trípode para radiadores infrarrojos
CN 支架



For YT-99530, YT-99531,
YT-99532, YT-99536

Dla YT-99530, YT-99531,
YT-99532, YT-99536



YATO	H [mm]	
YT-99570	1100-1800	6

EN Stand for infrared heater
PL Statyw do promienników podczerwieni
DE Infrarotstrahlergestell
RU Подставка для инфракрасных обогревателей
CZ Stojan pro infrazářiče
HU Állvány infravörös melegítőhöz
RO Stand pt. încălzitor cu infraroșu
FR Trépied pour illuminateur infrarouge
IT Treppiede per irradiatore a raggi infrarossi
ES Trípode para radiadores infrarrojos
CN 支架



For YT-99530, YT-99531,
YT-99532, YT-99536

Dla YT-99530, YT-99531,
YT-99532, YT-99536



YATO	H [mm]	
YT-99571	1100-2100	1

EN Universal travel adapter with USB
 PL Uniwersalny adapter podróży z USB
 DE Universal-Reisestecker mit USB
 RU Универсальный дорожный адаптер-переходник с USB
 CZ Univerzální cestovní adaptér s USB
 HU Univerzális utazó adapter USB-vel
 RO Adaptor universal de călătorie cu USB
 FR Adaptateur de voyage universel avec USB
 IT Adattatore universale da viaggio con USB
 ES Adaptador universal de viaje con USB
 CN 旅行转换插头



YATO **YT-81300** 50

EN Universal travel adapter with USB
 PL Uniwersalny adapter podróży z USB
 DE Universal-Reisestecker mit USB
 RU Универсальный дорожный адаптер-переходник с USB
 CZ Univerzální cestovní adaptér s USB
 HU Univerzális utazó adapter USB-vel
 RO Adaptor universal de călătorie cu USB
 FR Adaptateur de voyage universel avec USB
 IT Adattatore universale da viaggio con USB
 ES Adaptador universal de viaje con USB
 CN 旅行转换插头



YATO **YT-81301** 50

EN Universal travel adapter
 PL Uniwersalny adapter podróży
 DE Universal-Reisestecker
 RU Универсальный дорожный адаптер-переходник
 CZ Univerzální cestovní adaptér
 HU Univerzális utazó adapter
 RO Adaptor universal de călătorie
 FR Adaptateur de voyage universel
 IT Adattatore universale da viaggio
 ES Adaptador universal de viaje
 CN 旅行转换插头

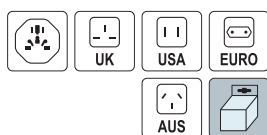

YATO **YT-81302** 50

EN Universal travel adapter with USB
 PL Uniwersalny adapter podróży z USB
 DE Universal-Reisestecker mit USB
 RU Универсальный дорожный адаптер-переходник с USB
 CZ Univerzální cestovní adaptér s USB
 HU Univerzális utazó adapter USB-vel
 RO Adaptor universal de călătorie cu USB
 FR Adaptateur de voyage universel avec USB
 IT Adattatore universale da viaggio con USB
 ES Adaptador universal de viaje con USB
 CN 旅行转换插头

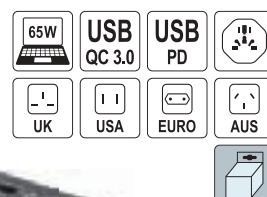

YATO **YT-81303** 40

EN Rubber protection extension cord
 PL Przedłużacz w osłonie gumowej
 DE Gummi Verlängerungskabel
 RU Удлинитель в резиновой изоляции
 CZ Prodlužovací kabel s gumovou izolací
 HU Gumi szigetelésű hosszabbító
 RO Cablu prelungitor electric
 FR Rallonge en caoutchouc
 IT Cavo di prolunga in gomma
 ES Cable de extensión con protección de caucho
 CN 电缆延长线

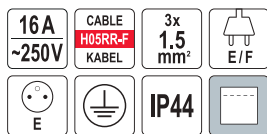

YATO	L [m]	
YT-81025	10	12
YT-81026	20	7
YT-81027	30	6
YT-81028	40	4

EN Rubber protection extension cord
 PL Przedłużacz w osłonie gumowej
 DE Gummi Verlängerungskabel
 RU Удлинитель в резиновой изоляции
 CZ Prodlužovací kabel s gumovou izolací
 HU Gumi szigetelésű hosszabbító
 RO Cablu prelungitor electric
 FR Rallonge en caoutchouc
 IT Cavo di prolunga in gomma
 ES Cable de extensión con protección de caucho
 CN 电缆延长线

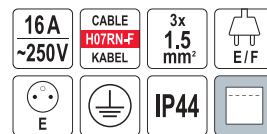

YATO	L [m]	
YT-81121	5	18
YT-81122	10	12

EN Rubber protection extension cord
PL Przedłużacz w osłonie gumowej
DE Gummi Verlängerungskabel
RU Удлинитель в резиновой изоляции
CZ Prodlužovací kabel s gumovou izolací
HU Gumi szigetelésű hosszabbító
RO Cablu prelungitor electric
FR Rallonge en caoutchouc
IT Cavo di prolunga in gomma
ES Cable de extensión con protección de caucho
CN 电缆延长线

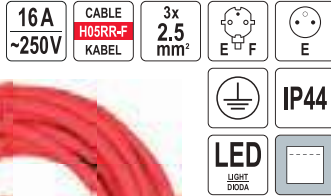

YATO	L [m]	
YT-81000	10	8
YT-81001	20	5
YT-81002	30	3
YT-81003	40	2

EN Rubber protection extension cord
PL Przedłużacz w osłonie gumowej
DE Gummi Verlängerungskabel
RU Удлинитель в резиновой изоляции
CZ Prodlužovací kabel s gumovou izolací
HU Gumi szigetelésű hosszabbító
RO Cablu prelungitor electric
FR Rallonge en caoutchouc
IT Cavo di prolunga in gomma
ES Cable de extensión con protección de caucho
CN 电缆延长线

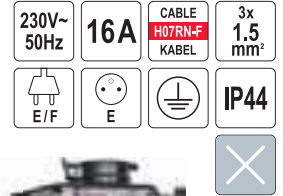

YATO	L [m]	
YT-8116	10	4
YT-81162	20	4

EN Extension cord
PL Przedłużacz budowlany
DE Bau-Verlängerungskabel
RU Удлинитель строительный
CZ Stavební prodlužovací kabel
HU Építőipari hosszabbító kábel
RO Prelungitor electric
FR Rallonge électrique
IT Prolunga da cantiere
ES Alargador de obra
CN 电缆延长线



YATO	L [m]	
YT-81030	10	10
YT-81031	15	5
YT-81032	25	4

EN Extension cord
PL Przedłużacz elektryczny
DE Verlängerungskabel
RU Удлинитель электрический
CZ Elektrický prodlužovač
HU Elektromos hosszabbító
RO Prelungitor electric
FR Rallonge électrique
IT Prolunga elettrica
ES Extensión eléctrica
CN 电源连接器

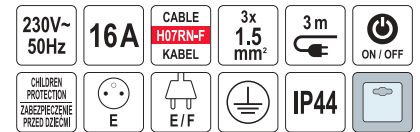

YATO	L [m]		Socket type / Typ gniazda	
YT-81240	3	3	E	10
YT-81241	3	4	E	10
YT-81242	3	5	E	10

EN Cable reel
PL Przedłużacz zwijany
DE Kabeltrommel
RU Удлинитель электрический
CZ Bubenový prodlužovač
HU Kábeldob
RO Prelungitor pe tambur
FR Rallonge électrique sur tambour enrouleur
IT Avvolgicavo con bobina
ES Cable de prolongación de tambor
CN 电缆卷轴

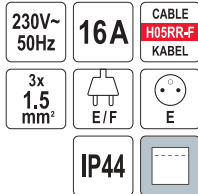

P_{max} = 1000 W coiled
P_{max} = 3000 W uncoiled
P_{max} = 1000 W zwinięty
P_{max} = 3000 W rozwinęty

YATO	L [m]	
YT-81052	20	2
YT-81053	30	2
YT-81054	40	2

EN Cable reel
PL Przedłużacz zwijany
DE Kabeltrommel
RU Удлинитель электрический
CZ Bubenový prodlužovač
HU Kábeldob
RO Prelungitor pe tambur
FR Rallonge électrique sur tambour enrouleur
IT Avvolgicavo con bobina
ES Cable de prolongación de tambor
CN 电缆延长线

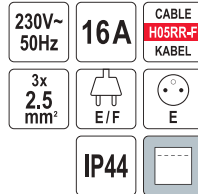

P_{max} = 1200 W coiled
P_{max} = 3600 W uncoiled
P_{max} = 1200 W zwinięty
P_{max} = 3600 W rozwinęty

YATO	L [m]	
YT-8106	30	1
YT-8107	40	1
YT-8108	50	1

EN Cable reel
PL Przedłużacz zwijany
DE Kabeltrommel
RU Удлинитель электрический
CZ Bubenový prodlužovač
HU Kábeldob
RO Prelungitor pe tambur
FR Rallonge électrique sur tambour enrouleur
IT Avvolgicavo con bobina
ES Cable de prolongación de tambor
CN 电缆延长线

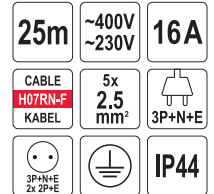

~230 V; 2P+E:
P_{max} = 1200 W coiled
P_{max} = 3000 W uncoiled
~400 V; 3P+N+E:
P_{max} = 3000 W coiled
P_{max} = 9000 W uncoiled
~230 V; 2P+E:
P_{max} = 1200 W zwinięty
P_{max} = 3000 W rozwinęty
~400 V; 3P+N+E:
P_{max} = 3000 W zwinięty
P_{max} = 9000 W rozwinęty

YATO	L [m]	
YT-8120	25	1

22

Garden tools
Narz dzia ogrodnicze

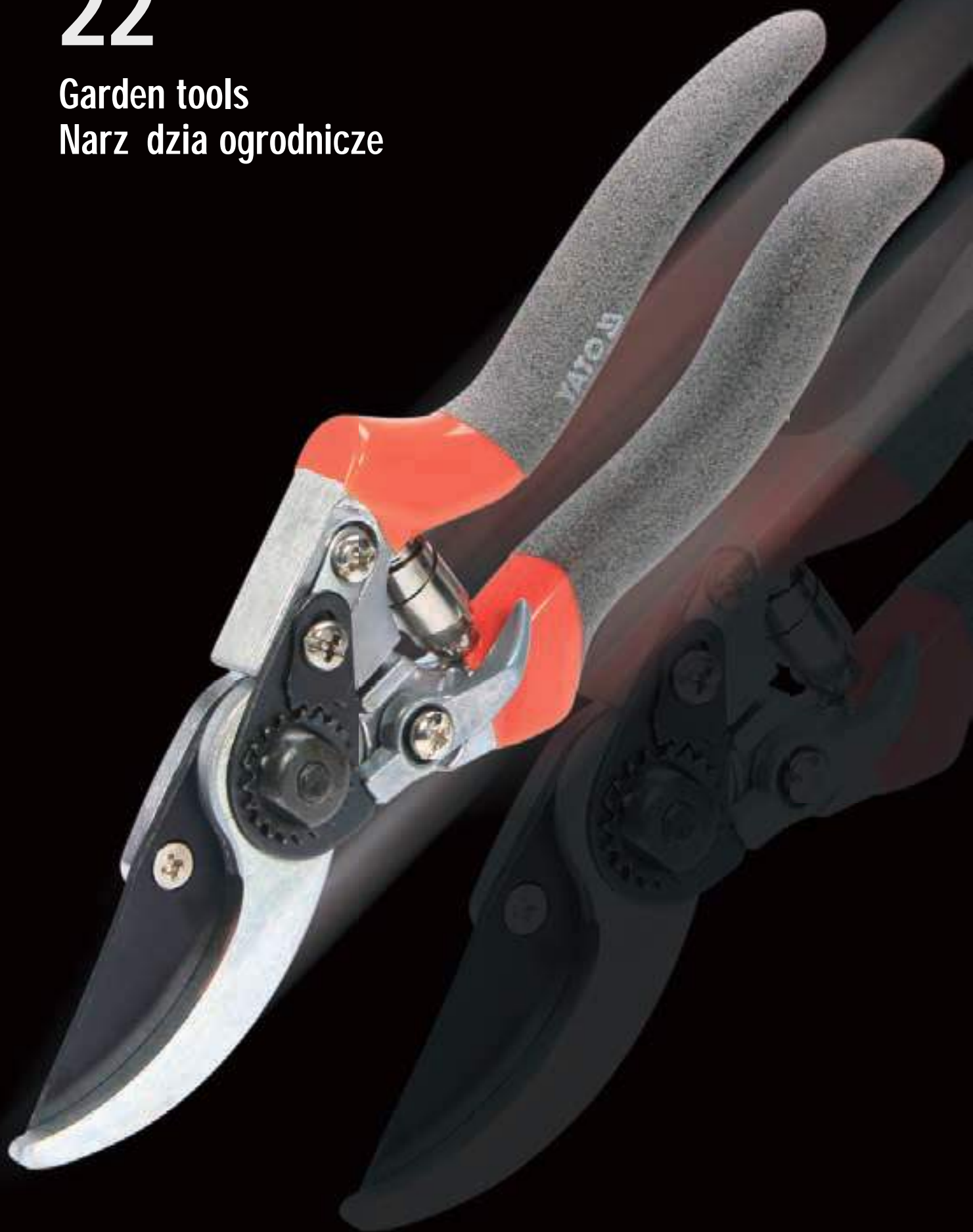

Watering program
Program wodny

656-660



Hand tools
Narzędzia ręczne

666-669



Hose connectors, male connectors, couplings, hose menders

Złącza, nypły, łączniki, rozgałęźniacze, reparatory..... 656

Hose nozzles (sprinklers) & sets

Zraszacze i zestawy..... 658

Garden hose holders

Stojaki na węże ogrodowe..... 660

Small garden tools

Małe narzędzia ogrodowe..... 666

Big garden tools

Duże narzędzia ogrodowe..... 667

Accessories

Akcesoria..... 668

Pruners & shears

Sekatory i nożyce ogrodowe

660-665



Pruners

Sekatory..... 660

Lopping shears

Sekatory do gałęzi..... 663

Leverage tree pruners

Sekatory gąsienicowe..... 664

Hedge shears

Nożyce do żywopłotu..... 665

Grass shears

Nożyce do trawy..... 665

EN Hose connector
 PL Złącze standard
 DE Universal-Schlauchkupplung
 RU Соединитель
 CZ Rychlospojka
 HU Tömítő-gyorscsatlakozó
 RO Conector furtun
 FR Raccord standard
 IT Raccordo rapido
 ES Conector para manguera
 CN 通水接头

Ø1/2"
 12.7mm

ABS
 PP
 TPR



YATO 

YT-99801

12/120

EN Waterstop hose connector
 PL Złącze stop
 DE Schlauchkupplung mit Wasserstop
 RU Соединитель с автостопом
 CZ Rychlospojka se stop ventilem
 HU Gyorscsatlakozó víz-stop
 RO Conector furtun cu funcție stop
 FR Raccord stop
 IT Raccordo rapido con acqua stop
 ES Conector para manguera con stop
 CN 止水接头

Ø1/2"
 12.7mm

STOP

ABS
 PP
 TPR



YATO 

YT-99803

12/120

EN Hose connector
 PL Złącze standard
 DE Universal-Schlauchkupplung
 RU Соединитель
 CZ Rychlospojka
 HU Tömítő-gyorscsatlakozó
 RO Conector furtun
 FR Raccord standard
 IT Raccordo rapido
 ES Conector para manguera
 CN 通水接头

Ø3/4"
 19mm

ABS
 PP
 TPR



YATO 

YT-99802

12/120

EN Waterstop hose connector
 PL Złącze stop
 DE Schlauchkupplung mit Wasserstop
 RU Соединитель с автостопом
 CZ Rychlospojka se stop ventilem
 HU Gyorscsatlakozó víz-stop
 RO Conector furtun cu funcție stop
 FR Raccord stop
 IT Raccordo rapido con acqua stop
 ES Conector para manguera con stop
 CN 止水接头

Ø3/4"
 19mm

STOP

ABS
 PP
 TPR



YATO 

YT-99804

12/120

EN Hose mender
 PL Reparatör do węzła
 DE Schlauchreparatur
 RU Муфта ремонтная для шланга
 CZ Hadicová spojka
 HU Tömítőlédő
 RO Mufă îmbinare
 FR Réparateur de tuyau
 IT Riparatore giuntatubi
 ES Reparatör para manguera
 CN 修补接头

Ø1/2"
 12.7mm

ABS
 PP
 TPR



YATO 

YT-99810

12/120

EN Hose mender
 PL Reparatör do węzła
 DE Schlauchreparatur
 RU Муфта ремонтная для шланга
 CZ Hadicová spojka
 HU Tömítőlédő
 RO Mufă îmbinare
 FR Réparateur de tuyau
 IT Riparatore giuntatubi
 ES Reparatör para manguera
 CN 修补接头

Ø3/4"
 19mm

ABS
 PP
 TPR



YATO 

YT-99811

12/120

EN Hose reducer
 PL Reparatör redukcyjny do węzła
 DE Reparaturstück mit Reduzierung
 RU Редуктор для шланга
 CZ Hadicová redukční spojka
 HU Tömítő összekötő
 RO Mufă îmbinare
 FR Réducteur de tuyau
 IT Giunto di riduzione per tubi
 ES Reductor de manguera
 CN 修补接头

Ø1/2"
 12.7mm

Ø3/4"
 19mm

ABS



YATO 

YT-8979

24/240

EN Tap adaptor
 PL Przyłącze do kranu
 DE Wasserhahnanschluss
 RU Адаптер для крана
 CZ Kohoutkový adaptér
 HU Csapcsatlakozó
 RO Adaptor robinet
 FR Raccord à robinet
 IT Connettore per rubinetto
 ES Conexión de grifo
 CN 水龙头转换接头

ABS



YATO 

YT-8970

24/240

EN Tap adaptor
 PL Przyłącze do kranu
 DE Wasserhahnanschluss
 RU Адаптер для крана
 CZ Kohoutkový adaptér
 HU Csapcsatlakozó
 RO Adaptor robinet
 FR Raccord à robinet
 IT Connettore per rubinetto
 ES Conexión de grifo
 CN 水龙头转换接头

(F)
 G3/4

ABS



YATO 

YT-8971

12/120

EN Tap adaptor
 PL Przyłącze do kranu
 DE Wasserhahnanschluss
 RU Адаптер для крана
 CZ Kohoutkový adaptér
 HU Csapcsatlakozó
 RO Adaptor robinet
 FR Raccord à robinet
 IT Connettore per rubinetto
 ES Conexión de grifo
 CN 水龙头转换接头

(F)
 G3/4

ABS
 TPR



YATO 

YT-99812

12/120

EN Tap adaptor
 PL Przyłącze do kranu
 DE Wasserhahnanschluss
 RU Адаптер для крана
 CZ Kohoutkový adaptér
 HU Csapcsatlakozó
 RO Adaptor robinet
 FR Raccord à robinet
 IT Connettore per rubinetto
 ES Conexión de grifo
 CN 水龙头转换接头

(F)
 G1

ABS



YATO 

YT-8972

12/120

EN Tap adaptor
 PL Przyłącze do kranu
 DE Wasserhahnanschluss
 RU Адаптер для крана
 CZ Kohoutkový adaptér
 HU Csapcsatlakozó
 RO Adaptor robinet
 FR Raccord à robinet
 IT Connettore per rubinetto
 ES Conexión de grifo
 CN 水龙头转换接头

(F)
 G1

ABS
 TPR



YATO 

YT-99813

12/120

EN Tap adaptor
PL Przyłącze do kranu
DE Wasserhahnanschluss
RU Адаптер для крана
CZ Kohoutkový adaptér
HU Csapcsatlakozó
RO Adaptor robinet
FR Raccord à robinet
IT Connettore per rubinetto
ES Conexión de grifo
CN 水龙头转换接头



(F)
G1/2
(F)
G3/4
ABS



YATO
YT-8973

12/120

EN Tap adaptor
PL Przyłącze do kranu
DE Wasserhahnanschluss
RU Адаптер для крана
CZ Kohoutkový adaptér
HU Csapcsatlakozó
RO Adaptor robinet
FR Raccord à robinet
IT Connettore per rubinetto
ES Conexión de grifo
CN 水龙头转换接头



(F)
G1/2
(F)
G3/4
ABS
TPR



YATO
YT-99814

12/120

EN Tap adaptor
PL Przyłącze do kranu
DE Wasserhahnanschluss
RU Адаптер для крана
CZ Kohoutkový adaptér
HU Csapcsatlakozó
RO Adaptor robinet
FR Raccord à robinet
IT Connettore per rubinetto
ES Conexión de grifo
CN 水龙头转换接头



(F)
G3/4
(F)
G1
ABS



YATO
YT-8974

12/120

EN Tap adaptor
PL Przyłącze do kranu
DE Wasserhahnanschluss
RU Адаптер для крана
CZ Kohoutkový adaptér
HU Csapcsatlakozó
RO Adaptor robinet
FR Raccord à robinet
IT Connettore per rubinetto
ES Conexión de grifo
CN 水龙头转换接头



(F)
G3/4
(F)
G1
ABS
TPR



YATO
YT-99815

12/120

EN Tap adaptor
PL Przyłącze do kranu
DE Wasserhahnanschluss
RU Адаптер для крана
CZ Kohoutkový adaptér
HU Csapcsatlakozó
RO Adaptor robinet
FR Raccord à robinet
IT Connettore per rubinetto
ES Conexión de grifo
CN 水龙头转换接头



(M)
G3/4
ABS



YATO
YT-8975

24/240

EN Hose coupling
PL Łącznik
DE Schlauchkupplung
RU Соединитель
CZ Spojka
HU Tömölcsatlakozás
RO Racord
FR Raccord
IT Raccordo
ES Acoplador
CN 接头



ABS



YATO
YT-8976

24/240

EN Hose coupling
PL Rozdzielacz
DE Wasserverteiler
RU Тройник-соединитель
CZ Rozdělovač
HU Vízelosztó
RO Racord 3 căi
FR Séparateur de tuyau
IT Distributore
ES Divisor de manguera
CN 三通接头



ABS



YATO
YT-8977

24/240

EN Y-switch coupling with swivel
PL Rozdzielacz z zaworami
DE 2-Wege Ventil
RU Распределитель внешний
CZ Rozbočovač s uzavíracími ventily
HU Y-elágazó, 2 db elzáróval
RO Racord tip „Y” cu robinet
FR Dérivation type „Y”
IT Distributore con valvole
ES Distribuidor tipo „Y”
CN 双通水管转换接头



(M) (F)
G3/4 **G3/4**
ABS



YATO
YT-8978

24/240

EN One way tap adaptor
PL Zawór ogrodowy
DE Garten-Ventil
RU Вентиль
CZ Ventil
HU Szelep
RO Ștuț cu conector reglabil
FR Raccord régulateur
IT Valvola giardino
ES Válvula
CN 接头



(F)
G3/4
BRASS
MOSIADZ
AI
ABS



YATO
YT-9940

12/48

EN Y-switch coupling with swivel
PL Rozdzielacz z zaworami
DE 2-Wege Ventil
RU Распределитель внешний
CZ Rozbočovač s uzavíracími ventily
HU Y-elágazó, 2 db elzáróval
RO Racord tip „Y” cu robinet
FR Soupape double
IT Distributore con valvole
ES Distribuidor tipo „Y”
CN 两用转换接头



(F) (F)
G3/4 **G1**
ABS



YATO
YT-99848

12/48

EN Y-switch coupling with swivel
PL Rozdzielacz z zaworami
DE 2-Wege Ventil
RU Распределитель внешний
CZ Rozbočovač s uzavíracími ventily
HU Y-elágazó, 2 db elzáróval
RO Racord tip „Y” cu robinet
FR Soupape double
IT Distributore con valvole
ES Distribuidor tipo „Y”
CN 两用转换接头



(F) **BRASS**
G3/4 **MOSIADZ**
AI **ABS**



YATO
YT-9941

12/48

EN Adjustable spray nozzle
 PL Zrasczacz prosty regulowany
 DE Einstellbare Spritze
 RU Регулируемый распылительный наконечник
 CZ Postřikovač nastavitelný
 HU Egyszerű szabályozható szórófej

RO Duză de stropit
 FR Lance arrosage réglable
 IT Lancia spruzzo regolabile
 ES Rociador de pico ajustable
 CN 调节式水枪



ABS
PP
TPR



YATO

YT-99830

12/120

EN Adjustable spray gun
 PL Pistolet zraszający regulowany
 DE Regelbare Sprühpistole
 RU Регулируемый оросительный пистолет
 CZ Kropící pistole regulovatelná
 HU Öntöző pisztoly állítható sugarú
 RO Pistol de stropit reglabil
 FR Pistolet d'arrosage réglé
 IT Pistola a spruzzo regolabile
 ES Pistola rociadora ajustable
 CN 调节式水枪

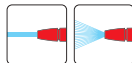

BRASS
MOSIADZ



YATO

YT-8967

12

EN Multifunction sprinkling gun
 PL Wielofunkcyjny pistolet zraszający
 DE Multifunktions-Spritzpistole
 RU Многофункциональный оросительный пистолет
 CZ Multifunkční postřikovací pistole
 HU Többfunkciós öntöző pisztoly
 RO Pistol de stropit
 FR Pistolet d'arrosage multifonctions
 IT Multifunzione pistola a spruzzo
 ES Pistola para regar multifuncional
 CN 水枪

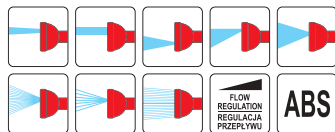

ABS



YATO

YT-99841

12/48

EN Adjustable spray gun
 PL Pistolet zraszający regulowany
 DE Regelbare Sprühpistole
 RU Регулируемый оросительный пистолет
 CZ Kropící pistole regulovatelná
 HU Öntöző pisztoly állítható sugarú
 RO Pistol de stropit reglabil
 FR Pistolet d'arrosage réglé
 IT Pistola a spruzzo regolabile
 ES Pistola rociadora ajustable
 CN 调节式水枪

RO Duză de stropit
 FR Lance arrosage réglable
 IT Lancia spruzzo regolabile
 ES Rociador de pico ajustable
 CN 调节式水枪



ABS
PP
TPR



YATO

YT-8957

12/48

EN Multifunction sprinkling gun
 PL Wielofunkcyjny pistolet zraszający
 DE Multifunktions-Spritzpistole
 RU Многофункциональный оросительный пистолет
 CZ Multifunkční postřikovací pistole
 HU Többfunkciós öntöző pisztoly
 RO Pistol de stropit
 FR Pistolet d'arrosage multifonctions
 IT Multifunzione pistola a spruzzo
 ES Pistola para regar multifuncional
 CN 水枪

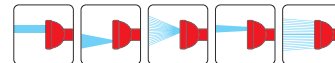

AI

ABS



YATO

YT-8960

12/48

EN Multifunction sprinkling gun
 PL Wielofunkcyjny pistolet zraszający
 DE Multifunktions-Spritzpistole
 RU Многофункциональный оросительный пистолет
 CZ Multifunkční postřikovací pistole
 HU Többfunkciós öntöző pisztoly
 RO Pistol de stropit
 FR Pistolet d'arrosage multifonctions
 IT Multifunzione pistola a spruzzo
 ES Pistola para regar multifuncional
 CN 水枪

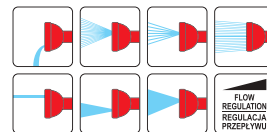

ABS



YATO

YT-8968

12

EN Basic hose set with straight nozzle
PL Zestaw złączek ze zraszaczem prostym
DE Bewässerungs Spritz und Anschlusset
RU Набор поливочный
CZ Sada postřikovač a spojky
HU Készlet gyorskapocsal csaphoz
RO Ștut furtun apă cu accesorii pt. robinet
FR Set d'arrosage raccord
IT Set raccordi con sprinkler semplice
ES Juego de rociar tubuladura de grifo
CN 花园浇水软管



YATO
YT-99831

48

EN Basic hose set with straight nozzle
PL Zestaw złączek ze zraszaczem prostym
DE Bewässerungs Spritz und Anschlusset
RU Набор поливочный
CZ Sada postřikovač a spojky
HU Készlet gyorskapocsal csaphoz
RO Ștut furtun apă cu accesorii pt. robinet
FR Set d'arrosage raccord
IT Set raccordi con sprinkler semplice
ES Juego de rociar tubuladura de grifo
CN 花园浇水软管



YATO
YT-99832

48

EN Impulse sprinkler
PL Zraszacz impulsowy
DE Impulssprenger
RU Распылитель импульсный на пике
CZ Postřikovač
HU Impulzus szórófej
RO Aspersor cu impuls
FR Arroseur impulsion sur piquet
IT Sprinkler impulso
ES Rociador
CN 脉冲洒水器



YATO
YT-8985

48

EN Impulse sprinkler
PL Zraszacz impulsowy
DE Impulssprenger
RU Распылитель импульсный на пике
CZ Postřikovač
HU Impulzus szórófej
RO Aspersor cu impuls
FR Arroseur impulsion sur piquet
IT Sprinkler impulso
ES Rociador
CN 脉冲洒水器



YATO
YT-8986

48

EN 3-arms revolving sprinkler
PL Zraszacz 3-ramienny
DE 3-Arm Kreis-Regner
RU Трёхсторонний распылитель
CZ Rozprašovac třiramenny
HU Forgó locsoló leszűrhető
RO Aspersor cu 3 brațe
FR Arroseur sur piquet 3 branches
IT Tre braccio sprinkler
ES Rociador 3-brazos
CN 三叉插针洒水器



YATO
YT-8987

48

EN Tripod impulse sprinkler
PL Zraszacz impulsowy na statywie
DE Impulssprenger
RU Распылитель импульсный
CZ Postřikovač
HU Impulzus szórófej
RO Aspersor cu picior
FR Arroseur impulsion lance
IT Sprinkler impulso su un treppiede
ES Rociador
CN 洒水器



YATO
YT-8984

12

EN 8-pattern sprinkler
PL Zraszacz 8-funkcyjny
DE 8-Flächenregner
RU Распылитель 8-позиционный
CZ Postřikovač 8-funkční
HU 8 funkciós szórófej
RO Stropitor apă cu 8 funcții
FR Turbine d'arrosage 8 fonctionnes
IT Sprinkler 8-funzioni
ES Rociador 8-funciones de tierra
CN 洒水器

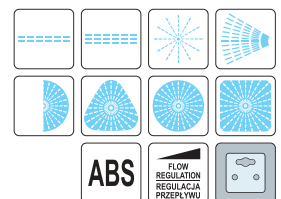

YATO
YT-8991

48

EN Aluminium tube oscillating sprinkler
 PL Zraszacz oscylacyjny z rurką aluminiową
 DE Rechteckregner
 RU Распылитель осциллирующий
 CZ Obdélníkový zavlažovač
 HU Oszillációs szórófej

RO Aspersor oscilant
 FR Arroseur oscillant aluminium
 IT Oscillante sprinkler con tubo di alluminio
 ES Aspersor oscilante con tubo de aluminio
 CN 摇摆洒水器

17 HOLES, 17WAYS

AI

ABS



YATO **YT-8993** 6

EN Aluminium tube oscillating sprinkler
 PL Zraszacz oscylacyjny z rurką aluminiową
 DE Rechteckregner
 RU Распылитель осциллирующий
 CZ Obdélníkový zavlažovač
 HU Oszillációs szórófej

RO Aspersor oscilant
 FR Arroseur oscillant aluminium
 IT Oscillante sprinkler con tubo di alluminio
 ES Aspersor oscilante con tubo de aluminio
 CN 摇摆洒水器

17 HOLES, 17WAYS

AI

ABS



YATO **YT-99845** 6

EN Hose holder
 PL Stojak do węża ogrodowego
 DE Gartenschlauchträger
 RU Барабан для намотки поливочного шланга
 CZ Stojan navijecí na zahradní hadici
 HU Utartódob locsolótömlőhöz
 RO Suport pt. furtun de grădină
 FR Dévidoir portable de tuyau
 IT Carrello avvolgitubo
 ES Estante para manguera de jardín
 CN 卷线盘



20 m $\varnothing 3/4" (19\text{mm})$

50 m $\varnothing 1 1/2" (38\text{mm})$

PP

YATO **YT-99850** 2

EN Hose cart
 PL Wózek do węża ogrodowego
 DE Gartenschlauchwagen
 RU Барабан для намотки поливочного шланга
 CZ Stojan navijecí na zahradní hadici
 HU Utartódob locsolótömlőhöz
 RO Suport pt. furtun de grădină
 FR Dévidoir sur roues
 IT Carrello avvolgitubo
 ES Carretila para manguera de jardín
 CN 卷线盘



20 m $\varnothing 3/4" (19\text{mm})$

50 m $\varnothing 1 1/2" (38\text{mm})$

PP

YATO **YT-99852** 2

EN Bypass pruner
 PL Sekator nożycowy
 DE Gartenschere
 RU Садовый секатор
 CZ Dvoubité zahradní nůžky
 HU Metszőolló

RO Foarfecă de grădină
 FR Sécateur de jardin
 IT Forbici da potatura bypass
 ES Tijera de poda bypass
 CN 剪枝剪

205 mm



YATO L [mm] **YT-8800** 205 12/72

EN Bypass pruner
 PL Sekator nożycowy
 DE Gartenschere
 RU Садовый секатор
 CZ Dvoubité zahradní nůžky
 HU Metszőolló

RO Foarfecă de grădină
 FR Sécateur de jardin
 IT Forbici da potatura bypass
 ES Tijera de poda bypass
 CN 剪枝剪

220 mm



YATO L [mm] **YT-8801** 220 12/72

EN Anvil pruner
 PL Sekator kowadełkowy
 DE Amboss-Gartenschere
 RU Секатор с наковальней
 CZ Kovadlinkové zahradní nůžky
 HU Üllős metszőolló

RO Foarfecă cu nicovală
 FR Sécateur à enclume
 IT Forbici da potatura a incudine
 ES Tijera de poda de yunque
 CN 修枝剪

200 mm



YATO L [mm] **YT-8802** 200 12/72

EN Bypass pruner
 PL Sekator nożycowy
 DE Gartenschere
 RU Садовый секатор
 CZ Dvoubité zahradní nůžky
 HU Metszőolló

RO Foarfecă de grădină
 FR Sécateur de jardin
 IT Forbici da potatura bypass
 ES Tijera de poda bypass
 CN 剪枝剪

180 mm



YATO L [mm] **YT-8805** 180 12/72

EN Ratchet anvil pruner
PL Sekator kowadełkowy z grzechotką
DE Amboss-Gartenschere mit Ratsche
RU Секатор с наковальной и храповым механизмом
CZ Kovadlinkové zahradní nůžky s ráčnou
HU Racsnis üllös metszőolló

RO Foarfecă nicovală cu clichet
FR Sécateur à enclume à cliquet
IT Forbici a incudine con cricchetto
ES Tijera de poda de yunque con carraca
CN 棘轮剪枝剪



YATO L [mm] 200 12/72
YT-8807

EN Ratchet anvil pruner
PL Sekator kowadełkowy z grzechotką
DE Amboss-Gartenschere mit Ratsche
RU Секатор с наковальной и храповым механизмом
CZ Kovadlinkové zahradní nůžky s ráčnou
HU Racsnis üllös metszőolló

RO Foarfecă nicovală cu clichet
FR Sécateur à enclume à cliquet
IT Forbici a incudine con cricchetto
ES Tijera de poda de yunque con carraca
CN 棘轮剪枝剪



YATO L [mm] 200 12/72
YT-8808

EN Bypass pruner
PL Sekator nożycowy
DE Gartenschere
RU Садовый секатор
CZ Dvoubřité zahradní nůžky
HU Metszőolló

RO Foarfecă de grădină
FR Sécateur de jardin
IT Forbici da potatura bypass
ES Tijera de poda bypass
CN 剪枝剪



YATO L [mm] 210 12/72
YT-8809

EN Bypass pruner
PL Sekator nożycowy
DE Gartenschere
RU Садовый секатор
CZ Dvoubřité zahradní nůžky
HU Metszőolló

RO Foarfecă de grădină
FR Sécateur de jardin
IT Forbici da potatura bypass
ES Tijera de poda bypass
CN 剪枝剪



YATO L [mm] 190 12/72
YT-8811

EN Bypass pruner
PL Sekator nożycowy
DE Gartenschere
RU Садовый секатор
CZ Dvoubřité zahradní nůžky
HU Metszőolló

RO Foarfecă de grădină
FR Sécateur de jardin
IT Forbici da potatura bypass
ES Tijera de poda bypass
CN 剪枝剪



YATO L [mm] 200 12/72
YT-8845

EN Bypass pruner
PL Sekator nożycowy
DE Gartenschere
RU Садовый секатор
CZ Dvoubřité zahradní nůžky
HU Metszőolló

RO Foarfecă de grădină
FR Sécateur de jardin
IT Forbici da potatura bypass
ES Tijera de poda bypass
CN 剪枝剪



YATO L [mm] 200 12/60
YT-8790

EN Fruit and flower shears
PL Sekator do obcinania zawiązków
DE Blumen- und Traubenschere
RU Секатор садовый виноградный
CZ Zahradnické nůžky na pupeny
HU Zöldség- és gyümölcs metszőolló

RO Foarfecă pt. grădină
FR Ciseaux à fleurs
IT Forbici per raccolta frutta
ES Tijera para podar fruta
CN 剪枝剪

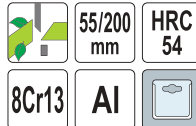

YATO L [mm] 200 12/60
YT-8791

EN Fruit and flower shears
PL Sekator do obcinania zawiązków
DE Blumen- und Traubenschere
RU Секатор садовый виноградный
CZ Zahradnické nůžky na pupeny
HU Zöldség- és gyümölcs metszőolló

RO Foarfecă pt. grădină
FR Ciseaux à fleurs
IT Forbici per raccolta frutta
ES Tijera para podar fruta
CN 剪枝剪



YATO L [mm] 180 12/72
YT-8815

EN Fruit and flower shears
PL Sekator do obcinania zawiązków
DE Blumen- und Traubenschere
RU Секатор садовый виноградный
CZ Zahradnické nůžky na pupeny
HU Zöldség- és gyümölcs metszőolló

RO Foarfecă pt. grădină
FR Ciseaux à fleurs
IT Forbici per raccolta frutta
ES Tijera para podar fruta
CN 剪枝剪



YATO L [mm] 190 12/72
YT-8816

EN Fruit and flower shears
PL Sekator do obcinania zawiązków
DE Blumen- und Traubenschere
RU Секатор садовый виноградный
CZ Zahradnické nůžky na pupeny
HU Zöldség- és gyümölcs metszőolló

RO Foarfecă pt. grădină
FR Ciseaux à fleurs
IT Forbici per raccolta frutta
ES Tijera para podar fruta
CN 剪枝剪



YATO L [mm] 190 12/72
YT-8817

EN Grafting tool
 PL Sekator do szczepień
 DE Gartenschere zum Pfropfen
 RU Секатор для прививки
 CZ Roubovací nůžky
 HU Oltó olló
 RO Instrument pt. altoit
 FR Sécateur de greffage
 IT Forbici da innesto
 ES Tijera injertadora
 CN 嫁接剪

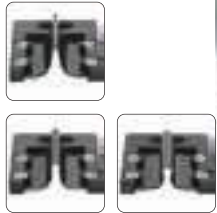

YATO  L [mm] 
 YT-88505 20

EN Anvil pruner
 PL Sekator kowadełkowy
 DE Amboss-Gartenschere
 RU Секатор с наковальной
 CZ Kovadlinkové zahradní nůžky
 HU Üllős metszőolló
 RO Foarfecă cu nicovală
 FR Sécateur à enclume
 IT Forbici da potatura a incudine
 ES Tijera de poda de yunque
 CN 修枝剪



YATO  L [mm] 
 YT-88182 208 12/48

EN Bypass pruner
 PL Sekator nożycowy
 DE Gartenschere
 RU Садовый секатор
 CZ Dvoubřité zahradní nůžky
 HU Metszőolló
 RO Foarfecă de grădină
 FR Sécateur de jardin
 IT Forbici da potatura bypass
 ES Tijera de poda bypass
 CN 剪枝剪



YATO  L [mm] 
 YT-88185 220 12/48

EN Bypass pruner
 PL Sekator nożycowy
 DE Gartenschere
 RU Садовый секатор
 CZ Dvoubřité zahradní nůžky
 HU Metszőolló
 RO Foarfecă de grădină
 FR Sécateur de jardin
 IT Forbici da potatura bypass
 ES Tijera de poda bypass
 CN 剪枝剪



YATO  L [mm] 
 YT-88190 208 12/48



EN Bypass pruner
 PL Sekator nożycowy
 DE Gartenschere
 RU Садовый секатор
 CZ Dvoubřité zahradní nůžky
 HU Metszőolló
 RO Foarfecă de grădină
 FR Sécateur de jardin
 IT Forbici da potatura bypass
 ES Tijera de poda bypass
 CN 剪枝剪



YATO  L [mm] 
 YT-88180 208 12/48



EN Bypass pruner
 PL Sekator nożycowy
 DE Gartenschere
 RU Садовый секатор
 CZ Dvoubřité zahradní nůžky
 HU Metszőolló
 RO Foarfecă de grădină
 FR Sécateur de jardin
 IT Forbici da potatura bypass
 ES Tijera de poda bypass
 CN 剪枝剪



YATO  L [mm] 
 YT-88183 205 12/48



EN Bypass pruner
 PL Sekator nożycowy
 DE Gartenschere
 RU Садовый секатор
 CZ Dvoubřité zahradní nůžky
 HU Metszőolló
 RO Foarfecă de grădină
 FR Sécateur de jardin
 IT Forbici da potatura bypass
 ES Tijera de poda bypass
 CN 剪枝剪



YATO  L [mm] 
 YT-88186 220 12/48

EN Anvil pruner
 PL Sekator kowadełkowy
 DE Amboss-Gartenschere
 RU Секатор с наковальной
 CZ Kovadlinkové zahradní nůžky
 HU Üllős metszőolló
 RO Foarfecă cu nicovală
 FR Sécateur à enclume
 IT Forbici da potatura a incudine
 ES Tijera de poda de yunque
 CN 修枝剪



YATO  L [mm] 
 YT-88191 208 12/48

EN Bypass pruner
PL Sekator nożycowy
DE Gartenschere
RU Садовый секатор
CZ Dvoubřité zahradní nůžky
HU Metszőolló

RO Foarfecă de grădină
FR Sécateur de jardin
IT Forbici da potatura bypass
ES Tijera de poda bypass
CN 剪枝剪

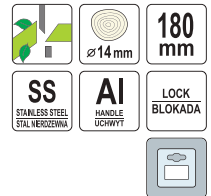

YATO	L [mm]	
YT-8843	180	5/60

EN Bypass pruner
PL Sekator nożycowy
DE Gartenschere
RU Садовый секатор
CZ Dvoubřité zahradní nůžky
HU Metszőolló

RO Foarfecă de grădină
FR Sécateur de jardin
IT Forbici da potatura bypass
ES Tijera de poda bypass
CN 剪枝剪



YATO	L [mm]	
YT-8849	200	12/72

EN Anvil lopper
PL Sekator kowadełkowy do gałęzi
DE Amboss-Astscherer
RU Сучкорез с наковальней
CZ Nůžky na větve kovadlinkové
HU Űllős ágvágvó olló

RO Foarfecă pt. crengi
FR Coupe-branches à enclume
IT Troncarami da potatura a incudine
ES Tijera corta ramas de yunque
CN 高枝剪



YATO	L [mm]	
YT-8832	635	12

EN Anvil lopper
PL Sekator kowadełkowy do gałęzi
DE Amboss-Astscherer
RU Сучкорез с наковальней
CZ Nůžky na větve kovadlinkové
HU Űllős ágvágvó olló

RO Foarfecă pt. crengi
FR Coupe-branches à enclume
IT Troncarami da potatura a incudine
ES Tijera corta ramas de yunque
CN 高枝剪



YATO	L [mm]	
YT-8834	700	12

EN Bypass lopper
PL Sekator nożycowy do gałęzi
DE Bypass-Astscherer
RU Сучкорез садовый
CZ Nůžky na větve dvoubřité
HU Bypass ágvágvó olló

RO Foarfecă pt. crengi
FR Coupe-branches
IT Troncarami da potatura bypass
ES Tijera corta ramas bypass
CN 高枝剪



YATO	L [mm]	
YT-8831	625	12

EN Bypass lopper
PL Sekator nożycowy do gałęzi
DE Bypass-Astscherer
RU Сучкорез садовый
CZ Nůžky na větve kovadlinkové
HU Bypass ágvágvó olló

RO Foarfecă pt. crengi
FR Coupe-branches
IT Troncarami da potatura bypass
ES Tijera corta ramas bypass
CN 高枝剪



YATO	L [mm]	
YT-8833	705	12

EN Anvil lopper
PL Sekator kowadełkowy do gałęzi
DE Amboss-Astscherer
RU Сучкорез с наковальней
CZ Nůžky na větve kovadlinkové
HU Űllős ágvágvó olló

RO Foarfecă pt. crengi
FR Coupe-branches à enclume
IT Troncarami da potatura a incudine
ES Tijera corta ramas de yunque
CN 高枝剪





YATO	L [mm]	
YT-8835	780	12

EN Anvil lopper
 PL Sekator kowadełkowy do gałęzi
 DE Amboss-Astschere
 RU Сучкорез с наковальной
 CZ Nůžky na větve kovadlinkové
 HU Űllős ágváágó olló

RO Foarfecă pt. crengi
 FR Coupe-branches à enclume
 IT Troncarami da potatura a incudine
 ES Tijera corta ramas de yunque
 CN 高枝剪





YATO 	L [mm]	
YT-8836	770	12

EN Telescopic bypass lopper
 PL Sekator do gałęzi nożycowy teleskopowy
 DE Teleskop-Bypass-Astschere
 RU Сучкорез телескопический
 CZ Teleskopické nůžky na větve dvoubřité
 HU Teleszkópos bypass ágváágó olló

RO Foarfecă telescopică pt. crengi
 FR Coupe-branches télescopique
 IT Troncarami telescopico bypass
 ES Tijera corta ramas bypass telescópica
 CN 可伸縮高枝剪





YATO 	L [mm]	
YT-8839	650-900	6

EN Telescopic bypass lopper
 PL Sekator do gałęzi nożycowy teleskopowy
 DE Teleskop-Bypass-Astschere
 RU Сучкорез телескопический
 CZ Teleskopické nůžky na větve dvoubřité
 HU Teleszkópos bypass ágváágó olló

RO Foarfecă telescopică pt. crengi
 FR Coupe-branches télescopique
 IT Troncarami telescopico bypass
 ES Tijera corta ramas bypass telescópica
 CN 可伸縮高枝剪



YATO 	L [mm]	
YT-8841	690-930	6

EN Leverage tree pruner
 PL Sekator gąsienicowy z piłą
 DE Baumsäge mit Astschere
 RU Сучкорез штанговый с пилой
 CZ Nůžky na větve s pilkou
 HU Hernyózó olló fűrészel
 RO Foarfecă si fierăstrău pt. crengi
 FR Echenilloir avec scie
 IT Sveltatoio con segaccio
 ES Sierra de podar con tijeras
 CN 高枝鋸

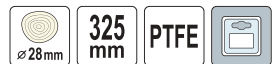



YATO 	L [mm]	
YT-8876	325	12

EN Telescopic bypass lopper
 PL Sekator do gałęzi nożycowy teleskopowy
 DE Teleskop-Bypass-Astschere
 RU Сучкорез телескопический
 CZ Teleskopické nůžky na větve dvoubřité
 HU Teleszkópos bypass ágváágó olló

RO Foarfecă telescopică pt. crengi
 FR Coupe-branches télescopique
 IT Troncarami telescopico bypass
 ES Tijera corta ramas bypass telescópica
 CN 可伸縮高枝剪





YATO 	L [mm]	
YT-8838	630-960	6/12

EN Telescopic anvil lopper
 PL Sekator do gałęzi kowadełkowy teleskopowy
 DE Teleskop-Amboss-Astschere
 RU Сучкорез телескопический с наковальной
 CZ Teleskopické nůžky na větve kovadlinkové
 HU Teleszkópos Űllős ágváágó olló

RO Foarfecă telescopică pt. crengi
 FR Coupe-branches à enclume télescopique
 IT Troncarami telescopico a incudine
 ES Tijera corta ramas de yunque telescópica
 CN 可伸縮高枝剪





YATO 	L [mm]	
YT-8840	640-885	12

EN Telescopic anvil lopper
 PL Sekator do gałęzi kowadełkowy teleskopowy
 DE Teleskop-Amboss-Astschere
 RU Сучкорез телескопический с наковальной
 CZ Teleskopické nůžky na větve kovadlinkové
 HU Teleszkópos Űllős ágváágó olló

RO Foarfecă telescopică pt. crengi
 FR Coupe-branches à enclume télescopique
 IT Troncarami telescopico a incudine
 ES Tijera corta ramas de yunque telescópica
 CN 可伸縮高枝剪



YATO 	L [mm]	
YT-8842	660-910	12

YATO 	L [mm]	
YT-8876	325	12

EN Hedge shears
PL Nożyce do żywoplotu
DE Hand-Heckenschere
RU Кусторез
CZ Nůžky na živý plot
HU Sövényvágó olló

RO Foarfecă pt. gard viu
FR Cisaille à haie
IT Cesioie per siepi
ES Tijera corta setos
CN 整篱剪



205/520
mm



YATO 	L [mm]	
YT-8821	520	24



EN Hedge shears
PL Nożyce do żywoplotu
DE Hand-Heckenschere
RU Кусторез
CZ Nůžky na živý plot
HU Sövényvágó olló

RO Foarfecă pt. gard viu
FR Cisaille à haie
IT Cesioie per siepi
ES Tijera corta setos
CN 整篱剪



254/650
mm



YATO 	L [mm]	
YT-8823	650	12



EN Grass shears
PL Nożyce do trawy wielopozycyjne
DE Handgrasschere
RU Ножницы для стрижки травы
CZ Nožnice na trávu
HU Forgatható fűvirító olló
RO Foarfeca pt. gazon
FR Cisaille à gazon
IT Cesioie per erba multifunzione
ES Tijeras de cesped
CN 草剪



130/330
mm

3
POSITIONS
POZYCJE



YATO 	L [mm]	
YT-8851	330	12/60

EN Grass shears
PL Nożyce do trawy wielopozycyjne
DE Handgrasschere
RU Ножницы для стрижки травы
CZ Nožnice na trávu
HU Forgatható fűvirító olló
RO Foarfeca pt. gazon
FR Cisaille à gazon
IT Cesioie per erba multifunzione
ES Tijeras de cesped
CN 草剪





130/370
mm

16
POSITIONS
POZYCJE

360°



YATO 	L [mm]	
YT-8853	370	6/72

EN Hedge shears
PL Nożyce do żywoplotu
DE Hand-Heckenschere
RU Кусторез
HU Sövényvágó olló

RO Foarfecă pt. gard viu
FR Cisaille à haie
IT Cesioie per siepi
ES Tijera corta setos
CN 整篱剪



205/550
mm



YATO 	L [mm]	
YT-8822	550	12



EN Telescopic hedge shears
PL Teleskopowe nożyce do żywoplotu
DE Teleskop-Hand-Heckenschere
RU Кусторез с телескопическими ручками
HU Teleszkópos sövényvágó olló

RO Foarfecă telescopică pt. gard viu
FR Cisaille à haie télescopique
IT Cesioie telescopiche per siepi
ES Tijera corta setos telescópica
CN 可伸缩整篱剪



210/
690-890
mm



YATO 	L [mm]	
YT-8824	690-890	6



EN Grass shears
PL Nożyce do trawy wielopozycyjne
DE Handgrasschere
RU Ножницы для стрижки травы
CZ Nožnice na trávu
HU Forgatható fűvirító olló
RO Foarfeca pt. gazon
FR Cisaille à gazon
IT Cesioie per erba multifunzione
ES Tijeras de cesped
CN 草剪



120/310
mm

8
POSITIONS
POZYCJE



YATO 	L [mm]	
YT-8852	310	6/24

EN Grass shears
PL Nożyce do trawy wielopozycyjne
DE Handgrasschere
RU Ножницы для стрижки травы
CZ Nožnice na trávu
HU Forgatható fűvirító olló
RO Foarfeca pt. gazon
FR Cisaille à gazon
IT Cesioie per erba multifunzione
ES Tijeras de cesped
CN 草剪





130/370
mm

16
POSITIONS
POZYCJE

360°



YATO 	L [mm]	
YT-8854	370	6/72

EN Folding pruning saw
 PL Piła ogrodnicza składana
 DE Klappgartensäge
 RU Пила садовая складная
 CZ Skládací zahradní pilka
 HU Összecsukható kerti fűrész
 RO Fierăstrău pliabil pt. crengi
 FR Scie à élaguer pliante
 IT Seghetto da potatura pieghevole
 ES Sierra para jardín plegable
 CN 折叠锯

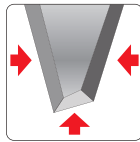

180 mm
 7TPI
 1.4 mm
 HRC 53-60
 SK5
 ABS
 TPR
 LOCK BLOKADA

EN Folding pruning saw
 PL Piła ogrodnicza składana
 DE Klappgartensäge
 RU Пила садовая складная
 CZ Skládací zahradní pilka
 HU Összecsukható kerti fűrész
 RO Fierăstrău pliabil pt. crengi
 FR Scie à élaguer pliante
 IT Seghetto da potatura pieghevole
 ES Sierra para jardín plegable
 CN 折叠锯

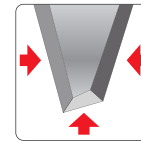

9TPI
 1.2 mm
 HRC 62-64
 SK5
 PTFE
 ABS TPR



YATO	L [mm]	
YT-87725	180	12/48

YATO	L [mm]	
YT-87730	180	12/48
YT-87731	210	12/48
YT-87732	250	12/48

EN Pruning saw with sheath
 PL Piła ogrodnicza z kaburą
 DE Gartensäge mit Holster
 RU Пила садовая с кабурой
 CZ Zahradní pilka s pouzdrém
 HU Kerti fűrész tokkal
 RO Fierăstrău pt. crengi cu toc
 FR Scie à élaguer avec étui
 IT Seghetto da potatura con fodero
 ES Sierra para jardín con funda
 CN 园林锯

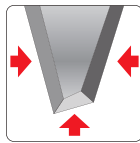

350 mm
 7TPI
 1.2 mm
 HRC 62-64
 SK5
 PTFE
 ABS TPR
 SHEATH KABURA

EN Curved pruning saw
 PL Piła ogrodnicza zakrzywiona
 DE Gebogene Gartensäge
 RU Пила садовая с изогнутым полотном
 CZ Zahradní pilka zahnutá
 HU Ívelt kerti fűrész
 RO Fierăstrău curbă pt. crengi
 FR Scie à élaguer courbe
 IT Seghetto da potatura curvo
 ES Sierra para jardín curvada
 CN 弯锯

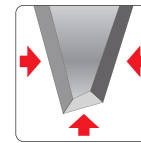

350 mm
 7TPI
 1.2 mm
 HRC 62-64
 SK5
 PTFE
 ABS TPR
 SHEATH KABURA



YATO	L [mm]	
YT-87740	350	12/36

YATO	L [mm]	
YT-87744	350	12/36

EN Transplanter
 PL Lopatka
 DE Blumenkelle
 RU Совок посадочный
 CZ Lopatka
 HU Ásó
 RO Mini-lopată gradinarit
 FR Transplantoir
 IT Spatola
 ES Paleta estrecha
 CN 移植器

350 mm



YATO	L [mm]	
YT-8865	350	10/60

EN Rake
 PL Grabki
 DE Blumenrechen
 RU Грабли
 CZ Hrabičky
 HU Gereblye
 RO Mini grebla
 FR Râteau
 IT Rastrelli
 ES Rastrillo
 CN 园艺耙

325 mm



YATO	L [mm]	
YT-8866	325	10/60

EN Hoe and cultivator
 PL Motyczka z pazurkami
 DE Doppelhacke
 RU Рыхлитель комбинированный
 CZ Motyčka s kultivátorem
 HU Kerti villás kapa
 RO Săpăligă cu cultivator
 FR Serfouette
 IT Zappa con artigli
 ES Escarificador y azadilla
 CN 园艺锄

310 mm



YATO	L [mm]	
YT-8867	310	10/60

EN Cultivator
 PL Pazurki
 DE Grubber
 RU Рыхлитель
 CZ Kultivátor
 HU Kultivátor
 RO Cultivator
 FR Griffes piocheuse
 IT Artigli
 ES Escarifiador
 CN 园艺耙

420 mm



YATO	L [mm]	
YT-8868	420	10/60

EN Garden rake
 PL Grabki wachlarzowe
 DE Landschaftsbesen
 RU Грабли веерные
 CZ Hrabičky
 HU Kerti gereblye
 RO Grebla de gradina
 FR Râteau
 IT Rastrelli ventilatore
 ES Rastrillo de abanico de hojalata
 CN 园艺耙

400 mm



YATO	L [mm]	
YT-8869	400	10/60

EN Transplanter
 PL Lopatka
 DE Blumenkelle
 RU Совок посадочный
 CZ Lopatka
 HU Ásó
 RO Mini-lopată gradinarit
 FR Transplantoir
 IT Spatola
 ES Paleta estrecha
 CN 园艺铲

360 mm



YATO	L [mm]	
YT-8870	360	10/60

EN Transplanter
PL Łopatka
DE Blumenkelle
RU Совок посадочный
CZ Lopatka
HU Ásó
RO Mini-lopata gradinarit
FR Transplanter
IT Spatola
ES Paleta estrecha
CN 移植器

340 mm

CHROME PLATED CHROMO-WANE



YATO

L [mm]



YT-8885

340

12/72

EN Transplanter
PL Łopatka
DE Blumenkelle
RU Совок посадочный
CZ Lopatka
HU Ásó
RO Mini-lopata gradinarit
FR Transplanter
IT Spatola
ES Paleta estrecha
CN 园艺铲

340 mm

CHROME PLATED CHROMO-WANE



YATO

L [mm]



YT-8886

340

12/72

EN Hoe
PL Motyczka
DE Garten Handhacke
RU Мотыжка
CZ Motyčka
HU Kerti kapa
RO Săpăligă
FR Binette
IT Zappetta
ES Azadilla
CN 园艺锄

280 mm

CHROME PLATED CHROMO-WANE



YATO

L [mm]



YT-8889

280

12/72

EN Cultivator
PL Pazaruki
DE Grubber
RU Рыхлитель
CZ Kultivátor
HU Kultivátor
RO Cultivator
FR Griffes piocheuse
IT Artigli
ES Escarifi cador
CN 园艺耙

270 mm

CHROME PLATED CHROMO-WANE



YATO

L [mm]



YT-8890

270

12/72

EN Rolling tiller
PL Spulchniaz
DE Rollpflüger
RU Рыхлитель дисковый
CZ Kypříč pudy
HU Görgös talajlazító
RO Mini afânător pt. pamant
FR Émietteur
IT Coltivatore
ES Escarifi cador
CN 松土器

370 mm

CHROME PLATED CHROMO-WANE



YATO

L [mm]



YT-8891

370

12/72

EN Hoe and cultivator
PL Motyczka z pazurkami
DE Doppelhacke
RU Рыхлитель комбинированный
CZ Motyčka s kultivátorem
HU Kerti villás kapa
RO Săpăligă cu cultivator
FR Serfolette
IT Zappa con artigli
ES Escarificador y azadilla
CN 园艺锄

320 mm

CHROME PLATED CHROMO-WANE



YATO

L [mm]



YT-8892

320

12/72

EN Garden dibber
PL Pikownik ogrodniczy
DE Pflanzler
RU Конус посадочный
CZ Sázečí kolík
HU Kerti ültetőfa
RO Plantator pt. răsaduri
FR Plantoir de jardin
IT Foraterra
ES Plantador
CN 挖洞器



280 mm

SS STAINLESS STEEL NERZEUG



YATO

L [mm]



YT-8894

280

10/60

EN Sharp spade
PL Szpadel ostry
DE Scharfer Spaten
RU Штыковая лопата
CZ Rýč špičatý
HU Hegyes ásó
RO Hârleț ascuțit
FR Bêche à bord pointu
IT Vanga affilata
ES Pala puntiaguda
CN 铁锹



120 cm

HRC 40-48

1050 Mn



YATO

L [cm]



YT-86804

120

6

EN Flat spade
PL Szpadel prosty
DE Rodespaten
RU Заступ
CZ Rýč rovný
HU Egyenes ásó
RO Cazma cu coadă
FR Bêche
IT Vanga dritta
ES Pala recta
CN 铁锹



120 cm

HRC 40-48

1050 Mn



YATO

L [cm]



YT-86800

120

6

EN Coal shovel
PL Łopata węglowa
DE Kohlschaufel
RU Лопата для угля
CZ Lopata na uhlí
HU Szénlapát
RO Lopata pt. carbune
FR Pelle à charbon
IT Pala per carbone
ES Pala para carbón
CN 铁锹



120 cm

HRC 40-48

1050 Mn



YATO

L [cm]



YT-86801

120

6

EN Sand shovel
 PL Lopata piaskowa
 DE Sandschaufel
 RU Лопата для песка
 CZ Lopata na písek
 HU Homoklapát
 RO Lopată pt. nisip
 FR Pelle à sable
 IT Pala per sabbia
 ES Pala para arena
 CN 铁锹



120 cm

HRC 40-48

1050 Mn



YATO L [cm] 6
 YT-86808 120 6

EN Digging fork
 PL Widły
 DE Grabegabel
 RU Вилы
 CZ Zahradnické vidlice
 HU Vasvilla
 RO Furcă pt. grădinarit
 FR Fourche à bêcher
 IT Forchetta
 ES Horca
 CN 铁叉



120 cm



YATO L [cm] 6
 YT-86805 120 6

EN Digging fork
 PL Widły
 DE Grabegabel
 RU Вилы
 CZ Zahradnické vidlice
 HU Vasvilla
 RO Furcă pt. grădinarit
 FR Fourche à bêcher
 IT Forchetta
 ES Horca
 CN 铁叉



120 cm



YATO L [cm] 6
 YT-86809 120 6

EN Weed puller
 PL Wyrrywacz chwastów
 DE Unkrautfemer
 RU Приспособление для вырывания сорняков
 CZ Vytrhávač plevelu
 HU Gyomkihúzó

RO Dispozitiv pt. smuls buruieni
 FR Extracteur de mauvaises herbes
 IT Estrattore di erbacce
 ES Extractor de maleza
 CN 移苗器

995 mm

AI

PP



YATO L [mm] 6
 YT-86840 995 6

EN Manual lawn leveling rake
 PL Ręczny niwelator terenu
 DE Rasenraker
 RU Грабли для выравнивания газона
 CZ Ruční nivelační brána
 HU Gyep szintező
 RO Dispozitiv pt. nivelarea gazonului
 FR Niveleur de terrain manuel
 IT Rastrello livellante
 ES Rastrillo de nivelación de césped
 CN 手动草坪平整器



80x30 cm



YATO 30
 YT-86771 30

EN Manual leveler with wheels
 PL Niwelator terenu na kołach
 DE Rasenraker mit Rädern
 RU Ручной грайдер планировщик грунта
 CZ Ruční nivelační brána na kolech
 HU Kerekes szintező
 RO Nivelator manual cu roti
 FR Niveleur de terrain manuel sur roues
 IT Rastrello livellante con ruote
 ES Niveladora de suelo manual
 CN 手动带车轮平整器



105-175 cm



YATO 6
 YT-86781 6

EN Manual lawn leveling rake
 PL Ręczny niwelator terenu
 DE Rasenraker
 RU Грабли для выравнивания газона
 CZ Ruční nivelační brána
 HU Gyep szintező
 RO Dispozitiv pt. nivelarea gazonului
 FR Niveleur de terrain manuel
 IT Rastrello livellante
 ES Rastrillo de nivelación de césped
 CN 手动草坪平整器



60x25 cm



YATO 20
 YT-86770 20

EN Manual leveler with wheels
 PL Niwelator terenu na kołach
 DE Rasenraker mit Rädern
 RU Ручной грайдер планировщик грунта
 CZ Ruční nivelační brána na kolech
 HU Kerekes szintező
 RO Nivelator manual cu roti
 FR Niveleur de terrain manuel sur roues
 IT Rastrello livellante con ruote
 ES Niveladora de suelo manual
 CN 手动带车轮平整器



105 cm



YATO 10
 YT-86780 10

EN Multiple holder
 PL Wieszak na narzędzia
 DE Werkzeughalter
 RU Подвеска для инструмента
 CZ Věšák na nářadí
 HU Szerszámakasztó

RO Organizator scule
 FR Porte-outils
 IT Portautensili
 ES Colgador para herramientas
 CN 塑料挂架

18-32 mm

x5

x6

320 g

ABS TPR



YATO 40
 YT-87650 40

EN Flexible garden tub
PL Pojemnik elastyczny ogrodowy
DE Flexibler Garten-Korbeimer
RU Контейнер эластичный садовый
CZ Elastické zahradní vědro
HU Rugalmas kertí dézsa
RO Galeata flexibilă de gradină
FR Panier souple pour jardin
IT Contenitore da giardino flessibile
ES Espuerta flexible de jardín
CN 软质园艺桶

42 L



YATO	[]	
YT-86880	42	520

EN Compost spreader
PL Rozrzutnik ogrodowy
DE Kompoststreuer
RU Садовый разбрасыватель компоста
CZ Rozmetadlo kompostu
HU Komposztoszóró
RO Distribuitor de compost
FR Épandeur à compost
IT Spandiconcime
ES Esparcidor de compost
CN 肥料撒播机



60 cm

∅ 40 cm

max 50 kg



- Telescopic handle with 3 levels of height adjustment
- Steel mesh basket 60 cm width
- Teleskopowy uchwyt z 3-stopniową regulacją wysokości
- Kosz z metalowej siatki o szerokości 60 cm

YATO	Working part width / Szerokość części roboczej [mm]	
YT-86763	600	1

EN Universal spreader
PL Siewnik uniwersalny
DE Universal-Streuwagen
RU Сеелка садовая универсальная
CZ Univerzální sypací vozík
HU Univerzális kertí vetőgép
RO Semănătoare universală
FR Épandeur universel
IT Spargitore universale
ES Esparcidor universal
CN 播种机

25 L

0.5 m

1 2 3... 10

10"

PP



- Dosage adjustment by lever
- For sowing grass, fertilization, spreading of salt and sand
- Regulacja dozowania za pomocą dźwigni
- Do siania trawy, nawożenia, rozsypania soli i piasku

YATO	[]	
YT-86713	25	1

EN Garden roller
PL Walec ogrodowy
DE Gartenwalze
RU Каток газонный
CZ Zahradní váleček
HU Kerti henger
RO Tavălug gazon
FR Rouleau de jardin
IT Rullo da giardino
ES Rodillo de jardín
CN 花园辊

65 L

50 cm

∅ 40 cm

13 kg



- Adjustable mud scraper
- Handle with foam cover
- Regulowana skrobaczka do usuwania błota
- Uchwyt z piankową osłoną

YATO	Working part width / Szerokość części roboczej [mm]	
YT-86760	500	1

EN Handheld spreader
PL Rozsiewacz ręczny
DE Handstreuer
RU Разбрасыватель-сеялка ручная
CZ Ruční rozmetadlo
HU Kézi magászóró
RO Semănătoare manuală
FR Épandeur à main
IT Spargitore manuale
ES Esparcidor manual de semillas
CN 手摇式播种器

3 L

1.8-3.6 m

1 2 3 4 5

PP



- Ergonomic armrest to ensure work comfort
- For sowing grass, fertilization, spreading of salt and sand
- Ergonomiczny podłokietnik dla wygody i komfortu pracy
- Do siania trawy, nawożenia, rozsypania soli i piasku

YATO	[]	
YT-86700	3	1

EN Broadcast spreader
PL Siewnik rotacyjny
DE Rotationsstreuer
RU Сеелка ротационная
CZ Rotační sypáč
HU Rotációs műtrágyaszóró
RO Distribuitor seminte
FR Épandeur de diffusion
IT Seminatore a centrifuga
ES Carrizo esparcidor rotativo
CN 播种机

23 L

max 25 kg



- Dosage adjustment by lever in handle
- Big pneumatic wheels 12"
- Set includes sieve and pouch
- Regulacja dozowania za pomocą dźwigni w uchwycie
- Duże koła pneumatyczne 12"
- W zestawie sito oraz pokrowiec

YATO	[]	
YT-86715	23	1

YATO	page/stroņa	YATO	page/stroņa	YATO	page/stroņa	YATO	page/stroņa	YATO	page/stroņa	YATO	page/stroņa	YATO	page/stroņa	YATO	page/stroņa		
YT-0135	15	YT-0355	8	YT-0493	91	YT-0660	462	YT-0831	463	YT-1044	65	YT-1183	68	YT-1282	30	YT-1420	23
YT-0136	15	YT-0356	8	YT-0494	91	YT-0661	462	YT-0835	464	YT-1045	65	YT-1184	68	YT-1283	30	YT-1421	23
YT-0137	15	YT-0357	8	YT-0495	91	YT-0662	463	YT-0836	405	YT-1046	65	YT-1185	68	YT-1284	30	YT-1422	23
YT-0138	15	YT-0358	8	YT-0496	91	YT-0663	462	YT-0837	405	YT-1047	65	YT-1186	68	YT-1285	30	YT-1423	23
YT-0139	15	YT-0359	8	YT-0497	91	YT-0670	434	YT-0838	403	YT-1048	65	YT-1187	68	YT-1286	30	YT-1424	23
YT-0140	15	YT-0360	8	YT-0498	91	YT-0671	452	YT-0840	443	YT-1049	65	YT-1188	68	YT-1289	30	YT-1425	25
YT-0143	15	YT-0362	8	YT-0499	91	YT-0672	441	YT-0841	404	YT-1050	65	YT-1189	68	YT-1291	30	YT-1426	25
YT-0170	15	YT-0363	8	YT-0500	102	YT-0673	442	YT-0842	404	YT-1052	65	YT-1191	68	YT-1292	30	YT-1427	24
YT-0171	15	YT-0365	8	YT-0501	102	YT-0674	442	YT-0843	82	YT-1054	65	YT-1193	68	YT-1295	32	YT-1429	23
YT-0172	15	YT-0367	12	YT-0502	102	YT-0677	412	YT-0844	405	YT-1055	65	YT-1194	68	YT-1296	28	YT-1430	23
YT-0173	15	YT-0368	12	YT-0503	103	YT-0680	449	YT-0845	406	YT-1056	458	YT-1196	68	YT-1297	24	YT-1431	23
YT-0175	15	YT-0369	12	YT-0504	103	YT-0681	451	YT-0846	406	YT-1060	65	YT-1197	68	YT-1301	53	YT-1432	23
YT-0189	9	YT-0370	12	YT-0505	103	YT-0682	453	YT-0847	405	YT-1061	65	YT-1198	68	YT-1302	53	YT-1433	24
YT-0191	9	YT-0371	12	YT-0506	103	YT-0683	450	YT-0860	462	YT-1062	65	YT-1201	30	YT-1303	53	YT-1434	24
YT-0192	9	YT-0372	12	YT-0507	103	YT-0684	449	YT-0862	511	YT-1064	66	YT-1202	30	YT-1304	53	YT-1435	24
YT-0193	9	YT-0373	12	YT-0508	102	YT-0685	449	YT-0863	512	YT-1065	70	YT-1203	30	YT-1305	53	YT-1436	24
YT-0194	9	YT-0374	12	YT-0509	103	YT-0690	388	YT-0864	512	YT-1066	70	YT-1204	30	YT-1306	53	YT-1437	24
YT-0195	9	YT-0375	12	YT-0511	104	YT-0691	388	YT-0865	512	YT-1067	65	YT-1205	30	YT-1307	53	YT-1438	24
YT-0196	9	YT-0376	12	YT-0512	104	YT-0692	474	YT-0866	512	YT-1068	70	YT-1206	30	YT-1308	53	YT-01440	433
YT-0197	9	YT-0377	12	YT-0519	103	YT-0693	474	YT-0867	512	YT-1069	70	YT-1207	30	YT-1309	53	YT-1460	30
YT-0198	9	YT-0378	12	YT-0520	53	YT-0694	474	YT-0880	465	YT-1070	66	YT-1208	30	YT-1310	53	YT-1461	30
YT-0199	9	YT-0380	12	YT-0521	53	YT-0695	474	YT-0882	380	YT-1071	66	YT-1209	30	YT-1311	53	YT-1462	30
YT-0200	9	YT-0381	12	YT-0530	15	YT-0696	474	YT-0883	380	YT-1072	66	YT-1210	30	YT-1312	53	YT-1463	30
YT-0201	9	YT-0383	13	YT-0534	445	YT-0697	474	YT-0884	380	YT-1073	66	YT-1211	30	YT-1313	53	YT-1464	30
YT-0202	9	YT-0384	13	YT-0560	104	YT-0699	475	YT-0885	380	YT-1074	66	YT-1212	30	YT-1314	53	YT-1465	30
YT-0203	9	YT-0385	13	YT-0561	104	YT-0700	386	YT-0886	380	YT-1075	66	YT-1213	30	YT-1315	53	YT-1466	30
YT-0204	9	YT-0386	13	YT-0562	104	YT-0701	386	YT-0902	368	YT-1076	66	YT-1214	30	YT-1316	53	YT-1467	30
YT-0205	9	YT-0387	13	YT-0563	104	YT-0704	386	YT-0907	376	YT-1077	66	YT-1215	30	YT-1317	53	YT-1468	30
YT-0206	9	YT-0388	13	YT-0585	398	YT-0705	386	YT-0908	376	YT-1078	66	YT-1216	30	YT-1318	53	YT-1469	30
YT-0208	10	YT-0389	13	YT-0590	397	YT-0707	387	YT-0910	376	YT-1079	66	YT-1217	30	YT-1319	53	YT-1470	30
YT-0290	26	YT-0390	13	YT-0591	396	YT-0708	387	YT-0911	376	YT-1080	66	YT-1218	30	YT-1320	53	YT-1471	30
YT-0291	29	YT-0391	13	YT-0593	446	YT-0709	388	YT-0913	367	YT-1082	66	YT-1219	30	YT-1322	53	YT-1472	30
YT-0292	33	YT-0392	13	YT-0594	383	YT-0710	388	YT-0914	368	YT-1083	66	YT-1220	30	YT-1323	53	YT-1473	30
YT-0293	26	YT-0394	13	YT-0596	384	YT-0712	389	YT-0953	333	YT-1084	66	YT-1221	31	YT-1324	53	YT-1474	30
YT-0294	29	YT-0396	13	YT-0599	385	YT-0715	389	YT-0959	335	YT-1085	66	YT-1222	31	YT-1326	53	YT-1475	30
YT-0295	33	YT-0398	13	YT-0600	385	YT-0716	475	YT-0960	336	YT-1086	66	YT-1223	31	YT-1328	53	YT-1476	30
YT-0297	26	YT-0400	92	YT-0602	391	YT-0717	475	YT-0965	338	YT-1088	66	YT-1224	31	YT-1330	53	YT-1478	30
YT-0298	29	YT-0404	86	YT-0603	396	YT-0718	475	YT-0980	337	YT-1091	66	YT-1225	31	YT-1334	55	YT-1480	30
YT-0299	33	YT-0405	86	YT-0605	456	YT-0730	26	YT-0981	337	YT-1092	66	YT-1226	31	YT-1335	55	YT-1481	30
YT-0307	25	YT-0406	86	YT-0606	409	YT-0731	29	YT-0982	337	YT-1093	66	YT-1227	31	YT-1340	54	YT-1501	95
YT-0308	29	YT-0407	86	YT-0607	409	YT-0732	33	YT-0990	341	YT-1096	66	YT-1228	31	YT-1341	54	YT-1502	95
YT-0309	33	YT-0408	86	YT-0608	409	YT-0733	26	YT-0994	340	YT-1100	66	YT-1229	31	YT-1342	54	YT-1503	95
YT-0310	25	YT-0409	86	YT-0609	392	YT-0735	33	YT-1000	64	YT-1102	66	YT-1230	31	YT-1345	54	YT-1505	95
YT-0311	29	YT-0410	92	YT-0610	450	YT-0750	74	YT-1001	64	YT-1105	66	YT-1231	31	YT-1347	54	YT-1507	95
YT-0312	33	YT-0411	92	YT-0611	451	YT-0751	74	YT-1002	64	YT-1110	66	YT-1232	31	YT-1348	54	YT-1508	95
YT-0313	25	YT-0412	92	YT-0612	399	YT-0754	75	YT-1003	64	YT-1115	67	YT-1233	31	YT-1350	54	YT-1511	95
YT-0314	29	YT-0413	92	YT-0613	399	YT-0760	8	YT-1004	64	YT-1119	66	YT-1234	31	YT-1352	54	YT-1512	95
YT-0315	33	YT-0414	92	YT-0614	399	YT-0760	74	YT-1005	64	YT-1121	66	YT-1235	31	YT-1355	54	YT-1513	95
YT-0316	25	YT-0415	93	YT-0615	400	YT-0761	8	YT-1006	64	YT-1122	66	YT-1236	31	YT-1356	31	YT-1515	95
YT-0317	29	YT-0416	93	YT-0616	400	YT-0761	75	YT-1007	64	YT-1124	66	YT-1237	31	YT-1360	55	YT-1517	95
YT-0318	33	YT-0417	93	YT-0617	427	YT-0762	8	YT-1008	64	YT-1127	66	YT-1238	31	YT-1370	403	YT-1518	95
YT-0322	25	YT-0418	93	YT-0618	431	YT-0763	8	YT-1009	64	YT-1128	66	YT-1239	31	YT-1371	403	YT-1542	17
YT-0323	29	YT-0419	93	YT-0619	457	YT-0764	8	YT-1010	64	YT-1129	66	YT-1240	31	YT-1372	403	YT-1543	17
YT-0324	33	YT-0420	93	YT-0620	398	YT-0765	8	YT-1011	64	YT-1130	66	YT-1241	32	YT-1373	403	YT-1544	17
YT-0325	25	YT-0421	440	YT-0621	457	YT-0766	8	YT-1012	64	YT-1132	66	YT-1242	32	YT-1374	403	YT-1546	17
YT-0326	29	YT-0461	59	YT-0622	433	YT-0767	8	YT-1013	64	YT-1133	66	YT-1243	32	YT-1375	403	YT-1549	17
YT-0327	33	YT-0465	95	YT-0623	397	YT-0768	8	YT-1014	64	YT-1134	66	YT-1244	32	YT-1378	404	YT-1552	17
YT-0331	26	YT-0466	95	YT-0624	397	YT-0769	8	YT-1015	64	YT-1135	66	YT-1246	31	YT-1379	404	YT-1554	17
YT-0332	12	YT-0467	95	YT-0627	413	YT-0770	75	YT-1016	64	YT-1136	66	YT-1247	31	YT-1381	404	YT-1556	17
YT-0333	12	YT-0468	96	YT-0628	457	YT-0771	75	YT-1017	64	YT-1138	66	YT-1248	31	YT-1382	404	YT-1557	17
YT-0334	12	YT-0470	90	YT-0630	408	YT-0782	76	YT-1018	64	YT-1141	66	YT-1249	31	YT-01385	15	YT-1558	17
YT-0335	8	YT-0471	90	YT-0632	416	YT-0800	460	YT-1019	64	YT-1142	66	YT-1250	31	YT-1385	404	YT-1565	17
YT-0336	8	YT-0472	90	YT-0633	421	YT-0801	460	YT-1020	64	YT-1143	66	YT-1251	31	YT-1400	97	YT-1566	17
YT-0337	8	YT-0474	90	YT-0635	414	YT-0802	460	YT-1022	64	YT-1146	66	YT-1252	32	YT-1401	23	YT-1567	17
YT-0338	8	YT-0475	90	YT-0636	414	YT-0807	462	YT-1025	64	YT-1148	66	YT-1253	444	YT-1403	23	YT-1571	18
YT-0339	8	YT-0476	90	YT-0637	414	YT-0808	462	YT-1027	69	YT-1150	66	YT-1254	444	YT-1404	23	YT-1573	18
YT-0340	8	YT-0477	90	YT-0638	402	YT-0809	462	YT-1029	69	YT-1155	67	YT-1255	31	YT-1405	23	YT-1575	18
YT-0341	8	YT-0478	90	YT-0640	392	YT-0810	462	YT-1030	65	YT-1157	71	YT-1258	31	YT-1406	23	YT-1576	18
YT-0342	8	YT-0480	90	YT-0641	392	YT-0811	462	YT-1031	65	YT-1160	67	YT-1259	31	YT-1407	23	YT-1601	14
YT-0343	8	YT-0481	90	YT-0642	401	YT-0813	446	YT-1032	65	YT-1161	67	YT-1270	30	YT-1408	23	YT-1602	14
YT-0344	8	YT-0482	90	YT-0643	458	YT-0814	446	YT-1033	65	YT-1162	67	YT-1271	30	YT-1409	23	YT-1603	14
YT-0345	8	YT-0483	90	YT-0645	411	YT-0817	445	YT-1034	65	YT-1163	67	YT-1272	30	YT-1410			

YATO	page/strona	YATO	page/strona	YATO	page/strona	YATO	page/strona	YATO	page/strona	YATO	page/strona	YATO	page/strona				
YT-1614	14	YT-1711	476	YT-1953	111	YT-2147	113	YT-2374	345	YT-2518	390	YT-2969	186	YT-03241	25	YT-3327	182
YT-1615	14	YT-1713	476	YT-1954	111	YT-2151	115	YT-2375	14	YT-2519	390	YT-2970	186	YT-3241	173	YT-3329	182
YT-1616	14	YT-1714	476	YT-1956	111	YT-2152	115	YT-2376	145	YT-2520	390	YT-2971	186	YT-03242	29	YT-3330	182
YT-1617	14	YT-1715	476	YT-1960	203	YT-2153	115	YT-2377	14	YT-2521	390	YT-2973	186	YT-3242	173	YT-3332	182
YT-1618	14	YT-1720	477	YT-1961	204	YT-2155	115	YT-2378	145	YT-2522	390	YT-2975	186	YT-03243	33	YT-3333	182
YT-1619	14	YT-1721	477	YT-1962	203	YT-2156	115	YT-2379	14	YT-2523	390	YT-2976	186	YT-3243	173	YT-3334	182
YT-1620	14	YT-1751	432	YT-1963	205	YT-2170	19	YT-2378	14	YT-2535	456	YT-2977	186	YT-3244	173	YT-3336	182
YT-1621	14	YT-1752	431	YT-1964	205	YT-2171	19	YT-2379	14	YT-2536	457	YT-2978	186	YT-3245	173	YT-3338	182
YT-1622	14	YT-1753	431	YT-1965	205	YT-2172	19	YT-2380	14	YT-2540	393	YT-2979	186	YT-3246	173	YT-3343	182
YT-1627	16	YT-1754	431	YT-1966	134	YT-2173	19	YT-2380	346	YT-2541	394	YT-2980	188	YT-3247	173	YT-3345	182
YT-1628	16	YT-1756	466	YT-1967	134	YT-2180	257	YT-2381	14	YT-2542	395	YT-2981	188	YT-3248	173	YT-3346	182
YT-1629	16	YT-1757	466	YT-1968	134	YT-2182	257	YT-2381	346	YT-2543	395	YT-2982	188	YT-3249	173	YT-3349	182
YT-1630	16	YT-1762	433	YT-1969	134	YT-2201	249	YT-2382	14	YT-2544	456	YT-2983	188	YT-3250	173	YT-3350	182
YT-1631	16	YT-1763	467	YT-1970	205	YT-2203	249	YT-2382	346	YT-2546	456	YT-2984	188	YT-3251	173	YT-3351	182
YT-1632	16	YT-1764	467	YT-1974	133	YT-2204	249	YT-2383	14	YT-2547	456	YT-2985	188	YT-3252	173	YT-3353	182
YT-1633	16	YT-1765	467	YT-1976	208	YT-2205	249	YT-2383	346	YT-2568	82	YT-2986	188	YT-3253	173	YT-3370	184
YT-1634	16	YT-1766	467	YT-1988	114	YT-2206	249	YT-2384	14	YT-2670	82	YT-2987	188	YT-3254	173	YT-3371	184
YT-1635	16	YT-1767	467	YT-1989	114	YT-2210	249	YT-2384	346	YT-2797	84	YT-2988	188	YT-3255	173	YT-3372	184
YT-1636	16	YT-1768	467	YT-1990	114	YT-2211	249	YT-2385	14	YT-2801	85	YT-2989	188	YT-3256	173	YT-3373	184
YT-1637	16	YT-1769	467	YT-1991	114	YT-2212	249	YT-2385	346	YT-2802	85	YT-2990	188	YT-3257	173	YT-3374	184
YT-1638	16	YT-1843	206	YT-1992	114	YT-2213	250	YT-2386	14	YT-2810	86	YT-2991	188	YT-3258	173	YT-3377	184
YT-1639	16	YT-1844	206	YT-1993	114	YT-2214	250	YT-2387	14	YT-2811	86	YT-2992	188	YT-3259	173	YT-3380	184
YT-1640	16	YT-1845	206	YT-1994	114	YT-2215	250	YT-2388	14	YT-2812	86	YT-2993	188	YT-3261	175	YT-3381	184
YT-1641	16	YT-1846	206	YT-1995	114	YT-2216	250	YT-2390	58	YT-2817	122	YT-2994	188	YT-3262	175	YT-3400	212
YT-1642	16	YT-1847	206	YT-2006	108	YT-2217	250	YT-2390	349	YT-2818	122	YT-2995	188	YT-3263	175	YT-3401	212
YT-1644	16	YT-1848	206	YT-2007	108	YT-2218	250	YT-2391	58	YT-2819	122	YT-2996	188	YT-3264	175	YT-3402	212
YT-1647	16	YT-01851	11	YT-2008	108	YT-2222	249	YT-2391	349	YT-2820	122	YT-2997	188	YT-3265	175	YT-3403	212
YT-1649	16	YT-1851	206	YT-2016	108	YT-2223	249	YT-2392	58	YT-2821	122	YT-3001	326	YT-3266	175	YT-3404	212
YT-1651	10	YT-01852	11	YT-2018	108	YT-2224	249	YT-2392	349	YT-2822	122	YT-3002	326	YT-3267	175	YT-3405	212
YT-1652	10	YT-1852	206	YT-2026	108	YT-2225	249	YT-2393	349	YT-2823	122	YT-3003	326	YT-3268	175	YT-3407	212
YT-1653	10	YT-01853	11	YT-2028	108	YT-2228	253	YT-2394	58	YT-2824	122	YT-3004	326	YT-3269	175	YT-3408	212
YT-1654	10	YT-1853	206	YT-2029	108	YT-2229	253	YT-2394	349	YT-2825	122	YT-3005	326	YT-3270	175	YT-3409	212
YT-1655	10	YT-01854	11	YT-2030	108	YT-2230	253	YT-2395	58	YT-2826	122	YT-3022	326	YT-3271	175	YT-3410	212
YT-1656	10	YT-1854	206	YT-2031	109	YT-2231	253	YT-2395	349	YT-2827	122	YT-3023	326	YT-3272	175	YT-3411	213
YT-1657	10	YT-01855	11	YT-2036	108	YT-2232	255	YT-2396	58	YT-2828	122	YT-3024	326	YT-3273	175	YT-3412	213
YT-1658	10	YT-1855	206	YT-2037	108	YT-2233	255	YT-2396	349	YT-2861	135	YT-3025	326	YT-3274	175	YT-3413	213
YT-1659	10	YT-01856	11	YT-2039	112	YT-2234	255	YT-2397	58	YT-2862	135	YT-3026	326	YT-3275	175	YT-3414	213
YT-1660	10	YT-1856	206	YT-2046	112	YT-2235	255	YT-2397	349	YT-2864	134	YT-3071	307	YT-3276	175	YT-3415	213
YT-1661	10	YT-01858	11	YT-2047	112	YT-2240	127	YT-2398	349	YT-2865	466	YT-3072	307	YT-3277	175	YT-3416	213
YT-1662	10	YT-01865	12	YT-2048	112	YT-2245	125	YT-2399	349	YT-2866	466	YT-3073	307	YT-3278	175	YT-3417	213
YT-1663	10	YT-01870	12	YT-2050	112	YT-2246	126	YT-2400	58	YT-2900	248	YT-3074	307	YT-3279	175	YT-3421	213
YT-1664	10	YT-01872	12	YT-2051	112	YT-2247	126	YT-2401	349	YT-2910	248	YT-3076	307	YT-3280	175	YT-3445	213
YT-1665	10	YT-01874	12	YT-2052	112	YT-2250	125	YT-2402	349	YT-2911	248	YT-3077	307	YT-3281	175	YT-3460	210
YT-1666	10	YT-01875	12	YT-2055	112	YT-2254	128	YT-2403	349	YT-2912	248	YT-3078	307	YT-3282	175	YT-3461	210
YT-1667	10	YT-01876	12	YT-2056	112	YT-2255	125	YT-2404	349	YT-2913	248	YT-3079	307	YT-3283	175	YT-3462	210
YT-1669	10	YT-01877	12	YT-2057	112	YT-2256	125	YT-2405	349	YT-2914	248	YT-3081	307	YT-3284	175	YT-3590	229
YT-1670	10	YT-01879	12	YT-2058	112	YT-2260	130	YT-2406	349	YT-2916	248	YT-3082	307	YT-3285	175	YT-3591	229
YT-01670	19	YT-1900	204	YT-2060	112	YT-2261	131	YT-2407	349	YT-2917	248	YT-3083	307	YT-3286	175	YT-3600	266
YT-1671	10	YT-1901	204	YT-2061	112	YT-2262	131	YT-2449	115	YT-2918	248	YT-3084	307	YT-3287	175	YT-3609	267
YT-01671	19	YT-1902	204	YT-2063	112	YT-2263	131	YT-2450	115	YT-2919	248	YT-3101	208	YT-3288	175	YT-3610	267
YT-1672	10	YT-01906	9	YT-2064	112	YT-2268	130	YT-2451	115	YT-2920	248	YT-3102	208	YT-3289	175	YT-3612	267
YT-01672	19	YT-01907	9	YT-2066	109	YT-2270	129	YT-2452	116	YT-2921	248	YT-3103	208	YT-3290	175	YT-3618	353
YT-1673	10	YT-01908	9	YT-2067	109	YT-2274	130	YT-2453	115	YT-2930	185	YT-3106	208	YT-3291	175	YT-3703	289
YT-01673	19	YT-01909	9	YT-2069	251	YT-2275	130	YT-2459	116	YT-2931	185	YT-3107	208	YT-3292	175	YT-3705	289
YT-1674	11	YT-1910	203	YT-2070	251	YT-2278	130	YT-2460	116	YT-2932	185	YT-3108	208	YT-3293	175	YT-3707	289
YT-01674	19	YT-1911	204	YT-2071	19	YT-2279	131	YT-2461	117	YT-2933	185	YT-3130	209	YT-3294	175	YT-3708	289
YT-1675	11	YT-1912	203	YT-2072	19	YT-2280	133	YT-2463	117	YT-2934	185	YT-3133	209	YT-3295	175	YT-3712	289
YT-01675	19	YT-1913	203	YT-2073	19	YT-2293	129	YT-2466	117	YT-2935	185	YT-3134	209	YT-3296	175	YT-3713	289
YT-1676	11	YT-1914	204	YT-2074	19	YT-2294	129	YT-2468	117	YT-2937	185	YT-3150	209	YT-3297	175	YT-3714	289
YT-01676	19	YT-1915	203	YT-2075	19	YT-2296	126	YT-2469	117	YT-2939	185	YT-3160	210	YT-3298	175	YT-3725	176
YT-1677	11	YT-1916	204	YT-2080	110	YT-2297	126	YT-2473	116	YT-2940	185	YT-3161	210	YT-3299	175	YT-3726	176
YT-01677	19	YT-1918	203	YT-2081	110	YT-2298	126	YT-2476	116	YT-2941	185	YT-3163	210	YT-3300	175	YT-3727	176
YT-1678	11	YT-1919	204	YT-2082	110	YT-2299	126	YT-2482	249	YT-2942	185	YT-3200	209	YT-3303	182	YT-3728	176
YT-01678	19	YT-1920	205	YT-2083	110	YT-2300	125	YT-2483	249	YT-2943	185	YT-3201	209	YT-3304	182	YT-3735	293
YT-1679	11	YT-1922	203	YT-2084	110	YT-2305	127	YT-2484	249	YT-2944	185	YT-3202	209	YT-3306	182	YT-3736	293
YT-01679	19	YT-1924	205	YT-2085	110	YT-2313	130	YT-2485	249	YT-2945	185	YT-3203	209	YT-3308	182	YT-3740	228
YT-1680	11	YT-1925	205	YT-2086	110	YT-2316	131	YT-2488	249	YT-2946	185	YT-3204	209	YT-03311	26	YT-3801	27
YT-1681	11	YT-1930	206	YT-2090	251	YT-2319	129	YT-2489	249	YT-2950	185	YT-3221	210	YT-3311	182	YT-3802	27
YT-1682	11	YT-1940	108	YT-2091	251	YT-2340	343	YT-2490	249	YT-2951	185	YT-3222	210	YT-3313	182	YT-3803	27
YT-1683	11	YT-1941	108	YT-2130	112	YT-2341	343	YT-2491	249	YT							

YATO	page/strona	YATO	page/strona	YATO	page/strona	YATO	page/strona	YATO	page/strona	YATO	page/strona	YATO	page/strona	YATO	page/strona	YATO	page/strona
YT-3821	27	YT-4181	172	YT-04351	58	YT-4447	165	YT-04631	98	YT-05123	101	YT-05436	100	YT-05581	99	YT-06003	424
YT-3822	27	YT-4182	172	YT-4351	174	YT-4448	165	YT-4631	146	YT-5130	117	YT-05438	100	YT-05583	99	YT-6004	196
YT-3823	27	YT-4183	172	YT-04352	58	YT-4449	165	YT-04632	98	YT-5131	118	YT-05439	100	YT-05585	99	YT-06004	418
YT-3824	27	YT-4184	172	YT-4352	174	YT-4450	165	YT-4632	146	YT-5140	118	YT-05440	100	YT-05586	99	YT-6005	196
YT-3825	27	YT-4185	172	YT-04353	58	YT-4451	165	YT-4633	146	YT-5141	118	YT-05441	100	YT-05588	99	YT-06005	420
YT-3826	27	YT-4186	172	YT-4353	174	YT-4452	165	YT-4634	146	YT-5142	118	YT-05442	100	YT-05590	99	YT-06006	425
YT-3827	27	YT-4187	172	YT-04354	58	YT-4453	165	YT-04635	96	YT-5200	295	YT-05443	100	YT-05591	99	YT-06007	426
YT-3828	27	YT-4188	172	YT-4354	174	YT-4454	165	YT-04636	98	YT-5202	295	YT-05444	100	YT-05592	99	YT-06008	416
YT-3829	27	YT-4189	172	YT-04355	58	YT-4455	165	YT-04639	97	YT-5203	295	YT-05445	100	YT-05593	99	YT-06009	420
YT-3830	27	YT-4190	172	YT-4355	174	YT-4456	165	YT-04641	97	YT-5204	295	YT-05446	100	YT-05594	99	YT-06010	423
YT-3831	27	YT-4191	172	YT-04356	58	YT-4457	165	YT-04644	96	YT-5207	295	YT-05450	101	YT-05597	99	YT-06011	416
YT-3832	27	YT-4192	172	YT-4356	174	YT-4458	165	YT-04645	96	YT-5209	295	YT-05451	101	YT-05601	99	YT-6012	196
YT-3833	27	YT-4200	171	YT-04357	58	YT-4460	165	YT-04671	95	YT-5210	295	YT-05452	101	YT-05602	99	YT-06012	417
YT-3839	28	YT-4201	171	YT-4357	174	YT-4461	165	YT-04681	96	YT-05211	52	YT-05453	101	YT-05603	99	YT-6013	196
YT-3840	28	YT-4202	171	YT-4358	174	YT-4462	165	YT-04682	96	YT-05212	52	YT-05454	101	YT-05604	99	YT-06013	420
YT-3841	444	YT-4203	171	YT-4359	174	YT-4491	144	YT-04683	96	YT-5212	295	YT-05456	101	YT-05605	99	YT-6014	196
YT-3842	27	YT-4204	171	YT-04360	59	YT-4492	144	YT-04684	96	YT-05213	52	YT-05458	101	YT-05606	99	YT-06014	417
YT-3843	27	YT-4205	171	YT-4361	173	YT-4493	144	YT-04685	97	YT-05214	52	YT-05459	101	YT-05607	99	YT-6015	196
YT-3844	27	YT-4206	171	YT-4362	173	YT-4494	144	YT-04686	97	YT-5214	296	YT-05460	101	YT-05608	99	YT-06015	427
YT-3845	27	YT-4207	171	YT-4363	173	YT-4495	144	YT-04690	97	YT-05215	52	YT-05461	101	YT-05609	99	YT-6016	196
YT-3847	27	YT-4208	171	YT-4364	173	YT-4496	144	YT-4690	151	YT-5218	297	YT-05462	101	YT-05610	99	YT-06016	418
YT-3848	27	YT-4209	171	YT-4367	173	YT-4497	144	YT-04691	98	YT-05220	53	YT-05463	101	YT-05611	99	YT-6017	196
YT-3849	27	YT-4210	171	YT-4369	173	YT-4498	144	YT-4691	151	YT-05221	53	YT-05464	101	YT-05615	100	YT-06017	417
YT-3850	28	YT-4211	171	YT-04370	56	YT-4499	144	YT-4692	152	YT-05222	53	YT-05465	101	YT-05631	105	YT-06018	420
YT-3851	444	YT-04211	440	YT-4370	173	YT-4500	144	YT-4693	152	YT-05223	53	YT-05466	101	YT-05632	105	YT-06019	416
YT-3853	28	YT-4212	171	YT-04371	56	YT-4501	144	YT-4694	152	YT-05224	53	YT-05490	101	YT-05633	105	YT-06021	425
YT-3854	28	YT-4213	171	YT-04372	56	YT-4502	144	YT-04695	96	YT-05225	53	YT-5490	308	YT-05634	105	YT-6022	196
YT-3895	381	YT-4214	171	YT-04373	56	YT-4503	144	YT-4695	152	YT-05226	53	YT-05491	101	YT-05635	105	YT-06022	422
YT-03950	13	YT-4215	171	YT-04374	56	YT-4504	144	YT-04699	96	YT-5226	298	YT-5491	308	YT-05636	105	YT-6023	196
YT-03951	13	YT-4216	171	YT-04375	56	YT-4505	144	YT-4700	149	YT-05227	53	YT-05492	101	YT-05640	100	YT-06023	417
YT-03952	13	YT-4217	171	YT-4375	173	YT-4506	144	YT-04702	88	YT-05228	53	YT-5492	308	YT-05644	100	YT-6024	196
YT-03953	13	YT-4218	171	YT-4376	173	YT-4507	144	YT-4710	149	YT-5228	298	YT-05493	101	YT-5710	228	YT-06024	425
YT-03954	13	YT-4219	171	YT-4379	173	YT-4508	144	YT-4711	151	YT-5230	298	YT-5493	308	YT-05800	415	YT-6025	196
YT-03955	13	YT-4220	171	YT-4380	173	YT-4509	144	YT-04712	88	YT-5234	298	YT-05494	101	YT-05801	415	YT-06025	419
YT-03956	13	YT-4221	171	YT-04381	57	YT-4510	144	YT-4712	151	YT-5237	298	YT-5494	308	YT-05802	415	YT-06026	421
YT-4020	166	YT-4222	171	YT-04382	57	YT-4515	147	YT-4713	151	YT-5240	298	YT-05495	101	YT-05810	414	YT-06027	425
YT-4025	166	YT-4223	171	YT-04383	57	YT-4516	147	YT-4714	151	YT-5242	298	YT-05496	101	YT-05811	414	YT-06028	422
YT-4030	166	YT-4224	171	YT-4383	173	YT-4518	147	YT-4720	179	YT-5243	298	YT-5496	308	YT-05812	414	YT-06029	420
YT-4032	166	YT-4225	171	YT-04384	57	YT-4519	147	YT-4721	179	YT-05244	52	YT-05497	101	YT-05815	414	YT-6030	197
YT-4035	166	YT-4226	171	YT-04385	57	YT-4520	147	YT-04722	88	YT-05245	53	YT-5497	309	YT-05816	414	YT-06030	459
YT-4040	166	YT-4227	171	YT-4385	173	YT-4521	147	YT-4722	179	YT-5245	298	YT-05498	101	YT-05817	414	YT-06031	396
YT-4042	166	YT-4228	171	YT-04386	57	YT-4522	147	YT-4723	179	YT-05246	53	YT-05499	101	YT-05830	413	YT-6032	197
YT-4045	166	YT-4229	171	YT-04387	57	YT-4550	144	YT-4730	153	YT-05247	53	YT-5499	309	YT-5835	102	YT-06032	396
YT-4048	166	YT-4230	171	YT-04388	57	YT-4551	144	YT-04742	88	YT-5247	299	YT-5500	309	YT-5837	102	YT-06033	396
YT-4050	166	YT-04301	56	YT-04390	57	YT-4552	144	YT-4750	220	YT-05248	53	YT-05501	101	YT-5838	102	YT-06034	398
YT-04051	86	YT-04302	56	YT-4390	173	YT-4553	144	YT-4751	220	YT-05249	53	YT-5501	309	YT-05880	438	YT-06035	397
YT-04052	86	YT-04303	56	YT-04391	57	YT-4560	144	YT-04752	88	YT-05250	53	YT-5502	309	YT-05881	438	YT-06036	470
YT-4052	166	YT-04304	56	YT-04392	57	YT-4561	144	YT-4752	220	YT-05251	53	YT-5503	309	YT-05890	398	YT-06037	397
YT-4055	166	YT-04305	56	YT-04393	57	YT-4562	145	YT-4755	220	YT-5260	293	YT-5504	309	YT-05893	396	YT-06038	397
YT-4060	166	YT-04306	56	YT-04394	57	YT-4563	145	YT-4757	221	YT-5261	293	YT-5506	309	YT-05897	397	YT-6045	197
YT-4065	166	YT-04307	56	YT-04395	57	YT-4564	145	YT-4758	221	YT-5262	293	YT-5507	309	YT-5901	308	YT-6046	197
YT-4070	166	YT-04310	57	YT-04396	57	YT-4570	145	YT-4759	221	YT-05311	16	YT-5508	309	YT-5902	308	YT-6050	198
YT-4075	166	YT-04311	57	YT-04397	57	YT-4571	145	YT-4761	222	YT-05312	16	YT-05514	101	YT-5904	308	YT-6052	198
YT-4080	166	YT-04312	57	YT-04398	57	YT-4573	145	YT-04762	88	YT-05313	16	YT-05515	101	YT-5905	308	YT-6053	198
YT-4085	166	YT-04313	57	YT-4400	182	YT-04580	398	YT-4763	222	YT-05314	16	YT-05516	101	YT-5911	484	YT-6055	198
YT-4090	166	YT-04314	57	YT-04401	59	YT-04581	398	YT-4764	222	YT-05315	16	YT-05517	101	YT-5913	484	YT-6056	198
YT-4100	166	YT-04315	57	YT-4401	182	YT-4590	147	YT-4766	222	YT-05320	16	YT-05518	101	YT-5914	484	YT-6057	198
YT-4110	166	YT-04316	57	YT-4402	182	YT-4594	146	YT-4767	222	YT-05333	447	YT-05519	101	YT-5920	200	YT-6058	198
YT-4120	166	YT-04317	57	YT-4403	182	YT-4601	146	YT-4768	222	YT-05335	428	YT-05520	101	YT-5923	200	YT-6060	198
YT-4140	166	YT-04318	57	YT-04411	56	YT-4602	146	YT-4769	222	YT-05337	439	YT-5530	362	YT-5924	200	YT-6061	198
YT-4160	166	YT-04319	57	YT-04412	56	YT-4603	146	YT-04772	88	YT-05338	428	YT-5531	370	YT-5925	200	YT-06061	410
YT-4161	172	YT-04320	58	YT-04413	56	YT-4604	146	YT-04782	88	YT-05339	446	YT-5532	369	YT-5927	200	YT-06062	198
YT-4162	172	YT-04321	58	YT-04417	56	YT-4605	146	YT-04792	88	YT-05341	429	YT-5533	370	YT-5930	201	YT-06062	410
YT-4163	172	YT-04322	58	YT-04418	56	YT-04620	94	YT-04812	88	YT-05342	430	YT-5534	370	YT-5932	201	YT-6063	198
YT-4164	172	YT-04323	58	YT-4430	165	YT-4620	146	YT-04822	89	YT-05343	429	YT-5535	371	YT-5933	201	YT-06064	410
YT-4165	172	YT-04324	58	YT-4431	165	YT-04621	94	YT-04832	89	YT-05344	430	YT-5536	371	YT-05933	446	YT-6065	198
YT-4166	172	YT-04325	58	YT-4432	165	YT-04622	94	YT-4901	9	YT-05345	430	YT-5537	372	YT-05934	446	YT-6066	198
YT-4167	172	YT-04326	58	YT-4433	165	YT-4622	146	YT-4902	9	YT-05390	408	YT-5538	372	YT-5935	201	YT-6067	198
YT-4168	172	YT-04327	58														

YATO	page/strona	YATO	page/strona	YATO	page/strona	YATO	page/strona	YATO	page/strona	YATO	page/strona	YATO	page/strona	YATO	page/strona		
YT-6085	198	YT-6194	232	YT-06341	407	YT-06622	463	YT-06881	495	YT-07110	387	YT-7506	226	YT-08033	460	YT-08425	401
YT-6086	198	YT-06201	399	YT-06342	408	YT-06650	503	YT-06882	494	YT-7111	316	YT-7507	226	YT-8033	630	YT-08426	401
YT-06086	448	YT-06205	410	YT-6343	219	YT-06651	503	YT-06883	492	YT-7112	316	YT-07511	74	YT-8034	630	YT-08428	401
YT-06088	455	YT-06208	407	YT-06343	408	YT-06652	503	YT-06884	493	YT-07115	389	YT-7511	226	YT-08035	460	YT-08429	401
YT-6091	199	YT-6219	235	YT-6344	219	YT-06653	504	YT-06885	493	YT-7126	316	YT-7512	226	YT-08040	460	YT-08431	402
YT-6093	199	YT-6220	235	YT-6345	219	YT-06654	504	YT-06888	492	YT-7127	316	YT-7520	225	YT-8106	653	YT-08432	402
YT-6095	199	YT-6221	235	YT-6346	219	YT-06655	504	YT-06890	497	YT-7128	316	YT-7524	227	YT-8107	653	YT-08442	405
YT-6097	199	YT-6222	235	YT-6349	219	YT-06656	504	YT-06891	497	YT-7129	316	YT-7525	227	YT-8108	653	YT-08443	405
YT-6099	199	YT-6223	232	YT-6351	219	YT-06657	504	YT-06895	498	YT-7130	316	YT-7527	227	YT-8116	653	YT-08461	406
YT-6101	200	YT-6224	232	YT-6353	219	YT-06658	504	YT-06896	498	YT-7131	316	YT-7528	227	YT-08120	460	YT-08462	407
YT-06101	450	YT-6225	232	YT-6354	219	YT-06659	504	YT-6903	139	YT-07140	389	YT-7529	227	YT-8120	653	YT-08474	405
YT-6103	200	YT-6226	232	YT-6355	219	YT-06660	504	YT-6907	139	YT-07190	351	YT-7530	227	YT-08144	448	YT-08477	405
YT-6104	200	YT-6227	232	YT-6356	219	YT-06661	505	YT-06912	388	YT-07191	351	YT-7531	227	YT-8152	139	YT-08490	650
YT-6105	200	YT-6228	232	YT-6358	219	YT-06662	505	YT-06913	388	YT-07195	350	YT-7532	225	YT-8156	140	YT-08495	639
YT-6107	200	YT-6229	232	YT-6359	219	YT-06663	505	YT-06914	388	YT-07200	26	YT-7534	225	YT-8159	139	YT-08496	639
YT-6110	200	YT-6230	232	YT-6360	219	YT-06664	505	YT-6916	139	YT-7200	321	YT-7550	230	YT-08163	445	YT-08502	641
YT-6112	200	YT-6231	232	YT-06373	414	YT-06680	495	YT-06919	389	YT-07201	29	YT-7551	230	YT-08164	445	YT-08504	643
YT-6113	200	YT-6232	232	YT-06377	414	YT-06711	452	YT-6925	311	YT-7201	321	YT-7560	227	YT-8165	139	YT-08507	643
YT-6116	200	YT-6233	232	YT-6401	158	YT-06721	441	YT-6926	311	YT-07202	33	YT-7561	227	YT-8166	139	YT-08509	641
YT-6120	200	YT-6234	232	YT-6402	158	YT-06722	483	YT-6927	311	YT-7220	328	YT-7600	224	YT-8173	140	YT-08511	644
YT-6121	200	YT-6235	232	YT-6403	158	YT-6740	272	YT-6972	474	YT-7221	328	YT-07601	74	YT-8174	139	YT-08513	644
YT-06122	399	YT-6236	232	YT-6404	158	YT-6741	272	YT-6977	389	YT-7222	328	YT-7601	224	YT-8177	139	YT-08514	644
YT-06123	399	YT-6237	232	YT-6405	158	YT-6743	272	YT-6980	473	YT-7223	328	YT-07605	74	YT-08195	427	YT-08516	645
YT-6124	200	YT-6238	232	YT-6406	158	YT-6745	272	YT-6983	473	YT-7300	439	YT-07607	74	YT-08196	427	YT-08518	642
YT-6125	200	YT-6239	232	YT-6407	158	YT-6750	273	YT-6985	473	YT-7301	439	YT-07609	74	YT-08231	382	YT-08519	642
YT-6126	200	YT-6241	148	YT-6408	158	YT-6751	272	YT-6987	473	YT-7302	439	YT-07611	74	YT-08235	382	YT-08520	644
YT-6132	201	YT-6242	148	YT-6409	158	YT-6753	272	YT-6992	475	YT-7306	439	YT-07612	74	YT-08236	382	YT-08521	644
YT-6133	201	YT-6243	148	YT-6410	158	YT-6754	272	YT-6995	475	YT-7307	435	YT-7620	307	YT-08237	382	YT-08522	641
YT-6136	200	YT-6244	148	YT-6412	158	YT-6755	273	YT-7000	270	YT-7310	440	YT-7623	307	YT-8245	281	YT-08524	643
YT-6137	200	YT-6245	148	YT-06412	392	YT-06772	489	YT-7001	270	YT-7311	440	YT-7624	307	YT-08253	382	YT-08527	642
YT-6140	233	YT-6246	148	YT-6413	158	YT-06773	489	YT-7003	270	YT-7312	440	YT-07641	74	YT-08254	382	YT-08529	645
YT-6141	233	YT-6247	148	YT-6414	158	YT-06774	489	YT-7004	271	YT-7349	471	YT-07642	74	YT-08255	382	YT-08547	648
YT-6142	233	YT-6248	148	YT-6415	158	YT-06775	489	YT-7005	270	YT-7350	471	YT-07711	75	YT-08271	280	YT-08548	648
YT-6143	234	YT-6249	148	YT-6416	158	YT-06776	489	YT-7007	270	YT-7360	606	YT-07712	74	YT-8272	280	YT-08550	648
YT-6144	234	YT-6251	148	YT-6417	158	YT-06777	495	YT-7011	271	YT-7361	606	YT-07730	74	YT-8273	280	YT-08551	648
YT-06144	394	YT-06251	399	YT-6420	159	YT-06780	491	YT-07020	524	YT-7362	606	YT-07731	74	YT-08280	465	YT-08555	646
YT-6145	234	YT-6253	148	YT-6421	159	YT-06782	494	YT-07021	524	YT-7363	606	YT-07735	74	YT-08295	463	YT-08556	646
YT-6146	234	YT-06255	399	YT-6422	159	YT-06783	494	YT-7022	271	YT-7364	606	YT-07736	74	YT-08302	463	YT-08557	646
YT-6147	233	YT-6256	148	YT-6423	159	YT-06784	494	YT-7023	271	YT-7365	606	YT-07740	75	YT-08304	463	YT-08558	641
YT-6148	233	YT-06256	399	YT-6424	159	YT-06785	496	YT-7024	271	YT-7366	606	YT-07741	75	YT-8304	480	YT-08559	647
YT-6149	233	YT-6258	148	YT-6440	158	YT-06786	492	YT-7025	271	YT-7367	606	YT-07743	75	YT-08305	463	YT-08567	646
YT-6150	234	YT-6260	148	YT-6441	158	YT-06787	493	YT-7026	271	YT-7368	606	YT-07745	75	YT-8305	480	YT-08568	646
YT-6151	234	YT-06260	407	YT-6442	158	YT-06790	495	YT-7032	271	YT-7369	606	YT-7752	60	YT-8310	482	YT-08569	647
YT-6152	233	YT-06273	412	YT-6443	158	YT-06793	495	YT-7033	271	YT-7371	606	YT-07752	75	YT-8311	482	YT-08570	647
YT-6153	233	YT-06275	413	YT-6444	158	YT-6801	195	YT-7034	271	YT-7376	606	YT-7753	61	YT-08312	463	YT-08571	647
YT-6154	233	YT-06278	413	YT-6445	158	YT-06802	449	YT-07041	386	YT-7377	607	YT-07753	75	YT-08320	464	YT-08579	648
YT-6155	234	YT-06279	413	YT-6446	158	YT-6803	195	YT-07042	386	YT-7380	608	YT-07762	75	YT-8350	236	YT-08580	646
YT-06155	400	YT-6280	148	YT-6447	158	YT-06804	449	YT-07043	386	YT-7382	608	YT-7807	90	YT-8351	236	YT-08581	645
YT-6156	234	YT-6281	148	YT-6448	158	YT-06805	449	YT-07044	386	YT-7400	591	YT-7808	90	YT-8352	236	YT-08582	645
YT-06157	400	YT-06288	408	YT-6449	158	YT-06806	450	YT-07045	387	YT-7409	591	YT-7809	90	YT-8353	236	YT-08587	645
YT-6160	233	YT-06301	408	YT-6450	158	YT-06807	450	YT-07046	387	YT-7410	591	YT-7810	90	YT-08353	464	YT-08588	645
YT-06160	400	YT-06311	446	YT-6451	158	YT-06808	450	YT-7051	271	YT-7413	591	YT-7811	90	YT-8354	236	YT-08590	649
YT-6161	233	YT-06312	447	YT-6452	158	YT-06809	450	YT-7052	271	YT-7414	591	YT-7812	90	YT-08354	464	YT-08591	649
YT-6162	233	YT-06313	447	YT-6453	158	YT-06811	450	YT-7053	271	YT-7416	592	YT-07822	76	YT-8355	236	YT-08592	649
YT-06162	400	YT-06315	447	YT-6454	158	YT-06822	453	YT-7054	271	YT-7417	592	YT-07830	76	YT-8356	236	YT-08593	649
YT-6163	233	YT-06316	447	YT-06475	412	YT-06835	455	YT-7055	271	YT-7419	592	YT-07831	76	YT-8357	236	YT-08594	650
YT-06163	400	YT-06322	424	YT-06477	410	YT-06837	456	YT-07055	351	YT-7420	592	YT-07832	76	YT-8358	236	YT-08595	649
YT-6164	233	YT-06323	422	YT-6501	160	YT-06845	455	YT-07057	351	YT-7430	593	YT-07835	76	YT-08390	443	YT-08596	649
YT-6165	233	YT-06324	426	YT-6502	160	YT-6854	466	YT-07061	388	YT-7433	593	YT-07836	76	YT-08391	443	YT-08597	648
YT-06166	431	YT-06325	421	YT-6503	160	YT-6855	466	YT-07063	388	YT-7435	593	YT-7980	90	YT-08392	443	YT-08598	650
YT-06169	431	YT-06326	418	YT-6504	160	YT-06860	493	YT-07065	388	YT-7446	593	YT-8001	153	YT-8400	236	YT-08599	650
YT-06172	478	YT-06327	423	YT-6505	160	YT-6862	466	YT-07067	350	YT-7451	614	YT-8002	153	YT-8401	236	YT-08625	513
YT-06174	428	YT-06328	422	YT-6506	160	YT-06862	491	YT-07068	350	YT-7455	614	YT-8003	153	YT-8402	236	YT-08677	512
YT-06175	428	YT-6330	219	YT-6510	260	YT-6863	466	YT-07069	350	YT-7456	614	YT-8004	153	YT-8403	236	YT-08678	512
YT-06176	428	YT-6331	219	YT-6511	260	YT-06864	491	YT-07070	318	YT-7458	614	YT-8005	153	YT-08403	443	YT-08679	512
YT-6180	232	YT-06331	419	YT-6512	260	YT-06865	489	YT-07071	318	YT-7460	612	YT-8006	153	YT-8404	236	YT-08680	377
YT-6181	232	YT-6332	219	YT-6513	260	YT-06866	499	YT-07071	388	YT-7461	613	YT-8011	153	YT-8405	236	YT-08681	377
YT-6182	232	YT-06332	417	YT-06535	410	YT-06867	500	YT-7080	319								

YATO	page/strom	YATO	page/strom	YATO	page/strom	YATO	page/strom	YATO	page/strom	YATO	page/strom	YATO	page/strom	YATO	page/strom		
YT-08793	465	YT-08942	359	YT-09515	332	YT-12005	416	YT-15291	18	YT-18400	206	YT-21154	123	YT-22312	253	YT-23733	344
YT-08795	465	YT-08950	511	YT-09524	333	YT-12007	409	YT-15292	18	YT-18410	206	YT-21155	123	YT-22313	256	YT-24091	349
YT-8800	660	YT-8957	658	YT-09525	333	YT-12439	32	YT-15293	18	YT-18413	206	YT-21158	123	YT-22314	256	YT-24092	349
YT-8801	660	YT-08960	596	YT-09528	333	YT-12445	32	YT-15791	18	YT-18566	206	YT-21159	123	YT-22315	256	YT-24093	349
YT-08802	465	YT-8960	658	YT-09540	334	YT-12531	444	YT-16505	10	YT-18570	206	YT-21160	123	YT-22316	256	YT-24094	349
YT-8802	660	YT-8967	658	YT-09544	334	YT-12541	444	YT-16973	11	YT-18600	134	YT-21161	124	YT-22317	256	YT-24095	349
YT-8805	660	YT-8968	658	YT-09545	334	YT-12660	38	YT-17000	476	YT-18602	134	YT-21190	124	YT-22318	254	YT-24100	349
YT-8807	661	YT-08970	596	YT-09546	334	YT-12671	51	YT-17001	476	YT-18610	133	YT-21191	124	YT-22322	255	YT-24101	349
YT-8808	661	YT-8970	656	YT-09564	335	YT-12681	41	YT-17002	476	YT-18611	133	YT-21200	133	YT-22333	255	YT-24102	349
YT-8809	661	YT-8971	656	YT-09571	335	YT-12691	40	YT-17003	476	YT-18612	133	YT-21210	133	YT-22338	255	YT-24103	349
YT-8811	661	YT-8972	656	YT-09575	335	YT-12930	31	YT-17004	476	YT-18615	133	YT-21211	133	YT-22341	254	YT-24130	349
YT-8815	661	YT-08973	598	YT-09615	336	YT-12931	31	YT-17005	476	YT-18616	133	YT-21570	116	YT-22342	255	YT-24201	346
YT-8816	661	YT-8973	657	YT-09618	336	YT-12932	31	YT-17006	476	YT-18617	133	YT-21582	511	YT-22343	256	YT-24202	346
YT-8817	661	YT-08974	598	YT-09620	336	YT-12933	31	YT-17007	476	YT-18900	207	YT-21650	19	YT-22344	255	YT-24203	346
YT-8821	665	YT-8974	657	YT-09632	338	YT-12934	31	YT-17008	476	YT-18907	207	YT-21651	19	YT-22345	256	YT-24204	346
YT-8822	665	YT-8975	657	YT-09633	338	YT-12935	31	YT-17009	476	YT-18950	206	YT-21652	19	YT-22353	254	YT-24205	346
YT-8823	665	YT-8976	657	YT-09675	338	YT-12936	31	YT-17015	476	YT-18960	208	YT-21653	19	YT-22354	254	YT-24206	346
YT-8824	665	YT-8977	657	YT-09676	338	YT-12937	31	YT-17025	476	YT-18963	208	YT-21654	19	YT-22355	254	YT-24207	346
YT-8831	663	YT-8978	657	YT-09695	341	YT-12938	31	YT-17045	476	YT-18973	118	YT-21735	259	YT-22357	261	YT-24208	346
YT-8832	663	YT-8979	656	YT-09702	341	YT-12939	31	YT-17075	476	YT-19260	205	YT-21740	260	YT-22360	261	YT-24209	346
YT-8833	663	YT-8984	659	YT-09703	341	YT-12940	31	YT-17205	477	YT-19261	205	YT-21741	260	YT-22361	261	YT-24220	347
YT-8834	663	YT-8985	659	YT-09715	340	YT-12941	31	YT-17207	477	YT-19682	131	YT-21742	260	YT-22362	261	YT-24221	347
YT-8835	663	YT-8986	659	YT-09717	340	YT-12942	31	YT-17211	477	YT-19691	132	YT-21743	260	YT-22363	261	YT-24224	347
YT-8836	664	YT-8987	659	YT-09730	339	YT-12943	31	YT-17213	477	YT-19695	131	YT-21744	260	YT-22364	261	YT-24225	347
YT-8838	664	YT-8991	659	YT-09738	339	YT-12944	31	YT-17214	477	YT-19697	132	YT-21745	260	YT-22365	261	YT-24230	347
YT-8839	664	YT-8993	660	YT-09739	339	YT-12945	31	YT-17261	475	YT-19744	133	YT-21746	260	YT-22366	254	YT-24231	347
YT-8840	664	YT-09000	368	YT-09740	339	YT-12946	31	YT-17262	475	YT-19763	227	YT-21747	260	YT-22373	258	YT-24232	347
YT-8841	664	YT-09002	366	YT-09741	339	YT-12947	31	YT-17310	478	YT-19764	227	YT-21750	259	YT-22374	258	YT-24233	347
YT-8842	664	YT-09003	366	YT-09742	339	YT-12948	31	YT-17311	478	YT-19765	227	YT-21751	259	YT-22375	258	YT-24234	347
YT-8843	663	YT-09004	367	YT-09743	237	YT-12949	31	YT-17312	478	YT-19766	227	YT-21752	260	YT-22376	258	YT-24236	347
YT-8845	661	YT-09005	366	YT-09744	237	YT-12951	32	YT-17490	460	YT-19767	227	YT-21753	260	YT-22377	258	YT-24237	347
YT-8849	663	YT-09032	367	YT-09745	237	YT-12961	28	YT-17508	432	YT-19951	114	YT-21754	260	YT-22378	258	YT-24240	347
YT-8851	665	YT-09033	367	YT-09746	237	YT-12971	24	YT-17510	432	YT-19952	114	YT-21755	260	YT-22380	306	YT-24241	347
YT-8852	665	YT-09061	369	YT-09747	237	YT-13351	55	YT-17513	431	YT-19953	114	YT-21756	260	YT-22440	128	YT-24242	347
YT-8853	665	YT-09071	376	YT-09748	237	YT-13465	54	YT-17515	432	YT-19954	114	YT-21757	260	YT-22442	127	YT-24243	347
YT-8854	665	YT-09072	376	YT-09749	237	YT-13475	54	YT-17525	434	YT-19955	114	YT-21758	259	YT-22443	128	YT-24244	348
YT-8865	666	YT-09091	359	YT-09750	237	YT-13490	54	YT-17527	416	YT-19961	114	YT-21759	259	YT-22451	125	YT-24245	348
YT-8866	666	YT-09092	359	YT-09803	337	YT-13790	404	YT-17565	467	YT-19962	114	YT-21793	252	YT-22570	127	YT-24246	348
YT-8867	666	YT-09093	359	YT-09860	337	YT-14001	98	YT-17567	467	YT-19963	114	YT-21802	257	YT-22640	131	YT-24250	348
YT-8868	666	YT-09101	378	YT-09901	342	YT-14120	23	YT-17568	467	YT-19964	114	YT-21805	257	YT-22703	129	YT-24251	348
YT-8869	666	YT-09102	378	YT-09904	341	YT-14121	23	YT-17569	467	YT-19965	114	YT-21825	258	YT-22753	130	YT-24253	348
YT-8870	666	YT-09104	379	YT-09910	342	YT-14123	23	YT-17571	467	YT-19966	114	YT-21826	258	YT-22760	130	YT-24258	472
YT-08872	380	YT-09107	378	YT-09911	342	YT-14124	23	YT-17572	467	YT-19971	114	YT-21840	256	YT-22851	128	YT-24270	472
YT-08873	380	YT-09108	378	YT-09912	342	YT-14125	23	YT-17573	467	YT-19972	114	YT-21842	256	YT-22857	126	YT-24271	472
YT-08874	380	YT-09152	366	YT-09913	342	YT-14126	23	YT-17574	467	YT-19973	114	YT-21844	256	YT-22860	128	YT-24272	472
YT-8876	664	YT-09155	366	YT-09940	657	YT-14127	23	YT-17575	467	YT-19974	114	YT-21845	256	YT-22861	128	YT-24280	472
YT-8885	667	YT-09158	601	YT-9941	657	YT-14128	23	YT-17580	468	YT-19975	114	YT-21846	256	YT-22862	128	YT-24281	472
YT-8886	667	YT-09159	600	YT-09944	340	YT-14129	23	YT-17581	468	YT-19976	114	YT-21847	256	YT-22863	128	YT-24282	472
YT-8889	667	YT-09160	601	YT-09945	341	YT-14390	84	YT-17582	468	YT-19977	114	YT-21850	257	YT-22864	128	YT-24301	470
YT-8890	667	YT-09161	600	YT-09955	340	YT-14421	51	YT-17588	468	YT-19979	114	YT-21851	257	YT-22865	128	YT-24780	252
YT-8891	667	YT-09162	600	YT-09958	210	YT-14431	34	YT-17590	469	YT-19981	115	YT-21852	257	YT-22870	207	YT-24781	252
YT-8892	667	YT-09163	598	YT-09959	210	YT-14432	34	YT-17595	470	YT-19982	115	YT-21855	257	YT-22871	207	YT-24790	260
YT-8894	667	YT-09164	599	YT-09990	344	YT-14433	35	YT-17600	470	YT-19983	115	YT-21856	257	YT-22872	207	YT-24800	261
YT-08900	594	YT-09165	599	YT-10251	64	YT-14451	34	YT-17605	470	YT-19984	115	YT-21857	257	YT-22873	207	YT-24801	261
YT-08901	594	YT-09166	600	YT-10255	71	YT-14461	35	YT-17619	432	YT-19991	115	YT-21860	257	YT-22874	207	YT-24963	263
YT-08902	594	YT-09167	599	YT-10555	71	YT-14471	35	YT-17622	429	YT-19992	115	YT-21955	252	YT-22875	207	YT-24965	263
YT-08903	594	YT-09168	597	YT-10563	458	YT-14491	34	YT-17623	428	YT-19993	115	YT-21956	252	YT-22930	129	YT-24966	263
YT-08904	594	YT-09169	598	YT-10564	458	YT-14501	36	YT-17625	433	YT-19994	115	YT-21957	252	YT-23001	126	YT-24970	263
YT-08905	595	YT-09170	597	YT-10567	458	YT-14820	30	YT-17626	433	YT-19995	115	YT-21960	252	YT-23051	127	YT-24971	263
YT-08906	594	YT-09171	597	YT-10630	64	YT-14821	30	YT-17627	429	YT-20400	109	YT-21991	260	YT-23052	127	YT-24972	263
YT-08907	595	YT-09173	600	YT-10632	64	YT-14822	30	YT-17629	429	YT-20401	109	YT-22000	250	YT-23054	127	YT-24980	263
YT-08908	595	YT-09174	601	YT-10640	66	YT-14824	30	YT-17631	468	YT-20402	109	YT-22001	250	YT-23133	129	YT-24983	262
YT-08915	595	YT-09175	600	YT-10642	69	YT-14825	30	YT-17632	468	YT-20430	132	YT-22002	250	YT-23200	141	YT-24990	262
YT-08916	595	YT-09177	596	YT-10643	69	YT-14826	30	YT-17633	468	YT-20433	132	YT-22005	250	YT-23201	141	YT-24991	262
YT-08917	595	YT-09178	597	YT-10652	69	YT-14827	30	YT-17634	468	YT-20435	132	YT-22123	249	YT-23241	524	YT-25000	262
YT-08918	596	YT-09179	597	YT-10653	71	YT-14828	30	YT-17635	468	YT-20890	251	YT-22153	250	YT-23242	524	YT-25001	262
YT-08919	596	YT-09180	597	YT-10654	69	YT-1											

YATO	page/strona	YATO	page/strona	YATO	page/strona	YATO	page/strona	YATO	page/strona	YATO	page/strona	YATO	page/strona	YATO	page/strona
YT-25391	393	YT-25910	80	YT-28919	511	YT-31303	208	YT-35862	229	YT-37011	291	YT-38831	43	YT-43490	171
YT-25411	395	YT-25911	80	YT-28920	511	YT-31310	208	YT-35863	229	YT-37015	291	YT-38841	49	YT-43494	170
YT-25412	395	YT-25912	80	YT-28921	511	YT-31343	209	YT-35864	229	YT-37016	291	YT-38850	48	YT-43941	170
YT-25413	395	YT-25913	80	YT-28922	511	YT-31350	228	YT-35865	229	YT-37017	291	YT-38861	37	YT-43942	170
YT-25415	402	YT-25914	80	YT-28950	177	YT-31612	210	YT-35866	229	YT-37022	290	YT-38872	44	YT-43943	170
YT-25417	394	YT-25920	80	YT-28951	177	YT-33010	191	YT-35867	229	YT-37036	289	YT-38875	44	YT-43944	170
YT-25418	394	YT-25921	80	YT-28952	177	YT-33011	191	YT-35868	229	YT-37038	289	YT-38881	45	YT-43945	170
YT-25450	456	YT-25922	80	YT-28953	177	YT-33015	191	YT-35869	229	YT-37040	291	YT-38891	42	YT-43946	170
YT-25472	456	YT-25923	80	YT-28954	177	YT-33021	176	YT-35870	229	YT-37042	290	YT-38901	42	YT-43947	170
YT-25480	407	YT-25924	80	YT-28955	177	YT-33022	176	YT-35871	229	YT-37052	290	YT-38911	39	YT-43948	170
YT-25483	407	YT-25925	80	YT-28956	177	YT-33023	176	YT-35872	229	YT-37141	289	YT-38931	47	YT-43949	170
YT-25650	83	YT-25926	80	YT-28957	177	YT-33830	188	YT-35873	229	YT-37150	290	YT-38941	50	YT-43960	170
YT-25651	83	YT-25927	80	YT-28958	177	YT-33831	188	YT-35880	229	YT-37160	292	YT-38951	381	YT-43962	170
YT-25652	83	YT-25928	80	YT-28959	177	YT-33832	188	YT-35881	229	YT-37161	292	YT-39009	140	YT-43963	170
YT-25653	83	YT-25929	80	YT-28960	177	YT-33833	188	YT-35970	266	YT-37164	292	YT-39280	52	YT-43964	170
YT-25654	83	YT-25930	80	YT-28961	177	YT-33834	188	YT-35980	269	YT-37170	292	YT-39700	177	YT-43965	170
YT-25655	83	YT-25931	80	YT-28962	177	YT-33837	188	YT-35981	269	YT-37177	292	YT-39820	168	YT-43966	170
YT-25656	83	YT-25932	80	YT-28963	177	YT-33861	174	YT-35982	269	YT-37200	302	YT-40010	166	YT-43967	170
YT-25657	83	YT-25933	80	YT-28964	177	YT-33862	174	YT-35983	269	YT-37210	311	YT-40011	166	YT-43968	170
YT-25658	83	YT-25934	80	YT-28965	177	YT-33863	174	YT-36007	266	YT-37214	311	YT-40012	166	YT-43970	182
YT-25659	83	YT-25940	80	YT-28966	177	YT-33864	174	YT-36011	266	YT-37220	309	YT-40013	166	YT-43971	182
YT-25660	83	YT-25941	80	YT-28967	177	YT-33865	174	YT-36012	266	YT-37221	310	YT-40014	166	YT-43972	182
YT-25661	83	YT-25942	80	YT-29001	248	YT-33866	174	YT-36013	266	YT-37222	310	YT-40016	166	YT-43973	182
YT-25663	83	YT-25943	80	YT-29003	248	YT-33867	174	YT-36060	266	YT-37223	309	YT-40019	166	YT-43974	182
YT-25664	83	YT-25950	80	YT-29220	260	YT-33868	174	YT-36070	266	YT-37235	309	YT-40025	166	YT-43975	182
YT-25665	83	YT-25951	80	YT-29222	260	YT-33869	174	YT-36091	267	YT-37236	310	YT-40050	170	YT-43976	182
YT-25670	83	YT-25952	80	YT-29280	397	YT-33870	174	YT-36092	267	YT-37237	310	YT-41602	167	YT-43977	182
YT-25671	83	YT-25953	80	YT-29980	329	YT-33873	174	YT-36095	267	YT-37238	310	YT-41603	167	YT-43978	182
YT-25672	83	YT-25954	80	YT-29982	329	YT-33920	211	YT-36112	267	YT-37239	310	YT-41604	167	YT-43979	182
YT-25673	83	YT-25955	80	YT-29984	329	YT-33921	211	YT-36119	268	YT-37240	310	YT-41605	167	YT-43980	182
YT-25674	83	YT-25956	80	YT-30060	326	YT-33922	211	YT-36125	268	YT-37241	310	YT-41641	172	YT-43981	182
YT-25675	83	YT-25957	80	YT-30061	326	YT-33923	211	YT-36127	268	YT-37242	311	YT-41642	172	YT-43982	182
YT-25676	83	YT-25958	80	YT-30062	326	YT-33930	211	YT-36128	268	YT-37301	288	YT-41926	181	YT-43983	182
YT-25677	83	YT-25959	80	YT-30063	326	YT-33931	211	YT-36129	268	YT-37303	288	YT-41930	172	YT-43984	182
YT-25678	83	YT-25960	80	YT-30064	326	YT-33932	211	YT-36140	267	YT-37311	288	YT-41931	172	YT-43985	182
YT-25679	83	YT-25961	80	YT-30071	326	YT-33933	211	YT-36150	268	YT-37317	288	YT-41932	172	YT-43986	182
YT-25680	83	YT-25965	81	YT-30072	326	YT-33934	211	YT-36171	353	YT-37325	288	YT-41933	172	YT-43990	183
YT-25681	83	YT-25966	81	YT-30073	326	YT-33935	211	YT-36177	353	YT-37364	293	YT-41934	172	YT-43991	183
YT-25683	83	YT-25967	81	YT-30074	326	YT-33950	211	YT-36200	269	YT-37390	227	YT-41935	172	YT-43992	183
YT-25684	83	YT-25968	81	YT-30310	326	YT-33951	211	YT-36201	269	YT-37391	228	YT-41936	172	YT-43993	183
YT-25685	83	YT-25971	82	YT-30311	326	YT-33960	211	YT-36202	269	YT-37404	227	YT-41937	172	YT-43994	183
YT-25760	84	YT-25972	85	YT-30312	326	YT-33961	211	YT-36203	269	YT-37410	602	YT-41938	172	YT-43995	183
YT-25802	83	YT-25980	81	YT-30313	326	YT-33970	211	YT-36420	492	YT-37411	602	YT-41939	172	YT-44045	182
YT-25803	83	YT-25981	81	YT-30320	327	YT-33971	211	YT-36451	268	YT-37412	602	YT-41940	172	YT-44050	183
YT-25804	83	YT-25982	82	YT-30330	327	YT-33972	212	YT-36452	268	YT-37420	302	YT-41941	172	YT-44051	183
YT-25805	83	YT-25985	80	YT-30331	327	YT-34670	192	YT-36453	268	YT-37421	302	YT-41942	172	YT-44052	183
YT-25806	83	YT-25986	80	YT-30340	327	YT-34671	192	YT-36454	268	YT-37422	303	YT-41943	172	YT-44053	183
YT-25807	83	YT-25987	80	YT-30370	326	YT-34680	214	YT-36460	269	YT-37423	303	YT-41944	172	YT-44054	183
YT-25808	83	YT-25988	80	YT-30395	327	YT-34681	214	YT-36470	268	YT-37430	303	YT-41945	172	YT-44055	183
YT-25809	83	YT-25989	80	YT-30397	327	YT-34682	214	YT-36471	268	YT-37433	303	YT-41946	172	YT-44056	183
YT-25810	83	YT-25990	80	YT-30400	327	YT-34683	215	YT-36472	268	YT-37434	303	YT-41947	172	YT-44057	183
YT-25811	83	YT-25991	80	YT-30410	324	YT-34684	215	YT-36473	268	YT-37440	303	YT-41948	172	YT-44058	183
YT-25831	83	YT-25992	80	YT-30414	324	YT-34685	215	YT-36474	268	YT-37441	303	YT-41949	172	YT-44059	183
YT-25832	83	YT-25993	80	YT-30433	323	YT-34686	216	YT-36475	268	YT-37444	304	YT-41950	172	YT-44060	183
YT-25833	83	YT-25994	80	YT-30434	323	YT-34687	217	YT-36476	268	YT-37450	304	YT-41951	172	YT-44061	183
YT-25834	83	YT-25995	80	YT-30435	324	YT-34688	218	YT-36480	269	YT-37470	307	YT-41952	172	YT-44062	183
YT-25835	83	YT-25996	80	YT-30436	324	YT-34689	218	YT-36481	269	YT-37490	603	YT-41953	172	YT-44063	183
YT-25836	83	YT-25997	80	YT-30460	324	YT-34690	218	YT-36510	269	YT-38510	444	YT-41954	172	YT-44064	183
YT-25837	83	YT-25998	81	YT-30461	324	YT-34691	218	YT-36700	275	YT-38511	444	YT-41955	172	YT-44065	183
YT-25838	83	YT-27930	517	YT-30464	324	YT-34692	218	YT-36701	277	YT-38512	445	YT-41956	172	YT-44066	183
YT-25839	83	YT-27940	84	YT-30465	324	YT-34693	218	YT-36706	276	YT-38516	445	YT-41957	172	YT-44067	183
YT-25840	83	YT-28000	85	YT-30471	325	YT-34700	216	YT-36709	276	YT-38517	445	YT-41958	172	YT-44068	183
YT-25852	83	YT-28003	85	YT-30473	325	YT-34701	215	YT-36710	276	YT-38520	445	YT-41959	172	YT-44069	183
YT-25853	83	YT-28015	85	YT-30475	325	YT-34702	217	YT-36711	275	YT-38521	445	YT-41960	172	YT-44070	183
YT-25854	83	YT-28150	122	YT-30477	325	YT-34703	217	YT-36712	276	YT-38522	445	YT-41961	172	YT-44071	183
YT-25855	83	YT-28153	122	YT-30479	325	YT-34710	216	YT-36715	276	YT-38550	433	YT-41962	172	YT-44072	183
YT-25856	83	YT-28174	122	YT-30491	325	YT-34711	214	YT-36720	275	YT-38561	36	YT-41963	172	YT-44073	183
YT-25857	83	YT-28245	122	YT-30492	325	YT-34712	216	YT-36725	275	YT-38650	51	YT-41964	172	YT-44074	183
YT-25861	83	YT-28263	122	YT-30500	325	YT-34713	217	YT-36726	275	YT-38653	51	YT-41965	172	YT-44077	184
YT-25862	83	YT-28283	123	YT-30503	325	YT-35850	229	YT-36727	275	YT-38671	37	YT-41966	172	YT-44080	284
YT-25863	83	YT-28290	122	YT-30600	305	YT-35851	229	YT-36730	277	YT-38680	38	YT-41967	172	YT-44081	284
YT-25900	80	YT-28293	122	YT-30610	305	YT-35852	229	YT-36731	277	YT-38681	37	YT-41968	172	YT-44085	284
YT-25901	80	YT-28294	123	YT-30700	307	YT-35853	229	YT-36740	277	YT-38683	36	YT-41969	172	YT-44087	284
YT-25902	80	YT-28295	123	YT-30900	296	YT-35854	229	YT-36741	277	YT-38741	37	YT-41970	172	YT-44095	178
YT-25903	80	YT-28300	134	YT-31091	208</										

YATO	page/strom	YATO	page/strom	YATO	page/strom	YATO	page/strom	YATO	page/strom	YATO	page/strom	YATO	page/strom	YATO	page/strom		
YT-44668	167	YT-44831	168	YT-47021	149	YT-47883	243	YT-52245	294	YT-55073	309	YT-58962	484	YT-60445	177	YT-61742	189
YT-44673	169	YT-44840	185	YT-47022	149	YT-47884	243	YT-52246	294	YT-55210	369	YT-58964	484	YT-60446	177	YT-61743	189
YT-44674	169	YT-44841	185	YT-47121	150	YT-47889	242	YT-52247	294	YT-55212	369	YT-58966	484	YT-60447	177	YT-61747	191
YT-44675	169	YT-44842	185	YT-47122	151	YT-47892	242	YT-52310	298	YT-55290	365	YT-58967	484	YT-60480	199	YT-61750	190
YT-44676	169	YT-44843	185	YT-47123	150	YT-47893	242	YT-52311	298	YT-55293	361	YT-59155	202	YT-60482	199	YT-61751	190
YT-44677	168	YT-44845	185	YT-47124	150	YT-47894	242	YT-52312	298	YT-55299	368	YT-59156	202	YT-60484	199	YT-61770	191
YT-44680	174	YT-44847	185	YT-47141	150	YT-47895	242	YT-52313	298	YT-55300	363	YT-59164	201	YT-60488	198	YT-61771	191
YT-44681	174	YT-44849	185	YT-47142	150	YT-47896	243	YT-52314	298	YT-55307	364	YT-59165	201	YT-60489	198	YT-61772	191
YT-44682	174	YT-44860	168	YT-47143	150	YT-47900	243	YT-52317	294	YT-55308	360	YT-59166	201	YT-60522	198	YT-61773	191
YT-44683	174	YT-44861	168	YT-47144	150	YT-47901	243	YT-52320	299	YT-55311	375	YT-59167	201	YT-60533	198	YT-62228	232
YT-44684	174	YT-44863	168	YT-47145	150	YT-47902	243	YT-52471	299	YT-55321	375	YT-59168	202	YT-60577	198	YT-62229	232
YT-44685	174	YT-44865	168	YT-47146	150	YT-47910	243	YT-52472	299	YT-55331	375	YT-59169	202	YT-60581	198	YT-62231	232
YT-44686	174	YT-44866	168	YT-47147	149	YT-47911	243	YT-52473	299	YT-55341	375	YT-59170	202	YT-60582	198	YT-62238	232
YT-44687	174	YT-44867	168	YT-47148	149	YT-47912	243	YT-52477	298	YT-55351	375	YT-59177	202	YT-60583	198	YT-62239	232
YT-44688	174	YT-44868	168	YT-47149	149	YT-47913	243	YT-52550	227	YT-55361	375	YT-59178	202	YT-60590	198	YT-62241	232
YT-44689	174	YT-44869	168	YT-47150	150	YT-47920	242	YT-52621	293	YT-55371	375	YT-59179	202	YT-60591	198	YT-62243	232
YT-44690	174	YT-44870	168	YT-47151	150	YT-47921	242	YT-52622	273	YT-55381	375	YT-59180	202	YT-60621	198	YT-62244	232
YT-44693	175	YT-44871	168	YT-47152	150	YT-47922	242	YT-52740	294	YT-55391	375	YT-59181	202	YT-60622	198	YT-62245	232
YT-44700	169	YT-44872	168	YT-47155	150	YT-47930	244	YT-52760	293	YT-55401	375	YT-59182	202	YT-60627	199	YT-62246	232
YT-44705	169	YT-44874	168	YT-47160	228	YT-47931	244	YT-52780	293	YT-55411	375	YT-59183	202	YT-60628	199	YT-62248	232
YT-44721	187	YT-44875	168	YT-47161	228	YT-47932	244	YT-52788	231	YT-55421	375	YT-59184	202	YT-60631	199	YT-62249	232
YT-44722	187	YT-44876	168	YT-47170	150	YT-47933	244	YT-52790	295	YT-55443	370	YT-59185	202	YT-60633	198	YT-62251	232
YT-44723	187	YT-44877	168	YT-47195	181	YT-47940	244	YT-52840	230	YT-55444	371	YT-59951	196	YT-60634	198	YT-62258	232
YT-44724	187	YT-44878	168	YT-47197	181	YT-47945	244	YT-52841	230	YT-55451	373	YT-59952	196	YT-60635	198	YT-62259	232
YT-44725	187	YT-44879	168	YT-47200	179	YT-48200	197	YT-52843	230	YT-55453	373	YT-59955	196	YT-60636	198	YT-62261	232
YT-44726	187	YT-44880	168	YT-47212	179	YT-48201	197	YT-52850	230	YT-55455	371	YT-59961	196	YT-60652	198	YT-62268	232
YT-44729	188	YT-44881	168	YT-47301	153	YT-48202	197	YT-52860	231	YT-55456	370	YT-59962	196	YT-60665	198	YT-62269	232
YT-44730	187	YT-44882	168	YT-47303	153	YT-48203	197	YT-52863	231	YT-55457	373	YT-59965	196	YT-60682	198	YT-62271	232
YT-44731	187	YT-44883	168	YT-47304	153	YT-48204	197	YT-52870	294	YT-55458	372	YT-59971	196	YT-60685	198	YT-62328	232
YT-44732	187	YT-44884	168	YT-47330	180	YT-48205	197	YT-52871	294	YT-55462	372	YT-59972	196	YT-60686	198	YT-62329	232
YT-44739	187	YT-44888	169	YT-47331	179	YT-48206	197	YT-54090	306	YT-55463	370	YT-59975	196	YT-60687	198	YT-62331	232
YT-44740	187	YT-45280	146	YT-47335	180	YT-49123	9	YT-54101	306	YT-55464	371	YT-59981	196	YT-60731	198	YT-62338	232
YT-44741	187	YT-45281	146	YT-47336	180	YT-51303	118	YT-54153	305	YT-55465	374	YT-59982	196	YT-60732	198	YT-62339	232
YT-44742	187	YT-45282	146	YT-47340	180	YT-51311	118	YT-54200	306	YT-55466	374	YT-59985	196	YT-60733	198	YT-62341	232
YT-44743	187	YT-45480	147	YT-47341	180	YT-51312	118	YT-54230	306	YT-55469	371	YT-60003	196	YT-60782	198	YT-62348	232
YT-44744	187	YT-45481	147	YT-47344	180	YT-51320	118	YT-54233	307	YT-55471	374	YT-60004	196	YT-60783	198	YT-62349	232
YT-44745	187	YT-45482	147	YT-47345	180	YT-51450	269	YT-54240	307	YT-55472	370	YT-060022	419	YT-60784	198	YT-62351	232
YT-44746	187	YT-45483	147	YT-47348	180	YT-51451	269	YT-54300	300	YT-55473	370	YT-060175	424	YT-60785	198	YT-62358	232
YT-44747	187	YT-45484	147	YT-47370	181	YT-51452	269	YT-54310	300	YT-55474	373	YT-060176	419	YT-60791	198	YT-62359	232
YT-44750	168	YT-45485	147	YT-47372	181	YT-51470	271	YT-54313	300	YT-55476	374	YT-060261	423	YT-60792	198	YT-62780	149
YT-44751	168	YT-45486	147	YT-47375	181	YT-51471	271	YT-54320	300	YT-55477	374	YT-060262	426	YT-60794	198	YT-62821	148
YT-44752	168	YT-45487	147	YT-47377	181	YT-51880	295	YT-54400	299	YT-55478	374	YT-060302	459	YT-60795	198	YT-62822	148
YT-44754	168	YT-45488	147	YT-47380	181	YT-51881	295	YT-54500	301	YT-55479	375	YT-060303	459	YT-60871	198	YT-62823	148
YT-44755	168	YT-45489	147	YT-47385	181	YT-51900	296	YT-54501	301	YT-55480	371	YT-060304	459	YT-60872	198	YT-62824	148
YT-44756	168	YT-45490	147	YT-47496	220	YT-51901	296	YT-54502	301	YT-55481	371	YT-060305	459	YT-60905	199	YT-62825	148
YT-44757	168	YT-45491	147	YT-47497	220	YT-51902	296	YT-54503	301	YT-55500	478	YT-060306	459	YT-60907	199	YT-62826	148
YT-44758	168	YT-45492	147	YT-47511	220	YT-51903	296	YT-54504	301	YT-55503	478	YT-60322	197	YT-61025	200	YT-62827	148
YT-44759	168	YT-45493	147	YT-47518	220	YT-51904	296	YT-54505	301	YT-55510	479	YT-60323	197	YT-61132	200	YT-62828	148
YT-44760	168	YT-45494	147	YT-47553	223	YT-51905	297	YT-54540	301	YT-55511	479	YT-60371	197	YT-61395	235	YT-62840	149
YT-44761	168	YT-45650	147	YT-47554	223	YT-51906	297	YT-54541	301	YT-55512	479	YT-60372	197	YT-061602	400	YT-62900	231
YT-44763	168	YT-45655	147	YT-47555	223	YT-51907	297	YT-54542	301	YT-55513	479	YT-60373	197	YT-61678	235	YT-62907	231
YT-44764	168	YT-45660	145	YT-47565	221	YT-51908	297	YT-54543	301	YT-55556	487	YT-60374	197	YT-61679	235	YT-62910	231
YT-44765	168	YT-45905	146	YT-47568	221	YT-51909	296	YT-54544	301	YT-55557	487	YT-60375	197	YT-61680	235	YT-62930	288
YT-44766	168	YT-46190	146	YT-47593	221	YT-51910	297	YT-54550	301	YT-55565	488	YT-60376	197	YT-61681	235	YT-63701	262
YT-44767	168	YT-46191	146	YT-47612	222	YT-51911	297	YT-54551	301	YT-55567	488	YT-60377	197	YT-61700	189	YT-63702	262
YT-44768	168	YT-46270	146	YT-47658	223	YT-51920	297	YT-54552	301	YT-55568	488	YT-60378	197	YT-61701	189	YT-63703	262
YT-44769	168	YT-46273	146	YT-47691	223	YT-51921	298	YT-54553	301	YT-55570	488	YT-60379	197	YT-61702	189	YT-63704	262
YT-44770	168	YT-46500	307	YT-47695	219	YT-51960	300	YT-54554	301	YT-55580	487	YT-60401	176	YT-61703	189	YT-63705	262
YT-44772	168	YT-46501	307	YT-47696	219	YT-51961	300	YT-54560	301	YT-55581	487	YT-60402	176	YT-61704	189	YT-63740	262
YT-44773	168	YT-46750	153	YT-47697	219	YT-51962	300	YT-54561	301	YT-55582	487	YT-60403	176	YT-61705	189	YT-63951	158
YT-44774	168	YT-46800	152	YT-47698	219	YT-51963	300	YT-54562	301	YT-55600	485	YT-60409	176	YT-61706	189	YT-63952	158
YT-44776	168	YT-46801	152	YT-47770	201	YT-51964	300	YT-54590	301	YT-55601	485	YT-60421	176	YT-61707	189	YT-63953	158
YT-44780	171	YT-46802	152	YT-47777	223	YT-51970	300	YT-54591	301	YT-55670	478	YT-60422	176	YT-61711	190	YT-63954	158
YT-44781	171	YT-46803	152	YT-47780	220	YT-51971	300	YT-54592	301	YT-55675	478	YT-60423	176	YT-61712	191	YT-63955	158
YT-44782	171	YT-46804	152	YT-47782	220	YT-51973	300	YT-54593	301	YT-55690	473	YT-60424	176	YT-61714	189	YT-63956	158
YT-44783	171	YT-46810	152	YT-47785	223	YT-52220	294	YT-54620</									

YATO	page/strona	YATO	page/strona	YATO	page/strona	YATO	page/strona	YATO	page/strona	YATO	page/strona	YATO	page/strona	YATO	page/strona
YT-64255	159	YT-068711	491	YT-70677	274	YT-72106	328	YT-73602	606	YT-74520	614	YT-76042	225	YT-78340	619
YT-64256	159	YT-068713	490	YT-70678	274	YT-72107	328	YT-73603	607	YT-74521	614	YT-76043	225	YT-78341	619
YT-64257	159	YT-068721	490	YT-70713	318	YT-72108	328	YT-73611	607	YT-74551	614	YT-76050	224	YT-78342	619
YT-64258	159	YT-068791	496	YT-70715	318	YT-72115	328	YT-73612	607	YT-74612	612	YT-76051	224	YT-78343	619
YT-64262	159	YT-068911	497	YT-70720	318	YT-72116	328	YT-73613	607	YT-74615	613	YT-76052	224	YT-78420	621
YT-64263	159	YT-068912	497	YT-70721	318	YT-72120	328	YT-73614	607	YT-74621	615	YT-76080	235	YT-78421	621
YT-64270	158	YT-068913	498	YT-70722	318	YT-72121	328	YT-73615	607	YT-74624	614	YT-76085	235	YT-78422	621
YT-64271	158	YT-068914	499	YT-70723	318	YT-72122	328	YT-73621	607	YT-74625	616	YT-76086	235	YT-78423	621
YT-64272	158	YT-068915	498	YT-70724	318	YT-72125	328	YT-73631	606	YT-74626	616	YT-76087	235	YT-78424	621
YT-64275	158	YT-068920	499	YT-70725	318	YT-72126	328	YT-73634	606	YT-74630	615	YT-76101	238	YT-78425	621
YT-64276	158	YT-69280	312	YT-70726	318	YT-72127	328	YT-73641	606	YT-74631	615	YT-76103	238	YT-78426	621
YT-64277	158	YT-69281	312	YT-70727	318	YT-72140	329	YT-73700	607	YT-74632	615	YT-76105	238	YT-78427	621
YT-64278	158	YT-69285	312	YT-70730	228	YT-72141	329	YT-73701	607	YT-74633	615	YT-76108	238	YT-78428	621
YT-64300	158	YT-69286	312	YT-70740	321	YT-72300	321	YT-73702	607	YT-74635	615	YT-76260	304	YT-78429	621
YT-64307	158	YT-69287	312	YT-70770	320	YT-72301	321	YT-73703	607	YT-74636	615	YT-76261	304	YT-78430	621
YT-64320	159	YT-69290	312	YT-70771	320	YT-72302	321	YT-73760	606	YT-74637	616	YT-76266	304	YT-78431	621
YT-64551	305	YT-69291	312	YT-70772	320	YT-72303	321	YT-73761	606	YT-74638	616	YT-76270	304	YT-78432	621
YT-64552	305	YT-69930	312	YT-70780	318	YT-72305	321	YT-73765	607	YT-74639	609	YT-76280	304	YT-78433	621
YT-64970	161	YT-69931	312	YT-70781	318	YT-72450	454	YT-73766	607	YT-74640	609	YT-77540	61	YT-78434	621
YT-65000	161	YT-69932	312	YT-70782	318	YT-72453	454	YT-73810	608	YT-74642	609	YT-77541	60	YT-78435	621
YT-65001	161	YT-69940	311	YT-70783	318	YT-72460	454	YT-73830	608	YT-74645	609	YT-77542	61	YT-78436	621
YT-65002	161	YT-70020	270	YT-70786	318	YT-72960	483	YT-73831	608	YT-74647	610	YT-78000	86	YT-78437	621
YT-65003	161	YT-70021	270	YT-70787	318	YT-72963	439	YT-73832	608	YT-74650	610	YT-78001	86	YT-78438	621
YT-65006	161	YT-70270	271	YT-70791	319	YT-72970	454	YT-73840	608	YT-74658	610	YT-78002	86	YT-78439	621
YT-65007	161	YT-70271	271	YT-70792	319	YT-72971	409	YT-73842	608	YT-74659	610	YT-78003	86	YT-78440	621
YT-65008	161	YT-70272	271	YT-70794	319	YT-72977	483	YT-73845	280	YT-74660	610	YT-78004	86	YT-78441	621
YT-65048	160	YT-70273	271	YT-70796	320	YT-72978	483	YT-73855	280	YT-74661	610	YT-78005	86	YT-78442	621
YT-65049	160	YT-70274	271	YT-70797	320	YT-72981	448	YT-73861	280	YT-74662	610	YT-78010	86	YT-78443	621
YT-65071	161	YT-70560	274	YT-70823	319	YT-72982	448	YT-73921	509	YT-74663	610	YT-78011	86	YT-78444	621
YT-65072	161	YT-70561	274	YT-70825	320	YT-72985	448	YT-73924	510	YT-74664	610	YT-78012	86	YT-78445	621
YT-65073	161	YT-70562	274	YT-70843	319	YT-72986	448	YT-73929	510	YT-74665	610	YT-78013	86	YT-78446	621
YT-65080	160	YT-70563	274	YT-70850	318	YT-72990	438	YT-73930	509	YT-74666	610	YT-78014	86	YT-78447	621
YT-65081	160	YT-70564	274	YT-70851	318	YT-72995	441	YT-73931	510	YT-74699	609	YT-78015	86	YT-78448	621
YT-65082	160	YT-70565	274	YT-70853	329	YT-72996	442	YT-73932	509	YT-74719	609	YT-78016	86	YT-78449	621
YT-65085	161	YT-70566	274	YT-70855	319	YT-73011	435	YT-73933	510	YT-74728	609	YT-78020	87	YT-78450	621
YT-65136	161	YT-70567	274	YT-70870	292	YT-73012	436	YT-73934	510	YT-74729	609	YT-78021	87	YT-78451	621
YT-66700	377	YT-70580	274	YT-70880	319	YT-73022	436	YT-73935	510	YT-74739	609	YT-78022	87	YT-78452	621
YT-67220	302	YT-70581	274	YT-70890	284	YT-73023	437	YT-73970	616	YT-74751	609	YT-78023	87	YT-78453	621
YT-67221	302	YT-70582	274	YT-71000	329	YT-73024	436	YT-73971	616	YT-74752	609	YT-78024	87	YT-78454	621
YT-67370	406	YT-70583	274	YT-71003	329	YT-73025	435	YT-73972	616	YT-74753	609	YT-78025	87	YT-78455	621
YT-67371	406	YT-70584	274	YT-71004	329	YT-73030	437	YT-73973	616	YT-74754	609	YT-78030	87	YT-78470	620
YT-67380	473	YT-70585	274	YT-71005	329	YT-73031	437	YT-73974	616	YT-74755	609	YT-78031	87	YT-78471	620
YT-67381	473	YT-70586	274	YT-71070	316	YT-73032	436	YT-73975	616	YT-74756	609	YT-78032	87	YT-78472	620
YT-67382	473	YT-70587	274	YT-71071	316	YT-73040	455	YT-74001	590	YT-74757	609	YT-78033	87	YT-78473	620
YT-67383	473	YT-70588	274	YT-71072	316	YT-73045	455	YT-74002	590	YT-74758	609	YT-78034	87	YT-78474	620
YT-67385	473	YT-70630	274	YT-71073	316	YT-73050	437	YT-74008	603	YT-74759	609	YT-78035	87	YT-78475	620
YT-67421	272	YT-70631	274	YT-71075	316	YT-73055	438	YT-74009	603	YT-74771	609	YT-78036	87	YT-78476	620
YT-67422	272	YT-70632	274	YT-71076	316	YT-73065	442	YT-74050	464	YT-74772	609	YT-78040	87	YT-78477	620
YT-67433	272	YT-70633	274	YT-71077	316	YT-73072	435	YT-74051	464	YT-74820	610	YT-78041	87	YT-78478	620
YT-67441	272	YT-70634	274	YT-71080	317	YT-73077	138	YT-74060	611	YT-74824	610	YT-78042	87	YT-78479	620
YT-67460	272	YT-70635	274	YT-71081	317	YT-73078	138	YT-74070	590	YT-74852	613	YT-78043	87	YT-78480	620
YT-67470	273	YT-70636	274	YT-71082	317	YT-73079	502	YT-74071	590	YT-74862	613	YT-78044	87	YT-78481	620
YT-67520	273	YT-70637	274	YT-71085	317	YT-73080	136	YT-74141	591	YT-74870	613	YT-78045	87	YT-78482	620
YT-67560	273	YT-70638	274	YT-71086	317	YT-73081	136	YT-74172	592	YT-74917	613	YT-78050	87	YT-78483	620
YT-67570	273	YT-70639	274	YT-71087	317	YT-73083	137	YT-74218	611	YT-74919	613	YT-78051	87	YT-78484	620
YT-67571	273	YT-70650	274	YT-71150	317	YT-73085	137	YT-74220	611	YT-74949	613	YT-78052	87	YT-78485	620
YT-67573	273	YT-70651	274	YT-71151	317	YT-73087	138	YT-74221	611	YT-75001	225	YT-78053	87	YT-78486	620
YT-67574	273	YT-70652	274	YT-71153	317	YT-73089	137	YT-74225	612	YT-75002	225	YT-78054	87	YT-78487	620
YT-67580	299	YT-70653	274	YT-71155	317	YT-73090	138	YT-74227	612	YT-75003	225	YT-78055	87	YT-78488	620
YT-67583	299	YT-70654	274	YT-71156	317	YT-73091	138	YT-74229	612	YT-75071	226	YT-78056	87	YT-78489	620
YT-067833	494	YT-70655	274	YT-71320	317	YT-73092	138	YT-74230	612	YT-75072	226	YT-78057	87	YT-78490	620
YT-067834	494	YT-70656	274	YT-71540	317	YT-73093	138	YT-74231	612	YT-75101	226	YT-78130	89	YT-78491	620
YT-067842	493	YT-70657	274	YT-71541	317	YT-73094	137	YT-74235	611	YT-75121	226	YT-78131	89	YT-78492	620
YT-68000	192	YT-70658	274	YT-71570	317	YT-73096	137	YT-74236	612	YT-75122	226	YT-78132	89	YT-78493	620
YT-68001	192	YT-70659	274	YT-71571	317	YT-73097	137	YT-74241	611	YT-75123	225	YT-78133	89	YT-78494	620
YT-68002	194	YT-70660	274	YT-71572	317	YT-73122	322	YT-74242	611	YT-75124	226	YT-78134	89	YT-78495	620
YT-68005	193	YT-70661	274	YT-71580	317	YT-73126	322	YT-74246	603	YT-75140	228	YT-78135	89	YT-78496	620
YT-68006	193	YT-70662	274	YT-71581	317	YT-73127	322	YT-74261	603	YT-75201	225	YT-78136	89	YT-78497	620
YT-68007	194	YT-70663	274	YT-71582	317	YT-73129	323	YT-74262	603	YT-75260	226	YT-78141	89	YT-78498	620
YT-068581	491	YT-70664	274	YT-71650	323	YT-73131	136	YT-74263	603	YT-75261	226	YT-78142	89	YT-78499	620
YT-068582	491	YT-70665	274	YT-71655	323	YT-73137	135	YT-74290	593	YT-75262	227	YT-78143	89	YT-78500	620
YT-068641	490	YT-70666	274	YT-71700	317	YT-73138	136	YT-74291	593	YT-75360	228	YT-78144	89	YT-78501	620
YT-068652	490	YT-70667	274	YT-71701	317	YT-73140	316	YT-74333	593	YT-75370	228	YT-78145	89	YT-78502	620
YT-068661	499	YT-70668	274	YT-71702	317	YT-73141	316	YT-74351							

YATO	page/strona	YATO	page/strona	YATO	page/strona	YATO	page/strona	YATO	page/strona	YATO	page/strona	YATO	page/strona	YATO	page/strona	YATO	page/strona
YT-79082	628	YT-79362	628	YT-80158	625	YT-80509	618	YT-80739	618	YT-81001	653	YT-82034	538	YT-82306	283	YT-82564	550
YT-79083	628	YT-79363	628	YT-80159	625	YT-80510	618	YT-80740	618	YT-81002	653	YT-82036	539	YT-82307	283	YT-82565	551
YT-79084	628	YT-79364	628	YT-80160	625	YT-80511	618	YT-80741	618	YT-81003	653	YT-82037	539	YT-82320	554	YT-82566	551
YT-79085	628	YT-79365	628	YT-80161	625	YT-80512	618	YT-80750	618	YT-81025	652	YT-82044	539	YT-82330	548	YT-82567	551
YT-79090	627	YT-79440	628	YT-80162	625	YT-80513	618	YT-80751	618	YT-81026	652	YT-82045	539	YT-82332	549	YT-82568	551
YT-79091	627	YT-79441	628	YT-80163	625	YT-80514	618	YT-80752	618	YT-81027	652	YT-82055	543	YT-82333	549	YT-82595	542
YT-79092	627	YT-79442	628	YT-80164	629	YT-80515	618	YT-80753	618	YT-81028	652	YT-82060	539	YT-82334	549	YT-82596	542
YT-79093	627	YT-79443	628	YT-80165	629	YT-80516	618	YT-80754	618	YT-81030	653	YT-82063	539	YT-82335	549	YT-82597	542
YT-79094	627	YT-79444	628	YT-80166	629	YT-80517	618	YT-80755	618	YT-81031	653	YT-82071	540	YT-82336	549	YT-82600	542
YT-79095	627	YT-79445	628	YT-80167	629	YT-80521	617	YT-80756	618	YT-81032	653	YT-82077	517	YT-82337	549	YT-82601	542
YT-79100	627	YT-79520	624	YT-80168	629	YT-80522	617	YT-80757	618	YT-81052	653	YT-82080	532	YT-82340	548	YT-82604	542
YT-79101	627	YT-79521	624	YT-80169	629	YT-80523	617	YT-80758	618	YT-81053	653	YT-82096	532	YT-82350	549	YT-82607	543
YT-79102	627	YT-79522	624	YT-80170	631	YT-80524	617	YT-80783	619	YT-81054	653	YT-82097	532	YT-82353	242	YT-82611	542
YT-79103	627	YT-79523	624	YT-80171	631	YT-80525	617	YT-80784	619	YT-81121	652	YT-82098	533	YT-82354	242	YT-82612	542
YT-79104	627	YT-79524	624	YT-80172	631	YT-80526	617	YT-80785	619	YT-81122	652	YT-82099	533	YT-82355	549	YT-82613	542
YT-79105	627	YT-79525	624	YT-80173	631	YT-80527	617	YT-80786	619	YT-81162	653	YT-82100	533	YT-82360	529	YT-82700	279
YT-79110	627	YT-79540	624	YT-80174	631	YT-80528	617	YT-80787	619	YT-81220	484	YT-82101	533	YT-82361	529	YT-82701	279
YT-79111	627	YT-79541	624	YT-80175	631	YT-80529	617	YT-80788	619	YT-81221	484	YT-82104	534	YT-82380	546	YT-82742	280
YT-79112	627	YT-79542	624	YT-80176	625	YT-80530	617	YT-80789	619	YT-81240	653	YT-82105	534	YT-82390	546	YT-82743	280
YT-79113	627	YT-79543	624	YT-80177	625	YT-80531	617	YT-80790	619	YT-81241	653	YT-82106	534	YT-82395	537	YT-82744	280
YT-79114	627	YT-79544	624	YT-80178	625	YT-80532	617	YT-80791	619	YT-81242	653	YT-82110	534	YT-82396	537	YT-82751	527
YT-79115	627	YT-79545	624	YT-80179	625	YT-80533	617	YT-80820	299	YT-81300	652	YT-82118	540	YT-82401	556	YT-82753	527
YT-79120	627	YT-79550	623	YT-80180	625	YT-80534	617	YT-80841	618	YT-81301	652	YT-82122	540	YT-82402	556	YT-82755	527
YT-79121	627	YT-79551	623	YT-80181	625	YT-80535	617	YT-80842	618	YT-81302	652	YT-82123	540	YT-82403	556	YT-82760	523
YT-79122	627	YT-79552	623	YT-80182	629	YT-80536	617	YT-80843	618	YT-81303	652	YT-82127	541	YT-82430	283	YT-82763	517
YT-79123	627	YT-79553	623	YT-80183	629	YT-80537	617	YT-80844	618	YT-81355	508	YT-82131	541	YT-82431	283	YT-82765	524
YT-79124	627	YT-79554	623	YT-80184	629	YT-80538	617	YT-80845	618	YT-81357	508	YT-82133	541	YT-82433	283	YT-82770	528
YT-79125	627	YT-79555	623	YT-80185	629	YT-80583	617	YT-80846	618	YT-81358	508	YT-82135	541	YT-82434	283	YT-82772	528
YT-79130	627	YT-79560	623	YT-80186	629	YT-80584	617	YT-80847	618	YT-81440	500	YT-82138	532	YT-82435	283	YT-82780	519
YT-79131	627	YT-79561	623	YT-80187	629	YT-80585	617	YT-80848	618	YT-81441	501	YT-82141	546	YT-82436	283	YT-82781	519
YT-79132	627	YT-79562	623	YT-80188	632	YT-80586	617	YT-80849	618	YT-81442	501	YT-82144	546	YT-82437	283	YT-82786	519
YT-79133	627	YT-79563	623	YT-80189	632	YT-80587	617	YT-80881	619	YT-81443	501	YT-82148	545	YT-82438	283	YT-82787	519
YT-79134	627	YT-79564	623	YT-80190	632	YT-80588	617	YT-80882	619	YT-81450	501	YT-82151	543	YT-82439	283	YT-82790	520
YT-79135	627	YT-79565	623	YT-80191	632	YT-80589	617	YT-80883	619	YT-81451	500	YT-82152	543	YT-82440	283	YT-82791	520
YT-79140	627	YT-79710	632	YT-80192	632	YT-80590	617	YT-80884	619	YT-81452	501	YT-82154	543	YT-82441	283	YT-82792	520
YT-79141	627	YT-79711	632	YT-80193	632	YT-80591	617	YT-80885	619	YT-81453	501	YT-82158	537	YT-82442	283	YT-82794	520
YT-79142	627	YT-79712	632	YT-80280	625	YT-80620	618	YT-80886	619	YT-81454	501	YT-82159	537	YT-82443	283	YT-82795	520
YT-79143	627	YT-79713	632	YT-80281	625	YT-80621	618	YT-80887	619	YT-81460	501	YT-82161	537	YT-82444	283	YT-82796	520
YT-79144	627	YT-79714	632	YT-80282	625	YT-80622	618	YT-80888	619	YT-81461	502	YT-82163	536	YT-82445	283	YT-82797	520
YT-79145	627	YT-79715	632	YT-80283	625	YT-80623	618	YT-80900	626	YT-81490	482	YT-82165	545	YT-82446	283	YT-82798	521
YT-79200	624	YT-79880	155	YT-80284	625	YT-80624	618	YT-80901	626	YT-81491	482	YT-82168	543	YT-82447	283	YT-82799	521
YT-79201	624	YT-79881	155	YT-80285	629	YT-80625	618	YT-80902	626	YT-81500	466	YT-82169	543	YT-82451	281	YT-82802	521
YT-79202	624	YT-79882	155	YT-80286	629	YT-80626	618	YT-80903	626	YT-81501	466	YT-82172	544	YT-82456	281	YT-82804	521
YT-79203	624	YT-79883	155	YT-80287	629	YT-80627	618	YT-80904	626	YT-81591	139	YT-82173	544	YT-82457	281	YT-82805	521
YT-79204	624	YT-79884	155	YT-80288	629	YT-80628	618	YT-80905	626	YT-81592	139	YT-82174	544	YT-82458	281	YT-82806	522
YT-79205	624	YT-79901	154	YT-80289	629	YT-80629	617	YT-80906	630	YT-81593	139	YT-82175	545	YT-82459	281	YT-82807	461
YT-79210	624	YT-79904	154	YT-80290	631	YT-80630	617	YT-80907	630	YT-81594	139	YT-82181	538	YT-82460	282	YT-82808	525
YT-79211	624	YT-79905	154	YT-80291	631	YT-80631	617	YT-80908	630	YT-81595	140	YT-82185	538	YT-82461	282	YT-82809	525
YT-79212	624	YT-79907	154	YT-80292	631	YT-80632	617	YT-80909	630	YT-81596	139	YT-82187	526	YT-82462	282	YT-82810	525
YT-79213	624	YT-79910	154	YT-80293	631	YT-80633	617	YT-80910	630	YT-81651	139	YT-82188	526	YT-82467	279	YT-82811	525
YT-79214	624	YT-79915	154	YT-80294	631	YT-80634	617	YT-80911	630	YT-81652	140	YT-82189	210	YT-82468	278	YT-82812	569
YT-79215	624	YT-79916	154	YT-80395	626	YT-80635	617	YT-80912	632	YT-81654	139	YT-82190	554	YT-82469	278	YT-82813	569
YT-79216	624	YT-79925	155	YT-80396	626	YT-80636	617	YT-80913	632	YT-81655	139	YT-82191	554	YT-82490	282	YT-82814	525
YT-79217	624	YT-79940	155	YT-80397	626	YT-80637	617	YT-80914	632	YT-81656	139	YT-82192	546	YT-82491	278	YT-82815	525
YT-79218	624	YT-79943	155	YT-80398	626	YT-80638	617	YT-80915	632	YT-81775	636	YT-82194	546	YT-82492	278	YT-82816	544
YT-79219	624	YT-80070	154	YT-80399	626	YT-80639	617	YT-80916	632	YT-81808	640	YT-82196	538	YT-82493	278	YT-82817	544
YT-79220	624	YT-80071	154	YT-80400	626	YT-80640	617	YT-80917	632	YT-81809	640	YT-82200	538	YT-82494	278	YT-82818	525
YT-79221	624	YT-80072	154	YT-80401	630	YT-80641	617	YT-80924	626	YT-81811	637	YT-82206	547	YT-82495	278	YT-82819	525
YT-79222	624	YT-80073	154	YT-80402	630	YT-80642	617	YT-80925	626	YT-81819	639	YT-82207	547	YT-82496	278	YT-82822	526
YT-79223	624	YT-80080	154	YT-80403	630	YT-80643	617	YT-80926	626	YT-81820	639	YT-82220	551	YT-82497	278	YT-82823	526
YT-79224	624	YT-80081	154	YT-80404	630	YT-80644	617	YT-80927	626	YT-81821	639	YT-82223	551	YT-82498	278	YT-82824	526
YT-79230	625	YT-80082	154	YT-80405	630	YT-80645	617	YT-80928	626	YT-81855	640	YT-82230	547	YT-82507	282	YT-82826	526
YT-79231	625	YT-80130	154	YT-80406	630	YT-80646	617	YT-80929	626	YT-81856	640	YT-82240	547	YT-82510	279	YT-82827	526
YT-79232	625	YT-80140	625	YT-80407	632	YT-80647	617	YT-80930	626	YT-81860	640	YT-82242	547	YT-82512	278	YT-82828	526
YT-79233	625	YT-80141	625	YT-80408	632	YT-80648	617	YT-80931	626	YT-81900	636	YT-82250	258	YT-82514	279	YT-82830	566
YT-79234	625	YT-80142	625	YT-80409	632	YT-80649	6										

YATO	page/strona	YATO	page/strona	YATO	page/strona	YATO	page/strona	YATO	page/strona	YATO	page/strona	YATO	page/strona				
YT-82903	518	YT-83228	238	YT-83457	240	YT-84956	582	YT-85341	562	YT-86804	667	YT-692501	311	YT-828463	530	YT-855481	578
YT-82904	518	YT-83229	238	YT-83458	240	YT-84959	583	YT-85343	562	YT-86805	668	YT-692603	311	YT-828464	530	YT-855482	578
YT-82905	518	YT-83230	238	YT-83460	241	YT-84960	583	YT-85349	561	YT-86808	668	YT-692612	311	YT-828465	530	YT-855483	578
YT-82909	519	YT-83231	238	YT-83461	241	YT-84961	583	YT-85350	561	YT-86809	668	YT-730893	137	YT-828498	530	YT-855484	578
YT-82910	519	YT-83232	238	YT-83462	241	YT-84962	583	YT-85363	563	YT-86840	668	YT-730933	138	YT-828499	531	YT-855487	578
YT-82912	519	YT-83233	238	YT-83463	241	YT-84963	583	YT-85364	563	YT-86880	669	YT-731251	322	YT-828500	531	YT-855488	578
YT-82920	528	YT-83235	238	YT-83464	241	YT-84970	584	YT-85370	563	YT-87650	666	YT-731252	322	YT-828501	531	YT-855490	578
YT-82922	528	YT-83236	238	YT-83465	241	YT-84971	584	YT-85371	563	YT-87725	668	YT-742411	611	YT-828502	531	YT-855491	578
YT-82924	527	YT-83237	238	YT-83466	241	YT-84975	583	YT-85372	563	YT-87730	666	YT-742421	611	YT-828503	531	YT-855492	579
YT-82925	527	YT-83238	238	YT-83467	241	YT-84976	583	YT-85395	562	YT-87731	666	YT-746391	609	YT-828504	531	YT-855493	579
YT-82933	529	YT-83239	238	YT-83471	241	YT-84977	583	YT-85401	560	YT-87732	666	YT-746402	610	YT-829021	518	YT-855494	579
YT-82940	529	YT-83260	201	YT-83472	241	YT-84978	583	YT-85402	560	YT-87740	666	YT-746403	610	YT-834581	241	YT-8277905	520
YT-82950	471	YT-83261	201	YT-83473	241	YT-84990	584	YT-85403	560	YT-87744	666	YT-746418	609	YT-834582	241	YT-8277915	521
YT-82955	526	YT-83262	201	YT-83474	241	YT-84991	584	YT-85451	557	YT-88180	662	YT-746419	609	YT-834583	241	YT-8277925	522
YT-82956	526	YT-83263	201	YT-83475	241	YT-85003	574	YT-85453	557	YT-88182	662	YT-746600	610	YT-834584	241	YT-8277935	522
YT-82961	639	YT-83264	201	YT-83476	241	YT-85010	567	YT-85460	557	YT-88183	662	YT-746621	610	YT-834585	241		
YT-82970	534	YT-83265	201	YT-83477	241	YT-85015	566	YT-85481	557	YT-88185	662	YT-746641	610	YT-834586	241		
YT-82971	534	YT-83266	201	YT-83800	241	YT-85016	566	YT-85520	575	YT-88186	662	YT-746648	610	YT-834587	241		
YT-82972	535	YT-83271	239	YT-83801	241	YT-85022	585	YT-85521	575	YT-88190	662	YT-746681	610	YT-834588	241		
YT-82976	535	YT-83272	239	YT-83802	241	YT-85025	585	YT-85525	575	YT-88191	662	YT-808701	619	YT-834589	241		
YT-82980	535	YT-83273	239	YT-83803	241	YT-85026	585	YT-85528	575	YT-88505	662	YT-808702	619	YT-834591	241		
YT-82982	535	YT-83274	239	YT-83804	241	YT-85027	585	YT-85532	575	YT-89000	562	YT-808703	619	YT-834592	241		
YT-82984	535	YT-83275	239	YT-83805	241	YT-85030	585	YT-85533	575	YT-091681	597	YT-808704	619	YT-834593	241		
YT-82985	536	YT-83276	239	YT-83806	241	YT-85031	585	YT-85537	576	YT-091691	599	YT-808705	619	YT-834594	241		
YT-82986	536	YT-83291	239	YT-83807	241	YT-85032	585	YT-85545	576	YT-091692	599	YT-808706	619	YT-834595	241		
YT-82988	536	YT-83292	239	YT-83808	241	YT-85035	585	YT-85550	576	YT-091844	599	YT-808707	619	YT-834596	241		
YT-82990	536	YT-83293	239	YT-84660	573	YT-85036	585	YT-85570	576	YT-99500	650	YT-808708	619	YT-834597	241		
YT-82992	536	YT-83294	239	YT-84670	573	YT-85037	585	YT-85580	577	YT-99501	650	YT-808709	619	YT-834598	241		
YT-82994	536	YT-83295	239	YT-84671	573	YT-85040	586	YT-85590	576	YT-99520	651	YT-818141	638	YT-834599	241		
YT-82995	536	YT-83296	239	YT-84672	573	YT-85041	586	YT-85591	577	YT-99530	651	YT-818151	638	YT-845803	240		
YT-83000	479	YT-83351	239	YT-84675	573	YT-85042	586	YT-85592	577	YT-99531	651	YT-818161	638	YT-845813	240		
YT-83001	479	YT-83352	239	YT-84770	568	YT-85051	586	YT-85600	577	YT-99532	651	YT-818171	638	YT-845823	240		
YT-83002	479	YT-83353	239	YT-84790	568	YT-085051	643	YT-085601	647	YT-99536	651	YT-818221	636	YT-845833	240		
YT-83003	479	YT-83354	239	YT-84800	566	YT-85060	586	YT-085602	647	YT-99570	651	YT-818231	636	YT-845843	240		
YT-83033	479	YT-83355	239	YT-84820	532	YT-85061	586	YT-85605	577	YT-99571	651	YT-818241	636	YT-845853	240		
YT-83037	479	YT-83356	239	YT-84840	572	YT-85062	586	YT-85606	577	YT-99650	560	YT-818251	636	YT-845863	240		
YT-83051	480	YT-83361	239	YT-84850	572	YT-85065	586	YT-85606	647	YT-99651	560	YT-818271	637	YT-846003	240		
YT-83052	480	YT-83362	239	YT-84860	576	YT-85066	586	YT-85607	647	YT-99690	558	YT-818291	637	YT-846013	240		
YT-83060	480	YT-83363	239	YT-84868	571	YT-85067	586	YT-85680	529	YT-99693	558	YT-818381	637	YT-846023	240		
YT-83061	480	YT-83364	239	YT-84870	571	YT-85075	586	YT-85700	552	YT-99695	558	YT-818391	637	YT-846033	240		
YT-83062	480	YT-83365	239	YT-84871	571	YT-085081	642	YT-85701	552	YT-99700	558	YT-821023	533	YT-846043	240		
YT-83070	482	YT-83366	239	YT-84872	571	YT-85111	579	YT-85710	552	YT-99705	558	YT-821024	533	YT-846053	240		
YT-83080	481	YT-83371	239	YT-84877	570	YT-85121	579	YT-85715	552	YT-99710	558	YT-821591	538	YT-846063	240		
YT-83081	481	YT-83372	239	YT-84893	574	YT-85135	579	YT-85716	553	YT-99720	559	YT-827788	520	YT-846113	237		
YT-83082	481	YT-83373	239	YT-84895	574	YT-85141	579	YT-85720	553	YT-99730*	559	YT-827790	520	YT-846133	237		
YT-83085	481	YT-83374	239	YT-84901	574	YT-85142	579	YT-85730	553	YT-99733*	559	YT-827791	521	YT-846153	237		
YT-83090	557	YT-83375	239	YT-84910	574	YT-85150	579	YT-85731	553	YT-99738*	560	YT-827792	522	YT-849299	580		
YT-83091	558	YT-83376	239	YT-84914	580	YT-85155	579	YT-85732	554	YT-99739*	560	YT-827793	522	YT-849301	580		
YT-83092	558	YT-83381	239	YT-84915	580	YT-85160	573	YT-85733	553	YT-99740*	559	YT-828061	522	YT-849311	581		
YT-83101	482	YT-83382	239	YT-84916	580	YT-85161	573	YT-85735	553	YT-99743*	559	YT-828071	522	YT-849329	581		
YT-83113	483	YT-83383	239	YT-84917	580	YT-85162	573	YT-85736	554	YT-99801	656	YT-828072	522	YT-849331	581		
YT-83114	483	YT-83384	239	YT-84918	580	YT-85170	556	YT-85738	554	YT-99802	656	YT-828073	523	YT-849332	581		
YT-83130	503	YT-83385	239	YT-84919	580	YT-85173	565	YT-85739	554	YT-99803	656	YT-828074	523	YT-849333	581		
YT-83140	502	YT-83386	239	YT-84921	581	YT-85175	565	YT-85740	553	YT-99804	656	YT-828075	523	YT-849351	581		
YT-83141	502	YT-83390	240	YT-84923	580	YT-85176	565	YT-85741	553	YT-99810	656	YT-828076	523	YT-849355	580		
YT-83142	502	YT-83391	240	YT-84925	580	YT-85177	565	YT-85742	554	YT-99811	656	YT-828131	569	YT-849381	580		
YT-83143	503	YT-83392	240	YT-84927	580	YT-85179	565	YT-85743	554	YT-99812	656	YT-828132	569	YT-849382	580		
YT-83144	503	YT-83393	240	YT-84928	581	YT-85180	573	YT-85744	553	YT-99813	656	YT-828133	569	YT-849383	580		
YT-83145	502	YT-83394	240	YT-84929	581	YT-85182	572	YT-85745	554	YT-99814	657	YT-828134	569	YT-849395	582		
YT-83146	502	YT-83395	240	YT-84930	580	YT-85200	571	YT-85750	554	YT-99815	657	YT-828135	569	YT-849405	582		
YT-83147	503	YT-83396	240	YT-84931	580	YT-85205	571	YT-85800	572	YT-99830	658	YT-828136	569	YT-849441	582		
YT-83148	503	YT-83397	240	YT-84933	581	YT-85208	572	YT-85803	572	YT-99831	659	YT-828137	569	YT-849449	582		
YT-83151	482	YT-83398	240	YT-84934	581	YT-85220	569	YT-85910	564	YT-99832	659	YT-828138	569	YT-849451	582		
YT-83152	482	YT-83399	240	YT-84935	580	YT-85221	569	YT-85915	564	YT-99841	658	YT-828293	526	YT-849452	582		
YT-83153	482	YT-83400	240	YT-84936	581	YT-85222	570	YT-85930	564	YT-99845	660	YT-828294	526	YT-849453	582		
YT-83160	237	YT-83401	240	YT-84937	581	YT-85223	570	YT-085941	649	YT-99848	657	YT-828295	526	YT-849470	582		
YT-83161	237	YT-83430	240	YT-84938	581	YT-85224	570	YT-085942	649	YT-99850	660	YT-828296	527	YT-849472	582		
YT-83162	237	YT-83431	240	YT-84939	582	YT-85225	570	YT-86211	565	YT-99852	660	YT-828331	567	YT-849474	582		
YT-83163	237	YT-834															



REG-707
Branded rack YATO 100 cm /
Regał firmowy YATO 100 cm



REG-777
Hangers set for power tools YATO /
Zestaw zawieszni na elektronarzędzia YATO



REG-779
Hangers set for power tools YATO 18 V /
Zestaw zawieszni na elektronarzędzia YATO 18 V



REG-918
Display for sanding paper YATO in rolls /
Ekspozytor na papier ścierny YATO w rolkach



REG-919
Display for sanding paper YATO in sheets /
Ekspozytor na papier ścierny YATO w arkuszach



REG-908
Standing display for YATO rectifiers /
Ekspozytor stojący na prostowniki YATO



REG-925
Display for YATO work clothes /
Ekspozytor na ubrania robocze YATO



REG-603
Rotary display rack YATO /
Ekspozytor obrotowy YATO



REG-776
Standing triangular display for YATO sets /
Trójstronny ekspozytor stojący na zestawy YATO



REG-763
Standing display for YATO shoes /
Ekspozytor stojący na buty YATO



REG-977
Chrome tube mannequin /
Manekin z rury chromowej

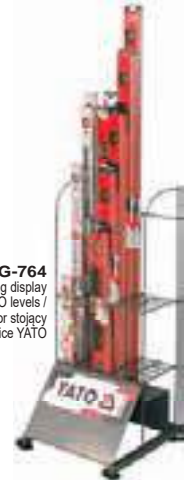

REG-764
Standing display for YATO levels /
Ekspozytor stojący na poziomice YATO



REG-708
Branded rack VOREL 100 cm /
Regał firmowy VOREL 100 cm



REG-999
Standing display for window seals VOREL /
Ekspozytor stojący na uszczelki do okien VOREL



REG-954
Display for ropes /
Ekspozytor na liny



REG-706
Branded rack STHOR 100 cm /
Regał firmowy STHOR 100 cm



REG-709
Branded rack FLO 100 cm /
Regał firmowy FLO 100 cm



REG-715
Mesh display rack FLO 230 cm /
Regał siatkowy FLO 230 cm



REG-147
Kitchen faucet display rack FALA /
Ekspozytor na baterie kuchenne FALA



REG-146
Bath faucet display rack FALA /
Ekspozytor na baterie łazienkowe FALA



REG-149
Stand for linear drains FALA /
Ekspozytor na odpływy liniowe FALA



REG-808
Display for wave toilet seats FALA /
Ekspozytor na deski toaletowe FALA



REG-992
Display rack for REG-707 for pipe wrenches YATO /
Ekspozytor do REG-707 na klucze do rur YATO



REG-994
Display rack for REG-707 for YATO bits /
Ekspozytor do REG-707 na nasadki YATO



REG-994P
Display rack with the lid for REG-707 for YATO bits /
Ekspozytor z pokrywą do REG-707 na nasadki YATO



REG-998
Display rack for REG-707 for YATO hammers /
Ekspozytor do REG-707 na młotki YATO



REG-993
Display rack for REG-707 for YATO pneumatic tools /
Ekspozytor do REG-707 na narzędzia pneumatyczne YATO



REG-951
Display for carpentry clamps /
Ekspozytor na ścisiki stolarskie



REG-804
Tag for YATO shoes / Zawieszka na buty YATO



REG-991
Display rack for REG-707 for YATO disc saws /
Ekspozytor do REG-707 na pily tarczowe YATO



REG-952
Display for the disc cutters /
Ekspozytor na tarcze do szlifierek kątowych



REG-761
Hook for axes / Wieszak na siekiery



REG-930
Display for YATO buck saws /
Ekspozytor na pily kabląkowe YATO



REG-868
Hook 30 cm for trowels / Hak 30 cm na kielnie



REG-144
Pendant for wall mounted faucet FALA /
Zawieszka na baterię ścienną FALA



REG-145
Pendant for deck mounted faucet FALA /
Zawieszka na baterię stojącą FALA



REG-909
Display stand for FLO garden tools /
Ekspozytor na narzędzia ogrodowe FLO



REG-911
Pallet display for garden tools /
Ekspozytor paletowy na narzędzia ogrodnicze



REG-799
Display stand VOREL /
Display ekspozycyjny VOREL



REG-902
Standing display for YATO sockets /
Ekspozytor stojący na nasadki YATO



REG-807
Display box for STHOR drill bits /
Ekspozytor skrzynka na wiertła STHOR



REG-604
Wall-stand display rack YATO /
Ekspozytor stojąco-wiszący YATO



REG-605
Waterfall display rack YATO /
Ekspozytor kaskadowy YATO

REG-705
Advertising wobler YATO /
Wobler reklamowy YATO

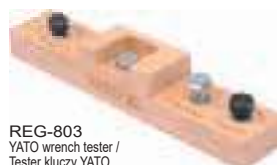

REG-803
YATO wrench tester /
Tester kluczy YATO



REG-711
Rack shelf for REG-707 YATO /
Półka do REG-707 YATO

Memo

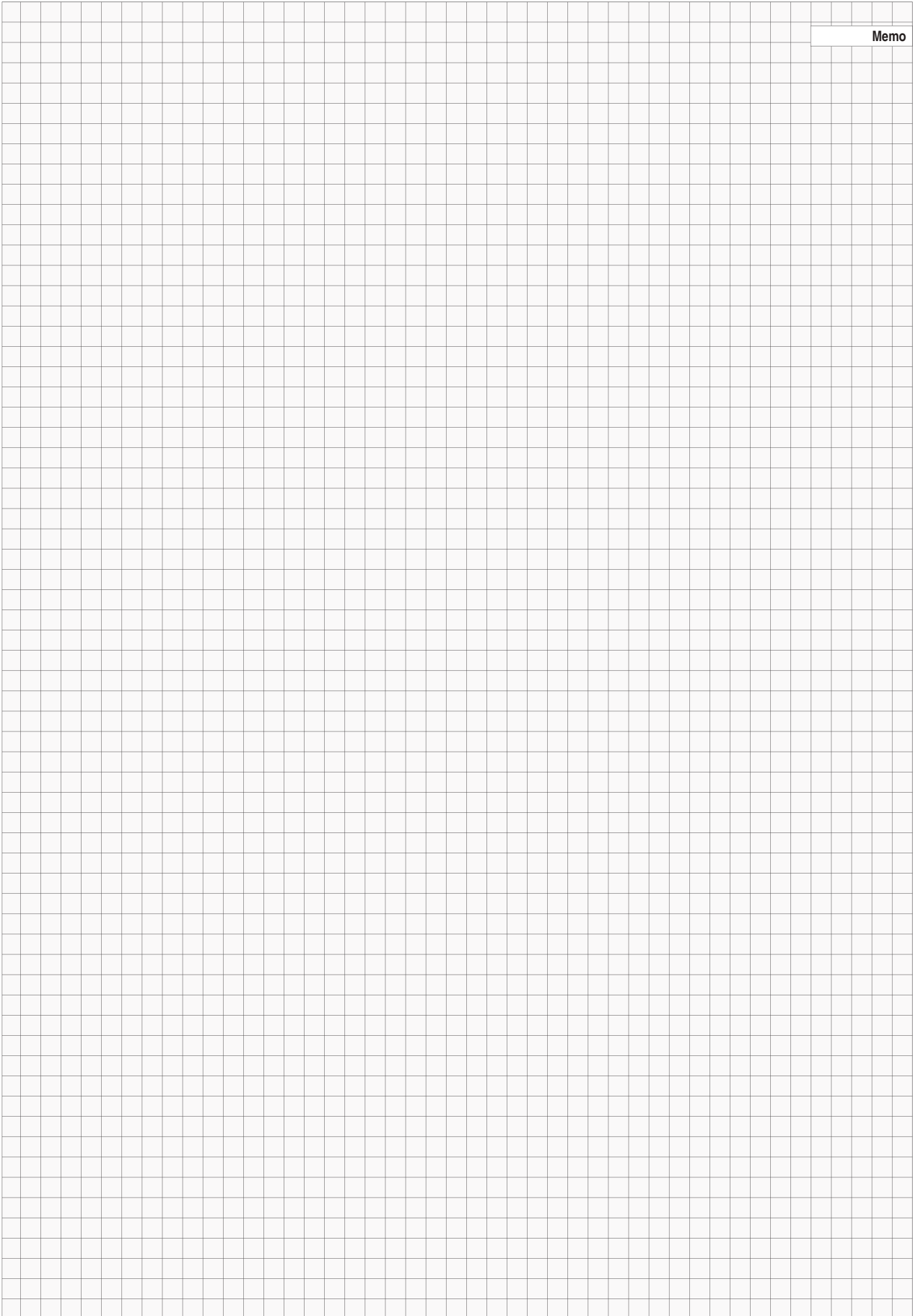

Memo



PL

I. TOYA S.A. informuje, iż: 1) niniejszy katalog nie stanowi oferty w rozumieniu prawa cywilnego; 2) prezentowane w niniejszym katalogu artykuły mogą w rzeczywistości odbiegać od wskazanego na zdjęciach wzoru, w szczególności jeżeli chodzi o cechy zewnętrzne, tj. wielkość, kolor, sposób opakowania, liczbę przedmiotów w opakowaniu; 3) nie ponosi odpowiedzialności za drobne różnice w sposobie pakowania czy właściwościach artykułów pozostających bez wpływu na jego przeznaczony cel lub sposób użytkowania; 4) nie ponosi odpowiedzialności wynikającej z jakichkolwiek niedokładności lub nieścisłości, co do informacji zawartych w przedmiotowym katalogu; 5) nie ponosi odpowiedzialności za ewentualną szkodę powstałą w wyniku otrzymania towaru o innych właściwościach niż prezentowany na zdjęciach.

II. Pomimo najlepszych starań poczynionych przez TOYA S.A. nie może ona zagwarantować, iż informacje zawarte w niniejszym katalogu w pełni odpowiadają rzeczywistości.

III. Wszelkie decyzje podjęte na podstawie informacji zawartych w przedmiotowym katalogu podejmowane są na własne ryzyko osoby, która korzysta z tych informacji.

GB

I. TOYA S.A. informs that: 1) the present catalogue does not constitute an offer as construed in the civil law; 2) the goods presented in the present catalogue may in fact differ from the models shown in the pictures, particularly as far as external properties are concerned, namely size, colour, packaging, number of items in the package; 3) the company will not be held responsible for small differences in packaging or properties of the goods, which do not affect the purpose or the exploitation of the tools; 4) the company will not be held responsible for any inaccuracies or imprecision regarding the information presented in the catalogue; 5) the company will not be held responsible for any damage caused by goods whose properties differ from those of the tools presented in the photographs.

II. In spite of all the efforts made by TOYA S.A., the company cannot guarantee the information contained in the present catalogue fully correspond to the reality.

III. Any decisions made on the basis of the information contained in the present catalogue will be made at the risk of the person who makes them using the aforementioned information.

D

I. TOYA S.A. informiert, dass: 1) der vorliegende Katalog kein Angebot im zivilrechtlichen Sinne darstellt; 2) die im vorliegenden Katalog präsentierten Artikel in der Realität von den auf den Musterfotos gezeigten abweichen können, und zwar besonders dann, wenn es um äußere Eigenschaften geht, wie z.B. Größe, Farbe, Art der Verpackung, Anzahl der Gegenstände in der Verpackung; 3) sie keine Verantwortung für geringfügige Unterschiede bei der Verpackungsart oder den Eigenschaften der Artikel übernimmt, die ohne Auswirkungen auf seinen Bestimmungszweck oder die Art der Nutzung bleiben; 4) sie keine Verantwortung für irgendwelche Oberflächlichkeiten und Ungenauigkeiten bzgl. der im Sachkatalog enthaltene Informationen übernimmt; 5) sie keine Verantwortung für eventuelle Schäden, die im Ergebnis des Erhalts der Ware mit anderen als auf den Fotos dargestellten Eigenschaften entstanden sind, übernimmt.

II. Trotz großer Bemühungen seitens TOYA S.A. kann die Firma nicht garantieren, dass die im vorliegenden Katalog enthaltene Informationen voll der Realität entsprechen.

III. Sämtliche Entscheidungen, die auf der Grundlage der im Sachkatalog enthaltene Informationen getroffen wurden, gehen auf das Risiko der Person, die diese Informationen benutzt.

RUS

I. TOYA S.A. заявляет: 1) настоящий каталог не является торговым предложением с точки зрения гражданского законодательства; 2) изделия, представленные в настоящем каталоге, могут отличаться от образцов на снимках, особенно внешним видом, то есть размером, цветом, способом упаковки, количеством предметов в упаковке; 3) производитель не отвечает за мелкие отличия в способе упаковки или свойствах изделий, которые не влияют на предназначение или способ пользования изделиями; 4) производитель не отвечает за мелкие неточности в сведениях из предметного каталога; 5) производитель не отвечает за ущерб, нанесенный вследствие поставки товара, отличающегося параметрами от указанного на снимках.

II. Несмотря на все усилия в данном направлении, компания TOYA S.A. не гарантирует, что информация, метящаяся в настоящем каталоге, полностью отвечает действительности.

III. Риск, связанный с любыми решениями, принятыми на основании информации из предметного каталога, берут на себя лица, пользующиеся указанной информацией.

CZ

I. TOYA S.A. informuje že: 1) tento katalog nepředstavuje nabídku ve smyslu občanského práva; 2) výrobky prezentované v tomto katalogu se mohou ve skutečnosti lišit od modelů uvedených na obrázcích, zejména co se týká vnějších znaků, tj. velikosti, barvy, způsobu balení, počtu předmětů v balení; 3) nenese odpovědnost za drobné rozdíly ve způsobu balení nebo ve vlastnostech výrobků, které nemají zásadní vliv na jejich určený účel nebo způsob používání; 4) nenese odpovědnost vyplývající z jakýchkoli nepřesností co do informací uvedených v předmětném katalogu; 5) nenese odpovědnost za případné škody vzniklé v důsledku obdržení zboží s jinými vlastnostmi, než je uvedeno na obrázcích.

II. Navzdory mimořádnému úsilí vynaloženému firmou TOYA S.A. tato nemůže garantovat, zda informace uvedené v tomto katalogu zcela odpovídají skutečnosti.

III. Veškerá rozhodnutí přijatá na základě informací uvedených v předmětném katalogu jsou přijímána na vlastní riziko osoby, která tyto informace využívá.

H

I. A TOYA S.A. tájékoztatja, hogy: 1) a jelen katalógus a polgári jog szerint nem kereskedelmi ajánlat; 2) a jelen katalógusban bemutatott árucikkek a valóságban eltérhetnek a képeken látható mintáktól, különösen a külső tulajdonságok, mint a méret, szín, csomagolási mód, a csomagban lévő tárgyak száma tekintetében; 3) nem vállal felelősséget a csomagolás módjában vagy az árucikkek olyan tulajdonságaiban történt változtatásokért, amelyek nem befolyásolják lényeges módon annak rendeltetését vagy a felhasználás módját; 4) nem vállal felelősséget a jelen katalógusban lévő információk pontatlanságáért; 5) nem vállal felelősséget azokért az esetleges károkért, amik az árucikkek fényképeken látható tulajdonságoktól eltérő tulajdonságokkal történő leszállításból erednek.

II. A TOYA S.A. minden igyekezete ellenére nem tudja garantálni, hogy a jelen katalógusban található információk teljes egészében megfelelnek a valóságnak.

III. A tárgyi katalógusban található információk alapján meghozott bármilyen döntés annak a személynek a rizikója, aki ezeket az információkat felhasználja.

RO

I. TOYA S.A. informează că: 1) prezentul catalog nu constituie ofertă în înțelesul dreptului civil; 2) articolele prezentate în prezentul catalog se pot diferi față de mostrele din fotografiile, în special aspectul exterior, adică mărimea, culoarea, modul de ambalare, cantitatea obiectelor în ambalaj; 3) nu-și asumă răspunderea referitor la mici diferențe la modul de ambalare sau la articolele al căror proprietăți nu au influență referitor la destinația sau modul lor de utilizare; 4) nu-și asumă răspunderea referitor la orice inexactitate sau imprecizie, datorită informațiilor cuprinse în catalogul respectiv; 5) nu-și asumă răspunderea referitor la o eventuală pagubă ca urmare a primirii marfei cu alte proprietăți decât cele prezentate pe fotografii.

II. Cu toate strădanile TOYA S.A., firma nu poate garanta că, informațiile din prezentul catalog corespund realității.

III. Orice decizie preluată în baza informațiilor cuprinse în catalogul respectiv, sunt preluate pe riscul și răspunderea persoanei care a făcut folos de aceste informații.

E

I. TOYA S.A. comunica lo siguiente: 1) el presente catálogo no constituye una oferta, en el sentido que la noción adquiere en la ley civil; 2) los artículos presentados en el presente catálogo pueden en realidad diferir de los modelos indicados en las fotografías, especialmente en cuanto a sus propiedades externas, es decir el tamaño, el color, el empaque o la cantidad de los objetos en el empaque; 3) la empresa no se hace responsable por pequeñas diferencias en cuanto al empaque o las propiedades de los artículos, siempre y cuando estas diferencias no afectan el propósito o el modo de operación de las herramientas; 4) la empresa no se hace responsable por ninguna imprecisión en cuanto a la información presentada en el presente catálogo; 5) la empresa no se hace responsable por ningún daño que surja del hecho de que los artículos recibidos difieran de los artículos presentados en las fotografías en cuanto a sus propiedades.

II. A pesar de los mejores intentos de parte TOYA S.A. la empresa no puede garantizar que la información presentada en el presente catálogo corresponda completamente a la realidad.

III. Todas las decisiones tomadas en base a la información presentada en el presente son responsabilidad de la persona que recurra a la dicha información.



www.yato.com

YATO heaters make work more comfortable by warming up the air in garages, workshops, warehouses, and production halls. They're perfect for spaces where maintaining the right temperature is crucial for production, storage, or processing. They're also great for drying and airing out rooms during renovation or construction work. Choosing the right heater depends on the size of the space, the type of fuel it uses, and how mobile you need the device to be.



YT-99700
2 kW

YT-99705
3 kW

YT-99710
5 kW

**ELECTRIC
HEATERS PTC
NAGRZEWNICE
ELEKTRYCZNE PTC**



YT-99720
3 kW

**ELECTRIC
HEATER PTC
NAGRZEWNICA
ELEKTRYCZNA PTC**



YT-99730
15 kW

YT-99733
30 kW

**GAS FIRED HEATERS
NAGRZEWNICE GAZOWE**



YT-99740
30 kW

YT-99743
50 kW

**DIRECT OIL FIRED HEATERS
NAGRZEWNICE OLEJOWE**

więcej na stronach:
more on pages:
558-560

HEATERS AND DEHUMIDIFIERS - NAGRZEWNICE I OSUSZACZE



www.yato.com

Nagrzewnice YATO podnoszą komfort pracy ogrzewając powietrze w garażach, warsztatach, magazynach i halach produkcyjnych. Znajdą zastosowanie w obiektach, gdzie konieczne jest utrzymanie odpowiednich warunków temperaturowych do produkcji, składowania lub przetwarzania produktów. Dobrze sprawdzą się podczas suszenia i przewietrzania pomieszczeń w trakcie prac remontowo-budowlanych. Wybór nagrzewnicy zależy od wielkości pomieszczenia, paliwa zasilającego i oczekiwań wobec mobilności urządzenia.



YT-99690
2 kW

YT-99693
3 kW

**ELECTRIC
HEATERS PTC
NAGRZEWNICE
ELEKTRYCZNE PTC**



YT-99738
20 kW

YT-99739
30 kW

**DIRECT OIL
FIRED HEATERS
NAGRZEWNICE
OLEJOWE**



YT-99695
5 kW

**ELECTRIC
HEATER PTC
NAGRZEWNICA
ELEKTRYCZNA PTC**



YT-99650 DEHUMIDIFIER
900 W OSUSZACZ



YT-99651 DEHUMIDIFIER
1350 W OSUSZACZ

więcej na stronach:
more on pages:
558-560



MANUFACTURER / PRODUCENT

TOYA S.A.
ul. Sołtysowicka 13-15
51-168 Wrocław
Poland
☎ (+48 71) 32 46 200
fax: (+48 71) 32 46 370
sales@yato.pl (domestic)
export@yato.pl (export)
import@yato.pl (import)

ODDZIAŁ WARSZAWSKI
Teren Mapletree Park Nadarzyn
al. Kasztanowa 160
05-831 Młochów k. Warszawy
Poland
☎ (+48 22) 73 82 800
☎ (+48 22) 73 82 828
sales@yato.pl (domestic)
export@yato.pl (export)

TOYA ROMANIA S.A.
Șos. Ștefănești, 8-3A
Ștefăneștii De Jos, Ilfov
România
☎ (+40 031) 710 8692
office@yato.ro

YATO TOOLS (SHANGHAI) CO., LTD.
No. 1, Lane 1300,
East Kangqiao Road
Shanghai, China 201315
☎ (+86 21) 681 829 50
fax: (+86 21) 681 829 51
yato@yato-sh.com

YATO TOOLS (JIAXING) CO., LTD.
No.1033 Huyan Road,
Baibu Town, Haiyan County,
Jiaxing City, Zhejiang Province, China
☎ (+86 21) 681 829 50
yato@yato-sh.com

YOUR TRUSTED SUPPLIER: / TWÓJ ZAUFANY DOSTAWCA:



www.yato.com

GET ACQUAINTED WITH OUR WIDE OFFER:
ZOBACZ NASZĄ BOGATĄ OFERTĘ:

