





68206



68207



68208



68209

The stylish color and eye-catching design of LUND kettles will enhance the appeal of your kitchen. With high power, they boil water very quickly, even at full capacity. The double stainless steel walls

ensure the kettle's surface remains cool to the touch, even when the water inside reaches 100°C.

Explore all the features of LUND kettles and choose the best model for yourself.

Modny kolor i przyciągający oko design czajników LUND podkreślą atrakcyjność Twojej kuchni. Dzięki dużej mocy bardzo szybko zagotują wodę, także przy pełnej pojemności. Podwójne ścianki ze stali nierdzewnej powodują,

że powierzchnie czajników są zimne w dotyku, nawet gdy w środku jest woda o temperaturze 100°C.

Zobacz wszystkie funkcje czajników LUND i wybierz najlepszy model dla siebie.

1 **Spanners** 6-13
Klucze



2 **Sockets, accessories & sets** 14-23
Klucze nasadowe, akcesoria i zestawy



3 **Screwdrivers & screwdriver bits** 24-41
Wkrętaki i końcówki wkrętakowe



4 **Pliers** 42-49
Szczypce



5 **Electrician tools** 50-55
Narzędzia dla elektryków



6 **Hammers, chisels, punches & axes** 56-67
Młotki, dłuta, przecinaki i siekiery



7 **Clamps & vices** 68-73
Ściski i imadła



8 Cutting tools 74-117

Narzędzia tnące



9 Plumbing tools 118-127

Narzędzia hydrauliczne



10 Fastening tools 128-143

Narzędzia do łączenia

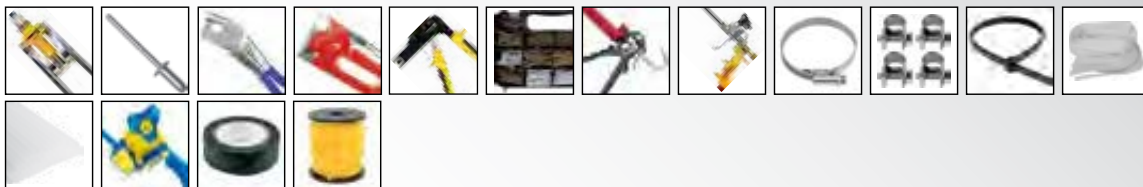

11 Plastering & bricklaying tools 144-187

Narzędzia budowlane i malarskie



12 Measuring tools 188-203

Narzędzia miernicze

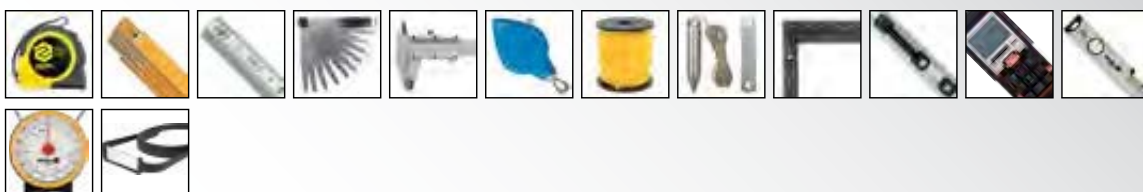

13 Pneumatic tools 204-213

Narzędzia pneumatyczne



14 Special automotive tools & equipment 214-245

Narzędzia i wyposażenie warsztatu samochodowego



15 Power tools & accessories 246-275

Elektronarzędzia i akcesoria

STWOR **LUND** **FLO**



16 Welding equipment 276-281

Sprzęt spawalniczy



17 Safes, padlocks & locks 282-289

Sejfy, kłódki i zamki



18 Accessories 290-295

Akcesoria



19 Bicycle accessories 296-301

Akcesoria rowerowe



20 Kitchen and home appliance 302-333

Sprzęt AGD



21 Household equipment 334-359

Gospodarstwo domowe



22 Health & safety products Artykuły BHP

360-373



23 Electric products Artykuły elektryczne

374-387



24 Garden tools & power tools Narzędzia i elektronarzędzia ogrodowe

388-457



25 Sanitary ware & hydraulics Armatura sanitarna i hydraulika

458-491



Memo

1

Spanners Klucze



Combination spanners Klucze płasko-oczkowe



8-10

Combination spanners & sets, polished head
Klucze płasko-oczkowe i zestawy,
polerowana główka.....

8

Combination spanners & sets, satin finish CrV
Klucze płasko-oczkowe i zestawy,
wykończenie satynowe CrV.....

9

Combination ratchet wrenches Klucze płasko-oczkowe z grzechotką



10

Combination ratchet wrenches
Klucze płasko-oczkowe z grzechotką.....

10

Combination ratchet wrench sets
Zestawy kluczy płasko-oczkowych z grzechotką.....

10

Double open end spanners Klucze płaskie



10-11

Double open end spanners & sets, polished head
Klucze płaskie i zestawy, polerowana główka.....

10

Double open end spanner sets, satin finish CrV
Zestawy kluczy płaskich,
wykończenie satynowe CrV.....

11

Bi-hexagonal ring spanners Klucze oczkowe odgięte



11

Bi-hexagonal ring spanner sets, polished head
Zestawy kluczy oczkowych odgiętych, polerowana główka.....

11

Open end swivel socket spanners Klucze płasko-nasadowe



11

T-type deep socket wrenches Klucze nasadowe typu „T”



11

Box end wrenches Klucze rurowe



11

L-type wrenches Klucze nasadowe typu „L”



12

Multipipe wrenches Klucze uniwersalne



12

Double ratchet wrenches Klucze nasadkowe z grzechotką



12

Adjustable wrenches Klucze nastawne



12-13

Torque wrenches Klucze dynamometryczne



13

1

- EN Combination spanner
- PL Klucz płasko-oczkowy
- DE Ringmaulschlüssel
- RU Ключ комбинированный
- CZ Klíč očkoplochy
- RO Cheie combinată
- HU Csillag-villás kulcs
- ES Llave combinada



No.	Size / Rozmiar [mm]	
51060	6	200/1200
51070	7	200/1000
51080	8	60/600
51090	9	60/600
51100	10	50/600
51110	11	50/400
51120	12	50/400
51130	13	50/400
51140	14	50/300
51150	15	50/300
51160	16	50/200
51170	17	20/200
51180	18	25/200
51190	19	30/120
51200	20	20/160
51210	21	20/120
51220	22	30/120
51240	24	15/90
51270	27	15/60
51300	30	10/40
51320	32	10/40

- EN Combination spanner set
- PL Zestaw kluczy płasko-oczkowych
- DE Maul-Ringschlüssel-Satz
- RU Набор комбинированных ключей
- CZ Sada očkoplochyh klíčů
- RO Set chei combinate
- HU Csillag-villáskulcs készlet
- ES Juego de llaves combinadas



No.	Size / Rozmiar [mm]	pcs / szt.	
51580	6, 8, 10, 11, 13, 14, 17, 19	8	5/50
51620	6, 7, 8, 9, 10, 11, 12, 13, 14, 17, 19, 22	12	5/20
51650	6, 7, 8, 9, 10, 11, 12, 13, 14, 15, 16, 17, 18, 19, 20, 21, 22, 23, 24, 25, 26, 27, 28, 30, 32	25	1/4

- EN Combination spanner
- PL Klucz płasko-oczkowy
- DE Ringmaulschlüssel
- RU Ключ комбинированный
- CZ Klíč očkoplochy
- RO Cheie combinată
- HU Csillag-villás kulcs
- ES Llave combinada



STHOR

No.	Size / Rozmiar [mm]	
51040	6	200/1200
51042	8	100/600
51044	10	50/600
51046	12	50/400
51047	13	50/400
51048	14	50/300
51049	15	50/300
51051	17	20/200

- EN Combination spanner set
- PL Zestaw kluczy płasko-oczkowych
- DE Maul-Ringschlüssel-Satz
- RU Набор комбинированных ключей
- CZ Sada očkoplochyh klíčů
- RO Set chei combinate
- HU Csillag-villáskulcs készlet
- ES Juego de llaves combinadas



No.	Size / Rozmiar [mm]	pcs / szt.	
51560	8, 10, 12, 13, 14, 17	6	15/60
51590	6, 8, 10, 12, 13, 14, 17, 19	8	10/40
51630	6, 7, 8, 9, 10, 11, 12, 13, 14, 17, 19, 22	12	5/20
51640	6, 7, 8, 9, 10, 11, 12, 13, 14, 17, 19, 21, 24, 27, 32	15	2/12
51645	6, 7, 8, 9, 10, 11, 12, 13, 14, 15, 16, 17, 18, 19, 21, 22, 24, 27, 30, 32	20	2/8

- EN Combination spanner set
- PL Zestaw kluczy płasko-oczkowych
- DE Maul-Ringschlüssel-Satz
- RU Набор комбинированных ключей
- CZ Sada očkoplochyh klíčů
- RO Set chei combinate
- HU Csillag-villáskulcs készlet
- ES Juego de llaves combinadas



VOREL

No.	Size / Rozmiar [mm]	pcs / szt.	
50850	8, 10, 12, 13, 14, 17	6	4/40
50861	6, 8, 10, 13, 14, 17, 19, 22	8	4/32
50871	6, 7, 8, 9, 10, 11, 12, 13, 14, 17, 19, 22	12	2/20

EN Combination spanner set
 PL Zestaw kluczy płasko-oczkowych
 DE Maul-Ringschlüssel-Satz
 RU Набор комбинированных ключей

CZ Sada očkoplochých klíčů
 RO Set chei combinate
 HU Csillag-villáskulcs készlet
 ES Juego de llaves combinadas



No.	Size / Rozmiar	pcs / szt.	
50880	1/4" (6.3 mm), 5/16" (7.9 mm), 3/8" (9.5 mm), 7/16" (11.1 mm), 1/2" (12.7 mm), 9/16" (14.3 mm), 5/8" (15.9 mm), 1/16" (17.5 mm), 3/4" (19.0 mm)	9	10

EN Combination spanner set
 PL Zestaw kluczy płasko-oczkowych
 DE Maul-Ringschlüssel-Satz
 RU Набор комбинированных ключей

CZ Sada očkoplochých klíčů
 RO Set chei combinate
 HU Csillag-villáskulcs készlet
 ES Juego de llaves combinadas



No.	Size / Rozmiar [mm]	pcs / szt.	
51720	8, 10, 12, 13, 14, 17	6	4/40
51721	6, 8, 10, 12, 13, 14, 17, 19	8	4/32
51722	6, 7, 8, 9, 10, 11, 12, 13, 14, 17, 19, 22	12	2/20

EN Combination spanner set
 PL Zestaw kluczy płasko-oczkowych
 DE Maul-Ringschlüssel-Satz
 RU Набор комбинированных ключей

CZ Sada očkoplochých klíčů
 RO Set chei combinate
 HU Csillag-villáskulcs készlet
 ES Juego de llaves combinadas



No.	Size / Rozmiar [mm]	pcs / szt.	
51705	8, 10, 12, 13, 14, 15, 17, 19	8	30

EN Combination spanner
 PL Klucz płasko-oczkowy
 DE Ringmaulschlüssel
 RU Ключ комбинированный
 CZ Klíč očkoplochy
 RO Cheie combinată
 HU Csillag-villás kulcs
 ES Llave combinada



1



No.	Size / Rozmiar [mm]	
51671	6	20/400
51672	7	20/400
51673	8	20/400
51674	9	20/400
51675	10	20/320
51676	11	20/240
51677	12	20/240
51678	13	20/200
51679	14	20/200
51680	15	20/200
51681	16	20/200
51682	17	20/160
51683	18	20/160
51684	19	20/160
51685	20	20/120
51686	21	20/120
51687	22	20/120
51688	23	10/80
51689	24	10/80
51690	25	10/60
51691	26	10/40
51692	27	10/40
51693	28	10/40
51694	29	10/40
51695	30	10/40
51696	32	10/40

EN Combination spanner set
 PL Zestaw kluczy płasko-oczkowych
 DE Maul-Ringschlüssel-Satz
 RU Набор комбинированных ключей

CZ Sada očkoplochých klíčů
 RO Set chei combinate
 HU Csillag-villáskulcs készlet
 ES Juego de llaves combinadas



No.	Size / Rozmiar [mm]	pcs / szt.	
51710	6, 8, 10, 11, 12, 13, 14, 15, 17, 18, 19, 22	12	20

1

- EN Combination spanner set
- PL Zestaw kluczy plasko-oczkowych
- DE Maul-Ringschlüssel-Satz
- RU Набор комбинированных ключей
- CZ Sada očkoplochých klíčů
- RO Set chei combinate
- HU Csillag-villáskulcs készlet
- ES Juego de llaves combinadas

25 PCS CrV



No.	Size / Rozmiar [mm]	pcs / szt.	
51715	6, 7, 8, 9, 10, 11, 12, 13, 14, 15, 16, 17, 18, 19, 20, 21, 22, 23, 24, 25, 26, 27, 28, 30, 32	25	4

- EN Combination ratchet wrench set
- PL Zestaw kluczy plasko-oczkowych z grzechotką
- DE Ratschen-Ringmaulschlüssel-Satz
- RU Набор комбинированных ключей с трещоткой
- CZ Sada očkoplochých ráčnových klíčů
- RO Set chei combinate cu clichet
- HU Racsnis csillag-villás kulcs készlet
- ES Juego de llaves combinadas con carraca

4 PCS 72T 60Si2Mn CrV



No.	Size / Rozmiar [mm]	pcs / szt.	
52661	10, 13, 17, 19	4	10/20

- EN Double open end spanner set
- PL Zestaw kluczy plaskich
- DE Doppelmaulschlüsselsatz
- RU Набор рожковых ключей
- CZ Sada plochých klíčů
- RO Set chei fixe
- HU Villás kulcskészlet
- ES Juego de llaves fijas



No.	Size / Rozmiar [mm]	pcs / szt.	
50560	6x7, 8x9, 10x11, 12x13, 14x15, 16x17	6	20/80
50590	6x7, 8x9, 10x11, 12x13, 14x15, 16x17, 18x19, 20x22	8	10/40
50610	6x7, 8x9, 10x11, 12x13, 14x15, 16x17, 18x19, 20x22, 24x27, 30x32	10	5/20
50630	6x7, 8x9, 10x11, 12x13, 14x15, 16x17, 18x19, 20x22, 21x23, 24x26, 25x28, 27x32	12	5/15

- EN Combination ratchet wrench
- PL Klucz plasko-oczkowy z grzechotką
- DE Ratschen-Ringmaulschlüssel
- RU Ключ комбинированный с трещоткой
- CZ Klíč očkoplochý ráčnový
- RO Cheie combinată cu clichet
- HU Csillag-villás kulcs racsnis
- ES Llave combinada con carraca

72T 60Si2Mn CrV



No.	Size / Rozmiar [mm]	
52652	10	10/100
52653	11	10/100
52654	12	10/100
52655	13	10/100
52656	14	10/100
52657	15	10/100
52658	17	10/50
52659	19	10/50
52660	22	10/40

- EN Double open end spanner
- PL Klucz plaski
- DE Doppelmaulschlüssel
- RU Ключ рожковый
- CZ Plochý klíč
- RO Cheie fixă
- HU Villáskulcs
- ES Llave fija



No.	Size / Rozmiar [mm]	
50070	6x7	100/1000
50090	8x9	60/600
50100	8x10	60/600
50110	10x11	60/600
50120	10x13	50/500
50130	12x13	50/500
50150	14x15	50/300
50170	13x17	50/300
50190	17x19	30/180
50220	17x22	30/180
50270	24x27	25/100
50330	30x32	15/60

- EN Double open end spanner set
- PL Zestaw kluczy plaskich
- DE Doppelmaulschlüsselsatz
- RU Набор рожковых ключей
- CZ Sada plochých klíčů
- RO Set chei fixe
- HU Villás kulcskészlet
- ES Juego de llaves fijas



No.	Size / Rozmiar [mm]	pcs / szt.	
50580	6x7, 8x9, 10x11, 12x13, 14x15, 16x17, 18x19, 20x22	8	10/40

EN Double open end spanner set
 PL Zestaw kluczy płaskich
 DE Doppelmaulschlüsselsatz
 RU Набор рожковых ключей
 CZ Souprava plochých klíčů
 RO Set chei fixe
 HU Villás kulcskészlet
 ES Juego de llaves fijas



VOREL

No.	Size / Rozmiar [mm]	pcs / szt.	
51740	6x7, 8x9, 10x11, 12x13, 14x15, 16x17	6	4/40
51741	6x7, 8x9, 10x11, 12x13, 14x15, 16x17, 18x19, 20x22	8	4/24

EN Bi-hexagonal ring spanner set
 PL Zestaw kluczy oczkowych odgiętych
 DE Doppelringschlüsselsatz
 RU Набор ключей накидных изогнутых
 CZ Sada vyhnutých očkových klíčů
 RO Set chei inelare cu cot
 HU Hajlított csillagkulcs készlet
 ES Juego de llaves de estrella acodadas



No.	Size / Rozmiar [mm]	pcs / szt.	
52580	6x7, 8x9, 10x11, 12x13, 14x15, 16x17, 18x19, 20x22	8	5/20

EN Socket wrench
 PL Klucz nasadowy
 DE Steckschlüssel
 RU Ключ торцевой
 CZ Nastrčný kľúč
 RO Cheie tubulară
 HU Nyeles dugkulcs
 ES Llaves tubular



VOREL

No.	Socket size / Rozmiar nasadki [mm]	L [mm]	
56770	8	190	50
56710	8	380	50
56780	10	190	50
56720	10	380	50
56790	13	190	50
56730	13	380	50

EN Bi-hexagonal ring spanner set
 PL Zestaw kluczy oczkowych odgiętych
 DE Doppelringschlüsselsatz
 RU Набор ключей накидных изогнутых

CZ Sada vyhnutých očkových klíčů
 RO Set chei inelare cu cot
 HU Hajlított csillagkulcs készlet
 ES Juego de llaves de estrella acodadas



1



No.	Size / Rozmiar [mm]	pcs / szt.	
52630	6x7, 8x9, 10x11, 12x13, 14x15, 16x17, 18x19, 20x21, 22x23, 24x25, 26x27, 28x32	12	2/8

EN Open end swivel head socket wrench
 PL Klucz płasko-nasadowy, przegubowy
 DE Maul-Steckschlüssel
 RU Ключ рожково-торцевой с шарниром

CZ Kľuč nasad. ploch.
 RO Cheie combinată fixă-tubulară cu articulație
 HU Kulcs villás-dugó
 ES Combinada con vaso



No.	Size / Rozmiar [mm]	
52680	8	20/200
52700	10	20/200
52730	13	20/200
52740	14	20/200
52750	15	25/100
52770	17	25/100
52790	19	25/50
52820	22	25/50

EN Tubular socket wrench set
 PL Zestaw kluczy rurowych
 DE Rohrsteckschlüsselsatz
 RU Набор ключей трубчатых
 CZ Kľúče trubkové
 RO Chei pt. țevi
 HU Csőkulcs
 ES Llaves de tubería

10
PCS



No.	Size / Rozmiar [mm]	pcs / szt.	
52900	6x7, 8x9, 10x11, 12x13, 14x15, 16x17, 18x19, 20x22	10	6/24

1

EN Socket wrench
 PL Klucz nasadowy
 DE Steckschlüssel
 RU Ключ торцевой

CZ Nastrčný klíč
 RO Cheie tubulară
 HU Nyeles dugókulcs
 ES Llave tubular



No.	Size / Rozmiar [mm]	
54600	6	80/320
54610	7	80/320
54620	8	50/200
54630	9	40/160
54640	10	40/160
54650	11	25/100
54660	12	25/100
54670	13	25/100
54680	14	20/80
54690	15	20/80
54700	16	12/48
54710	17	12/48
54720	18	10/40
54730	19	10/40
54750	21	6/24
54760	22	6/24
54780	24	6/24

EN Adjustable wrench
 PL Klucz nastawny
 DE Rollgabelschlüssel
 RU Ключ разводной

CZ Nastavitelný klíč
 RO Cheie reglabilă
 HU Állítható villáskulcs
 ES Llave ajustable



VOREL

No.	L [mm]	
54061	200	6/60
54062	250	6/36
54063	300	6/24

EN Multipipe wrenches
 PL Klucze uniwersalne
 DE Universalschlüssel
 RU Ключи универсальные
 CZ Univerzální klíče
 RO Chei universale
 HU Univerzális kulcs
 ES Juego de llaves universales



VOREL

No.	Size [mm]	pcs / szt.	
54000	9-22, 23-32	2	20/40

EN Double ratchet wrench
 PL Klucz nasadowy z grzechotką
 DE Gerüstratsche
 RU Ключ торцевой с трещоткой
 CZ Ráčnový klíč průchozí dvoustranný
 RO Cheie tubulară dubla cu cichet
 HU Kettős racsnis kulcs
 ES Llave de vaso con carraca



32T



VOREL

No.	Size / Rozmiar [mm]	
52935	17x19	2/40
52936	19x22	2/40

EN Adjustable wrench
 PL Klucz nastawny
 DE Rollgabelschlüssel
 RU Ключ разводной

CZ Nastavitelný klíč
 RO Cheie reglabilă
 HU Állítható villáskulcs
 ES Llave ajustable



VOREL

No.	L [mm]	Package	
54065	150		6/120
54066	200		6/60
54067	250		6/36
54068	300		6/24
54080	375		2/12
54081	450		2/6

EN Adjustable wrench
 PL Klucz nastawny
 DE Rollgabelschlüssel
 RU Ключ разводной

CZ Nastavitelný klíč
 RO Cheie reglabilă
 HU Állítható villáskulcs
 ES Llave ajustable



VOREL

No.	L [mm]	
54070	150	6/120
54071	200	6/60
54072	250	6/36
54073	300	6/24

EN Beam torque wrench
 PL Klucz dynamometryczny wychylny
 DE Beam-Typ-Drehmomentschlüssel
 RU Ключ динамометрический стрелочный
 CZ Dynamometrický klíč
 RO Cheie dinamometrică
 HU Nyomatékkulcs
 ES Llave dinamométrica de aguja

1/2" 0-300 CrV 6140



VOREL

No.	Ø	
57451	1/2" (12.7 mm)	16

EN Beam torque wrench
 PL Klucz dynamometryczny wychylny
 DE Beam-Typ-Drehmomentschlüssel
 RU Ключ динамометрический стрелочный
 CZ Dynamometrický klíč
 RO Cheie dinamometrică
 HU Nyomatékkulcs
 ES Llave dinamométrica de aguja

1/2" 0-200 Nm



1



VOREL

No.	Ø	
57450	1/2" (12.7 mm)	6/24

EN Torque wrench
 PL Klucz dynamometryczny
 DE Drehmomentschlüssel
 RU Ключ динамометрический
 CZ Dynamometrický klíč
 RO Cheie dinamometrică
 HU Nyomatékkulcs
 ES Llave dinamométrica



VOREL

No.	Ø	L [mm]	Torque / Moment obrotowy [Nm]	Package	
57300	3/8" (9.5 mm)	270	13.6-108		20
57350	1/2" (12.7 mm)	465	28.0-210		10
57400	3/4" (19.0 mm)	625	68-406		10

Memo

2

Sockets, accessories & sets Klucze nasadowe, akcesoria i zestawy



Sockets Klucze nasadowe



16

Hexagonal sockets 1/2"

Klucze nasadowe sześciokątne 1/2"..... 16

Hexagonal sockets 3/4"

Klucze nasadowe sześciokątne 3/4"..... 16

Universal wrench sockets

Nasadki uniwersalne..... 16

Accessories Akcesoria



16-17

Extension bars

Przedłużki..... 16

Universal joints

Przeguby Cardana..... 16

Sliding T-bars

Pokręta typu „T”..... 17

Speed braces

Rękojeści wygięte..... 17

Ratchet handles Grzechotki



17-18

Socket & tool sets Zestawy kluczy nasadowych i narzędziowych



18-23

Socket sets 1/4"

Zestawy kluczy nasadowych 1/4"..... 18

Socket sets 3/8"

Zestawy kluczy nasadowych 3/8"..... 18

Socket sets 1/2"

Zestawy kluczy nasadowych 1/2"..... 18

Socket sets 3/4"

Zestawy kluczy nasadowych 3/4"..... 19

Tool sets

Zestawy narzędziowe..... 19

2

EN Hexagonal socket
 PL Nasadka sześciokątna
 DE Sechskantenschlüssel
 RU Торцевая головка 6-гранная

CZ Šestihřanný nástavec
 RO Cheie tubulară hexagonală
 HU Hatszögű rátét
 ES Boquilla hexagonal corta

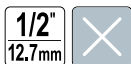

No.	Socket size / Rozmiar nasadki [mm]	Ø	
53100	10	1/2" (12.7 mm)	150/300
53120	12	1/2" (12.7 mm)	150/300
53130	13	1/2" (12.7 mm)	150/300
53140	14	1/2" (12.7 mm)	150/300
53150	15	1/2" (12.7 mm)	150/300
53170	17	1/2" (12.7 mm)	125/250
53180	18	1/2" (12.7 mm)	100/200
53190	19	1/2" (12.7 mm)	100/200
53220	22	1/2" (12.7 mm)	75/150
53240	24	1/2" (12.7 mm)	50/100

EN Universal wrench socket
 PL Nasadka uniwersalna
 DE Universal Steckschlüssel
 RU Головка универсальная



No.	Socket size / Rozmiar nasadki [mm]	Ø	
53002	7-19	3/8" (9.5 mm)	8/48
53003	11-32	1/2" (12.7 mm)	6/24

EN Extension bar
 PL Przedłużka
 DE Verlängerung
 RU Удлинитель для воротка



No.	Ø	L [mm]	
53610	1/2" (12.7 mm)	125	50/100
53630	1/2" (12.7 mm)	250	25/50

EN Extension bar
 PL Przedłużka
 DE Verlängerung
 RU Удлинитель для воротка



No.	Ø	L [mm]	
53650	3/4" (19.0 mm)	100	60
53670	3/4" (19.0 mm)	200	25

EN Hexagonal socket
 PL Nasadka sześciokątna
 DE Sechskantenschlüssel
 RU Торцевая головка 6-гранная

CZ Šestihřanný nástavec
 RO Cheie tubulară hexagonală
 HU Hatszögű rátét
 ES Boquilla hexagonal corta

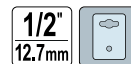

No.	Socket size / Rozmiar nasadki [mm]	Ø	
53332	10	1/2" (12.7 mm)	10/300
53335	13	1/2" (12.7 mm)	10/300
53336	14	1/2" (12.7 mm)	5/300
53337	15	1/2" (12.7 mm)	5/300
53338	16	1/2" (12.7 mm)	5/300
53339	17	1/2" (12.7 mm)	10/250
53340	18	1/2" (12.7 mm)	10/200
53341	19	1/2" (12.7 mm)	10/200

EN Hexagonal socket
 PL Nasadka sześciokątna
 DE Sechskantenschlüssel
 RU Торцевая головка 6-гранная

CZ Šestihřanný nástavec
 RO Cheie tubulară hexagonală
 HU Hatszögű rátét
 ES Boquilla hexagonal corta



No.	Socket size / Rozmiar nasadki [mm]	Ø	
53400	22	3/4" (19.0 mm)	50
53410	24	3/4" (19.0 mm)	50
53420	27	3/4" (19.0 mm)	50
53430	30	3/4" (19.0 mm)	50
53440	32	3/4" (19.0 mm)	50
53450	36	3/4" (19.0 mm)	50
53460	38	3/4" (19.0 mm)	40
53470	41	3/4" (19.0 mm)	25
53480	46	3/4" (19.0 mm)	20
53490	50	3/4" (19.0 mm)	20

EN Universal joint
 PL Przegub Cardana
 DE Kardangelenk
 RU Карданный шарнир
 CZ Kardanový kloub
 RO Articulație Cardanică
 HU Kardán csukló
 ES Articulación Cardan



No.	Ø	
53600	1/2" (12.7 mm)	50/100

EN Sliding T-bar
PL Pokrętko typu „T”
DE Handgriff mit Gleitstück
RU Вороток Т-образный

CZ Otočná račká typ „T”
RO Antrenor culisabil tip „T”
HU „T” alakú hajtókar
ES Mango tipo „T”



No.	Ø	L [mm]	
53700	1/2" (12.7 mm)	250	25/50

EN Speed brace
PL Rękojeść wygięta
DE Kurbelverlängerung
RU Вороток-коловорот

CZ Ohnutá rukojeť
RO Antrenor curbă (manivelă)
HU Hajlított markolat
ES Mango encorvado

400
mm



No.	Ø	L [mm]	
53730	1/2" (12.7 mm)	400	40

EN Ratchet handle
PL Grzechotka
DE Hebelumschaltknarre
RU Трещотка

CZ Ráčna
RO Antrenor cu clichet
HU Racsnis hajtókar
ES Llave de carraca



VOREL

No.	Ø	L [mm]	
53561	1/4" (6.3 mm)	135	40/80
53563	1/2" (12.7 mm)	240	20/40

EN Ratchet handle
PL Grzechotka
DE Hebelumschaltknarre
RU Трещотка

CZ Ráčna
RO Antrenor cu clichet
HU Racsnis hajtókar
ES Llave de carraca

VOREL

No.	Ø	L [mm]	Number of teeth / Liczba zębów	
53571	1/4" (6.3 mm)	150	72	6/36
53572	3/8" (9.5 mm)	200	72	6/36
53573	1/2" (12.7 mm)	260	72	6/36

EN Sliding T-bar
PL Pokrętko typu „T”
DE Handgriff mit Gleitstück
RU Вороток Т-образный

CZ Otočná račká typ „T”
RO Antrenor culisabil tip „T”
HU „T” alakú hajtókar
ES Mango tipo „T”



VOREL

No.	Ø	L [mm]	
53710	3/4" (19.0 mm)	450	20

EN Ratchet handle
PL Grzechotka
DE Hebelumschaltknarre
RU Трещотка

CZ Ráčna
RO Antrenor cu clichet
HU Racsnis hajtókar
ES Llave de carraca



No.	Ø	
53500	1/4" (6.3 mm)	40/80
53520	3/8" (9.5 mm)	25/50
53540	1/2" (12.7 mm)	20/40

EN Flexible ratchet handle
PL Grzechotka z przegubem
DE Gelenk-Hebelumschaltknarre
RU Трещотка шарнирная

CZ Kloubová ráčna
RO Antrenor cu clichet flexibil
HU Csuklós racsni
ES Llave de carraca articulada

1/2"
12.7mm



No.	Ø	L [mm]	
53560	1/2" (12.7 mm)	250	25/50

CrV



EN Ratchet handle
 PL Grzechotka
 DE Hebelumschaltknarre
 RU Трещотка

CZ Ráčna
 RO Antrenor cu clichet
 HU Racsnis hajtókar
 ES Llave de carraca



2



No.	Ø	L [mm]	Number of teeth / Liczba zębów	
53575	1/4" (6.3 mm)	155	72	12/72
53576	3/8" (9.5 mm)	200	72	6/48
53577	1/2" (12.7 mm)	250	72	6/36

EN Socket set and accessories
 PL Zestaw nasadek z akcesoriami
 DE Steckschlüsselsatz mit Zubehör
 RU Набор головок с принадлежностями

CZ Sada nástavců s příslušenstvím
 RO Trusă tubulare cu accesorii
 HU Dugókulcs készlet tartozékokkal
 ES Juego de vasos y accesorios



1/4" (6.3 mm): 4, 4.5, 5, 5.5, 6, 6.5, 7, 8, 9, 10, 11, 12, 13 mm;
 1/4" (6.3 mm) x 50 mm;
 1/4" (6.3 mm) x 120 mm;
 1/4" (6.3 mm)

No.	Ø	pcs / szt.	
58160	1/4" (6.3 mm)	16	20

EN Socket set and accessories
 PL Zestaw nasadek z akcesoriami
 DE Steckschlüsselsatz mit Zubehör
 RU Набор головок с принадлежностями

CZ Sada nástavců s příslušenstvím
 RO Trusă tubulare cu accesorii
 HU Dugókulcs készlet tartozékokkal
 ES Juego de vasos y accesorios



1/2" (12.7 mm): 8, 9, 10, 11, 12, 13, 14, 15, 16, 17, 18, 19, 20, 21, 22, 23, 24, 27, 30 mm;
 1/2" (12.7 mm) x 125 mm;
 1/2" (12.7 mm) x 250 mm;
 1/2" (12.7 mm) x 240 mm;
 1/2" (12.7 mm)

No.	Ø	pcs / szt.	
58240	1/2" (12.7 mm)	24	5

EN Ratchet handle
 PL Grzechotka
 DE Hebelumschaltknarre
 RU Трещотка
 CZ Ráčna
 RO Antrenor cu clichet
 HU Racsnis hajtókar
 ES Llave de carraca



No.	Ø	L [mm]	
53580	3/4" (19.0 mm)	500	10

EN Socket set and accessories
 PL Zestaw nasadek z akcesoriami
 DE Steckschlüsselsatz mit Zubehör
 RU Набор головок с принадлежностями

CZ Sada nástavců s příslušenstvím
 RO Trusă tubulare cu accesorii
 HU Dugókulcs készlet tartozékokkal
 ES Juego de vasos y accesorios

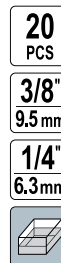

1/4" (6.3 mm): 4, 4.5, 5, 5.5, 6, 7, 8, 9, 10, 11, 12 mm;
 3/8" (9.5 mm): 13, 14, 17 mm;
 3/8" (9.5 mm) x 21 mm;
 3/8" (9.5 mm) x 70 mm;
 1/4" (6.3 mm) x 3/8" (9.5 mm);
 1/4" (6.3 mm) x 50 mm;
 3/8" (9.5 mm) x 190 mm;
 3/8" (9.5 mm)

No.	Ø	pcs / szt.	
58210	1/4" (6.3 mm), 3/8" (9.5 mm)	20	10

EN Socket and ratchet set
 PL Zestaw nasadek z grzechotką
 DE Steckschlüsselsatz mit Hebelumschaltknarre
 RU Набор головок с трещоткой

CZ Sada nástavců a ráčny
 RO Trusă tubulare și antrenor
 HU Dugókulcs készlet racsnis hajtókarral
 ES Juego de vasos y carraca

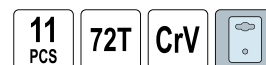

No.	Socket size / Rozmiar nasadki [mm]	L [mm]	Ø	
58600	5, 6, 7, 8, 9, 10, 11, 12, 13, 14	150	1/4" (6.3 mm)	6/24
58602	10, 11, 12, 13, 14, 15, 17, 19, 22, 24	260	1/2" (12.7 mm)	12

EN Socket set
 PL Komplet nasadek z akcesoriami
 DE Sechskantenschlüssel-Einsatz
 RU Набор торцевых головок
 CZ Sada nástrčných klíčů a ráčny
 RO Trusă de scule
 HU Dugókulcs készlet racsnis hajtókkal
 ES Juego de boquillas con accesorios

12 PCS 1/2" 12.7mm 45T AS-DRIVE



1/2" (12.7 mm): 10, 11, 12, 13, 14, 15, 17, 19, 21, 24 mm;
 1/2" (12.7 mm);
 1/2" (12.7 mm); 45T

No.	Ø	pcs / szt.	☐
58633	1/2" (12.7 mm)	12	5/10

EN Socket set
 PL Komplet nasadek z akcesoriami
 DE Sechskantenschlüssel-Einsatz
 RU Набор торцевых головок

CZ Sada nástrčných klíčů a ráčny
 RO Trusă de scule
 HU Dugókulcs készlet racsnis hajtókkal
 ES Juego de boquillas con accesorios

14 PCS 3/4" 19mm



3/4" (19.0 mm): 22, 24, 27, 30, 32, 36, 38, 41, 46, 50 mm;
 3/4" (19.0 mm) x 100; 200 mm;
 3/4" (19.0 mm) x 456 mm; 3/4" (19.0 mm) x 495 mm

No.	Ø	pcs / szt.	☐
58140	3/4" (19.0 mm)	14	2

EN Tool set
 PL Zestaw narzędziowy
 DE Werkzeug-Satz
 RU Набор инструмента

CZ Sada nářadí
 RO Trusa de scule
 HU Szerszámkészlet
 ES Juego de herramientas

38 PCS 1/4" 6.3mm 45T AS-DRIVE



1/4" (6.3 mm): 3.5, 4, 4.5, 5, 5.5, 6, 7, 8, 9, 10, 11, 12, 13, 14 mm;
 1/4" (6.3 mm); 1/4" (6.3 mm); 1/4" (6.3 mm);
 1/4" (6.3 mm); 1/4" (6.3 mm); 1/4" (6.3 mm); 45T; 1/4" (6.3 mm);
 1/4" (6.3 mm); 1/4" (6.3 mm); PH1, PH2; 1/4" (6.3 mm); PZ1, PZ2;
 1/4" (6.3 mm); T10, T15, T20, T25, T30, T40; 1/4" (6.3 mm); 3, 4, 5, 6, 8 mm

No.	Ø	pcs / szt.	☐
58640	1/4" (6.3 mm)	38	10

EN Ratchet handle with socket set
 PL Komplet nasadek z grzechołką
 DE Sechskant-Steckschlüssel-Satz
 RU Трещотка с насадками
 CZ Sada nástrčných klíčů a ráčny
 RO Trusă de scule
 HU Dugókulcs készlet racsnis hajtókkal
 ES Matraca con boquillas

19 PCS 1/2" 12.7mm 45T AS-DRIVE



1/2" (12.7 mm): 8, 9, 10, 11, 12, 13, 14, 15, 16, 17, 19, 21, 22, 23, 24, 27, 30, 32 mm;
 1/2" (12.7 mm); 45T

No.	Ø	pcs / szt.	☐
58634	1/2" (12.7 mm)	19	4/8

EN Socket set
 PL Komplet nasadek z akcesoriami
 DE Sechskantenschlüssel-Einsatz
 RU Набор торцевых головок

CZ Sada nástrčných klíčů a ráčny
 RO Trusă de scule
 HU Dugókulcs készlet racsnis hajtókkal
 ES Juego de boquillas con accesorios

20 PCS 3/4" 19mm



3/4" (19.0 mm): 22, 24, 26, 27, 28, 30, 32, 34, 36, 38, 41, 42, 45, 46, 48, 50 mm;
 3/4" (19.0 mm) x 100; 200 mm;
 3/4" (19.0 mm) x 456 mm;
 3/4" (19.0 mm) x 495 mm

No.	Ø	pcs / szt.	☐
58150	3/4" (19.0 mm)	20	2

EN Tool set
 PL Zestaw narzędziowy
 DE Werkzeug-Satz
 RU Набор инструмента

CZ Sada nářadí
 RO Trusa de scule
 HU Szerszámkészlet
 ES Juego de herramientas

42 PCS 1/4" 6.3mm 45T AS-DRIVE



1/4" (6.3 mm): 4, 4.5, 5, 5.5, 6, 7, 8, 9, 10, 11, 12, 13, 14 mm; 1/4" (6.3 mm); 8, 9, 10, 11, 12, 13 mm;
 1/4" (6.3 mm); 2 PCS; 1/4" (6.3 mm); 1/4" (6.3 mm); 1/4" (6.3 mm); 1/4" (6.3 mm);
 1/4" (6.3 mm); 45T; 1/4" (6.3 mm); 1/4" (6.3 mm); 1/4" (6.3 mm) x 1/4" (6.3 mm);
 1/4" (6.3 mm); 3, 4, 5 mm; 1/4" (6.3 mm); PH0, PH1, PH2; 1/4" (6.3 mm); PZ0, PZ1, PZ2;
 1/4" (6.3 mm); 6, 7, 8 mm; 1.5, 2, 2.5 mm

No.	Ø	pcs / szt.	☐
58641	1/4" (6.3 mm)	42	10

EN Tool set
 PL Zestaw narzędziowy
 DE Werkzeug-Satz
 RU Набор инструмента
 CZ Sada nářadí
 RO Trusa de scule
 HU Szerszámkészlet
 ES Juego de herramientas

56 PCS 1/4" 6.3mm
 CrV 50BV30 45T
 AS-DRIVE



1/4" (6.3 mm): 4, 4.5, 5, 5.5, 6, 7, 8, 9, 10, 11, 12, 13 mm; 1/4" (6.3 mm): 6, 7, 8, 9, 10, 11, 12, 13 mm; 1/4" (6.3 mm): E4, E5, E6, E7, E8, E10; CrV 50BV30; 1/4" (6.3 mm): 2 PCS; 1/4" (6.3 mm); 1/4" (6.3 mm); 1/4" (6.3 mm); 1/4" (6.3 mm); 45T; 1/4" (6.3 mm); 1/4" (6.3 mm) (F) x 3/8" (9.5 mm) (M); 1/4" (6.3 mm): 4, 5.5, 6.5 mm; 1/4" (6.3 mm): PH1, PH2, PH3; 1/4" (6.3 mm): PZ1, PZ2, PZ3; 1/4" (6.3 mm): T8, T10, T15, T20, T25, T30, T40; 1/4" (6.3 mm): 3, 4, 5, 7, 6, 8 mm

STHOR

No.	Ø	pcs / szt.	Icon
58643	1/4" (6.3 mm)	56	10

EN Tool set
 PL Zestaw narzędziowy
 DE Werkzeug-Satz
 RU Набор инструмента
 CZ Sada nářadí
 RO Trusa de scule
 HU Szerszámkészlet
 ES Juego de herramientas

94 PCS 1/2" 12.7mm 1/4" 6.3mm 45T AS-DRIVE



1/2" (12.7 mm): 10, 11, 12, 13, 14, 15, 16, 17, 18, 19, 20, 21, 22, 23, 24, 27, 30, 32; 1/4" (6.3 mm): 4, 4.5, 5, 5.5, 6, 7, 8, 9, 10, 11, 12, 13, 14 mm; 1/2" (12.7 mm): 14, 15, 17, 19 mm; 1/4" (6.3 mm): 6, 7, 8, 9, 10, 11, 12, 13 mm; 1/2" (12.7 mm); 2 PCS; 1/4" (6.3 mm); 2 PCS; 3/8" (9.5 mm) (F) x 1/2" (12.7 mm) (M); 1/4" (6.3 mm); 1/2" (12.7 mm); 1/4" (6.3 mm); 1/2" (12.7 mm): 16, 21 mm; 1/4" (6.3 mm); 1/2" (12.7 mm); 1/4" (6.3 mm); 45T; 1/4" (6.3 mm); 1/4" (6.3 mm); 1/2" (12.7 mm) x 5/16" (7.9 mm); 1/4" (6.3 mm) x 1/4" (6.3 mm); 1/2" (12.7 mm); 8, 10, 12 mm; 5/16" (7.9 mm): PH3, PH4; 5/16" (7.9 mm): PZ3, PZ4; 5/16" (7.9 mm): T40, T45, T50, T55; 5/16" (7.9 mm): 8, 10, 12, 14 mm; 1/4" (6.3 mm): 4, 5.5, 7 mm; 1/4" (6.3 mm): PH1, PH2; 1/4" (6.3 mm): PZ1, PZ2; 1/4" (6.3 mm): T8, T10, T15, T20, T25, T30; 1/4" (6.3 mm): 3, 4, 5, 6 mm; 1.5, 2, 2.5 mm

STHOR

No.	Ø	pcs / szt.	Icon
58687	1/4" (6.3 mm), 1/2" (12.7 mm)	94	3

EN Tool set
 PL Zestaw narzędziowy
 DE Werkzeug-Satz
 RU Набор инструмента
 CZ Sada nářadí
 RO Trusa de scule
 HU Szerszámkészlet
 ES Juego de herramientas

22 PCS 3/8" 9.5mm 45T AS-DRIVE



3/8" (9.5 mm): 6, 7, 8, 9, 10, 11, 12, 13, 14, 15, 16, 17, 18, 19, 20, 21, 22 mm; 3/8" (9.5 mm); 3/8" (9.5 mm); 45T

STHOR

No.	Ø	pcs / szt.	Icon
58661	3/8" (9.5 mm)	22	10

EN Tool set
 PL Zestaw narzędziowy
 DE Werkzeug-Satz
 RU Набор инструмента
 CZ Sada nářadí
 RO Trusa de scule
 HU Szerszámkészlet
 ES Juego de herramientas

108 PCS 1/2" 12.7mm 1/4" 6.3mm CrV 50BV30 45T AS-DRIVE



1/2" (12.7 mm): 10, 11, 12, 13, 14, 15, 16, 17, 18, 19, 20, 21, 22, 24, 27, 30, 32 mm; 1/4" (6.3 mm): 4, 4.5, 5.5, 6, 7, 8, 9, 10, 11, 12, 13, 14 mm; 1/2" (12.7 mm): 14, 15, 17, 19, 22 mm; 1/4" (6.3 mm): 6, 7, 8, 9, 10, 11, 12, 13 mm; 1/2" (12.7 mm): E10, E11, E12, E14, E16, E18, E20, E24; 1/4" (6.3 mm): E4, E5, E6, E7, E8; CrV 50BV30; 1/2" (12.7 mm); 1/4" (6.3 mm); 2 PCS; 3/8" (9.5 mm) (F) x 1/2" (12.7 mm) (M); 1/2" (12.7 mm); 1/4" (6.3 mm); 1/2" (12.7 mm); 16, 21 mm; 1/4" (6.3 mm); 1/2" (12.7 mm); 1/4" (6.3 mm); 45T; 1/4" (6.3 mm); 1/2" (12.7 mm) (F) x 5/16" (7.9 mm) (F); 5/16" (7.9 mm): 8, 10, 12 mm; 5/16" (7.9 mm): PH3, PH4; 5/16" (7.9 mm): PZ3, PZ4; 5/16" (7.9 mm): T40, T45, T50, T55, T60; 5/16" (7.9 mm): 7, 8, 10, 12, 14 mm; 1/4" (6.3 mm): 4, 5.5, 6.5 mm; 1/4" (6.3 mm): PH1, PH2; 1/4" (6.3 mm): PZ1, PZ2; 1/4" (6.3 mm): T8, T10, T15, T20, T25, T27, T30; 1/4" (6.3 mm): 3, 4, 5, 6 mm; 1.5, 2, 2.5 mm

STHOR

No.	Ø	pcs / szt.	Icon
58685	1/4" (6.3 mm), 1/2" (12.7 mm)	108	3

EN Tool set
 PL Zestaw narzędziowy
 DE Werkzeug-Satz
 RU Набор инструмента

CZ Sada nářadí
 RO Trusa de scule
 HU Szerszámkészlet
 ES Juego de herramientas

122 PCS 1/2" 12.7mm 1/4" 6.3mm CrV 50BV30

CrV 6150 45T AS-DRIVE

2



1/2" (12.7 mm): 12, 13, 14, 15, 16, 17, 18, 19, 20, 21, 22, 24, 27, 30, 32 mm; 1/4" (6.3 mm): 4, 4.5, 5, 5.5, 6, 7, 8, 9, 10, 11, 12, 13, 14 mm; 1/2" (12.7 mm): 10, 12, 13, 14, 17, 19 mm; 1/4" (6.3 mm): 4, 5, 6, 7, 8, 9 mm; 1/2" (12.7 mm): E10, E12, E14, E16, E18, E20, E22, E24; CrV 50BV30; 1/2" (12.7 mm), 1/4" (6.3 mm); 3/8" (9.5 mm) (F) x 1/2" (12.7 mm) (M); 3/8" (9.5 mm) (F) x 1/4" (6.3 mm) (M); 1/2" (12.7 mm), 1/4" (6.3 mm); 1/2" (12.7 mm): 16, 21 mm; 1/2" (12.7 mm); 1/4" (6.3 mm); 45T; 1/4" (6.3 mm); 1/4" (6.3 mm) x 1/4" (6.3 mm); 1/4" (6.3 mm): 3, 4, 5, 6 mm; 1/4" (6.3 mm): PH0, PH1, PH2; 1/4" (6.3 mm): P20, PZ1, PZ2; 1/4" (6.3 mm): 4.0, 5.5, 6.5 mm; 1/4" (6.3 mm): PH1, PH2, PH3; 1/4" (6.3 mm): PZ2, PZ3; 1/4" (6.3 mm): T8, T10, T15, T20, T25; 1/4" (6.3 mm): T10, T15, T20, T25, T40; 1/4" (6.3 mm): 3, 4, 5, 6 mm; 8, 9, 10, 11, 12, 13, 14, 15, 16, 17, 18, 19 mm; 4x100, 6.5x150, PH2x100, PH3x150 mm; CrV 6150; 160 mm; 180 mm; 250 mm; 300 mm; 2, 2.5, 3, 4, 5, 6, 7, 8, 10 mm

STHOR

No.	Ø	pcs / szt.	☐
58690	1/4" (6.3 mm), 1/2" (12.7 mm)	122	2

EN Tool set
 PL Zestaw narzędziowy
 DE Werkzeug-Satz
 RU Набор инструмента

CZ Sada nářadí
 RO Trusa de scule
 HU Szerszámkészlet
 ES Juego de herramientas

173 PCS 1/2" 12.7mm 3/8" 9.5mm 1/4" 6.3mm

CrV 50BV30 45T AS-DRIVE



1/2" (12.7 mm): 10, 11, 12, 13, 14, 15, 16, 17, 18, 19, 20, 21, 22, 23, 24, 27, 30, 32 mm; 3/8" (9.5 mm): 10, 11, 12, 13, 14, 15, 16, 17, 18, 19 mm; 1/4" (6.3 mm): 4, 4.5, 5, 5.5, 6, 7, 8, 9, 10, 11, 12, 13, 14 mm; 1/2" (12.7 mm): 16, 17, 18, 19, 22 mm; 3/8" (9.5 mm): 10, 11, 12, 13, 14, 15 mm; 1/4" (6.3 mm): 4, 5, 6, 7, 8, 9, 10 mm; 1/2" (12.7 mm): E18, E20, E24; 3/8" (9.5 mm): E10, E11, E12, E14, E16; 1/4" (6.3 mm): E4, E5, E6, E7, E8; CrV 50BV30; 1/2" (12.7 mm): 2 PCS; 3/8" (9.5 mm), 1/4" (6.3 mm): 2 PCS; 3/8" (9.5 mm) (F) x 1/2" (12.7 mm) (M); 1/2" (12.7 mm), 3/8" (9.5 mm), 1/4" (6.3 mm); 1/2" (12.7 mm): 16, 21 mm; 3/8" (9.5 mm): 18 mm; 1/4" (6.3 mm); 1/2" (12.7 mm), 3/8" (9.5 mm), 1/4" (6.3 mm); 45T; 1/4" (6.3 mm); 1/2" (12.7 mm) x 5/16" (7.9 mm), 3/8" (9.5 mm) x 5/16" (7.9 mm); 1/4" (6.3 mm) x 1/4" (6.3 mm); 5/16" (7.9 mm); 5/16" (7.9 mm): PH3, PH4; 5/16" (7.9 mm): PZ3, PZ4; 5/16" (7.9 mm): T40, T45, T50, T55, T60, T70; 5/16" (7.9 mm): T40, T45, T50, T55, T60, T70; 5/16" (7.9 mm): 7, 8, 10, 12, 14 mm; 1/4" (6.3 mm): T5, T6, T7; 1/4" (6.3 mm): T7, T10, T15, T20, T25, T27, T30, T40, T45; 1/4" (6.3 mm): M5, M6, M8; 1/4" (6.3 mm): RM5, RM6, RM7, RM8, RM9; 1/4" (6.3 mm): 4, 5.5, 6.5, 7 mm; 1/4" (6.3 mm): PH0, PH1, PH2; 1/4" (6.3 mm): P20, PZ1, PZ2; 1/4" (6.3 mm): T8, T9, T10, T15, T20, T25, T27, T30; 1/4" (6.3 mm): T8, T9, T10, T15, T20, T25, T27, T30; 1/4" (6.3 mm): 3, 4, 5, 6 mm; 1.25, 1.5, 2, 2.5, 3, 4, 5 mm

STHOR

No.	Ø	pcs / szt.	☐
58688	1/4" (6.3 mm), 3/8" (9.5 mm), 1/2" (12.7 mm)	173	1

EN Tool set
 PL Zestaw narzędziowy
 DE Werkzeug-Satz
 RU Набор инструмента
 CZ Sada nářadí
 RO Trusa de scule
 HU Szerszámkészlet
 ES Juego de herramientas

2

216 PCS 1/2" 12.7mm 3/8" 9.5mm 1/4" 6.3mm CrV 50BV30 CrV 6140 45T AS-DRIVE



1/2" (12.7 mm): 10, 11, 12, 13, 14, 15, 17, 19, 20, 21, 22, 24, 27, 30, 32 mm; 3/8" (9.5 mm): 10, 11, 12, 13, 14, 15, 16, 17, 18, 19 mm; 1/4" (6.3 mm): 4, 4.5, 5, 5.5, 6, 7, 8, 9, 10, 11, 12, 13, 14 mm; 1/2" (12.7 mm): 16, 17, 18, 19, 22 mm; 3/8" (9.5 mm): 10, 11, 12, 13, 14, 15 mm; 1/4" (6.3 mm): 4, 5, 6, 7, 8, 9, 10 mm; 1/2" (12.7 mm): E20, E22, E24; 3/8" (9.5 mm): E10, E11, E12, E14, E16, E18; 1/4" (6.3 mm): E4, E5, E6, E7, E8; CrV 50BV30; 1/2" (12.7 mm): 2 PCS; 3/8" (9.5 mm): 1/4" (6.3 mm): 2 PCS; 1/2" (12.7 mm): 3/8" (9.5 mm); 1/4" (6.3 mm); 1/2" (12.7 mm): 16, 21 mm; 3/8" (9.5 mm): 18 mm; 1/2" (12.7 mm): 1/4" (6.3 mm); 1/2" (12.7 mm), 3/8" (9.5 mm); 1/4" (6.3 mm); 45T; 1/2" (12.7 mm), 3/8" (9.5 mm); 1/4" (6.3 mm); 45T; 1/2" (12.7 mm) x 5/16" (7.9 mm); 1/4" (6.3 mm) x 5/16" (7.9 mm); 1/4" (6.3 mm) x 1/4" (6.3 mm); 5/16" (7.9 mm); 6, 6.5, 8 mm; 1/4" (6.3 mm): 4, 5.5, 6.5 mm; CrV 6140; 5/16" (7.9 mm): PH3, PH4; 1/4" (6.3 mm): PH1, PH2; CrV 6140; 5/16" (7.9 mm): PZ3, PZ4; 1/4" (6.3 mm): PZ1, PZ2; CrV 6140; 5/16" (7.9 mm): T25, T27, T30, T35, 2xT40, T45, T50; 1/4" (6.3 mm): T8, T10, T15, T20, T25; CrV 6140; 5/16" (7.9 mm): T27, T30, T35, T40, T45, T50; 1/4" (6.3 mm): T8, 2xT10, 2xT15, 2xT20, 2xT25, T40; CrV 6140; 5/16" (7.9 mm): 5.5, 6, 6.5, 7, 8 mm; 1/4" (6.3 mm): 3, 4, 5, 6 mm; CrV 6140; 1/4" (6.3 mm): 3, 4, 5, 6 mm; CrV 6140; 5/16" (7.9 mm): M5, M6, M8, M10; 1/4" (6.3 mm): M5, M6, M8; CrV 6140; 1/4" (6.3 mm): S1, S2; CrV 6140; 1/4" (6.3 mm): 1, 2, 3 mm; CrV 6140; 1/4" (6.3 mm): 1/4" (6.3 mm): 6, 8, 10 mm; CrV 6140; 1/4" (6.3 mm): 4, 6, 8 mm; CrV 6140; 1/4" (6.3 mm): 6, 6.5, 8 mm; CrV 6140; 1/4" (6.3 mm): PH3, PH4; CrV 6140; 1/4" (6.3 mm): PZ3, PZ4; CrV 6140; 1/2" (12.7 mm): T55, T60; 1/4" (6.3 mm): T25, T27, T30, T35, T40 (2 PCS), T45, T50; CrV 6140; 1/4" (6.3 mm): T27, T30, T35, T40, T45, T50; CrV 6140; 1/4" (6.3 mm): 5.5, 6, 6.5, 7, 8 mm; CrV 6140; 1/4" (6.3 mm): M5, M6, M8, M10; CrV 6140; 8, 10, 11, 12, 13, 14, 15, 16, 17, 18, 19, 22 mm; 1.27, 1.5, 2, 2.5, 3, 4, 5 mm



No.	Ø	pcs / szt.	☐
58700	1/4" (6.3 mm), 3/8" (9.5 mm), 1/2" (12.7 mm)	216	1

EN Tool set
 PL Zestaw narzędziowy
 DE Werkzeug-Satz
 RU Набор инструмента
 CZ Sada nářadí
 RO Trusa de scule
 HU Szerszámkészlet
 ES Juego de herramientas

216 PCS 1/2" 12.7mm 3/8" 9.5mm 1/4" 6.3mm CrV 50BV30 45T AS-DRIVE



1/2" (12.7 mm): 10, 11, 12, 13, 14, 15, 17, 19, 20, 21, 22, 24, 27, 30, 32 mm; 3/8" (9.5 mm): 10, 11, 12, 13, 14, 15, 16, 17, 18, 19 mm; 1/4" (6.3 mm): 4, 4.5, 5, 5.5, 6, 7, 8, 9, 10, 11, 12, 13, 14 mm; 1/2" (12.7 mm): 16, 17, 18, 19, 22 mm; 3/8" (9.5 mm): 10, 11, 12, 13, 14, 15 mm; 1/4" (6.3 mm): 4, 5, 6, 7, 8, 9, 10 mm; 1/2" (12.7 mm): E20, E22, E24; 3/8" (9.5 mm): E10, E11, E12, E14, E16, E18; 1/4" (6.3 mm): E4, E5, E6, E7, E8; CrV 50BV30; 1/2" (12.7 mm): 2 PCS; 3/8" (9.5 mm): 1/4" (6.3 mm); 2 PCS; 1/2" (12.7 mm), 3/8" (9.5 mm), 1/4" (6.3 mm); 1/2" (12.7 mm): 16, 21 mm; 3/8" (9.5 mm): 18 mm; 1/2" (12.7 mm), 1/4" (6.3 mm); 1/2" (12.7 mm), 3/8" (9.5 mm), 1/4" (6.3 mm); 45T; 1/2" (12.7 mm), 3/8" (9.5 mm); 1/4" (6.3 mm); 45T; 1/2" (12.7 mm) x 5/16" (7.9 mm); 1/4" (6.3 mm) x 5/16" (7.9 mm); 1/4" (6.3 mm) x 1/4" (6.3 mm); 5/16" (7.9 mm): 6, 6.5, 8 mm; 1/4" (6.3 mm): 4, 5.5, 6.5 mm; 5/16" (7.9 mm): PH3, PH4; 1/4" (6.3 mm): PH1, PH2; 5/16" (7.9 mm): PZ3, PZ4; 1/4" (6.3 mm): PZ1, PZ2; 5/16" (7.9 mm): T25, T27, T30, T35, T40 (2 PCS), T45, T50; 1/4" (6.3 mm): T8, T10, T15, T20, T25; 5/16" (7.9 mm): T27, T30, T35, T40, T45, T50; 1/4" (6.3 mm): T8, 2xT10, 2xT15, 2xT20, 2xT25, T40; 5/16" (7.9 mm): 5.5, 6, 6.5, 7, 8 mm; 1/4" (6.3 mm): 3, 4, 5, 6 mm; 1/4" (6.3 mm): 3, 4, 5, 6 mm; 5/16" (7.9 mm): M5, M6, M8, M10; 1/4" (6.3 mm): M5, M6, M8; 1/4" (6.3 mm): S1, S2; 1/4" (6.3 mm): 1, 2, 3 mm; 1/4" (6.3 mm): 1/4" (6.3 mm): 6, 8, 10 mm; 1/4" (6.3 mm): 4, 6, 8 mm; 1/4" (6.3 mm): 4, 6, 8 mm; 1/4" (6.3 mm): 6, 6.5, 8 mm; 1/4" (6.3 mm): PH3, PH4; 1/4" (6.3 mm): PZ3, PZ4; 1/2" (12.7 mm): T55, T60; 1/4" (6.3 mm): T27, T30, T35, T40, T45, T50; 1/4" (6.3 mm): T27, T30, T35, T40, T45, T50; 1/4" (6.3 mm): 5.5, 6, 6.5, 7, 8 mm; 1/4" (6.3 mm): M5, M6, M8, M10; 8, 10, 11, 12, 13, 14, 15, 16, 17, 18, 19, 22 mm; 1.27, 1.5, 2, 2.5, 3, 4, 5 mm



No.	Ø	pcs / szt.	☐
58691	1/4" (6.3 mm), 3/8" (9.5 mm), 1/2" (12.7 mm)	216	1

EN Tool set
 PL Zestaw narzędziowy
 DE Werkzeug-Satz
 RU Набор инструмента

CZ Sada nářadí
 RO Trusa de scule
 HU Szerszámkészlet
 ES Juego de herramientas

225 PCS 1/2" 12.7mm 3/8" 9.5mm 1/4" 6.3mm CrV 6140 45T AS-DRIVE METRIC SAE



1/2" (12.7 mm): 10, 13, 15, 16, 17, 18, 19, 20, 21, 22, 23, 24, 27, 30, 32 mm; 3/8" (9.5 mm): 10, 11, 12, 13, 14, 15, 16, 17, 18, 19 mm; 1/4" (6.3 mm): 3.5, 4, 4.5, 5, 5.5, 6, 7, 8, 9, 10, 11, 12, 13, 14 mm; 1/2" (12.7 mm): 10, 11, 12, 13, 14, 15, 17, 19, 21 mm; 3/8" (9.5 mm): 6, 7, 8, 9, 10 mm; 1/2" (12.7 mm): 7/16" (11.1 mm), 1/2" (12.7 mm), 9/16" (14.3 mm), 5/8" (15.9 mm), 11/16" (17.5 mm), 3/4" (19.0 mm), 13/16" (20.6 mm), 7/8" (22.2 mm); 1/4" (6.3 mm): 1/4" (6.3 mm), 9/32" (7.1 mm), 5/16" (7.9 mm), 11/32" (8.7 mm), 3/8" (9.5 mm); 1/2" (12.7 mm): 17, 19, 21 mm; 1/2" (12.7 mm): E16, E18, E20, E22, E24; 3/8" (9.5 mm): E10, E11, E12, E14; 1/4" (6.3 mm): E4, E5, E6, E7, E8; 1/2" (12.7 mm): 2 PCS; 3/8" (9.5 mm): 2 PCS; 1/4" (6.3 mm): 2 PCS; 3/8" (9.5 mm) (F) x 1/2" (12.7 mm) (M), 1/2" (12.7 mm) (F) x 3/8" (9.5 mm) (M); 1/2" (12.7 mm), 3/8" (9.5 mm); 1/4" (6.3 mm); 1/2" (12.7 mm): 16, 21 mm; 3/8" (9.5 mm): 18 mm; 1/4" (6.3 mm); 1/2" (12.7 mm); 3/8" (9.5 mm), 1/4" (6.3 mm); 45T; 1/4" (6.3 mm) x 5/16" (7.9 mm), 3/8" (9.5 mm) x 5/16" (7.9 mm), 3/8" (9.5 mm) x 1/4" (6.3 mm), 1/4" (6.3 mm) x 1/4" (6.3 mm); 3/8" (9.5 mm) x 1/4" (6.3 mm), 1/4" (6.3 mm) x 1/4" (6.3 mm) (2 PCS); 1/4" (6.3 mm) x 1/4" (6.3 mm); 5/16" (7.9 mm): 8, 10 mm; 1/4" (6.3 mm): 3, 4, 5.5, 6.5, 7, 8, 9 mm; CrV 6140; 5/16" (7.9 mm): PH3, PH4; 1/4" (6.3 mm): PH0, PH1, PH2, PH3; CrV 6140; 5/16" (7.9 mm): PZ3, PZ4; 1/4" (6.3 mm): PZ0, PZ1, PZ2, PZ3; CrV 6140; 5/16" (7.9 mm): T20, T25, T27, T30, T40, T45, T50, T55 (L=75 mm); T40, T45, T50, T55, T60, T70 (L=30 mm); 1/4" (6.3 mm): T8, T9, T10, T15, T20, T25, T27, T30; 5/16" (7.9 mm): T40, T45, T50, T55, T60, T70; 1/4" (6.3 mm): T8, T9, T10, T15, T20, T25, T27, T30; CrV 6140; 5/16" (7.9 mm): 10, 12, 14 mm; 1/4" (6.3 mm): 3, 4, 5, 6, 7, 8 mm; CrV 6140; 1/4" (6.3 mm): 4, 5, 6, 7, 8 mm; CrV 6140; 1/4" (6.3 mm): M5, M6, M8, M10; CrV 6140; 1/4" (6.3 mm): S1, S2; CrV 6140; 1/4" (6.3 mm): 1, 2, 3, 4; CrV 6140; 1/4" (6.3 mm): 6, 8, 10; CrV 6140; 8, 9, 10, 11, 12, 13, 14, 15, 16, 17, 19, 22 mm; 6x38, PH2x38; 180 mm; 250 mm; 2, 2.5, 3, 4, 5, 6, 7, 8, 10, 12 mm



No.	⊙	pcs / szt.	☐
58693	1/4" (6.3 mm), 3/8" (9.5 mm), 1/2" (12.7 mm)	225	1

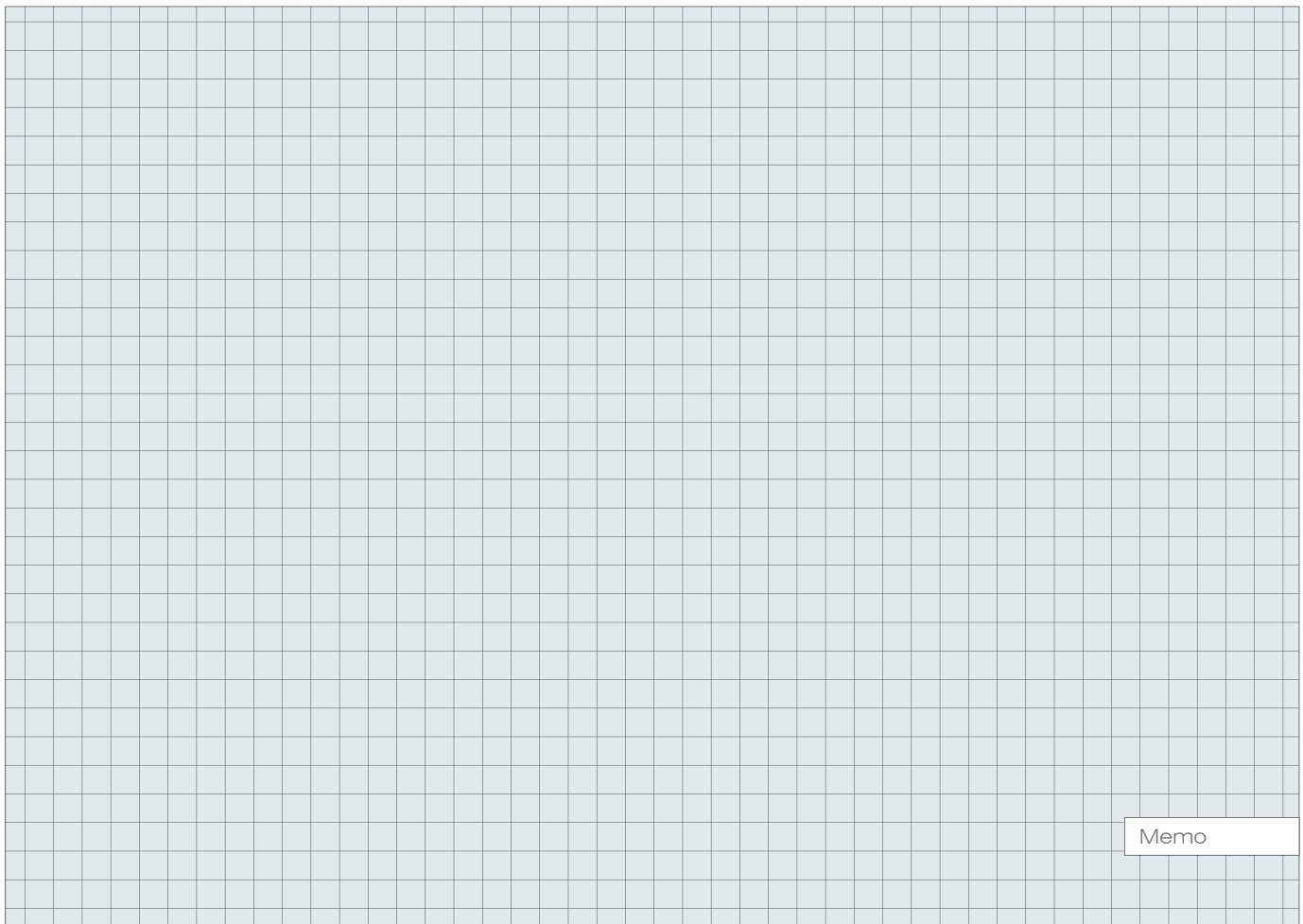

Memo

3

Screwdrivers & screwdriver bits Wkrętaki i końcówki wkrętakowe

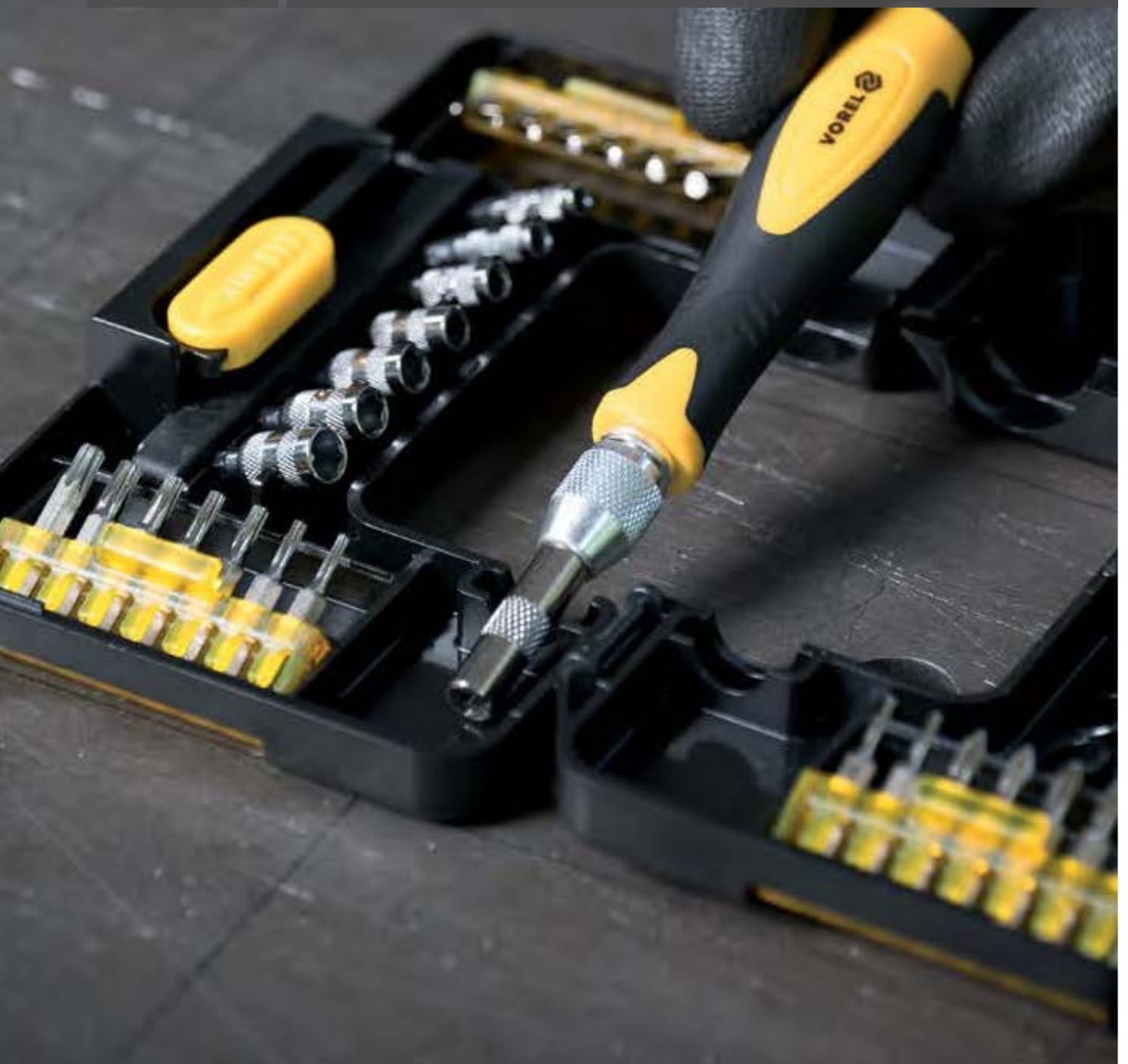

Screwdrivers, 3 colour handle
Wkrętaki, trójkolorowa rączka

26-28

Slotted screwdrivers

Wkrętaki płaskie..... 26

Phillips screwdrivers

Wkrętaki krzyżakowe..... 26

Pozidrive screwdrivers

Wkrętaki „Pozidrive”..... 26

Torx screwdrivers

Wkrętaki „Torx”..... 26

Screwdriver sets

Komplety wkrętaków..... 26

Ratchet screwdrivers

Wkrętaki z grzechotką..... 28

Screwdrivers HI-TEC & sets
Wkrętaki HI-TEC i zestawy

28-29

Slotted screwdrivers

Wkrętaki płaskie..... 28

Phillips screwdrivers

Wkrętaki krzyżakowe..... 29

Screwdriver sets

Komplety wkrętaków..... 29

Special & impact screwdrivers
Wkrętaki specjalne i udarowe

29-32

Two way screwdrivers

Wkrętaki dwustronne..... 29

Ratchet screwdriver sets with bits

Zestawy wkrętaków z grzechotką i bitami..... 30

Impact screwdrivers

Wkrętaki udarowe..... 31

Telescopic screwdrivers

Wkrętaki teleskopowe..... 32

T-bar screwdrivers

Wkrętaki T-gryf..... 32

Screwdriver sets

Zestawy wkrętaków



32-33

Precision screwdrivers setsZestawy wkrętaków
precyzyjnych

34-35

Screwdriver bits

Kończówki wkrętakowe



35-38

Screwdriver bit sets

Zestawy końcówek wkrętakowych..... 35

Screwdriver bit holders

Uchwyty do końcówek wkrętakowych..... 38

Nut setter sets

Zestawy nasadek magnetycznych do wkrętarek..... 38

Hex & Torx keys & sets

Klucze imbusowe i zestawy



39-41

T-handle keys & sets

Klucze imbusowe typu „T” i zestawy..... 39

Hex keys

Klucze imbusowe „Hex”..... 40

Hex key sets

Zestawy kluczy imbusowych „Hex”..... 40

Torx & Torx Tamperproof key sets

Zestawy kluczy imbusowych „Torx” i „Torx Tamperproof”..... 41

EN Screwdriver
PL Wkrętak
DE Schraubendreher
RU Отвёртка

CZ Šroubovák
RO Şurubelniţă
HU Csavarhúzó
ES Destornillador



No.	⊖ [mm]	L [mm]	PCS ROBŪ	
60912	2	75	12	96/384
60950	3	75	12	96/384
60951	3	100	12	96/384
60952	4	100	12	96/384
60913	4	150	12	96/384
60914	4	200	12	60/240
60915	5	38	12	60/240
60953	5	75	12	60/240
60954	5	100	12	60/240
60955	5	150	12	60/240
60916	5	200	12	36/144
60917	6	38	12	60/240
60956	6	100	12	36/144
60957	6	150	12	36/144
60958	6	200	12	36/144
60959	8	150	6	24/96
60918	8	250	6	24/96

EN Screwdriver
PL Wkrętak
DE Schraubendreher
RU Отвёртка

CZ Šroubovák
RO Şurubelniţă
HU Csavarhúzó
ES Destornillador



No.	⊕	L [mm]	PCS ROBŪ	
60931	PZ0	75	12	96/384
60932	PZ0	100	12	96/384
60933	PZ1	75	12	60/240
60934	PZ1	100	12	60/240
60935	PZ1	200	12	36/144
60936	PZ2	100	12	36/144
60937	PZ2	150	12	36/144
60938	PZ2	200	12	36/144
60939	PZ3	150	8	24/96

EN Screwdriver set
PL Zestaw wkrętek
DE Schraubendreher-Satz
RU Набор отвёрток
CZ Sada šroubováků
RO Set şurubelniţe
HU Csavarhúzó készlet
ES Juego de destornilladores



No.	pcs / szt.	
60970	10	6/24

EN Screwdriver
PL Wkrętak
DE Schraubendreher
RU Отвёртка
CZ Šroubovák
RO Şurubelniţă
HU Csavarhúzó
ES Destornillador

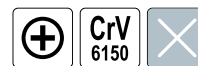

No.	⊕	L [mm]	PCS ROBŪ	
60920	PH00	65	12	96/384
60961	PH0	75	12	96/384
60962	PH0	100	12	96/384
60921	PH1	38	12	60/240
60963	PH1	75	12	60/240
60964	PH1	100	12	60/240
60965	PH1	150	12	60/240
60922	PH1	250	12	36/144
60923	PH2	38	12	60/240
60966	PH2	100	12	36/144
60967	PH2	150	12	36/144
60968	PH2	200	12	36/144
60924	PH2	250	12	36/144
60969	PH3	150	6	24/96

EN Screwdriver
PL Wkrętak
DE Schraubendreher
RU Отвёртка

CZ Šroubovák
RO Şurubelniţă
HU Csavarhúzó
ES Destornillador

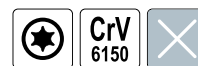

No.	⊕	L [mm]	PCS ROBŪ	
60880	T5	75	12	96/384
60881	T6	75	12	96/384
60882	T7	75	12	96/384
60883	T8	75	12	96/384
60885	T10	100	12	60/240
60886	T15	100	12	60/240
60887	T20	100	12	60/240
60888	T25	100	12	36/144
60889	T27	100	12	36/144
60890	T30	100	12	36/144
60891	T40	100	6	24/96

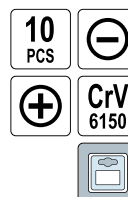

⊖ 3x75, 5x100, 6x100, 6x150, 8x150 mm; CrV 6150;
⊕ PH0x75, PH1x75, PH2x100, PH2x150, PH3x150 mm; CrV 6150

EN Screwdriver set
 PL Zestaw długich wkrętaków
 DE Schraubendrehersatz
 RU Набор отверток

CZ Sada dlouhých šroubováků
 RO Set surubelnițe lungi
 HU Hosszú csavarhúzó készlet
 ES Juego de destornilladores largos



⊖ 5.5, 6.5, 8.0 mm (L=325 mm); CrV 6150;
 ⊕ PH0, PH1, PH2 (L=325 mm); CrV 6150;
 ⊗ T25, T30 (L=325 mm); CrV 6150



No.	pcs / szt.	📦
60990	8	10

EN Screwdriver set
 PL Zestaw wkrętaków
 DE Schraubendreher-Satz
 RU Набор отвёрток
 CZ Sada šroubováků
 RO Set șurubelnițe
 HU Csavarhúzó készlet
 ES Juego de destornilladores

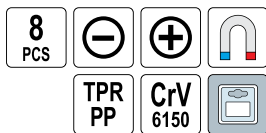

⊖ 3.0x75, 5.5x75, 6.5x38, 6.5x100 mm; CrV 6150;
 ⊕ PH0x75, PH1x75, PH2x38, PH2x100 mm; CrV 6150



No.	pcs / szt.	📦
60782	8	6/24

EN Screwdriver set
 PL Zestaw wkrętaków
 DE Schraubendreher-Satz
 RU Набор отвёрток

CZ Sada šroubováků
 RO Set șurubelnițe
 HU Csavarhúzó készlet
 ES Juego de destornilladores

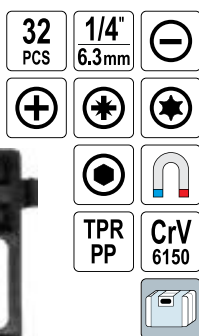

⊖ 4.0x75, 6.5x100, 8.0x150 mm; CrV 6150; ⊕ PH1x75, PH2x100 mm; CrV 6150; ⊗ PZ1x75, PZ2x100 mm; CrV 6150;
 ⊖ 2.0x50, 2.5x50, 3.0x50 mm; CrV 6150; ⊕ PH00x50, PH0x50, PH1x50 mm; CrV 6150; ⊕ 1/4" (6.3 mm); PH0, PH1, PH2 (L=25 mm); CrV 6150; ⊕ 1/4" (6.3 mm); PZ0, PZ1, PZ2 (L=25 mm); CrV 6150;
 ⊕ 1/4" (6.3 mm); T10, T15, T20, T25, T30 (L=25 mm); CrV 6150; ⊕ 1/4" (6.3 mm); 2, 2.5, 3, 4, 5, 6 mm (L=25 mm); CrV 6150; ⊕ 1/4" (6.3 mm)



No.	pcs / szt.	📦
60785	32	10

EN Screwdriver set
 PL Zestaw wkrętaków
 DE Schraubendreher-Satz
 RU Набор отвёрток
 CZ Sada šroubováků
 RO Set șurubelnițe
 HU Csavarhúzó készlet
 ES Juego de destornilladores



⊖ 5.5x75, 6.5x38, 6.5x100 mm; CrV 6150;
 ⊕ PH1x75, PH2x38, PH2x100 mm; CrV 6150



No.	pcs / szt.	📦
60783	6	10/20

EN Screwdriver set
 PL Zestaw wkrętaków
 DE Schraubendreher-Satz
 RU Набор отвёрток
 CZ Sada šroubováků
 RO Set șurubelnițe
 HU Csavarhúzó készlet
 ES Juego de destornilladores

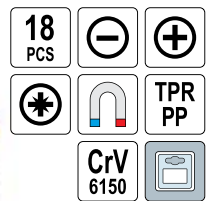

⊖ 5.5x75, 6.5x38, 6.5x100, 8.0x150 mm; CrV 6150; ⊕ PH1x75, PH2x38, PH2x100, PH3x150 mm; CrV 6150;
 ⊖ 2.5x50, 3.0x50 mm; CrV 6150; ⊕ PH00x50, PH0x50 mm; CrV 6150; ⊗ T5x50, T6x50, T7x50, T8x50, T9x50, T10x50 mm; CrV 6150



No.	pcs / szt.	📦
60781	18	10

EN Screwdriver set
 PL Zestaw wkrętaków
 DE Schraubendreher-Satz
 RU Набор отвёрток
 CZ Sada šroubováků
 RO Set șurubelnițe
 HU Csavarhúzó készlet
 ES Juego de destornilladores

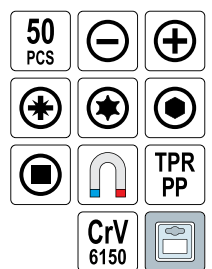

⊖ 4.0x75, 6.5x68, 6.5x100, 8.0x150 mm; CrV 6150; ⊕ PH1x75, PH2x38, PH2x100, PH3x150 mm; CrV 6150;
 ⊖ 2.0x50, 2.5x50, 3.0x50 mm; CrV 6150; ⊕ PH00x50, PH0x50 mm; CrV 6150; ⊗ T6x50, T8x50, T10x50 mm; CrV 6150; ⊕ 1/4" (6.3 mm); 3, 4, 5, 6 mm (L=25 mm); CrV 6150; ⊕ 1/4" (6.3 mm); PH0, PH1, PH2, PH3 (L=25 mm); CrV 6150; ⊕ 1/4" (6.3 mm); PZ0, PZ1, PZ2, PZ3 (L=25 mm); CrV 6150;
 ⊕ 1/4" (6.3 mm); 2, 2.5, 3, 4, 5x2, 5.5, 6 mm (L=25 mm); CrV 6150; ⊕ 1/4" (6.3 mm); T8, T10, T15, T20, T25, T27, T30, T40 (L=25 mm); CrV 6150; ⊕ 1/4" (6.3 mm); S0, S1, S2, S3 (L=25 mm); CrV 6150;
 ⊕ 1/4" (6.3 mm)



No.	pcs / szt.	📦
60780	50	6

- EN Screwdriver set
- PL Zestaw wkrętek
- DE Schraubendreher-Satz
- RU Набор отвёрток
- CZ Sada šroubováků
- RO Set șurubelnițe
- HU Csavarhúzó készlet
- ES Juego de destornilladores



No.	pcs / szt.	
60750	100	3

- EN Ratchet screwdriver set
- PL Zestaw wkrętek z grzechotką
- DE Ratschenschraubendreher-Satz mit Einsätzen
- RU Отвёртка реверсивная с набором бит и торцевых головок
- CZ Ráčňový kloubový šroubovák
- RO Set șurubelnița
- HU Dugókulcs és bit készlet csukló
- ES Juego con destornillador y carraca



1/4" (6.3 mm): 5, 6, 7 mm (L=25 mm); PH1, PH1, PH2, PH2, PH3 (L=52 mm); T10, T15, T20, T25, T30 (L=52 mm); 1/4" (6.3 mm): 4, 6 mm (L=52 mm); 1/4" (6.3 mm): 5, 6, 7, 8, 9, 10 mm; 5/16" (7.9 mm), 11/32" (8.7 mm), 3/8" (9.5 mm), 7/16" (11.1 mm), 1/2" (12.7 mm); 1/4" (6.3 mm)



No.	pcs / szt.	
60975	29	6/24

- EN Screwdriver
- PL Wkrętek
- DE Schraubendreher
- RU Отвёртка
- CZ Šroubovák
- RO Șurubelniță
- HU Csavarhúzó
- ES Destornillador

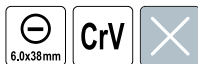

No.	⊖ [mm]	L [mm]	
61090	6	38	12/192

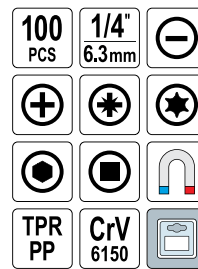

1/4" (6.3 mm): 6, 7, 8, 9, 10, 11 mm (L=35 mm); CrV 6150; 3.0x75, 4.0x100, 5.5x75, 5.5x100, 6.5x100, 6.5x150, 8.0x150 mm; CrV 6150; PH0x75, PH1x75, PH1x100, PH1x150, PH2x100, PH2x150 mm; CrV 6150; PZ0x75, PZ1x75, PZ2x100 mm; CrV 6150; T10x75, T20x75, T25x100, T30x100 mm; CrV 6150; S0x75, S1x75, S2x100 mm; CrV 6150; 2.5x50, 3.0x50 mm; CrV 6150; PH00x50, PH0x50 mm; CrV 6150; T6x50, T7x50, T8x50, T10x50 mm; CrV 6150; 1/4" (6.3 mm): 3, 3.5, 4, 4.5, 5, 5.5, 6, 6.5, 7, 8 mm (L=25 mm); CrV 6150; 1/4" (6.3 mm): PH0 (2 PCS), PH1 (2 PCS), PH2 (3 PCS), PH3 (3 PCS) (L=25 mm); CrV 6150; 1/4" (6.3 mm): PZ0 (2 PCS), PZ1 (2 PCS), PZ2 (3 PCS), PZ3 (3 PCS) (L=25 mm); CrV 6150; 1/4" (6.3 mm): T6, T8, T10, T15, T20, T25, T27, T30, T35, T40 (L=25 mm); CrV 6150; 1/4" (6.3 mm): 2, 2.5, 3, 3.5, 4, 4.5, 5, 5.5, 6, 7 mm (L=25 mm); CrV 6150; 1/4" (6.3 mm): 1/8", 9/64", 5/32", 3/16", 7/32", 1/4" (L=25 mm); CrV 6150; 1/4" (6.3 mm): S0, S1, S2, S3 (L=25 mm); CrV 6150; SL5-PH1, SL6-PH2; CrV 6150

- EN Screwdriver
- PL Wkrętek
- DE Schraubendreher
- RU Отвёртка
- CZ Šroubovák
- RO Șurubelniță
- HU Csavarhúzó
- ES Destornillador



No.	⊖ [mm]	L [mm]	
61010	2.5	63	12/240
61020	3.2	75	12/240
61030	3.2	100	12/240
61040	3.2	150	12/240
61050	5.0	75	12/240
61060	5.0	100	12/240
61070	5.0	150	12/240
61080	5.0	200	12/240

- EN Screwdriver
- PL Wkrętek
- DE Schraubendreher
- RU Отвёртка
- CZ Šroubovák
- RO Șurubelniță
- HU Csavarhúzó
- ES Destornillador



No.	⊖ [mm]	L [mm]	Driver / Zabierak	
61110	6	100	tak	12/144
61120	6	150	nie	12/144
61140	6	200	nie	12/144
61160	8	150	nie	6/72

EN Screwdriver
 PL Wkrętk
 DE Schraubendreher
 RU Отвёртка
 CZ Šroubovák
 RO Şurubelniţă
 HU Csavarhúzó
 ES Destornillador

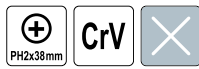

No.	⊕	L [mm]	📦
61290	PH2	38	12/288

EN Screwdriver
 PL Wkrętk
 DE Schraubendreher
 RU Отвёртка

CZ Šroubovák
 RO Şurubelniţă
 HU Csavarhúzó
 ES Destornillador



No.	⊕	L [mm]	📦
61250	PH1	75	12/240
61260	PH1	100	12/240
61270	PH1	150	12/240
61280	PH1	200	12/240

EN Screwdriver set
 PL Zestaw wkrętek
 DE Schraubendreher-Satz
 RU Набор отвёрток
 CZ Sada šroubováků
 RO Set şurubelniţe
 HU Csavarhúzó készlet
 ES Juego de destornilladores

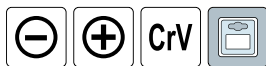

No.	pcs / szt.	📦
61550	5	5/20

EN Screwdriver
 PL Wkrętk
 DE Schraubendreher
 RU Отвёртка

CZ Šroubovák
 RO Şurubelniţă
 HU Csavarhúzó
 ES Destornillador



No.	⊕	L [mm]	📦
61210	PH00	63	12/240
61220	PH0	75	12/240
61230	PH0	100	12/240
61240	PH0	150	12/240

EN Screwdriver
 PL Wkrętk
 DE Schraubendreher
 RU Отвёртка
 CZ Šroubovák
 RO Şurubelniţă
 HU Csavarhúzó
 ES Destornillador



No.	⊕	L [mm]	Driver / Zaberak	📦
61300	PH2	100	nie	12/144
61320	PH2	150	nie	12/144
61340	PH2	200	nie	12/144
61350	PH2	250	nie	12/144

EN Two-way screwdriver
 PL Wkrętk dwustronny
 DE Umsteckschraubendreher
 RU Отвёртка двухсторонняя
 CZ Dvoustranný šroubovák
 RO Şurubelniţă dublu capăt
 HU Kétoldalas csavarhúzó
 ES Destornillador de dos caras

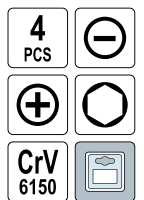

⊕ 5 mm-PH1; CrV 6150;
 ⊕ 6 mm-PH2; CrV 6150;
 ○ 6-8 mm; CrV 6150



No.	pcs / szt.	📦
64654	4	12/72

EN Two-way screwdriver
 PL Wkrętek dwustronny
 DE Umsteckschraubendreher
 RU Отвёртка двухсторонняя
 CZ Dvoustranný šroubovák
 RO Şurubelniţă dublu capăt
 HU Kétfoldalas csavarhúzó
 ES Destornillador de dos caras



6 mm-PH2 (L=115 mm); CrV 6150



No.	pcs / szt.	
64952	6/120	

EN Screwdriver
 PL Wkrętek
 DE Schraubendreher
 RU Отвёртка
 CZ Šroubovák
 RO Şurubelniţă
 HU Csavarhúzó
 ES Destornillador



No.	pcs / szt.	
65041	7	25/100

EN Ratchet screwdriver set with bits
 PL Zestaw wkrętek z grzechotką i bitami
 DE Schraubendreher mit Ratche
 RU Отвёртка реверсивная с набором бит
 CZ Šroubovák z fehtačkou
 RO Şurubelniţă cu clichet
 HU Racsnis csavarbehajtó
 ES Juego con destornillador y carraca

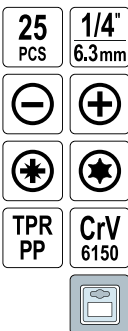

1/4" (6.3 mm): 4, 5, 6, 7, 6.9, 10, 11, 12 mm; 1/4" (6.3 mm); (L=25 mm); CrV 6150; 1/4" (6.3 mm): 4, 5, 6 mm (L=25 mm); CrV 6150; PH0, PH1, PH2, PH3 (L=25 mm); CrV 6150; PZ0, PZ1, PZ2, PZ3 (L=25 mm); CrV 6150; T10, T15, T20 (L=25 mm); CrV 6150



No.	pcs / szt.	
65105	25	6/36

EN Precision screwdriver bits
 PL Zestaw końcówek śrubokrętowych
 DE Schraubendreherbitsatz
 RU Набор специальных бит
 CZ Sada bitov
 RO Trusă şurubelniţă interschimbabilă
 HU Bitkészlet
 ES Juego de llaves especiales

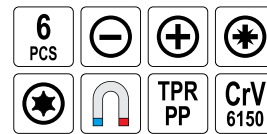

5-6 mm (L=150 mm); CrV 6150; PH1-PH2 (L=150 mm); CrV 6150; PZ1-PZ2 (L=150 mm); CrV 6150; T20-T25 (L=150 mm); CrV 6150; 5-6 mm (L=150 mm); CrV 6150



No.	pcs / szt.	
64960	6	12/48

EN Ratchet screwdriver set with bits
 PL Zestaw wkrętek z grzechotką i bitami
 DE Schraubendreher mit Ratche
 RU Отвёртка реверсивная с набором бит
 CZ Šroubovák z fehtačkou
 RO Şurubelniţă cu clichet
 HU Racsnis csavarbehajtó
 ES Juego con destornillador y carraca

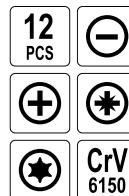

1/4" (6.3 mm): 3.5, 4, 5.5 mm (L=25 mm); 1/4" (6.3 mm): PH0, PH1, PH2 (L=25 mm); 1/4" (6.3 mm): PZ0, PZ1, PZ2 (L=25 mm); 1/4" (6.3 mm): T20, T25 (L=25 mm)



No.	pcs / szt.	
64658	12	12/72

EN Ratchet screwdriver set with bits
 PL Wkrętek z grzechotką i wymiennymi końcówkami
 DE Schraubendreher mit Ratche
 RU Отвёртки с набором бит
 CZ Šroubovák z fehtačkou
 RO Şurubelniţă cu clichet
 HU Racsnis csavarbehajtó
 ES Juego con destornillador y carraca

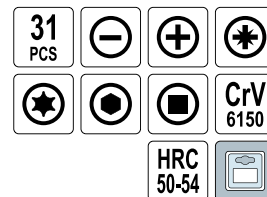

1/4" (6.3 mm): 3, 3.5, 4, 5, 5.5, 6 mm (L=25 mm); 1/4" (6.3 mm): PH0, PH1, PH2, PH3 (L=25 mm); 1/4" (6.3 mm): PZ0, PZ1, PZ2, PZ3 (L=25 mm); 1/4" (6.3 mm): T10, T15, T20, T25, T27, T30 (L=25 mm); 1/4" (6.3 mm): 2, 2.5, 3, 4, 5, 6 mm (L=25 mm); 1/4" (6.3 mm): S0, S1 (L=25 mm); 2.0x50 mm; PH00 x 50 mm



No.	pcs / szt.	
64655	31	6/36

EN Ratchet screwdriver set with bits
 PL Zestaw wkrętak z grzechotką i bitami
 DE Schraubendreher mit Ratche
 RU Отвёртка реверсивная с набором бит
 CZ Šroubovák z fehtačkou
 RO Şurubelniţă cu clichet
 HU Racsnis csavarbehajtó
 ES Juego con destornillador y carraca

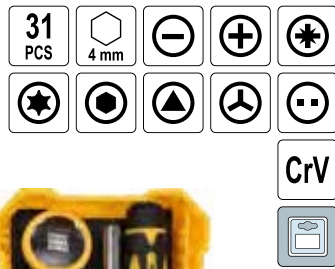

□ 1.0, 1.5, 2.0, 2.5, 3.0 mm; CrV; ⚙ PH000, PH00, PH0, PH1, PH2; CrV; ⚙ PZ0, PZ1; CrV; ⚙ T4, T5, T6, T7, T8, T10; CrV; ○ 0.7, 0.9, 1.3, 1.5, 2.0, 3.0 mm; CrV; △ 3.0 mm; CrV; ▽ 3.0 mm; CrV; ▽ 2.6 mm; CrV; ▽ 115 mm; CrV



No.	pcs / szt.	📦
65025	31	6/24

EN Ratchet screwdriver set with bits
 PL Zestaw wkrętak z grzechotką i bitami
 DE Schraubendreher mit Ratche
 RU Отвёртка реверсивная с набором бит
 CZ Šroubovák z fehtačkou
 RO Şurubelniţă cu clichet
 HU Racsnis csavarbehajtó
 ES Juego con destornillador y carraca



EN Impact screwdriver
 PL Wkrętak udarowy
 DE Schlagschrauber
 RU Отвёртка ударная
 CZ Narazový šroubovák kovový
 RO Şurubelniţă metalică cu percutor
 HU Kézi ütvecsavarhúzó
 ES Destornillador de percusión



No.	pcs / szt.	📦
65120	5	25

EN Ratchet screwdriver set with bits
 PL Wkrętak z grzechotką i wymiennymi końcówkami
 DE Schraubendreher mit Ratche
 RU Отвёртки с набором бит
 CZ Šroubovák z fehtačkou
 RO Şurubelniţă cu clichet
 HU Racsnis csavarbehajtó
 ES Juego con destornillador y carraca

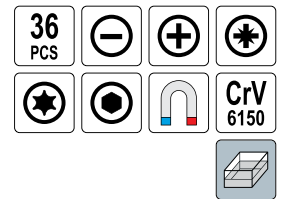

□ 1/4" (6.3 mm): 4, 4.5, 5, 6, 7, 8, 9, 10, 11, 12, 13 mm; □ 1/4" (6.3 mm): 3, 3.5, 4, 5.5 mm (L=25 mm); ⚙ 1/4" (6.3 mm): PH0, PH1, PH2, PH3 (L=25 mm); ⚙ 1/4" (6.3 mm): PZ0, PZ1, PZ2, PZ3 (L=25 mm); ⚙ 1/4" (6.3 mm): T10, T15, T20, T25, T27, T30 (L=25 mm); ○ 1/4" (6.3 mm): 3, 4 mm (L=25 mm); ▽ 50 mm



No.	pcs / szt.	📦
64660	36	6/24

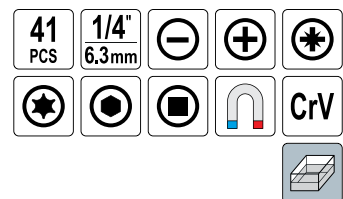

□ 1/4" (6.3 mm): 5, 6, 7, 8, 9, 10 mm (L=20 mm); CrV; □ 3.0, 4.0, 5.0, 6.0 mm, 1/8" (3.2 mm), 5/32" (4.0 mm), 3/16" (4.8 mm), 1/4" (6.3 mm); CrV; ⚙ PH0, PH1, PH2, PH3; CrV; ⚙ PZ0, PZ1, PZ2, PZ3; CrV; ⚙ T15, T20, T25, T30; CrV; ○ 3.0, 4.0, 5.0, 6.0 mm, 1/8" (3.2 mm), 5/32" (4.0 mm), 3/16" (4.8 mm), 1/4" (6.3 mm); CrV; □ S0, S1, S2, S3 mm; CrV; □ 1/4" (6.3 mm); (L=25 mm); CrV; □ 1/4" (6.3 mm); (L=60 mm); CrV



No.	pcs / szt.	📦
64385	41	6/24

EN Ratchet screwdriver set with bits
 PL Zestaw wkrętak z grzechotką i bitami
 DE Schraubendreher mit Ratche
 RU Отвёртка реверсивная с набором бит
 CZ Šroubovák z fehtačkou
 RO Şurubelniţă cu clichet
 HU Racsnis csavarbehajtó
 ES Juego con destornillador y carraca

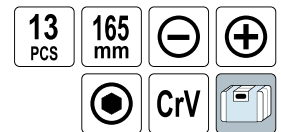

□ 5/16" (7.9 mm) x 1/2" (12.7 mm);
 □ 5, 6, 8, 9 mm (L=35 mm);
 ⚙ PH1, PH2, PH3, PH4 (L=35 mm);
 ○ 4, 5, 6, 8 mm (L=35 mm)



No.	pcs / szt.	📦
65123	13	20

EN Impact screwdriver
 PL Wkrętak udarowy
 DE Schlagschrauber
 RU Отвёртка ударная
 CZ Narazový šroubovák kovový
 RO Şurubelniţă metalică cu percutor
 HU Kézi ütvecsavarhúzó
 ES Destornillador de percusión

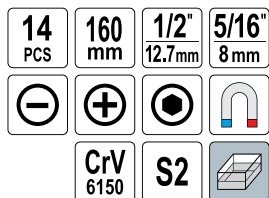

5/16" (7.9 mm) x 1/2" (12.7 mm);
 4, 5, 6, 8, 9 mm (L=35 mm); S2;
 PH1, PH2, PH3 (L=35 mm); S2;
 4, 5, 6, 8 mm (L=35 mm)



No.	pcs / szt.	☐
65124	14	20

EN Screwdriver with magnetic telescopic pick-up tool
 PL Wkrętak z teleskopowym chwytakiem magnetycznym
 DE Schraubendreher mit auschiebbarem magnetischem Halter
 RU Отвёртка магнитная с битами
 CZ Magnetický řoubavák-teleskop
 RO Şurubelniţă telesopică cu cap magnetic
 HU Mágneses csavarbehajtó-teleszkop
 ES Destornillador magnético-telescop

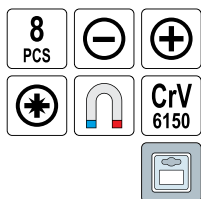

1/4" (6.3 mm): 3, 4, 5, 5.5 mm (L=25 mm);
 1/4" (6.3 mm): PH1, PH2 (L=25 mm);
 1/4" (6.3 mm): PZ1, PZ2 (L=25 mm)



No.	pcs / szt.	☐
64650	8	12/72

EN T-bar screwdriver
 PL Wkrętak T-gryf
 DE T-griff Schraubendrehersatz
 RU Отвёртка с T-образной ручкой и насадками
 CZ Šroubovák T-gryf
 RO Set şurubelniţa tip „T”
 HU Csavarbehajtó, T-gryf
 ES Destornillador T-grifo

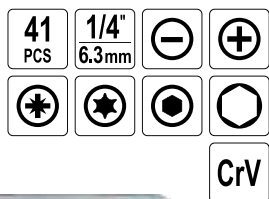

1/4" (6.3 mm): 4, 5, 6, 7 mm (L=25 mm); 1/4" (6.3 mm): PH1, PH2, PH3 (L=25 mm);
 1/4" (6.3 mm): T10, T15, T20, T25, T30, T40 (L=25 mm); 1/4" (6.3 mm): PZ1, PZ2, PZ3
 (L=25 mm); 1/4" (6.3 mm): 4, 5, 6 mm (L=25 mm); 1/4" (6.3 mm): 5, 6, 7, 8, 9, 10, 11, 12, 13 mm; CrV;
 1/4" (6.3 mm): 3/16" (4.8 mm), 7/32" (5.6 mm), 1/4" (6.3 mm), 9/32" (7.1 mm), 5/16" (7.9 mm), 11/32" (8.7 mm), 3/8"
 (9.5 mm), 7/16" (11.1 mm), 1/2" (12.7 mm); CrV; 1/4" (6.3 mm) x 6 mm; 1/4" (6.3 mm)



No.	pcs / szt.	☐
65150	41	24

EN Telescopic screwdriver, magnetic
 PL Wkrętak magnetyczny, teleskopowy
 DE Schraubendreher
 RU Отвёртка магнитная с битами
 CZ Magnetický řoubavák -teleskop
 RO Şurubelniţă telesopică magnetică
 HU Mágneses csavarbehajtó-teleszkop
 ES Destornillador magnético-telescop



No.	pcs / szt.	☐
65045	7	25/100

EN T-bar screwdriver
 PL Wkrętak T-gryf
 DE T-griff Schraubendrehersatz
 RU Отвёртка с T-образной ручкой и насадками
 CZ Šroubovák T-gryf
 RO Set şurubelniţa tip „T”
 HU Csavarbehajtó, T-gryf
 ES Destornillador T-grifo

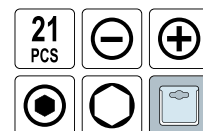

No.	pcs / szt.	☐
65100	21	10/80

EN Screwdriver set
 PL Zestaw wkrętek
 DE Schraubendreher-Satz
 RU Набор отвёрток
 CZ Sada šroubováků
 RO Set şurubelniţe
 HU Csavarhúzó készlet
 ES Juego de destornilladores



No.	pcs / szt.	☐
64060	6	20/60

EN Screwdriver set
 PL Zestaw wkrętaków
 DE Schraubendreher-Satz
 RU Набор отвёрток
 CZ Sada šroubováků
 RO Set șurubelnițe
 HU Csavarhúzó készlet
 ES Juego de destornilladores

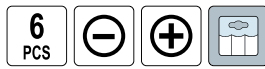

No.	pcs / szt.	
64050	6	20/80

EN Screwdriver set
 PL Zestaw wkrętaków
 DE Schraubendreher-Satz
 RU Набор отвёрток
 CZ Sada šroubováků
 RO Set șurubelnițe
 HU Csavarhúzó készlet
 ES Juego de destornilladores



No.	pcs / szt.	
64090	6	10/60

EN Precision screwdriver bits and holder
 PL Zestaw końcówek śrubokrętowych z uchwytem
 DE Schraubendreherbitsatz mit Bithalter
 RU Отвёртка с набором специальных бит
 CZ Sada bitů s držákem
 RO Set șurubelnițe cu biți de precizie
 HU Racsnis csavarbehajtó
 ES Juego de destornillador con puntas

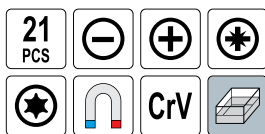

VOREL

No.	pcs / szt.	
64370	21	10/60

EN Screwdriver set
 PL Zestaw wkrętaków
 DE Schraubendreher-Satz
 RU Набор отвёрток
 CZ Sada šroubováků
 RO Set șurubelnițe
 HU Csavarhúzó készlet
 ES Juego de destornilladores



No.	pcs / szt.	
64070	7	20/80

EN Ratchet screwdriver set with bits
 PL Zestaw wkrętak z grzechotką i bitami
 DE Schraubendreher mit Ratche
 RU Отвёртка реверсивная с набором бит
 CZ Šroubovák z řehotačkou
 RO Șurubelnița cu clicheț
 HU Racsnis csavarbehajtó
 ES Juego con destornillador y carraca

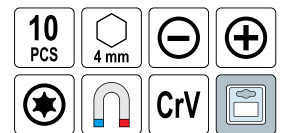

▯ 1.0, 1.5, 2.0 mm; CrV;
 ⊕ PH00, PH0, PH1; CrV;
 ⊕ T6, T7, T8; CrV

VOREL

No.	pcs / szt.	
64400	10	8/144

EN Ratchet screwdriver set with bits
 PL Zestaw wkrętak z grzechotką i bitami
 DE Schraubendreher mit Ratche
 RU Отвёртка реверсивная с набором бит
 CZ Šroubovák z řehotačkou
 RO Șurubelnița cu clicheț
 HU Racsnis csavarbehajtó
 ES Juego con destornillador y carraca

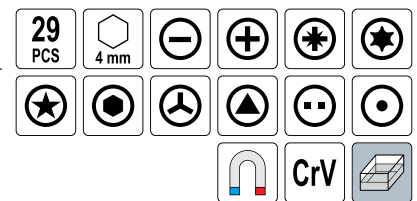

▯ 0.7, 1.0, 1.2, 1.5, 1.8 mm; CrV; ⊕ PH000, PH00, PH0, PH1; CrV; ⊕ PZ000, PZ00, PZ0, PZ1; CrV; ⊕ 0.7, 0.9, 1.3, 1.5, 2.0 mm; CrV; ⊕ T4, T5, T6, T7, T8; CrV; ⊕ 3.0 mm; CrV; ⊕ 3.0 mm; CrV; ⊕ 2.6 mm; CrV; ⊕ 2.0 mm; CrV; ⊕ 1.0 mm; CrV

VOREL

No.	pcs / szt.	
64401	29	12/48

EN Precision screwdriver bits and holder
 PL Zestaw końcówek śrubokrętowych z uchwytem
 DE Schraubendreherbitsatz mit Bithalter
 RU Отвёртка с набором специальных бит
 CZ Sada bitů s držákem
 RO Set șurubelniță cu biți de precizie
 HU Csavarhúzó bit készlet
 ES Juego de destornillador con puntas

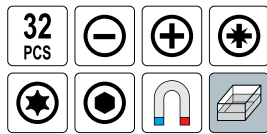

▯ 1/4" (6.3 mm): 1.0, 1.5, 2.0, 2.5, 3.0, 3.5, 4.0 mm;
 ⊕ 1/4" (6.3 mm): PH000, PH00, PH0, PH1;
 ⊕ 1/4" (6.3 mm): PZ0, PZ1;
 ⊕ 1/4" (6.3 mm): T4, T5, T6, T7, T8, T9, T10, T15, T20;
 ○ 1/4" (6.3 mm): 0.7, 0.9, 1.3, 1.5, 2.0, 2.5, 3.0, 4.0 mm



No.	pcs / szt.	
64371	32	10/20

EN Precision screwdriver set
 PL Zestaw wkrętańców precyzyjnych
 DE Präzisions-Schraubendreher-Satz
 RU Набор прецизионных отвёрток

CZ Sada šroubováků pro jemnou mechaniku
 RO Set șurubelnițe de precizie
 HU Órás csavarhúzó készlet
 ES Juego de destornilladores de precisión

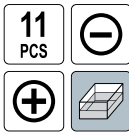

⊖ 0.9, 1.2, 1.4, 1.8, 2.4, 3.0 mm;
 ⊕ PH00, PH0, PH1

No.	pcs / szt.	
64330	11	25/100

EN Precision screwdriver bits and holder
 PL Zestaw końcówek śrubokrętowych z uchwytem
 DE Schraubendreherbitsatz mit Bithalter
 RU Набор инструментов для ремонта мобильных телефонов
 CZ Sada bitů s držákem
 RO Set șurubelniță cu biți de precizie
 HU Csavarhúzó bit készlet
 ES Juego de destornillador con puntas



▯ 1/16" (1.6 mm), 5/64" (2.0 mm), 3/32" (2.4 mm), 1/8" (3.2 mm), 9/64" (3.6 mm), 5/32" (4.0 mm);
 ⊕ PH000, PH00, PH0, PH1, PH2; ○ 0.035" (0.9 mm), 1/16" (1.6 mm), 0.05" (1.8 mm),
 5/64" (2.0 mm), 3/32" (2.4 mm), 1/8" (3.2 mm), 5/32" (4.0 mm); ⊕ T4, T5, T6, T7, T8, T9, T10, T15, T20;
 ☆ 5/64" (2.0 mm); ○ 0.035" (0.9 mm); △ 1/8" (3.2 mm); ⊖ 1/8" (3.2 mm);
 ∴ 7/64" (2.8 mm)



No.	pcs / szt.	
64396	32	10/50

EN Precision screwdriver set
 PL Zestaw wkrętańców precyzyjnych
 DE Präzisions-Schraubendreher-Satz
 RU Набор прецизионных отвёрток

CZ Sada šroubováků pro jemnou mechaniku
 RO Set șurubelnițe de precizie
 HU Órás csavarhúzó készlet
 ES Juego de destornilladores de precisión

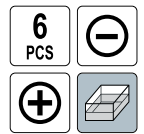

⊖ 1.4, 2.0, 2.4, 3.0 mm;
 ⊕ PH0, PH1

No.	pcs / szt.	
64310	6	20/100

EN Precision screwdriver bits and holder
 PL Zestaw końcówek śrubokrętowych z uchwytem
 DE Schraubendreherbitsatz mit Bithalter
 RU Отвёртка с набором специальных бит
 CZ Sada bitů s držákem
 RO Set șurubelniță cu biți de precizie
 HU Csavarhúzó bit készlet
 ES Juego de destornillador con puntas

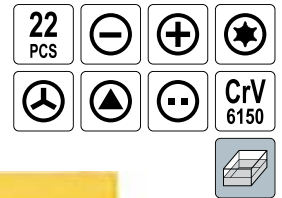

▯ 1/16" (1.6 mm), 5/64" (2.0 mm), 3/32" (2.4 mm), 1/8" (3.2 mm), 5/32" (4.0 mm); ⊕ PH000, PH00, PH0, PH1; ⊕ T5, T6, T7, T8, T9, T10, T15, T20; △ 3.0 mm; ⊖ 3.0 mm; ∴ 2.6 mm;



No.	pcs / szt.	
64395	22	10/50

EN Mobile phone repair tools set
 PL Zestaw do naprawy telefonów komórkowych
 DE Mobiltelefon Reparatur Satz
 RU Набор инструментов для ремонта мобильных телефонов
 CZ Nástroje na opravu mobilních telefonů
 RO Set șurubelnițe service telefoane mobile
 HU Mobiltelefon-javítás szerszámkészlet
 ES Herramientas de la reparación del teléfono móvil fijadas



▯ 1.0, 2.0 mm; CrV; ⊕ PH000, PH00, PH0, PH1; CrV; ⊕ T2, T3, T4, T5, T6, T8, T10; CrV; ⊕ T7, CrV; ○ 1.5, 2.0 mm; CrV; ⊖ Y000, Y00, Y0; CrV; ☆ 0.8 (2 PCS), 1.2, 1.5 mm; CrV; △ 3.0 mm; CrV; 4x75 mm; CrV



No.	pcs / szt.	
64384	32	6/48

EN Precision screwdriver set
 PL Wkrętaki precyzyjne
 DE Präzisions-Schraubendrehersatz
 RU Набор отвёрток для точных работ
 CZ Precizní šroubováky
 RO Set şurubelniţe de precizie
 HU Precíziós csavarhúzó
 ES Destornilladores precisos



No.	Tip size / Rozmiar grotu	pcs / szt.	
64553	1.4, 2.4, 3.0, PH00, PH0, PH1	6	10/60
64554	T5, T6, T7, T8, T9, T10	6	10/60

EN Screwdriver bit set
 PL Zestaw końcówek śrubokrętowych
 DE Schraubendreherbitsatz
 RU Набор битов
 CZ Sada šroubovacích bitů
 RO Set biţi
 HU Csavarbit készlet
 ES Juego de puntas para atornillar



▯ 1/4" (6.3 mm): 5, 6 mm (L=25 mm); CrV; ⚙ 1/4" (6.3 mm): PH0, PH1, PH2 (L=25 mm); CrV;
 ⚙ 1/4" (6.3 mm): PZ1, PZ2 (L=25 mm); CrV; ⚙ 1/4" (6.3 mm): T15, T20 (L=25 mm); CrV;
 ▯ 1/4" (6.3 mm); (L=60 mm); CrV



No.	pcs / szt.	
65705	10	5/80

EN Screwdriver bit set
 PL Zestaw końcówek śrubokrętowych
 DE Schraubendreherbitsatz
 RU Набор битов
 CZ Sada šroubovacích bitů
 RO Set biţi
 HU Csavarbit készlet
 ES Juego de puntas para atornillar



No.	pcs / szt.	
66301	41	10/40

EN Screwdriver bit set
 PL Zestaw końcówek śrubokrętowych
 DE Schraubendreherbitsatz
 RU Набор битов
 CZ Sada šroubovacích bitů
 RO Set biţi
 HU Csavarbit készlet
 ES Juego de puntas para atornillar

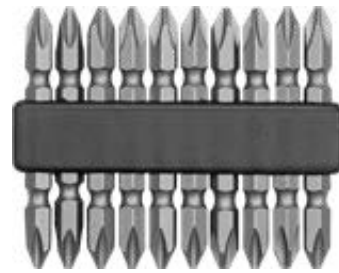

No.		L [mm]	pcs / szt.	
65700	PH2	60	10	25/100

EN Screwdriver bit set
 PL Zestaw końcówek śrubokrętowych
 DE Schraubendreherbitsatz
 RU Набор битов
 CZ Sada šroubovacích bitů
 RO Set biţi
 HU Csavarbit készlet
 ES Juego de puntas para atornillar

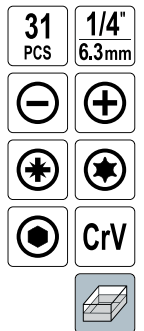

▯ 1/4" (6.3 mm): 3, 4, 5, 5.5, 6, 7 mm (L=25 mm); CrV; ⚙ 1/4" (6.3 mm): PH0, PH1 (2 PCS), PH2 (2 PCS), PH3 (L=25 mm); CrV; ⚙ 1/4" (6.3 mm): PZ0, PZ1 (2 PCS), PZ2 (2 PCS), PZ3 (L=25 mm); CrV; ⚙ 1/4" (6.3 mm): T10, T15, T20, T25, T27, T30 (L=25 mm); CrV; ▯ 1/4" (6.3 mm): 2, 3, 4, 5, 5.5, 6 mm (L=25 mm); CrV; ▯ 1/4" (6.3 mm); (L=60 mm); CrV



No.	pcs / szt.	
66302	31	10/30

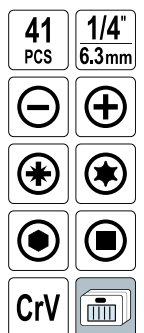

▯ 1/4" (6.3 mm): 3, 4, 5, 5.5, 6, 7 mm (L=25 mm); CrV; ⚙ 1/4" (6.3 mm): PH0, PH1 (2 PCS), PH2 (4 PCS), PH3 (L=25 mm); CrV; ⚙ 1/4" (6.3 mm): PZ0, PZ1 (2 PCS), PZ2 (4 PCS), PZ3 (L=25 mm); CrV; ⚙ 1/4" (6.3 mm): T10, T15, T20, T25, T27, T30, T40 (L=25 mm); CrV; ▯ 1/4" (6.3 mm): 2, 2.5, 3, 4, 5, 5.5, 6 mm (L=25 mm); CrV; ▯ 1/4" (6.3 mm): S0, S1, S2, S3 (L=25 mm); CrV; ▯ 1/4" (6.3 mm); (L=60 mm); CrV

EN Screwdriver bit set
 PL Zestaw końcówek śrubokrętowych
 DE Schraubendreherbitsatz
 RU Набор битов

CZ Sada šroubovacích bitů
 RO Set biți
 HU Csavarbit készlet
 ES Juego de puntas para atornillar



- 1/4" (6.3 mm): 3, 4, 5, 5.5, 6, 7 mm (L=25 mm); 4, 6 mm (L=50 mm); CrV;
- ⊕ 1/4" (6.3 mm): PH0, PH1 (2 PCS), PH2 (5 PCS), PH3 (L=25 mm); PH1, PH2, PH3 (L=50 mm); CrV;
- ⊕ 1/4" (6.3 mm): PZ0, PZ1 (2 PCS), PZ2 (5 PCS), PZ3 (L=25 mm), PZ1, PZ2, PZ3 (L=50 mm); CrV;
- ⊕ 1/4" (6.3 mm): T10, T15, T20, T25, T27, T30, T40 (L=25 mm); T15, T20, T25 (L=50 mm); CrV;
- 1/4" (6.3 mm): 2, 2.5, 3, 4, 5, 5.5, 6 mm (L=25 mm); 4, 5, 6 mm (L=50 mm); CrV;
- 1/4" (6.3 mm): S0, S1, S2, S3 (L=25 mm); CrV

No.	pcs / szt.	Image
66310	56	8/16

EN Screwdriver bit set
 PL Zestaw końcówek śrubokrętowych
 DE Schraubendreherbitsatz
 RU Набор битов
 CZ Sada šroubovacích bitů
 RO Set biți
 HU Csavarbit készlet
 ES Juego de puntas para atornillar

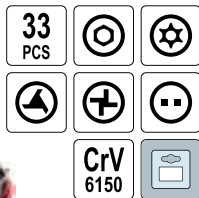

- ⊕ 1/4" (6.3 mm): T8, T10, T15, T20, T25, T27, T30, T35, T40 (L=25 mm); 5/64" (2.0 mm), 3/32" (2.4 mm), 7/64" (2.8 mm), 1/8" (3.2 mm), 9/64" (3.6 mm), 5/32" (4.0 mm) (L=25 mm); 1/4" (6.3 mm): 2, 2.5, 3, 4, 5, 6 mm (L=25 mm); 1/4" (6.3 mm): 1, 2, 3, 4 (L=25 mm); 1/4" (6.3 mm): 6, 8, 10 (L=25 mm); - 1/4" (6.3 mm): 4, 6, 8, 10 (L=25 mm); 1/4" (6.3 mm): (L=60 mm)

No.	pcs / szt.	Image
66330	33	12/60

EN Screwdriver bit set
 PL Zestaw końcówek śrubokrętowych
 DE Schraubendreherbitsatz
 RU Набор битов
 CZ Sada šroubovacích bitů
 RO Set biți
 HU Csavarbit készlet
 ES Juego de puntas para atornillar



- ⊕ T20, T25, T30, T40, T45, T50, T55 (L=30 mm); T20, T25, T30, T40, T45, T50, T55 (L=75 mm);
- 4, 5, 6, 7, 8, 10, 12 mm (L=30 mm); 4, 5, 6, 7, 8, 10, 12 mm (L=75 mm);
- M5, M6, M8, M10, M12 (L=30 mm); M5, M6, M8, M10, M12 (L=75 mm)

No.	pcs / szt.	Image
66410	40	10

EN Screwdriver bit set
 PL Końcówki śrubokrętowe do gipsów
 DE Schraubendreherbitsatz
 RU Насадки для быстрого заворачивания саморезов по гипсокартону
 CZ Koncovky šroubovákové na sádro
 RO Set biți pt. ghips
 HU Csavarhúzóvégek gipszhez
 ES Puntas con limitador



⊕ 1/4" (6.3 mm): PH2 (L=25 mm)

No.	pcs / szt.	Image
65800	2	12/144

EN Screwdriver bit set
 PL Zestaw końcówek śrubokrętowych
 DE Schraubendreherbitsatz
 RU Набор битов

CZ Sada šroubovacích bitů
 RO Set biți
 HU Csavarbit készlet
 ES Juego de puntas para atornillar

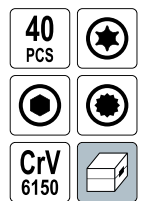

- ⊕ 3/8" (9.5 mm): T20, T25, T30, T40, T45, T50, T55 (L=30 mm); 3/8" (9.5 mm): T20, T25, T30, T40, T45, T50, T55 (L=75 mm);
- 3/8" (9.5 mm): 4, 5, 6, 7, 8, 10, 12 mm (L=30 mm); 3/8" (9.5 mm): 4, 5, 6, 7, 8, 10, 12 mm (L=75 mm);
- 3/8" (9.5 mm): M5, M6, M8, M10, M12 (L=30 mm); 3/8" (9.5 mm): M5, M6, M8, M10, M12 (L=75 mm);
- ⊕ 1/2" (12.7 mm) x 3/8" (9.5 mm), 3/8" (9.5 mm) x 3/8" (9.5 mm)

No.	pcs / szt.	Image
66400	40	10

EN Screwdriver bit set
 PL Zestaw końcówek śrubokrętowych
 DE Schraubendreherbitsatz
 RU Набор битов

CZ Sada šroubovacích bitů
 RO Set biți
 HU Csavarbit készlet
 ES Juego de puntas para atornillar



- ⊕ 3/8" (9.5 mm): T25, T30, T40, T45, T50, T55 (L=30 mm);
- ⊕ 1/2" (12.7 mm) x 3/8" (9.5 mm)

No.	pcs / szt.	Image
66570	7	24/72

EN Screwdriver bit set
 PL Zestaw końcówek śrubokrętowych
 DE Schraubendreherbitsatz
 RU Набор битов
 CZ Sada šroubovacích bitů
 RO Set biți
 HU Csavarbit készlet
 ES Juego de puntas para atornillar



3/8" (9.5 mm): T20, T25, T30, T40, T45, T50, T55 (L=30 mm); 3/8" (9.5 mm): T20, T25, T30, T40, T45, T50, T55 (L=75 mm);
 1/2" (12.7 mm) x 3/8" (9.5 mm)



No.	pcs / szt.	Box icon
66580	15	20

EN Screwdriver bit set
 PL Zestaw końcówek śrubokrętowych
 DE Schraubendreherbitsatz
 RU Набор битов
 CZ Sada šroubovacích bitů
 RO Set biți
 HU Csavarbit készlet
 ES Juego de puntas para atornillar



3/8" (9.5 mm): 4, 5, 6, 7, 8, 10, 12 (L=30 mm); 3/8" (9.5 mm): 4, 5, 6, 7, 8, 10, 12 (L=75 mm); 1/2" (12.7 mm) x 3/8" (9.5 mm)



No.	pcs / szt.	Box icon
66720	15	20

EN Screwdriver bit set
 PL Zestaw końcówek śrubokrętowych
 DE Schraubendreherbitsatz
 RU Набор битов
 CZ Sada šroubovacích bitů
 RO Set biți
 HU Csavarbit készlet
 ES Juego de puntas para atornillar



3/8" (9.5 mm): M5, M6, M8, M10, M12 (L=30 mm); 3/8" (9.5 mm): M5, M6, M8, M10, M12 (L=75 mm);
 1/2" (12.7 mm) x 3/8" (9.5 mm)



No.	pcs / szt.	Box icon
66770	11	20

EN Screwdriver bit set
 PL Zestaw końcówek śrubokrętowych
 DE Schraubendreherbitsatz
 RU Набор битов

CZ Sada šroubovacích bitů
 RO Set biți
 HU Csavarbit készlet
 ES Juego de puntas para atornillar



3/8" (9.5 mm): 4, 5, 6, 8, 10, 12 mm (L=30 mm); 1/2" (12.7 mm) x 3/8" (9.5 mm)



No.	pcs / szt.	Box icon
66710	7	24/72

EN Screwdriver bit set
 PL Zestaw końcówek śrubokrętowych
 DE Schraubendreherbitsatz
 RU Набор битов
 CZ Sada šroubovacích bitů
 RO Set biți
 HU Csavarbit készlet
 ES Juego de puntas para atornillar



3/8" (9.5 mm): M5, M6, M8, M10, M12 (L=30 mm); 1/2" (12.7 mm) x 3/8" (9.5 mm)



No.	pcs / szt.	Box icon
66760	6	24/72

EN Screwdriver bit set
 PL Zestaw końcówek śrubokrętowych
 DE Schraubendreherbitsatz
 RU Набор битов
 CZ Sada šroubovacích bitů
 RO Set biți
 HU Csavarbit készlet
 ES Juego de puntas para atornillar



No.	pcs / szt.	Box icon
66080	7	20/200

EN Screwdriver bit set
 PL Zestaw końcówek śrubokrętowych
 DE Schraubendreherbitsatz
 RU Набор битов

CZ Sada šroubovacích bitů
 RO Set biți
 HU Csavarbit készlet
 ES Juego de puntas para atornillar

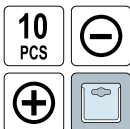

No.	pcs / szt.	
66112	10	25/100

EN Screwdriver bit set
 PL Zestaw końcówek śrubokrętowych
 DE Schraubendreherbitsatz
 RU Набор битов

CZ Sada šroubovacích bitů
 RO Set biți
 HU Csavarbit készlet
 ES Juego de puntas para atornillar



No.	pcs / szt.	
66200	20	12/48

EN Screwdriver bit set
 PL Zestaw końcówek nasadowych
 DE Bit-Steckschlüsselsatz
 RU Набор торцевых головок

CZ Sada nastróných koncovek
 RO Set tubulare de mandrină
 HU Csőkulcskészlet
 ES Juego de puntas de calar

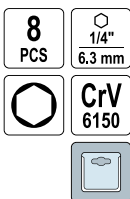

1/4" (6.3 mm): 5, 6, 7, 8, 9, 10, 11, 13 mm; CrV 6150

No.	pcs / szt.	
66113	8	25/50

EN Screwdriver bit set
 PL Zestaw końcówek śrubokrętowych
 DE Schraubendreherbitsatz
 RU Набор битов

CZ Sada šroubovacích bitů
 RO Set biți
 HU Csavarbit készlet
 ES Juego de puntas para atornillar



No.	pcs / szt.	
66210	20	12/48

EN Screwdriver bit holder
 PL Uchwyt do końcówek śrubokrętowych
 DE Bithalter
 RU Адаптер для бит

CZ Držák bitů
 RO Adaptor biți
 HU Bit befogó
 ES Soporte para puntas

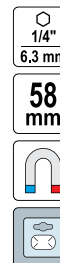

No.		
65850		30/300

EN Angle adapter
 PL Adapter kątowy
 DE Winkelschrauber
 RU Адаптер угловой для бит

CZ Úhel elektrická vrtačka připojení adaptéru
 RO Adaptor unghiular
 HU Sarokcsavarozó adapter
 ES Ángulo magnético bit driver adaptador

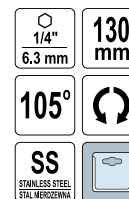

No.		L [mm]	
65840	1/4" (6.3 mm)	130	60

EN T-handle hex key
 PL Klucz sześciokątny typu „T”
 DE Sechskant-Stiftschlüssel mit T-Griff
 RU Ключ шестигранный с Т-образной рукояткой
 CZ Imbusový klíč s T-rukojetí
 RO Cheie hexagonală tip „T”
 HU Imbuskulcs T-markolattal
 ES Llave hexagonal con mango en T

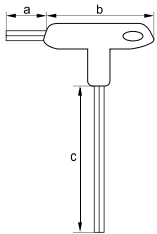
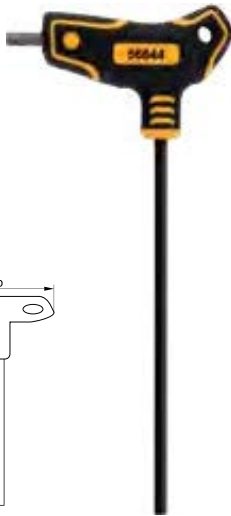

No.	⊙ [mm]	a [mm]	b [mm]	c [mm]	
56640	2.0	10	59	100	24/240
56642	3.0	13	59	100	24/240
56643	4.0	13	76	150	24/192
56644	5.0	14	76	150	24/192
56645	6.0	14	76	150	24/192

EN T-handle hex key set
 PL Zestaw kluczy sześciokątnych typu „T”
 DE Sechskant-Stiftschlüssel-Satz mit T-Griff
 RU Набор ключей шестигранных с Т-образной рукояткой
 CZ Sada imbusových klíčů s T-rukojetí
 RO Set chei hexagonale tip „T”
 HU Imbuskulcs készlet T-markolattal
 ES Juego de llaves hexagonales con mango en T

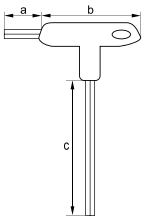

No.	⊙ [mm]	a [mm]	b [mm]	c [mm]	pcs / szt.	
56649	2.5, 3, 4, 5, 6, 7, 8, 10	12, 13, 13, 14, 14, 16, 18, 20	59, 59, 76, 76, 76, 95, 95	100, 100, 150, 150, 150, 200, 200	8	12/24

EN T-handle hex key
 PL Klucz sześciokątny typu „T”
 DE Sechskant-Stiftschlüssel mit T-Griff
 RU Ключ шестигранный с Т-образной рукояткой
 CZ Imbusový klíč s T-rukojetí
 RO Cheie hexagonală tip „T”
 HU Imbuskulcs T-markolattal
 ES Llave hexagonal con mango en T

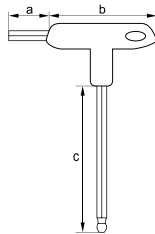
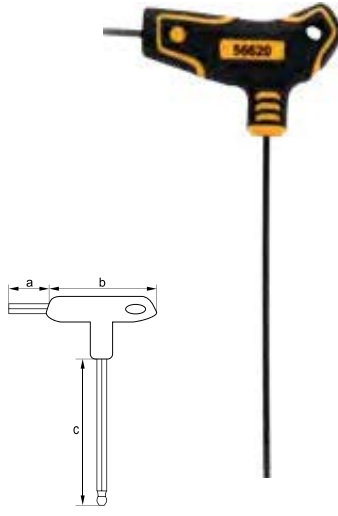

No.	⊙ [mm]	a [mm]	b [mm]	c [mm]	
56622	3.0	13	59	100	24/240
56623	4.0	13	76	150	24/192
56624	5.0	14	76	150	24/192
56625	6.0	14	76	150	24/192

EN T-handle hex key set
 PL Zestaw kluczy sześciokątnych typu „T”
 DE Sechskant-Stiftschlüssel-Satz mit T-Griff
 RU Набор ключей шестигранных с Т-образной рукояткой
 CZ Sada imbusových klíčů s T-rukojetí
 RO Set chei hexagonale tip „T”
 HU Imbuskulcs készlet T-markolattal
 ES Juego de llaves hexagonales con mango en T

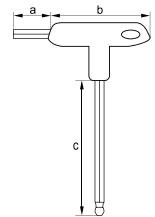

No.	⊙ [mm]	a [mm]	b [mm]	c [mm]	pcs / szt.	
56629	2.5, 3, 4, 5, 6, 7, 8, 10	12, 13, 13, 14, 14, 16, 18, 20	59, 59, 76, 76, 76, 95, 95	100, 100, 150, 150, 150, 200, 200	8	12/24

EN T-handle Torx key
 PL Klucz Torx typu „T”
 DE Torx-Schlüssel mit T-Griff
 RU Ключ Torx с Т-образной рукояткой
 CZ Klíč Torx s T-rukojetí
 RO Cheie Torx tip „T”
 HU T-nyelű Torx kulcs
 ES Llave Torx con mango en T

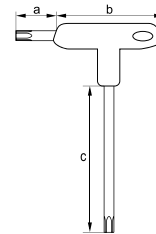

No.	⊙	a [mm]	b [mm]	c [mm]	
56630	T10	10	59	100	24/240
56631	T15	12	59	100	24/240
56632	T20	13	59	100	24/192
56633	T25	13	76	150	24/192
56634	T27	14	76	150	24/192
56635	T30	14	76	150	24/192

EN T-handle Torx key set
 PL Zestaw kluczy Torx typu „T”
 DE T-Griff-Torx-Schlüssel-Satz
 RU Набор ключей Torx с Т-образной рукояткой
 CZ Sada klíčů Torx s T-rukojetí
 RO Set chei Torx tip „T”
 HU T-nyelű Torx kulcs készlet
 ES Juego llaves Torx con mango en T

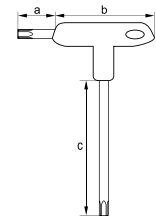

No.	⊙	a [mm]	b [mm]	c [mm]	pcs / szt.	
56639	T10, T15, T20, T25, T27, T30, T40, T45, T50	10, 12, 13, 13, 14, 14, 16, 18, 20	59, 59, 59, 76, 76, 76, 95, 95	100, 100, 100, 150, 150, 150, 200, 200	9	12/24

- EN Hex key
- PL Klucz imbusowy
- DE Sechskant-Stiftschlüssel
- RU Шестигранный ключ
- CZ Imbusový klíč
- RO Cheie imbus
- HU Imbusz kulcs
- ES Llave hexagonal

3



No.	⌀ [mm]	
56040	4	1000/2000
56050	5	400/800
56060	6	400/800
56070	7	300/600
56080	8	200/400
56100	10	100/200
56120	12	50/100
56130	13	50/100
56140	14	50/100
56170	17	25/50

- EN Hex key set
- PL Zestaw kluczy imbusowych
- DE Sechskant-Stiftschlüsselsatz
- RU Набор шестигранных ключей
- CZ Sada imbusových klíčů
- RO Set chei imbus
- HU Imbusz kulcs készlet
- ES Juego de llaves hexagonales



No.	⌀ [mm]	pcs / szt.	
56380	2, 2.5, 3, 4, 5, 6, 8, 10	8	20/100
56390	1.5, 2, 2.5, 3, 4, 5, 6, 7, 8, 10	10	20/100

- EN Hex key set
- PL Zestaw kluczy imbusowych
- DE Sechskant-Stiftschlüsselsatz
- RU Набор шестигранных ключей
- CZ Sada imbusových klíčů
- RO Set chei imbus
- HU Imbusz kulcs készlet
- ES Juego de llaves hexagonales



No.	⌀ [mm]	pcs / szt.	
56393	1.5, 2, 2.5, 3, 4, 5, 5.5, 6, 8, 10	10	10/60

- EN Hex key set
- PL Zestaw kluczy imbusowych
- DE Sechskant-Stiftschlüsselsatz
- RU Набор шестигранных ключей
- CZ Sada imbusových klíčů
- RO Set chei imbus
- HU Imbusz kulcs készlet
- ES Juego de llaves hexagonales



No.	⌀ [mm]	pcs / szt.	
56470	2.5, 3, 4, 5, 6, 8, 10	7	20/40

- EN Hex key set
- PL Zestaw kluczy imbusowych
- DE Sechskant-Stiftschlüsselsatz
- RU Набор шестигранных ключей
- CZ Sada imbusových klíčů
- RO Set chei imbus
- HU Imbusz kulcs készlet
- ES Juego de llaves hexagonales



No.	⌀ [mm]	pcs / szt.	
56391	1.5, 2, 2.5, 3, 3.5, 4, 5, 6, 8, 10	10	20/100
56392	2, 2.5, 3, 4, 5, 6, 8, 10	8	20/100

- EN Hex key set
- PL Zestaw kluczy imbusowych
- DE Sechskant-Stiftschlüsselsatz
- RU Набор шестигранных ключей
- CZ Sada imbusových klíčů
- RO Set chei imbus
- HU Imbusz kulcs készlet
- ES Juego de llaves hexagonales



No.	⌀ [mm]	pcs / szt.	
56400	2, 2.5, 3, 4, 5, 6, 8, 10, 12, 14	10	20/40

- EN Hex key set
- PL Zestaw kluczy imbusowych
- DE Sechskant-Stiftschlüsselsatz
- RU Набор шестигранных ключей
- CZ Sada imbusových klíčů
- RO Set chei imbus
- HU Imbusz kulcs készlet
- ES Juego de llaves hexagonales



No.	⌀ [mm]	pcs / szt.	
56473	1.5, 2, 2.5, 3, 4, 5, 6, 8	8	10/60

EN Hex key set
 PL Zestaw kluczy imbusowych
 DE Sechskant-Stiftschlüsselsatz
 RU Набор шестигранных ключей
 CZ Sada imbusových klíčů
 RO Set chei imbus
 HU Imbuskulcs készlet
 ES Juego de llaves hexagonales

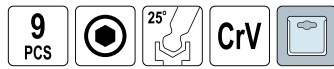

No.	⌀ [mm]	pcs / szt.	
56475	2,5, 3, 4, 5, 5,5, 6, 7, 8, 10	9	10/60

EN Hex key set
 PL Zestaw kluczy imbusowych
 DE Sechskant-Stiftschlüsselsatz
 RU Набор шестигранных ключей
 CZ Sada imbusových klíčů
 RO Set chei imbus
 HU Imbuskulcs készlet
 ES Juego de llaves hexagonales

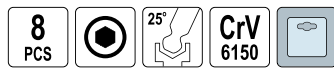

No.	⌀ [mm]	pcs / szt.	
56505	1,5, 2, 2,5, 3, 4, 5, 6, 8	8	25/100

EN Torx key set
 PL Zestaw kluczy Torx
 DE Torx-Stiftschlüsselsatz
 RU Набор ключей Torx
 CZ Sada klíčů Torx
 RO Set de chei Torx
 HU Torx kulcskészlet
 ES Juego de llaves Torx

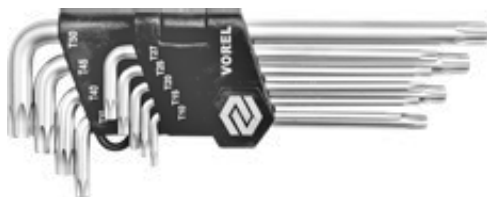

No.	⌀	pcs / szt.	
56478	T10, T15, T20, T25, T27, T30, T40, T45, T50	9	20/40

EN Torx key set
 PL Zestaw kluczy Torx
 DE Torx-Stiftschlüsselsatz
 RU Набор ключей Torx
 CZ Sada klíčů Torx
 RO Set de chei Torx
 HU Torx kulcskészlet
 ES Juego de llaves Torx



No.	⌀	pcs / szt.	
56507	T9, T10, T15, T20, T25, T27, T30, T40	8	25/100

EN Hex key set
 PL Zestaw kluczy imbusowych
 DE Sechskant-Stiftschlüsselsatz
 RU Набор шестигранных ключей
 CZ Sada imbusových klíčů
 RO Set chei imbus
 HU Imbuskulcs készlet
 ES Juego de llaves hexagonales



No.	⌀ [mm]	pcs / szt.	
56477	2, 2,5, 3, 4, 5, 5,5, 6, 8, 10	9	10/60

EN Hex key set
 PL Zestaw kluczy imbusowych
 DE Sechskant-Stiftschlüsselsatz
 RU Набор шестигранных ключей
 CZ Sada imbusových klíčů
 RO Set chei imbus
 HU Imbuskulcs készlet
 ES Juego de llaves hexagonales



No.	⌀ [mm]	pcs / szt.	
56506	1,5, 2, 2,5, 3, 4, 5, 6, 8	8	25/100

EN Torx key set
 PL Zestaw kluczy Torx
 DE Torx-Stiftschlüsselsatz
 RU Набор ключей Torx
 CZ Sada klíčů Torx
 RO Set de chei Torx
 HU Torx kulcskészlet
 ES Juego de llaves Torx



No.	⌀	pcs / szt.	
56600	T10, T10, T15, T20, T25, T27, T30, T40	8	50/100



4

Pliers
Szczypce

CURRENT
PRĄD max 160 A

VORTEX

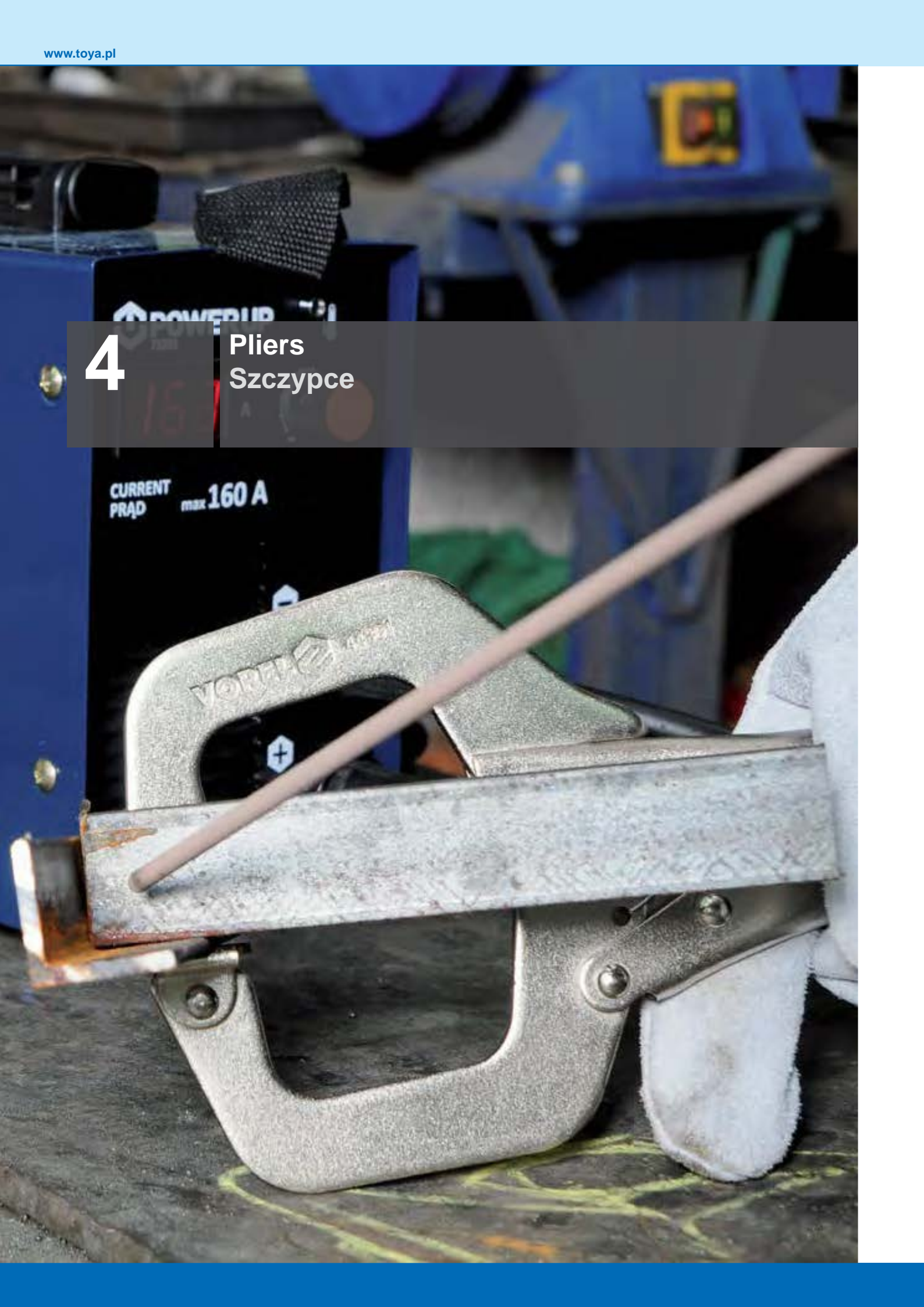

Pliers, heavy duty blue handle Szczypce, uchwyty niebieski



44

Combination pliers

Szczypce uniwersalne..... 44

Side cutting pliers

Szczypce tnące, boczne..... 44

Long nose pliers

Szczypce wydłużone, proste..... 44

Bent nose pliers

Szczypce wydłużone, wygięte..... 44

Pliers, 2 colour handle Szczypce, dwukolorowa rączka



44-45

Combination pliers

Szczypce uniwersalne..... 44

Side cutting pliers

Szczypce tnące, boczne..... 44

Long nose pliers

Szczypce wydłużone, proste..... 44

Bent nose pliers

Szczypce wydłużone, wygięte..... 44

Round nose pliers

Szczypce okrągłe..... 45

Wire stripping pliers

Szczypce do ściągania izolacji..... 45

End cutting pliers

Szczypce tnące, czołowe..... 45

Water pump pliers

Szczypce nastawne..... 45

Chrome plated pliers Szczypce chromowane



45

Water pump pliers

Szczypce nastawne..... 45

Pincers & pliers Szczypce i obcęgi



45

End cutting pliers

Szczypce tnące, czołowe..... 45

Carpenter's pincers

Obcęgi..... 45

Tower pincers

Szczypce tynkarskie..... 45

Pliers „Juco” Szczypce „Juco”



46

Combination pliers

Szczypce uniwersalne..... 46

Side cutting pliers

Szczypce tnące, boczne..... 46

Mini pliers Szczypce „Mini”



46-47

Combination pliers

Szczypce uniwersalne..... 46

Side cutting pliers

Szczypce tnące, boczne..... 46

Long nose pliers

Szczypce wydłużone, proste..... 46

Bent nose pliers

Szczypce wydłużone, wygięte..... 46

Flat nose pliers

Szczypce płaskie..... 46

Round nose pliers

Szczypce okrągłe..... 47

End cutting pliers

Szczypce tnące, czołowe..... 47

Mini pliers sets

Zestawy szczypiec „Mini”..... 47

Circlip pliers Szczypce Segera



47-48

Lock grip pliers & sets Szczypce zaciskowe i zestawy



48-49

EN Combination pliers
 PL Szczypce uniwersalne
 DE Kombinationszange
 RU Плоскогубцы универсальные
 CZ Univerzální kleště
 RO Patent universal
 HU Kombináltfogó
 ES Alicates universal



VOREL

No.	L [mm]	
40010	160	6/60
40011	180	6/60
40012	200	6/60

EN Long nose pliers
 PL Szczypce wydłużone proste
 DE Radiozange gebogen
 RU Тонкогубцы удлиненные прямые
 CZ Prodloužené kleště rovné
 RO Clește cu vârf lung ascuțit
 HU Rádiófogó egyenes
 ES Alicates de punta rectos



VOREL

No.	L [mm]	
40013	160	6/120
40014	200	6/60

EN Combination pliers
 PL Szczypce uniwersalne
 DE Kombinationszange
 RU Плоскогубцы универсальные
 CZ Univerzální kleště
 RO Patent universal
 HU Kombináltfogó
 ES Alicates universal



VOREL

No.	L [mm]	
40041	160	6/60
40042	180	6/60
40043	200	6/60

EN Long nose pliers
 PL Szczypce wydłużone proste
 DE Radiozange gebogen
 RU Тонкогубцы удлиненные прямые
 CZ Prodloužené kleště rovné
 RO Clește cu vârf lung ascuțit
 HU Rádiófogó egyenes
 ES Alicates de punta rectos



VOREL

No.	L [mm]	
40044	160	6/120
40045	180	6/60

EN Diagonal side cutting pliers
 PL Szczypce tnące boczne
 DE Seitenschneider
 RU Бокорезы
 CZ Řezací kleště boční
 RO Clește pt. tăiat lateral
 HU Oldal csípőfogó
 ES Alicates corte lateral



VOREL

No.	L [mm]	
40017	160	6/60
40018	180	6/60

EN Bent nose pliers
 PL Szczypce wydłużone wygięte
 DE Radiozange gerade
 RU Тонкогубцы удлиненные изогнутые
 CZ Prodloužené kleště ohnuté
 RO Patent cu vârf ascuțit îndoit
 HU Rádiófogó hajlított
 ES Alicates de punta curva



VOREL

No.	L [mm]	
40015	160	6/120
40016	200	6/60

EN Diagonal side cutting pliers
 PL Szczypce tnące boczne
 DE Seitenschneider
 RU Бокорезы
 CZ Řezací kleště boční
 RO Clește pt. tăiat lateral
 HU Oldal csípőfogó
 ES Alicates corte lateral



VOREL

No.	L [mm]	
40047	160	6/120
40048	180	6/60

EN Bent nose pliers
 PL Szczypce wydłużone wygięte
 DE Radiozange gerade
 RU Тонкогубцы удлиненные изогнутые
 CZ Prodloužené kleště ohnuté
 RO Patent cu vârf ascuțit îndoit
 HU Rádiófogó hajlított
 ES Alicates de punta curva



VOREL

No.	L [mm]	
40050	160	6/120
40051	180	6/60

EN Round nose pliers
 PL Szczypce okrągłe
 DE Rundzange
 RU Крупоносовые
 CZ Kruhové kleště
 RO Clește rotund
 HU Kerekcsőrű fogó
 ES Alicates redondos

160 mm



VOREL

No.	L [mm]	
40054	160	6/120

EN End cutting pliers
 PL Szczypce tnące czolowe
 DE Vornscheider
 RU Кусачки торцевые
 CZ Kleště štípačí čelní
 RO Clește pt. retezat
 HU Homlokcsípő fogó
 ES Cortacables frontales

160 mm



VOREL

No.	L [mm]	
40055	160	6/60

EN Water pump pliers
 PL Szczypce nastawne
 DE Wasserpumpenzange
 RU Кусачки торцевые
 CZ Nastavitelné kleště
 RO Clește papagal
 HU Állítható fogó
 ES Tenaza ajustable

250 mm



No.	L [mm]	
41500	250	6/60

EN Carpenter's pincers
 PL Obcegi
 DE Kneifzange
 RU Клеши строительные
 CZ Kleště
 RO Clește cuie
 HU Harapófogó
 ES Tenazas

180 mm



VOREL

No.	L [mm]	
41151	180	6/60
41152	200	6/60

EN Wire stripping pliers
 PL Szczypce do ściągania izolacji
 DE Abisolierzange
 RU Клеши для снятия изоляции
 CZ Kleště na sundávání izolace
 RO Decablator
 HU Szigeteléseltávolító fogó
 ES Pinzas pelacables

160 mm



VOREL

No.	L [mm]	
40056	160	6/60

EN Water pump pliers
 PL Szczypce nastawne
 DE Wasserpumpenzange
 RU Кусачки переставные
 CZ Nastavitelné kleště
 RO Clește papagal
 HU Állítható fogó
 ES Tenaza ajustable

250 mm



VOREL

No.	L [mm]	
40057	250	6/60

EN End cutting pliers
 PL Szczypce tnące czolowe
 DE Vornscheider
 RU Кусачки торцевые
 CZ Kleště štípačí čelní
 RO Clește pt. retezat
 HU Homlokcsípő fogó
 ES Cortacables frontales

180 mm



VOREL

No.	L [mm]	
41121	180	6/60

EN Tower pincers
 PL Obcegi tynkarskie
 DE Beisszange
 RU Клеши штукатурные
 CZ Kleště štípačí čelní
 RO Clește pt. cuie
 HU Rabitzfogó
 ES Tenazas de enlucido

250 mm



VOREL

No.	L [mm]	
41381	250	6/60

EN Combination pliers
 PL Szczypce uniwersalne
 DE Kombinationszange
 RU Плоскогубцы универсальные
 CZ Univerzální kleště
 RO Patent universal
 HU Kombináltfogó
 ES Alicates universal

1000 V



JUCO

No.	L [mm]	Voltage / Napiecie [V]	
40160	160	1000	10/50
40180	180	1000	10/50
40200	200	1000	10/50

EN Combination pliers
 PL Szczypce uniwersalne
 DE Kombinationszange
 RU Плоскогубцы универсальные
 CZ Univerzální kleště
 RO Patent universal
 HU Kombináltfogó
 ES Alicates universal

120 mm



VOREL

No.	L [mm]	
42300	120	12/120

EN Long nose pliers
 PL Szczypce wydłużone proste
 DE Radiozange gebogen
 RU Тонкогубцы удлиненные прямые
 CZ Prodloužené kleště rovné
 RO Clește cu vârf lung ascuțit
 HU Rádiófogó egyenes
 ES Alicates de punta rectos

125 mm



VOREL

No.	L [mm]	
42303	125	12/120

EN Bent nose pliers
 PL Szczypce wydłużone wygięte
 DE Radiozange gerade
 RU Тонкогубцы удлиненные изогнутые
 CZ Prodloužené kleště ohnuté
 RO Patent cu vârf ascuțit îndoit
 HU Rádiófogó hajlított
 ES Alicates de punta curva

125 mm



VOREL

No.	L [mm]	
42304	125	12/120

EN Diagonal side cutting pliers
 PL Szczypce tnące boczne
 DE Seitenschneider
 RU Бокорезы
 CZ Řezací kleště boční
 RO Clește pt. tăiat lateral
 HU Oldal csípőfogó
 ES Alicates corte lateral

160 mm 1000 V



JUCO

No.	L [mm]	Voltage / Napiecie [V]	
40700	160	1000	10/10

EN Diagonal side cutting pliers
 PL Szczypce tnące boczne
 DE Seitenschneider
 RU Бокорезы
 CZ Řezací kleště boční
 RO Clește pt. tăiat lateral
 HU Oldal csípőfogó
 ES Alicates corte lateral

110 mm



VOREL

No.	L [mm]	
42301	110	12/120

EN Long nose pliers
 PL Szczypce wydłużone proste
 DE Radiozange gebogen
 RU Тонкогубцы удлиненные прямые
 CZ Prodloužené kleště rovné
 RO Clește cu vârf lung ascuțit
 HU Rádiófogó egyenes
 ES Alicates de punta rectos

150 mm



VOREL

No.	L [mm]	
42305	150	12/120

EN Flat nose pliers
 PL Szczypce płaskie
 DE Flachzange
 RU Плоскогубцы удлиненные
 CZ Kleště ploché
 RO Clește cu vârf ascuțit
 HU Rádiófogó, egyenes
 ES Alicates de bocas planas

120 mm



VOREL

No.	L [mm]	
42306	120	12/120

EN Round nose pliers
 PL Szcypce okrągłe
 DE Rundzange
 RU Круглогубы
 CZ Kruhové kleště
 RO Clește rotund
 HU Kerekcsőrű fogó
 ES Alicates redondos



No.	L [mm]	
42307	125	12/120

EN Mini pliers set
 PL Zestaw miniszczypiec
 DE Mini-Zangensatz
 RU Пассатижи в наборе
 CZ Elektronické kleště
 RO Set mini patenti
 HU Elektronikai fogó
 ES Alicates electronicas



No.	pcs / szt.	
42308	4	25/50

EN Circlip pliers, external straight
 PL Szcypce Segera zewnętrzne proste
 DE Seegeringzange aussen gerade
 RU Съемник стопорных колец (разжим)

CZ Kleště Segera vnější rovné
 RO Clește Seger exterior drept
 HU Segerfogó külső, egyenes
 ES Alicates Seger exteriores de punta



No.	L [mm]	
43050	160	6/60
43055	180	6/60
43060	200	6/60

EN Circlip pliers, internal straight
 PL Szcypce Segera wewnętrzne proste
 DE Seegeringzange innen gerade
 RU Съемник стопорных колец (сжим)

CZ Kleště Segera vnitřní rovné
 RO Clește Seger interior drept
 HU Segerfogó belső, egyenes
 ES Alicates Seger interiores de punta



No.	L [mm]	
43052	160	6/60
43057	180	6/60
43062	200	6/60

EN End cutting pliers
 PL Szcypce tnące czolowe
 DE Vornscheider
 RU Кусачки торцевые
 CZ Kleště štípači čelní
 RO Clește pt. rezezat
 HU Homlokcsípő fogó
 ES Cortacables frontales



No.	L [mm]	
42302	110	12/120

EN Mini pliers set
 PL Zestaw miniszczypiec
 DE Mini-Zangensatz
 RU Пассатижи в наборе
 CZ Elektronické kleště
 RO Set mini patenti
 HU Elektronikai fogó
 ES Alicates electronicas



No.	pcs / szt.	
42309	6	4/40

EN Circlip pliers, external bent
 PL Szcypce Segera zewnętrzne wygięte
 DE Seegeringzange aussen gebogen
 RU Съемник стопорных колец (разжим)

CZ Kleště Segera vnější ohnuté
 RO Clește Seger exterior curbat
 HU Segerfogó külső, hajlított
 ES Alicates Seger exteriores curvos



No.	L [mm]	
43051	160	6/60
43056	180	6/60
43061	200	6/60

EN Circlip pliers, internal bent
 PL Szcypce Segera wewnętrzne wygięte
 DE Seegeringzange innen gebogen
 RU Съемник стопорных колец (сжим)

CZ Kleště Segera vnitřní ohnuté
 RO Patent Seger interior curbat
 HU Segerfogó belső, hajlított
 ES Alicates Seger interiores curvos



No.	L [mm]	
43053	160	6/60
43058	180	6/60
43063	200	6/60

- EN Circlip pliers
- PL Szczypce Segera
- DE Seegering-Zange
- RU Съёмник стопорных колец
- CZ Kleště na pojistné kroužky
- RO Clește Seger
- HU Seegerfogó
- ES Alicates Seger



5
PCS

150
mm

No.	L [mm]	pcs / szt.	Icon
43510	150	5	12/60

- EN Lock grip pliers
- PL Szczypce Morse'a
- DE Gripzange
- RU Зажим ручной
- CZ Kleště Morse'a
- RO Clește autoblocant
- HU Morse fogó
- ES Alicates Morse

250
mm



No.	L [mm]	Icon
44102	250	6/60

- EN Lock grip pliers
- PL Szczypce spawalnicze
- DE Schweisserzange
- RU Клещи зажимные сварочные
- CZ Svářečské kleště
- RO Clește autoblocant pt. sudura
- HU Hegesztő fogó
- ES Alicates de soldar

0-70
mm

275
mm

C
TYPE



No.	L [mm]	Type / Typ	Icon
44300	275	C	6/36

- EN Welding locking pliers „C” type
- PL Szczypce zaciskowe klamrowe typu „C”
- DE Klemm- und Klammerzange vom Typ „C”
- RU Клещи зажимные сварочные
- CZ Kleště sarnosvorné upínací typu „C”
- RO Clește autoblocant cu clemă tip „C”
- HU „C” fogó
- ES Pinzas de tornillo (de apriete) de grapa tipo „C”



VOREL

No.	L [mm]	Type / Typ	Icon
44301	280	C	5/30



- EN Lock grip pliers
- PL Szczypce Morse'a
- DE Gripzange
- RU Зажим ручной
- CZ Kleště Morse'a
- RO Clește autoblocant
- HU Morse fogó
- ES Alicates Morse

250
mm



No.	L [mm]	Icon
44100	250	6/60

- EN Locking pliers set
- PL Zestaw szczypiec Morse'a
- DE Gripzangen-Set
- RU Набор клещей Морса
- CZ Sada kleští siko
- RO Set clesti autoblocanti
- HU Morse fogókészlet
- ES Juego de pinzas morsa

4
PCS

HRC
45-48



L=140, 165, 225 mm;
 L=180 mm

VOREL

No.	L [mm]	pcs / szt.	Icon
44110	140, 165, 185, 225	4	5/20

0-70
mm

280
mm

C
TYPE

EN Lock grip pliers
 PL Szczypce spawalnicze
 DE Schweisserzange
 RU Клещи зажимные сварочные
 CZ Svářečské kleště
 RO Cleste autoblocant pt. sudura
 HU Hegesztő fogó
 ES Alicates de soldar

0-60 mm 225 mm
 U TYPE



No.	L [mm]	Type / Typ	
44400	225	U	6/36

EN Lock grip pliers
 PL Szczypce spawalnicze
 DE Schweisserzange
 RU Клещи зажимные сварочные
 CZ Svářečské kleště
 RO Cleste autoblocant pt. sudura
 HU Hegesztő fogó
 ES Alicates de soldar

0-65 mm 250 mm 95 mm
 SM TYPE



No.	L [mm]	Type / Typ	
44500	250	SM	6/36

EN Mini locking pliers set
 PL Zestaw szczypiec spawalniczych mini
 DE Mini-Schweißzangen-Satz
 RU Набор сварочных мини-клещей
 CZ Sada svařovacích kleští mini
 RO Set mini clești autoblocanti
 HU Mini testcsipesz készlet
 ES Juego de mini pinzas para soldar

4 PCS HRC 45-48



L=110 mm;
 L=125 mm;
 L=130 mm (2 PCS)



No.	L [mm]	pcs / szt.	
44330	110, 125, 130, 130	4	6/24

4

Memo

5

Electrician tools Narzędzia dla elektryków

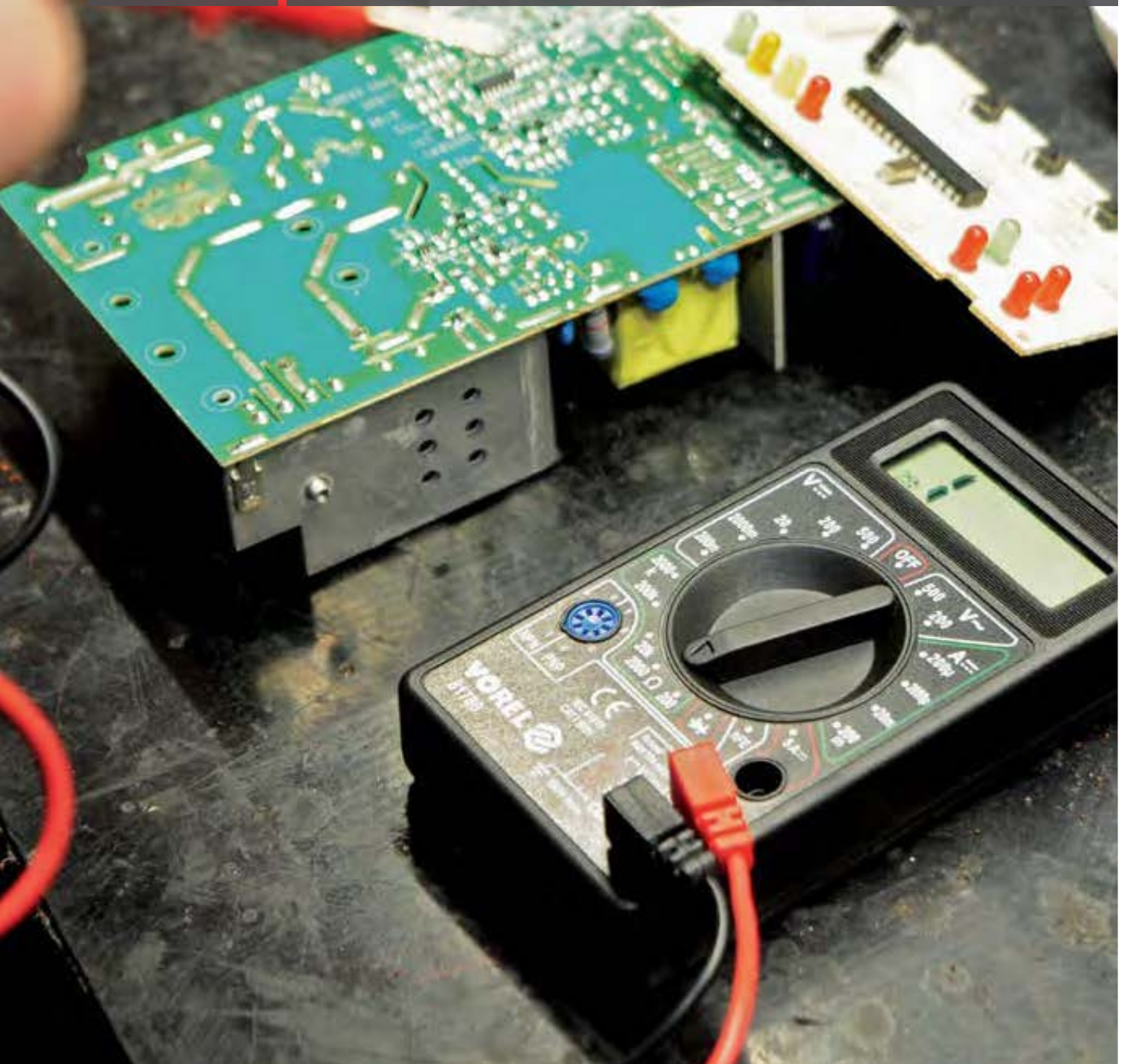

Crimping pliers
 Szczypce do zaciskania
 konektorów

.....52



Wire strippers
 Ściągacze izolacji

.....53



Electrical cutters
 Obcinaki elektryczne

.....53-54



Voltage testers
 Próbniki napięcia

.....54



Digital universal meters
 Cyfrowe mierniki uniwersalne

.....54-55



EN Ratchet crimping pliers
 PL Szczypce do zaciskania konektorów
 DE Kabelschuhzange
 RU Клещи для опрессовки наконечников
 CZ Lisovací kleště na konektory
 RO Clește sertizat conectori
 HU Krimpelő fogó
 ES Pinza crimpadora para conectores



No.	mm ²	AWG	
45500	0.5-2.5	20-14	12/36

EN Ratchet crimping pliers
 PL Szczypce do zaciskania konektorów
 DE Kabelschuhzange
 RU Клещи для опрессовки наконечников
 CZ Lisovací kleště na konektory
 RO Clește sertizat conectori
 HU Krimpelő fogó
 ES Pinza crimpadora para conectores

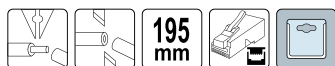

No.	RJ	
45504	RJ45, RJ10, RJ11, 8P, 6P, 4P	10/50

EN Multifunctional pliers with connectors
 PL Szczypce wielofunkcyjne z konektorami
 DE Multifunktionszange mit Kabelschuhe
 RU Клещи многофункциональные для снятия изоляции с наконечниками
 CZ Multifunkční kleště s konektory
 RO Clește multifunctional cu papuci
 HU Multifunkciós fogó csatlakozókkal
 ES Alicates multifuncionales con conectores

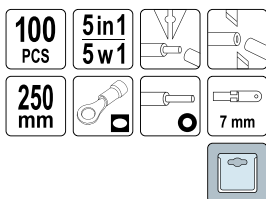

No.	mm ²	AWG	mm ²	AWG	pcs / szt.	
45050	1.5-6.0	22-10	1.5-6.0	22-10	100	25/50

EN Ratchet crimping pliers
 PL Szczypce do zaciskania konektorów
 DE Kabelschuhzange
 RU Клещи для опрессовки наконечников
 CZ Lisovací kleště na konektory
 RO Clește sertizat conectori
 HU Krimpelő fogó
 ES Pinza crimpadora para conectores

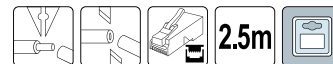

No.	RJ	
45503	RJ45, RJ11	10/40

EN Multifunctional pliers
 PL Szczypce wielofunkcyjne
 DE Multifunktionszange
 RU Клещи многофункциональные для снятия изоляции
 CZ Multifunkční kleště
 RO Clește multifunctional
 HU Multifunkciós fogó
 ES Alicates multifuncionales

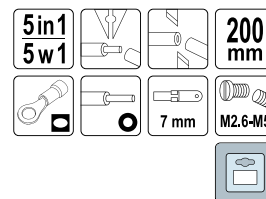

No.	mm ²	AWG	mm ²	AWG	
45000	1.5-6.0	22-10	0.75-6.0	22-10	12/120

EN Multifunctional pliers
 PL Szczypce wielofunkcyjne
 DE Multifunktionszange
 RU Клещи многофункциональные для снятия изоляции
 CZ Multifunkční kleště
 RO Clește multifunctional
 HU Multifunkciós fogó
 ES Alicates multifuncionales

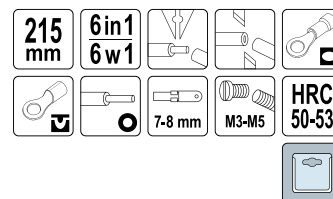

No.	mm ²	AWG	mm ²	AWG	mm ²	AWG	
45012	0.64-2.6	26-10	0.8-2.6	22-10	0.64-2.6	26-10	12/72

EN Wire stripper
 PL Ściągacz izolacji
 DE Abisolierzange
 RU Съёмник изоляции
 CZ Odstraňovač izolace
 RO Decablator
 HU Blankoló fogó
 ES Pelacables

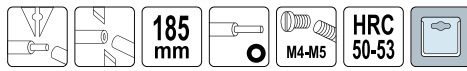

No.	mm ²	AWG	
45010	0.8-2.6	20-10	12/120

EN Automatic wire stripper
 PL Automacyjny ściągacz izolacji
 DE Automatische Abisolierzange
 RU Клещи для удаления изоляции
 CZ Automatický stahovač izolace
 RO Clește decablator automat
 HU Automatikus szigeteléselhúzó
 ES Pelacables automatico



No.	mm ²	AWG	
45151	1.0-3.2	17-12	10/40

EN Automatic wire stripper with cutter
 PL Automacyjny ściągacz z obcinakiem
 DE Automatische Abisolierzange + Schneider
 RU Клещи-автомат для снятия изоляции
 CZ Automatický stahovač izolace
 RO Decablator automat
 HU Automatikus szigeteléselhúzó
 ES Pelacables automatico



No.	mm ²	AWG	
45201	0.5-4.0	20-13	10/50

EN Automatic wire stripper
 PL Automacyjny ściągacz izolacji
 DE Automatische Abisolierzange
 RU Клещи для удаления изоляции
 CZ Automatický stahovač izolace
 RO Clește decablator automat
 HU Automatikus szigeteléselhúzó
 ES Pelacables automatico



No.	mm ²	AWG	
45100	0.5-6.0	20-10	20/100

EN Universal wire stripper
 PL Uniwersalny ściągacz izolacji
 DE Universal Abisolierzange
 RU Универсальный съёмник изоляции
 CZ Univerzální odizolovací kleště
 RO Decablator universal
 HU Blankoló fogó
 ES Extractor de aislado universal

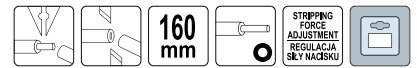

No.	mm ²	AWG	
45160	0.25	30	10/40

EN Electrical cutter
 PL Obcinak elektryczny
 DE Seitenschneider
 RU Диэлектрические бокорезы
 CZ Kleště elektrifikácké
 RO Clește tăietor pt. electroniști
 HU Műszerész oldalsípó fogó
 ES Alicata de corte para electrónica



No.	L [mm]	
45020	135	12/120

EN Electrician's scissors
 PL Nożyczki dla elektryków
 DE Elektriker-Schere
 RU Ножницы электрика
 CZ Nůžky elektrikařské
 RO Foarfecă pt. electricieni
 HU Villanyszerező olló
 ES Tijera de electricista

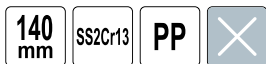

No.	L [mm]	
76320	140	12/120

EN Voltage tester
 PL Próbnik napięcia
 DE Spannungsprüfer
 RU Тестер напряжения
 CZ Zkoušečka napětí
 RO Tester pt. tensiune
 HU Fáziskereső
 ES Probador de corriente

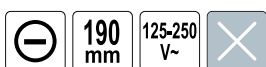

No.	L [mm]	
65235	190	12/600

EN Digital universal multimeter
 PL Cyfrowy miernik uniwersalny
 DE Digital-Multimeter
 RU Универсальный цифровой измеритель
 CZ Digitální multimetr univerzální
 RO Multimetru digital universal
 HU Digitális multiméter
 ES Multimetro digital universal

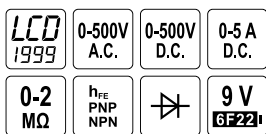

No.		
81780		12/72

EN Voltage tester
 PL Próbnik napięcia
 DE Spannungsprüfer
 RU Тестер напряжения
 CZ Zkoušečka napětí
 RO Tester pt. tensiune
 HU Fáziskereső
 ES Probador de corriente

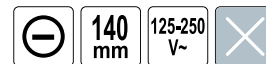

No.	L [mm]	
65233	140	12/1200

EN Digital universal multimeter
 PL Cyfrowy miernik uniwersalny
 DE Digital-Multimeter
 RU Универсальный цифровой измеритель
 CZ Digitální multimetr univerzální
 RO Multimetru digital universal
 HU Digitális multiméter
 ES Multimetro digital universal



No.		
81772		100

EN Digital universal multimeter
 PL Cyfrowy miernik uniwersalny
 DE Digital-Multimeter
 RU Универсальный цифровой измеритель
 CZ Digitální multimetr univerzální
 RO Multimetru digital universal
 HU Digitális multiméter
 ES Multimetro digital universal

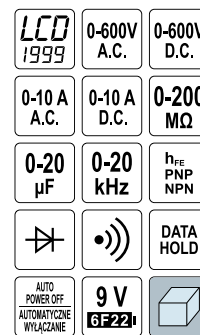

No.	Digit height / Wysokość cyfr [mm]	
81783	25	20

EN Digital universal multimeter
 PL Cyfrowy miernik uniwersalny
 DE Digital-Multimeter
 RU Универсальный цифровой измеритель
 CZ Digitální multimetr univerzální
 RO Multimetru digital universal
 HU Digitális multiméter
 ES Multimetro digital universal



LCD 1999	0-600V A.C.	0-600V D.C.
0-10 A A.C.	0-10 A D.C.	0-200 MΩ
0-20 μF	0-20 kHz	°C -40 +400
h _{FE} PNP NPN	⚡)))
AUTO POWER OFF AUTOMATYCZNE WYŁĄCZANIE	9 V 6F22	📦



No.	Digit height / Wysokość cyfr [mm]	📦
81784	25	20

EN Digital universal multimeter
 PL Cyfrowy miernik uniwersalny
 DE Digital-Multimeter
 RU Универсальный цифровой измеритель
 CZ Digitální multimetr univerzální
 RO Multimetru digital universal
 HU Digitális multiméter
 ES Multimetro digital universal



LCD 1999	0-750V A.C.	0-1000V D.C.
0-20 A A.C.	0-20 A D.C.	0-200 MΩ
0-200 μF	h _{FE} PNP NPN	⚡
)))	DATA HOLD	ADJUSTABLE DISPLAY REGULOWANY WYŚWIETLACZ
AUTO POWER OFF AUTOMATYCZNE WYŁĄCZANIE	9 V 6F22	📦



No.	📦
81775	40

EN Digital universal multimeter
 PL Cyfrowy miernik uniwersalny
 DE Digital-Multimeter
 RU Универсальный цифровой измеритель
 CZ Digitální multimetr univerzální
 RO Multimetru digital universal
 HU Digitális multiméter
 ES Multimetro digital universal



LCD 1999	0-600V A.C.
0-600V D.C.	0-10 A D.C.
0-2 MΩ	h _{FE} PNP NPN
⚡)))
DATA HOLD	LED BACKLIGHT FOSZNETELÉNY
9 V 6F22	📦



No.	📦
81773	50

EN Clamp universal multimeter
 PL Cęgowy miernik uniwersalny
 DE Universal Zangenamperemeter
 RU Универсальные
 токоизмерительные клещи
 CZ Univerzální klešťový multimetr
 RO Multimetru universal cu clemă
 HU Univerzális bilincs multiméter
 ES Multimetro de pinza universal



LCD 1999	0-600V A.C.
0-600V D.C.	0-400A A.C.
0-200 KΩ	⚡
)))	DATA HOLD
2x AAA	📦



No.	📦
81801	5/60



Memo

6

Hammers, chisels, punches & axes Młotki, dłuta, przecinaki i siekiery

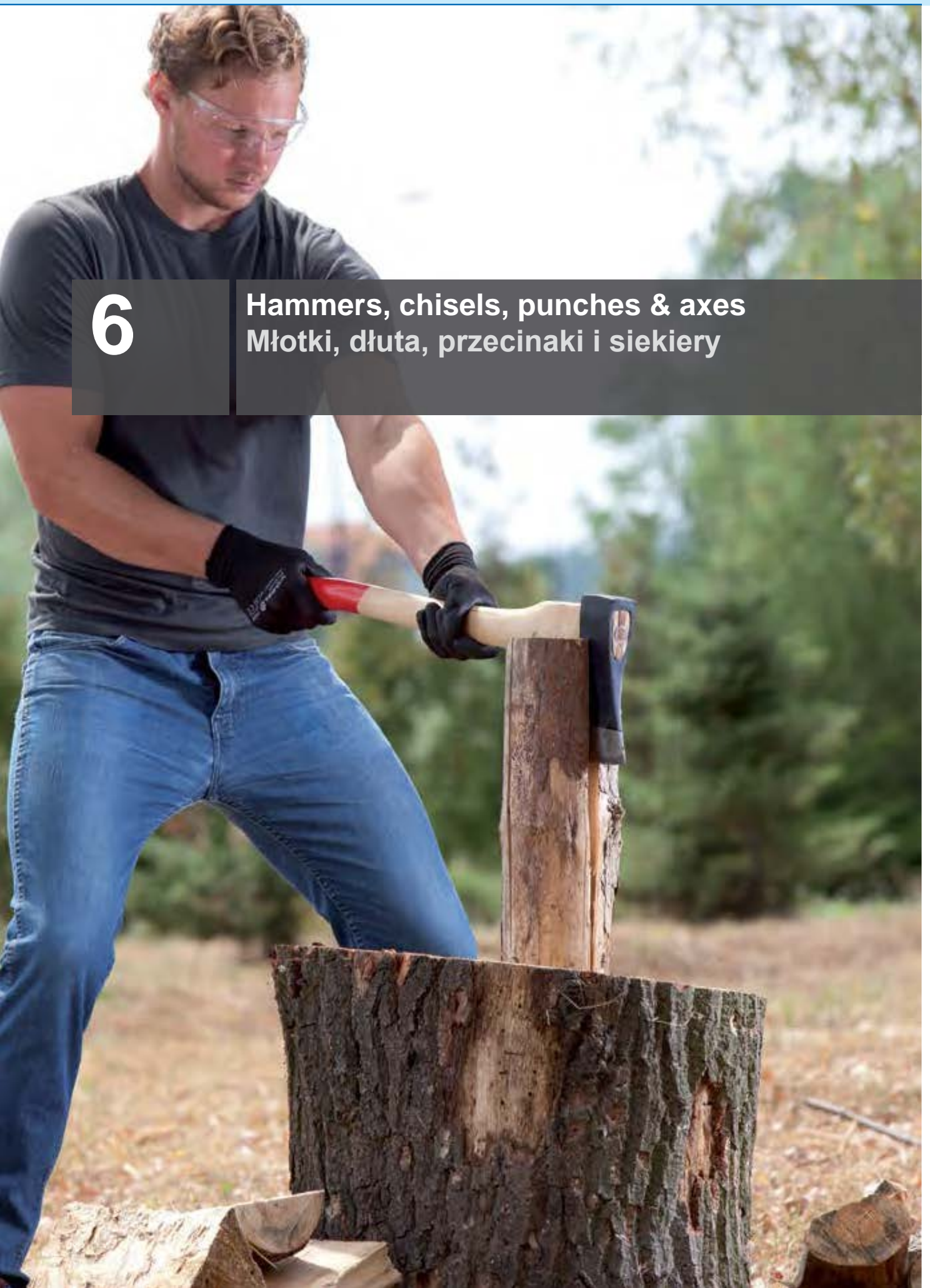

Machinist hammers Młotki ślusarskie



58-59

Machinist hammers with wooden handle

Młotki ślusarskie z rączką drewnianą 58

Machinist hammers with fibreglass handle

Młotki ślusarskie z rączką z włókna szklanego 58

Machinist hammers „Juco”

Młotki ślusarskie „Juco” 58

Brick hammers „Juco”

Młotki murarskie „Juco” 59

Welder's hammers „Juco”

Młotki spawalnicze „Juco” 59

Stoning hammers Młotki kamieniarskie



59

Stoning hammers „Juco”

Młotki kamieniarskie „Juco” 59

Hammers with tubular steel handle Młotki z trzonkiem rurowym



59-60

Claw hammers

Młotki szewskie 59

Roofing hammers

Młotki ciesielskie 60

Mason's hammers

Młotki murarskie 60

Hammers with fibreglass handle Młotki z rączką z włókna szklanego



60

Claw hammers

Młotki szewskie 60

Roofing hammers

Młotki ciesielskie 60

Rubber mallets Młotki gumowe



60-61

Rubber mallets with wooden handle

Młotki gumowe z rączką drewnianą 60

Rubber mallets with tubular steel handle

Młotki gumowe z rączką stalową 60

Rubber mallets with fibreglass handle

Młotki gumowe z rączką z włókna szklanego 61

Soft faced mallets

Młotki blacharskie gumowo-plastykowe 61

Wooden mallets Młotki drewniane



61

Chisels, cold chisels, punches & wrecking bars

Dłuta, przecinaki, przebijaki i łomy



61-63

Wood chisels with wooden handle

Dłuta stolarskie z rączką drewnianą 61

Wood chisels with plastic handle

Dłuta stolarskie z rączką z tworzywa 61

Curving chisels

Dłuta snycerskie 62

Cold chisels

Przecinaki 62

Cold chisels „Juco”

Przecinaki „Juco” 62

Punches

Przebijaki 63

Wrecking bars

Łomy 63

Wrecking bars „Juco”

Łomy „Juco” 63

Axes Siekiery



64-65

Axes with wooden handle

Siekiery z trzonkiem drewnianym 64

Axes with fibreglass handle

Siekiery z trzonkiem z włókna szklanego 64

Axes „Juco”

Siekiery „Juco” 64

Hammer and axe wedges

Zestawy klinujące do młotków i siekier 65

Picaxes Kilofy



66

Pickaxes

Kilofy 66

Wood splitters „Juco”

Kliny do rozłupywania drewna „Juco” 66

EN Machinist hammer
 PL Młotek ślusarski
 DE Schlosserhammer
 RU Молоток слесарный

CZ Zámečnické kladivo
 RO Ciocan de lăcătușerie
 HU Lakatos kalapács
 ES Martillo de cerrajero



No.	m [g]	
30010	100	12/120
30020	200	12/72
30030	300	12/60
30040	400	6/48
30050	500	6/36
30060	600	6/36
30080	800	6/24
30100	1000	6/24
30150	1500	6/12
30200	2000	6/12

EN Machinist hammer
 PL Młotek ślusarski
 DE Schlosserhammer
 RU Молоток слесарный

CZ Zámečnické kladivo
 RO Ciocan de lăcătușerie
 HU Lakatos kalapács
 ES Martillo de cerrajero

DIN
1042



JUCO

No.	m [kg]	
30531	3	1
30532	4	1
30533	5	1
30534	6	1
30535	8	1
30536	10	1

EN Machinist hammer
 PL Młotek ślusarski
 DE Schlosserhammer
 RU Молоток слесарный

CZ Zámečnické kladivo
 RO Ciocan de lăcătușerie
 HU Lakatos kalapács
 ES Martillo de cerrajero

MONOBLOCK
MONOLIT



JUCO

No.	m [g]	
30220	300	5
30222	500	5
30224	700	5

EN Machinist hammer
 PL Młotek ślusarski
 DE Schlosserhammer
 RU Молоток слесарный

CZ Zámečnické kladivo
 RO Ciocan de lăcătușerie
 HU Lakatos kalapács
 ES Martillo de cerrajero



VOREL

No.	m [g]	
30410	100	6/120
30420	200	6/60
30430	300	6/60
30440	400	6/48
30450	500	6/36
30460	600	6/36
30480	800	6/24
30500	1000	6/24
30510	1500	6/12
30520	2000	6/12

EN Machinist hammer
 PL Młotek ślusarski
 DE Schlosserhammer
 RU Молоток слесарный

CZ Zámečnické kladivo
 RO Ciocan de lăcătușerie
 HU Lakatos kalapács
 ES Martillo de cerrajero



VOREL

No.	m [g]	
30310	100	6/120
30320	200	6/36
30330	300	6/36
30340	400	6/36
30350	500	6/36
30360	600	6/36
30380	800	6/24
30390	1000	6/24
30395	1500	6/12
30400	2000	6/12

EN Machinist hammer
 PL Młotek ślusarski
 DE Schlosserhammer
 RU Молоток слесарный

CZ Zámečnické kladivo
 RO Ciocan de lăcătușerie
 HU Lakatos kalapács
 ES Martillo de cerrajero

DIN
1041



JUCO

No.	m [g]	
31050	500	10
31070	700	10
31100	1000	10
31150	1500	6
31200	2000	6

EN Machinist hammer
PL Młotek ślusarski
DE Schlosserhammer
RU Молоток слесарный

CZ Zámečnické kladivo
RO Ciocan de lăcătușerie
HU Lakatos kalapács
ES Martillo de cerrajero

DIN
1042



JUCO

No.	m [g]	
31300	3000	1
31400	4000	1
31500	5000	1
31600	6000	1
31800	8000	1
32000	10000	1

EN Brick hammer
PL Młotek murarski
DE Maurerhammer
RU Молоток каменщика
CZ Kladivo zednické
RO Ciocan de zidărie
HU Kőműves kalapács
ES Martillo de albañil



JUCO

No.	m [g]	
32720	700	5

EN Stoning hammer
PL Młotek kamieniarski
DE Fäustel
RU Молот двухбухтовый

CZ Palička kovová
RO Ciocan pt. zidărie
HU Kőtörő kalapács
ES Martillo de piedra

DIN
6475



JUCO

No.	m [g]	
32202	2000	6
32203	3000	1
32204	4000	1
32205	5000	1
32206	6000	1
32207	8000	1
32208	10000	1

EN Machinist hammer
PL Młotek ślusarski
DE Schlosserhammer
RU Молоток слесарный

CZ Zámečnické kladivo
RO Ciocan de lăcătușerie
HU Lakatos kalapács
ES Martillo de cerrajero

DIN
1041



JUCO

No.	m [g]	
29993	500	5
29994	700	5
29995	1000	5
29996	1500	5
29997	2000	5

EN Welder's hammer
PL Młotek spawalniczy
DE Schweisserhammer
RU Молоток сварщика

CZ Svářečské kladívko
RO Ciocan de sudură
HU Hegesztő kalapács
ES Martillo para soldar



JUCO

No.	m [g]	
32110	350	5

EN Claw hammer
PL Młotek stolarski
DE Klauenhammer
RU Молоток гвоздодер
CZ Tesařské kladivo
RO Ciocan pt. cizmărie
HU Szeghúzó kalapács
ES Martillo carpintero

600
g



VOREL

No.	m [g]	
32625	600	6/24

EN Claw hammer
 PL Młotek stolarski
 DE Klauenhammer
 RU Молоток-гвоздодер
 CZ Tesařské kladivo
 RO Ciocan pt. cizmărie
 HU Szeghúzó kalapács
 ES Martillo carpintero



450 g 365 mm #45 MONOBLOCK MONOLIT

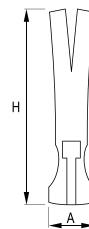

No.	m [g]	L [mm]	A [mm]	H [mm]	
32610	450	365	28x28	140	6/24

6

EN Roofing hammer
 PL Młotek ciesielski
 DE Lattenhammer
 RU Молоток кровельщика

CZ Tesařské kladivo
 RO Ciocan de dulgherie
 HU Ácskalapács
 ES Martillo para techos



No.	m [g]	
32685	600	6/24

EN Masonry hammer, type R
 PL Młotek murarski reński
 DE Maurerhammer, Rheinische Form
 RU Молоток каменщика рейнский

CZ Kladivo zednické rýnské
 RO Ciocan de zidărie tip Rin
 HU Kőműves kalapács Rajnai típusú
 ES Martillo de albañil de Rin

600 g



No.	m [g]	
32715	600	6/24

EN Roofing hammer
 PL Młotek ciesielski
 DE Lattenhammer
 RU Молоток кровельщика

CZ Tesařské kladivo
 RO Ciocan de dulgherie
 HU Ácskalapács
 ES Martillo para techos

600 g



No.	m [g]	
32687	600	6/24

EN Masonry hammer, type B
 PL Młotek murarski berliński
 DE Maurerhammer, Berliner Form
 RU Молоток каменщика берлинский

CZ Kladivo zednické berlínské
 RO Ciocan de zidărie tip Berlin
 HU Kőműves kalapács Berlińi típusú
 ES Martillo de albañil de Berlín

600 g



No.	m [g]	
32705	600	6/24

EN Claw hammer
 PL Młotek stolarski
 DE Klauenhammer
 RU Молоток-гвоздодер

CZ Tesařské kladivo
 RO Ciocan pt. cizmărie
 HU Szeghúzó kalapács
 ES Martillo carpintero

600 g



No.	m [g]	
32627	600	6/24

EN Rubber mallet
 PL Młotek gumowy
 DE Gummihammer
 RU Киянка резиновая

CZ Pryžové kladivo
 RO Ciocan de cauciuc
 HU Gumikalapács
 ES Mazo de goma



No.	Head diameter / Šířka obucha [mm]	
33550	45	36/72
33650	55	12/60
33900	70	12/24

EN Rubber mallet
 PL Młotek gumowy
 DE Gummihammer
 RU Киянка резиновая

CZ Pryžové kladivo
 RO Ciocan de cauciuc
 HU Gumikalapács
 ES Mazo de goma



VOREL

No.	Head diameter / Šířka obucha [mm]	
33557	50	12/60
33657	56	12/48
33907	66	6/24

EN Soft face hammer
 PL Młotek blacharski
 DE Schonhammer
 RU Молоток рихтовочный

CZ Palička klempířská
 RO Ciocan pt. tablă
 HU Bádógos kalapács
 ES Martillo chapista



No.	Head diameter / Šířka obucha [mm]	
33950	35	30/60

EN Wooden mallet
 PL Młotek drewniany blacharski
 DE Holzhammer für Bleche
 RU Молоток жестящика, деревянный

CZ Palice dřevěná klempířská
 RO Ciocan din lemn pt. tinichigerie
 HU Bádógos fakalapács
 ES Martillo de madera de hojalatero



VOREL

No.	L [mm]	
33532	285	20

EN Wood chisel
 PL Dłuto stolarskie
 DE Stechbeitel
 RU Стамеска по дереву
 CZ Dláto tesařské
 RO Daltă de tâmplărie
 HU Asztales véső
 ES Cincel para madera



EN Rubber mallet
 PL Młotek gumowy
 DE Gummihammer
 RU Киянка резиновая

CZ Pryžové kladivo
 RO Ciocan de cauciuc
 HU Gumikalapács
 ES Mazo de goma



VOREL

No.	Head diameter / Šířka obucha [mm]	
33535	45	12/48
33555	50	12/48
33655	56	6/30
33905	66	6/24
33925	76	6/18

EN Carpenter's wooden mallet
 PL Młotek drewniany stolarski
 DE Tischlerhammer aus Holz
 RU Молоток деревянный столярный

CZ Palice dřevěná stolařská
 RO Ciocan din lemn de tâmplar
 HU Asztales fakalapács
 ES Martillo de madera de carpintero



VOREL

No.	L [mm]	
33530	320	20

EN Wood chisel set
 PL Zestaw dłut stolarskich
 DE Stechbeitelsatz
 RU Набор стамесок по дереву

CZ Sada tesařských dlát
 RO Set dălji de tâmplărie
 HU Asztales véső készlet
 ES Juego de cinceles para madera



No.	pcs / szt.	
25500	4	10/40

VOREL

No.	Size / Rozmiar [mm]	
25510	6	5/60
25511	8	5/60
25512	10	5/60
25513	12	5/60
25514	14	5/60
25515	15	5/60
25516	18	5/60
25517	20	5/60
25518	22	5/60
25519	25	5/60
25520	32	5/60
25521	38	5/60



EN Wood chisel set
 PL Zestaw dłut stolarskich
 DE Stechbeitelsatz
 RU Набор стамесок по дереву

CZ Sada tesařských dlát
 RO Set dălți de tâmplărie
 HU Asztalos véső készlet
 ES Juego de cinceles para madera



VOREL

No.	Size / Rozmiar [mm]	pcs / szt.	
25530	6, 12, 18, 24	4	10/40

EN Wood carving chisel set
 PL Zestaw dłut snycerskich
 DE Schnitzmeißel-Set
 RU Набор фигурных стамесок

CZ Sada řezbářských dlát
 RO Set dălți pt. sculptură în lemn
 HU Fafaragó véső készlet
 ES Juego de cinceles para tallado de madera



No.	pcs / szt.	
25700	6	15/60

EN Cold chisel with protection
 PL Przecinak z osłoną
 DE Schlitzmeißel mit Handschutz
 RU Зубило с протектором

CZ Plochý sekáč (z krytem)
 RO Daltă zidărie cu apărătoare
 HU Hidegvágó, lapos (védőfejjel)
 ES Cincel plano (con protector)



VOREL

No.	W [mm]	L [mm]	
35351	25	300	12/36
35352	25	350	10/30
35353	25	400	12/24
35355	25	500	5/20

EN Forged cold chisel
 PL Przecinak ślusarski
 DE Flachmeißel
 RU Зубило слесарное

CZ Zámečnický sekáč
 RO Dalta forjată pt. metal
 HU Lakatos hidegvágó
 ES Cincel de cerrajería

JUCO

No.	Thickness / Grubość [mm]	W [mm]	L [mm]	m [kg]	
35372	10	20	200	0.25	10
35373	12	23	250	0.46	10
35374	12	23	300	0.53	10

EN Wood carving chisel set
 PL Zestaw dłut snycerskich
 DE Schnitzmeißel-Set
 RU Набор фигурных стамесок
 CZ Sada řezbářských dlát
 RO Set dălți pt. sculptură în lemn
 HU Fafaragó véső készlet
 ES Juego de cinceles para tallado de madera



VOREL

No.	pcs / szt.	
25570	12	6/12

EN Cold chisel with protection
 PL Przecinak z osłoną
 DE Schlitzmeißel mit Handschutz
 RU Зубило с протектором

CZ Plochý sekáč (z krytem)
 RO Daltă zidărie cu apărătoare
 HU Hidegvágó, lapos (védőfejjel)
 ES Cincel plano (con protector)



No.	W [mm]	L [mm]	
35250	20	250	12/72
35300	25	300	12/48

EN Cold chisel with protection
 PL Przecinak z osłoną
 DE Schlitzmeißel mit Handschutz
 RU Зубило с протектором

CZ Plochý sekáč (z krytem)
 RO Daltă zidărie cu apărătoare
 HU Hidegvágó, lapos (védőfejjel)
 ES Cincel plano (con protector)



VOREL

No.	Thickness / Grubość [mm]	W [mm]	L [mm]	
35450	18	50	215	6/36
35451	19	75	215	6/36
35452	25	100	215	6/36



EN Octagonal point chisel with protection
 PL Przebijak murarski z osłoną
 DE Spitzmeißel mit Handschutz
 RU Керн с протектором
 CZ Sekáč zednický s ochranným
 RO Dorn cu protecție pt. construcții
 HU Falvészó kézvédővel
 ES Cincel de cerrajería con protector



No.	L [mm]	
35430	300	12/48

EN Wrecking bar
 PL Łom
 DE Nagelisen
 RU Лом

CZ Páčidlo
 RO Rangă
 HU Szögkihúzó
 ES Palanca



VOREL

No.	W [mm]	L [mm]	
34243	18	500	5/10
34245	18	700	10
34247	18	1000	10

EN Square type wrecking bar
 PL Łom kwadratowy, hartowane końcówki
 DE Nagelisen gehärtete Spitze
 RU Лом квадратный с закаленными концами
 CZ Páčidlo hranaté, kalené konce
 RO Rangă pătrată
 HU Négyzetű keresztmetszetű feszítővas, edzett véggel
 ES Palanca



VOREL

No.	Thickness / Grubość [mm]	W [mm]	L [mm]	
34254	12	22	400	12/24
34256	16	30	600	6/12

EN Wrecking bar
 PL Łom
 DE Nagelisen
 RU Лом-гвоздодёр

CZ Páčidlo
 RO Rangă
 HU Szögkihúzó
 ES Palanca



No.	L [mm]	
34600	600	24
34750	750	24
34900	900	24

EN Forged cold chisel with protection
 PL Przecinak murarski z osłoną
 DE Meißel mit Handschutz
 RU Зубило с протектором

CZ Zámečnický sekáč (z krytem)
 RO Dalta forjată cu protecție
 HU Fém hidegvágó, kézvédővel
 ES Cincel de cerrajería mm con protector



JUCO

No.	Thickness / Grubość [mm]	L [mm]	m [kg]	
35359	17	250	0.56	5
35360	17	300	0.65	5
35362	17	350	0.76	5

EN Flat wrecking bar
 PL Łom płaski hartowany
 DE Nagelisen gehärtete Spitze
 RU Лом плоский закаленный

CZ Páčidlo ploché kalené
 RO Rangă plată
 HU Lapos feszítővas
 ES Palanca plana



VOREL

No.	Thickness / Grubość [mm]	W [mm]	L [mm]	
34251	6	35	450	6/24

EN Wrecking bar
 PL Łom
 DE Nagelisen
 RU Лом-гвоздодёр

CZ Páčidlo
 RO Rangă
 HU Szögkihúzó
 ES Palanca



No.	L [mm]	
34300	300	60

EN Wrecking bar
 PL Łom sześciokątny
 DE Brechstange
 RU Лом-гвоздодёр шестигранный

CZ Šestiúhľé páčidlo
 RO Rangă
 HU Hatszögű feszítővas
 ES Palanca hexagonal



JUCO

No.	Thickness / Grubość [mm]	L [mm]	m [kg]	
34204	17	400	0.82	5
34205	17	500	1.1	5
34206	17	600	1.2	5
34207	17	700	1.4	5
34208	17	800	1.6	5
34210	19	1000	2.5	5
34212	19	1200	3	5

EN Wrecking bar CZ Stavební páčidlo
 PL Łom budowlany RO Rangă
 DE Baubrechstange HU Szögkihúzó
 RU Лом круглый ES Palanca



6

JUCO

No.	Ø [mm]	L [mm]	m [kg]	
34220	27	1000	3.6	1
34222	27	1200	4.8	1
34225	27	1500	5.7	1

EN Splitting axe CZ Štípací sekera
 PL Siekiera rozłupująca RO Topor pt. despicat lemne
 DE Spaltaxt HU Hasítófejsze
 RU Топор-колыш ES Hacha de corte



FLO

No.	m [g]	
32930	1000	10

EN Axe CZ Sekera
 PL Siekiera RO Topor
 DE Axt HU Fejsze
 RU Топор ES Hacha



VOREL

No.	m [g]	
33065	600	20
33085	800	20
33105	1000	12
33125	1250	6

EN Axe CZ Sekera
 PL Siekiera RO Topor
 DE Axt HU Fejsze
 RU Топор ES Hacha



FLO

No.	m [g]	
33080	800	12/24

EN Axe CZ Sekera
 PL Siekiera RO Topor
 DE Axt HU Fejsze
 RU Топор ES Hacha



FLO

No.	m [g]	
33067	600	24
33087	800	20
33107	1000	12
33127	1250	12
33147	1400	12
33177	1600	12

EN Axe CZ Sekera
 PL Siekiera RO Topor
 DE Axt HU Fejsze
 RU Топор ES Hacha



JUCO

No.	m [g]	DIN	
33024	400	5131	5
33026	600	5131	5
33028	800	5131	5
33030	1000	5131	5
33032	1250	7294	5
33035	1500	7294	5

EN Axe CZ Sekera
 PL Siekiera RO Topor
 DE Axt HU Fejsze
 RU Топор ES Hacha



JUCO

No.	m [g]	DIN	
33000	400	5131	5
33001	600	5131	5
33002	800	5131	5
33003	1000	5131	5
33004	1250	7294	5
33005	1500	7294	5
33006	1800	7294	5
33007	2000	7294	5
33008	2500	7294	5



6

EN Axe set CZ Sada klasických seker
 PL Zestaw siekier tradycyjnych RO Set topoare
 DE Satz traditioneller Äxte HU Hagymányos balta készlet
 RU Набор традиционных топоров ES Set de hechas tradicionales



JUCO

No.	m [kg]	
32999	0.4, 1.5	5

EN Splitting maul CZ Sekerové kladivo
 PL Siekiero-młot RO Topor cu pană
 DE Spaltaxt HU Hasítófejsze
 RU Топор-копун ES Hacha pesada



JUCO

No.	m [g]	
32927	2100	1
32928	3200	1

EN Canadian axe CZ Sekera kanadská
 PL Siekiera kanadyjska RO Topor canadian
 DE Handbeil „Kanadische Form“ HU Hosszú nyelű, hasító fejsze
 RU Топор канадского типа ES Hacha canada



JUCO

No.	m [g]	
33022	1800	5

EN Splitting axe CZ Štípací sekera
 PL Siekiera rozłupująca RO Topor pt. despiciat lemne
 DE Spaltaxt HU Hasítófejsze
 RU Топор-копун ES Hacha de corte



JUCO

No.	m [g]	
32924	2000	5

EN Splitting maul CZ Sekerové kladivo
 PL Siekiero-młot RO Topor cu pană
 DE Spaltaxt HU Hasítófejsze
 RU Топор-копун ES Hacha pesada



JUCO

No.	m [g]	
32925	2500	1
32926	4000	1

EN Hammer wedges CZ Sada klínků
 PL Zestaw klinujących RO Set pană pt.ciocan
 DE Keilesatz HU Ékelő készlet
 RU Набор клинов ES Juego de sujeción

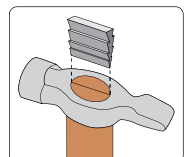

VOREL

No.	pcs / szt.	
99472	10	6/72

EN Hammer wedges
 PL Zestaw klinujący
 DE Keilesatz
 RU Набор клинов
 CZ Sada klínků
 RO Set pană pt.ciocan
 HU Ékelő készlet
 ES Juego de sujeción



JUCO

No.	For hammer / Do młotka [kg]	For axe / Do siekiery	
99460	0.1-0.5	-	50
99461	0.7-2.0	-	50
99462	3.0-4.0	0.4	50

6

EN Pick axe
 PL Kilof bez trzonka
 DE Spitzhacke ohne Stiel
 RU Кирка двухсторонняя без черенка

CZ Násada na krumpáč
 RO Târnăcop fără coadă
 HU Csákánynyél
 ES Palo para pico



VOREL

No.	m [kg]	
32901	2.5	8

EN Pick axe
 PL Kilof oprawiony
 DE Spitzhacke
 RU Кирка двухсторонняя с черенком

CZ Krumpáč osazený
 RO Târnăcop cu coadă
 HU Ékeltszákány
 ES Piqueta



VOREL

No.	m [kg]	
32900	2.5	6

EN Hammer wedges
 PL Zestaw klinujący
 DE Keilesatz
 RU Набор клинов
 CZ Sada klínků
 RO Set pană pt.ciocan
 HU Ékelő készlet
 ES Juego de sujeción



JUCO

No.	For hammer / Do młotka [kg]	For axe / Do siekiery [kg]	
99463	5-6	0.6-1.0	50
99464	8-10	1.2-2.5	50

EN Pick axe handle
 PL Trzonek do kilofa
 DE Stiel für Spitzhacke
 RU Черенок для кирки

CZ Násada na krumpáč
 RO Coadă pt. târnăcop
 HU Csákánynyél
 ES Palo para pico



VOREL

No.	L [cm]	For / Dla	
32902	90	32901	10

EN Wood splitter
 PL Kłjn do rozłupywania drewna
 DE Spaltkeil
 RU Клин для раскалывания бревен

CZ Klín na štípání polen
 RO Pana pt. lemn
 HU Fahasító ék
 ES Cuña para partir madera



JUCO

No.	m [kg]	
32922	2	1
32923	3	1

Memo

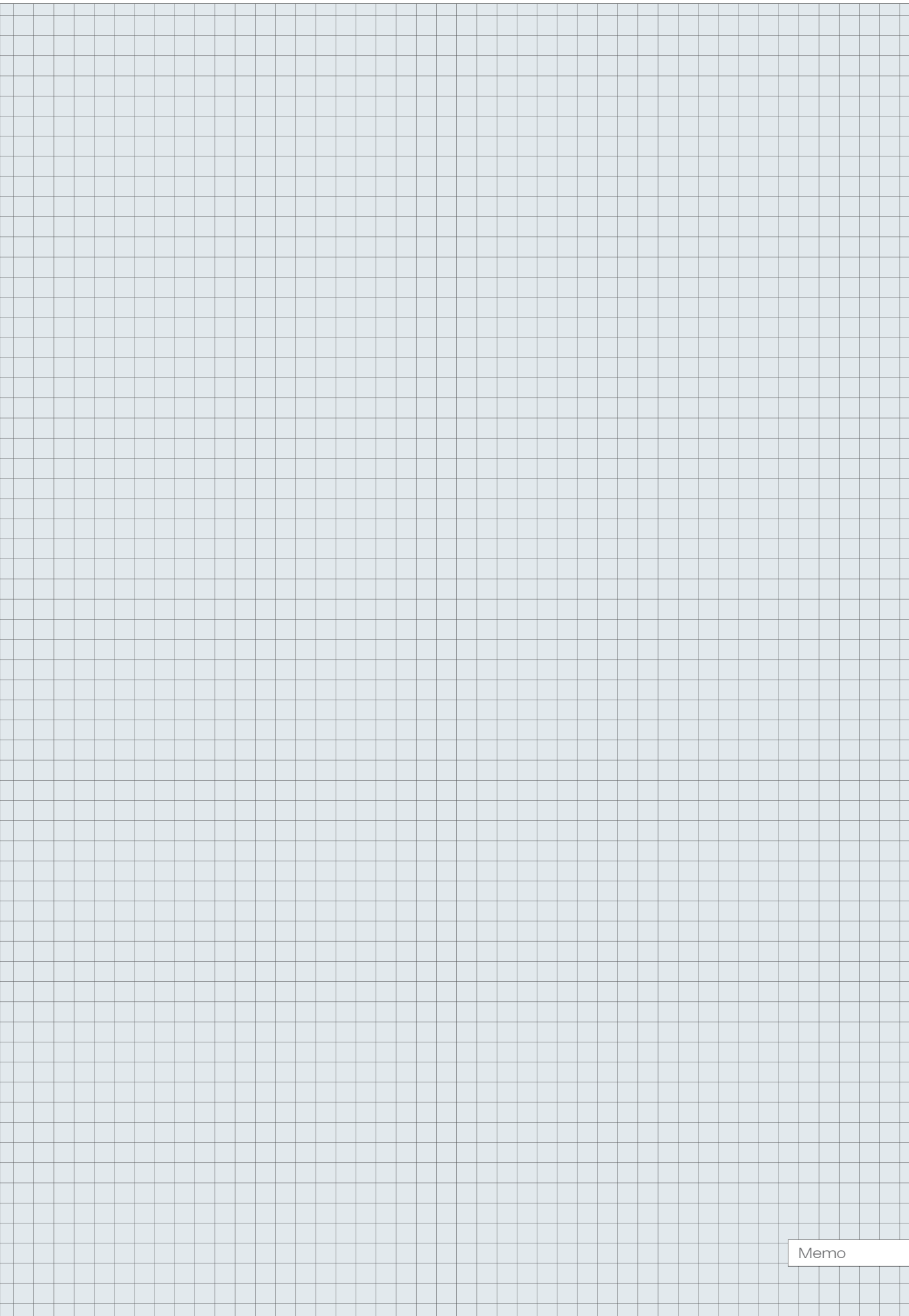

Memo

7

Clamps & vices Ściski i imadła

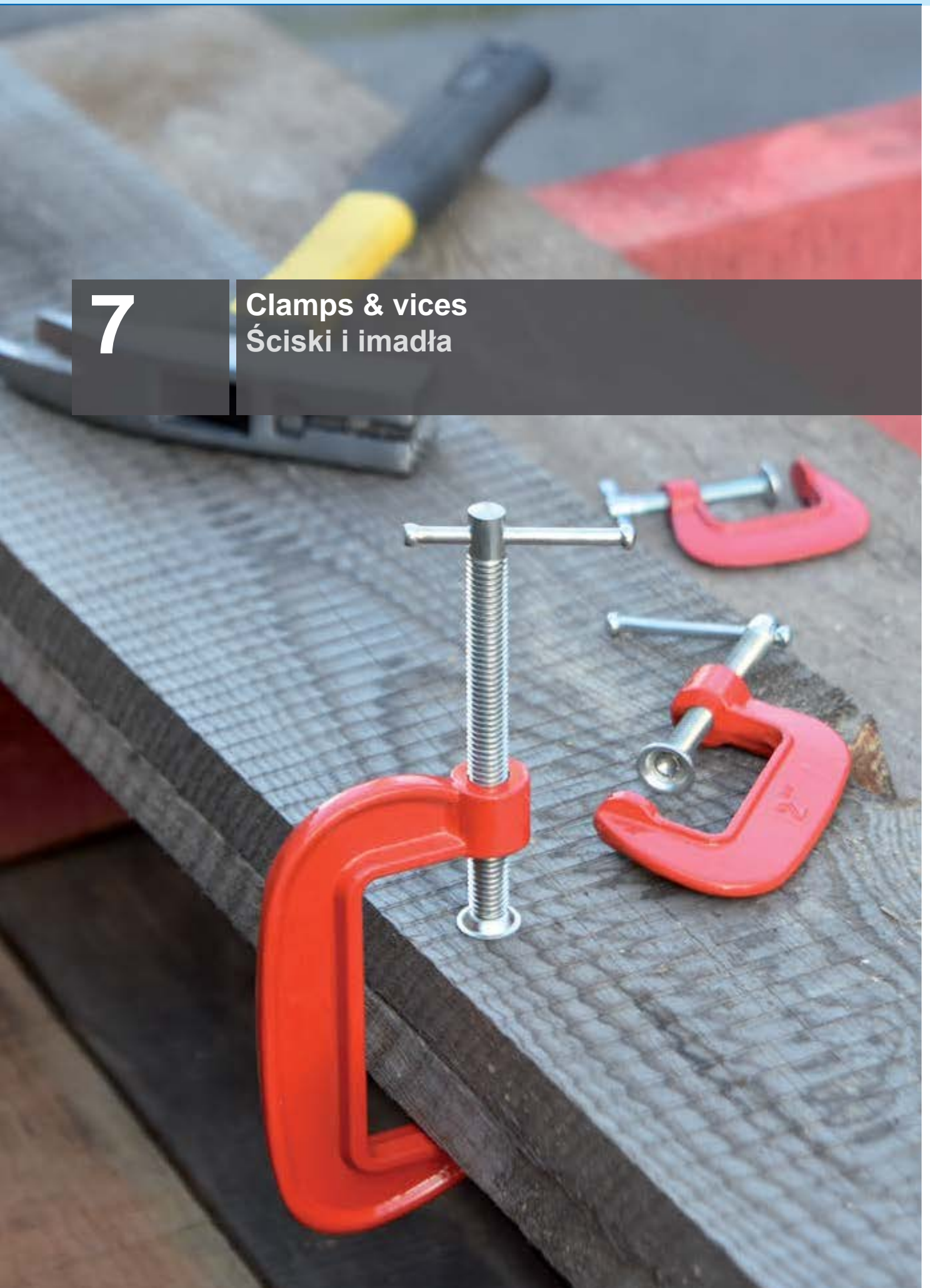

Clamps Ściski



70-72

F-clamps & sets

Ściski stolarskie i zestawy..... 70

Quick release clamps

Ściski szybkozaciskowe..... 70

Battenboard clamps

Ściski do klejenia płyt stolarskich..... 71

Spring clamps

Ściski sprężynowe..... 71

Corner clamps

Ściski kątowe..... 72

Frame clamps

Ściski taśmowe..... 72

C-clamps

Ściski typu „C”..... 72

Ratchet floor clamps

Pasy ściągające do paneli podłogowych..... 72

Vices Imadła



73

Baby vices

Imadła stołowe..... 73

Bench vices

Imadła ślusarskie..... 73

EN F-clamp
 PL Ścisk stolarski
 DE Schraubzwinge
 RU Струбцина столярная
 CZ Truhlářská svěrka
 RO Menghină pt. tâmplărie
 HU Asztalos szorító
 ES Sargento de carpintería



7 VOREL

No.	Size / Rozmiar [mm]	
37100	50x100	12/60
37101	50x150	12/60
37102	50x200	12/60
37103	50x250	12/60
37104	50x300	12/60
37106	80x200	10/30
37107	80x250	10/30
37108	80x300	10/20
37109	80x500	10/20
37110	120x300	10/20
37111	120x500	10
37112	120x800	10
37113	120x1000	6
37114	120x1200	6
37115	120x1500	6

EN F-clamps
 PL Ścisłki stolarskie
 DE Schraubzwingen
 RU Струбцины столярные
 CZ Truhlářské svěrky
 RO Set menghină de tâmplărie
 HU Asztalos szorítók
 ES Sargentos de carpintería



No.	Size / Rozmiar [mm]	pcs / szt.	
38150	50x150	2	10/30
38200	50x200	2	10/30

EN F-clamp
 PL Ścisk stolarski
 DE Schraubzwinge
 RU Струбцина столярная
 CZ Truhlářská svěrka
 RO Menghină pt. tâmplărie
 HU Asztalos szorító
 ES Sargento de carpintería



No.	Size / Rozmiar [mm]	
37150	50x150	12/60
37200	50x200	12/60
37250	50x250	12/60
37300	50x300	12/60
37380	80x300	15/30
37400	80x500	15/30
37430	120x300	10/20
37500	120x500	10/20
37800	120x800	10
37900	120x1000	10

EN Quick release clamp
 PL Ścisk szybkozaciskowy
 DE Schnellklemme
 RU Быстрозажимная струбцина
 CZ Svěrka rychloupínací
 RO Clemă cu prindere rapidă
 HU Gyors asztalos szorító
 ES Apretador rápido



VOREL

No.	L [mm]	Max. expand range / Maks. zasięg rozpięcia [mm]	Max. clamping range / Maks. zasięg ściskania [mm]	Max. jaws depth / Maks. głębokość szczęk [mm]	
38401	150	141-312	0-152	63	12/36
38402	200	141-355	0-203	63	6/36
38403	250	141-405	0-254	63	6/30
38404	300	141-464	0-304	63	6/30
38406	350	141-555	0-355	63	6/24
38407	450	141-617	0-457	63	6/24
38408	600	141-769	0-609	63	6/18
38409	750	141-922	0-762	63	6/12

EN Squeezing clamp
 PL Ścisak z prowadnicą aluminiową do klejenia płyt
 DE Aluminium-Fugzwinge
 RU Струбцина-вайма
 CZ Dverový upínac
 RO Menghina pt. tamplarie
 HU Táblásító szorító
 ES Prensa sargento de aluminio



VOREL

No.	L [mm]	
38642	900	10
38641	1500	10
38643	2400	3/3



EN Pipe clamps
 PL Ścisak do klejenia płyt mocowany na rurze
 DE Holz kleben Rohrschelle
 RU Струбцина трубная
 CZ Trubková zvierka
 RO Menghină de tâmplărie
 HU Végtelen csavaros fém szorító
 ES Prensa sargento para carpintería

3/4"
19mm



VOREL

No.	
38620	12

EN Spring clamp set
 PL Zestaw ścisaków sprężynowych
 DE Federklemme-Satz
 RU Набор зажимов пружинных
 CZ Sada pružinových svěrek
 RO Set cleme arc
 HU Rugós szorító készlet
 ES Juego de pinzas con resorte

2 PCS 150 mm



VOREL

No.	L [mm]	Max. jaws range / Maks. rozwarcie szczęk [mm]	Max. jaws depth / Maks. głębokość szczęk [mm]	pcs / szt.	
38497	150	50	25	2	24/48

EN Spring clamp set
 PL Zestaw ścisaków sprężynowych
 DE Federklemme-Satz
 RU Набор зажимов пружинных
 CZ Sada pružinových svěrek
 RO Set cleme arc
 HU Rugós szorító készlet
 ES Juego de pinzas con resorte

VOREL

No.	L [mm]	Max. jaws range / Maks. rozwarcie szczęk [mm]	pcs / szt.	
38490	50	20	6	36/144

EN Spring clamp
 PL Ścisak sprężynowy
 DE Federklemme
 RU Струбцина пружинная
 CZ Pružinová svěrka
 RO Clește presă
 HU Rugós szorító
 ES Pinza de resorte



No.	L [mm]	
38500	100	24/240
38515	150	12/120
38525	200	10/100

EN Spring clamp set
 PL Zestaw ścisaków sprężynowych
 DE Federklemme-Satz
 RU Набор зажимов пружинных
 CZ Sada pružinových svěrek
 RO Set cleme arc
 HU Rugós szorító készlet
 ES Juego de pinzas con resorte

4 PCS 100 mm



VOREL

No.	L [mm]	Max. jaws range / Maks. rozwarcie szczęk [mm]	pcs / szt.	
38493	100	35	4	24/96



6 PCS

50 mm

20mm



EN Corner clamp
 PL Ścisk stolarski kątowy
 DE Gehrungszwinge
 RU Струбцина угловая
 CZ Truhlářské upínadlo úhlové
 RO Cleste presa colt
 HU Asztalos szorító, sarok
 ES Abrazadera de ángulo



No.	Size / Rozmiar [mm]	
38750	75	10/100

EN Frame clamp
 PL Ścisk taśmowy
 DE Bandzwinge
 RU Ленточный зажим
 CZ Pásová svorka
 RO Cheie cu bandă pt. presat
 HU Szalagos szorító
 ES Tensor de cinta



VOREL

No.	Tape length / Długość taśmy [m]	
38531	4	20

EN C-clamp set
 PL Ściski typu „C”
 DE C-Schraubzwingen-Satz
 RU Набор струбцин C-образных

CZ Sada svěrek typu "C"
 RO Set prese tip „C”
 HU "C" típusú szorítók
 ES Juego de prensas tipo "C"



No.	Jaws range / Rozstaw szczęk [mm]	
38830	25, 50, 75	12/48

EN Corner clamp
 PL Ścisk stolarski kątowy
 DE Gehrungszwinge
 RU Струбцина угловая
 CZ Truhlářské upínadlo úhlové
 RO Cleste presa colt
 HU Asztalos szorító, sarok
 ES Abrazadera de ángulo

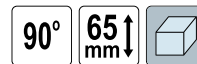

VOREL

No.	Size / Rozmiar [mm]	
38751	65x70	6/12

EN C-clamp
 PL Ścisk typu „C”
 DE C-Schraubzwinge
 RU Струбцина C-образная

CZ Svěrka šroubová tvar "C"
 RO Clemă tip "C"
 HU "C" típusú szorító
 ES Prensa tipo "C"



VOREL

No.	Jaws range / Rozstaw szczęk [mm]	Force pressure / Siła nacisku [kg]	
38430	50	140	50
38431	75	190	50
38432	100	270	30
38433	125	320	20
38434	150	360	18
38435	200	390	10
38436	250	420	6

EN Ratchet floor clamp
 PL Pas ściągający do paneli podłogowych
 DE Spanngurt für Laminatpannele
 RU Ремень для стяжки напольных панелей
 CZ Stahovací pás na podlahní panele
 RO Curea elastică strâns plăci parchet
 HU Padlópanelhez rögzítő pánt
 ES Cinta tirante para placas de suelo



No.	Tape length / Długość taśmy [m]	
82355	5	10/20

EN Baby vice
 PL Imadlo stołowe
 DE Tisch-Schraubstock
 RU Тиски настольные неповоротные
 CZ Stolní svěrák
 RO Menghină de masă
 HU Asztali satu
 ES Tornillo de banco



No.	Jaws width / Szerokość szczęk [mm]	
36000	25	15/60
36004	40	12/48
36005	50	18/36
36006	60	12/24
36008	70	10/20

EN Baby vice with swivel base
 PL Imadlo stołowe obrotowe
 DE Tisch-Schraubstock
 RU Тиски настольные
 CZ Stolní svěrák
 RO Menghină de masă
 HU Asztali satu
 ES Tornillo de banco



No.	Jaws width / Szerokość szczęk [mm]	
36014	40	12/24
36015	50	10/20
36016	60	9/18
36018	75	6/12

EN Baby vice with swivel base
 PL Imadlo stołowe obrotowe
 DE Tisch-Schraubstock
 RU Тиски настольные
 CZ Stolní svěrák
 RO Menghină de masă
 HU Asztali satu
 ES Tornillo de banco



VOREL

No.	Jaws width / Szerokość szczęk [mm]	
36650	65	10

EN Bench vice
 PL Imadlo ślusarskie
 DE Schlosserschraubstock
 RU Тиски слесарные

CZ Zámečnický svěrák
 RO Menghină de lăcătușerie
 HU Lakatos satu
 ES Tornillo de banco



VOREL

No.	Jaws width / Szerokość szczęk [mm]	
36032	100	1
36033	125	1
36034	150	1/1

EN Bench vice with swivel base
 PL Imadlo ślusarskie obrotowe
 DE Schlosserschraubstock drehbar
 RU Тиски слесарные поворотные

CZ Zámečnický svěrák otočný
 RO Menghină de lăcătușerie rotativă
 HU Forgátható lakatos satu
 ES Tornillo de banco giratorio



VOREL

No.	Jaws width / Szerokość szczęk [mm]	
36037	100	1
36038	125	1
36039	150	1

8

Cutting tools Narzędzia tnące



Drill bits Wiertła

77-85

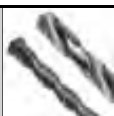

Twist drill bits HSS & sets

Wiertła do metalu HSS i zestawy..... 77

Twist drill bits HSS-G & sets

Wiertła do metalu HSS-G i zestawy..... 78

Step drills & sets

Wiertła stopniowe i zestawy..... 78

Universal drills & sets

Wiertła uniwersalne i zestawy..... 79

Masonry drill bits & sets

Wiertła do betonu i zestawy..... 80

Wood drill bits

Wiertła do drewna..... 80

SDS Masonry drill bits & sets

Wiertła do betonu SDS i zestawy..... 81

SDS Chisels

Przecinaki i dłuta SDS..... 82

Hollow drill sets

Wiertła koronowe do betonu..... 83

Hole saw kits

Zestawy otwornic..... 84

Tungsten carbide hole saws

Otwornice z węglikiem wolframu..... 85

Drills for glass, ceramic tiles & sets

Wiertła do szkła, ceramiki, gresu i zestawy..... 85

Jigs & patterns

Wzorniki i szablony..... 85

Tools for dowel joints

Narzędzia do połączeń kołkowych

86



Taps & dies

Narzędzia do gwintowania

86-88



Hand taps CZ TOOLS

Gwintowniki CZ TOOLS..... 86

Machine taps CZ TOOLS

Gwintowniki maszynowe CZ TOOLS..... 87

Circular dies CZ TOOLS

Narzynki CZ TOOLS..... 87

Tap & die sets CZ TOOLS

Zestawy gwintowników i narzynek CZ TOOLS..... 87

Tap wrenches & die holders

Pokręta do gwintowników i narzynek..... 87

Tap & die sets

Zestawy gwintowników i narzynek..... 88

Screw extractor sets

Wykrętaki do zerwanych śrub..... 88

Router bits, rotary rasps & sets

Frezy do drewna, metalu i zestawy

88



Diamond tools

Narzędzia diamentowe

89-90



Diamond blades for cutting construction materials

Tarcze diamentowe do cięcia materiałów budowlanych..... 89

Diamond rod saws

Brzeszczoty diamentowe..... 90

Tungsten carbide tipped tools

Narzędzia z ostrzem z węglika wolframu

90



Tungsten carbide saws for wood

Tarcze z węglikiem do drewna..... 90

Tungsten carbide saws for aluminium

Tarcze z węglikiem do aluminium..... 90

Cutting & grinding discs

Tarcze do cięcia i szlifowania

90-91



Metal cutting discs

Tarcze do cięcia metalu..... 90

Metal grinding discs

Tarcze do szlifowania metalu..... 91

Stone cutting discs

Tarcze do cięcia kamienia..... 91

Stone grinding discs

Tarcze do szlifowania kamienia..... 91

Flap discs

Ściernice listkowe talerzowe

91



Grinding discs

Tarcze do szlifierek stołowych

91-92



Shears

Nożyce

92-93



Tin snips

Nożyce do blachy..... 92

Bolt cutters

Nożyce do prętów..... 93

Saws & blades

Piły i brzeszczoty

94-101



Hand saws

Piły do drewna..... 94

Bow saws

Piły kabłąkowe..... 95

Bow saw blades

Brzeszczoty do pił kabłąkowych..... 95

Compass saws

Piły otwornice..... 95

Saws for gas concrete

Piły do gazobetonu..... 95

Hacksaw frames

Piły do metalu..... 96

Cross cut saws

Piły poprzeczne..... 97

Miter saws Piły kątowe.....	97
Miter boxes Skrzynki uciosowe.....	98
Blades Brzeszczoty.....	98
Jig saw blades Brzeszczoty do wyrzynarek.....	101

Brushes, knives & files

Szczotki, noże i pilniki

101-115



Wire brushes Szczotki druciane.....	101
Cup brushes Szczotki tarczowe.....	102
Rubber discs Tarcze gumowe do elektronarzędzi.....	103
8 Pocket knives Noże składane.....	105
Window scrapers Skrobaki do szyb.....	109
Glass cutters Nożyki do cięcia szkła.....	109
Marking out tools Narzędzia traserskie.....	109
Scrapers Cykliny.....	109
Wood carving knife sets Zestawy nożyków precyzyjnych.....	109
Scissors Nożyczki.....	109
Leatherwork accessories Akcesoria kaletnicze.....	110
Wood planes Strugi.....	111
Steel files Pilniki do metalu.....	112
Diamond whetstones & sets Osełki diamentowe i zestawy.....	113
Rasps Tarniki do drewna.....	113
Rasps for plaster Tarniki do gipsu.....	114

Abrasive products

Artykuły ściernie

115-117



Sharpening stones Osełki.....	115
Waterproof sand papers Papiery ściernie wodoodporne.....	115
Abrasive clothes Piłótna ściernie.....	115
Abrasive meshes Siatki ściernie.....	116
No end abrasive bands Taśmy ściernie bezkońcowe.....	116
Abrasive sponges Kostki ściernie.....	116
Abrasive discs Krażki ściernie.....	116
Sanding blocks Błoki ściernie.....	117
Polishing sets Zestawy polerskie.....	117

EN Twist drill bit
 PL Wiertło do metalu
 DE Metallspiralbohrer
 RU Сверло по металлу
 CZ Vrták na kov
 RO Burghiu pt. metal
 HU Fúrószár fémhez
 ES Broca para metal



STHOR

No.	Ø [mm]	pcs / szt.	
20100	1.0	10	200/10000
20150	1.5	10	200/8000
20200	2.0	10	200/8000
20250	2.5	10	200/4000
20280	2.8	10	200/4000
20300	3.0	10	200/4000
20320	3.2	10	100/4000
20350	3.5	10	100/4000
20400	4.0	10	100/4000
20420	4.2	10	100/2500
20450	4.5	10	100/2500
20500	5.0	10	100/2500
20550	5.5	10	100/2000
20600	6.0	10	50/1200
20650	6.5	10	50/1200
20700	7.0	10	50/1200
20800	8.0	5	50/600
20850	8.5	5	50/600
20900	9.0	5	50/600
21000	10.0	5	50/250
21100	11.0	5	50/250
21200	12.0	5	50/250
21250	12.5	5	50/250
21300	13.0	5	50/250
21400	14.0	5	50/200
21600	16.0	5	10/100

EN Twist drill set
 PL Zestaw wiertel do metalu
 DE Metall-Spiralbohrer-Satz
 RU Набор сверл по металлу
 CZ Sada vrtáků na kov
 RO Set de burghie pt. metal
 HU Fúrószár készlet fémhez
 ES Juego de brocas para metal



STHOR

No.	Ø [mm]	pcs / szt.	
22330	1, 1.5, 2, 2.5, 3, 3.5, 4, 4.5, 5, 5.5, 6, 6.5, 7, 7.5, 8, 8.5, 9, 9.5, 10	19	30
22340	1, 1.5, 2, 0, 2.5, 3, 0, 3.5, 4, 0, 4.5, 5, 5.5, 6, 6.5, 7, 7.5, 8, 8.5, 9, 9.5, 10, 10.5, 11, 11.5, 12, 12.5, 13	25	20

EN Twist drill set
 PL Zestaw wiertel do metalu
 DE Metall-Spiralbohrer-Satz
 RU Набор сверл по металлу
 CZ Sada vrtáků na kov
 RO Set de burghie pt. metal
 HU Fúrószár készlet fémhez
 ES Juego de brocas para metal



STHOR

No.	Ø [mm]	pcs / szt.	
22130	1.5, 2, 2.5, 3, 3.2, 3.5, 4, 4.5, 4.8, 5, 5.5, 6, 6.5	13	25/100
22180	2, 2.5, 3, 3.5, 4, 4.5, 5, 5.5, 6, 6.5, 7, 7.5, 8	13	25/50

EN Twist drill set
 PL Zestaw wiertel do metalu
 DE Metall-Spiralbohrer-Satz
 RU Набор сверл по металлу
 CZ Sada vrtáků na kov
 RO Set de burghie pt. metal
 HU Fúrószár készlet fémhez
 ES Juego de brocas para metal

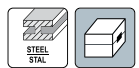

STHOR

No.	Ø [mm]	pcs / szt.	
22190	1, 1.5, 2, 2.5, 3, 3.5, 4, 4.5, 5, 5.5, 6, 6.5, 7, 7.5, 8, 8.5, 9, 9.5, 10	19	30
22250	1, 1.5, 2, 2.5, 3, 3.5, 4, 4.5, 5, 5.5, 6, 6.5, 7, 7.5, 8, 8.5, 9, 9.5, 10, 10.5, 11, 11.5, 12, 12.5, 13	25	20

EN Twist drill set
 PL Zestaw wiertel do metalu
 DE Metall-Spiralbohrer-Satz
 RU Набор сверл по металлу
 CZ Sada vrtáků na kov
 RO Set de burghie pt. metal
 HU Fúrószár készlet fémhez
 ES Juego de brocas para metal

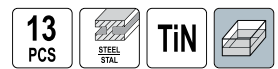

STHOR

No.	Ø [mm]	pcs / szt.	
22300	1.5, 2.0, 2.5, 3.0, 3.2, 3.5, 4.0, 4.5, 4.8, 5.0, 5.5, 6.0, 6.5	13	25/100
22310	2.0, 2.5, 3.0, 3.5, 4.0, 4.5, 5.0, 5.5, 6.0, 6.5, 7.0, 7.5, 8.0	13	25/50

8

- EN HSS twist drill bit
- PL Wiertło do metalu HSS
- DE Metallspiralbohrer HSS
- RU Сверло по металлу HSS
- CZ Vrták na kov HSS
- RO Burghiu pt. metal HSS
- HU Fúrószár fémhez HSS
- ES Broca para metal HSS



STHOR

No.	Ø [mm]	pcs / szt.	Box
21900	1.0	10	20/1000
21905	1.5	10	20/1000
21910	2.0	10	20/800
21915	2.5	10	20/800
21919	3.0	10	20/500
21921	3.2	10	20/400
21924	3.5	10	20/400
21927	4.0	10	10/400
21929	4.2	10	10/250
21932	4.5	10	10/250
21934	4.8	10	10/250
21936	5.0	10	10/250
21941	5.5	10	10/200
21944	6.0	10	10/120
21948	6.5	10	5/120
21950	7.0	5	10/120
21951	7.5	5	10/120
21952	8.0	5	10/120
21955	8.5	5	10/120
21956	9.0	5	10/120
21958	10.0	5	10/50
21961	11.0	5	10/50
21963	12.0	5	10/50
21966	13.0	3	16/48

- EN Step drill
- PL Wiertło stopniowe
- DE Stufenbohrer
- RU Сверло ступенчатое
- CZ Stupňovitý vrták
- RO Burghiu în trepte
- HU Lépcsős fúró
- ES Broca cónica escalonada

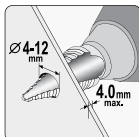

STHOR

No.	Ø [mm]	Box
22610	4, 6, 8, 10, 12	25/200

- EN Twist drill set
- PL Zestaw wiertel do metalu
- DE Metall-Spiralbohrer-Satz
- RU Набор сверл по металлу
- CZ Sada vrtáků na kov
- RO Set de burghie pt. metal
- HU Fúrószár készlet fémhez
- ES Juego de brocas para metal

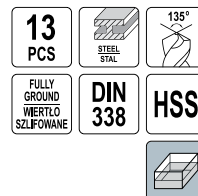

STHOR

No.	Ø [mm]	pcs / szt.	Box
21998	2, 2.5, 3, 3.5, 4, 4.5, 5, 5.5, 6, 6.5, 7, 7.5, 8	13	10/50

- EN Twist drill set
- PL Zestaw wiertel do metalu
- DE Metall-Spiralbohrer-Satz
- RU Набор сверл по металлу
- CZ Sada vrtáků na kov
- RO Set de burghie pt. metal
- HU Fúrószár készlet fémhez
- ES Juego de brocas para metal

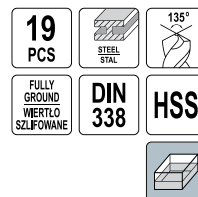

STHOR

No.	Ø [mm]	pcs / szt.	Box
21999	1, 1.5, 2, 2.5, 3, 3.5, 4, 4.5, 5, 5.5, 6, 6.5, 7, 7.5, 8, 8.5, 9, 9.5, 10	19	5/30

- EN Twist drill set
- PL Zestaw wiertel do metalu
- DE Metall-Spiralbohrer-Satz
- RU Набор сверл по металлу
- CZ Sada vrtáků na kov
- RO Set de burghie pt. metal
- HU Fúrószár készlet fémhez
- ES Juego de brocas para metal

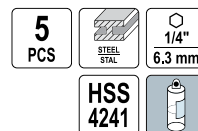

STHOR

No.	Ø [mm]	pcs / szt.	Box
21650	4, 5, 6, 8, 10	5	30/60

- EN Step drill
- PL Wiertło stopniowe
- DE Stufenbohrer
- RU Сверло ступенчатое
- CZ Stupňovitý vrták
- RO Burghiu în trepte
- HU Lépcsős fúró
- ES Broca cónica escalonada

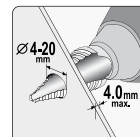

STHOR

No.	Ø [mm]	Box
22611	4, 6, 8, 10, 12, 14, 16, 18, 20	25/100

EN Step drill
 PL Wiertło stopniowe
 DE Stufenbohrer
 RU Сверло ступенчатое
 CZ Stupňovitý vrták
 RO Burghiu in trepte
 HU Lépcsős fúró
 ES Broca cónica escalonada

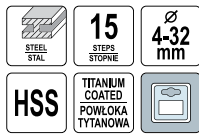

STHOR

No.	Ø [mm]	
22612	4, 6, 8, 10, 12, 14, 16, 18, 20, 22, 24, 26, 28, 30, 32	10/80

EN Step drill set
 PL Zestaw wiertel stopniowych
 DE Stufenbohrer Set
 RU Набор ступенчатых сверл
 CZ Sada stupňovitých vrtáků
 RO Set burghie in trepte
 HU Lépcsős fúró készlet
 ES Juego de brocas cónicas escalonadas

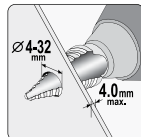
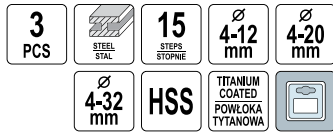

STHOR

No.	Ø [mm]	
22616	4-12 (4, 6, 8, 10, 12 mm), 4-20 (4, 6, 8, 10, 12, 14, 16, 18, 20, 22, 24, 26, 28, 30, 32 mm), 4-32 (4, 6, 8, 10, 12, 14, 16, 18, 20, 22, 24, 26, 28, 30, 32 mm)	20

EN Universal drills
 PL Zestaw wiertel uniwersalnych
 DE Universalbohrer-Set
 RU Набор универсальных сверл
 CZ Sada víceúčelových vrtáků
 RO Set burghie universale
 HU Keményfém többcélyú fúró készlet
 ES Sets de brocas multimaterial

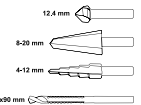

STHOR

No.	pcs / szt.	
22640	4	25/100

EN Step drill
 PL Wiertło stopniowe
 DE Stufenbohrer
 RU Сверло ступенчатое
 CZ Stupňovitý vrták
 RO Burghiu in trepte
 HU Lépcsős fúró
 ES Broca cónica escalonada



STHOR

No.	Ø [mm]	
22613	4, 6, 9, 12, 15, 18, 21, 24, 27, 30, 33, 36, 39	10/40

EN Step drill set
 PL Zestaw wiertel stopniowych
 DE Stufenbohrer Set
 RU Набор ступенчатых сверл
 CZ Sada stupňovitých vrtáků
 RO Set burghie in trepte
 HU Lépcsős fúró készlet
 ES Juego de brocas cónicas escalonadas

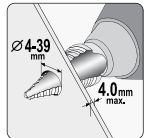
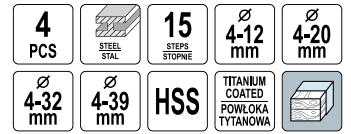

STHOR

No.	Ø [mm]	
22617	4-12 (4, 6, 8, 10, 12 mm), 4-20 (4, 6, 8, 10, 12, 14, 16, 18, 20, 22, 24, 26, 28, 30, 32 mm), 4-32 (4, 6, 8, 10, 12, 14, 16, 18, 20, 22, 24, 26, 28, 30, 32 mm), 4-39 (4, 6, 9, 12, 15, 18, 21, 24, 27, 30, 33, 36, 39 mm)	20

EN Universal drill
 PL Wiertło uniwersalne
 DE Universalbohrer
 RU Универсальное сверло
 CZ Víceúčelový vrták
 RO Burghiu universal
 HU Kőzet és többcélyú fúró
 ES Broca multimaterial

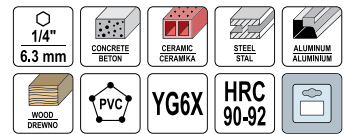

STHOR

No.	Ø [mm]	L [mm]	
21686	6	110	100/400
21688	7	110	100/400
21690	8	120	100/400
21691	10	120	50/200
21692	12	150	50/200

- EN Masonry drill bit set
- PL Zestaw wiertel do betonu
- DE Betonbohrer-Satz
- RU Набор сверел по бетону
- CZ Sada vrtáků do betonu
- RO Set de burghie pt. beton
- HU Fúrókészlet betonhoz
- ES Juego brocas para hormigón

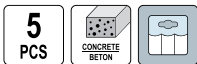

STHOR

8

No.	Ø [mm]	pcs / szt.	
23331	4, 5, 6, 8, 10	5	50/200

- EN Wood drill set
- PL Wiertła do drewna
- DE Holzbohrersatz
- RU Набор сверел по дереву
- CZ Vrtáky do dřeva
- RO Set burghie pt. lemn
- HU Fafúrószár készlet
- ES Brocas para madera



No.	Ø [mm]	pcs / szt.	
22350	4, 5, 6, 8, 10	5	25/200

- EN Wood drill set
- PL Wiertła do drewna
- DE Holzbohrersatz
- RU Набор сверел по дереву
- CZ Vrtáky do dřeva
- RO Set burghie pt. lemn
- HU Fafúrószár készlet
- ES Brocas para madera



STHOR

No.	Ø [mm]	pcs / szt.	
22381	3, 4, 5, 6, 7, 8, 9, 10	8	10/80

- EN Masonry drill bit
- PL Wiertło do betonu
- DE Betonbohrer
- RU Сверло по бетону
- CZ Vrták na beton
- RO Burghiu pt. beton
- HU Fúrószár betonhoz
- ES Broca para hormigón

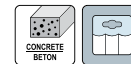

STHOR

No.	Ø [mm]	L [mm]	
23311	4	75	200/1600
23312	5	85	200/1600
23313	6	100	200/1000
23315	8	120	100/500
23325	8	400	50/200
23316	10	120	100/500
23326	10	400	50/100
23317	12	150	50/250
23327	12	400	50/100
23318	14	150	50/150

- EN Wood drill set
- PL Wiertła do drewna
- DE Holzbohrersatz
- RU Набор сверел по дереву
- CZ Vrtáky do dřeva
- RO Set burghie pt. lemn
- HU Fafúrószár készlet
- ES Brocas para madera

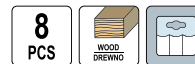

STHOR

No.	Ø [mm]	pcs / szt.	
22380	3, 4, 5, 6, 7, 8, 9, 10	8	20/100

- EN Wood drill set
- PL Wiertła do drewna
- DE Holzbohrersatz
- RU Набор сверел по дереву
- CZ Vrtáky do dřeva
- RO Set burghie pt. lemn
- HU Fafúrószár készlet
- ES Brocas para madera



STHOR

No.	Ø [mm]	L [mm]	pcs / szt.	
22460	6, 8, 10, 12, 13, 14	300	6	25

EN Wood drill set
 PL Wiertła do drewna
 DE Holzbohrersatz
 RU Набор сверел по дереву
 CZ Vrtáky do dřeva
 RO Set burghie pt. lemn
 HU Fafűrőszár készlet
 ES Brocas para madera



STORZ

No.	Ø [mm]	L [mm]	pcs / szt.	
22465	10, 12, 14, 16, 18, 20	230	6	10

EN Flat wood bits
 PL Wiertła łopatkowe do drewna
 DE Holz-Flachfräsbohrersatz
 RU Набор сверел по дереву
 CZ Vrtáky do dřeva
 RO Set burghie plate pt. lemn
 HU Fafűrőszár készlet
 ES Brocas para madera



No.	Ø [mm]	pcs / szt.	
22500	10, 12, 16, 18, 20, 25	6	10/100

EN Wood splitting drill bit
 PL Wiertło do rozłupywania drewna
 DE Holzspaltbohrer
 RU Сверло для раскалывания дров
 CZ Vrták na štípání dřeva
 RO Burghiu pt. despicat lemn
 HU Fahasító kúp
 ES Broca para cortar leña



STORZ

No.	Ø [mm]	pcs / szt.	
22590	32	3	5/50
22591	45	3	4/20

EN Hand gimlet set
 PL Zestaw świderków ręcznych
 DE Handbohrer
 RU Бурав по дереву
 CZ Nebožez kovový
 RO Set ștrele
 HU Kézi fűrő
 ES Broca manual



VOREL

No.	Ø [mm]	pcs / szt.	
22431	2, 3, 4, 5	4	20/200

EN Wood drill set
 PL Wiertła do drewna
 DE Holzbohrersatz
 RU Набор сверел по дереву
 CZ Vrtáky do dřeva
 RO Set burghie pt. lemn
 HU Fafűrőszár készlet
 ES Brocas para madera

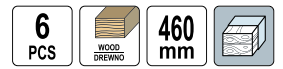

STORZ

No.	Ø [mm]	L [mm]	pcs / szt.	
22466	10, 12, 14, 16, 18, 20	460	6	10

EN Masonry drill bit
 PL Wiertło do betonu
 DE Betonbohrer
 RU Бур по бетону
 CZ Vrták na beton
 RO Burghiu pt. beton
 HU Fűrőszár betonhoz
 ES Broca para hormigón



STORZ

No.	Ø [mm]	L [mm]	
23620	5	110	10/500
23640	6	110	10/500
23650	6	160	10/500
23660	6	210	10/300
23670	8	110	10/500
23680	8	160	10/400
23690	8	210	10/250
23692	8	300	10/200
23693	8	460	10/100
23694	8	600	10/100
23710	10	160	10/300
23720	10	210	10/250
23722	10	300	10/150
23723	10	460	10/100
23724	10	600	10/100
23730	12	160	10/300
23740	12	460	10/100
23750	12	266	10/150
23752	12	600	10/60
23800	14	166	10/200
23820	14	460	10/80
23830	14	266	10/150
23832	14	600	10/50
23840	16	200	10/160
23850	16	300	8/96
23860	16	460	8/48
23862	16	600	8/48
23880	18	300	8/72
23882	18	460	6/48
23883	18	600	6/48
23920	20	300	5/50
23930	20	460	5/50
23932	20	600	5/30
23960	22	460	5/25
23962	22	600	5/25
23980	25	300	5/50
23982	25	600	5/15
23990	25	460	5/25
23992	28	600	2/10
23999	30	600	5/10

EN Masonry drill bit
 PL Wiertło do betonu
 DE Betonspiralbohrer
 RU Сверло по бетону

CZ Vrták na beton
 RO Burghiu pt. beton
 HU Fúrószár betonhoz
 ES Broca para hormigón



STHOR

No.	Ø [mm]	L [mm]	
23371	16	300	10/50
23390	16	600	5/30
23411	16	900	4/20
23372	18	300	10/50
23391	18	600	5/30
23412	18	900	4/20
23373	20	300	8/40
23392	20	600	4/20
23413	20	900	2/10
23374	22	300	6/30
23393	22	600	4/20
23414	22	900	2/10
23375	24	300	6/30
23394	24	600	4/20
23415	24	900	2/10
23376	25	300	6/30
23395	25	600	4/20
23416	25	900	2/10
23377	26	300	6/30
23396	26	600	2/10
23417	26	900	2/10
23397	28	600	2/10
23418	28	900	5
23379	30	300	4/20
23398	30	600	2/10
23419	30	900	5
23380	32	300	4/20
23399	32	600	2/10
23420	32	900	5
23381	35	300	4/20
23400	35	600	2/10
23421	35	900	5
23422	37	900	5
23402	38	600	1/5
23423	38	900	5
23403	40	600	5
23424	40	900	5

EN Point chisel
 PL Szpicak
 DE Spitzmeißel
 RU Зубило пиковое

CZ Špičák
 RO Spit
 HU Hegyes véső
 ES Cincel punta



STHOR

No.	Ø [mm]	Working width / Szerokość robocza [mm]	L [mm]	
23601	18	1.5	280	20/40
23602	18	1.5	400	10/20

EN Masonry drill bit set
 PL Zestaw wiertel do betonu
 DE Betonbohrer-Satz
 RU Набор сверл по бетону
 CZ Sada vrtáků do betonu
 RO Set de burghie pt. beton
 HU Fúrókészlet betonhoz
 ES Juego brocas para hormigón



STHOR

No.	Ø [mm]	pcs / szt.	
23988	5, 6, 8, 10, 12	5	15/60

EN Point chisel
 PL Szpicak
 DE Spitzmeißel
 RU Зубило пиковое

CZ Špičák
 RO Spit
 HU Hegyes véső
 ES Cincel punta



STHOR

No.	Ø [mm]	Working width / Szerokość robocza [mm]	L [mm]	
23590	14	1.5	250	25/50

EN Flat chisel
 PL Dłuto wąskie
 DE Flachmeißel
 RU Зубило узкое

CZ Sekáč
 RO Daltă plată
 HU Lapos véső
 ES Cincel plano



STHOR

No.	Ø [mm]	Working width / Szerokość robocza [mm]	L [mm]	
23591	14	20	250	25/50

EN Flat chisel
 PL Dłuto wąskie
 DE Flachmeißel
 RU Зубило узкое
 CZ Sekáč
 RO Daltă plată
 HU Lapos véső
 ES Cincel plano



STHOR

No.	Ø [mm]	Working width / Szerokość robocza [mm]	L [mm]	
23603	18	25	280	20/40
23604	18	25	400	10/20

EN Flat chisel
 PL Dłuto płaskie
 DE Spatmeißel
 RU Долого плоское
 CZ Sekáč plochý
 RO Daltă lată
 HU Széles lapos véső
 ES Cincel plano



STHOR

No.	Ø [mm]	Working width / Szerokość robocza [mm]	L [mm]	
23594	14	60	250	25/50

EN Groove chisel
 PL Bruzdownik
 DE Nutenmeißel
 RU Зубило-штробер
 CZ Sekáč drážkovací
 RO Dalta canal
 HU Horonyvéső
 ES Cincel acanalado



STHOR

No.	Ø [mm]	Working width / Szerokość robocza [mm]	L [mm]	
23593	14	22	250	25/50

EN Hollow drill set
 PL Wiertło koronowe do muru
 DE Bohrkronen
 RU Коронка по бетону
 CZ Korunový vrták na zed
 RO Carotă pt. beton
 HU Koronafűrészfalhoz
 ES Broca vidia para muro

VOREL

No.	Ø [mm]	
03240	65	24
03241	80	20

EN Spade chisel
 PL Dłuto szerokie
 DE Spatmeißel
 RU Зубило плоское широкое
 CZ Sekáč plochy
 RO Daltă lată
 HU Széles véső
 ES Cincel pala



STHOR

No.	Ø [mm]	Working width / Szerokość robocza [mm]	L [mm]	
23592	14	40	250	25/50

EN Spade chisel
 PL Dłuto szerokie
 DE Spatmeißel
 RU Зубило плоское широкое
 CZ Sekáč plochy
 RO Daltă lată
 HU Széles véső
 ES Cincel pala



STHOR

No.	Ø [mm]	Working width / Szerokość robocza [mm]	L [mm]	
23605	18	40	280	20/40
23606	18	50	400	10/20

EN Adapter
 PL Adapter
 DE Adapter
 RU Адаптер
 CZ Adaptér
 RO Adaptor
 HU Adaptor
 ES Adaptador



STHOR

No.	L [mm]	
23460	60	100/200

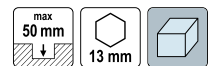

EN Hollow drill set
 PL Wiertło koronowe do muru
 DE Bohrkronen
 RU Коронка по бетону
 CZ Korunový vrták na zeď
 RO Carotă pt. beton
 HU Koronafúró falhoz
 ES Broca widia para muro



No.	Ø [mm]	
03245	65	24
03246	80	20

EN Drywall circle cutter
 PL Wycinarka do płyt gipsowych
 DE Schnitzzirkel für Gipsplatten
 RU Резак круговой по гипскартону
 CZ Vystřihovačka pro sádrové desky
 RO Cuțit pt. plăci de rigips
 HU Gipszfalkívágó
 ES Compas cortador para planchas de escayola



No.	Ø [mm]	
03990	30-400	12/48

EN Hole saw set
 PL Zestaw wycinarek do otworów w drewnie
 DE Lochsägensatz
 RU Пилы кольцевые по дереву в наборе
 CZ Sada děrovek do dřeva
 RO Set carote pt. lemn
 HU Körtivágó készlet
 ES Juego de sierras de corona para madera

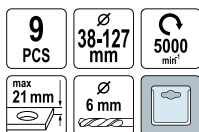

No.	Ø [mm]	pcs / szt.	
22572	38, 51, 57, 67, 76, 89, 102, 127	9	6/24

EN Hole saw set
 PL Zestaw wycinarek do otworów w drewnie
 DE Lochsägensatz
 RU Пилы кольцевые по дереву в наборе
 CZ Sada děrovek do dřeva
 RO Set carote pt. lemn
 HU Körtivágó készlet
 ES Juego de sierras de corona para madera

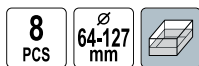

No.	Ø [mm]	pcs / szt.	
22571	64, 76, 87, 102, 127	8	6/24

EN Hole saw set
 PL Wycinarka otworów do drewna
 DE Lochsägensatz
 RU Пилы кольцевые по дереву в наборе
 CZ Vytínač otvorů
 RO Set carote pt. lemn
 HU Lyukasztó
 ES Sierra de corona para madera



No.	Ø [mm]	pcs / szt.	
22565	51, 76, 89	4	12/48

EN Hole saw set
 PL Zestaw wycinarek do otworów w drewnie
 DE Lochsägensatz
 RU Пилы кольцевые по дереву в наборе
 CZ Sada děrovek do dřeva
 RO Set carote pt. lemn
 HU Körtivágó készlet
 ES Juego de sierras de corona para madera

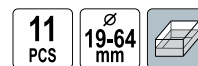

No.	Ø [mm]	pcs / szt.	
22570	19, 21, 28, 31, 37, 43, 51, 64	11	12/36

EN Hole saw for wood with hardened teeth
 PL Wyrzynarka do drewna, hartowane zęby
 DE Lochsägensatz
 RU Пилы кольцевые по дереву закалённые зубья
 CZ Vyřezávací pila kalená
 RO Carotă pt. lemn
 HU Szúrófűrész edzett
 ES Sierra de corona curtidó

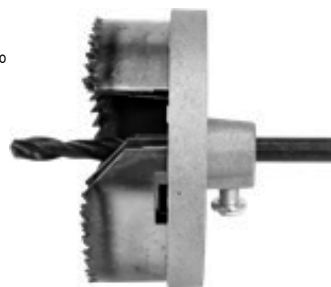
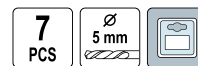

No.	Ø [mm]	Max. drilling depth / Maks. głębokość wiercenia [mm]	
28680	26, 32, 38, 45, 50, 56, 63	17	10/100
28690	26, 32, 38, 45, 50, 56, 63	43	10/80

EN Hole saw for wood
 PL Wyrzynarka do drewna
 DE Lochsägensatz
 RU Пилы кольцевые по дереву
 CZ Vyřezávací pila
 RO Carotă pt. lemn
 HU Szűrőfűrész
 ES Sierra de corona

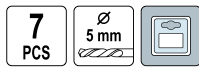

No.	Ø [mm]	Max. drilling depth / Maks. głębokość wiercenia [mm]	
28710	26, 32, 38, 45, 50, 56, 63	20	10/100
28720	26, 32, 38, 45, 50, 56, 63	43	10/80

EN Tungsten carbide coated hole saw set
 PL Zestaw wycinarek wolframowych
 DE Lochbohrersatz
 RU Коронки вольфрамовые

CZ Sada děrovacích vrtáků pro keramiku
 RO Set freze
 HU Körkivógó készlet wolfram borítással
 ES Juego de punzones de wolframio



No.	Ø [mm]	
03300	33, 53, 67, 73	5/20
03301	33, 53, 67, 83	5/20

EN Drill for glass
 PL Wiertło do szkła i ceramiki
 DE Bohrer für Glas
 RU Сверло по стеклу

CZ Vrták do skla
 RO Burghiu pt. sticlă
 HU Üvegfúró
 ES Broca para vidrio

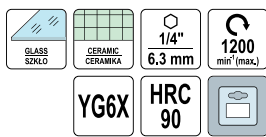

No.	Ø [mm]	L [mm]	
21700	3	60	125/500
21701	4	60	125/500
21702	5	70	125/500
21703	6	75	125/500
21704	8	80	125/500
21705	10	100	125/500
21706	12	100	100/400

EN Tool drill guide
 PL Szablon do wyznaczania otworów
 DE Schablone zur Markierung von Löchern
 RU Шаблон для разметки отверстий
 CZ Šablona pro značení otvorů
 RO Șablon pt. marcarea găurilor
 HU Nyílászablon
 ES Plantilla para determinar perforaciones



No.	L [mm]	
18180	200 (ramię poziome), 250 (listwa pionowa)	40

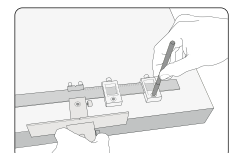

EN Hole saw set
 PL Zestaw wycinarek do otworów
 DE Lochsägensatz
 RU Пилы кольцевые по дереву
 CZ Vyřezávací pila
 RO Set carote pt. lemn
 HU Lyukasztő
 ES Cortador de agujeros



No.	Ø [mm]	pcs / szt.	
28725	60, 67, 74, 81, 95	8	6/24

EN Tile and glass drill
 PL Wiertło do szkła i glazury
 DE Glass- und Fliesenbohrer
 RU Сверло по плитке и стеклу

CZ Vrták do skla a glazury
 RO Burghiu pt. sticlă și plăci ceramice
 HU Üveg- és csempéfúró
 ES Broca para cristal y azulejos



No.	Ø [mm]	L [mm]	
05540	4	80	50/100
05560	6	90	50/100
05580	8	95	50/100
05600	10	100	50/100

EN Glass and tile drills
 PL Zestaw wiertel do szkła i ceramiki
 DE Glas- und Fliesenbohrer
 RU Набор сверл по стеклу и керамике
 CZ Vrtáky do skla a keramika
 RO Set burghie pt. sticla si ceramica
 HU Üveg és kerámi fúrók
 ES Juego de brocas, ceramica

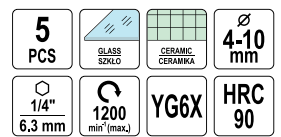

No.	Ø [mm]	pcs / szt.	
21709	4, 5, 6, 8, 10	5	25/100

- EN Depth collars for drills
 PL Ograniczniki głębokości wiercenia
 DE Bohrtiefenbegrenzersatz
 RU Ограничители глубины сверления
 CZ Omezovače hloubky vrtání
 RO Limitator adancime pt. burghiu
 HU Mélységűtközők
 ES Topes de profundidad para brocas



No.	Ø [mm]	pcs / szt.	
24070	3, 4, 5, 6, 8, 10, 12, 16	8	20/120

- EN Dowel set
 PL Zestaw do połączeń kolkowych
 DE Holzdübel-Werkzeugsatz
 RU Набор для соединения на шкантах
 CZ Kolkovací sada
 RO Set pt. imbinari cu dibluri lemni
 HU Facsapozó készlet
 ES Juego para ensamblaje de madera



- INCLUDED:**
 - 30 pcs of wood dowel pins: 6 x 30 mm, 8 x 40 mm, 10 x 40 mm
 - 6 pcs of dowelling centre points: 6, 8, 10 mm
 - 3 pcs of drill stops: 6, 8, 10 mm
 - 3 pcs of brad point drill bits: 6, 8, 10 mm
 - Hex key
- W ZESTAWIE:**
 - 30 kółków drewnianych rowkowanych: 6 x 30 mm, 8 x 40 mm, 10 x 40 mm
 - 6 znaczników: 6, 8, 10 mm
 - 3 ograniczniki głębokości wiercenia: 6, 8, 10 mm
 - 3 wiertła do drewna: 6, 8, 10 mm
 - Klucz imbusowy



No.	Ø [mm]	pcs / szt.	
24080	6, 8, 10	43	6/24

- EN Woodworking doweling jig
 PL Szablon do połączeń kolkowych
 DE Dübel Bohrschablone
 RU Кондуктор для сверления отверстий
 CZ Kolkovací přípravek
 RO Sablon pt. dibluri lemni
 HU Típliző fűrésablón
 ES Guía de perforación



No.	Ø [mm]	
24090	6, 8, 10	50

- EN Hand taps
 PL Gwintowniki
 DE Handgewindebohrer
 RU Метчик
- CZ Závitníky
 RO Tarozii
 HU Meneffűró
 ES Machos de roscar



No.	Size / Rozmiar	pcs / szt.	
24300	M3	3	25/100
24310	M4	3	25/100
24320	M5	3	25/100
24330	M6	3	25/100
24340	M7	3	25/100
24350	M8	3	25/100

- EN Dowelling centre points
 PL Znaczniki do wyznaczania otworów
 DE Holzdübel-Markierspitzen
 RU Набор кернов для мебельных шкантов
 CZ Značičky hroty pro kolkování
 RO Punctatoare pt. dibluri
 HU Típljelölő
 ES Centradores

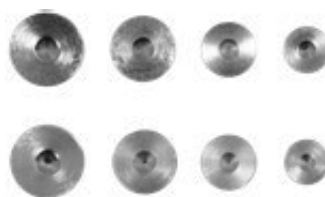

No.	Ø [mm]	pcs / szt.	
24060	6 x2, 8 x2, 10 x2, 12 x2	8	20/120

- EN Pocket hole cutter set
 PL Zestaw do połączeń kieszeniowych
 DE Taschenbohrlehre Satz
 RU Комплект для карманного соединения
 CZ Šikmý otvor lokátor
 RO Set pt. găurirea oblică în lemn
 HU Zsebfurat-szűrő készlet
 ES Juego para agujeros de bolsillo



- Ø9.5x3.5 mm;
 115x25x25 mm;
 9.5 mm;



No.	
24091	10/40

- EN Pocket hole plugs
 PL Zasklepki do otworów kieszeniowych
 DE Stöpsel zum Verschließen von Taschenlochbohrungen
 RU Заглушки для карманных отверстий
 CZ Zátky do šikmých otvorů
 RO Cepuri lemni
 HU Zsebfurat kitöltő
 ES Tapones para agujeros de bolsillo

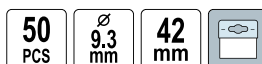

No.	Ø [mm]	L [mm]	pcs / szt.	
24095	9.3	42	50	100

No.	Size / Rozmiar	pcs / szt.	
24370	M10	3	25/100
24390	M12	3	25/100
24410	M14	3	20
24430	M16	3	20
24450	M18	3	20
24470	M20	3	20

EN Machine tap
 PL Gwintownik maszynowy
 DE Maschinengewindebohrer
 RU Метчик машинный

CZ Strojní závitník
 RO Tarod
 HU Gépi menetfűró
 ES Macho mecanico



sztool

No.	Size / Rozmiar	Box icon
24960	M3	25/100
24961	M4	25/100
24962	M5	25/100
24963	M6	25/100
24964	M8	25/100
24965	M10	25/100
24966	M12	25/100



EN Circular die
 PL Narzynka
 DE Schneideisen
 RU Пнашка
 CZ Kruhová závitová čelist
 RO Filieră
 HU Menetvágó
 ES Cojnete de roscar



sztool

No.	Size / Rozmiar	Box icon
24500	M3	25/100
24510	M4	25/100
24520	M5	25/100
24530	M6	25/100
24550	M8	25/100
24570	M10	25/100
24590	M12	25/100
24610	M14	25/100
24630	M16	15/60
24650	M18	30/60
24670	M20	15/60

EN Tap and die set
 PL Zestaw gwintowników i narzynek
 DE Gewindeschneidwerkzeug-Satz
 RU Набор плашек и метчиков
 CZ Sada závitníků a závitových oček
 RO Set de tarozi și filiere
 HU Menetfűró és menetmetsző készlet
 ES Juego de machos de roscar y cojinetes



sztool

No.	Size / Rozmiar	pcs / szt.	Box icon
24900	M3, M4, M5, M6, M8, M10, M12	32	5

EN Tap set
 PL Zestaw gwintowników
 DE Gewindeschneidwerkzeug-Satz
 RU Набор метчиков
 CZ Souprava závitníků
 RO Set de tarozi
 HU Menetfűró készlet
 ES Juego de machos de roscar



sztool

No.	Size / Rozmiar	pcs / szt.	Box icon
24940	M3, M4, M5, M6, M7, M8, M10, M12	25	60

EN Ratchet tap wrench
 PL Grzechotka do gwintownika
 DE Gewindebohrerratsche
 RU Вороток для метчиков с трещоткой
 CZ Řečtačka na závitník
 RO Port tarod cu clichet
 HU Racsnis hajtósár menetfűróhoz
 ES Carraca para macho de roscar



No.	Size / Rozmiar	Box icon
24700	M3-M8	25/100
24710	M5-M12	25/100

- EN Tap and die set
- PL Zestaw gwintowników i narzynek
- DE Gewindeschneidwerkzeug-Satz
- RU Набор плашек и метчиков
- CZ Sada závitníků a závitových oček
- RO Set de tarozi și filiere
- HU Menefűró és menetmetsző készlet
- ES Juego de machos de roscar y cojinetes



No.	Size / Rozmiar	
24295	M3, M4, M5, M6, M8, M10, M12, M3-M12, M3-M12	10/20

- EN Router bit set
- PL Zestaw frezów do drewna
- DE Oberfrärsersatz
- RU Набор фрез по дереву
- CZ Sada fréz do dřeva
- RO Set de freze pt. lemn
- HU Faipari marókés készlet
- ES Juego de fresas para madera



No.	Ø [mm]	Toolholder size / Rozmiar uchwyty narzędziowego [mm]	pcs / szt.	
22552	6, 12, 12.7, 16, 22, 25.4, 28.6, 32	6	12	20

- EN Router bit set
- PL Zestaw frezów do drewna
- DE Oberfrärsersatz
- RU Набор фрез по дереву
- CZ Sada fréz do dřeva
- RO Set de freze pt. lemn
- HU Faipari marókés készlet
- ES Juego de fresas para madera

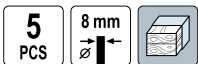

No.	Ø [mm]	Toolholder size / Rozmiar uchwyty narzędziowego [mm]	pcs / szt.	
22551	15, 20, 25, 30, 35	8	5	5/20

- EN Screw extractor set
- PL Wykrętki do zerwanych śrub
- DE Schraubenausdrehsatz
- RU Набор для извлечения обломанных болтов
- CZ Vrtáky do přetržených šroubů
- RO Trusă extractoare șuruburi rupte
- HU Törtcsavar kieszdő készlet
- ES Destornillador para tornillos arrancados



No.	Size / Rozmiar	pcs / szt.	
24000	1/8" (3.2 mm) - 1/4" (6.3 mm), 1/4" (6.3 mm) - 5/16" (7.9 mm), 5/16" (7.9 mm) - 7/16" (11.1 mm), 7/16" (11.1 mm) - 9/16" (14.3 mm), 9/16" (14.3 mm) - 3/4" (19.0 mm)	5	12/120

- EN Router bit set
- PL Zestaw frezów do drewna
- DE Oberfrärsersatz
- RU Набор фрез по дереву
- CZ Sada fréz do dřeva
- RO Set de freze pt. lemn
- HU Faipari marókés készlet
- ES Juego de fresas para madera

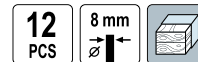

No.	Toolholder size / Rozmiar uchwyty narzędziowego [mm]	pcs / szt.	
22550	8	12	5/20

- EN Mini rotary file set
- PL Zestaw frezów do miniszliferek
- DE Frärserset für Minischleifmaschine
- RU Набор фрез для гравера
- CZ Sada fréz pro mini brusky
- RO Set freze pt. mini freză
- HU Mini köszörű felsőmaró készlet
- ES Juego de fresas para miniamoladoras



No.	pcs / szt.	
25405	6	50/300

EN Diamond blade segmented
 PL Tarcza diamentowa "segment"
 DE Diamanttrennscheibe
 RU Диск алмазный сегментированный

CZ Diamantový kotouč segmentový
 RO Disc diamantat
 HU Szegmens gyémántkorong
 ES Disco de diamante de segmentos

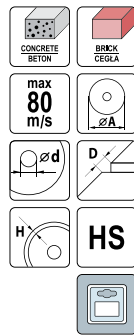

No.	ØA [mm]	Ød [mm]	max C [min ⁻¹]	D [mm]	H [mm]	
08711	115	22.2	12000	2.0	8	20/200
08712	125	22.2	11000	2.1	8	20/160
08714	180	22.2	8000	2.2	8	15/60
08715	230	22.2	6500	2.4	8	10/40

EN Diamond blade continuous rim
 PL Tarcza diamentowa pełna
 DE Diamanttrennscheibe
 RU Диск алмазный сплошной

CZ Diamantový kotouč plyný
 RO Disc diamantat
 HU Gyémántkorong (teljes)
 ES Disco de diamante

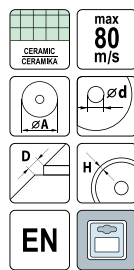

No.	ØA [mm]	Ød [mm]	max C [min ⁻¹]	D [mm]	H [mm]	
08731	115	22.2	12000	1.6	5	20/200
08732	125	22.2	11000	1.6	5	20/160
08734	180	22.2	8000	1.8	5	15/60

EN Diamond blade turbo
 PL Tarcza diamentowa turbo
 DE Diamanttrennscheibe Turbo
 RU Отрезной алмазный диск турбо

CZ Diamantový kotouč turbo
 RO Disc diamantat
 HU Gyémántkorong turbo
 ES Disco de diamante turbo



No.	ØA [mm]	Ød [mm]	max C [min ⁻¹]	D [mm]	H [mm]	
08751	115	22.2	12000	2.0	8	20/200
08752	125	22.2	11000	2.0	8	20/160
08754	180	22.2	8000	2.2	8	15/60
08755	230	22.2	6500	2.4	8	10/40

EN Diamond blade segmented
 PL Tarcza diamentowa "segment"
 DE Diamanttrennscheibe
 RU Диск алмазный сегментированный

CZ Diamantový kotouč segmentový
 RO Disc diamantat
 HU Szegmens gyémántkorong
 ES Disco de diamante de segmentos

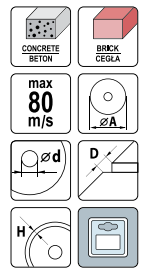

No.	ØA [mm]	Ød [mm]	max C [min ⁻¹]	D [mm]	H [mm]	
08780	115	22.2	13200	1.9	7	20/120
08781	125	22.2	12000	2.0	7	20/120
08782	180	22.2	8400	2.3	7	15/45
08783	230	22.2	6600	2.4	7	10/30

EN Diamond blade continuous rim
 PL Tarcza diamentowa pełna
 DE Diamanttrennscheibe
 RU Диск алмазный сплошной

CZ Diamantový kotouč plyný
 RO Disc diamantat
 HU Gyémántkorong teljes
 ES Disco de diamante

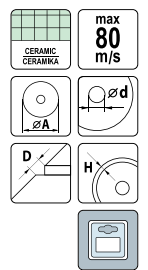

No.	ØA [mm]	Ød [mm]	max C [min ⁻¹]	D [mm]	H [mm]	
08785	115	22.2	13200	1.9	5	20/120
08786	125	22.2	12000	2.0	5	20/120
08788	230	22.2	6600	2.4	5	10/30

EN Diamond blade turbo
 PL Tarcza diamentowa turbo
 DE Diamanttrennscheibe Turbo
 RU Отрезной алмазный диск турбо

CZ Diamantový kotouč turbo
 RO Disc diamantat
 HU Gyémántkorong turbo
 ES Disco de diamante turbo

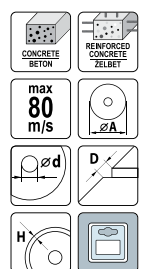

No.	ØA [mm]	Ød [mm]	max C [min ⁻¹]	D [mm]	H [mm]	
08790	115	22.2	13200	2.0	7.0	20/120
08791	125	22.2	12000	2.1	7.0	20/120
08792	180	22.2	8400	2.4	7.5	15/45
08793	230	22.2	6600	2.6	7.5	10/30

- EN Diamond rod saw
- PL Brzeszczot diamentowy
- DE Diamantsägekordel
- RU Полотно алмазное
- CZ Lanko pivoie diamantowe
- RO Pânză diamantată
- HU Fűrészlap-pálca, gyémántbevonatú
- ES Hoja de sierra de diamante



No.	L [mm]	
27575	300	20/100

- EN TCT circular saw blade for aluminium
- PL Pila tarczowa do aluminium z węglikiem wolframu
- DE Hartmetallbestückt Kreissägeblatt für Aluminium
- RU Диск пильный по алюминию
- CZ Kotoučová pila na hliník s karbidem wolframu
- RO Disc circular pt. aluminiu
- HU Wolframkarbidos körfűrészlap, alumíniumhoz
- ES Disco de sierra con carbono



No.	Ø [mm]	Ød [mm]	max C [min ⁻¹]	D [mm]	s [mm]	T	
08853	210	30	6500	2.2	1.6	72	10/20
08854	250	30	5400	3.0	1.8	100	10/20
08855	300	30	4500	3.2	2.0	100	10

- EN Metal cutting disc
- PL Tarcza do cięcia metalu
- DE Trennscheibe für Metall
- RU Диск отрезной по металлу
- CZ Kotouč pro řezání kovu
- RO Disc debitat metale
- HU Vágókorong fémhez
- ES Disco cortador para metal

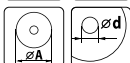

No.	ØA [mm]	Ød [mm]	max C [min ⁻¹]	D [mm]	
08630	115	22	12000	1.0	25/200
08633	115	22	13300	2.5	25/200
08631	125	22	11000	1.0	25/200
08635	125	22	12200	2.5	25/200
08639	230	22	6600	1.6	25/50
08640	230	22	6600	3.2	25/50
08641	230	22	6600	2.5	25/50
08642	300	32	5100	3.2	10/20
08644	350	32	4400	3.5	10/20
08646	400	32	3800	4.0	10/20

- EN TCT circular saw blade for wood
- PL Pila tarczowa do drewna z węglikiem wolframu
- DE Kreissägeblatt HM-Bestückt
- RU Диск пильный с карбидом вольфрама
- CZ Kotoučová pila na dřevo z karbidem wolframu
- RO Disc circular cu dinți din wolfram pt. lemn
- HU Wolframkarbidos körfűrész fához
- ES Disco de sierra con carbono de tungsteno

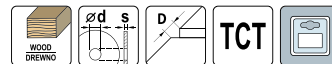

No.	Ø [mm]	Ød [mm]	max C [min ⁻¹]	D [mm]	s [mm]	T	
08811	140	20	9600	2.0	1.3	16	25/50
08819	160	20	8300	2.0	1.4	18	25/50
08820	160	30	8300	2.0	1.4	24	25/50
08821	160	30	8300	2.0	1.4	36	25/50
08822	160	20	8300	2.0	1.4	48	25/50
08825	184	30	7400	2.2	1.4	24	10/20
08827	184	30	7400	2.2	1.4	40	10/20
08828	185	20	7400	2.2	1.4	18	10/20
08829	200	30	6500	2.2	1.6	24	10/20
08831	210	30	6500	2.2	1.6	40	10/20
08832	210	30	6500	2.2	1.6	60	10/20
08833	250	30	5400	3.0	1.8	24	10/20
08834	250	30	5400	3.0	1.8	40	10/20
08835	250	30	5400	3.0	1.8	60	10/20
08837	300	30	4500	3.2	2.0	40	10
08838	300	30	4500	3.2	2.0	60	10
08845	350	30	3800	3.2	2.2	40	10
08851	400	30	3300	3.2	2.2	60	10

- EN Metal cutting disc
- PL Tarcza do cięcia metalu
- DE Trennscheibe für Metall
- RU Диск отрезной по металлу
- CZ Kotouč pro řezání kovu
- RO Disc debitat metale
- HU Vágókorong fémhez
- ES Disco cortador para metal

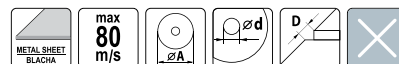

No.	ØA [mm]	Ød [mm]	max C [min ⁻¹]	D [mm]	
08170	115	22	13200	1.0	25/200
08174	115	22	13200	3.0	25/200
08171	125	22	12200	1.0	25/200
08175	125	22	12200	3.0	25/200

EN Metal grinding disc - depressed centre
 PL Tarcza do szlifowania metalu wypukła
 DE Metall-Schleifscheibe gewölbt
 RU Диск шлифовальный по металлу
 CZ Kotouč pro broušení kovu
 RO Disc pt. șlefuit metal
 HU Vágókorong fémhez
 ES Disco de pulir de metalo

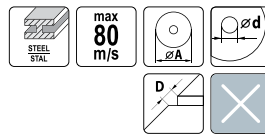

No.	ØA [mm]	Ød [mm]	max C [min ⁻¹]	D [mm]	
08663	115	22	13300	6.0	25/100
08665	125	22	11000	6.8	25/100
08669	230	22	6600	6.8	25/50

EN Stone cutting disc
 PL Tarcza do cięcia kamienia
 DE Stein-Trennscheibe
 RU Диск отрезной по камню
 CZ Kotouč pro řezání kamene
 RO Disc pt. tăiat piatră
 HU Vágókorong kőhöz
 ES Disco cortador de piedra

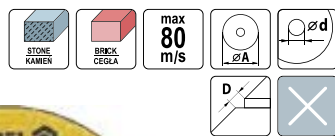

No.	ØA [mm]	Ød [mm]	max C [min ⁻¹]	D [mm]	
08671	115	22	13200	3.2	25/200
08674	230	22	6600	3.2	25/50

EN Abrasive disc
 PL Ściernica listkowa talerzowa
 DE Lameller
 RU Диск лепестковый

CZ Kotouč brusný lamelový
 RO Disc abraziv
 HU Lamellás csiszoló
 ES Disco abrasivo

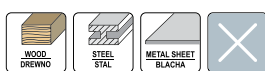

No.	Grit / Ziarnistość	Ø [mm]	max C [min ⁻¹]	
07974	P40	115	13300	50/200
07984	P40	125	12300	50/200
07975	P60	115	13300	50/200
07985	P60	125	12300	50/200
07976	P80	115	13300	50/200
07986	P80	125	12300	50/200
07977	P100	115	13300	50/200
07987	P100	125	12300	50/200
07978	P120	115	13300	50/200
07988	P120	125	12300	50/200

EN Metal grinding disc - depressed centre
 PL Tarcza do szlifowania metalu wypukła
 DE Metall-Schleifscheibe gewölbt
 RU Диск шлифовальный по металлу выпуклый
 CZ Kotouč pro broušení kovu
 RO Disc pt. șlefuit metal
 HU Vágókorong fémhez
 ES Disco de pulir de metalo

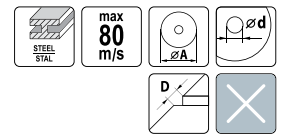

No.	ØA [mm]	Ød [mm]	max C [min ⁻¹]	D [mm]	
08190	115	22	13200	6	25/100
08191	125	22	12200	6	25/100

EN Stone grinding disc - depressed centre
 PL Tarcza do szlifowania kamienia wypukła
 DE Stein-Schleifscheibe gewölbt
 RU Диск шлифовальный по камню
 CZ Kotouč pro broušení kamene
 RO Disc pt. șlefuit piatră
 HU Csiszolókorong kőhöz
 ES Disco de pulir de piedra

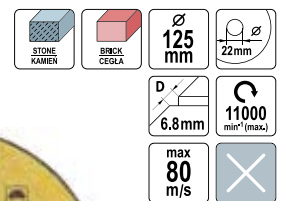

No.	ØA [mm]	Ød [mm]	max C [min ⁻¹]	D [mm]	
08683	125	22	11000	6.8	25/100

EN Grinding disc
 PL Tarcza do szlifierki stolowej
 DE Schleifscheibe
 RU Круг для настольного точильного станка
 CZ Brusný kotouč
 RO Disc abraziv
 HU Kőszűrűkő
 ES Disco abrasivo

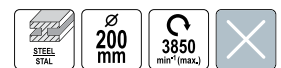

No.	Ø [mm]	Mounting hole diameter / Srednica mocowania [mm]	Thickness / Grubość [mm]	max C [min ⁻¹]	
08876	200	20	40	3850	5

- EN Grinding disc
- PL Tarcza do szlifierki stołowej
- DE Schleifscheibe
- RU Круг для настольного точильного станка
- CZ Brusný kotouč
- RO Disc abraziv
- HU Kőszűrűkő
- ES Disco abrasivo

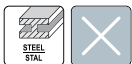

No.	Ø [mm]	Mounting hole diameter / Średnica mocowania [mm]	Thickness / Grubość [mm]	max. α [min ⁻¹]	Grit / Ziarnistość	
08860	125	12.7	17	5850	gruboziairny	10
08861	125	12.7	17	5850	drobnoziairny	10
08864	150	12.7	17	5350	gruboziairny	10
08865	150	12.7	17	5350	drobnoziairny	10
08868	150	31.8	25	5350	gruboziairny	10
08869	150	31.8	25	5350	drobnoziairny	10
08873	200	15.9	20	3850	drobnoziairny	10
08875	200	31.8	30	3850	drobnoziairny	10

- EN Tin snips
- PL Nożyce do cięcia blachy
- DE Blechscherer
- RU Ножницы по металлу
- CZ Nůžky na plech
- RO Foarfecă pt. tablă
- HU Lemezvágó olló
- ES Tijera corta chapa

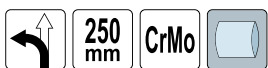

No.	L [mm]	Max. cutting capacity in cold-rolled steel / Maks. grubość cięcia w stali walcowanej na zimno [mm]	
48000	250	1.5	6/36

- EN Tin snips
- PL Nożyce do cięcia blachy
- DE Blechscherer
- RU Ножницы по металлу
- CZ Nůžky na plech
- RO Foarfecă pt. tablă
- HU Lemezvágó olló
- ES Tijera corta chapa



No.	L [mm]	Max. cutting capacity in cold-rolled steel / Maks. grubość cięcia w stali walcowanej na zimno [mm]	
48080	250	1	6/36

- EN Grinding wheel dresser
- PL Przyrząd do wyrównywania tarcz szlifierskich
- DE Schleifscheiben-Abrichter
- RU Шарошка для выравнивания абразивных дисков
- CZ Zařízení pro vyrovnávání brusných kotoučů
- RO Dresser roată de șlefuit
- HU Csiszolókorong szabályzó
- ES Rectificador de muelas abrasivas

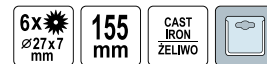

No.	L [mm]	
08900	155	12/48

- EN Tin snips
- PL Nożyce do cięcia blachy
- DE Blechscherer
- RU Ножницы по металлу
- CZ Nůžky na plech
- RO Foarfecă pt. tablă
- HU Lemezvágó olló
- ES Tijera corta chapa

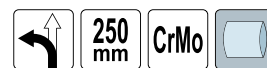

No.	L [mm]	Max. cutting capacity in cold-rolled steel / Maks. grubość cięcia w stali walcowanej na zimno [mm]	
48060	250	1.2	6/48

- EN Tin snips
- PL Nożyce do cięcia blachy
- DE Blechscherer
- RU Ножницы по металлу
- CZ Nůžky na plech
- RO Foarfecă pt. tablă
- HU Lemezvágó olló
- ES Tijera corta chapa



No.	L [mm]	
48100	250	6/60

EN Tin snips
 PL Nożyce do cięcia blachy
 DE Blechscherer
 RU Ножницы по металлу
 CZ Nůžky na plech
 RO Foarfecă pt. tablă
 HU Lemezvágó olló
 ES Tijera corta chapa



No.	L [mm]	Max. cutting capacity in cold-rolled steel / Maks. grubość cięcia w stali walcowanej na zimno [mm]	Box icon
48082	250	1	6/36

EN Tin snips
 PL Nożyce do cięcia blachy
 DE Blechscherer
 RU Ножницы по металлу
 CZ Nůžky na plech
 RO Foarfecă pt. tablă
 HU Lemezvágó olló
 ES Tijera corta chapa

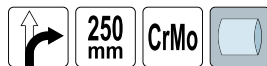

No.	L [mm]	Max. cutting capacity in cold-rolled steel / Maks. grubość cięcia w stali walcowanej na zimno [mm]	Box icon
48050	250	1.5	6/36

EN Tin snips
 PL Nożyce do cięcia blachy
 DE Blechscherer
 RU Ножницы по металлу
 CZ Nůžky na plech
 RO Foarfecă pt. tablă
 HU Lemezvágó olló
 ES Tijera corta chapa



No.	L [mm]	Max. cutting capacity in cold-rolled steel / Maks. grubość cięcia w stali walcowanej na zimno [mm]	Box icon
48081	250	1	6/36

EN Tin snips
 PL Nożyce do cięcia blachy
 DE Blechscherer
 RU Ножницы по металлу
 CZ Nůžky na plech
 RO Foarfecă pt. tablă
 HU Lemezvágó olló
 ES Tijera corta chapa

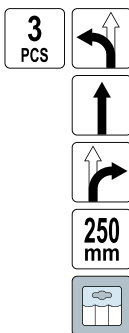

No.	L [mm]	pcs / szt.	Box icon
48330	250	3	5/20

EN Tin snips
 PL Nożyce do cięcia blachy
 DE Blechscherer
 RU Ножницы по металлу
 CZ Nůžky na plech
 RO Foarfecă pt. tablă
 HU Lemezvágó olló
 ES Tijera corta chapa



No.	L [mm]	Box icon
48200	250	6/60

EN Tin snips
 PL Nożyce do cięcia blachy
 DE Blechscherer
 RU Ножницы по металлу
 CZ Nůžky na plech
 RO Foarfecă pt. tablă
 HU Lemezvágó olló
 ES Tijera corta chapa

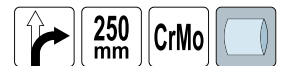

No.	L [mm]	Max. cutting capacity in cold-rolled steel / Maks. grubość cięcia w stali walcowanej na zimno [mm]	Box icon
48070	250	1.2	6/48

EN Tin snips
 PL Nożyce do cięcia blachy
 DE Blechscherer
 RU Ножницы по металлу

CZ Nůžky na plech
 RO Foarfecă pt. tablă
 HU Lemezvágó olló
 ES Tijera corta chapa



No.	L [mm]	Box icon
48150	250	6/60

EN Bolt cutter
 PL Nożyce do drutu
 DE Drahtschere
 RU Ножницы для проволоки

CZ Nůžky na drát
 RO Clește pt. tăiat sârmă
 HU Drótvágó olló
 ES Alicates para cortar alambre



No.	L [mm]	Box icon
49200	200	15/60

EN Bolt cutter
 PL Nożyce do pretów
 DE Bolzenschneider
 RU Болторезы

CZ Nůžky štípací na tyče
 RO Clește pt. buloane
 HU Csapszegvágó olló
 ES Cortavarillas



No.	L [mm]	
49450	450	20
49600	600	1/10

8

EN Miter shears
 PL Nożyce wielofunkcyjne do węży, rurek, listew
 DE Mitre Scheren
 RU Ножницы угловые для пластмассовых и резиновых профилей
 CZ Úhlové nůžky
 RO Foarfecă multifuncțională
 HU Gérvágó olló
 ES Tijeras multifuncionales para mangueras, tubos, molduras

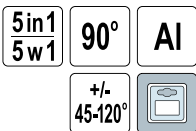

No.	Hose diameter / Srednica węża [mm]	
48350	17, 20, 27	6/24

EN Hand saw for wood
 PL Pila płatnica do drewna
 DE Handsäge für Holz
 RU Ручная пила по дереву
 CZ Ruční pila na dřevo
 RO Fierastrău „coada de vulpe” pt. lemn
 HU Rókafarkú fűrész
 ES Serrucho para carpintero

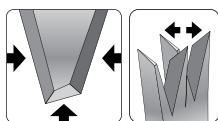
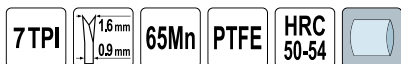

No.	L [mm]	
28385	400	12/48
28386	450	10/40
28387	500	10/40

EN Bolt cutter
 PL Nożyce do pretów
 DE Bolzenschneider
 RU Болторезы

CZ Nůžky štípací na tyče
 RO Clește pt. buloane
 HU Csapszegvágó olló
 ES Cortavarillas



No.	L [mm]	Max. cutting diameter / Maks. średnica cięcia [mm]	
49770	350	6	1/24
49771	450	8	1/12
49772	600	10	1/12
49773	750	12	6
49774	900	14	4
49775	1050	16	2

EN Hand saw for wood
 PL Pila płatnica do drewna
 DE Handsäge für Holz
 RU Ручная пила по дереву

CZ Ruční pila na dřevo
 RO Fierastrău „coada de vulpe” pt. lemn
 HU Rókafarkú fűrész
 ES Serrucho para carpintero



No.	L [mm]	
28380	400	10/40
28381	450	10/40
28382	500	10/40

EN Hand saw for wood
 PL Pila płatnica do drewna
 DE Handsäge für Holz
 RU Ручная пила по дереву
 CZ Ruční pila na dřevo
 RO Fierastrău „coada de vulpe” pt. lemn
 HU Rókafarkú fűrész
 ES Serrucho para carpintero

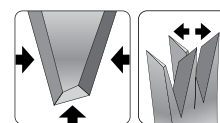
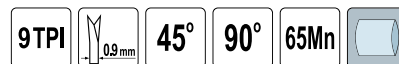

No.	L [mm]	
28370	350	12/48
28371	400	12/48
28372	450	12/48
28373	500	12/48

EN Hand saw for wood
 PL Pila platnica do drewna
 DE Handsäge für Holz
 RU Ручная пила по дереву

CZ Ruční pila na dřevo
 RO Fierastrău „coada de vulpe” pt. lemn
 HU Rókafarkú fűrész
 ES Serrucho para carpintero



No.	L [mm]	
28394	400	12/60
28395	450	12/60

EN Bow saw
 PL Pila kablakowa
 DE Bügelsäge
 RU Лучковая пила
 CZ Oblouková pila
 RO Fierastrău tip arc
 HU Keretes fűrész
 ES Sierra de arco



FLO

No.	L [mm]	
28745	530	12/24

EN Bow saw blade for wet wood
 PL Brzeszczot do drewna mokrego
 DE Bügelsägeblatt für frisches Holz
 RU Полотно для лучковой пилы по влажному дереву
 CZ Pílový list na mokré dřevo
 RO Lamă pt. lemn verde
 HU Keretes fűrészhez fűrészlap nedves fához
 ES Hoja de sierra para madera húmeda

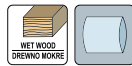

FLO

No.	L [mm]	W [mm]	
28771	530	20	60/240
28772	610	20	60/240
28773	760	20	60/240

EN Saw for gas concrete
 PL Pila do gazobetonu
 DE Gasbetonsäge
 RU Пила по газобетону с твердосплавным зубом
 CZ Pila na plynobeton
 RO Fierastrău cu placute vidia pt. BCA
 HU Fűrész gázbetonhoz
 ES Sierra para gas hormigón



VOREL

No.	L [mm]	T	
28011	600	15	6/12
28012	660	34	6/12

EN Bow saw
 PL Pila kablakowa
 DE Bügelsäge
 RU Лучковая пила

CZ Oblouková pila
 RO Fierastrău tip arc
 HU Keretes fűrész
 ES Sierra de arco



No.	L [mm]	
28740	525	24
28750	750	24

EN Bow saw
 PL Pila kablakowa
 DE Bügelsäge
 RU Лучковая пила

CZ Oblouková pila
 RO Fierastrău tip arc
 HU Keretes fűrész
 ES Sierra de arco



FLO

No.	L [mm]	
28746	610	12/24
28755	760	12/24

EN Compass saw
 PL Pila otwornica
 DE Astsäge
 RU Пила выкружная

CZ Pila otvornice
 RO Fierastrău coadă de șoarece
 HU Lyukfűrész
 ES Sierra compas



No.	L [mm]	
28650	300	30/120

EN Hand saw with replaceable blades
 PL Pila ręczna z wymiennymi brzeszczotami
 DE Handsäge mit austauschbaren Sägeblättern
 RU Ножовка со сменными полотнами
 CZ Ruční pila s vyměnitelnými čepelemi
 RO Fierastrău manual cu lame înlocuibile
 HU Kézifűrész cserélhető lapokkal
 ES Sierra de mano con hojas intercambiables



VOREL

No.	
28401	12/48

EN Hacksaw frame
 PL Pila do metalu
 DE Metallsägebogen
 RU Ножовка по металлу
 CZ Pila na kov
 RO Fierăstrău pt. metal
 HU Fémfűrész
 ES Sierra de metalo

300 mm



No.	L [mm]	
27000	300	12/48

EN Hacksaw frame
 PL Pila do metalu
 DE Metallsägebogen
 RU Ножовка по металлу
 CZ Pila na kov
 RO Fierăstrău pt. metal
 HU Fémfűrész
 ES Sierra de metalo

300 mm



No.	L [mm]	
27200	300	20/60

EN Hacksaw frame
 PL Pila do metalu
 DE Metallsägebogen
 RU Ножовка по металлу
 CZ Pila na kov
 RO Fierăstrău pt. metal
 HU Fémfűrész
 ES Sierra de metalo

300 mm



JUCO

No.	L [mm]	
27495	300	5

EN Hack saw set
 PL Zestaw pil do metalu
 DE Metallsägen
 RU Набор пил по металлу
 CZ Sada pil na kov
 RO Set bomfaiere
 HU Fémfűrész készlet
 ES Sierras de metal, juego



VOREL

No.	L [mm]	pcs / szt.	
27333	150, 300, 300	3	6/36

EN Hacksaw frame
 PL Pila do metalu
 DE Metallsägebogen
 RU Ножовка по металлу
 CZ Pila na kov
 RO Fierăstrău pt. metal
 HU Fémfűrész
 ES Sierra de metalo

250-300 mm



No.	L [mm]	
27100	250-300	12/60

EN Hacksaw frame
 PL Pila do metalu
 DE Metallsägebogen
 RU Ножовка по металлу
 CZ Pila na kov
 RO Fierăstrău pt. metal
 HU Fémfűrész
 ES Sierra de metalo

METAL 300 mm 24 TPI BI-METAL AI



VOREL

No.	L [mm]	
27322	300	6/36

EN Hacksaw frame
 PL Pila do metalu
 DE Metallsägebogen
 RU Ножовка по металлу
 CZ Pila na kov
 RO Fierăstrău pt. metal
 HU Fémfűrész
 ES Sierra de metalo

150 mm



No.	L [mm]	
27600	150	30/150

3 PCS METAL 150 mm 300 mm 24 TPI AI

EN Multi-functional hand saw with multiple blades
 PL Pila wielofunkcyjna z zestawem akcesoriów
 DE Multifunktionale magische Säge
 RU Многофункциональная волшебная пила

CZ Multifunkční ruční dřevěná píla
 RO Fierastrău multifunctional cu lame de rezerva
 HU Varázs fűrész
 ES Sierra mágica multifuncional

INCLUDED:
 - Multi-functional hand saw
 - 6 universal blades 150 mm for wood, metal and plastics
 - 2 diamond blades: round blade for glass and tiles, flat blade 6 mm
 - 2 tile cutters
 - Frame with round blade for cutting glass and with teeth for breaking glass or tiles
 - Wing bolt
 - Flat blade 175 x 20 mm for wood and plastics

W ZESTAWIE:
 - Pila modelarska
 - 6 uniwersalnych brzeszczotów 150 mm do drewna, metalu i tworzyw
 - 2 brzeszczoty diamentowe: okrągły do ceramiki i szkła oraz płaski 6 mm
 - 2 rysiki do ceramiki
 - Rama z okrągłym nożem do cięcia szkła oraz wycięciami do łamania szkła lub ceramiki
 - Nakrętka skrzydełkowa
 - Brzeszczot płaski 175 x 20 mm do agresywnego cięcia drewna i tworzyw



No.	27610	30
-----	-------	----

EN Handle for reciprocating saw blades with accessories
 PL Uchwyt do brzeszczotów bagnetowych z akcesoriami
 DE Handgriff für Säbelsägeblätter mit Zubehör
 RU Рукотка для сабельных пил с аксессуарами
 CZ Rukojeť pro pilové plátky s příslušenstvím
 RO Mâner pt. pânze de ferăstrău cu accesorii
 HU Fogantyú dugattyús fűrészlapokhoz kiegészítőkkel
 ES Mango para hojas de sierra de sable con accesorios

18 PCS	WOOD DREWNÓ	METAL	150 mm
6 TPI	14 TPI	HCS 65Mn	M2 6150



- 1/4" (6.3 mm): 5, 6 mm (L=25 mm);
- ⊕ 1/4" (6.3 mm): PH1, PH2 (L=25 mm);
- ⊕ 1/4" (6.3 mm): PZ1, PZ2 (L=25 mm);
- ⊕ 1/4" (6.3 mm): T15, T20 (L=25 mm);
- 1/4" (6.3 mm): 5, 6 mm (L=25 mm);
- 1/4" (6.3 mm): S1, S2 (L=25 mm);
- 1/4" (6.3 mm);
- ⊕ 14 TPI, 65 Mn (L=150 mm) x3;
- ⊕ 6 TPI, 6150 M2 (L=150 mm) x2

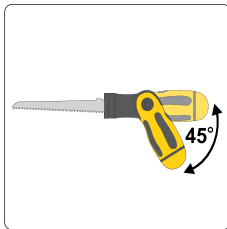

No.	L [mm]	TPI	pcs / szt.	Icon
27630	150	6, 14	18	5/20

EN Precision mitre saw
 PL Pila kątowna uchylna
 DE Kippbare Präzisions-Gehrungssäge
 RU Ступло наклонное с пилой
 CZ Pokosová úhlová píla
 RO Fierăstrău pt. tăiat la unghi
 HU Kézi gérvágó fűrész
 ES Sierra ingletadora manual



No.	Saw blade length / Długość brzeszczotu [mm]	Horizontal cutting angle / Kąt cięcia w płaszczyźnie poziomej [°]	Icon
29050	550	45, 55, 60, 72, 90	1



STEEL STAL	CERAMIC CERAMIKA
CERAMIC CERAMIKA	GRES TILE GRES
WOOD DREWNÓ	ALUMINIUM ALUMINIUM
LAMINATE LAMINAT	GLASS SZKŁO
PVC	

EN Cross-cut saw
 PL Pila poprzeczna
 DE Bauchsäge
 RU Пила двуручная

CZ Pila břichatka
 RO Joagar
 HU Keresztvágó fűrész
 ES Sierra para corte cruzado

100 cm	Icon
--------	------



No.	L [cm]	Type / Typ	Icon
28790	100	L-1000	10

EN Precision mitre saw
 PL Pila kątowna
 DE Präzisions-Gehrungssäge
 RU Ступло поворотное с пилой
 CZ Úhlová píla
 RO Fierăstrău pt. tăiat la unghi
 HU Kézi gérvágó fűrész
 ES Sierra ingletadora manual

550 mm	Icon
--------	------



No.	Saw blade length / Długość brzeszczotu [mm]	Horizontal cutting angle / Kąt cięcia w płaszczyźnie poziomej [°]	Icon
29000	550	22.5, 30, 36, 45, 90	1

550 mm	±45°	Icon
--------	------	------



- EN Miter box
- PL Skrzynka uciosowa
- DE Schneidlade
- RU Крыцно
- CZ Pokosová krabička
- RO Suport pt. tăiere la unghi
- HU Gervágó doboz
- ES Caja de ingletes



No.	Dimensions / Wymiary [mm]	
29210	300x80	10
29220	450x105	12

8

- EN Miter box
- PL Skrzynka uciosowa
- DE Schneidlade
- RU Крыцно
- CZ Pokosová krabička
- RO Suport pt. tăiere la unghi
- HU Gervágó doboz
- ES Caja de ingletes



No.	External dimensions / Wymiary zewnętrzne [mm]	
29313	280x132x102	30

- EN Miter box
- PL Skrzynka uciosowa
- DE Schneidlade
- RU Крыцно
- CZ Pokosová krabička
- RO Suport pt. tăiere la unghi
- HU Gervágó doboz
- ES Caja de ingletes



No.	Dimensions / Wymiary [mm]	
29323	326x122x78	18

- EN Miter box
- PL Skrzynka uciosowa
- DE Schneidlade
- RU Крыцно
- CZ Pokosová krabička
- RO Suport pt. tăiere la unghi
- HU Gervágó doboz
- ES Caja de ingletes



No.	External dimensions / Wymiary zewnętrzne [mm]	
29311	250x75x55	70
29312	290x90x70	50

- EN Miter box
- PL Skrzynka uciosowa
- DE Schneidlade
- RU Крыцно
- CZ Pokosová krabička
- RO Suport pt. tăiere la unghi
- HU Gervágó doboz
- ES Caja de ingletes

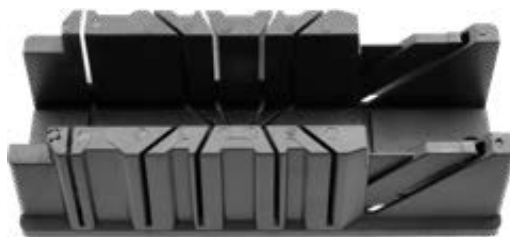

No.	Dimensions / Wymiary [mm]	
29317	233x53x56	50
29318	250x65x60	50
29319	295x80x70	30

- EN Sabre saw blades
- PL Brzeszczytły do pily szablastej
- DE Säbelsägeblatt
- RU Пильное полотно
- CZ Píllový plátek do pily ocasky
- RO Set pânze pt. fierăstrău sabie
- HU Szablyafűrészlap
- ES Hoja de sierra sable

7
PCS

STEEL
STAL

WOOD
DREWNÓ

150/130
mm

92/72
mm

4 TPI

6 TPI

8 TPI

10
TPI

14
TPI

18
TPI

24
TPI

1.0 mm

1.2 mm

BL-METAL

HCS

BL-METAL



No.	pcs / szt.	
27850	7	10/100

EN Hacksaw blade for metal
 PL Brzeszczot do metalu
 DE Metallsägeblatt
 RU Полотно по металлу

CZ Pilový list na kov
 RO Pânze fierăstrău pt. metal
 HU Fémfűrészlap
 ES Hoja de sierra para metal

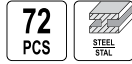

No.	Type / Typ	L [mm]	W [mm]	pcs / szt.	
27500	RAMb	300	25	72	10



No.	Type / Typ	L [mm]	W [mm]	pcs / szt.	
27501	RAMc	300	12	144	10

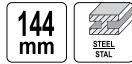

No.	Type / Typ	L [mm]	W [mm]	pcs / szt.	
27502	RAMa	300	12	144	10



No.	Type / Typ	L [mm]	W [mm]	pcs / szt.	
27505	RAMe	300	20	72	10

EN Hacksaw blade for metal
 PL Brzeszczot do metalu
 DE Metallsägeblatt
 RU Полотно по металлу
 CZ Pilový list na kov
 RO Pânze fierăstrău pt. metal
 HU Fémfűrészlap
 ES Hoja de sierra para metal



No.	Type / Typ	L [mm]	W [mm]	
27530	RAMb	300	25	70/700

EN Hacksaw blade for wood and metal
 PL Brzeszczot do drewna i metalu
 DE Sägeblatt für Holz und Metall
 RU Полотно по дереву и металлу
 CZ Pilový list na dřevo a kov
 RO Pânze fierăstrău pt. lemn și metal
 HU Fűrészlap fához és fémhez
 ES Hoja de sierra para madera y metal

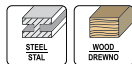

No.	Type / Typ	L [mm]	W [mm]	
27533	RAMf	300	20	70/700

EN Hacksaw blade for wood and metal
 PL Brzeszczot do drewna i metalu
 DE Sägeblatt für Holz und Metall
 RU Полотно по дереву и металлу
 CZ Pilový list na dřevo a kov
 RO Pânze fierăstrău pt. lemn și metal
 HU Fűrészlap fához és fémhez
 ES Hoja de sierra para madera y metal



No.	Type / Typ	L [mm]	W [mm]	pcs / szt.	
27506	RAMf	300	20	72	10



No.	Type / Typ	L [mm]	W [mm]	pcs / szt.	
27510	RAMd	300	25	72	10

EN Hacksaw blade for metal
 PL Brzeszczot do metalu
 DE Metallsägeblatt
 RU Полотно по металлу
 CZ Pilový list na kov
 RO Pânze fierăstrău pt. metal
 HU Fémfűrészlap
 ES Hoja de sierra para metal

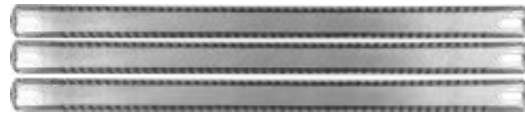

No.	Type / Typ	L [mm]	W [mm]	pcs / szt.	
27511	RAMb	300	25	3	50

EN Hacksaw blade for wood and metal
 PL Brzeszczot do drewna i metalu
 DE Sägeblatt für Holz und Metall
 RU Полотно по дереву и металлу
 CZ Pilový list na dřevo a kov
 RO Pânze fierăstrău pt. lemn și metal
 HU Fűrészlap fához és fémhez
 ES Hoja de sierra para madera y metal



No.	Type / Typ	L [mm]	W [mm]	pcs / szt.	
27513	RAMd	300	25	3	50

EN Hacksaw blade for metal
 PL Brzeszczot do metalu
 DE Metallsägeblatt
 RU Полотно по металлу
 CZ Pilový list na kov
 RO Pânze fierăstrău pt. metal
 HU Fémfűrészlap
 ES Hoja de sierra para metal



No.	L [mm]	pcs / szt.	
27520	300	12	20/120

EN Hacksaw blade for metal
 PL Brzeszczot do metalu
 DE Metallsägeblatt
 RU Полотно по металлу
 CZ Pilový list na kov
 RO Pânze fierăstrău pt. metal
 HU Fémfűrészlap
 ES Hoja de sierra para metal

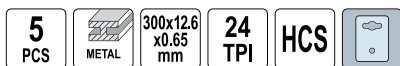

No.	L [mm]	W [mm]	TPI	pcs / szt.	
27535	300	12.6	24	5	10/200

EN Hacksaw blade for metal
 PL Brzeszczot do metalu
 DE Metallsägeblatt
 RU Полотно по металлу
 CZ Pilový list na kov
 RO Pânze fierăstrău pt. metal
 HU Fémfűrészlap
 ES Hoja de sierra para metal

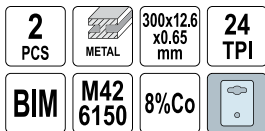

No.	L [mm]	W [mm]	TPI	pcs / szt.	
27542	300	12.6	24	2	10/200

EN Hacksaw blade for metal
 PL Brzeszczot do metalu
 DE Metallsägeblatt
 RU Полотно по металлу
 CZ Pilový list na kov
 RO Pânze fierăstrău pt. metal
 HU Fémfűrészlap
 ES Hoja de sierra para metal

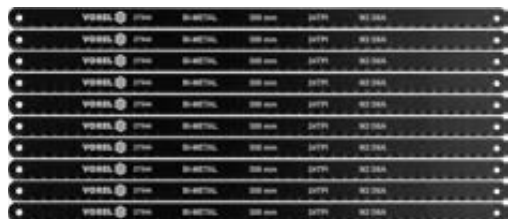
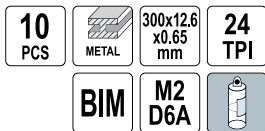

No.	L [mm]	W [mm]	TPI	pcs / szt.	
27544	300	12.6	24	10	5/50

EN Hacksaw blade for metal
 PL Brzeszczot do metalu
 DE Metallsägeblatt
 RU Полотно по металлу
 CZ Pilový list na kov
 RO Pânze fierăstrău pt. metal
 HU Fémfűrészlap
 ES Hoja de sierra para metal



No.	L [mm]	pcs / szt.	
27800	150	10	8/120

EN Hacksaw blade for metal
 PL Brzeszczot do metalu
 DE Metallsägeblatt
 RU Полотно по металлу
 CZ Pilový list na kov
 RO Pânze fierăstrău pt. metal
 HU Fémfűrészlap
 ES Hoja de sierra para metal

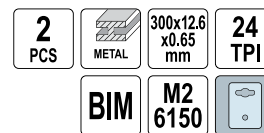

No.	L [mm]	W [mm]	TPI	pcs / szt.	
27541	300	12.6	24	2	10/200

EN Hacksaw blade for metal
 PL Brzeszczot do metalu
 DE Metallsägeblatt
 RU Полотно по металлу
 CZ Pilový list na kov
 RO Pânze fierăstrău pt. metal
 HU Fémfűrészlap
 ES Hoja de sierra para metal

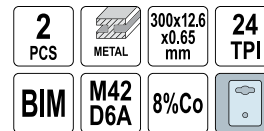

No.	L [mm]	W [mm]	TPI	pcs / szt.	
27543	300	12.6	24	2	10/200

EN Hacksaw blade for metal
 PL Brzeszczot do metalu
 DE Metallsägeblatt
 RU Полотно по металлу
 CZ Pilový list na kov
 RO Pânze fierăstrău pt. metal
 HU Fémfűrészlap
 ES Hoja de sierra para metal

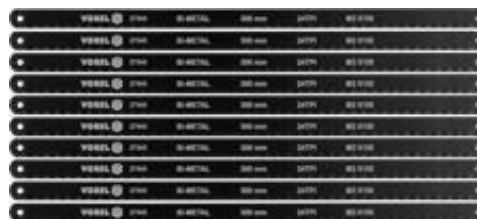
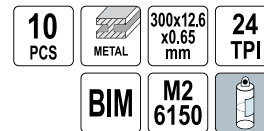

No.	L [mm]	W [mm]	TPI	pcs / szt.	
27545	300	12.6	24	10	5/50



EN Jig saw blades
 PL Brzeszczoły do wyrzynarki elektrycznej
 DE Stichsägeblätter
 RU Полотно для электролобзика

CZ Pilový list do přímočaré pily
 RO Panza fierastru circular
 HU Dekopírlap
 ES Recambio sierra de calar



VOREL **6TPI** **1.5 mm** **WOOD DREWNO** **PLYWOOD SKLEJKA** **PVC** **HCS 65Mn**

No.	L [mm]	Working length / Długość robocza [mm]	pcs / szt.	
27811	100	75	5	100/400

VOREL **6TPI** **1.2 mm** **WOOD DREWNO** **HCS 65Mn**

No.	L [mm]	Working length / Długość robocza [mm]	pcs / szt.	
27813	100	75	5	100/400

VOREL **10 TPI** **1.5 mm** **WOOD DREWNO** **CHIPBOARD PLYTA WIDORNA** **HCS 65Mn**

No.	L [mm]	Working length / Długość robocza [mm]	pcs / szt.	
27815	100	75	5	100/400

EN Jig saw blades
 PL Brzeszczoły do wyrzynarki elektrycznej
 DE Stichsägeblätter
 RU Полотно для электролобзика

CZ Pilový list do přímočaré pily
 RO Panza fierastru circular
 HU Dekopírlap
 ES Recambio sierra de calar



VOREL **6TPI** **1.2 mm** **WOOD DREWNO** **CHIPBOARD PLYTA WIDORNA** **HCS 65Mn**

No.	L [mm]	Working length / Długość robocza [mm]	pcs / szt.	
27830	100	75	5	100/400

VOREL **6TPI** **1.5 mm** **WOOD DREWNO** **PVC** **HCS 65Mn**

No.	L [mm]	Working length / Długość robocza [mm]	pcs / szt.	
27831	100	75	5	100/400

VOREL **10 TPI** **1.5 mm** **WOOD DREWNO** **PLYWOOD SKLEJKA** **HCS 65Mn**

No.	L [mm]	Working length / Długość robocza [mm]	pcs / szt.	
27833	100	75	5	100/400

VOREL **STEEL STAL** **WOOD DREWNO** **PLYWOOD SKLEJKA** **PVC**

No.	L [mm]	Working length / Długość robocza [mm]	pcs / szt.	
27834	100, 100, 76, 100, 70	75, 75, 50, 75, 45	5	100/400

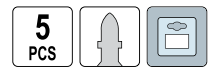

VOREL **10 TPI** **1.5 mm** **WOOD DREWNO** **PLYWOOD SKLEJKA** **PVC** **HCS 65Mn**

No.	L [mm]	Working length / Długość robocza [mm]	pcs / szt.	
27810	100	75	5	100/400

VOREL **8TPI** **1.2 mm** **WOOD DREWNO** **CHIPBOARD PLYTA WIDORNA** **PVC** **HCS 65Mn**

No.	L [mm]	Working length / Długość robocza [mm]	pcs / szt.	
27812	100	75	5	100/400

VOREL **21 TPI** **1.0 mm** **STEEL STAL** **HSS M2**

No.	L [mm]	Working length / Długość robocza [mm]	pcs / szt.	
27814	76	50	5	100/400

VOREL **STEEL STAL** **CHIPBOARD PLYTA WIDORNA** **PLYWOOD SKLEJKA** **PVC**

No.	L [mm]	Working length / Długość robocza [mm]	pcs / szt.	
27820	100, 100, 100, 76, 100	75, 75, 75, 50, 75	5	100/400

EN Wire brush
 PL Szczotka druciana
 DE Drahtbürste
 RU Щетка проволочная
 CZ Drátěný kartáč
 RO Perie de sârmă
 HU Drótkefe
 ES Cepillo de alambre



VOREL

No.	Row quantity / Liczba rzędów	
06930	3	12/120
06940	4	12/120
06950	5	12/120
06960	6	12/120

EN Wire brush set
 PL Zestaw szczotek drucianych
 DE Drahtbürsten-Satz
 RU Набор проволочных щёток
 CZ Sada kartáčů drátěných
 RO Set perii de sârmă
 HU Drótkefe készlet
 ES Juego de cepillos de alambre



VOREL

No.	L [mm]	
06963	170	24/240
06964	220	24/72

EN Brass wire brush
 PL Szczotka druciana mosiężna
 DE Messingdrahtbürste
 RU Щетка проволочная латунная
 CZ Drátěný kartáč mosazný
 RO Perie de sârmă din alamă
 HU Réz sörtés drótkéfe
 ES Cepillo de alambre de latón



No.	Ø [mm]	max. C [min ⁻¹]	Icon
06965			25/100

EN Circular brush - crimped wire
 PL Szczotka tarczowa, drut karbowany
 DE Stahldraht - Kegelfürste
 RU Щетка-крацевка с гайкой
 CZ Kotoučový kartáč, rýhovaný drát
 RO Perie circulară, sârmă ondulată
 HU Tarcás drótkéfe, sodrott dróttal
 ES Cepillo redondo de alambre ondulado



No.	Ø [mm]	max. C [min ⁻¹]	Icon
06972	100	12500	12/72
06973	115	12500	12/72

EN Circular brush - twisted wire
 PL Szczotka tarczowa z gwintem, drut splatany
 DE Stahldraht - Zopf - Kegelfürste
 RU Щетка-крацевка-усиленная
 CZ Kotoučový kartáč, pletený drát
 RO Perie circulară, sârmă împletită
 HU Tarcás drótkéfe, egyenes dróttal
 ES Cepillo redondo de alambre conico



No.	Ø [mm]	max. C [min ⁻¹]	Icon
06977	100	12500	12/48

EN Circular brush - twisted wire
 PL Szczotka tarczowa, drut splatany
 DE Stahldraht - Scheibenbürste
 RU Дисковая щетка витая
 CZ Kotoučový kartáč
 RO Perie circulară, sârmă împletită
 HU Tarcás drótkéfe
 ES Cepillo redondo de alambre conico



No.	Ø [mm]	max. C [min ⁻¹]	Icon
06981	100	11000	12/72
06982	115	11000	12/48
06983	150	9000	12/36

EN Cup brush - crimped wire
 PL Szczotka czolowa z gwintem, drut karbowany
 DE Stahldraht - Topfbürste
 RU Щетка-крацевка чашка с гайкой

CZ Čelní kartáč, rýhovaný drát
 RO Perie cupă, sârmă ondulată
 HU Homlok drótkéfe, sodrott dróttal
 ES Cepillo de copa de alambre ondulado



No.	Ø [mm]	max. C [min ⁻¹]	Icon
06970	75	1200	12/72
06971	100	8500	6/24

EN Cup brush - twisted wire
 PL Szczotka czolowa z gwintem, drut splatany
 DE Stahldraht - Zopf fürste
 RU Щетка - крацевка круговая крученая щетка крацевка (чашка)
 CZ Čelní kartáč, pletený drát
 RO Perie cupă, sârmă împletită
 HU Homlok drótkéfe, sodrott dróttal
 ES Cepillo de copa de alambre conico



No.	Ø [mm]	max. C [min ⁻¹]	Icon
06974	65	12500	12/36
06975	80	8500	12/36
06976	100	8500	6/24

EN Circular brush - crimped wire
 PL Szczotka tarczowa, drut karbowany
 DE Stahldraht - Scheibenbürste
 RU Щетка-крацевка латунированная сталь
 CZ Kotoučový kartáč
 RO Perie circulară, sârmă ondulată
 HU Tarcás drótkéfe
 ES Cepillo redondo de alambre ondulado



No.	Ø [mm]	max. C [min ⁻¹]	Icon
06978	125	6000	12/72
06979	150	6000	12/36
06980	200	4500	12/24

EN Circular brush - crimped wire
 PL Szczotka tarczowa z trzpieniem, drut karbowany
 DE Stahldraht - Scheibenbürste
 RU Щетка круговая со стержнем
 CZ Okružní kartáč drátěný se stopkou
 RO Perie rotundă pt. bormasina
 HU Tarcás drótkéfe, nyéllel
 ES Cepillo redondo



No.	Ø [mm]	max. C [min ⁻¹]	Icon
06985	75	4500	10/120
06986	100	4500	12/120

EN Cup brush – crimped wire
 PL Szczotka czolowa z trzpieniem, drut karbowany
 DE Stahldraht - Topfbürste
 RU Щетка-крацевка со стержнем чашка
 CZ Čelní kartáč, z hrotem, rýhovaný drát
 RO Perie cupă cu ax, sârmă ondulată
 HU Homlok drótkéfe, nyéllel, sodrott dróttal
 ES Cepillo de copa con mandril, de alambre ondulado



VOREL

No.	Ø [mm]	max Ω [min ⁻¹]	
06987	50	4500	10/180
06988	75	4500	12/96

EN Steel wire brush set
 PL Szczotka druciana okrągła
 DE Stahldraht - Bürstensatz
 RU Набор щеток
 CZ Drátěné kartáče kulaté
 RO Perii de sârmă rotunde
 HU Kerek drótkéfe
 ES Cepillos de alambre redontos



No.	max Ω [min ⁻¹]	
06990	4500	20/120

EN Circular brush - twisted wire
 PL Szczotka tarczowa z trzpieniem, drut splatany
 DE Stahldraht-Scheibenbürste
 RU Щетка круговая со стержнем
 CZ Okružní kartáč drátěný se stopkou
 RO Perie rotunda pt. bormasina
 HU Tarcás drótkéfe, nyéllel
 ES Cepillo redondo



VOREL

No.	Ø [mm]	max Ω [min ⁻¹]	
06993	75	12500	30/180

EN Hook and loop rubber disc
 PL Przystawka z rzepem
 DE Klett-Haftsteller mit Dorn
 RU Шлифовальный диск с липучкой

CZ Příkladné zařízení ze zipem
 RO Suport disc abraziv
 HU Kistál tapadókoronggal
 ES Disco de goma con velcro



VOREL

No.	Ø [mm]	max Ω [min ⁻¹]	
08312	125	2000	12/120

EN Wire brush set
 PL Szczotki druciane z trzpieniem, drut karbowany
 DE Stahldraht-Bürstensatz
 RU Набор щеток-крацевок со стержнем
 CZ Okružní kartáč drátěný se stopkou
 RO Perii de sârmă cu ax
 HU Tarcás drótkéfe, nyéllel, sodrott dróttal
 ES Cepillos de alambre con mandril



VOREL

No.	Ø [mm]	max Ω [min ⁻¹]	
06989	25, 50, 50	4500	12/60

EN Cup brush – crimped wire
 PL Szczotka czolowa z trzpieniem, drut karbowany
 DE Stahldraht - Topfbürste
 RU Щетка-крацевка со стержнем чашка
 CZ Čelní kartáč, z hrotem, rýhovaný drát
 RO Perie cupă cu ax, sârmă ondulată
 HU Homlok drótkéfe, nyéllel, sodrott dróttal
 ES Cepillo de copa con mandril, de alambre ondulado



VOREL

No.	Ø [mm]	max Ω [min ⁻¹]	
06992	24	4500	12/96

EN Cup brush - twisted wire
 PL Szczotka czolowa z trzpieniem, drut splatany
 DE Stahldraht - Zopfgrundbürste
 RU Щетка-крацевка витая со стержнем
 CZ Čelní kartáč, z hrotem, pletený drát
 RO Perie cupă cu ax, sârmă împletită
 HU Homlok drótkéfe, nyéllel, egyenes dróttal
 ES Cepillo de copa con mandril, de alambre conico



VOREL

No.	Ø [mm]	max Ω [min ⁻¹]	
06995	22	4500	24/192
06994	75	12500	12/96

EN Rubber disc with arbor
 PL Przystawka-dysk z trzpieniem
 DE Klett-Haftsteller mit Dorn
 RU Шлифовальный диск с хвостовиком

CZ Nástavec-kotouč s upínacím trnem
 RO Suport disc pt. polizor unghiular
 HU Csiszoló korong nyéllel
 ES Disco de goma con mandril



VOREL

No.	Ø [mm]	max Ω [min ⁻¹]	
08314	125	3250	30/120

EN Hook and loop rubber disc for angle grinder
 PL Euro dysk do kątowniki z rzepem
 DE Klett-Haftsteller mit Gewindeflansch
 RU Насадка пластиковая жесткая под круг на липучке
 CZ Euro disk do úhelníků ze zipem
 RO Suport disc pt. polizor unghiular
 HU Euro lemez élhez, tapadókoronggal
 ES Disco de goma para angul con velcro



VOREL

No.	Ø [mm]	max. C [min ⁻¹]	
08315	125	12200	30/120

EN Hook and loop rubber disc for angle grinder
 PL Tarcza do kątowniki z rzepem
 DE Klett-Gummihaftstützteller
 RU Насадка шлифовальная под круг на липучке
 CZ otouč do úhelníků ze zipem
 RO Suport disc pt. polizor unghiular
 HU Euro lemez élhez, tapadókoronggal
 ES Disco para el pulidor angular con sujetador velcro



VOREL

No.	Ø [mm]	max. C [min ⁻¹]	
08318	125	12000	25/100

EN Hook and loop rubber disc for angle grinder
 PL Euro dysk do kątowniki z rzepem
 DE Klett-Haftstützteller mit Gewindeflansch
 RU Шлифовальный диск под круг с липучкой
 CZ Euro disk do úhelníků ze zipem
 RO Suport disc pt. polizor unghiular
 HU Euro lemez élhez, tapadókoronggal
 ES Disco de goma para angul con velcro



**PRO
FILE**

No.	Ø [mm]	max. C [min ⁻¹]	
08500	125	10000	20
08510	150	8500	20

EN Rubber disc for angle grinder and drill machine
 PL Przystawka do szlifierek kątownych i wiertarek
 DE Klett-Haftstützteller mit Gewindeflansch und Ersatzdorn
 RU Насадка шлифовальная с липучкой + переход
 CZ Koutouč do úhelníků ze zipem
 RO Suport disc pt. polizor unghiular
 HU Euro lemez élhez, tapadókoronggal
 ES Disco de goma para ancul con mandril

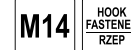
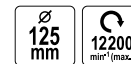

VOREL

No.	Ø [mm]	max. C [min ⁻¹]	
08316	125	12200	30/120

EN Hook and loop rubber disc
 PL Przystawka z rzepem
 DE Klett-Haftstützteller mit Dorn
 RU Насадка резиновая с липучкой
 CZ Přídavné zařízení ze zipem
 RO Suport disc abraziv
 HU Kistál tapadókoronggal
 ES Disco de goma con velcro



**PRO
FILE**

No.	Ø [mm]	max. C [min ⁻¹]	
08400	125	2000	20

EN Rubber disc for angle grinder
 PL Euro dysk do kątowniki z trzpieniem
 DE Klett-Haftstützteller mit Gewindeflansch und Ersatzdorn
 RU Насадка шлифовальная с липучкой + переход
 CZ Euro disk do úhelníků
 RO Suport disc pt. polizor unghiular
 HU Euro lemez élhez, tapadókoronggal
 ES Disco de goma para ancul con mandril



**PRO
FILE**

No.	Ø [mm]	max. C [min ⁻¹]	
08501	125	10000	20

EN Hook and loop rubber disc for angle grinder
 PL Tarcza do kątowniki z rzepem nr 2
 DE Klett-Gummihaftstützteller mit Gewindeflansch
 RU Насадка шлифовальная под круг на липучке
 CZ Kotoúč do úhelníků ze zipem číslo 2
 RO Suport disc pt. polizor unghiular
 HU Euro lemez élhez, tapadókoronggal, 2. sz.
 ES Disco de goma para angul con velcro



PRO

No.	Ø [mm]	max. C [min ⁻¹]	
08511	125	10000	20

EN Polishing felt disc
 PL Filc polerski na rzep
 DE Filzpolierdisc
 RU Полировальная насадка из фетра на липучке
 CZ Leštící plstěnc na zip
 RO Disc pasla de lustruit cu scai
 HU Polirozó filc tapadókoronggal
 ES Fieltro de pulir con velcro



PRO

No.	Ø [mm]	max. C [min ⁻¹]	
08522	125	10000	100

EN Lock knife
 PL Nóż składany sierpak
 DE Klappmesser
 RU Нож складной
 CZ Dřevěný nůž srpek
 RO Cutit secera maner lemn
 HU Hajlított pengéjű kés, fanyelű
 ES Cuchillo falciforme de madera



VOREL

No.	Blade length / Długość ostrza [mm]	
76621	75	10/100

EN Cable knife
 PL Nóż monterski
 DE Montagemesser
 RU Нож электрика
 CZ Montážní nůž
 RO Cutit pt. decablat
 HU Szerelőkés
 ES Cuchillo de montaje



No.	
76640	50

EN Polishing felt disc
 PL Rzep do tarczy gumowej (przylepiec)
 DE Klettdisk für Gummistützteller
 RU Круг с липучкой
 CZ Zip do pryžového kotoúče (suchý zip)
 RO Disc pasla de lustruit cu scai
 HU Tapadókorong gumitárcsához
 ES Velcro para disco de goma



VOREL

No.	Ø [mm]	
08520	150	10/100
08521	125	10/100

EN Folding knife
 PL Nóż składany
 DE Klappmesser
 RU Нож складной
 CZ Kapesní nůž
 RO Briceag
 HU Zsebkés
 ES Navaja

5
PCS

VOREL

No.	Blade size / Rozmiar ostrza [mm]	
76526	61x33x0.5	12/72

EN Electrician's knife
 PL Nóż monterski składany
 DE Montagemesser
 RU Нож складной
 CZ Montážní nůž
 RO Cutit pt. decablat
 HU Szerelőkés
 ES Cuchillo de montaje



VOREL

No.	Blade length / Długość ostrza [mm]	
76622	85	10/100

EN Cable knife
 PL Nóż monterski
 DE Montagemesser
 RU Нож электрика
 CZ Montážní nůž
 RO Cutit pt. decablat
 HU Szerelőkés
 ES Cuchillo de montaje



No.	
76650	50

- EN Cable knife
- PL Nóż sierpak
- DE Klappmesser
- RU Нож садовый
- CZ Dřevěný nůž srpek
- RO Cuțit tip seceră
- HU Hajlított pengéjű kés, fanyelű
- ES Cuchillo falciforme de madera



No.		
76660		50

- EN Safety knife
- PL Nożyk bezpieczny
- DE Sicherheitsmesser
- RU Безопасный нож
- CZ Bezpečnostní nůž
- RO Cutter
- HU Biztonsági kés
- ES Cúter de seguridad



No.	Blade size / Rozmiar ostrza [mm]	
76040	40x20	36/288

- EN Replacement blades for safety knife
- PL Ostrza zapasowe do nożyka bezpiecznego
- DE Ersatzklingen für Sicherheitsmesser
- RU Сменные лезвия для безопасного ножа
- CZ Náhradní čepele pro bezpečnostní nůž
- RO Lame de rezervă pt. cutter
- HU Tartalék penge biztonságási késhez
- ES Cuchillas de recambio para cúter de seguridad

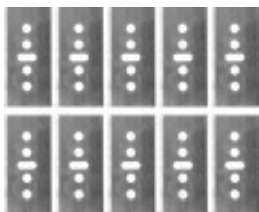

No.	Blade size / Rozmiar ostrza [mm]	pcs / szt.	
76041	40x20x0.4	10	12/144

For 76040
Dla 76040

- EN Spare blades for utility knife
- PL Ostrza zapasowe do nożyka
- DE Ersatzklingen für Cuttermesser
- RU Запасные лезвия для ножа
- CZ Náhradní bity do nože
- RO Lame de rezervă pt. cutter
- HU Tartalék pengék a késhez
- ES Hojas de repuesto para cuchillo



No.	Blade size / Rozmiar ostrza [mm]	For / Dla	
76010	61x19	76000, 76011, 76015	100/600

- EN Safety knife
- PL Nożyk bezpieczny
- DE Sicherheitsmesser
- RU Безопасный нож
- CZ Bezpečnostní nůž
- RO Cutter
- HU Biztonsági kés
- ES Cúter de seguridad



No.	Blade size / Rozmiar ostrza [mm]	
76035	61x19	24/288

- EN Replacement blades for safety knife
- PL Ostrza zapasowe do nożyka bezpiecznego
- DE Ersatzklingen für Sicherheitsmesser
- RU Сменные лезвия для безопасного ножа
- CZ Náhradní čepele pro bezpečnostní nůž
- RO Lame de rezervă pt. cutter
- HU Tartalék penge biztonságási késhez
- ES Cuchillas de recambio para cúter de seguridad

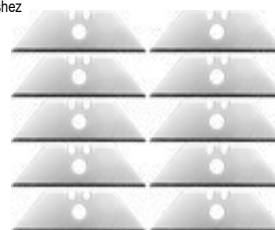
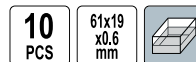

No.	Blade size / Rozmiar ostrza [mm]	pcs / szt.	
76036	61x19x0.6	10	24/144

For 76035
Dla 76035

- EN Utility knife with trapezoid blade
- PL Nożyk z ostrzem trapezowym
- DE Cuttermesser mit Trapezklinge
- RU Нож с выдвигающим трапециевидным лезвием
- CZ Nůž s lichoběžníkovou čepelí
- RO Cutter cu lamă trapezoidală retractabilă
- HU Trapéz pengés kés
- ES Cortador trapezoidal retráctil



No.	Blade size / Rozmiar ostrza [mm]	
76000	61x19	25/200

- EN Cutting knife with blade compartment
- PL Nóż instalacyjny z magazynkiem
- DE Universalmesser
- RU Нож обрезиненный
- CZ Univerzální nůž
- RO Cuțit cu lamă trapezoidală retractabilă
- HU Univerzális kés
- ES Cutter con cargador

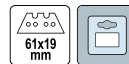

No.	Blade size / Rozmiar ostrza [mm]	
76011	61x19	12/48

EN Utility knife with trapezoid blade
 PL Nożyk z ostrzem trapezowym
 DE Cuttermesser mit Trapezklinge
 RU Нож с выдвигаемым трапециевидным лезвием
 CZ Nůž s lichoběžníkovou čepelí
 RO Cutter cu lamă trapezoidală retractabilă
 HU Trapéz pengés kés
 ES Cortador trapezoidal retráctil

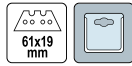

No.	Blade size / Rozmiar ostrza [mm]	
76015	61x19	12/72

EN Safety knife
 PL Nożyk bezpieczny
 DE Sicherheitsmesser
 RU Безопасный нож
 CZ Bezpečnostní nůž
 RO Cutter
 HU Biztonsági kés
 ES Cúter de seguridad



No.		
76030		24/144

EN Utility knife
 PL Nożyk z lamany ostrzem
 DE Abbrechklingen-Messer
 RU Нож строительный
 CZ Nůž ulamovací
 RO Cutter cu lamă retractabilă
 HU Barkácskés
 ES Cortador retráctil



No.	Blade width / Szerokość ostrza [mm]	
76184	18	12/120

EN Utility knife
 PL Nożyk z lamany ostrzem
 DE Abbrechklingen-Messer
 RU Нож строительный
 CZ Nůž ulamovací
 RO Cutter cu lamă retractabilă
 HU Barkácskés
 ES Cortador retráctil

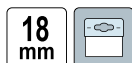

No.	Blade width / Szerokość ostrza [mm]	
76185	18	60/600

EN Utility knife
 PL Nożyk z lamany ostrzem
 DE Abbrechklingen-Messer
 RU Нож строительный
 CZ Nůž ulamovací
 RO Cutter cu lamă retractabilă
 HU Barkácskés
 ES Cortador retráctil



No.	Blade width / Szerokość ostrza [mm]	
76101	9	60/360

EN Utility knife
 PL Nożyk z lamany ostrzem
 DE Abbrechklingen-Messer
 RU Нож строительный
 CZ Nůž ulamovací
 RO Cutter cu lamă retractabilă
 HU Barkácskés
 ES Cortador retráctil



No.	Blade width / Szerokość ostrza [mm]	
76160	9	24/288

EN Utility knife
 PL Nożyk z lamany ostrzem
 DE Abbrechklingen-Messer
 RU Нож строительный
 CZ Nůž ulamovací
 RO Cutter cu lamă retractabilă
 HU Barkácskés
 ES Cortador retráctil

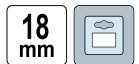

No.	Blade width / Szerokość ostrza [mm]	
76180	18	40/400

EN Utility knife
 PL Nożyk z lamany ostrzem
 DE Abbrechklingen-Messer
 RU Нож строительный
 CZ Nůž ulamovací
 RO Cutter cu lamă retractabilă
 HU Barkácskés
 ES Cortador retráctil

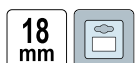

No.	Blade width / Szerokość ostrza [mm]	
76181	18	50/400

EN Utility knife
 PL Nożyk z łamanym ostrzem
 DE Abbrechklingen-Messer
 RU Нож строительный
 CZ Nůž ulamovací
 RO Cutter cu lamă retractabilă
 HU Barkácskés
 ES Cortador retráctil



No.	Blade width / Szerokość ostrza [mm]	
76182	18	24/240

EN Utility knife
 PL Nożyk z łamanym ostrzem
 DE Abbrechklingen-Messer
 RU Нож строительный
 CZ Nůž ulamovací
 RO Cutter cu lamă retractabilă
 HU Barkácskés
 ES Cortador retráctil



No.	Blade width / Szerokość ostrza [mm]	
76186	18	12/144

EN Spare blades for utility knife
 PL Ostrza zapasowe do nożyka
 DE Abbrechklingen für Cuttermesser
 RU Запасные лезвия для ножа
 CZ Náhradní břity do nože
 RO Lame de rezervă pt. cutter
 HU Tartalék pengék a késhez
 ES Hojas de repuesto para cuchillo



No.	Blade width / Szerokość ostrza [mm]	pcs / szt.	
76214	25	5	36/288

EN Utility knife set
 PL Zestaw nożyków
 DE Universal-Messersatz
 RU Набор ножей pistolетных

CZ Sada ulamovacích nožů
 RO Set cuttere
 HU Univerzális kés készlet
 ES Cuchillos de papelería



No.	pcs / szt.	
76230	3	50/200

EN Utility knife
 PL Nożyk z łamanym ostrzem
 DE Abbrechklingen-Messer
 RU Нож строительный
 CZ Nůž ulamovací
 RO Cutter cu lamă retractabilă
 HU Barkácskés
 ES Cortador retráctil

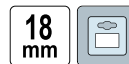

No.	Blade width / Szerokość ostrza [mm]	
76183	18	24/144

EN Utility knife
 PL Nożyk z łamanym ostrzem
 DE Abbrechklingen-Messer
 RU Нож строительный
 CZ Nůž ulamovací
 RO Cutter cu lamă retractabilă
 HU Barkácskés
 ES Cortador retráctil



No.	Blade width / Szerokość ostrza [mm]	
76190	25	12/72

EN Spare blades for utility knife
 PL Ostrza zapasowe do nożyka
 DE Abbrechklingen für Cuttermesser
 RU Запасные лезвия для ножа
 CZ Náhradní břity do nože
 RO Lame de rezervă pt. cutter
 HU Tartalék pengék a késhez
 ES Hojas de repuesto para cuchillo



No.	Blade width / Szerokość ostrza [mm]	pcs / szt.	
76210	9	5	100/600
76220	18	5	100/600

EN Utility knife set
 PL Zestaw nożyków
 DE Universal-Messersatz
 RU Набор ножей pistolетных

CZ Sada ulamovacích nožů
 RO Set cuttere
 HU Univerzális kés és műanyag kaparó készlet
 ES Cuchillos de papelería



No.	pcs / szt.	
76250	5	30/150

EN Window scraper
 PL Skrobak do szyby
 DE Fensterabstreicher
 RU Скребок для стекла

CZ Škrabák na skla
 RO Răzuitor pt. geamuri
 HU Kaparó üveghez
 ES Rascador de cristales



No.	Blade width / Szerokość ostrza [mm]	
06820	60	50/200

EN Oil glass cutter
 PL Nóż olejowy do szkła
 DE Ölglasschneider
 RU Стеклорез масляный
 CZ Rezák na sklo
 RO Diamant pt. tăiat sticlă cu ulei
 HU Olajkés üveghez
 ES Cuchillo de aceite para cristales



No.		
05050		6/120

EN Automatic center punch
 PL Punktak automatyczny
 DE Automatischer Körner
 RU Автоматический кернер
 CZ Automatické důlčikem
 RO Punctator automat
 HU Automatikus központ punci
 ES Centro automático punch



VOREL

No.	L [mm]	
35240	140	12/72

EN Wood carving knife set
 PL Zestaw nożyków precyzyjnych z ostrzami
 DE Präzisionsmessersatz
 RU Набор ножей для резьбы по дереву

CZ Sada přesných nožů s břitý
 RO Set cutite prelucrate lemn
 HU Modellező készlet pengékkel
 ES Juego de cutters precisos con cuchillos



No.	pcs / szt.	
76305	16	25/100

EN Glass cutter
 PL Nóż do szkła
 DE Glasschneider
 RU Стеклопез
 CZ Nůž do skla
 RO Diamant pt. sticlă
 HU Kés üveghez
 ES Cuchillo para cristal



No.		
05100		12/240

EN Scriber
 PL Rysik traserski
 DE Reißnadel
 RU Чертилка по металлу
 CZ Rysovací jehla
 RO Ac de trasat
 HU Karctu
 ES Trazador



VOREL

No.	L [mm]	
35210	140	12/72

EN Double edge scraper
 PL Cyklina ręczna
 DE Ziehklingenschaber
 RU Ручная цикля
 CZ Ruční škrabka
 RO Rascheta dubla
 HU Kézi kaparó
 ES Rasqueta manual



No.	Blade size / Rozmiar ostrza [mm]	
06840	40	10
06860	60	10

EN Scissors
 PL Nożyczki
 DE Haushaltsschere
 RU Ножницы
 CZ Nůžky
 RO Foarfecă
 HU Olló
 ES Tijeras



VOREL

No.	L [mm]	
76311	170	12/144

EN Scissors
 PL Nożyczki
 DE Haushaltsschere
 RU Ножницы
 CZ Nůžky
 RO Foarfecă
 HU Olló
 ES Tijeras



No.	L [mm]	
76312	220	12/144

EN Leather hole punch
 PL Dziurkacz nastawny
 DE Einstellbarer Locher
 RU Дырокол pistolетный

CZ Děrovací kleště nastavitelné
 RO Perforator ajustabil
 HU Állítható lyukasztó
 ES Pinza perforadora ajustable

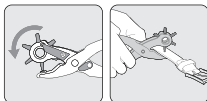

No.	L [mm]	
43600	220	6/36

EN Pliers for plastic snaps
 PL Praska do zaciskania nap
 DE Zange für Plastic Moschettoni
 RU Клещи для пластиковых защелками
 CZ Pliers pro plastovou nezaradne
 RO Presă manuală pt. perforat plastic
 HU Fogó műanyag pattan
 ES Alicates para la snaps de plástico



No.	Hole diameter / Średnica otworu [mm]	
76710	10, 12, 14	30/60

EN Punch set
 PL Zestaw przebijaków do skóry
 DE Lederlocherstet
 RU Набор пробойников для кожи
 CZ Sada průbojníků na kůži
 RO Set preducele
 HU Bőryukasztó készlet
 ES Juego de perforar en piel

No.	Hole diameter / Średnica otworu [mm]	
76700	2, 2.5, 3.2, 4, 4.8, 5.5, 6.4, 8, 9.5, 11.1, 12.7, 14, 15.8, 19, 22	5/20

EN Scissors set
 PL Zestaw nożyczek
 DE Haushaltsscherensatz
 RU Ножницы бытовые в наборе
 CZ Nůžky
 RO Set foarfeci
 HU Olló
 ES Tijeras



No.	L [mm]	pcs / szt.	
76314	140, 170, 190, 220, 250	5	12/24

EN Leather hole punch & grommet setting tool kit
 PL Zestaw kaletniczy
 DE Taschner Satz
 RU Набор для установки кнопок и люверсов
 CZ Děrovačka na pásky
 RO Set clesti prelucrare piele
 HU Szegecselő és lyukasztó készlet
 ES Kit de cuero herramientas neumáticos de perforación y ojal

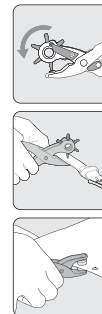

No.		
43603		5/20

EN Punch set
 PL Zestaw przebijaków do skóry
 DE Lederlocherstet
 RU Набор пробойников для кожи
 CZ Sada průbojníků na kůži
 RO Set preducele
 HU Bőryukasztó készlet
 ES Juego de perforar en piel



No.	Hole diameter / Średnica otworu [mm]	
76705	2.5, 3, 4, 5, 6, 7, 8, 9, 10	10/80



EN Rabbet plane
 PL Strug kątnik czołowy
 DE Simshobel
 RU Фальцгебель двойной деревянный
 CZ Hoblík čelní drážkovník
 RO Rindea frontală unghilulară
 HU Párkánygyalu, homlok
 ES Cepillo de ranura



No.	Blade width / Szerokość ostrza [mm]	L [mm]	
25830	30	245	20

EN Block plane
 PL Metalowy strug do drewna
 DE Metallhobel für Holz
 RU Металлический рубанок по дереву
 CZ Kovový hoblík do dřeva
 RO Rindea
 HU Fémgyalu
 ES Cepillo metálico para madera



No.	Blade width / Szerokość ostrza [mm]	
25885	42	50

EN Block plane
 PL Metalowy strug do drewna
 DE Metallhobel für Holz
 RU Металлический рубанок по дереву
 CZ Kovový hoblík do dřeva
 RO Rindea
 HU Fémgyalu
 ES Cepillo metálico para madera



No.	Blade width / Szerokość ostrza [mm]	
25887	44	30

EN Plasterboard edge planer
 PL Strug do krawędzi płyt gipsowo-kartonowych
 DE Gipskarton-Kantenhobel
 RU Рубанок кромочный для гипскартона
 CZ Hoblík na hrany sádrokartonu
 RO Rindea pt. gips carton
 HU Gipszkarton élgyalu
 ES Cepillo biselador para cartón yeso



No.	
25972	50

EN Mini block plane
 PL Metalowy strug modelarski
 DE Metallhobel für Modellbau
 RU Металлический рубанок для моделирования
 CZ Kovový modelářský hoblík
 RO Mini rindea
 HU Mini fémgyalu
 ES Cepillo mini



No.	Blade width / Szerokość ostrza [mm]	
25881	26	10/50

EN Block plane
 PL Metalowy strug do drewna
 DE Metallhobel für Holz
 RU Металлический рубанок по дереву
 CZ Kovový hoblík do dřeva
 RO Rindea
 HU Fémgyalu
 ES Cepillo metálico para madera



No.	Blade width / Szerokość ostrza [mm]	
25886	42	36

EN Plasterboard edge planer
 PL Strug do krawędzi płyt gipsowo-kartonowych
 DE Gipskarton-Kantenhobel
 RU Рубанок кромочный для гипскартона
 CZ Hoblík na hrany sádrokartonu
 RO Rindea pt. gips carton
 HU Gipszkarton élgyalu
 ES Cepillo biselador para cartón yeso

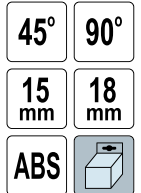

No.	
25971	50

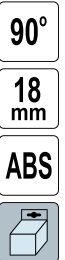

EN Steel file
 PL Pilnik do metalu
 DE Metallfeile
 RU Напильник по металлу
 CZ Zámečnický pilník
 RO Pila de lăcătușerie
 HU Lakatos reszelő
 ES Lima para metal



No.	L [mm]	
25160	200	25/100

EN Steel file
 PL Pilnik do metalu
 DE Metallfeile
 RU Напильник по металлу
 CZ Zámečnický pilník
 RO Pila de lăcătușerie
 HU Lakatos reszelő
 ES Lima para metal



No.	L [mm]	
25162	200	25/100

EN Steel file
 PL Pilnik do metalu
 DE Metallfeile
 RU Напильник по металлу

CZ Zámečnický pilník
 RO Pila de lăcătușerie
 HU Lakatos reszelő
 ES Lima para metal



No.	L [mm]	
25164	200	25/100

EN Steel file set
 PL Zestaw pilników do metalu
 DE Metallfeilen-Satz
 RU Набор напильников по металлу
 CZ Sada pilníků zámečnických
 HU Lakatos reszelő készlet
 ES Juego de limas para metal

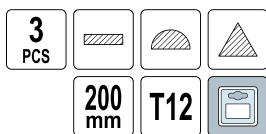

No.	L [mm]	pcs / szt.	
25165	200	3	10/20

EN Steel file
 PL Pilnik do metalu
 DE Metallfeile
 RU Напильник по металлу
 CZ Zámečnický pilník
 RO Pila de lăcătușerie
 HU Lakatos reszelő
 ES Lima para metal



No.	L [mm]	
25161	200	25/100

EN Steel file
 PL Pilnik do metalu
 DE Metallfeile
 RU Напильник по металлу
 CZ Zámečnický pilník
 RO Pila de lăcătușerie
 HU Lakatos reszelő
 ES Lima para metal



No.	L [mm]	
25163	200	25/100



No.	L [mm]	pcs / szt.	
25166	200	5	10/20

EN Needle file set
 PL Zestaw pilników iglaków
 DE Nadelfeilens-Satz
 RU Набор надфилей

CZ Sada jehlových pilníků
 RO Set pile conice
 HU Tűreszelő készlet
 ES Juego de limas de aguja



No.	L [mm]	Toolholder size / Rozmiar uchwyty narzędziowego (mm)	pcs / szt.	Package	
25370	150	4	5		20/200
25380	150	4	10		25/100
25390	150	4	12		25/100

EN Needle file set
 PL Zestaw pilników iglaków
 DE Nadelfeilens-Satz
 RU Набор надфилей
 CZ Sada jehlových pilníků
 RO Set pile conice
 HU Tűreszelő készlet
 ES Juego de limas de aguja



6
PCS

VOREL

No.	L [mm]	pcs / szt.	
25352	160	6	20/160
25351	140	6	20/160
25353	180	6	20/120

EN Diamond whetstone
 PL Osełka diamentowa
 DE Diamant Schleifstein
 RU Алмазный брусок

CZ Diamond brousek
 RO Piatra abraziva diamantata
 HU Kétoldalas gyémánt fenőkő
 ES Piedra de afilar diamantada

G400

150x50
mm



VOREL

No.	Grit / Ziamistość	W [mm]	L [mm]	
26131	G400	50	150	20/100

EN Diamond whetstone set
 PL Zestaw oselek diamentowych
 DE Diamant Schleifstein
 RU Алмазный брусок
 CZ Diamond brousek
 RO Piatra abraziva diamantata
 HU Kétoldalas gyémánt fenőkő
 ES Piedra de afilar diamantada

3
PCS

75x25
mm

G180

G260

G360

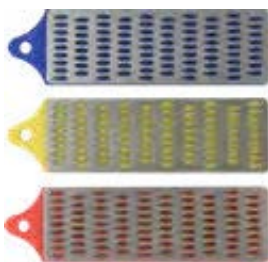

VOREL

No.	Grit / Ziamistość	W [mm]	L [mm]	
26140	G180, G260, G360	25	75	25/100

EN Needle file set
 PL Zestaw pilników iglaków
 DE Nadelfeilens-Satz
 RU Набор надфилей
 CZ Sada jehlových pilníků
 RO Set pile conice
 HU Tűreszelő készlet
 ES Juego de limas de aguja

6
PCS



No.	pcs / szt.	
25360	6	20/200

EN Diamond whetstone
 PL Osełka diamentowa
 DE Diamant Schleifstein
 RU Алмазный брусок

CZ Diamond brousek
 RO Piatra abraziva diamantata
 HU Kétoldalas gyémánt fenőkő
 ES Piedra de afilar diamantada

G600

150x50
mm



VOREL

No.	Grit / Ziamistość	W [mm]	L [mm]	
26130	G600	50	150	20/100

EN Diamond whetstone
 PL Osełka diamentowa
 DE Diamant Schleifstein
 RU Алмазный брусок

CZ Diamond brousek
 RO Piatra abraziva diamantata
 HU Kétoldalas gyémánt fenőkő
 ES Piedra de afilar diamantada

G300

150x50
mm

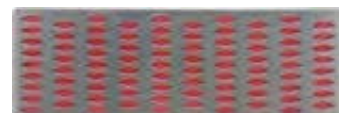

VOREL

No.	Grit / Ziamistość	W [mm]	L [mm]	
26132	G300	50	150	20/100

EN Wood rasp
 PL Tarnik do drewna
 DE Holzraspel
 RU Рашпиль по дереву
 CZ Rašple na dřevo
 RO Raspiță
 HU Fareszelő
 ES Lima para madera

200
mm



VOREL

No.	L [mm]	
25170	200	25/100

EN Wood rasp
 PL Tarnik do drewna
 DE Holzraspel
 RU Рашиль по дереву
 CZ Rašple na dřevo
 RO Rasplă
 HU Fareszelő
 ES Lima para madera



No.	L [mm]	
25171	200	25/100

EN Wood rasp
 PL Tarnik do drewna
 DE Holzraspel
 RU Рашиль по дереву
 CZ Rašple na dřevo
 RO Rasplă
 HU Fareszelő
 ES Lima para madera



No.	L [mm]	
25172	200	25/100

8

EN Wood rasp set
 PL Zestaw tarników do drewna
 DE Holzraspelsatz
 RU Набор рашилей для дерева

CZ Sada rašplí do dřeva
 RO Set raspile pt. lemn
 HU Fareszelő készlet
 ES Juego de limas para madera

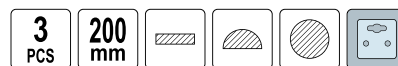

No.	L [mm]	pcs / szt.	
25173	200	3	10/20

EN Rasp for plaster
 PL Tarnik do gipsu
 DE Gipskartonplatten Rasp
 RU Рашиль для гипсокартона
 CZ Rašple pro omítky
 RO Rindea
 HU Reszelt vakolat
 ES Eliminador de yeso



No.	Working width / Szerokość robocza [mm]	L [mm]	
25300	40	60	10/60

EN Rasp for plaster
 PL Tarnik do gipsu
 DE Gipskartonplatten Rasp
 RU Рашиль для гипсокартона
 CZ Rašple pro omítky
 RO Rindea
 HU Reszelt vakolat
 ES Eliminador de yeso



No.	Working width / Szerokość robocza [mm]	L [mm]	
25307	40	140	15/60

EN Blade for rasp
 PL Tarka zapasowa do tarnika
 DE Sägeblatraspel
 RU Лезвие для рашиля по гипсокартону
 CZ Čepel do škrabacích
 RO Rezervă pt. rindea de rigips
 HU Penge reszelő
 ES Hoja para raspar



No.	Working width / Szerokość robocza [mm]	L [mm]	For / Dla	
25301	40	60	25300	10/120

EN Rasp for plaster
 PL Tarnik do gipsu
 DE Gipskartonplatten Rasp
 RU Рашиль для гипсокартона
 CZ Rašple pro omítky
 RO Rindea
 HU Reszelt vakolat
 ES Eliminador de yeso



No.	Working width / Szerokość robocza [mm]	L [mm]	
07930	50	140	6/36

EN Rasp for plaster
 PL Tarnik do gipsu
 DE Gipskartonplatten Rasp
 RU Рашпиль для гипсокартона
 CZ Rašple pro omítky
 RO Rindea
 HU Reszelt vakolat
 ES Eliminador de yeso



No.	Working width / Szerokość robocza [mm]	L [mm]	
25310	40	250	15/60

EN Sharpening stone
 PL Osełka owalna
 DE Abziehstein
 RU Брусок
 CZ Obtahovací brousek
 RO Piatră abrazivă pt. ascuțit
 HU Fenőkő
 ES Piedra de afilar



No.	L [mm]	
26210	225	50/100

EN Rotary sharpener
 PL Ostrzarka do wiertarki
 DE Bohrschärfer-Bohrmaschinenaufsatz
 RU Точило для ножей и ножниц

CZ Brousek na nože a nůžky
 RO Rezervă pt. dispozitiv de ascuțit
 HU Élezőkő fúrógéphe fogható
 ES Muela afilar cuchillos y tijeras



No.	
26225	80/240

EN Waterproof sand paper
 PL Papier ścierny wodoodporny
 DE Schleifpapier wasserfest
 RU Водостойкая наждачная бумага

CZ Smirkový papír-vodní
 RO Hârtie abrazivă impermeabilă
 HU Csiszolópapír vizes
 ES Papel de lija resistente al agua

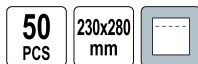

No.	Grit / Ziarnistość	Size / Rozmiar [mm]	pcs / szt.	
07060	P60	230x280	50	1000
07080	P80	230x280	50	1000
07100	P100	230x280	50	1000
07120	P120	230x280	50	1000
07180	P180	230x280	50	1000
07240	P240	230x280	50	1000
07320	P320	230x280	50	1000
07400	P400	230x280	50	1000
07506	P600	230x280	50	1000
07508	P800	230x280	50	1000
07510	P1000	230x280	50	1000
07512	P1200	230x280	50	1000

EN Sharpening stone
 PL Osełka
 DE Welzstein
 RU Брусок точильный
 CZ Brusný kámen
 RO Piatră abrazivă pt. ascuțit
 HU Fenőkő
 ES Piedra de afilar

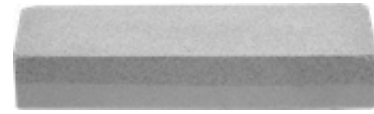

No.	L [mm]	
26150	150	25/50
26200	200	25/50

EN Knife sharpener
 PL Ostrzarka do noży
 DE Messerschärfer
 RU Точилка для ножей
 CZ Brousek na nože
 RO Dispozitiv de ascuțit cuțite
 HU Késélező
 ES Afilador de cuchillos



No.	
26220	12/96

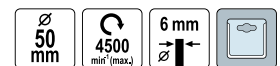

EN Abrasive cloth
 PL Płótno ściernie
 DE Schleifgewebe
 RU Бумага наждачная на тканевой основе
 CZ Brusné plátno
 RO Coală abrazivă
 HU Csiszolóvászon
 ES Paño abrasivo



No.	Grit / Ziarnistość	Size / Rozmiar [mm]	pcs / szt.	
07530	P36	230x280	50	500
07540	P46	230x280	50	500
07560	P60	230x280	50	500
07580	P80	230x280	50	500
07610	P100	230x280	50	500
07620	P120	230x280	50	500
07630	P150	230x280	50	500

EN Abrasive mesh
 PL Siatka ścierna
 DE Schleifgitter
 RU Шлифовальная сетка
 CZ Brusné pletivo
 RO Plasă abrazivă
 HU Csiszolóháló
 ES Red abrasiva nacional

105x280
mm



No.	Grit / Ziamistość	Size / Rozmiar [mm]	
07879	P40	105x280	50
07880	P60	105x280	50
07881	P80	105x280	50
07882	P100	105x280	50
07883	P120	105x280	50
07884	P150	105x280	50
07885	P180	105x280	50
07886	P220	105x280	50

EN Abrasive sponge
 PL Kostka ścierna
 DE Schleifschwamm
 RU Губка для шлифования
 CZ Hubka brusná
 RO Burete abraziv
 HU Dörzsszivacs
 ES Esponja abrasiva

68x100
x25
mm



No.	Grit / Ziamistość	Size / Rozmiar [mm]	
08288	P60	68x100x25	100
08289	P80	68x100x25	100
08290	P100	68x100x25	100
08291	P120	68x100x25	100
08292	P150	68x100x25	100
08293	P180	68x100x25	100

EN Abrasive disc with velcro
 PL Krążek ścierny z rzepem
 DE Fiberschleifscheiben ungelocht
 RU Круг шлифовальный на липучке
 CZ Brusný kotouč na suchý zip
 RO Disc abraziv cu (scai)
 HU Csiszolókorong (tapadókoronggal)
 ES Juego de discos abrasivos (velcro)

5
PCS

125
mm



No.	Grit / Ziamistość	Ø [mm]	pcs / szt.	
08553	P36	125	5	50/200
08554	P40	125	5	50/200
08556	P60	125	5	50/200
08558	P80	125	5	50/200
08560	P100	125	5	50/200
08562	P120	125	5	50/200
08565	P150	125	5	50/200

EN No end abrasive band
 PL Taśma ścierna bezkońcowa
 DE Schleifband
 RU Лента шлифовальная бесконечная
 CZ Pás brusný nekonečný
 RO Bandă abrazivă continuă
 HU Végtelenített csiszolószalag
 ES Banda abrasiva sin extremos

5
PCS

75x533
mm



No.	Grit / Ziamistość	Size / Rozmiar [mm]	pcs / szt.	
07664	P40	75x533	5	20/60
07665	P60	75x533	5	20/60
07666	P80	75x533	5	20/60
07667	P100	75x533	5	20/60
07668	P120	75x533	5	20/60

EN Abrasive sponge
 PL Kostka ścierna
 DE Schleifschwamm
 RU Губка для шлифования
 CZ Hubka brusná
 RO Burete abraziv
 HU Dörzsszivacs
 ES Esponja abrasiva

125x90
x65x25
mm



No.	Grit / Ziamistość	Size / Rozmiar [mm]	
08301	P60	125x90x65x25	100
08302	P80	125x90x65x25	100
08303	P100	125x90x65x25	100
08304	P120	125x90x65x25	100
08306	P150	125x90x65x25	100
08307	P180	125x90x65x25	100
08308	P220	125x90x65x25	100

EN Abrasive disc with holes
 PL Krążek ścierny z otworami
 DE Schleifscheibe mit Löchern
 RU Круг шлифовальный перфорированный
 CZ Brusný kotouč s otvory
 RO Disc abraziv cu orificii
 HU Csiszolókorong nyílásokkal
 ES Disco abrasivo con orificios

5
PCS

125
mm



No.	Grit / Ziamistość	Ø [mm]	pcs / szt.	
08573	P36	125	5	50/200
08574	P40	125	5	50/200
08576	P60	125	5	50/200
08578	P80	125	5	50/200
08580	P100	125	5	50/200
08582	P120	125	5	50/200
08585	P150	125	5	50/200

EN Sanding block
 PL Blok ścierny
 DE Handschleifer
 RU Брусок для шлифования
 CZ Držák na brusný papír
 RO Suport pt. șmirghel
 HU Kézi csiszoló
 ES Bloque abrasivo

85x160 mm



No.	Size / Rozmiar [mm]	
07950	160x85	20/100

EN Hand grinding block
 PL Blok ścierny z rzepem
 DE Schleifblock mit Klett
 RU Абразивный блок с липучкой
 CZ Brusná kostka se suchým zipem
 RO Suport de slefuire manual
 HU Csiszolóblokk, tépőzáras
 ES Bloque abrasivo con velcro

∅ 125 mm EVA HOOK FASTENER RZEP



No.	∅ [mm]	
07955	125	10/60

EN Hand grinding block
 PL Blok ścierny z rzepem
 DE Schleifblock mit Klett
 RU Абразивный блок с липучкой
 CZ Brusná kostka se suchým zipem
 RO Suport de slefuire manual
 HU Csiszolóblokk, tépőzáras
 ES Bloque abrasivo con velcro

∅ 150 mm EVA HOOK FASTENER RZEP



No.	∅ [mm]	
07957	150	10/120

EN Sanding block
 PL Blok ścierny
 DE Handschleifer
 RU Брусок для шлифования
 CZ Držák na brusný papír
 RO Suport pt. șmirghel
 HU Kézi csiszoló
 ES Bloque abrasivo

210x100 mm



No.	Size / Rozmiar [mm]	
07962	210x100	30

EN Sanding block
 PL Blok ścierny
 DE Handschleifer
 RU Брусок для шлифования
 CZ Držák na brusný papír
 RO Suport pt. șmirghel
 HU Kézi csiszoló
 ES Bloque abrasivo

100x210 mm



No.	Size / Rozmiar [mm]	
07970	210x100	20/80

EN Hand grinding block
 PL Blok ścierny z rzepem
 DE Schleifblock mit Klett
 RU Абразивный блок с липучкой
 CZ Brusná kostka se suchým zipem
 RO Suport de slefuire manual
 HU Csiszolóblokk, tépőzáras
 ES Bloque abrasivo con velcro

∅ 150 mm EVA HOOK FASTENER RZEP



No.	∅ [mm]	
07956	150	10/60

EN Sanding block
 PL Blok ścierny
 DE Handschleifer
 RU Брусок для шлифования
 CZ Držák na brusný papír
 RO Suport pt. șmirghel
 HU Kézi csiszoló
 ES Bloque abrasivo

220x100 mm



No.	Size / Rozmiar [mm]	
07960	220x100	30

EN Polishing set
 PL Zestaw polerski
 DE Polierset
 RU Полировальный набор

CZ Čistící a leštící souprava
 RO Set pt. lustruit
 HU Tisztító és polírozó készlet
 ES Conjunto de limpieza e polimento

6 mm 150g (2x)

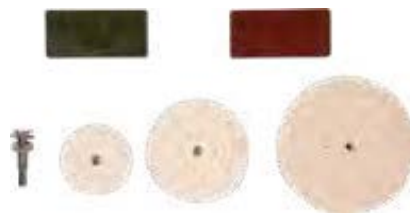
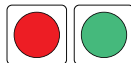

No.		
25420		30/60



9

Plumbing tools Narzędzia hydrauliczne



Ratchet die stocks Komplety gwintownic ręcznych	
.....	120

Hinged pipe vices Imadła zaciskowe do rur	
.....	120

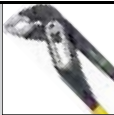
Water pump pliers Szczypce nastawne	
.....	120

Pipe wrenches Klucze do rur	
.....	120-121

Pipe wrenches Stillson type Klucze do rur typu Stillson.....	120
--	-----

Adjustable pipe wrenches Klucze do rur nastawne.....	121
--	-----

Adjustable wrenches Klucze nastawne francuskie.....	121
---	-----

Chain pipe wrenches Klucze do rur łańcuchowe	
.....	121

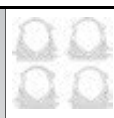
Plumbing assembly accessories Montażowe akcesoria hydrauliczne	
.....	122-123

Pipe cutters Obcinaki do rur	
.....	123-125

Calibrators Kalibratory	
.....	125

Pipe welders Zgrzewarki do rur	
.....	125

Hydraulic accessories Akcesoria hydrauliczne	
.....	125-127

- EN Ratchet die stock
 PL Zestaw gwintownic
 DE Schneidkluppensatz
 RU Набор резьбонарезной сантехнический
- CZ Sada závitníků
 RO Set de filiere
 HU Menetfűrő készlet
 ES Tarrajas para tubo



- 7 PCS
- 3/8" 9.5 mm
- 1/2" 12.7 mm
- 3/4" 19 mm
- 1" 25 mm
- 5/4" 32 mm



No.	Size / Rozmiar	pcs / szt.	
55820	3/8" (10.0 mm), 1/2" (12.5 mm), 3/4" (19.0 mm), 1" (25.0 mm), 1-1/4" (32.0 mm)	7	4

- EN Hinged pipe vice
 PL Imadło zaciskowe do rur
 DE Rohrschraubstock
 RU Тиски для труб
 CZ Upínací svěrák na trubky
 RO Menhină pt. țevi
 HU Satu, csőszorító
 ES Tornillo de aprite para tubos



No.	Mounting element diameter / Šrednica mocovanega elementu [mm]	
36570	13-50	6

- EN Pipe wrench
 PL Klucz do rur
 DE Rohrschlüssel
 RU Ключ трубный
 CZ Klíč součásti na trubky
 RO Cheie reglabila pt. tevi
 HU Csőkulcs
 ES Llave para tubos



No.	L [mm]	
55250	250	6/48
55300	300	6/36
55350	350	6/24

- EN Ratchet die stock
 PL Zestaw gwintownic
 DE Schneidkluppensatz
 RU Набор резьбонарезной сантехнический
 CZ Sada závitníků
 RO Set de filiere
 HU Menetfűrő készlet
 ES Tarrajas para tubo

- 6 PCS
- 1.5" 38 mm
- 2" 50 mm



No.	Size / Rozmiar	pcs / szt.	
55830	1-1/2" (38.0 mm), 2" (50.0 mm)	6	2

- EN Water pump pliers
 PL Szczypce nastawne
 DE Wasserpumpenzange
 RU Клещи переставные
 CZ Nastavitelné kleště
 RO Cleste papagal
 HU Állítható fogó
 ES Tenaza ajustable

- 250 mm
- 7 POSITIONS POZICIE



No.	L [mm]	
41510	250	10/50

- EN Pipe wrench
 PL Klucz do rur
 DE Rohrschlüssel
 RU Ключ трубный
- CZ Klíč součásti na trubky
 RO Cheie reglabila pt. tevi
 HU Csőkulcs
 ES Llave para tubos



No.	L [mm]	
55620	195	6/36
55625	245	6/30
55630	275	6/24
55635	310	6/18
55645	395	4/12
55660	490	2/6
55690	750	2/4

EN Adjustable pipe wrench
 PL Klucz nastawny do rur
 DE Rohrschlüssel
 RU Ключ трубный переставной

CZ Nastavitelný klíč na trubky
 RO Cheie reglabilă pt. țevi
 HU Állítható csőkulcs
 ES Llave para tubos



No.	Max. pipe diameter / Maks. średnica rury	L [mm]	
55100	1" (25 mm)	330	12/36
55150	1-1/2" (38 mm)	390	10/20
55200	2" (50 mm)	540	6/12

EN Adjustable pipe wrench
 PL Klucz nastawny do rur
 DE Rohrschlüssel
 RU Ключ трубный переставной

CZ Nastavitelný klíč na trubky
 RO Cheie reglabilă pt. țevi
 HU Állítható csőkulcs
 ES Llave para tubos



VOREL

No.	Max. pipe diameter / Maks. średnica rury	L [mm]	
55215	1" (25 mm)	310	24
55216	1-1/2" (38 mm)	420	16
55217	2" (50 mm)	560	8

EN Adjustable wrench
 PL Klucz nastawny francuski
 DE Stahlschraubenschlüssel (Franzose)
 RU Ключ разводной

CZ Nastavitelný klíč francouz
 RO Cheie reglabilă franceză
 HU Állítható franciakulcs
 ES Llave ajustable inglesa



VOREL

No.	Jaws opening capacity / Zakres rozwarcia szczęk [mm]	Jaws width / Szerokość szczęk [mm]	
54497	0-25	60	10
54498	0-35	70	10
54499	0-45	80	10
54500	0-55	90	5
54510	0-65	100	5

EN Adjustable pipe wrench
 PL Klucz nastawny do rur
 DE Rohrschlüssel
 RU Ключ трубный переставной
 CZ Nastavitelný klíč na trubky
 RO Cheie reglabilă pt. țevi
 HU Állítható csőkulcs
 ES Llave para tubos



VOREL

No.	Max. pipe diameter / Maks. średnica rury	L [mm]	
55210	1" (25 mm)	320	24
55211	1-1/2" (38 mm)	425	16
55212	2" (50 mm)	560	8

EN Adjustable pipe wrench
 PL Klucz nastawny do rur
 DE Rohrschlüssel
 RU Ключ трубный переставной

CZ Nastavitelný klíč na trubky
 RO Cheie reglabilă pt. țevi
 HU Állítható csőkulcs
 ES Llave para tubos



VOREL

No.	Max. pipe diameter / Maks. średnica rury	L [mm]	
55220	1" (25 mm)	315	24
55221	1-1/2" (38 mm)	425	16
55222	2" (50 mm)	560	8

EN Chain pipe wrench
 PL Klucz łańcuchowy do rur
 DE Kettenrohrzange
 RU Ключ цепной для труб
 CZ Klíč řetězový na trubky
 RO Cheie reglabilă pt. tevi cu lanț
 HU Láncos csőfogó
 ES Llave de cadena

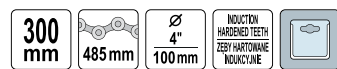

VOREL

No.	Max. pipe diameter / Maks. średnica rury	L [mm]	
55792	4" (100.0 mm)	300	5/20

- EN Pipe clips
 PL Uchwyty do rur
 DE Rohrclips
 RU Держатели для труб (клипсы)
 CZ Přichytky trubkové
 RO Cleme pt. tevi
 HU Csőbilincsek
 ES Clips para tubos



No.	Pipe diameter / Średnica rury [mm]	pcs / szt.	
54811	15-16	4	50
54812	18	4	50
54813	20	4	50
54814	22	4	50
54815	25	4	50
54816	28	4	50
54817	32	4	50

- EN Pipe clips Ring
 PL Uchwyty Ring do rur
 DE Rohrclips Ring
 RU Крепежные клипсы для труб
 CZ Přichytky trubkové Ring
 RO Cleme pt. tevi tip inel
 HU Ring típusú csőbilincsek
 ES Clips para tubos Ring

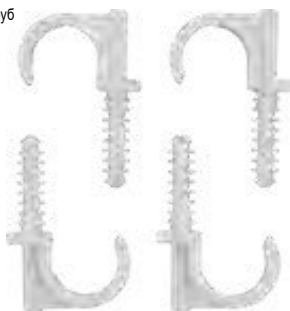

No.	Pipe diameter / Średnica rury [mm]	pcs / szt.	
54850	15-16	4	50
54851	18	4	50
54852	20	4	50
54853	22	4	50
54854	25	4	50
54855	28	4	50
54856	32	4	50

- EN Double pipe clips
 PL Haki do rur bis
 DE Doppelrohrhaken
 RU Держатели для труб и каналов двойные
 CZ Natloukací přichytky pro trubky dvojité
 RO Cleme duble pt. tevi
 HU Kettős kábelrögzítő bilincsek
 ES Abrazaderas para tubos dobles

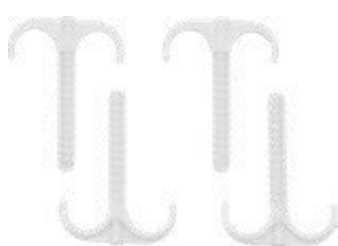

No.	Pipe diameter / Średnica rury [mm]	pcs / szt.	
54871	15-28	4	50

- EN Self locking pipe clips
 PL Uchwyty zamykane do rur
 DE Rohrschellen
 RU Держатели для труб (клипсы) с крышкой
 CZ Trubkove přichytky s klipem
 RO Cleme pt. tevi autoblocante
 HU Zárlható műanyag csőbilincsek
 ES Clips cerrados para tubos



No.	Pipe diameter / Średnica rury [mm]	pcs / szt.	
54830	15-16	4	50
54831	18	4	50
54832	20	4	50
54833	22	4	50
54834	25	4	50
54835	28	4	50
54836	32	4	50
54837	40	4	50

- EN Pipe clips
 PL Haki do rur
 DE Rohrclips
 RU Держатели для труб и каналов одиночные
 CZ Natloukací přichytky pro trubky
 RO Cleme pt. tevi
 HU Kábelrögzítő bilincsek
 ES Abrazaderas para tubos

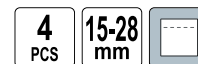

No.	Pipe diameter / Średnica rury [mm]	pcs / szt.	
54870	15-28	4	50

- EN Pipe clips with anchor
 PL Haki do rur z kolkkiem
 DE Dübelhaken
 RU Держатели для труб с дюбелем
 CZ Přichytky pro trubky s hmoždinkou
 RO Cleme pt. tevi cu ancora
 HU kábelrögzítő bilincsek tiplivel
 ES Abrazaderas para tubos con taco

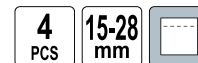

No.	Pipe diameter / Średnica rury [mm]	pcs / szt.	
54875	15-28	4	50

- EN Double pipe clips with anchor
- PL Haki do rur bis z kolkiem
- DE Doppeldübelhaken
- RU Держатели для труб двойные с дюбелем
- CZ Dvojitý přichytka pro trubky s hmoždinkou
- RO Cleme duble pt. tevi cu diblu
- HU Kettős kábelrögzítő bilincsek típlével
- ES Abrazaderas para tubos dobles con taco



No.	Pipe diameter / Średnica rury [mm]	pcs / szt.	
54876	15-28	4	50

- EN Sealing plug
- PL Korek hydrauliczny
- DE Stopfen für Dichtheitsprüfung
- RU Заглушка для проверки герметичности
- CZ Montážní zátká
- RO Dop de etanșare
- HU Záródugó
- ES Tapón para pruebas hidráulicas



No.	Thread size / Rozmiar gwintu	
54901	G1/2	20

- EN Sealing plug
- PL Korek hydrauliczny
- DE Stopfen für Dichtheitsprüfung
- RU Заглушка для проверки герметичности
- CZ Montážní zátká
- RO Dop de etanșare
- HU Záródugó
- ES Tapón para pruebas hidráulicas



No.	Thread size / Rozmiar gwintu	pcs / szt.	
54903	G1/2	10	20

- EN Sealing plug
- PL Korek hydrauliczny
- DE Stopfen für Dichtheitsprüfung
- RU Заглушка для проверки герметичности
- CZ Montážní zátká
- RO Dop de etanșare
- HU Záródugó
- ES Tapón para pruebas hidráulicas



No.	Thread size / Rozmiar gwintu	
54900	G1/2	20

- EN Sealing plug
- PL Korek hydrauliczny
- DE Stopfen für Dichtheitsprüfung
- RU Заглушка для проверки герметичности
- CZ Montážní zátká
- RO Dop de etanșare
- HU Záródugó
- ES Tapón para pruebas hidráulicas

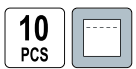

No.	Thread size / Rozmiar gwintu	pcs / szt.	
54902	G1/2	10	20

- EN Pipe cutter
- PL Obcinak do rur
- DE Rohrabschneider
- RU Труборез для труб
- CZ Rezač trubek
- RO Dispozitiv pt. tăiat tevi
- HU Csővágó
- ES Cortatubos

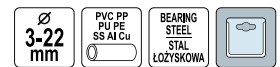

No.	Cutting diameter / Średnica cięcia [mm]	
78370	3-22	25/100

EN Pipe cutter
 PL Obcinak do rur
 DE Rohrabscneider
 RU Труборез для труб
 CZ Rezač trubek
 RO Dispozitiv pt. tăiat țevi
 HU Csővágó
 ES Cortatubos



No.	Cutting diameter / Średnica cięcia [mm]	
78375	3-30	25/100

EN PVC pipe cutter
 PL Obcinak do rur PVC
 DE PVC Rohrabscneider
 RU Труборез для ПВХ труб
 CZ Rezač PVC trubek
 RO Foarfecă pt. tăiat țevi din PVC
 HU Csővágó olló PVC csővekhez
 ES Tijera cortatubos para PVC

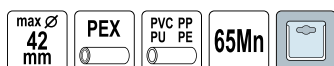

No.	Max. cutting diameter / Maks. średnica cięcia [mm]	
78342	42	10/60

EN PVC pipe cutter
 PL Obcinak do rur PVC
 DE PVC Rohrabscneider
 RU Труборез для ПВХ труб
 CZ Rezač PVC trubek
 RO Foarfecă pt. tăiat țevi din PVC
 HU Csővágó olló PVC csővekhez
 ES Tijera cortatubos para PVC



No.	Max. cutting diameter / Maks. średnica cięcia [mm]	
78341	42	12/48

EN Deburrer
 PL Gratownik
 DE Entgrater
 RU Гратосниматель
 CZ Odhrotovač
 RO Debavurator
 HU Sorjázó
 ES Desbarbador



No.		
78388		50/150

EN PVC pipe cutter
 PL Obcinak do rur PVC
 DE PVC Rohrabscneider
 RU Труборез для ПВХ труб
 CZ Rezač PVC trubek
 RO Foarfecă pt. tăiat țevi din PVC
 HU Csővágó olló PVC csővekhez
 ES Tijera cortatubos para PVC

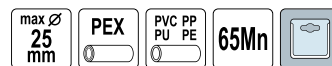

No.	Max. cutting diameter / Maks. średnica cięcia [mm]	
78340	25	25/100

EN PVC pipe cutter
 PL Obcinak do rur PVC
 DE PVC Rohrabscneider
 RU Труборез для ПВХ труб
 CZ Rezač PVC trubek
 RO Foarfecă pt. tăiat țevi din PVC
 HU Csővágó olló PVC csővekhez
 ES Tijera cortatubos para PVC

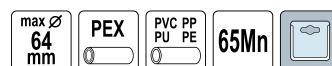

No.	Max. cutting diameter / Maks. średnica cięcia [mm]	
78345	64	6/48

EN Pipe cutter
 PL Obcinak do rur
 DE Rohrabscneider
 RU Труборез для труб
 CZ Rezač trubek
 RO Dispozitiv pt. tăiat țevi
 HU Csővágó
 ES Cortatubos



No.	Cutting diameter / Średnica cięcia	
78381	1/10" - 1-1/4" (3-32 mm)	60

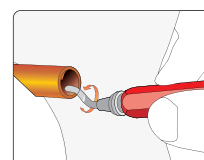
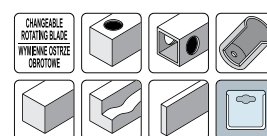

EN Pipe deburrer
 PL Gratownik do rur
 DE Rohrentgrater
 RU Гратосниматель для труб
 CZ Odhrotovač trubek
 RO Debavurator pt. tevi
 HU Sorjázó
 ES Desbarbador de tubos

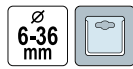

No.	Cutting diameter / Średnica cięcia [mm]	
78385	6-36	25/50

EN PVC plastic pipe welder
 PL Zgrzewarka do rur termoplastycznych
 DE Schweißgerät für thermoplastische Rohre
 RU Аппарат для сварки пластиковых труб
 CZ Svářečka na termoplastické trubky
 RO Mașină de sudat țevi termoplastice
 HU Hegesztő berendezés termoplasztikus csövekhez
 ES Máquina de soldar las tubos termoplásticos



Ø 16, 20, 25, 32, 40, 50 mm



No.	Power / Moc [W]	
78911	800	5

EN PVC plastic pipe welder
 PL Zgrzewarka do rur termoplastycznych
 DE Schweißgerät für thermoplastische Rohre
 RU Аппарат для сварки пластиковых труб
 CZ Svářečka na termoplastické trubky
 RO Mașină de sudat țevi termoplastice
 HU Hegesztő berendezés termoplasztikus csövekhez
 ES Máquina de soldar las tubos termoplásticos



Ø 16, 20, 25, 32, 40, 50, 63 mm



No.	Power / Moc [W]	
78910	800, 1500	5

EN Pipe calibration tool
 PL Kalibrator do rur
 DE Kalibrierer für Mehrschichtverbundrohr
 RU Калибратор пластиковый

CZ Kalibrátor pro trubku
 RO Calibrator teava multistrat
 HU Csőkalibráló
 ES Calibrador para tubos multicapa

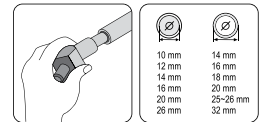

No.	
55740	300

EN PVC plastic pipe welder
 PL Zgrzewarka do rur termoplastycznych
 DE Schweißgerät für thermoplastische Rohre
 RU Аппарат для сварки пластиковых труб
 CZ Svářečka na termoplastické trubky
 RO Mașină de sudat țevi termoplastice
 HU Hegesztő berendezés termoplasztikus csövekhez
 ES Máquina de soldar las tubos termoplásticos



Ø 20, 25, 32, 40, 50, 63 mm



No.	Power / Moc [W]	
78912	750, 1500	4

EN PTFE tape
 PL Taśma PTFE
 DE Teflonband
 RU Фумлента
 CZ Teflonová páska
 RO Bandă de teflon
 HU Teflon szalag
 ES Cinta de teflón



No.	W [mm]	Thickness / Grubość [mm]	L [m]	
75201	12	0.1	12	250/1000
75202	19	0.2	15	200

- EN Thread sealing paste
 PL Pasta uszczelniająca do gwintów
 DE Paste zum Abdichten der Gewinde
 RU Паста для герметизации резьбы
 CZ Těsnící pasta na závity
 RO Pastă pt. etanșare filete
 HU Menettömítő paszta
 ES Pasta selladora para roscas



No.	m [g]	
86750	65	48
86751	250	24

- EN Oakum
 PL Pakuły lniane
 DE Leinenwerg
 RU Лен сантехнический
 CZ Lněná koudel
 RO Câlți de in
 HU Len kóc
 ES Estopa de lino



No.	m [g]	
86760	100	50

- EN Drain cleaner
 PL Pistolet do udrażniania rur
 DE Pistole zum Reinigen von Rohren
 RU Пневматический пистолет для прочистки труб
 CZ Pistole na čištění trubek
 RO Pistol pt. curățarea țevilor
 HU Csőtisztító pisztoly
 ES Pistola desatapaños

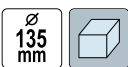

No.	Ø [mm]	
55500	63, 135	10

- EN Drain auger
 PL Spirala kanalizacyjna
 DE Rohrreinigungsspirale
 RU Трос сантехнический
 CZ Spirála na čištění trubek
 RO Sarpe pt. desfundat țevi
 HU Csőtisztító spirál
 ES Varilla para limpiar desagües



No.	Ø [mm]	L [m]	
55541	5	1.5	20/80
55542	6	3.0	18/36

- EN Hydraulic repair kit
 PL Hydrauliczny zestaw naprawczy
 DE Hydraulischer Reparatursatz
 RU Комплект для уплотнения резьбы
 CZ Hydraulická opravářská souprava
 RO Căneapă pt. etanșare
 HU Vízvezeték javító készlet
 ES Juego para reparaciones hidráulicas



No.	m [g]	
86761	100, 65	40

- EN Lubricant for PVC pipes
 PL Pasta poślizgowa do rur PCV
 DE Gleitpaste für PVC-Rohre
 RU Силиконовая смазка для ПВХ труб
 CZ Kluzná pasta na PVC trubky
 RO Pastă glisantă pt. țevi PVC
 HU Sikosító paszta PVC csövekhez
 ES Pasta de deslizamiento para tubos de PCV



No.	m [g]	
86770	250	18
86771	500	15

- EN Drain suction pump
 PL Pompa do udrażniania kanalizacji
 DE Rohrreinigungspumpe
 RU Пневматический вантуз для прочистки труб
 CZ Čerpadlo na čištění trubek
 RO Pompă pt. desfundarea țevilor
 HU Lefolyótisztító pumpa
 ES Desatascador bomba de vacío

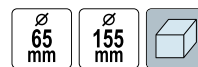

No.	Ø [mm]	
55505	65, 155	24

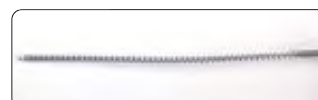

EN Drain auger
 PL Spirala kanalizacyjna
 DE Rohrreinigungsspirale
 RU Трос сантехнический

CZ Spirála na čištění trubek
 RO Sarpe pt. desfundat țevi
 HU Csőtisztító spirál
 ES Varilla para limpiar desagües



No.	Ø [mm]	L [m]	
55544	9	5	5/10
55545	9	10	4/8

EN Hand pressure test pump
 PL Pompa ręczna do prób ciśnieniowych
 DE Handpumpe für Druckproben
 RU Ручной насос для опрессовки
 CZ Ruční čerpadlo pro tlakové testování
 RO Pompa manuala testat presiunea
 HU Kézi nyomáspróba szivattyú
 ES Bomba manual para pruebas de presión

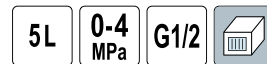

No.	Tank capacity / Pojemność zbiornika [l]	
55400	5	8

Memo

10

Fastening tools Narzędzia do łączenia

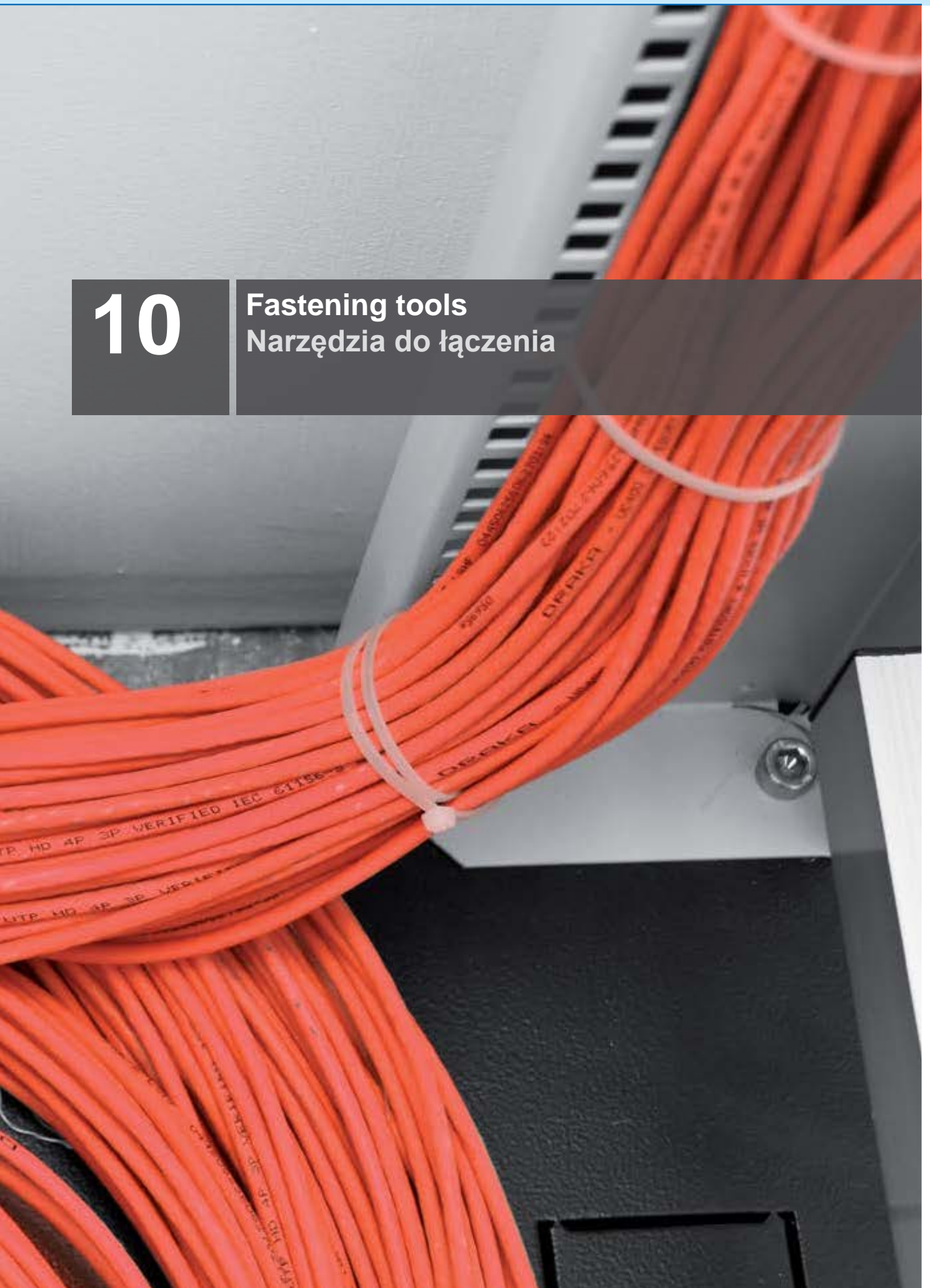

Hand riveters Nitownice ręczne

130-131



Hand riveters
Nitownice ręczne..... 130

Hand riveting tool
Nitownice ręczne, dźwigniowe..... 131

Rivets Nity

131



Aluminium blind rivets
Nity aluminiowe..... 131

Profile connection pliers Szczypce do łączenia profili

132



Staple guns, staples & nails Zszywacze, zszywki i gwoździe

132-134



Staple guns
Zszywacze..... 132

Staple removers
Rozszywacze..... 133

Staples
Zszywki..... 133

Brad nails
Szyfty..... 133

Nails
Gwoździe..... 134

Pliers for hollow expansion bolts Zaciskarki do kołków typu molly

134

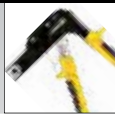

Screw, plug & hook sets Zestawy wkrętów, kołków i haków

135



Caulking guns Wyciskacze do mas

135-136



Foam guns Pistolety do pianki montażowej

136-138



Hose clips Opaski ślimakowe

138



Screw clamps Obejmy śrubowe

138-139



Cable ties Opaski plastikowe

139



Hook & loop cable ties Opaski z rzepem

139



Glue sticks & glue applicators Wkłady klejowe i dozowniki do kleju

140



Packing tape dispensers Podajniki taśmy pakowej

140



Tapes Taśmy

140-142



Ropes & lines Sznury i linki

142-143



EN Hand riveter
 PL Nitownica ręczna
 DE Hand-Nietzange
 RU Ручной заклепочник
 CZ Ruční nýtovačka
 RO Presă de nituit manuală
 HU Kézi szegecshúzó
 ES Remachadora manual



No.	L [mm]	Ø [mm]	
70000	250	2,4, 3,2, 4, 4,8	12/24

EN Hand riveter
 PL Nitownica ręczna
 DE Hand-Nietzange
 RU Ручной заклепочник
 CZ Ruční nýtovačka
 RO Presă de nituit manuală
 HU Kézi szegecshúzó
 ES Remachadora manual



No.	L [mm]	Ø [mm]	
70023	250	2,4, 3,2, 4, 4,8	12/24

EN Hand riveter
 PL Nitownica ręczna
 DE Hand-Nietzange
 RU Ручной заклепочник
 CZ Ruční nýtovačka
 RO Presă de nituit manuală
 HU Kézi szegecshúzó
 ES Remachadora manual

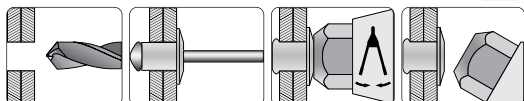
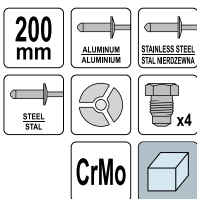

No.	L [mm]	Ø [mm]	
70035	200	2,4, 3,2, 4, 4,8	30

EN Hand riveter
 PL Nitownica ręczna
 DE Hand-Nietzange
 RU Ручной заклепочник
 CZ Ruční nýtovačka
 RO Presă de nituit manuală
 HU Kézi szegecshúzó
 ES Remachadora manual



No.	L [mm]	Ø [mm]	
70020	240	2,4, 3,2, 4, 4,8	12/24

EN Hand riveter
 PL Nitownica ręczna
 DE Hand-Nietzange
 RU Ручной заклепочник
 CZ Ruční nýtovačka
 RO Presă de nituit manuală
 HU Kézi szegecshúzó
 ES Remachadora manual



No.	L [mm]	Ø [mm]	
70030	230	2,4, 3,2, 4, 4,8	15/30

EN Hand riveter
 PL Nitownica ręczna
 DE Hand-Nietzange
 RU Ручной заклепочник
 CZ Ruční nýtovačka
 RO Presă de nituit manuală
 HU Kézi szegecshúzó
 ES Remachadora manual

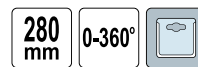

No.	L [mm]	Ø [mm]	
70100	280	2,4, 3,2, 4, 4,8	6/24

EN Hand riveter
 PL Nitownica ręczna
 DE Hand-Nietzange
 RU Ручной заклепочник
 CZ Ruční nýtovačka
 RO Presă de nituit manuală
 HU Kézi szegecszűző
 ES Remachadora manual

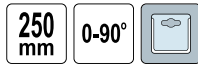

VOREL

No.	L [mm]	Ø [mm]	
70160	250	2,4, 3,2, 4, 4,8	12/24

EN Hand riveting tool
 PL Nitownica dźwigniowa
 DE Hebelnietzange
 RU Заклепочник рычажный
 CZ Nýtovačka páková
 RO Presă de nituit manuală
 HU Kézi szegecszűző
 ES Remachadora de palanca

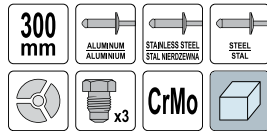

VOREL

No.	L [mm]	Ø [mm]	
70201	300	3,2, 4, 4,8	20

EN Hand riveting tool
 PL Nity aluminiumowa
 DE Hebelnietzange
 RU Заклепочник рычажный
 CZ Nýtovačka páková
 RO Presă de nituit manuală
 HU Kézi szegecszűző
 ES Remachadora de palanca



VOREL

No.	L [mm]	Ø [mm]	
70210	400	3,4, 4, 4,8	10/20

EN Hand rivet nut tool
 PL Nitownica ręczna do nitonakrętek
 DE Nietmutterzange
 RU Ручной заклепочник для резьбовых заклепок
 CZ Ruční nýtovačka na matice
 RO Clește pt. piulițe nituibile
 HU Emeltyűs popszegecszűző
 ES Remachadora de tuercas

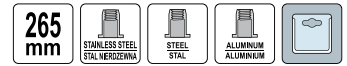

VOREL

No.	L [mm]	Nuts diameter / Średnica nitonakrętek	
70270	265	M3, M4, M5, M6	5/20

EN Hand riveting tool
 PL Nitownica dźwigniowa
 DE Hebelnietzange
 RU Заклепочник рычажный

CZ Nýtovačka páková
 RO Presă de nituit manuală
 HU Kézi szegecszűző
 ES Remachadora de palanca

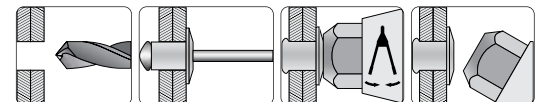
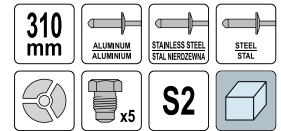

VOREL

No.	L [mm]	Ø [mm]	
70202	310	2,4, 3,2, 4, 4,8, 6,4	16

EN Aluminium blind rivets
 PL Nity aluminiumowe
 DE Aluminiumblindnieten
 RU Заклепки вытяжные алюминиевые

CZ Hliníkové nýty
 RO Nituri din aluminiu
 HU Alumínium popszegecs
 ES Remaches de aluminio



VOREL

No.	L [mm]	Ø [mm]	pcs / szt.	
70320	6.4	3.2	50	150/300
70330	9.6	3.2	50	150/300
70340	12.7	3.2	50	150/300
70400	6.4	4.0	50	100/200
70410	9.6	4.0	50	100/200
70420	12.7	4.0	50	100/200
70430	19.0	4.0	50	100/200
70480	6.4	4.8	50	100/200
70490	9.6	4.8	50	100/200
70500	12.7	4.8	50	100/200
70510	19.0	4.8	50	75/150

EN Stud crimper
 PL Szczypce do łączenia profili
 DE Profil-Verbundzange
 RU Щипцы для соединения профилей
 CZ Kleště na spojování profilů
 RO Clește pt. îmbinare profile
 HU Profilösszekítő fogó
 ES Pinzas para unir perfiles



No.	L [mm]	
04300	280	6/24

EN Staple gun
 PL Zszywacz tapicerski
 DE Tacker
 RU Стенлеп
 CZ Čalounická sešivačka
 RO Capsator tapiterie
 HU Kárpitos tűzőgép
 ES Grapadora de tapicero



No.	Staple length / Długość zszywki [mm]	
71000	4-8	10/60

EN Staple gun
 PL Zszywacz tapicerski
 DE Tacker
 RU Стенлеп
 CZ Čalounická sešivačka
 RO Capsator tapiterie
 HU Kárpitos tűzőgép
 ES Grapadora de tapicero

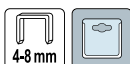

No.	Staple length / Długość zszywki [mm]	
71040	4-8	10/40

EN Staple gun
 PL Zszywacz tapicerski
 DE Tacker
 RU Стенлеп
 CZ Čalounická sešivačka
 RO Capsator tapiterie
 HU Kárpitos tűzőgép
 ES Grapadora de tapicero



No.		
71060		6/24

EN Stud crimper
 PL Szczypce do łączenia profili
 DE Profil-Verbundzange
 RU Щипцы для соединения профилей
 CZ Kleště na spojování profilů
 RO Clește pt. îmbinare profile
 HU Profilösszekítő fogó
 ES Pinzas para unir perfiles

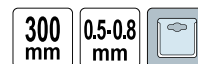

No.	L [mm]	
04301	300	6/24

EN Staple gun
 PL Zszywacz tapicerski
 DE Tacker
 RU Стенлеп
 CZ Čalounická sešivačka
 RO Capsator tapiterie
 HU Kárpitos tűzőgép
 ES Grapadora de tapicero



No.	Staple length / Długość zszywki [mm]	
71050	4-14	10/40

EN Staple gun
 PL Zszywacz tapicerski
 DE Tacker
 RU Стенлеп
 CZ Čalounická sešivačka
 RO Capsator tapiterie
 HU Kárpitos tűzőgép
 ES Grapadora de tapicero

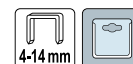

No.	Staple length / Długość zszywki [mm]	
71052	4-14	10/20

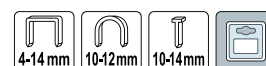

- EN Hammer tacker
- PL Zszywacz młotkowy
- DE Hammer Tacker
- RU Молотковый степлер
- CZ Sponkovač kladivový
- RO Capsator ciocan
- HU Kalapács tűzőgép
- ES Grapadora de martillo

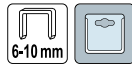

No.	Staple length / Długość zszywki [mm]	
71080	6-10	6/24

- EN Mesh pliers
- PL Szczypce do mocowania siatki ogrodzeniowej
- DE Zaunklammerzange
- RU Степлер-сшиватель для металлической сетки и сетки-рабицы
- CZ Kleště pro srovnání a montáž pletiv
- RO Clește pt. capse de plasă
- HU Fogókerítéskapocshoz
- ES Hog anillo alicates

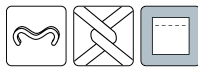

No.		
49840		50

- EN Staples
- PL Zszywki
- DE Heftklammern
- RU Скобы
- CZ Sponky
- RO Capse tapiterie
- HU Tűzőkapocs
- ES Grapas

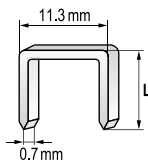

No.	Staple length / Długość zszywki [mm]	Staple thickness / Grubość zszywki [mm]	Staple width / Szerokość zszywki [mm]	pcs / szt.	
72040	4	0.7	11.3	1000	60/480
72060	6	0.7	11.3	1000	60/360
72080	8	0.7	11.3	1000	60/300
72100	10	0.7	11.3	1000	60/240
72120	12	0.7	11.3	1000	50/200
72140	14	0.7	11.3	1000	40/160

- EN Staple remover
- PL Rozszywacz
- DE Entkammerer
- RU Расшиватель
- CZ Rozešíváč
- RO Extractor capse
- HU Kapocskiszédo
- ES Quitagrapas

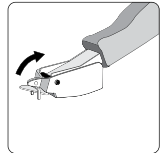

No.		
71160		10/40

- EN Staples type „E” for mesh pliers
- PL Zszywki typu „E” do mocowania siatki
- DE Zaunringe
- RU Скобы для обжима сетки
- CZ Svrky pro montáž pletiva
- RO Capse pt. plasă
- HU Kapcsok madárháló rögzítéséhez
- ES Grapas omega



No.	For / Dla	
49841	49840	10/60

- EN Staples
- PL Zszywki
- DE Heftklammern
- RU Скобы
- CZ Sponky
- RO Capse tapiterie
- HU Tűzőkapocs
- ES Grapas

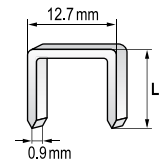
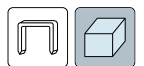

No.	Staple length / Długość zszywki [mm]	Staple thickness / Grubość zszywki [mm]	Staple width / Szerokość zszywki [mm]	pcs / szt.	
71970	6	0.9	12.7	12000	10
71971	10	0.9	12.7	7500	10
71972	16	0.9	12.7	4500	10

- EN Brad nails
- PL Szytyfy
- DE Stauchkopfnägel
- RU Шпилька для степлера
- CZ Kolařské hřebíky
- RO Cuie tapiterie
- HU Műanyag spakli
- ES Palos

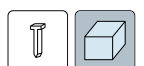

No.	Staple length / Długość zszywki [mm]	Staple thickness / Grubość zszywki [mm]	Staple width / Szerokość zszywki [mm]	pcs / szt.	
71980	16	1.3	1.8	5000	27
71981	30	1.3	1.8	5000	18
71982	35	1.3	1.8	5000	15
71983	50	1.3	1.8	5000	15

EN Staples
 PL Zszywki
 DE Heftklammern
 RU Скобы
 CZ Sponky
 RO Capse tapiterie
 HU Tűzőkapocs
 ES Grapas

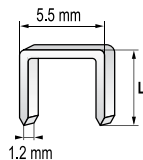

No.	Staple length / Długość zszywki [mm]	Staple thickness / Grubość zszywki [mm]	Staple width / Szerokość zszywki [mm]	pcs / szt.	
71975	16	1.2	5.5	2000	27
71976	21	1.2	5.5	2200	18
71977	25	1.2	5.5	2000	18

EN Coil nails
 PL Gwoździe bębnowe
 DE Coilnägel
 RU Барабанные гвозди
 CZ Hřebíky spojené drátem
 RO Cuie rolă
 HU Dobtáras szeg
 ES Clavos de tambor



No.	Nail length / Długość gwoździa [mm]	Nail diameter / Średnica gwoździa [mm]	pcs / szt.	
72015	32	2.1	7200	1
72016	38	2.1	7200	1
72017	50	2.1	5400	1
72018	64	2.5	3600	1
72019	70	2.5	3600	1
72020	75	2.5	3600	1
72021	80	2.8	3000	1
72022	90	2.8	3000	1

EN Nails on paper tape
 PL Gwoździe taśmowe
 DE Streifennägel
 RU Гвозди отделочные
 CZ Páskované hřebíky
 RO Cuie pe bandă
 HU Sítáras szeg
 ES Clavos de tira de papel



No.	Nail length / Długość gwoździa [mm]	Nail diameter / Średnica gwoździa [mm]	pcs / szt.	
72010	50	2.8	3000	1
72011	65	2.8	3000	1
72012	75	2.8	3000	1
72013	90	3.1	2000	1

EN Coil nails
 PL Gwoździe bębnowe
 DE Coilnägel
 RU Барабанные гвозди
 CZ Hřebíky spojené drátem
 RO Cuie rolă
 HU Dobtáras szeg
 ES Clavos de tambor



No.	Nail length / Długość gwoździa [mm]	Nail diameter / Średnica gwoździa [mm]	pcs / szt.	
71990	32	2.1	7200	1
71991	38	2.1	7200	1
71992	50	2.1	5400	1
71993	64	2.5	3000	1
71994	70	2.5	3000	1
71995	75	2.5	3000	1
71996	80	2.8	3000	1
71997	90	2.8	3000	1

EN Coil roofing nails
 PL Gwoździe papowe bębnowe
 DE Dachpapp-Coilnägel
 RU Гвозди барабанные кровельные
 CZ Pokryvačské hřebíky spojené drátem
 RO Cuie pt. acoperiș
 HU Tetőfedő szegek dobos
 ES Clavos para techos de bobina



No.	Nail length / Długość gwoździa [mm]	Nail diameter / Średnica gwoździa [mm]	pcs / szt.	
72000	19	3.1	4200	1
72001	22	3.1	4200	1

EN Pliers for hollow expansion bolts
 PL Zaciskarka do kołków „Molly”
 DE Maueranker-Einsetzwerkzeug
 RU Клещи для дюбелей „Молли”
 CZ Kleště kotvicí pro Molly hmoždinky
 RO Clește pt. ancore metalice
 HU Molly fogó üreges bővítőcsavarokhoz
 ES Alicata para tacos „Molly”

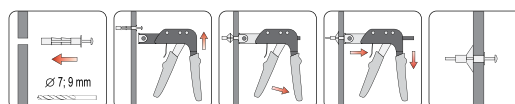

No.	
04320	10/40

EN Screw and plug set
 PL Zestaw wkrętów i kołków rozporowych
 DE Dübel- und Schrauben Sortiment
 RU Набор шурупов и дюбелей
 CZ Sada šroubů a hmoždinek
 RO Set dibluri și șuruburi
 HU Csavar és tiplí készlet
 ES Juego de tornillos y tacos

290
PCS

PE

GALVANIZED
STEEL
STAL
OCYNKOWANA

← 3.5 x 30 mm (35 PCS), 4 x 40 mm (35 PCS), 4.5 x 50 mm (30 PCS); ← 2.8 x 30 mm (35 PCS), 3.0 x 40 mm (40 PCS), 3.8 x 50 mm (35 PCS); ← 5 x 30 mm (30 PCS), 6 x 35 mm (30 PCS), 8 x 50 mm (20 PCS)



No.	pcs / szt.	📦
24112	290	5/20

EN Picture hook assortment
 PL Zestaw haków na obrazy
 DE Bilderhaken-Set
 RU Набор крючков для картин
 CZ Sada háčků na obrazy
 RO Set cârlige pt. rame foto
 HU Részec képekasztó készlet
 ES Juego de ganchos para cuadros

121
PCS

ABS

STEEL
BRASS PLATED
STAL
PLATEROWANA
MOSIADZEM

No.	pcs / szt.	📦
24130	121	6/60

EN Caulking gun
 PL Wyciskacz do mas
 DE Kartuschenpistole
 RU Пистолет для герметика
 CZ Ruční výtlačná pistole
 RO Pistol silicon
 HU Extrudáló pisztoly
 ES Pistola para masilla

230
mm

No.	Tube length / Długość tuby [mm]	📦
09130	230	10/20

EN Screw assortment
 PL Zestaw wkrętów
 DE Spanplattenschrauben Sortiment
 RU Набор шурупов

CZ Sada šroubů
 RO Set șuruburi
 HU Csavar készlet
 ES Juego de tornillos

580
PCSCARBON
STEEL
STAL
WĘGLOWA

← 4 x 20 mm (50 PCS), 5 x 30 mm (15 PCS); ← 3.5 x 19 mm (50 PCS), 4.2 x 25 mm (30 PCS); ← 1.5 x 25 mm (120 PCS), 2.0 x 40 mm (50 PCS), 3.0 x 60 mm (25 PCS); ← M4 x 20 mm (25 PCS), M5 x 25 (15 PCS); ← M4 (25 PCS), M5 (15 PCS); ← M4 (50 PCS), M5 (30 PCS); ← M4 (25 PCS), M5 (15 PCS)



No.	pcs / szt.	📦
24122	580	6/24

EN Caulking gun
 PL Wyciskacz do mas
 DE Kartuschenpistole
 RU Пистолет для герметика
 CZ Ruční výtlačná pistole
 RO Pistol silicon
 HU Extrudáló pisztoly
 ES Pistola para masilla

230
mm

No.	Tube length / Długość tuby [mm]	📦
09100	230	20/40

EN Caulking gun
 PL Wyciskacz do mas
 DE Kartuschenpistole
 RU Пистолет для герметика
 CZ Ruční výtlačná pistole
 RO Pistol silicon
 HU Extrudáló pisztoly
 ES Pistola para masilla

150
mm

No.	Tube length / Długość tuby [mm]	📦
09150	150	20/40

EN Caulking gun
 PL Wyciskacz do mas
 DE Kartuschenpistole
 RU Пистолет для герметика

CZ Ruční výtlačná pistole
 RO Pistol silicon
 HU Extrudáló pisztoly
 ES Pistola para masilla



No.	Tube length / Długość tuby [mm]	
09120	245	24

EN Building and construction cement grouting gun
 PL Aplikator do zapraw, mas szpachlowych i fugowania
 DE Spritze für Mörtel-, Spachtel- und Fugenmaßen
 RU Аппликатор для строительных растворов, шпатлевок и затирки
 CZ Aplikátor malt, plniv a spojínování
 RO Dispozitiv pt. chituit rosturi
 HU Habarcs, spatulyázó massa és fuga kinyomó
 ES Aplicador de mortero, masilla y para juntas

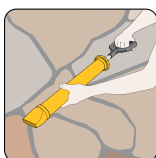
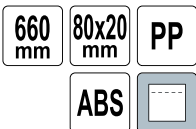

No.	L [mm]	
04450	660	24

EN Building and construction cement grouting gun
 PL Aplikator do zapraw, mas szpachlowych i fugowania
 DE Spritze für Mörtel-, Spachtel- und Fugenmaßen
 RU Аппликатор для строительных растворов, шпатлевок и затирки
 CZ Aplikátor malt, plniv a spojínování
 RO Dispozitiv pt. chituit rosturi
 HU Habarcs, spatulyázó massa és fuga kinyomó
 ES Aplicador de mortero, masilla y para juntas

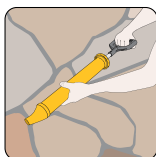
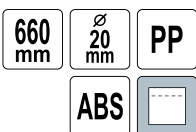

No.	L [mm]	
04452	660	24

EN Caulking gun
 PL Wyciskacz do mas
 DE Kartuschenpistole
 RU Пистолет для герметика

CZ Ruční výtlačná pistole
 RO Pistol silicon
 HU Extrudáló pisztoly
 ES Pistola para masilla



No.	Tube length / Długość tuby [mm]	
09160	230	6/12

EN Building and construction cement grouting gun
 PL Aplikator do zapraw, mas szpachlowych i fugowania
 DE Spritze für Mörtel-, Spachtel- und Fugenmaßen
 RU Аппликатор для строительных растворов, шпатлевок и затирки
 CZ Aplikátor malt, plniv a spojínování
 RO Dispozitiv pt. chituit rosturi
 HU Habarcs, spatulyázó massa és fuga kinyomó
 ES Aplicador de mortero, masilla y para juntas

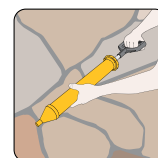
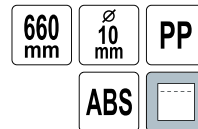

No.	L [mm]	
04451	660	24

EN Foam gun
 PL Pistolet do pianki montażowej
 DE Schaumpistole
 RU Пистолет для монтажной пены
 CZ Pistole na montážní pěnu
 RO Pistol pt. spumă
 HU Szerelőhab kinyomó pisztoly
 ES Pistola para espuma de poliuretano



No.		
09170		20

EN Foam gun
 PL Pistolet do pianki montażowej
 DE Schaumpistole
 RU Пистолет для монтажной пены
 CZ Pistolet na montážní pěnu
 RO Pistol pt. spumă
 HU Szerelőhab kinyomó pisztoly
 ES Pistola para espuma de poliuretano



VOREL

No.

09171



10/20

EN Foam gun
 PL Pistolet do pianki montażowej
 DE Schaumpistole
 RU Пистолет для монтажной пены
 CZ Pistolet na montážní pěnu
 RO Pistol pt. spumă
 HU Szerelőhab kinyomó pisztoly
 ES Pistola para espuma de poliuretano



VOREL

No.

09174



20

EN Foam gun
 PL Pistolet do pianki montażowej
 DE Schaumpistole
 RU Пистолет для монтажной пены
 CZ Pistolet na montážní pěnu
 RO Pistol pt. spumă
 HU Szerelőhab kinyomó pisztoly
 ES Pistola para espuma de poliuretano



VOREL

No.

09177



20

EN Foam gun
 PL Pistolet do pianki montażowej
 DE Schaumpistole
 RU Пистолет для монтажной пены
 CZ Pistolet na montážní pěnu
 RO Pistol pt. spumă
 HU Szerelőhab kinyomó pisztoly
 ES Pistola para espuma de poliuretano



VOREL

No.

09172



20

EN Foam gun
 PL Pistolet do pianki montażowej
 DE Schaumpistole
 RU Пистолет для монтажной пены
 CZ Pistolet na montážní pěnu
 RO Pistol pt. spumă
 HU Szerelőhab kinyomó pisztoly
 ES Pistola para espuma de poliuretano



VOREL

No.

09175



20

EN Foam gun
 PL Pistolet do pianki montażowej
 DE Schaumpistole
 RU Пистолет для монтажной пены
 CZ Pistolet na montážní pěnu
 RO Pistol pt. spumă
 HU Szerelőhab kinyomó pisztoly
 ES Pistola para espuma de poliuretano



VOREL

No.

09173



20

- EN Foam gun
 PL Pistolet do pianki montażowej
 DE Schaumpistole
 RU Пистолет для монтажной пены
 CZ Pistole na montážní pěnu
 RO Pistol pt. spumă
 HU Szerelőhab kinyomó pisztoly
 ES Pistola para espuma de poliuretano



No.	
09164	50/100

- EN Spray can tool
 PL Uchwyt pistoletowy do pojemników spray
 DE Pistolengriff für Spraydosen
 RU Пистолетная рукоятка для аэрозольей
 CZ Pistolová rukojeť pro spreje
 RO Pistol pt. spray-uri
 HU Aeroszolos szórőpisztoly fogantyú
 ES Empuñadura de pistola para aerosoles



No.	
09162	50/100

- EN Hose clip
 PL Opaska ślimakowa
 DE Schlauchklemme
 RU Хомут стальной
 CZ Šneková páska
 RO Colier metalic
 HU Csigapánt
 ES Abrazadera sin fin



No.	Ø [mm]	W [mm]	
73561	8-12	9	100
73562	10-16	9	100
73563	12-22	9	100
73565	16-27	9	100
73567	20-32	9	100
73568	25-40	9	100
73569	35-50	9	50
73570	40-60	9	50
73571	50-70	9	50
73572	60-80	9	25

- EN Screw clamp
 PL Obejma śrubowa
 DE Schraubklemme
 RU Винтовой зажим
 CZ Šroubová svorka
 RO Colier metalic
 HU Csavaros csőbilincs
 ES Abrazadera de tornillo



- EN Foam gun
 PL Pistolet do pianki montażowej
 DE Schaumpistole
 RU Пистолет для монтажной пены
 CZ Pistole na montážní pěnu
 RO Pistol pt. spumă
 HU Szerelőhab kinyomó pisztoly
 ES Pistola para espuma de poliuretano

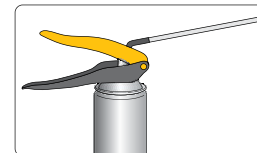

No.	
09163	100

- EN Foam gun
 PL Pistolet do pianki montażowej
 DE Schaumpistole
 RU Пистолет для монтажной пены
 CZ Pistole na montážní pěnu
 RO Pistol pt. spumă
 HU Szerelőhab kinyomó pisztoly
 ES Pistola para espuma de poliuretano



No.	
09165	20

- EN Hose clip set
 PL Zestaw serwisowy
 DE Schlauchklemmensatz
 RU Набор хомутов
 CZ Dělnická sada
 RO Set coliere metalice
 HU Szervizkészlet
 ES Juego de mantenimiento



No.	pcs / szt.	
73598	365	1



No.	Ø [mm]	W [mm]	pcs / szt.	
73780	8-10	9	4	100
73781	10-12	9	4	100
73782	12-14	9	4	100
73783	14-16	9	4	100
73784	16-18	9	4	100
73785	18-20	9	4	100
73786	20-22	9	4	100

EN Screw clamp
 PL Obejma śrubowa
 DE Schraubklemme
 RU Винтовой зажим

CZ Šroubová svorka
 RO Colier metalic
 HU Csavaros csőbilincs
 ES Abrazadera de tornillo



W1



VOREL

No.	Ø [mm]	W [mm]	pcs / szt.	
73787	19-21	18	4	100
73788	21-23	18	4	75
73789	23-25	18	4	75
73790	25-27	18	4	75
73791	27-29	18	3	75
73792	29-31	20	3	75
73793	32-35	20	3	75
73794	35-38	20	2	100
73795	38-41	20	2	100
73796	40-43	20	1	100
73797	44-47	22	1	100

No.	Ø [mm]	W [mm]	pcs / szt.	
73798	48-51	22	1	100
73799	52-55	22	1	100
73800	56-59	22	1	100
73801	60-63	22	1	100
73802	64-67	22	1	100
73803	68-73	24	1	100
73804	74-79	24	1	100
73805	80-85	24	1	100
73806	86-91	24	1	100
73807	92-97	24	1	100
73808	98-103	24	1	100

EN Cable ties
 PL Opaski plastikowe
 DE Kabelbinder
 RU Кабельные стяжки пластиковые
 CZ Stahovací pásy plastové
 RO Set coliere din plastic
 HU Kábelkötégek
 ES Bidas de plástico

PA 6.6
UL
P4V2

EN Cable ties
 PL Opaski plastikowe
 DE Kabelbinder
 RU Кабельные стяжки пластиковые

CZ Stahovací pásy plastové
 RO Set coliere din plastic
 HU Kábelkötégek
 ES Bidas de plástico

PA 6.6
UL
P4V2

VOREL

No.	Size / Rozmiar [mm]	Max. tensile strength / Maks. odporność na zrywanie [kg]	Max. wire bundle diameter / Maks. średnica wiązki kabli [mm]	pcs / szt.	
73892	2.5x100	8	20	100	250/500
73893	2.5x150	8	40	100	250/500
73894	2.5x200	8	50	100	125/250
73895	3.6x300	18	80	100	75/150
73929	4.8x280	22	80	100	50/100
73896	4.8x370	22	100	100	50/100
73897	4.8x430	22	120	100	35/70
73898	8.0x500	54	130	50	30/60

VOREL

No.	Size / Rozmiar [mm]	Max. tensile strength / Maks. odporność na zrywanie [kg]	Max. wire bundle diameter / Maks. średnica wiązki kabli [mm]	pcs / szt.	
73881	2.5x80	8	15	100	250/500
73882	2.5x100	8	20	100	250/500
73883	2.5x150	8	40	100	250/500
73884	2.5x200	8	50	100	125/250
73885	3.6x300	18	80	100	75/150
73906	4.8x200	22	50	100	75/150
73909	4.8x280	22	80	100	50/100
73886	4.8x370	22	100	100	50/100
73887	4.8x430	22	120	100	35/70
73888	8.0x500	54	130	50	30/60

EN Hook and loop cable ties
 PL Opaska rzepowa
 DE Klett-kabelbinder
 RU Хомут на липучке
 CZ Opaska na suchý zip
 RO Bandă velcro pt. organizat cabluri
 HU Tépőzáras szalag
 ES Cinta con velcro

10
PCS

NYLON

PU



EN Hook and loop cable ties
 PL Opaska rzepowa
 DE Klett-kabelbinder
 RU Хомут на липучке
 CZ Opaska na suchý zip
 RO Bandă velcro pt. organizat cabluri
 HU Tépőzáras szalag
 ES Cinta con velcro

10
PCS

NYLON

PU



VOREL

No.	Size / Rozmiar [mm]	pcs / szt.	
73840	150x25	10	50/100
73843	300x25	10	50/100
73845	450x25	10	50/100

VOREL

No.	Size / Rozmiar [mm]	pcs / szt.	
73850	150x25	10	50/100
73853	300x25	10	50/100
73855	450x25	10	50/100

- EN Nylon cable tie gun
- PL Zaciskacz do opasek kablowych
- DE Kabelbinder Verschluss Werkzeug
- RU Пистолет для кабельных стяжек
- CZ Kliešte viazacie káblové
- RO Clește pt. strans coliere plastic
- HU Kábelkötégető fogó
- ES Pistola de amarre de cables

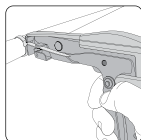

No.	10/40
73875	10/40

- EN Glue sticks
- PL Wkłady klejowe
- DE Heissklebeatronen
- RU Стержни для горячей склейки
- CZ Lepicí tyčinky
- RO Batoane adeziv
- HU Ragasztópisztoló betét
- ES Barras de cola

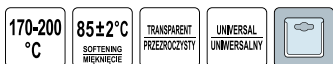

APPLICATION: - Cardboard, wood, plastic, leather, fabrics
ZASTOSOWANIE: - Tektura, drewno, plastik, skóra, tkaniny



No.	Ø [mm]	L [mm]	pcs / szt.	50/200
73260	7	100	12	50/200
73270	11	100	6	20/120
73271	11	150	12	20/60

- EN Packing tape dispenser
- PL Podajnik taśmy pakowej
- DE Verpackungsband-Abroller
- RU Диспенсер для клейких лент
- CZ Páskovačka
- RO Pistol cu banda de impachetare
- HU Csomagolószalag tépő
- ES Alimentador de la cinta de embalaje

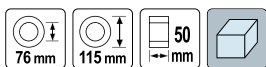

No.	W [mm]	12/24
75295	50	12/24

- EN Glue sticks
- PL Wkłady klejowe
- DE Heissklebeatronen
- RU Стержни для горячей склейки
- CZ Lepicí tyčinky
- RO Batoane adeziv
- HU Ragasztópisztoló betét
- ES Barras de cola

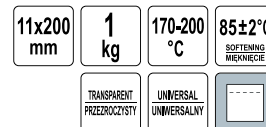

APPLICATION: - Cardboard, wood, plastic, leather, fabrics
ZASTOSOWANIE: - Tektura, drewno, plastik, skóra, tkaniny



No.	Ø [mm]	L [mm]	m [kg]	10
73300	11	200	1	10

- EN Glue applicator - bottle kit
- PL Dozownik kleju
- DE Applikator-Flasche für Flüssigklebstoffe
- RU Аппликатор клея
- CZ Aplikátor lepidla
- RO Dispenser lipici
- HU Lamellaragasztó
- ES Dispensador de pegamento



No.	50
78027	50

- EN Double-sided carpet tape
- PL Taśma dwustronna do wykładzin
- DE Doppelseitiges Klebeband für Auslegware
- RU Двухсторонняя клейкая лента для укладки ковровых покрытий
- CZ Obojstranná lepicí páska (na podlahové krytiny)
- RO Bandă dublu adezivă pt. mochetă
- HU Kétoldalas szalag szőnyegpadlóhoz
- ES Cinta de doble cara para revestimientos



No.	W [mm]	L [m]	48
75260	50	5	48
75261	50	10	36
75262	50	25	24

EN Double-sided tape
 PL Taśma dwustronna na folii
 DE Doppelseitiges Band auf PP-Folie
 RU Клейкая лента двухсторонняя на полипропиленовой основе
 CZ Obojstranná páska na PP folii
 RO Bandă dublu adezivă
 HU Kétoldalas
 ES Cinta de doble cara en film



VOREL

No.	W [mm]	L [m]	
75245	50	5	72
75246	50	10	72
75247	50	25	36

EN Warning tape
 PL Taśma ostrzegawcza
 DE Warnband
 RU Лента сигнальная
 CZ Výstražná páska
 RO Bandă de avertizare
 HU Figyelmeztető szalag
 ES Cinta de advertencia



VOREL

No.	W [mm]	L [m]	
75231	48	33	24

EN Warning tape
 PL Taśma ostrzegawcza
 DE Warnband
 RU Лента сигнальная
 CZ Výstražná páska
 RO Bandă de avertizare
 HU Figyelmeztető szalag
 ES Cinta de advertencia



No.	W [mm]	L [m]	
75233	75	100	24

EN Insulation tape
 PL Taśma izolacyjna
 DE Isolierband
 RU Изолента
 CZ Izolační páska
 RO Bandă izolatoare
 HU Szigetelőszalag
 ES Cinta aislante



No.	W [mm]	Thickness / Grubość [mm]	L [m]	pcs / szt.	
75000	19	0.13	10	10	50
75050	50	0.13	10	1	25/100

EN Mounting tape
 PL Taśma samoprzylepna dwustronna
 DE Doppelseitiges Montageband
 RU Двухсторонняя монтажная лента
 CZ Páska montážní dvouvrstvá
 RO Bandă dublu adezivă
 HU Kétoldalas ragasztószalag
 ES Cinta adhesiva de doble cara



VOREL

No.	W [mm]	L [m]	
75100	19	2.25, 5	12/96

EN Warning tape
 PL Taśma ostrzegawcza
 DE Warnband
 RU Лента сигнальная
 CZ Výstražná páska
 RO Bandă de avertizare
 HU Figyelmeztető szalag
 ES Cinta de advertencia



VOREL

No.	W [mm]	L [m]	
75230	48	33	24

EN Aluminium tape
 PL Taśma aluminiowa
 DE Aluminiumband
 RU Алюминиевая клейкая лента
 CZ Hliníková páska
 RO Bandă aluminiu
 HU Alumínium szalag
 ES Cinta de aluminio



VOREL

No.	W [mm]	L [m]	
75140	48	10	36
75141	48	50	24

EN Insulation tape
 PL Taśma izolacyjna
 DE Isolierband
 RU Изолента
 CZ Izolační páska
 RO Bandă izolatoare
 HU Szigetelőszalag
 ES Cinta aislante

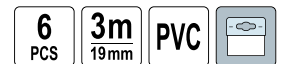

No.	W [mm]	Thickness / Grubość [mm]	L [mm]	pcs / szt.	
75060	19	0.13	3	6	10/100

EN PVC tape
 PL Taśma PCV do użytku zewnętrznego
 DE PVC Band
 RU Лента ПВХ для внешних работ
 CZ Páska PVC
 RO Bandă PVC
 HU Kétoldalas PVC
 ES Cinta de PVC para exteriores



No.	W [mm]	L [m]	
75031	48	33	50

EN Jute rope
 PL Lina jutowa
 DE Juteseil
 RU Канат джутовый
 CZ Jutové lano
 RO Funie iută
 HU Juta kötél
 ES Cable de yute



No.	Ø [mm]	L [m]	
69560	8	300	1
69561	10	200	1
69562	12	150	1
69563	14	100	1
69564	16	100	1
69565	18	50	1
69566	20	50	1

EN Packing jute string
 PL Sznurek pakowy jutowy
 DE Jute-Packschnur
 RU Шнур джутовый
 CZ Šňůra ucpávková jutová
 RO Sfoară de iută
 HU Csomagkötöző spárga, juta
 ES Cordel de yute para embalaje



No.	m [g]	
69630	50	112
69631	100	100

EN Polypropylene sennit line
 PL Linka pleciona polipropylenowa
 DE Geflochtenes Seil aus Polypropylen
 RU Канат полипропиленовый плетеный
 CZ Lano pletené polypropylenové
 RO Cordelină împletită din polipropilena
 HU Polipropilén fonott kötél
 ES Cuerda trenzada de polipropileno



No.	Ø [mm]	L [m]	
69502	4	400	1
69503	5	250	1
69504	6	250	1
69505	8	300	1
69506	10	200	1
69507	12	180	1
69508	14	110	1
69509	16	80	1
69510	18	70	1

EN String jute rope
 PL Lina jutowa skręcana
 DE Verdrillt Juteseil
 RU Канат джутовый
 CZ Jutové lano kroucená
 RO Funie răsucită de iută
 HU Sodrott juta kötél
 ES Cable de yute torcido



No.	Ø [mm]	L [m]	
69572	10	10	20

EN Flax thread, twine
 PL Nici lniane, dratwa
 DE Leinenfaden, Pechfaden
 RU Нить (дратва) льняная
 CZ Nítě lněné, dratev
 RO Sfoară de in
 HU Len cérna, fonál
 ES Hilo de lino, cabo de zapatero



No.	m [g]	
69635	100	28
69637	250	18

EN Needle rope CZ Lano s jádrem opletené
 PL Linka igłowa RO Cordelină
 DE Nadelseil HU Tűfonatos kótél
 RU Канат плетеный ES Cable acalabrotado



VOREL

No.	Ø [mm]	L [m]	
69539	8	10	30
69540	8	20	20
69542	10	10	25
69543	10	20	15
69546	12	20	10

EN Elastic sennit line
 PL Linka pleciona, elastyczna
 DE Geflochtenes Seil, elastisch
 RU Канат плетеный эластичный
 CZ Lano pletené elastické
 RO Cordelină elastică
 HU Fonott kótél, rugalmas
 ES Cuerda trenzada elástica



VOREL

No.	Ø [mm]	L [m]	
69550	6	150	1
69551	8	100	1
69552	10	100	1

EN Spliced wire polypropylene string
 PL Sznurek PP do podwiązania wełny izolacyjnej
 DE Polypropylen Erntegar
 RU Шнур полипропиленовый

CZ Provázek polypropylenový
 RO Snur din polipropilena
 HU Špagát polypropylénový
 ES Cuerda



VOREL

No.	Ø [mm]	L [m]	
69608	2.5	200	100
69609	2.5	300	80
69610	2.5	450	50
69612	2.5	1000	24
69613	2.5	2000	12

10

Memo

11

Plastering & bricklaying tools Narzędzia budowlane i malarskie



Floor laminate cutters Gilotyny do cięcia paneli podłogowych	
.....	146

Tile cutters & accessories Przyrządy do cięcia glazury i akcesoria	
.....	146-155

Tile cutters Przyrządy do glazury.....	146
--	-----

Tile cutting pliers Szczypce do glazury.....	147
--	-----

Grout removers & finishers Skrobaki i szpachelki do fug.....	147
--	-----

Accessories for tiles Akcesoria do glazury.....	148
---	-----

Burners & soldering tools Palniki i lutownice	
.....	157-158

Gas burners & accessories Palniki gazowe i akcesoria	
.....	158-160

Ladders & supports Drabiny i podpory	
.....	160-162

Masonry tools Narzędzia budowlane	
.....	162-187

Floats Pace.....	162
----------------------------	-----

Trowels Kielnie.....	165
--------------------------------	-----

Plaster & stucco spray guns Tynkownice pneumatyczne.....	165
--	-----

Tools for areated blocks Narzędzia do betonu komórkowego.....	166
---	-----

Tools for drywalls Narzędzia do płyt gipsowo-kartonowych.....	167
---	-----

Putty knives Szpachelki.....	167
--	-----

Scrapers Skrobaki.....	168
----------------------------------	-----

Mason's pans Czerpaki murarskie.....	172
--	-----

Building strainers Sita budowlane.....	172
--	-----

Paint mixers & grout mixers Mieszadła do farb i do zaprawy.....	172
---	-----

Wallpapering tools Narzędzia do tapetowania.....	174
--	-----

Paint rollers & accessories Wałki do malowania i akcesoria.....	174
---	-----

Paint brushes & accessories Pędzle malarskie i akcesoria.....	175
---	-----

Painting sheets Folie malarskie.....	179
--	-----

Tapes Taśmy.....	180
----------------------------	-----

Plastic buckets & tubs Wiadra i kasty budowlane.....	181
--	-----

Suction lifters Uchwyty do szyb.....	182
--	-----

Hooks „Juco” Haki budowlane „Juco”.....	183
---	-----

Pencils & accessories Ołówki i akcesoria.....	183
---	-----

Benders Giętarki.....	183
---------------------------------	-----

Paving tools Narzędzia brukarskie.....	184
--	-----

Wheelbarrows Taczki	
.....	187

EN Floor laminate cutter
 PL Gilotyna do cięcia paneli podłogowych
 DE Laminate Schneider
 RU Резак для ламината
 CZ Řezačka na laminátové podlahy
 RO Aparat de tăiat parchet laminat
 HU Laminált padló vágógép
 ES Guillotina para corte de laminados

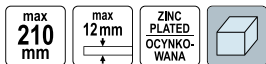

VOREL

No.	Cutting length / Długość cięcia [mm]		Guide bar diameter / Średnica prowadnicy [mm]	
28880	210		12	2

EN Tile cutter
 PL Przyrząd do cięcia glazury
 DE Fliesenschneider
 RU Плиткорез
 CZ Přístroj na řezání glazury
 RO Mașină pt. tăiat plăci ceramice
 HU Csempevágó
 ES Cortadora de cerámica

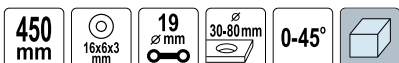

VOREL

No.	Cutting length / Długość cięcia [mm]	Guide bar diameter / Średnica prowadnicy [mm]	
00320	450	19	1

EN Tile cutter
 PL Przyrząd do cięcia glazury
 DE Fliesenschneider
 RU Плиткорез
 CZ Přístroj na řezání glazury
 RO Mașină pt. tăiat plăci ceramice
 HU Csempevágó
 ES Cortadora de cerámica

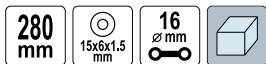

No.	Cutting length / Długość cięcia [mm]	Guide bar diameter / Średnica prowadnicy [mm]	
02300	280	16	6

EN Tile cutter
 PL Przyrząd do cięcia glazury
 DE Fliesenschneider
 RU Плиткорез
 CZ Přístroj na řezání glazury
 RO Mașină pt. tăiat plăci ceramice
 HU Csempevágó
 ES Cortadora de cerámica

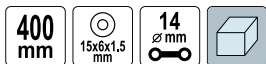

No.	Cutting length / Długość cięcia [mm]	Guide bar diameter / Średnica prowadnicy [mm]	
02400	400	14	6

EN Tile cutter
 PL Przyrząd do cięcia glazury
 DE Fliesenschneider
 RU Плиткорез
 CZ Přístroj na řezání glazury
 RO Mașină pt. tăiat plăci ceramice
 HU Csempevágó
 ES Cortadora de cerámica



VOREL

No.	Cutting length / Długość cięcia [mm]	Guide bar diameter / Średnica prowadnicy [mm]	
00300	600	19	1

EN Tile cutter
 PL Przyrząd do cięcia glazury
 DE Fliesenschneider
 RU Плиткорез
 CZ Přístroj na řezání glazury
 RO Mașină pt. tăiat plăci ceramice
 HU Csempevágó
 ES Cortadora de cerámica



VOREL

No.	Cutting length / Długość cięcia [mm]	Guide bar diameter / Średnica prowadnicy [mm]	
00610	590	16	1

EN Tile cutter
 PL Przyrząd do cięcia glazury
 DE Fliesenschneider
 RU Плиткорез
 CZ Přístroj na řezání glazury
 RO Mașină pt. tăiat plăci ceramice
 HU Csempevágó
 ES Cortadora de cerámica



VOREL

No.	Cutting length / Długość cięcia [mm]	Guide bar diameter / Średnica prowadnicy [mm]	
01060	600	15	1

EN Tile cutting wheel
 PL Kółko wymienne ze śrubą
 DE Schneidrad mit Schraube
 RU Запасной ролик для плиткореза

CZ Výměnné kolečko se šroubem
 RO Cuitit rola
 HU Cseregörgő csavarral
 ES Recambio de cuchillo redondo



VOREL

No.	Dimensions / Wymiary [mm]	For / Dla	
03150	15x6x1.5	02300, 02400	50/200
03160	16x6x3	00300, 00320	50/200
03220	22x6x2	00510, 00600, 00610, 01060	50/200

EN Tile cutting wheel
 PL Kółko tnące wymienne
 DE Schneiderrad
 RU Запасной ролик для плиткореза
 CZ Výměnné kolečko
 RO Cuițt rolă
 HU Cseregörgő csavarral
 ES Recambio de cuchillo redondo



No.	Dimensions / Wymiary [mm]	For / Dia	
03221	22x10.5x2	00703	50/200

EN Tile cutting pliers
 PL Szczypce do glazury
 DE Glasurzange
 RU Кусачки для плитки
 CZ Kleště do glazury
 RO Clește pt. plăci ceramice
 HU Csempefogó
 ES Tenazas para azulejos



No.	L [mm]	
04000	200	10/60

EN Tile cutting pliers
 PL Szczypce do łamania glazury
 DE Glasurzange
 RU Кусачки для плитки
 CZ Kleště do glazury
 RO Clește pt. plăci ceramice
 HU Csempefogó
 ES Tenazas para azulejos



No.	L [mm]	
04022	200	6/60

EN Grout finisher
 PL Szpachelka do fugi
 DE Fugenreiniger
 RU Шпатель для затирки межплиточных швов
 CZ Šuves skrěpers
 RO Răzuitoare pt. rosturi
 HU Fugakihúzó
 ES Rascador para juntas



No.	
04410	450

EN Tile cutting wheel
 PL Kółko tnące wymienne
 DE Schneiderrad
 RU Ролик для плиткореза
 CZ Výměnné kolečko
 RO Cuițt rolă
 HU Cseregörgő csavarral
 ES Recambio de cuchillo redondo



No.	Dimensions / Wymiary [mm]	
03225	22x6x6	500

EN Tile cutting pliers
 PL Szczypce do cięcia glazury
 DE Glasurzange
 RU Кусачки для плитки
 CZ Kleště do glazury
 RO Clește pt. plăci ceramice
 HU Csempefogó
 ES Tenazas para azulejos



No.	L [mm]	
04020	200	6/36

EN Tile cutting nipper
 PL Szczypce do glazury
 DE Glasurzange
 RU Кусачки для плитки
 CZ Kleště do glazury
 RO Clește pt. plăci ceramice
 HU Csempefogó
 ES Tenazas para azulejos



No.	L [mm]	
04200	200	12/60

EN Grout bag
 PL Worek do aplikacji fugi
 DE Fugenfüller-beutel
 RU Мешок для нанесения расшивки
 CZ Rukáv do spárování
 RO Pungă aplicare chit de rosturi
 HU Fugázó zsák
 ES Saco para la aplicación de juntas

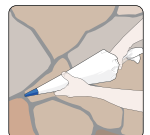

No.	
04440	36/108

- EN Grout remover
- PL Skrobak do fug
- DE Fugenreiniger
- RU Скребок для швов плитки
- CZ Škrabák na spáry
- RO Spaclu pt. rosturi
- HU Fugakihúzó
- ES Rascador para juntas



No.	Blade size / Rozmiar ostrza [mm]	
04405	50x2	12/60

- EN Circular tile cutter
- PL Wycinarka do otworów w glazurze
- DE Fliesenbohrzeug
- RU Резак по плитке
- CZ Výšeč otvorů v glazuře
- RO Cuită rotativă laiat faianță
- HU Lyukkivágó csempéhez
- ES Ruleta de corte para azulejos



No.	Cutting diameter / Średnica cięcia [mm]	
03900	20-90	20/80

- EN Adjustable plastic drill guide
- PL Prowadnica do wiercenia w płytkach ceramicznych
- DE Führungsschiene zum Bohren in Keramikfliesen
- RU Направляющая для сверления керамической плитки
- CZ Vodítko pro vrtání keramických obkladaček
- RO Ghidaj gaurire ajustabil
- HU Fúrószár vezető kerámiasempékhez
- ES Guía para taladrar en azulejos cerámicos



No.	Cutting diameter / Średnica cięcia [mm]	
03960	4-24, 25-84	40

- EN Hand tile cutter and breaker
- PL Rysik do cięcia glazury
- DE Fliesengriffel
- RU Резак для плитки
- CZ Rýsovací jehla na řezání glazury
- RO Cuită laiat / rupt faianță
- HU Karctű csempévágáshoz
- ES Cortador de azulejos



No.	L [mm]	
04050	130	50/400

- EN Tile laser
- PL Laser glazuriczny
- DE Fliesenlaser
- RU Лазерный уровень для пластин
- CZ Laserová vodováha
- RO Nivelă laser pt. plăci
- HU Csempelézer
- ES Láser de baldosas



No.	Vials / Libelle	
16030	2	20

- EN Circular tile cutter
- PL Wycinarka do otworów w glazurze
- DE Fliesenlochbohrer mit Handschutz
- RU Резак по плитке „Балеринка” с защитной решеткой
- CZ Výšeč otvorů v glazuře
- RO Cuită rotativă laiat faianță
- HU Lyukkivágó csempéhez
- ES Ruleta de corte para azulejos

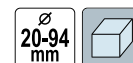

No.	Cutting diameter / Średnica cięcia [mm]	
03940	20-94	24

- EN Tile drilling guide
- PL Prowadnica do wiercenia w płytkach
- DE Führungsschiene zum Bohren in Fliesen
- RU Направляющая для сверления плитки
- CZ Vodítko pro vrtání v dlaždicích
- RO Șablon pt. marcare găuritor
- HU Csempé fúró vezető
- ES Guía de brocas para baldosas



No.	Cutting diameter / Średnica cięcia [mm]	
03963	4, 5, 6, 8, 10, 12	12/36

- EN TC tile cutter and breaker
- PL Rysik do cięcia i lamania glazury
- DE Fliesengriffel und Brecher
- RU Плиткорез-карандаш с отплавлявателем
- CZ Rýsovací jehla na řezání a lámání glazury
- RO Cuită pt. tăiat și rupt plăci ceramice
- HU Karctű csempévágáshoz és töréshez
- ES Cortador y rompedor de azulejos



No.	L [mm]	
04100	200	5/100

EN Glass cutting tool
 PL Nóż do płytek ceramicznych i szkła
 DE Fliesen- und Glasschneider
 RU Резак для керамической плитки и стекла
 CZ Nůž na fežání keramických dlaždic a skla
 RO Instrument de tăiat sticlă
 HU Csempé- és üvegvágó kés
 ES Cuchillo para cortar baldosas cerámicas y vidrio



VOREL

No.	L [mm]	
04060	120	6/240

EN Magnetic lock
 PL Maskownica uniwersalna
 DE Universal verdeckung mit Magnet
 RU Замок магнитный для кафеля
 CZ Maskovací rám univerzální do glazury
 RO Opritor magnetic
 HU Univerzális maszkoló csempépez
 ES Cierre magnetico universal

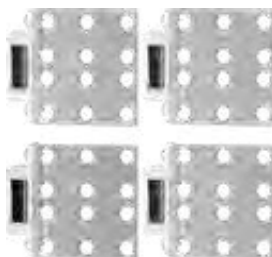

VOREL

No.		
04510		40

EN Tile suction cup
 PL Przysawka do glazury
 DE Saugnapf für Fliesen
 RU Присоска для плитки
 CZ Přísavka na obklady
 RO Ventuză pt. plăci ceramice
 HU Lapemelő tapadókorong
 ES Ventosa para azulejos



VOREL

No.	Ø [mm]	Max. lifting capacity / Maks. udźwig [kg]	
05290	80	20	200

EN Grouting sponge
 PL Gąbka glazurnicza
 DE Fliesenschwamm
 RU Губка для затирки
 CZ Houbka na spárování obkladů
 RO Burete pt. plăci ceramice
 HU Csempéző szivacs
 ES Esponja para azulejos

VOREL

No.	Dimensions / Wymiary [mm]	
04542	170x110x60	56

EN Tile leveling set
 PL Przyrząd do poziomowania płytek
 DE Schlagschnurgerät
 RU Уровень для укладки кафеля
 CZ Přístroj pro regulaci úrovně dlaždiček
 RO Fir pt. trasat
 HU Padlólapszintező eszköz
 ES Nivelador de cuerda para azulejos

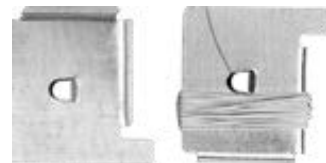
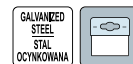

VOREL

No.		
04500		60

EN Tile magnetic fittings
 PL Uchwyty magnetyczne do płytek
 DE Fliesen Magnete
 RU Магнитные фитинги для плитки

CZ Magnety pod obklady
 RO Balamale magnetice pt. imbinarea placilor
 HU Csempémágnes
 ES Trampilla magnetica para la escotilla de inspección

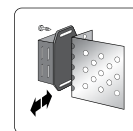
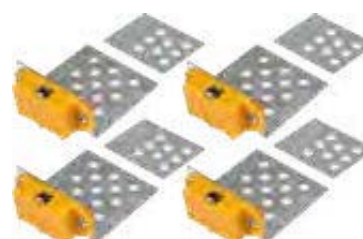

VOREL

No.	pcs / szt.	
04490	4	50/100

EN Grouting sponge
 PL Gąbka glazurnicza
 DE Fliesenschwamm
 RU Губка для затирки
 CZ Houbka na spárování obkladů
 RO Burete pt. plăci ceramice
 HU Csempéző szivacs
 ES Esponja para azulejos



VOREL

No.	Dimensions / Wymiary [mm]	
04540	165x100x60	74



- EN Grouting sponge
- PL Gąbka glazurnicza
- DE Fliesenschwamm
- RU Губка для затирки
- CZ Houba na spárování obkladů
- RO Burete pt. plăci ceramice
- HU Csempézó szivacs
- ES Esponja para azulejos



No.	Dimensions / Wymiary [mm]	
04544	165x100x80	18

- EN Glaze bucket
- PL Wiadro glazurnicze
- DE Fliesenwaschset Rolleneimer
- RU Ведро с роликом для затирки швов
- CZ Malířské vědro
- RO Galeata pt. zugravit
- HU Fugázó vödör
- ES Cubo de pintura



No.	Capacity / Pojemność [l]	
00250	10	2

- EN Tile leveling system (clips)
- PL System poziomowania płytek (klipsy)
- DE Fliesen Nivelliersystem (Clips)
- RU Система выравнивания плитки (зажимы и клинья)
- CZ Systém vyrovnávání dlaždic (spony)
- RO Sistem nivelare plăci (clipsuri)
- HU Csempeszintező rendszer (klipszek)
- ES Sistema de nivelación de baldosas (clips)

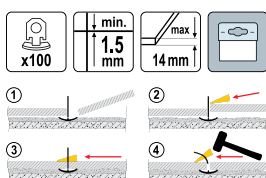

FEATURES:

- Useful when laying tiles on floors and walls
- Work great for large tiles
- Use with tiles of different thickness
- For use with 04718 wedges
- Save time and make work easy and efficient

CECHY:

- Ułatwia układanie płytek na ścianach i podłodze
- Szczególnie przydatny do płytek o większych rozmiarach
- Umożliwia poziomowanie płytek o różnych grubościach
- Do użytku z klinami 04718
- Ułatwia i przyspiesza prace



30x30	33x33	40x40	45x45	50x50	60x60	80x80	60x30	100x50	120x60
42	36	20	28	24	10	10	22	16	10

NUMBER OF CLIPS FOR VARIOUS DIMENSIONS TILES PER 1 M³
LICZBA KLIPSÓW NA M³ W ZALEŻNOŚCI OD ROZMIARU PŁYTKI



No.	pcs / szt.	
04690	100	15

- EN Grouting sponge
- PL Gąbka glazurnicza
- DE Fliesenschwamm
- RU Губка для затирки
- CZ Houba na spárování obkladů
- RO Burete pt. plăci ceramice
- HU Csempézó szivacs
- ES Esponja para azulejos

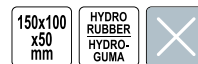

No.	Dimensions / Wymiary [mm]	
04546	150x100x50	10

- EN Tile leveling floor pliers
- PL Szczypce do poziomowania płytek
- DE Nivelliersystem Zange
- RU Щипцы до системы нивелировки
- CZ Kleště pro dlaždice vyrovnání
- RO Clește pt. sistem nivelare plăci
- HU Lapszintező speciális fogó
- ES Tenaza para sistema de nivelación



No.		
04699		5/30

- EN Tile leveling system (clips and wedges)
- PL System poziomowania płytek (klipsy i kliny)
- DE Fliesen Nivelliersystem (Clips und Keile)
- RU Система выравнивания плитки (зажимы и клинья)
- CZ Systém vyrovnávání dlaždic (spony a kliny)
- RO Sistem nivelare plăci (clipsuri și pene)
- HU Csempeszintező rendszer (klipszek és ékek)
- ES Sistema de nivelación de baldosas (clips y cuñas)

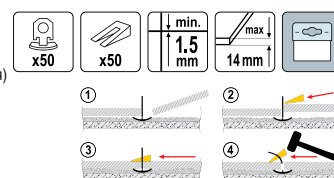

FEATURES:

- Useful when laying tiles on floors and walls
- Work great for large tiles
- Use with tiles of different thickness
- Wedges are reusable
- Save time and make work easy and efficient

CECHY:

- Ułatwia układanie płytek na ścianach i podłodze
- Szczególnie przydatny do płytek o większych rozmiarach
- Umożliwia poziomowanie płytek o różnych grubościach
- Kliny wielokrotnego użytku
- Ułatwia i przyspiesza prace



30x30	33x33	40x40	45x45	50x50	60x60	80x80	60x30	100x50	120x60
42	36	20	28	24	10	10	22	16	10

NUMBER OF CLIPS FOR VARIOUS DIMENSIONS TILES PER 1 M³
LICZBA KLIPSÓW NA M³ W ZALEŻNOŚCI OD ROZMIARU PŁYTKI



No.	pcs / szt.	
04691	50+50	15

EN Tile leveling system (clips and wedges)
 PL System poziomowania płytek (klipsy i kliny)
 DE Fliesen Nivelliersystem (Clips und Keile)
 RU Система выравнивания плитки (зажимы и клинья)
 CZ Systém vyrovnání dlaždic (spony a kliny)
 RO Sistem nivelare plăci (clipsuri și pene)
 HU Csempezintező rendszer (klipszek és ékek)
 ES Sistema de nivelación de baldosas (clips y cuñas)

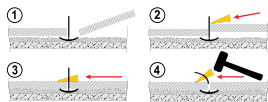
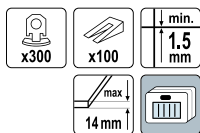

- FEATURES:**
- Useful when laying tiles on floors and walls
 - Work great for large tiles
 - Use with tiles of different thickness
 - Wedges are reusable
 - Save time and make work easy and efficient

- CECHY:**
- Ułatwia układanie płytek na ścianach i podłodze
 - Szczególnie przydatny do płytek o większych rozmiarach
 - Umożliwia poziomowanie płytek o różnych grubościach
 - Kliny wielokrotnego użytku
 - Ułatwia i przyspiesza pracę



30x30	33x33	40x40	45x45	50x50	60x60	80x80	60x30	100x50	120x60
42	36	20	28	24	10	10	22	16	10

NUMBER OF CLIPS FOR VARIOUS DIMENSIONS TILES PER 1 M²
 LICZBA KLIPSÓW NA M² W ZALEŻNOŚCI OD ROZMIARU PŁYTKI



No.	pcs / szt.	
04692	300+100	1

EN Tile leveling system (clips)
 PL System poziomowania płytek (klipsy)
 DE Fliesen Nivelliersystem (Clips)
 RU Система выравнивания плитки (зажимы)
 CZ Systém vyrovnání dlaždic (spony)
 RO Sistem nivelare plăci (clipsuri)
 HU Csempezintező rendszer (klipszek)
 ES Sistema de nivelación de baldosas (clips)

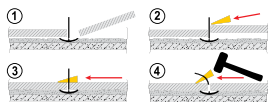
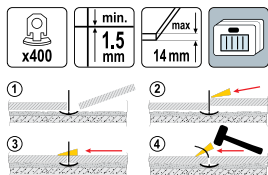

- FEATURES:**
- Useful when laying tiles on floors and walls
 - Work great for large tiles
 - Use with tiles of different thickness
 - For use with 04718 wedges
 - Save time and make work easy and efficient

- CECHY:**
- Ułatwia układanie płytek na ścianach i podłodze
 - Szczególnie przydatny do płytek o większych rozmiarach
 - Umożliwia poziomowanie płytek o różnych grubościach
 - Do użytku z klinami 04718
 - Ułatwia i przyspiesza pracę



30x30	33x33	40x40	45x45	50x50	60x60	80x80	60x30	100x50	120x60
42	36	20	28	24	10	10	22	16	10

NUMBER OF CLIPS FOR VARIOUS DIMENSIONS TILES PER 1 M²
 LICZBA KLIPSÓW NA M² W ZALEŻNOŚCI OD ROZMIARU PŁYTKI



No.	pcs / szt.	
04693	400	1

EN Tile leveling system (clips and wedges)
 PL System poziomowania płytek (klipsy i kliny)
 DE Fliesen Nivelliersystem (Clips und Keile)
 RU Система выравнивания плитки (зажимы и клинья)

CZ Systém vyrovnání dlaždic (spony a kliny)
 RO Sistem nivelare plăci (clipsuri și pene)
 HU Csempezintező rendszer (klipszek és ékek)
 ES Sistema de nivelación de baldosas (clips y cuñas)

- FEATURES:**
- Useful when laying tiles on floors and walls
 - Work great for large tiles
 - Use with tiles of different thickness
 - Wedges are reusable
 - Save time and make work easy and efficient

- CECHY:**
- Ułatwia układanie płytek na ścianach i podłodze
 - Szczególnie przydatny do płytek o większych rozmiarach
 - Umożliwia poziomowanie płytek o różnych grubościach
 - Kliny wielokrotnego użytku
 - Ułatwia i przyspiesza pracę



No.	pcs / szt.	
04714	50+50	15

EN Tile leveling system (clips, wedges and pliers)
 PL System poziomowania płytek (klipsy, kliny, szczypce)
 DE Fliesen Nivelliersystem (Klammern, Keile, Zangen)
 RU Система выравнивания плитки (зажимы, клинья, щипцы)
 CZ Systém vyrovnání dlaždic (spony, kliny, kleště)
 RO Sistem nivelare plăci (clipsuri, pene și clești)
 HU Csempezintező rendszer (klipszek, ékek és fogó)
 ES Sistema de nivelación de baldosas (clips, cuñas, pinzas)

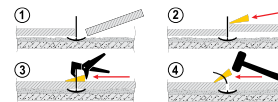
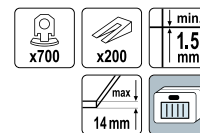

- FEATURES:**
- Useful when laying tiles on floors and walls
 - Work great for large tiles
 - Use with tiles of different thickness
 - Wedges are reusable
 - Save time and make work easy and efficient

- CECHY:**
- Ułatwia układanie płytek na ścianach i podłodze
 - Szczególnie przydatny do płytek o większych rozmiarach
 - Umożliwia poziomowanie płytek o różnych grubościach
 - Kliny wielokrotnego użytku
 - Ułatwia i przyspiesza pracę



30x30	33x33	40x40	45x45	50x50	60x60	80x80	60x30	100x50	120x60
42	36	20	28	24	10	10	22	16	10

NUMBER OF CLIPS FOR VARIOUS DIMENSIONS TILES PER 1 M²
 LICZBA KLIPSÓW NA M² W ZALEŻNOŚCI OD ROZMIARU PŁYTKI



No.	pcs / szt.	
04723	700+200	1

EN Tile leveling system (clips)
 PL System poziomowania płytek (klipsy)
 DE Fliesen Nivelliersystem (Clips)
 RU Система выравнивания плитки (зажимы)
 CZ Systém vyrovnání dlaždic (spony)
 RO Sistem nivelare plăci (clipsuri)
 HU Csempezintező rendszer (klipszek)
 ES Sistema de nivelación de baldosas (clips)

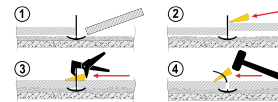
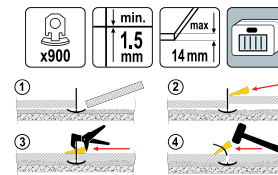

- FEATURES:**
- Useful when laying tiles on floors and walls
 - Work great for large tiles
 - Use with tiles of different thickness
 - For use with 04718 wedges
 - Save time and make work easy and efficient

- CECHY:**
- Ułatwia układanie płytek na ścianach i podłodze
 - Szczególnie przydatny do płytek o większych rozmiarach
 - Umożliwia poziomowanie płytek o różnych grubościach
 - Do użytku z klinami 04718
 - Ułatwia i przyspiesza pracę



30x30	33x33	40x40	45x45	50x50	60x60	80x80	60x30	100x50	120x60
42	36	20	28	24	10	10	22	16	10

NUMBER OF CLIPS FOR VARIOUS DIMENSIONS TILES PER 1 M²
 LICZBA KLIPSÓW NA M² W ZALEŻNOŚCI OD ROZMIARU PŁYTKI



No.	pcs / szt.	
04724	900	1

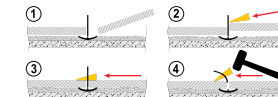
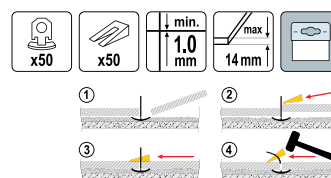

30x30	33x33	40x40	45x45	50x50	60x60	80x80	60x30	100x50	120x60
42	36	20	28	24	10	10	22	16	10

NUMBER OF CLIPS FOR VARIOUS DIMENSIONS TILES PER 1 M²
 LICZBA KLIPSÓW NA M² W ZALEŻNOŚCI OD ROZMIARU PŁYTKI

EN Tile leveling system (clips and wedges)
 PL System poziomowania płytek (klipsy i kliny)
 DE Fliesen Nivelliersystem (Clips und Keile)
 RU Система выравнивания плитки (зажимы и клинья)
 CZ Systém vyrovnání dlaždic (spony a kliny)
 RO Sistem nivelare plăci (clipsuri și pene)
 HU Csemeszintező rendszer (klipszek és ékek)
 ES Sistema de nivelación de baldosas (clips y cuñas)

FEATURES:

- Useful when laying tiles on floors and walls
- Work great for large tiles
- Use with tiles of different thickness
- Wedges are reusable
- Save time and make work easy and efficient

CECHY:

- Ułatwia układanie płytek na ścianach i podłodze
- Szczególnie przydatny do płytek o większych rozmiarach
- Umożliwia poziomowanie płytek o różnych grubościach
- Kliny wielokrotnego użytku
- Ułatwia i przyspiesza prace

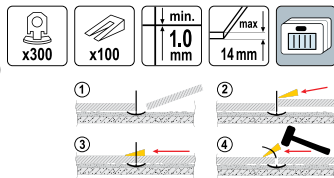

30x30	33x33	40x40	45x45	50x50	60x60	80x80	60x30	100x50	120x60
42	36	20	28	24	10	10	22	16	10

NUMBER OF CLIPS FOR VARIOUS DIMENSIONS TILES PER 1 M²
 LICZBA KLIPSÓW NA M² W ZALEŻNOŚCI OD ROZMIARU PŁYTKI



No.	pcs / szt.	
04715	300+100	1

EN Tile leveling system (clips)
 PL System poziomowania płytek (klipsy)
 DE Fliesen Nivelliersystem (Clips)
 RU Система выравнивания плитки (зажимы)
 CZ Systém vyrovnání dlaždic (spony)
 RO Sistem nivelare plăci (clipsuri)
 HU Csemeszintező rendszer (klipszek)
 ES Sistema de nivelación de baldosas (clips)

FEATURES:

- Useful when laying tiles on floors and walls
- Work great for large tiles
- Use with tiles of different thickness
- For use with 04718 wedges
- Save time and make work easy and efficient

CECHY:

- Ułatwia układanie płytek na ścianach i podłodze
- Szczególnie przydatny do płytek o większych rozmiarach
- Umożliwia poziomowanie płytek o różnych grubościach
- Do użytku z klinami 04718
- Ułatwia i przyspiesza prace

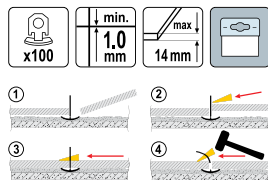

30x30	33x33	40x40	45x45	50x50	60x60	80x80	60x30	100x50	120x60
42	36	20	28	24	10	10	22	16	10

NUMBER OF CLIPS FOR VARIOUS DIMENSIONS TILES PER 1 M²
 LICZBA KLIPSÓW NA M² W ZALEŻNOŚCI OD ROZMIARU PŁYTKI



No.	pcs / szt.	
04716	100	15

EN Tile leveling system (clips)
 PL System poziomowania płytek (klipsy)
 DE Fliesen Nivelliersystem (Clips)
 RU Система выравнивания плитки (зажимы)
 CZ Systém vyrovnání dlaždic (spony)
 RO Sistem nivelare plăci (clipsuri)
 HU Csemeszintező rendszer (klipszek)
 ES Sistema de nivelación de baldosas (clips)

FEATURES:

- Useful when laying tiles on floors and walls
- Work great for large tiles
- Use with tiles of different thickness
- For use with 04718 wedges
- Save time and make work easy and efficient

CECHY:

- Ułatwia układanie płytek na ścianach i podłodze
- Szczególnie przydatny do płytek o większych rozmiarach
- Umożliwia poziomowanie płytek o różnych grubościach
- Do użytku z klinami 04718
- Ułatwia i przyspiesza prace



No.	pcs / szt.	
04713	900	1

EN Tile leveling system (clips, wedges and pliers)
 PL System poziomowania płytek (klipsy, kliny, szczypce)
 DE Fliesen Nivelliersystem (Klammern, Keile, Zangen)
 RU Система выравнивания плитки (зажимы, клинья, щипцы)
 CZ Systém vyrovnání dlaždic (spony, kliny, kleště)
 RO Sistem nivelare plăci (clipsuri, pene și clești)
 HU Csemeszintező rendszer (klipszek, ékek és fogó)
 ES Sistema de nivelación de baldosas (clips, cuñas, pinzas)

FEATURES:

- Useful when laying tiles on floors and walls
- Work great for large tiles
- Use with tiles of different thickness
- Wedges are reusable
- Save time and make work easy and efficient

CECHY:

- Ułatwia układanie płytek na ścianach i podłodze
- Szczególnie przydatny do płytek o większych rozmiarach
- Umożliwia poziomowanie płytek o różnych grubościach
- Kliny wielokrotnego użytku
- Ułatwia i przyspiesza prace

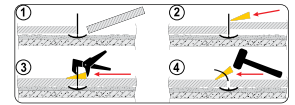
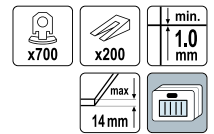

30x30	33x33	40x40	45x45	50x50	60x60	80x80	60x30	100x50	120x60
42	36	20	28	24	10	10	22	16	10

NUMBER OF CLIPS FOR VARIOUS DIMENSIONS TILES PER 1 M²
 LICZBA KLIPSÓW NA M² W ZALEŻNOŚCI OD ROZMIARU PŁYTKI



No.	pcs / szt.	
04712	700+200	1

EN Tile leveling system (clips)
 PL System poziomowania płytek (klipsy)
 DE Fliesen Nivelliersystem (Clips)
 RU Система выравнивания плитки (зажимы)
 CZ Systém vyrovnání dlaždic (spony)
 RO Sistem nivelare plăci (clipsuri)
 HU Csemeszintező rendszer (klipszek)
 ES Sistema de nivelación de baldosas (clips)

FEATURES:

- Useful when laying tiles on floors and walls
- Work great for large tiles
- Use with tiles of different thickness
- For use with 04718 wedges
- Save time and make work easy and efficient

CECHY:

- Ułatwia układanie płytek na ścianach i podłodze
- Szczególnie przydatny do płytek o większych rozmiarach
- Umożliwia poziomowanie płytek o różnych grubościach
- Do użytku z klinami 04718
- Ułatwia i przyspiesza prace

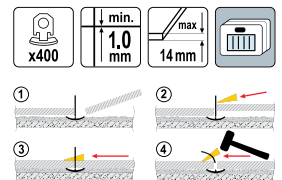

30x30	33x33	40x40	45x45	50x50	60x60	80x80	60x30	100x50	120x60
42	36	20	28	24	10	10	22	16	10

NUMBER OF CLIPS FOR VARIOUS DIMENSIONS TILES PER 1 M²
 LICZBA KLIPSÓW NA M² W ZALEŻNOŚCI OD ROZMIARU PŁYTKI



No.	pcs / szt.	
04717	400	1

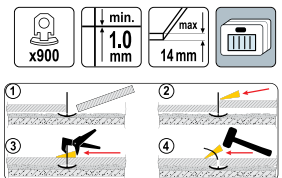

30x30	33x33	40x40	45x45	50x50	60x60	80x80	60x30	100x50	120x60
42	36	20	28	24	10	10	22	16	10

NUMBER OF CLIPS FOR VARIOUS DIMENSIONS TILES PER 1 M²
 LICZBA KLIPSÓW NA M² W ZALEŻNOŚCI OD ROZMIARU PŁYTKI

EN Tile leveling system (wedges)
 PL System poziomowania płytek (kliny)
 DE Fliesen Nivelliersystem (Keile)
 RU Система выравнивания плитки (клинья)
 CZ Systém vyrovnání dlaždic (kliny)
 RO Sistem nivelare plăci (pene)
 HU Csempeszintező rendszer (ékek)
 ES Sistema de nivelación de baldosas (cuñas)

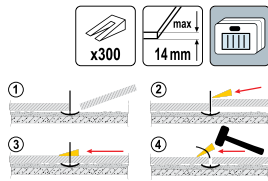

- FEATURES:**
- Useful when laying tiles on floors and walls
 - Work great for large tiles
 - Use with tiles of different thickness
 - Wedges are reusable
 - Save time and make work easy and efficient

- CECHY:**
- Ułatwia układanie płytek na ścianach i podłodze
 - Szczególnie przydatny do płytek o większych rozmiarach
 - Umożliwia poziomowanie płytek o różnych grubościach
 - Kliny wielokrotnego użytku
 - Ułatwia i przyspiesza prace



30x30	33x33	40x40	45x45	50x50	60x60	80x80	60x30	100x50	120x60
42	36	20	28	24	10	10	22	16	10

NUMBER OF CLIPS FOR VARIOUS DIMENSIONS TILES PER 1 M³
 LICZBA KLIPSÓW NA M³ W ZALEŻNOŚCI OD ROZMIARU PŁYTKI

No.	pcs / szt.	For / Dla	
04718	300	04690, 04693, 04716, 04717	1

EN Tile leveling system (clips and wedges)
 PL System poziomowania płytek (klipsy i kliny)
 DE Fliesen Nivelliersystem (Clips und Keile)
 RU Система выравнивания плитки (зажимы и клинья)
 CZ Systém vyrovnání dlaždic (spony a kliny)
 RO Sistem nivelare plăci (clipsuri și pene)
 HU Csempeszintező rendszer (klipszék és ékek)
 ES Sistema de nivelación de baldosas (clips y cuñas)

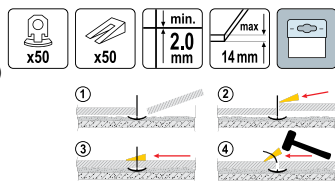

- FEATURES:**
- Useful when laying tiles on floors and walls
 - Work great for large tiles
 - Use with tiles of different thickness
 - Wedges are reusable
 - Save time and make work easy and efficient

- CECHY:**
- Ułatwia układanie płytek na ścianach i podłodze
 - Szczególnie przydatny do płytek o większych rozmiarach
 - Umożliwia poziomowanie płytek o różnych grubościach
 - Kliny wielokrotnego użytku
 - Ułatwia i przyspiesza prace



30x30	33x33	40x40	45x45	50x50	60x60	80x80	60x30	100x50	120x60
42	36	20	28	24	10	10	22	16	10

NUMBER OF CLIPS FOR VARIOUS DIMENSIONS TILES PER 1 M³
 LICZBA KLIPSÓW NA M³ W ZALEŻNOŚCI OD ROZMIARU PŁYTKI

No.	pcs / szt.	
04731	50+50	15

EN Tile leveling system (clips, wedges and pliers)
 PL System poziomowania płytek (klipsy, kliny, szczypce)
 DE Fliesen Nivelliersystem (Klammern, Keile, Zangen)
 RU Система выравнивания плитки (зажимы, клинья, щипцы)
 CZ Systém vyrovnání dlaždic (spony, kliny, kleště)
 RO Sistem nivelare plăci (clipsuri, pene și clești)
 HU Csempeszintező rendszer (klipszék, ékek és fogó)
 ES Sistema de nivelación de baldosas (clips, cuñas, pinzas)

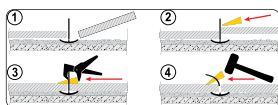

No.	pcs / szt.	
04728	700+200	1

- FEATURES:**
- Useful when laying tiles on floors and walls
 - Work great for large tiles
 - Use with tiles of different thickness
 - Wedges are reusable
 - Save time and make work easy and efficient

- CECHY:**
- Ułatwia układanie płytek na ścianach i podłodze
 - Szczególnie przydatny do płytek o większych rozmiarach
 - Umożliwia poziomowanie płytek o różnych grubościach
 - Kliny wielokrotnego użytku
 - Ułatwia i przyspiesza prace



30x30	33x33	40x40	45x45	50x50	60x60	80x80	60x30	100x50	120x60
42	36	20	28	24	10	10	22	16	10

NUMBER OF CLIPS FOR VARIOUS DIMENSIONS TILES PER 1 M³
 LICZBA KLIPSÓW NA M³ W ZALEŻNOŚCI OD ROZMIARU PŁYTKI

EN Tile leveling system (clips)
 PL System poziomowania płytek (klipsy)
 DE Fliesen Nivelliersystem (Clips)
 RU Система выравнивания плитки (зажимы)
 CZ Systém vyrovnání dlaždic (spony)
 RO Sistem nivelare plăci (clipsuri)
 HU Csempeszintező rendszer (klipszék)
 ES Sistema de nivelación de baldosas (clips)

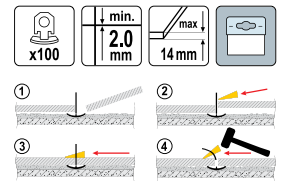

- FEATURES:**
- Useful when laying tiles on floors and walls
 - Work great for large tiles
 - Use with tiles of different thickness
 - For use with 04718 wedges
 - Save time and make work easy and efficient

- CECHY:**
- Ułatwia układanie płytek na ścianach i podłodze
 - Szczególnie przydatny do płytek o większych rozmiarach
 - Umożliwia poziomowanie płytek o różnych grubościach
 - Do użytku z klinami 04718
 - Ułatwia i przyspiesza prace



30x30	33x33	40x40	45x45	50x50	60x60	80x80	60x30	100x50	120x60
42	36	20	28	24	10	10	22	16	10

NUMBER OF CLIPS FOR VARIOUS DIMENSIONS TILES PER 1 M³
 LICZBA KLIPSÓW NA M³ W ZALEŻNOŚCI OD ROZMIARU PŁYTKI

No.	pcs / szt.	
04730	100	15

EN Tile leveling system (clips and wedges)
 PL System poziomowania płytek (klipsy i kliny)
 DE Fliesen Nivelliersystem (Clips und Keile)
 RU Система выравнивания плитки (зажимы и клинья)
 CZ Systém vyrovnání dlaždic (spony a kliny)
 RO Sistem nivelare plăci (clipsuri și pene)
 HU Csempeszintező rendszer (klipszék és ékek)
 ES Sistema de nivelación de baldosas (clips y cuñas)

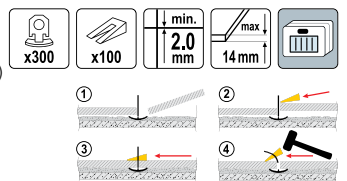

- FEATURES:**
- Useful when laying tiles on floors and walls
 - Work great for large tiles
 - Use with tiles of different thickness
 - Wedges are reusable
 - Save time and make work easy and efficient

- CECHY:**
- Ułatwia układanie płytek na ścianach i podłodze
 - Szczególnie przydatny do płytek o większych rozmiarach
 - Umożliwia poziomowanie płytek o różnych grubościach
 - Kliny wielokrotnego użytku
 - Ułatwia i przyspiesza prace



30x30	33x33	40x40	45x45	50x50	60x60	80x80	60x30	100x50	120x60
42	36	20	28	24	10	10	22	16	10

NUMBER OF CLIPS FOR VARIOUS DIMENSIONS TILES PER 1 M³
 LICZBA KLIPSÓW NA M³ W ZALEŻNOŚCI OD ROZMIARU PŁYTKI

No.	pcs / szt.	
04732	300+100	1



EN Tile leveling system (clips)
 PL System poziomowania płytek (klipsy)
 DE Fliesen Nivelliersystem (Clips)
 RU Система выравнивания плитки (зажимы)
 CZ Systém vyrovnání dlaždic (spony)
 RO Sistem nivelare plăci (clipsuri)
 HU Csemeszintező rendszer (klipszek)
 ES Sistema de nivelación de baldosas (clips)

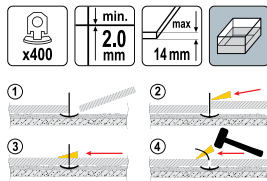

- FEATURES:**
- Useful when laying tiles on floors and walls
 - Work great for large tiles
 - Use with tiles of different thickness
 - For use with 04718 wedges
 - Save time and make work easy and efficient

CECHY:

- Ułatwia układanie płytek na ścianach i podłodze
- Szczególnie przydatny do płytek o większych rozmiarach
- Umożliwia poziomowanie płytek o różnych grubościach
- Do użytku z klinami 04718
- Ułatwia i przyspiesza prace



30x30	33x33	40x40	45x45	50x50	60x60	80x80	60x30	100x50	120x60
42	36	20	28	24	10	10	22	16	10

NUMBER OF CLIPS FOR VARIOUS DIMENSIONS TILES PER 1 M²
 LICZBA KLIPSÓW NA M² W ZALEŻNOŚCI OD ROZMIARU PŁYTKI

No.	pcs / szt.	
04734	400	1

EN Tile leveling system (clips)
 PL System poziomowania płytek (klipsy)
 DE Fliesen Nivelliersystem (Clips)
 RU Система выравнивания плитки (зажимы)
 CZ Systém vyrovnání dlaždic (spony)
 RO Sistem nivelare plăci (clipsuri)
 HU Csemeszintező rendszer (klipszek)
 ES Sistema de nivelación de baldosas (clips)

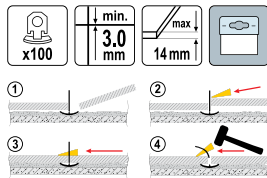

- FEATURES:**
- Useful when laying tiles on floors and walls
 - Work great for large tiles
 - Use with tiles of different thickness
 - For use with 04718 wedges
 - Save time and make work easy and efficient

CECHY:

- Ułatwia układanie płytek na ścianach i podłodze
- Szczególnie przydatny do płytek o większych rozmiarach
- Umożliwia poziomowanie płytek o różnych grubościach
- Do użytku z klinami 04718
- Ułatwia i przyspiesza prace



30x30	33x33	40x40	45x45	50x50	60x60	80x80	60x30	100x50	120x60
42	36	20	28	24	10	10	22	16	10

NUMBER OF CLIPS FOR VARIOUS DIMENSIONS TILES PER 1 M²
 LICZBA KLIPSÓW NA M² W ZALEŻNOŚCI OD ROZMIARU PŁYTKI

No.	pcs / szt.	
04735	100	15

EN Tile leveling system (clips and wedges)
 PL System poziomowania płytek (klipsy i kliny)
 DE Fliesen Nivelliersystem (Clips und Keile)
 RU Система выравнивания плитки (зажимы и клинья)

CZ Systém vyrovnání dlaždic (spony a kliny)
 RO Sistem nivelare plăci (clipsuri și pene)
 HU Csemeszintező rendszer (klipszek és ékek)
 ES Sistema de nivelación de baldosas (clips y cuñas)

- FEATURES:**
- Useful when laying tiles on floors and walls
 - Work great for large tiles
 - Use with tiles of different thickness
 - Wedges are reusable
 - Save time and make work easy and efficient

CECHY:

- Ułatwia układanie płytek na ścianach i podłodze
- Szczególnie przydatny do płytek o większych rozmiarach
- Umożliwia poziomowanie płytek o różnych grubościach
- Kliny wielokrotnego użytku
- Ułatwia i przyspiesza prace



30x30	33x33	40x40	45x45	50x50	60x60	80x80	60x30	100x50	120x60
42	36	20	28	24	10	10	22	16	10

NUMBER OF CLIPS FOR VARIOUS DIMENSIONS TILES PER 1 M²
 LICZBA KLIPSÓW NA M² W ZALEŻNOŚCI OD ROZMIARU PŁYTKI

No.	pcs / szt.	
04737	300+100	1

EN Tile leveling system (clips)
 PL System poziomowania płytek (klipsy)
 DE Fliesen Nivelliersystem (Clips)
 RU Система выравнивания плитки (зажимы)
 CZ Systém vyrovnání dlaždic (spony)
 RO Sistem nivelare plăci (clipsuri)
 HU Csemeszintező rendszer (klipszek)
 ES Sistema de nivelación de baldosas (clips)

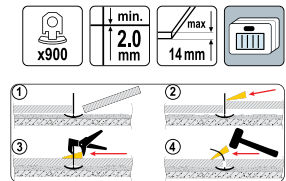

- FEATURES:**
- Useful when laying tiles on floors and walls
 - Work great for large tiles
 - Use with tiles of different thickness
 - For use with 04718 wedges
 - Save time and make work easy and efficient

CECHY:

- Ułatwia układanie płytek na ścianach i podłodze
- Szczególnie przydatny do płytek o większych rozmiarach
- Umożliwia poziomowanie płytek o różnych grubościach
- Do użytku z klinami 04718
- Ułatwia i przyspiesza prace



30x30	33x33	40x40	45x45	50x50	60x60	80x80	60x30	100x50	120x60
42	36	20	28	24	10	10	22	16	10

NUMBER OF CLIPS FOR VARIOUS DIMENSIONS TILES PER 1 M²
 LICZBA KLIPSÓW NA M² W ZALEŻNOŚCI OD ROZMIARU PŁYTKI

No.	pcs / szt.	
04729	900	1

EN Tile leveling system (clips and wedges)
 PL System poziomowania płytek (klipsy i kliny)
 DE Fliesen Nivelliersystem (Clips und Keile)
 RU Система выравнивания плитки (зажимы и клинья)
 CZ Systém vyrovnání dlaždic (spony a kliny)
 RO Sistem nivelare plăci (clipsuri și pene)
 HU Csemeszintező rendszer (klipszek és ékek)
 ES Sistema de nivelación de baldosas (clips y cuñas)

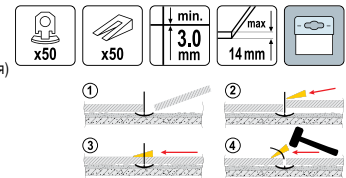

- FEATURES:**
- Useful when laying tiles on floors and walls
 - Work great for large tiles
 - Use with tiles of different thickness
 - Wedges are reusable
 - Save time and make work easy and efficient

CECHY:

- Ułatwia układanie płytek na ścianach i podłodze
- Szczególnie przydatny do płytek o większych rozmiarach
- Umożliwia poziomowanie płytek o różnych grubościach
- Kliny wielokrotnego użytku
- Ułatwia i przyspiesza prace



30x30	33x33	40x40	45x45	50x50	60x60	80x80	60x30	100x50	120x60
42	36	20	28	24	10	10	22	16	10

NUMBER OF CLIPS FOR VARIOUS DIMENSIONS TILES PER 1 M²
 LICZBA KLIPSÓW NA M² W ZALEŻNOŚCI OD ROZMIARU PŁYTKI

No.	pcs / szt.	
04736	50+50	15

EN Tile leveling system (clips, wedges and pliers)
 PL System poziomowania płytek (klipsy, kliny, szczypce)
 DE Fliesen Nivelliersystem (Klammern, Keile, Zangen)
 RU Система выравнивания плитки (зажимы, клинья, щипцы)
 CZ Systém vyrovnání dlaždic (spony, klíny, kleště)
 RO Sistem nivelare plăci (clipsuri, peni și clești)
 HU Csempezsintező rendszer (klipszek, ékek és fogó)
 ES Sistema de nivelación de baldosas (clips, cuñas, pinzas)

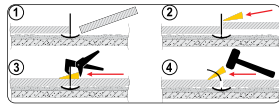
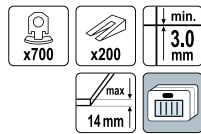

FEATURES:

- Useful when laying tiles on floors and walls
- Work great for large tiles
- Use with tiles of different thickness
- Wedges are reusable
- Save time and make work easy and efficient

CECHY:

- Ułatwia układanie płytek na ścianach i podłodze
- Szczególnie przydatny do płytek o większych rozmiarach
- Umożliwia poziomowanie płytek o różnych grubościach
- Klipy wielokrotnego użytku
- Ułatwia i przyspiesza prace



30x30	33x33	40x40	45x45	50x50	60x60	80x80	60x30	100x50	120x60
42	36	20	28	24	10	10	22	16	10

NUMBER OF CLIPS FOR VARIOUS DIMENSIONS TILES PER 1 M³
 LICZBA KLIPSÓW NA M³ W ZALEŻNOŚCI OD ROZMIARU PŁYTKI



No.	pcs / szt.	
04740	700+200	1

EN Tile leveling system (clips)
 PL System poziomowania płytek (klipsy)
 DE Fliesen Nivelliersystem (Clips)
 RU Система выравнивания плитки (зажимы)
 CZ Systém vyrovnání dlaždic (spony)
 RO Sistem nivelare plăci (clipsuri)
 HU Csempezsintező rendszer (klipszek)
 ES Sistema de nivelación de baldosas (clips)

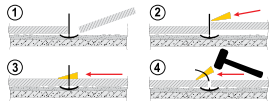
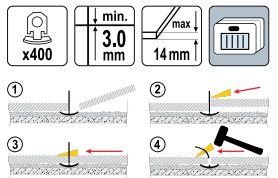

FEATURES:

- Useful when laying tiles on floors and walls
- Work great for large tiles
- Use with tiles of different thickness
- For use with 04718 wedges
- Save time and make work easy and efficient

CECHY:

- Ułatwia układanie płytek na ścianach i podłodze
- Szczególnie przydatny do płytek o większych rozmiarach
- Umożliwia poziomowanie płytek o różnych grubościach
- Do użytku z klinami 04718
- Ułatwia i przyspiesza prace



30x30	33x33	40x40	45x45	50x50	60x60	80x80	60x30	100x50	120x60
42	36	20	28	24	10	10	22	16	10

NUMBER OF CLIPS FOR VARIOUS DIMENSIONS TILES PER 1 M³
 LICZBA KLIPSÓW NA M³ W ZALEŻNOŚCI OD ROZMIARU PŁYTKI



No.	pcs / szt.	
04739	400	1

EN Tile leveling system (clips)
 PL System poziomowania płytek (klipsy)
 DE Fliesen Nivelliersystem (Clips)
 RU Система выравнивания плитки (зажимы)
 CZ Systém vyrovnání dlaždic (spony)
 RO Sistem nivelare plăci (clipsuri)
 HU Csempezsintező rendszer (klipszek)
 ES Sistema de nivelación de baldosas (clips)

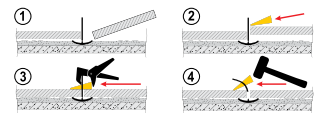

30x30	33x33	40x40	45x45	50x50	60x60	80x80	60x30	100x50	120x60
42	36	20	28	24	10	10	22	16	10

NUMBER OF CLIPS FOR VARIOUS DIMENSIONS TILES PER 1 M³
 LICZBA KLIPSÓW NA M³ W ZALEŻNOŚCI OD ROZMIARU PŁYTKI



No.	pcs / szt.	
04741	900	1

EN Tile leveling system pliers
 PL Szczypce do systemu poziomowania płytek
 DE Zange für Fliesen Nivelliersystem
 RU Щипцы для системы выравнивания плитки
 CZ Kleště pro systém vyrovnání dlaždic
 RO Clește pt. sistem nivelare plăci
 HU Csempezsintező fogó
 ES Pinzas para el sistema de nivelación de baldosas



For: 04712, 04713, 04714, 04715, 04716, 04717, 04718, 04723, 04724, 04728, 04729, 04730, 04731, 04732, 04734, 04735, 04736, 04737, 04739, 04740, 04741

For: 04712, 04713, 04714, 04715, 04716, 04717, 04718, 04723, 04724, 04728, 04729, 04730, 04731, 04732, 04734, 04735, 04736, 04737, 04739, 04740, 04741



No.	pcs / szt.	
04746		10

EN Tile leveling system
 PL Klipsy poziomujące płytki
 DE Fliesen-Ausgleichssystem
 RU Система выравнивания плитки-зажим СВР
 CZ Dlaždice nivelační systém
 RO Sistem nivelare plăci (clipsuri)
 HU Csempe szintező rendszer
 ES Sistema de nivelación del azulejo



FEATURES:

- Useful when laying tiles on floors and walls
- Work great for large tiles
- Use with tiles of different thickness
- Save time and make work easy and efficient

CECHY:

- Ułatwiają układanie płytek na ścianach i podłodze
- Szczególnie przydatne do płytek o większych rozmiarach
- Umożliwiają poziomowanie płytek o różnych grubościach
- Ułatwiają i przyspieszają prace

30x30	33x33	40x40	45x45	50x50	60x60	80x80	60x30	100x50	120x60
42	36	20	28	24	10	10	22	16	10

NUMBER OF CLIPS FOR VARIOUS DIMENSIONS TILES PER 1 M³
 LICZBA KLIPSÓW NA M³ W ZALEŻNOŚCI OD ROZMIARU PŁYTKI

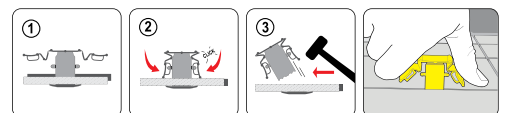

No.	pcs / szt.	
04677	100	1

- EN Starter kit for levelling ceramic tiles
- PL Zestaw startowy do poziomowania płytek
- DE Startset für Nivellierung der Fliesen
- RU Базовый комплект для выравнивания плитки
- CZ Startovací sada pro vyrovnání dlaždic
- RO Kit pt. nivelat placi ceramice
- HU Csemeszintező kezdőkészlet
- ES Kit inicial de nivelación de azulejos

FEATURES:

- Useful when laying tiles on floors and walls
- Work great for large tiles
- Use with tiles of different thickness
- Save time and make work easy and efficient

CECHY:

- Ułatwia układanie płytek na ścianach i podłodze
- Szczególnie przydatny do płytek o większych rozmiarach
- Umożliwia poziomowanie płytek o różnej grubościach
- Ułatwia i przyspiesza prace



201
PCS



No.	pcs / szt.	Box
04680	201	6/12

- EN Additional tile levelling cups
- PL Kubki dodatkowe do zestawu do poziomowania płytek
- DE Zusätzliche Kappen zum Set für Nivellierung der Fliesen
- RU Дополнительные колпачки для комплекта для выравнивания плитки
- CZ Dodatkové pohárky k sadě pro vyrovnání dlaždic
- RO Benzi si nivelat placi ceramice
- HU Plusz feltétek csemeszintező készlethez
- ES Cuñas auxiliares para el kit de nivelación de azulejos

100
PCS



No.	pcs / szt.	Box
04682	100	30

- EN Levelling tongs for precision levelling straps
- PL Szczypce do zaciągania pasków poziomujących
- DE Spannzange für Nivellierstifte
- RU Щипцы для затягивания выравнивающих полосок
- CZ Kiešťe do utahování vyrovnávacích pásků
- RO Dispozitiv pt. nivelare
- HU Szintezőszj hűző fogó
- ES Pinzas para tensar tiras de nivelación



No.	Box
04684	12/48

- EN Additional tile levelling straps
- PL Paski dodatkowe do zestawu do poziomowania płytek
- DE Zusätzliche Stifte zum Set für Nivellierung der Fliesen
- RU Дополнительные полоски для комплекта для выравнивания плитки
- CZ Dodatkové pásky k sadě pro vyrovnání dlaždic
- RO Benzi pt. nivelat placi
- HU Plusz szijak csemeszintező készlethez
- ES Tiras auxiliares para el kit de nivelación de azulejos

100
PCS

min.
0.75
mm

max.
3-40
mm



No.	pcs / szt.	Box
04681	100	18

- EN Additional tile levelling cups and straps
- PL Paski i kubki dodatkowe do zestawu do poziomowania płytek
- DE Zusätzliche Stifte und Kappen zum Set für Nivellierung der Fliesen
- RU Дополнительные полоски и колпачки для комплекта для выравнивания плитки
- CZ Dodatkové pásky a pohárky k sadě pro vyrovnání dlaždic
- RO Benzi si cupe pt. nivelat placi ceramice
- HU Plusz szijak és feltétek csemeszintező készlethez
- ES Tiras y cuñas auxiliares para el kit de nivelación de azulejos

100
PCS



No.	pcs / szt.	Box
04683	100	24

- EN Cross shape tile spacers
- PL Krzyżyki dystansowe
- DE Fliesenkreuze
- RU Крестики для плитки
- CZ Distanční křížky
- RO Distanțiere in cruce
- HU Hézagoló kereszt
- ES Crucetas para juntas



No.	Thickness / Grubość [mm]	pcs / szt.	Box
04600	1.5	200	100
04610	2.0	200	100
04620	2.5	200	100
04630	3.0	150	100
04640	4.0	100	100
04650	5.0	100	100

- EN Wedges for wall and floor tiles
- PL Klíny do glazury
- DE Keile für Wand und Bodenfliesen
- RU Клинья для плиток
- CZ Klíny do glazury
- RO Distanțiere faianța
- HU Ek csempéhez
- ES Cuñas para juntas de azulejos



No.	Thickness / Grubość [mm]	pcs / szt.	
04700	4	100	100
04710	7	50	100

- EN Gas soldering lamp
- PL Gazowa lampa lutownicza
- DE Gaslötlampe
- RU Газовая паяльная лампа
- CZ Plynová pájčecí lampa
- RO Lampă de lipit pe gaz
- HU Gázos forrasztólámpa
- ES Lampa de gas para soldar

1.7 kW max °C 1200 123 g/h BUTANE BUTAN

COMPOSITE BODY KOMPOZITOWY KORPUS 190 g



No.	Power / Moc [kW]	
73400	1.7	12

- EN Gas soldering lamp
- PL Gazowa lampa lutownicza
- DE Gaslötlampe
- RU Газовая паяльная лампа
- CZ Plynová pájčecí lampa
- RO Lampă de lipit pe gaz
- HU Gázos forrasztólámpa
- ES Lampa de gas para soldar

1.7 kW PIEZO max °C 850 123 g/h BUTANE BUTAN METAL BODY METALOWY KORPUS 190 g



No.	Power / Moc [kW]	
73404	1.7	20

- EN Panel clamps
- PL Klamry do paneli ściennych
- DE Klammern für Paneele
- RU Крепеж для панелей
- CZ Přichytky do panelů
- RO Cleme lambriu
- HU Kapcsok c panelekhez
- ES Abrazaderas para paneles de paredes

100 PCS



No.	Type / Typ	pcs / szt.	
04720	C-3	100	50
04721	C-1	100	50

- EN Gas soldering lamp
- PL Gazowa lampa lutownicza
- DE Gaslötlampe
- RU Газовая паяльная лампа
- CZ Plynová pájčecí lampa
- RO Lampă de lipit pe gaz
- HU Gázos forrasztólámpa
- ES Lampa de gas para soldar

1.7 kW PIEZO max °C 1200 123 g/h BUTANE BUTAN METAL BODY METALOWY KORPUS 190 g



No.	Power / Moc [kW]	
73403	1.7	12

- EN Gas torch
- PL Palnik gazowy
- DE Gasbrenner
- RU Газовая горелка
- CZ Plynový hořák
- RO Arzător de gaz
- HU Gázégő
- ES Soplete de gas

0.22 kW PIEZO max °C 1300 LIGHTER GAS GAZ DO ZAPALNICZEK 10 g LOCK BLOKADA 30 min CHILDREN PROTECTION ZABEZPECZENIE PRZED DZIECIŃMI 360°



No.	Power / Moc [kW]	
73420	0.22	10/60

- EN Soldering tool 3 in 1
- PL Lutownica gazowa 3 w 1
- DE 3 in 1 Gaslötkolben
- RU Газовый паяльник 3 в 1
- CZ Plynová rājka 3 v 1
- RO Ciocan de lipit cu gaz 3 in 1
- HU Gaz-forrasztópaka 3 az 1
- ES Soldador de gas 3 en 1

25-80 W

GAS GAZ

PROPANE BUTANE PROPAN BUTAN

LIGHTER GAS GAZ DO ZAPALNIKZEK

15 ml

60 min

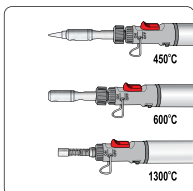

No.	Power / Moc [W]	
73410	25-80	12/48

- EN Gas blow torch
- PL Palnik gazowy
- DE Lötbrenner
- RU Газовая горелка
- CZ Plynový hořák
- RO Arzător de gaz
- HU Gázégő
- ES Soplete de gas

1.3 kW

PIEZO

max °C 1300

GAS GAZ

BUTANE BUTAN



No.	Power / Moc [kW]	
73413	1.3	10/60

- EN Point nozzle
- PL Dysza do lutowania, płomień punktowy
- DE Düse zum Löten, Punktflamme
- RU Сопло паяльника
- CZ Dýza na letování, bodový plamen
- RO Duză pt. lipit, flacără punct
- HU Forrasztó égő, szűró láng
- ES Tobera para soldadura, llama de punta

17 mm



No.	Size / Rozmiar [mm]	
73330	17	50/250

- EN Gas blow torch
- PL Palnik gazowy
- DE Lötbrenner
- RU Газовая горелка
- CZ Plynový hořák
- RO Arzător de gaz
- HU Gázégő
- ES Soplete de gas

1.3 kW

PIEZO

max °C 1300

GAS GAZ

BUTANE BUTAN



No.	Power / Moc [kW]	
73412	1.3	10/60

- EN Plumbers torch set with burners
- PL Zestaw do lutowania z dyszami
- DE Lötsatz
- RU Набор для пайки
- CZ Souprava k letování
- RO Set pt. lipit
- HU Forrasztó készlet
- ES Juego para soldadura

0.25 MPa

BUTANE BUTAN

157 g/h

2.22 kW

800-1200 °C

360 mm

x3

17/22/40 mm

2 m



No.	Max. pressure / Maks. ciśnienie [MPa]	Power / Moc [kW]	L [mm]	
73325	0.4	4	360	20

- EN Flat nozzle
- PL Dysza do lutowania, płomień płaski
- DE Düse zum Löten, flache Flamme
- RU Сопло плоское
- CZ Dýza na letování, plochý plamen
- RO Duză plată pt. arzător pe gaz
- HU Forrasztó égő, lapos láng
- ES Tobera para soldadura, llama plana

40 mm



No.	Size / Rozmiar [mm]	
73331	40	50/250

EN Roof heating torch with burners
 PL Palnik dekarSKI z dyszami
 DE Dachdeckerbrenner
 RU Кровельная горелка
 CZ Hořák pro pokrývace
 RO Arzător pt. acoperiș
 HU Bádógos forrasztó készülék
 ES Soplete de techado



0.4 MPa (max.)	BUTANE BUTAN	3785 g/h
53 kW	1500-1800 °C	360 mm
x3	25/35/50 mm	2 m

VOREL

No.	Max. pressure / Maks. ciśnienie [MPa]	Power / Moc [kW]	L [mm]	
73340	0.4	13	360	10

EN Roof heating torch with burners
 PL Palnik dekarSKI z dyszą i lancą
 DE Dachdeckerbrenner
 RU Кровельная горелка
 CZ Hořák pro pokrývace
 RO Arzător pt. acoperiș
 HU Bádógos forrasztó készülék
 ES Soplete de techado



0.4 MPa (max.)	BUTANE BUTAN	3420 g/h
47 kW	1500-1800 °C	745 mm
x1	50 mm	2 m

VOREL

No.	Max. pressure / Maks. ciśnienie [MPa]	Power / Moc [kW]	L [mm]	
73341	0.4	47	745	20

EN Roof heating torch with burners
 PL Palnik dekarSKI z dyszą i lancą
 DE Dachdeckerbrenner
 RU Кровельная горелка
 CZ Hořák pro pokrývace
 RO Arzător pt. acoperiș
 HU Bádógos forrasztó készülék
 ES Soplete de techado



0.25 MPa (max.)	BUTANE BUTAN	4465 g/h
62 kW	800-1200 °C	1315 mm
x1	60 mm	5 m

VOREL

No.	Max. pressure / Maks. ciśnienie [MPa]	Power / Moc [kW]	L [mm]	
73342	0.25	62	1315	8

EN Roof heating torch with burners
 PL Palnik dekarSKI z dyszami i lancą
 DE Dachdeckerbrenner
 RU Кровельная горелка
 CZ Hořák pro pokrývace
 RO Arzător pt. acoperiș
 HU Bádógos forrasztó készülék
 ES Soplete de techado



0.25 MPa (max.)	BUTANE BUTAN	5900 g/h
82 kW	1500-1800 °C	1385 mm
x2	60 mm	5 m

VOREL

No.	Max. pressure / Maks. ciśnienie [MPa]	Power / Moc [kW]	L [mm]	
73343	0.25	82	1385	8

EN Weed burner
 PL Palnik do wypalania chwastów
 DE Unkrautbrenner
 RU Горелка для выжигания сорняков
 CZ Hořák na pleveľ
 RO Arzător pt. buruieni
 HU Gyomégető
 ES Quemador de malezas



PIEZO	PROPANE BUTANE PROPAN BUTAN	226 g/h
3 kW	max °C 1300	7/16" 11 mm
850 mm	x1	25 mm

VOREL

No.	Power / Moc [kW]	L [mm]	
73430	3	850	12

EURO TYPE EN417



EN Nozzle
 PL Dysza
 DE Düse
 RU Conno
 CZ Dýza
 RO Duză
 HU Fúvóka
 ES Tobera



EN Hose
 PL Wąż przyłączeniowy do gazu
 DE Anschluss Schlauch für Gas
 RU Шланг газоподводящий

CZ Hadice k připojení plynu
 RO Furtun de conectare pt. arzătoare gaz
 HU Csatlakozó gáztömlő
 ES Manguera de conexión de gas



No.	Ø [mm]	
73350	25	50
73351	35	50
73352	50	50
73353	60	50



No.	L [m]	Ø [mm]	
73360	2	8	20
73362	5	8	10

EN Aluminium telescopic ladder
 PL Aluminiowa drabina teleskopowa
 DE Teleskopleiter aus Aluminium
 RU Многофункциональная стремянка
 CZ Hliníkový teleskopický žebřík
 RO Scară telesopică din aluminiu
 HU Alumínium kihúzható létra
 ES Escalera telescópica de aluminio



EN Aluminium telescopic ladder
 PL Aluminiowa drabina teleskopowa
 DE Teleskopleiter aus Aluminium
 RU Многофункциональная стремянка
 CZ Hliníkový teleskopický žebřík
 RO Scară telesopică din aluminiu
 HU Alumínium kihúzható létra
 ES Escalera telescópica de aluminio



FEATURES:

- Safe folding system according to newpest EN 131-6 standard
 - Safety lock

CECHY:

- Bezpieczny system składania zgodny z normą EN 131-6
 - Blokada zabezpieczająca



No.	Max. height / Maks. wysokość [m]	Rung quantity / Liczba stopni	
17701	3.8	13	1



No.	Max. height / Maks. wysokość [m]	Rung quantity / Liczba stopni	
17702	3.8	13	1

EN Multifold ladder
 PL Drabina wielofunkcyjna
 DE Mehrzweckleiter
 RU Лестница многофункциональная
 CZ Multifunkční žebřík
 RO Scară multifuncțională
 HU Többcéllú létra
 ES Escalera multipropósito



No.	Max. height / Maks. wysokość [m]	Rung quantity / Liczba stopni	
17704	3.4	4x3	1



EN 2-step ladder
 PL Drabina 2-stopniowa rozkładana
 DE 2-Stufen-Leiter
 RU 2-ступенчатая лестница
 CZ Schůdky 2 stupně
 RO Scără cu 2 trepte
 HU 2 fokok lépcsők
 ES 2 pasos escaleras



90x47.5 x49 cm	h 99 cm FOLDED ZŁOŻONA	2 STEPS STOPNIE
38x26 cm		max 150 kg
SOFT GRIP MIEKKI UCHWYT	PROTECTION RAIL WSPORNIK OCHRONNY	



No.	Height / Wysokość [m]	Rung quantity / Liczba stopni	
17730	0.9	2	4

EN Multifold ladder platform
 PL Podest do drabiny wielofunkcyjnej
 DE Podest für die Multifunktionale Leiter
 RU Подставки для стремянки
 CZ Plošina pro víceúčelový žebřík
 RO Platformă pt. scară multifuncțională
 HU Palló a multifunkciós létrához
 ES Descansillos para la escala multifuncional

830x295 mm	560x295 mm	ZINC PLATED OCYNKO- WANA
ANTI-SLIP SURFACE POWERSZCZONA ANTYPOŚLIZGOWA	max 150 kg	



No.	For / Dla	
17705	17704	5

EN Saw horse
 PL Podstawa robocza z metalu
 DE Stahl-Arbeitsbock
 RU Опорный штатив
 CZ Opěrný kozlík
 RO Stand de lucru, tip capră
 HU Munkabak
 ES Caballete de apoyo

2 PCS	100x10 x75 cm	max 200 kg	NON SLIP WORKTOP BLAT ANTY- POŚLIZGOWY
GALVANIZED STEEL OCYNKOWANA	HOLDER FOR CARRYING UCHWYT DO PRZENOSZENIA		



No.	
29401	1

EN 3-step ladder
 PL Drabina 3-stopniowa rozkładana
 DE 3-Stufen-Leiter
 RU 3-ступенчатая лестница
 CZ Schůdky 3 stupně
 RO Scără cu 3 trepte
 HU 3 fokok lépcsők
 ES 3 pasos escaleras



115x47.5 x65 cm	h 125 cm FOLDED ZŁOŻONA	3 STEPS STOPNIE
38x26 cm		max 150 kg
SOFT GRIP MIEKKI UCHWYT	PROTECTION RAIL WSPORNIK OCHRONNY	



No.	Height / Wysokość [m]	Rung quantity / Liczba stopni	
17733	1.15	3	2

EN Saw horse
 PL Podstawa robocza z tworzywa
 DE Stahl-Arbeitsbock
 RU Опорный штатив
 CZ Opěrný kozlík
 RO Stand de lucru, tip capră
 HU Munkabak
 ES Caballete de apoyo

2 PCS	PP	ABS	TPR	
----------	----	-----	-----	--



No.	
29400	3

EN Saw horse
 PL Podstawa robocza z regulowaną wysokością
 DE Stahl-Arbeitsbock
 RU Опорный штатив
 CZ Opěrný kozlík
 RO Stand de lucru, tip capră, reglabil
 HU Munkabak
 ES Caballete de apoyo

130 79 mm	max 200 kg	GALVANIZED STEEL STAL OCYNKOWANA	HOLDER FOR CARRYING UCHWYT DO PRZENOSZENIA	
-----------------	---------------	---	---	--



No.	
29404	1

EN Adjustable roller stand
 PL Podpora z rolką
 DE Rollenbock
 RU Роликовая опора
 CZ Opěrný stojan
 RO Stand cu role si suport
 HU Felsőörgős-bak
 ES Caballete de apoyo con rodillo



105
68 mm

60cm
ROLLER ROLKA

max 60 kg

GALVANIZED STEEL STAL OCYNKOWANA

CHROME ROLLER CHROMOWANA ROLKA



No.	
29410	1

EN Telescopic support bar
 PL Podpora teleskopowa
 DE Baustütze-Schnellspannstütze
 RU Подъемник-распорка для гипсокартона
 CZ Tyč teleskopická rozpěrná
 RO Suport sustinere telescopic
 HU Teleszkópos támasztórúd
 ES Puntal expansion



115
50 cm

max 30 kg



No.	
29440	2/10

EN Telescopic support bar
 PL Podpora teleskopowa
 DE Baustütze-Schnellspannstütze
 RU Подъемник-распорка для гипсокартона

CZ Tyč teleskopická rozpěrná
 RO Suport sustinere telescopic
 HU Teleszkópos támasztórúd
 ES Puntal expansion

290
115 cm

max 30 kg

11



No.	
29444	2/10

EN Telescopic support bar
 PL Podpora teleskopowa
 DE Baustütze-Schnellspannstütze
 RU Подъемник-распорка для гипсокартона

CZ Tyč teleskopická rozpěrná
 RO Suport sustinere telescopic
 HU Teleszkópos támasztórúd
 ES Puntal expansion

290
160 cm

max 60 kg



No.	
29445	4/8

EN Trowel
 PL Paca
 DE Reibebrett
 RU Терка
 CZ Hladitko
 RO Drișcă
 HU Glettelő
 ES Llana



No.	Size / Rozmiar [mm]	
06400	130x270	10
06410	140x500	10
06440	170x320	10

EN Trowel
 PL Paca
 DE Reibebrett
 RU Терка
 CZ Hladitko
 RO Drișcă
 HU Glettelő
 ES Llana



No.	Size / Rozmiar [mm]	
06420	140x700	10
06430	140x1000	10

EN Trowel
 PL Paca
 DE Reibebrett
 RU Телка
 CZ Hladitko
 RO Drișcă
 HU Glettelő
 ES Llana

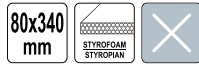

No.	Size / Rozmiar [mm]	
06401	80x340	10

EN Trowel
 PL Paca
 DE Reibebrett
 RU Телка
 CZ Hladitko
 RO Gletieră
 HU Glettelő
 ES Llana



No.	Size / Rozmiar [mm]	
06500	270x130	24

EN Trowel
 PL Paca
 DE Reibebrett
 RU Телка
 CZ Hladitko
 RO Gletieră
 HU Glettelő
 ES Llana



No.	Size / Rozmiar [mm]	Rubber thickness / Grubość gumy [mm]	
06520	270x130	4	30

EN Trowel
 PL Paca
 DE Reibebrett
 RU Телка
 CZ Hladitko
 RO Gletieră
 HU Glettelő
 ES Llana



No.	Size / Rozmiar [mm]	Sponge thickness / Grubość gąbki [mm]	
06540	270x130	25	20

EN Rasp for polystyrene
 PL Tarka do styropianu
 DE Reibebrett für Styropor
 RU Телка для пенопласта
 CZ Rašple na polystyren
 RO Gletieră pt. răzuit polistiren
 HU Polisztirol reszelő
 ES Escofina para poliestireno



No.	Size / Rozmiar [mm]	
06470	270x130	20
06472	400x180	10

EN Trowel
 PL Paca
 DE Reibebrett
 RU Телка
 CZ Hladitko
 RO Gletieră
 HU Glettelő
 ES Llana



No.	Size / Rozmiar [mm]	
06510	270x130	20

EN Trowel
 PL Paca
 DE Reibebrett
 RU Телка
 CZ Hladitko
 RO Gletieră
 HU Glettelő
 ES Llana



No.	Size / Rozmiar [mm]	Sponge thickness / Grubość gąbki [mm]	
06530	270x130	25	20



EN Trowel
PL Paca
DE Reibebrett
RU Терка
CZ Hladitko
RO Gletieră
HU Glettelő
ES Llana



No.	Size / Rozmiar [mm]	
06640	380x128	10
06660	480x128	10
06680	580x128	18

EN Trowel
PL Paca
DE Reibebrett
RU Терка
CZ Hladitko
RO Gletieră
HU Glettelő
ES Llana



No.	Size / Rozmiar [mm]	
06700	270x125	24

EN Trowel CZ Hladitko
PL Paca RO Gletieră
DE Reibebrett HU Glettelő
RU Терка ES Llana



No.	Size / Rozmiar [mm]	Teeth size / Rozmiar zębów [mm]	
06740	270x125	4x4	24
06760	270x125	6x6	24
06780	270x125	8x8	24
06781	270x125	10x10	24

EN Trowel
PL Paca
DE Reibebrett
RU Терка
CZ Hladitko
RO Gletieră
HU Glettelő
ES Llana



No.	Size / Rozmiar [mm]	
06512	260x95	12

EN Trowel CZ Hladitko
PL Paca RO Gletieră
DE Reibebrett HU Glettelő
RU Терка ES Llana



No.	Size / Rozmiar [mm]	Teeth size / Rozmiar zębów [mm]	
06650	380x128	8x8	10
06670	480x128	8x8	10
06690	580x128	8x8	18

EN Trowel
PL Paca
DE Reibebrett
RU Терка
CZ Hladitko
RO Gletieră
HU Glettelő
ES Llana



No.	Size / Rozmiar [mm]	
06701	270x130	24



EN Trowel CZ Hladitko
PL Paca RO Gletieră
DE Reibebrett HU Glettelő
RU Терка ES Llana

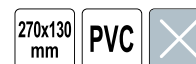

No.	Size / Rozmiar [mm]	Sponge thickness / Grubość gąbki [mm]	
06532	270x130	30	20

EN Trowel
 PL Paca
 DE Reibebrett
 RU Терка
 CZ Hladtko
 RO Gletieră
 HU Glettelő
 ES Llana



VOREL

No.	Size / Rozmiar [mm]	Rubber thickness / Grubość gumy [mm]	
06537	270x130	9	20
06538	270x130	18	20

EN Trowel
 PL Kielnia
 DE Kelle
 RU Кельма
 CZ Lžíce
 RO Mistrie
 HU Vakolókanál
 ES Paleta



VOREL

No.	Size / Rozmiar [mm]	
06341	180	50
06351	200	30

EN Trowel CZ Lžíce
 PL Kielnia RO Mistrie
 DE Kelle HU Vakolókanál
 RU Кельма ES Paleta

VOREL

No.	Size / Rozmiar [mm]	
06110	60x110	50
06120	80x120	50
06121	100x120	50

EN Plaster / stucco spray gun
 PL Tynkownica pneumatyczna do ścian
 DE Spritzpistole für Mörtel
 RU Пневмоковш для штукатурки стен
 CZ Stříkací pistole pro maltu
 RO Dispozitiv pneumatic pt. tencuit
 HU Habarcs szórőpisztoly
 ES Pistola pulverizadora para mortero

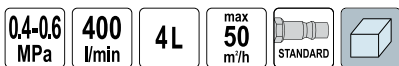

VOREL

$L_{pa} = 91,8 \pm 2,5 \text{ dB}$; $L_{wa} = 102,8 \pm 2,5 \text{ dB}$; $a_n = < 2,5 \text{ m/s}^2$

No.	Required air flow / Wymagany przepływ powietrza [l/min]	
09900	350-400	4

EN Trowel
 PL Kielnia
 DE Kelle
 RU Кельма
 CZ Lžíce
 RO Mistrie
 HU Vakolókanál
 ES Paleta



VOREL

No.	Size / Rozmiar [mm]	
06340	180	50
06350	200	50

EN Trowel
 PL Kielnia
 DE Kelle
 RU Кельма
 CZ Lžíce
 RO Mistrie
 HU Vakolókanál
 ES Paleta



VOREL

No.	Size / Rozmiar [mm]	
06370	130	50
06380	180	30



EN Ceiling plaster / stucco spray gun
 PL Tynkownica pneumatyczna do sufitów
 DE Deckenplatte / Stucco Spritzpistole
 RU Пневмоковш для штукатурки потолков
 CZ Stříkací pistole pro maltu
 RO Dispozitiv pneumatic pt. tencuit
 HU Habarcs szórőpisztoly
 ES Pistola pulverizadora para mortero



VOREL

$L_{pa} = 94,9 \pm 2,5 \text{ dB}$; $L_{wa} = 105,9 \pm 2,5 \text{ dB}$; $a_n = < 2,5 \text{ m/s}^2$

No.	Required air flow / Wymagany przepływ powietrza [l/min]	
09903	350-400	4

- EN Hand wall coating sprayer
- PL Narzutnica tynku
- DE Verputzmaschine
- RU Метатель штукатурки
- CZ Omítačka
- RO Dispozitiv pt. aplicare tencuială decorativă
- HU Vakolatszóró
- ES Máquina de revestimiento de yeso



No.	Size / Rozmiar [mm]	
09910	210x170	12

- EN Aerated concrete drill
- PL Wiertło do gazobetonu
- DE Bohrer für Porenbeton
- RU Сверло по газобетону
- CZ Vrták do pórobetonu
- RO Burghiu pt. BCA
- HU Pórusbeton fúró
- ES Broca para hormigón celular



No.	Working width / Szerokość robocza [mm]	
05821	60	20
05822	80	20
05823	120	20

- EN Scraper
- PL Zdzierak
- DE Raspelhobel
- RU Рубанок
- CZ Škrabák
- RO Gletieră
- HU Vakolatgyalu
- ES Raspador



No.	Size / Rozmiar [mm]	
05831	80x400	10

- EN Aerated concrete trowel
- PL Kielnia do gazobetonu
- DE Kelle für Porenbeton
- RU Кельма для газобетона
- CZ Zednická lžice na pórobeton
- RO Mistrie pt. BCA
- HU Simító pórusbetonhoz
- ES Paleta para hormigón celular



No.	Size / Rozmiar [mm]	
05803	125	10
05804	200	10
05805	240	10

- EN Scraper
- PL Zdzierak
- DE Raspelhobel
- RU Рубанок
- CZ Škrabák
- RO Gletieră
- HU Vakolatgyalu
- ES Raspador



No.	Size / Rozmiar [mm]	
05830	80x400	10

- EN Guide for aircrete blocks
- PL Przymiar do gazobetonu
- DE Sägewinkel für Porenbeton
- RU Угольник для резки газобетона
- CZ Úhelník na pórobeton
- RO Suport pt. tăiere BCA
- HU Pórusbeton sablon
- ES Guía para hormigón celular



No.		
05840		4

- EN Groove scraper CZ Drážkovač
 PL Rylec RO Unealta canelat BCA
 DE Nutenschaber HU Horonyvágó
 RU Штроборез ES Acanalador



No.		
05850		10

- EN Panel carry
 PL Nosidło do płyt gipsowo-kartonowych
 DE Plattenträger mit Tragegriff
 RU Приспособление для переноски плит
 CZ Držák pro přenášení desek s rukojetí
 RO Dispozitiv pt. transportat plăci de gips-carton
 HU Gipszkarton hordó
 ES Porta-paneles



No.	Dimensions / Wymiary [mm]	
04756	560x140x190	10

- EN Scraper
 PL Szpachelka
 DE Malerspachtel
 RU Шпатель
 CZ Špachtle
 RO Spaclu
 HU Spatula
 ES Espatula



No.	Working width / Szerokość robocza [mm]	
06030	30	12/240
06040	40	12/240
06050	50	12/240
06060	60	12/240
06080	80	12/240
06100	100	12/240

- EN Drywall panel carrier
 PL Uchwyt do przenoszenia płyt gipsowo-kartonowych
 DE Plattenträger mit Tragegriff
 RU Приспособление для переноски плит
 CZ Držák pro přenášení desek s rukojetí
 RO Dispozitiv pt. transportat plăci de gips-carton
 HU Jellemzők és előnyök
 ES Empunadura porta-placas

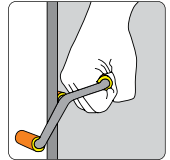

No.		
04755		6/12

- EN Drywall stripper
 PL Obcinak dwustronny do płyt gipsowo-kartonowych
 DE Streifenschneider
 RU Рейсмус-резаk для гипсокартона
 CZ Řezák na sádkarton
 RO Dispozitiv reglabil de taiere a placilor de gips-carton
 HU Gipszkarton vágó
 ES Cortador de tiras para tablaroca

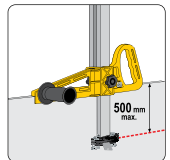
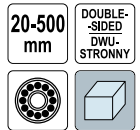

No.	Cutting width / Szerokość cięcia [mm]	
04770	20-500	10

- EN Scraper set
 PL Zestaw szpachelek
 DE Malerspachtelsatz
 RU Набор шпателей
 CZ Špachtle
 RO Set spacluri
 HU Spatula
 ES Espatulas



No.	Working width / Szerokość robocza [mm]	pcs / szt.	
06130	30, 50, 80	3	25/100

- EN Corner trowel
- PL Szpachelka kątowa
- DE Necken-Kelle
- RU Кельма угловая
- CZ Úhlová špachtle
- RO Șpaclu colț
- HU Kanál sarok
- ES Paleta ángulo



No.	Dimensions / Wymiary [mm]	
06140	80x60x60	50

- EN Plastic japanese putty knives
- PL Szpachle japońskie plastikowe
- DE Kunststoff Japan-Spachtel-Set
- RU Пластиковые шпатели «японки»
- CZ Špachtle japonské plastové
- RO Set raclete japoneze
- HU Japán spakli készlet műanyag
- ES Juego de espátulas japonesas de plástico



No.	Working width / Szerokość robocza [mm]	pcs / szt.	
05950	50, 80, 100, 120	4	10

- EN Stainless steel putty knife
- PL Szpachla nierdzewna
- DE Edelstahl-Kleberspachtel
- RU Шпатель фасадный нержавеющей
- CZ Nerezová špachtle
- RO Spaclu inox pt. chituit
- HU Rozsdamentes spakli
- ES Espátula de acero inoxidable



No.	Working width / Szerokość robocza [mm]	
06294	40	100
06295	60	80
06296	80	60
06297	100	50
06298	150	80
06301	200	60
06304	250	50
06307	350	25
06308	450	25
06309	600	10

- EN Corner trowel
- PL Szpachelka kątowa
- DE Necken-Kelle
- RU Кельма угловая
- CZ Úhlová špachtle
- RO Șpaclu colț
- HU Kanál sarok
- ES Paleta ángulo



No.	Dimensions / Wymiary [mm]	
06150	80x60x60	50

- EN Stainless steel scraper set
- PL Szpachelki nierdzewne «japonki»
- DE Aufstreichspachtel
- RU Набор шпателей тип «Японский»
- CZ Špachtle japonské nerezavějící
- RO Șpacluri japoneze inoxidabile
- HU Spatulá rozsdamentes
- ES Espátulas «japonesas» de acero

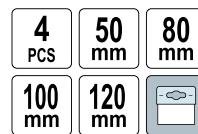

No.	Working width / Szerokość robocza [mm]	pcs / szt.	
06290	50, 80, 100, 120	4	12/120

- EN Stainless steel putty knife
- PL Szpachla nierdzewna
- DE Edelstahl-Kleberspachtel
- RU Шпатель фасадный нержавеющей
- CZ Nerezová špachtle
- RO Spaclu inox pt. chituit
- HU Rozsdamentes spakli
- ES Espátula de acero inoxidable



No.	Working width / Szerokość robocza [mm]	Teeth size / Rozmiar zębów [mm]	
06299	150	6x6	80
06300	150	8x8	80
06302	200	6x6	60
06303	200	8x8	60
06305	250	6x6	50
06306	250	8x8	50

EN Finishing spatula
 PL Szpachla wykończeniowa
 DE Flächenspachtel
 RU Финишный шпатель

CZ Špachtle fasádní
 RO Gletieră finisare
 HU Glett leköző
 ES Espátula para alisado



No.	Working width / Szerokość robocza [mm]	
06001	250	24
06002	400	12
06003	600	12
06004	800	12
06005	1000	8
06006	1200	8

EN Plastic putty knives for glue
 PL Pace plastikowe do kleju
 DE Kunststoffspachtel gezahnt
 RU Пластиковые шпатели для плиточного клея
 CZ Zubová stěrka plastová
 RO Spaclu din plastic
 HU Műanyag spakli
 ES Espátula de plástico

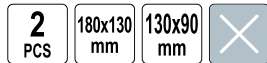

No.	Dimensions / Wymiary [mm]	pcs / szt.
05960	180x130, 130x90	2

EN Plastic putty knife
 PL Szpachla plastikowa
 DE Kunststoffspachtel
 RU Шпатель пластмассовый
 CZ Plastová špachtle
 RO Spaclu din plastic
 HU Műanyag spakli
 ES Espátula de plástico



No.	Working width / Szerokość robocza [mm]	Teeth size / Rozmiar zębów [mm]
05972	225	6x6

EN Replaceable blade for finishing spatula
 PL Ostrze do szpachli wykończeniowej
 DE Ersatzblatt für Flächenspachtel
 RU Лезвие для финишного шпателя
 CZ Náhradní čepel do špachtle fasádní
 RO Lamă de înlocuit pt. gletieră finisare
 HU Cserélhető penge glett leközőhoz
 ES Cuchilla de recambio para espátula de alisado



No.	W [mm]	For / Dla
06010	250	06001
06011	400	06002
06012	600	06003
06013	800	06004
06014	1000	06005
06015	1200	06006

EN Plastic putty knife
 PL Szpachla plastikowa
 DE Kunststoffspachtel
 RU Шпатель пластмассовый
 CZ Plastová špachtle
 RO Spaclu din plastic
 HU Műanyag spakli
 ES Espátula de plástico



No.	Working width / Szerokość robocza [mm]
05971	225

EN Plastic putty knife set
 PL Szpachle plastikowe
 DE Kunststoff-Spachtel-Set
 RU Шпатели пластиковые
 CZ Plastové špachtle
 RO Set spaclu plastic
 HU Spakli készlet műanyag
 ES Espátulas de plástico

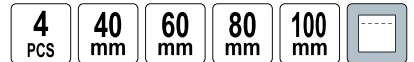

No.	Working width / Szerokość robocza [mm]	pcs / szt.
05980	40, 60, 80, 100	4

EN Rubber putty knife
 PL Szpachla gumowa
 DE Gummispachtel
 RU Шпатель резиновый
 CZ Gumová špachtle
 RO Șpaclu cauciuc
 HU Fugázó gumi
 ES Espátula de goma



No.	Working width / Szerokość robocza [mm]	
06310	150	30
06320	200	30
06330	250	30
06331	300	30

EN Stainless steel scraper
 PL Szpachelka nierdzewna
 DE Rostfrei Spachtel
 RU Шпатель нержавеющей

CZ Špachtle
 RO Șpaclu
 HU Spatula
 ES Espatula de acero inox



No.	Working width / Szerokość robocza [mm]	
05901	30	6/72
05902	40	6/72
05903	50	6/72
05904	60	6/72
05905	80	6/72
05906	100	6/72

EN Stainless steel scraper
 PL Szpachelka nierdzewna wygięta
 DE Rostfrei Spachtel
 RU Шпатель нержавеющей изогнутый
 CZ Špachtle
 RO Șpaclu
 HU Spatula
 ES Espatula de acero inox curvo



No.	Working width / Szerokość robocza [mm]	
05921	30	6/72
05922	40	6/72
05923	50	6/72
05924	60	6/72
05925	80	6/72
05926	100	6/72

EN Flexible silicone and sealant smother
 PL Gładzik do silikonu
 DE Silikonglätter
 RU Шпатель для затирки силикона
 CZ Hladitko do silikonu
 RO Spatulă pt. silicon
 HU Szilikon lehűző
 ES Alisador de juntas de silicona

150 mm

ELASTIC ELASTYCZNY



No.	L [mm]	
04360	150	24/240

EN Stainless steel scraper
 PL Szpachelka nierdzewna
 DE Rostfrei Spachtel
 RU Шпатель нержавеющей

CZ Špachtle
 RO Șpaclu
 HU Spatula
 ES Espatula de acero inox



No.	Working width / Szerokość robocza [mm]	
05911	30	6/72
05912	40	6/72
05913	50	6/72
05914	60	6/72
05915	80	6/72
05916	100	6/72

EN Painting scraper
 PL Skrobak malarski
 DE Malerabkratzer
 RU Скребок для краски со сменным лезвием
 CZ Škrabka malířská
 RO Racletă îndepărtat vopsea
 HU Festékvakaró
 ES Rascador de pintor

100 mm

SS STAINLESS STEEL STAL NERDZEWNA



No.	Blade working width / Szerokość robocza ostrza [mm]	
06795	100	60

- EN Spare blades for painting scraper
- PL Ostrze do skrobaka
- DE Schneide für Malerabkratzer
- RU Сменные лезвия для скребка
- CZ Ostrří do škrabky
- RO Lame de rezervă pt. răzuitor
- HU Fesztékvakaró-pengék
- ES Filo para rascador



No.	For / Dla	
06796	06795	10/100

- EN Scraper for concrete floor
- PL Skrobak do betonu z trzonkiem
- DE Betonschaber
- RU Скребок напольный для бетона
- CZ Škrabka
- RO Răzuitor
- HU Kaparó
- ES Raspador obra suel



No.	Blade size / Rozmiar ostrza [mm]	L [mm]	
05750	75x200	1300	10
05751	75x300	1300	10
05752	75x400	1300	10

- EN Blade for scraper
- PL Wymienne ostrze do skrobaka do betonu
- DE Klinge für Betonschaber
- RU Лезвие к скребку для бетонного пола
- CZ Škrabka vyměnitelná čepel
- RO Lamă de schimb
- HU Kaparó cserélhető penge
- ES Răzuitor lamă de schimb



No.	Blade size / Rozmiar ostrza [mm]	
05770	100x200	25/50
05771	100x300	25/50
05772	100x400	25/50

- EN Telescopic scraper
- PL Skrobak teleskopowy
- DE Teleskop Schaber
- RU Скребок телескопический
- CZ Teleskopický stěrač
- RO Răzuitor flexibil
- HU Teleszkópos jégkaparó
- ES Telescópicos raspador



No.		
06799		16/96

- EN Scraper for concrete floor
- PL Skrobak do betonu bez trzonka
- DE Betonschaber
- RU Скребок напольный для бетона
- CZ Škrabka
- RO Răzuitor
- HU Kaparó
- ES Raspador obra suel



No.	Blade size / Rozmiar ostrza [mm]	
05760	120x350	12/24
05761	120x250	12/24

- EN Blade for scraper
- PL Wymienne ostrze do skrobaka do betonu
- DE Klinge für Betonschaber
- RU Лезвие к скребку для бетонного пола
- CZ Škrabka vyměnitelná čepel
- RO Lamă de schimb
- HU Kaparó cserélhető penge
- ES Răzuitor lamă de schimb



No.	Blade size / Rozmiar ostrza [mm]	
05773	150x250	25/50
05774	150x350	25/50

EN Mason's pan
 PL Czerpak murarski
 DE Gipspfänchen
 RU Ковш штукатурный
 CZ Zednický koreček
 RO Cancioc
 HU Kőműveskanál
 ES Achicador de albanil



No.	Quantity
06335	50

EN Mixer
 PL Mieszadło
 DE Rührer
 RU Мешалка

CZ Míchadlo
 RO Mixer
 HU Keverő
 ES Mezclador



11



No.	Ø [mm]	L [mm]	Quantity
09060	60	400	40/80
09080	85	400	40/80
09090	100	600	30

EN Mixer
 PL Mieszadło
 DE Rührer
 RU Мешалка

CZ Míchadlo
 RO Mixer
 HU Keverő
 ES Mezclador



No.	Ø [mm]	L [mm]	Quantity
09005	65	410	40
09006	80	410	40

EN Mixer
 PL Mieszadło
 DE Rührer
 RU Мешалка

CZ Míchadlo
 RO Mixer
 HU Keverő
 ES Mezclador



No.	Ø [mm]	L [mm]	Quantity
09015	85	400	40
09017	100	550	20

EN Building strainer
 PL Sito budowlane
 DE Bau Sieb
 RU Сито строительное
 CZ Prohazovací síto stavební
 RO Sita construcții
 HU Építőipari rosta
 ES Cedazo para construcción



No.	Dimensions / Wymiary [cm]	Eyelet size / Rozmiar oczka [mm]	Quantity
34944	60x100	4	30
34945	60x100	6	5/30
34946	60x100	8	5/30
34947	60x100	10	30

EN Mixer
 PL Mieszadło
 DE Rührer
 RU Мешалка

CZ Míchadlo
 RO Mixer
 HU Keverő
 ES Mezclador



No.	Ø [mm]	L [mm]	Quantity
09010	110	510	40

EN Mixer
 PL Mieszadło
 DE Rührer
 RU Мешалка

CZ Míchadlo
 RO Mixer
 HU Keverő
 ES Mezclador



No.	Ø [mm]	L [mm]	Quantity
09031	75	300	10

EN Mixer CZ Michadlo
 PL Mieszadło RO Mixer
 DE Rührer HU Keverő
 RU Мешалка ES Mezclador



VOREL

No.	Ø [mm]	L [mm]	
09044	80	400	25
09046	100	600	25

EN Mixer CZ Michadlo
 PL Mieszadło RO Mixer
 DE Rührer HU Keverő
 RU Мешалка ES Mezclador



VOREL

No.	Ø [mm]	L [mm]	
09036	60	400	60
09038	80	400	35
09040	100	600	30

EN Mixer CZ Michadlo
 PL Mieszadło RO Mixer
 DE Rührer HU Keverő
 RU Мешалка ES Mezclador



VOREL

No.	Ø [mm]	L [mm]	
09096	80	400	20
09097	100	500	20

EN Mixer CZ Michadlo
 PL Mieszadło RO Mixer
 DE Rührer HU Keverő
 RU Мешалка ES Mezclador



VOREL

No.	Ø [mm]	L [mm]	
09063	115	580	10
09065	135	580	10

EN Mixer CZ Michadlo
 PL Mieszadło RO Mixer
 DE Rührer HU Keverő
 RU Мешалка ES Mezclador

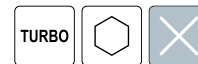

VOREL

No.	Ø [mm]	L [mm]	Type / Typ	
09048	75	400	C-75	20
09049	85	450	C-85	20
09050	100	500	C-100	20

EN Mixer CZ Michadlo
 PL Mieszadło RO Mixer
 DE Rührer HU Keverő
 RU Мешалка ES Mezclador

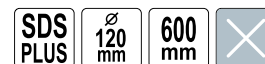

VOREL

No.	Ø [mm]	L [mm]	Type / Typ	
09094	120	600	C-120	10

EN Mixer
 PL Mieszadło
 DE Rührer
 RU Мешалка
 CZ Michadlo
 RO Mixer
 HU Keverő
 ES Mezclador



VOREL

No.	Ø [mm]	L [mm]	
09077	80	500	10

EN Mixer CZ Michadlo
 PL Mieszadło RO Mixer
 DE Rührer HU Keverő
 RU Мешалка ES Mezclador



VOREL

No.	Ø [mm]	L [mm]	
09062	100	500	20

- EN Wallpaper perforator
 PL Walek do perforacji tapet
 DE Tapetenperforierwalze
 RU Валик для перфорации обоев
 CZ Perforační váleček na tapety
 RO Perforator de tapet
 HU Tapétaperforáló henger
 ES Rodillo para perforación de papel de pared



VOREL

No.	W [mm]	
06457	150	6/36

- EN Deaeration roller
 PL Walek do odpowietrzania
 DE Entlüftungsrolle
 RU Валик аэрационный
 CZ Váleček na odvodušňování
 RO Rolă pt. aerisire șapă
 HU Levegőkinyomó henger
 ES Rodillo para hacer el vacío



VOREL

No.	Size / Rozmiar [mm]	
06450	75x230	15
06452	123x230	10

- EN Plaster roller
 PL Walek do gładzi gipsowych
 DE Rollspachtel-Walze
 RU Валик для шпаклевки
 CZ Váleček na sádrovou omítku
 RO Trafalet
 HU Glettelő henger
 ES Rodillo para masillar

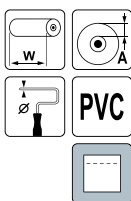

VOREL

No.	W [mm]	A [mm]	Ø [mm]	
09445	230	55	6	48

- EN Handy paint roller
 PL Walek malarski ze zbiornikiem na farbę
 DE Malerrolle mit Farbbehälter
 RU Малярный валик с емкостью для краски
 CZ Malářský váleček s nádobou na barvu
 RO Trafalet cu rezervor
 HU Festőhenger festékadagoló tartállyal
 ES Rodillo de pintura con depósito

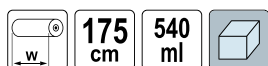

VOREL

No.	W [mm]	L [mm]	
09397	230	1750	6

- EN Squeegee for wallpapers
 PL Rakiel do tapet
 DE Tapetenrakiel
 RU Ракель для обоев
 CZ Škrabka na tapety
 RO Racleta pt. tapet
 HU Tapétalenyomó
 ES Rasqueta para papel de pared



VOREL

No.	Size / Rozmiar [mm]	
06460	280x165	12/120

- EN Deaeration roller
 PL Walek do odpowietrzania
 DE Entlüftungsrolle
 RU Валик аэрационный
- CZ Váleček na odvodušňování
 RO Rolă pt. aerisire șapă
 HU Levegőkinyomó henger
 ES Rodillo para hacer el vacío



VOREL

No.	Size / Rozmiar [mm]	
06453	110x500	2

- EN Plaster roller replacement
 PL Zapasowy walek do gładzi gipsowych
 DE Rollspachtel-Ersatzwalze
 RU Запасной валик для шпаклевки
 CZ Náhradní váleček na sádrovou omítku
 RO Rezerva trafalet
 HU Glettelő henger fej
 ES Recambio rodillo para masillar

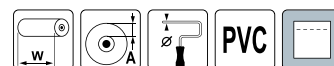

VOREL

No.	W [mm]	A [mm]	Ø [mm]	For / Dla	
09446	230	55	6	09445	50

- EN Paint roller refill
 PL Zapas do walka
 DE Ersatz Farbrolle
 RU Шубка для валика
 CZ Náhradní váleček
 RO Rezerva trafalet
 HU Pót festőhenger
 ES Recambio de rodillo



VOREL

No.	W [mm]	For / Dla	
09398	230	09397	100

EN Paint roller
 PL Walek malarski
 DE Farbroller
 RU Валик в сборе
 CZ Malířský váleček
 RO Trafalet cu tijă
 HU Festőhenger
 ES Rodillo de pintura

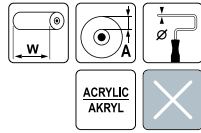

No.	W [mm]	A [mm]	Ø [mm]	
09307	180	20	6	55
09308	250	20	6	50

EN Paint roller
 PL Walek malarski
 DE Farbroller
 RU Валик в сборе
 CZ Malířský váleček
 RO Trafalet cu tijă
 HU Festőhenger
 ES Rodillo de pintura

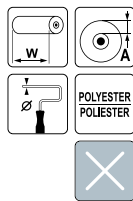

No.	W [mm]	A [mm]	Ø [mm]	
09345	180	15	6	55
09346	250	15	6	50

EN Paint roller
 PL Walek malarski
 DE Farbroller
 RU Валик в сборе
 CZ Malířský váleček
 RO Trafalet cu tijă
 HU Festőhenger
 ES Rodillo de pintura

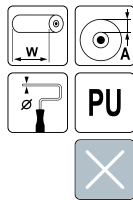

No.	W [mm]	A [mm]	Ø [mm]	
09370	50	35	6	70

EN Paint roller refill
 PL Zapas do walka
 DE Ersatz Farbrolle
 RU Шубка для валика
 CZ Náhradní váleček
 RO Rezerva trafalet
 HU Pót festőhenger
 ES Recambio de rodillo



No.	W [mm]	A [mm]	Ø [mm]	
09302	180	15	6	40
09303	250	15	8	25

EN Paint roller
 PL Walek malarski
 DE Farbroller
 RU Валик в сборе
 CZ Malířský váleček
 RO Trafalet cu tijă
 HU Festőhenger
 ES Rodillo de pintura

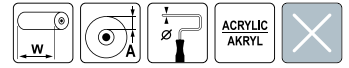

No.	W [mm]	A [mm]	Ø [mm]	
09334	100	9	6	40
09336	180	18	6	60

EN Paint roller
 PL Walek malarski
 DE Farbroller
 RU Валик в сборе
 CZ Malířský váleček
 RO Trafalet cu tijă
 HU Festőhenger
 ES Rodillo de pintura

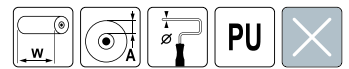

No.	W [mm]	A [mm]	Ø [mm]	
09359	150	50	6	50

EN Paint roller
 PL Walek malarski
 DE Farbroller
 RU Валик в сборе
 CZ Malířský váleček
 RO Trafalet cu tijă
 HU Festőhenger
 ES Rodillo de pintura

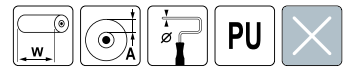

No.	W [mm]	A [mm]	Ø [mm]	
09371	70	35	6	80
09372	100	35	6	70
09373	150	50	6	50

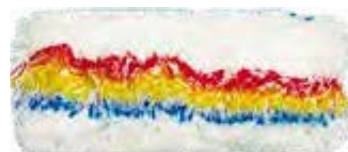
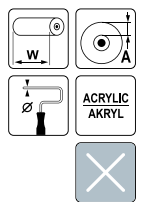

EN Paint roller refill
 PL Zapas do walka
 DE Ersatz Farbrolle
 RU Шубка для валика

CZ Náhradní váleček
 RO Rezerva trafalet
 HU Pót festőhenger
 ES Recambio de rodillo

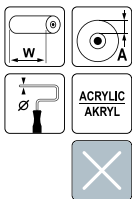

No.	W [mm]	A [mm]	Ø [mm]	
09310	180	20	6	10/40
09311	250	20	6	40

EN Paint roller refill
 PL Zapas do walka
 DE Ersatz Farbrolle
 RU Шубка для валика

CZ Náhradní váleček
 RO Rezerva trafalet
 HU Pót festőhenger
 ES Recambio de rodillo

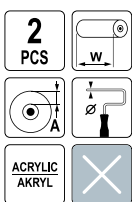

No.	W [mm]	A [mm]	Ø [mm]	
09338	100	9	6	150

EN Paint roller refill
 PL Zapas do walka
 DE Ersatz Farbrolle
 RU Шубка для валика

CZ Náhradní váleček
 RO Rezerva trafalet
 HU Pót festőhenger
 ES Recambio de rodillo

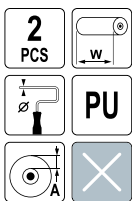

No.	W [mm]	A [mm]	Ø [mm]	
09375	50	35	6	200
09377	100	35	6	90

EN Paint grid
 PL Kratka malarska
 DE Abstreifgitter
 RU Решетка малярная
 CZ Malířská mřížka
 RO Grătar pt. trafalet
 HU Festőrács
 ES Rejilla de pintura

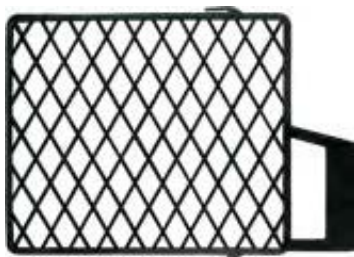

No.	[mm]	
09413	265x285	100

EN Paint roller refill
 PL Zapas do walka
 DE Ersatz Farbrolle
 RU Шубка для валика

CZ Náhradní váleček
 RO Rezerva trafalet
 HU Pót festőhenger
 ES Recambio de rodillo



No.	W [mm]	A [mm]	Ø [mm]	
09331	180	6	6	10/50
09332	250	6	8	10/40

EN Paint roller refill
 PL Zapas do walka
 DE Ersatz Farbrolle
 RU Шубка для валика

CZ Náhradní váleček
 RO Rezerva trafalet
 HU Pót festőhenger
 ES Recambio de rodillo

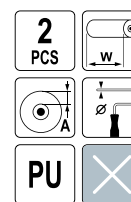

No.	W [mm]	A [mm]	Ø [mm]	
09365	100	35	6	80

EN Paint tray
 PL Kuweta malarska
 DE Farbwanne
 RU Ванночка малярная
 CZ Malířská vanička
 RO Tavă suport trafalet
 HU Festéktálca
 ES Cubeta para rodillo



No.	[mm]	
09406	150x245	75
09408	330x350	50

EN Paint roller with grid
 PL Walek z kratką
 DE Farbrolle mit Abstreifgitter
 RU Валик с решёткой
 CZ Váleček s mřížkou
 RO Trafalet cu grătar
 HU Festőhenger ráccsal
 ES Rodillo con rejilla

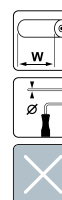

No.	W [mm]	Ø [mm]	
09385	180	6	25

EN Paint roller with tray
 PL Walek z kuwetą
 DE Farbroller mit Farbwanne
 RU Валик с ванночкой
 CZ Váleček s vaničkou
 RO Trafalet cu tavă
 HU Festőhenger és kűvettával
 ES Rodillo y cubeta

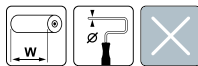

VOREL

No.	W [mm]	Ø [mm]	Box
09390	180	6	12

EN Roller frame
 PL Uchwyt do wałka
 DE Farbroller-Griff
 RU Ручка для валика
 CZ Držák válečku
 RO Mâner trafalet
 HU Festőhenger nyél
 ES Mango de rodillo

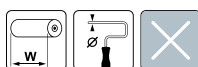

VOREL

No.	W [mm]	Ø [mm]	Box
09421	50/70	6	90
09422	100	6	90
09430	250	8	80

EN Flat paint brush
 PL Pędzel angielski profesjonalny
 DE Professional Flachpinsel
 RU Профессиональная кисть флейцевая тип Английский
 CZ Anglický štětec profesionální
 RO Pensulă englezească profesională
 HU Profeszionális laposecset
 ES Brocha plana profesional



VOREL

No.	W [mm]	H [mm]	Box
09531	25	51/46	50
09532	36	51/46	50
09533	50	57/52	50
09534	62	57/52	50
09535	75	57/52	50
09536	87	64/59	50
09537	102	64/59	50

EN Paint roller with tray
 PL Walek z kuwetą
 DE Farbroller mit Farbwanne
 RU Валик с ванночкой
 CZ Váleček s vaničkou
 RO Trafalet cu tavă
 HU Festőhenger és kűvettával
 ES Rodillo y cubeta

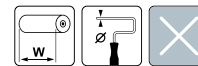

VOREL

No.	W [mm]	Ø [mm]	Box
09395	50	6	60

EN Flat paint brush
 PL Pędzel angielski
 DE Flachpinsel
 RU Кисть флейцевая тип Английский
 CZ Štětec anglický
 RO Pensulă englezească
 HU Laposecset
 ES Brocha plana

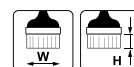

VOREL

No.	W [mm]	H [mm]	Box
09521	25	44/39	50
09522	36	51/46	50
09523	50	51/46	50
09524	63	51/46	50
09525	76	51/46	50

EN Angled paint brush
 PL Pędzel kaloryferowy
 DE Heizkörperpinsel
 RU Кисть радиаторная
 CZ Štětec na topná tělesa
 RO Pensulă pt. calorifere
 HU Radiátorecset
 ES Brocha angulada de radiadores

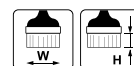

VOREL

No.	W [mm]	H [mm]	Box
09560	25	44/39	50
09561	36	51/46	50
09562	50	51/46	50

- EN Round paint brush
- PL Pędzel okrągły
- DE Ringpinsel
- RU Кисть круглая
- CZ Kulatý štětec
- RO Pensula rotundă
- HU Marokecset
- ES Brocha redonda



No.	W [mm]	H [mm]	
09581	20	44/39	50
09583	30	51/46	50
09585	40	51/46	50
09587	50	57/52	50
09589	60	57/52	50

- EN Paint brush
- PL Ławkowiec
- DE Malerbürste
- RU Кисть-макловица деревянная ручка
- CZ Natírací kartáč profesionální
- RO Bidinea profesională
- HU Profesionális kenőkefe
- ES Brocha prof.



No.	W [mm]	H [mm]	
09647	170x65	64/58	10
09648	180x75	70/64	10
09649	190x85	76/68	10

- EN Paint brushes
- PL Pędzle malarskie
- DE Pinselset
- RU Набор кистей
- CZ Sada malířských štětců
- RO Set pensule
- HU Festőecset készlet
- ES Brochas de pintar



No.	W [mm]	pcs / szt.	
09920	25, 36, 50	3	25/200
09930	36, 50, 63	3	40/160
09950	15, 25, 36, 50, 63	5	25/100

- EN Brush for wallpapers
- PL Pędzel do tapet
- DE Flächenstreicher
- RU Кисть-макловица деревянная ручка

- CZ Štětec na tapety dřevěný
- RO Bidinea pt. tapet
- HU Ecset fa tapétákhoz
- ES Brocha de empapelar madero

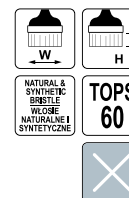

No.	W [mm]	H [mm]	
09636	110x30	51/46	30
09638	130x30	51/46	30
09640	140x40	57/52	30
09642	150x50	64/59	30

- EN Paint brush
- PL Chłapacz PCV
- DE Deckenbürste
- RU Кисть-макловица ПВХ
- CZ Smeták PVC
- RO Bidinea PVC
- HU PVC meszelő
- ES Brocha de PVC



No.	W [mm]	
09651	170x60	30

- EN Paint brush
- PL Ławkowiec PET
- DE Malerbürste
- RU Кисть-макловица PET
- CZ Natírací kartáč
- RO Bidinea
- HU Kenőkefe
- ES Brocha



No.	W [mm]	
09655	150x70	12
09650	170x70	12
09656	180x80	10

- EN Brush for pitch
 PL Smolowiec
 DE Pechstein
 RU Кисть для смолы
- CZ Kartáč asfalterský
 RO Perie pt. asfalt
 HU Kátránykenő kefe
 ES Brocha para alquitrán



No.	W [mm]	
09653	170	30

- EN Protective dust sheet
 PL Folia ochronna
 DE Abdeckplane
 RU Пленка защитная
 CZ Fólie krycí
 RO Folie de protecție
 HU Takarófolia
 ES Plástico protector



No.	[m]	Thickness / Grubość [µm]	Material / Material	
09462	4x5	5	HDPE	40
09463	4x5	15	LDPE	20

- EN Waste bags
 PL Worki na odpady
 DE Müllsäcke
 RU Пакеты для мусора
 CZ Pytle na odpad
 RO Saci de gunoi
 HU Szemeteszsák
 ES Bolsas para residuos



No.	Capacity / Pojemność [l]	Thickness / Grubość [µm]	pcs / szt.	
09475	80	142	10	10
09476	80	142	3	10
09477	120	142	10	10
09478	120	142	3	10

- EN Waste bags
 PL Worki na odpady
 DE Müllsäcke
 RU Пакеты для мусора
- CZ Pytle na odpad
 RO Saci de gunoi
 HU Szemeteszsák
 ES Bolsas para residuos



No.	Capacity / Pojemność [l]	Thickness / Grubość [µm]	pcs / szt.	
09472	240	40	10	10

- EN Magnetic paint brush holder
 PL Uchwyt magnetyczny do pędzli
 DE Magnethalter für Pinsel
 RU Магнитный патрон для кистей
 CZ Magnetický držák štětů
 RO Suport magnetic pt. pensule zugravit
 HU Mágneses ecsettartó
 ES Soporte magnético para pinceles

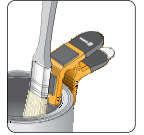
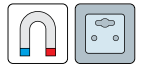

No.	L [mm]	
09590	90	24/96

- EN Protective dust sheet
 PL Folia ochronna
 DE Abdeckplane
 RU Пленка защитная
 CZ Fólie krycí
 RO Folie de protecție
 HU Takarófolia
 ES Plástico protector



No.	[m]	Thickness / Grubość [µm]	
09457	4x5	20	15
09459	4x5	30	10

- EN Waste bags
 PL Worki na odpady
 DE Müllsäcke
 RU Пакеты для мусора
 CZ Pytle na odpad
 RO Saci de gunoi
 HU Szemeteszsák
 ES Bolsas para residuos



No.	Capacity / Pojemność [l]	Thickness / Grubość [µm]	pcs / szt.	
09470	80	40	10	30
09471	120	60	15	10
09479	120	100	10	10
09464	160	60	10	10
09468	240	70	10	6
09469	360	50	10	8



EN Self adhesive paper tape
 PL Taśma papierowa samoprzylepna
 DE Papierband selbstklebend
 RU Лента малярная бумажная

CZ Páska papírová samolepicí
 RO Banda adeziva hartie
 HU Őntapadó papírszalag
 ES Cinta de papel autoadhesiva

25m 50m



No.	W [mm]	L [m]	<input type="checkbox"/>
75270	19	25	12/48
75271	25	25	9/36
75272	30	25	10/40
75273	38	25	6/24
75274	48	25	6/24
75285	25	50	9/36
75286	30	50	10/40
75287	38	50	6/24
75288	48	50	6/24

EN Plastering tape
 PL Taśma tynkarska elewacyjna
 DE Putzband
 RU Штукатурные лента
 CZ Fasádní omítková páska
 RO Banda mascare pt. tencuieli
 HU Homlokzati festő szalag
 ES Cinta de enlucido de fachada

20m 50m



No.	W [mm]	L [m]	<input type="checkbox"/>
75130	38	20	24
75131	48	20	24
75132	38	50	28
75133	48	50	24

EN Packing tape, brown
 PL Taśma pakowa brązowa
 DE Verpackungsband aus PP, braun
 RU Упаковочная клейкая лента
 CZ Balící páska PP hnědá
 RO Bandă ambalare PP maro
 HU PP barna ragasztószalag
 ES Cinta de embalaje marrón

OPP



No.	W [mm]	L [m]	<input type="checkbox"/>
75301	48	40	36
75302	48	66	36

EN Packing tape
 PL Taśma pakowa
 DE Band
 RU Упаковочная клейкая лента
 CZ Balící páska
 RO Banda scotch
 HU Csomagolószalag
 ES Cinta de embalaje

No.	W [mm]	L [m]	<input type="checkbox"/>
75300	48	45	12/36

EN Blue masking tape
 PL Taśma maskująca, niebieska
 DE Malerei blau Tape
 RU Малярна стрічка

CZ Maskovací páska
 RO Bandă de mascare
 HU Fedőszalag
 ES Cinta adhesiva azul

25m 50m



No.	W [mm]	L [m]	<input type="checkbox"/>
75120	30	25	40
75121	38	25	24
75122	48	25	24
75123	30	50	40
75124	38	50	24
75125	48	50	24

EN „DUCT” tape
 PL Taśma tekstylna „DUCT”
 DE Textilband „DUCT”
 RU Лента армированная на тканевой основе
 CZ Textilní páska „DUCT”
 RO Bandă textilă „DUCT”
 HU „DUCT” textil szalag
 ES Cinta textil „DUCT”

DUCT



No.	W [mm]	L [m]	<input type="checkbox"/>
75238	48	10	24
75239	38	50	28
75240	48	50	24

EN Packing tape, transparent
 PL Taśma pakowa przezroczysta
 DE Verpackungsband aus PP, durchsichtig
 RU Упаковочная клейкая лента

CZ Balící páska PP průhledná
 RO Bandă ambalare PP transparentă
 HU Átlátszó ragasztószalag
 ES Cinta de embalaje transparente

OPP



No.	W [mm]	L [m]	<input type="checkbox"/>
75303	48	40	36
75304	48	66	36



EN Bucket
PL Wiadro
DE Eimer
RU Ведро
CZ Vědro
RO Galeată
HU Vödör
ES Cubo



VOREL

No.	Capacity / Pojemność [l]	
06388	10	900
06390	12	680
06383	13	800
06393	16	450
06392	20	390
06384	21	400

EN Painting bucket
PL Wiadro malarskie
DE Malereimer
RU Ведро малярное
CZ Vědro malířské
RO Galeată pt. vopsea
HU Festövödör
ES Cubo para pintar



VOREL

No.	Capacity / Pojemność [l]	Dimensions / Wymiary [mm]	
09400	14	360x250x225	315

EN Mortar mixing tub
PL Kastrą budowlana
DE Mörtelkübel
RU Кювета строительная

CZ Zednická nádoba
RO Vas construcții
HU Malteres láda
ES Cubeta de mortero



VOREL

No.	Capacity / Pojemność [l]	
06394	40	210
06395	60	210
06396	90	120

EN Flexible tub
PL Pojemnik elastyczny
DE Flexibler Korbeimer
RU Контейнер эластичный

CZ Elastické vědro
RO Galeata flexibila
HU Rugalmas dézsa
ES Espuerta flexible

VOREL

No.	Capacity / Pojemność [l]	
35580	27	600
35581	42	520
35582	55	190

EN Bucket
PL Wiadro
DE Eimer
RU Ведро
CZ Vědro
RO Galeată
HU Vödör
ES Cubo



VOREL

No.	Capacity / Pojemność [l]	
06391	12	720
06381	16	500
06382	20	500

EN Mortar mixing tub
PL Kastrą budowlana
DE Mörtelkübel
RU Кювета строительная
CZ Zednická nádoba
RO Vas construcții
HU Malteres láda
ES Cubeta de mortero



VOREL

No.	Capacity / Pojemność [l]	
06397	40	110
06398	65	100
06399	90	160

EN Construction and garden bucket
PL Kubel budowlano-ogrodowy
DE Bau- und Gartenbehälter
RU Строительный и садовый контейнер

CZ Stavební a zahradní nádoba
RO Galeata pt. gradina si constructii
HU Építőipari és kertí vödör
ES Espuerta para obra y jardín



40 L

PP



VOREL

No.	Capacity / Pojemność [l]	
06338	40	150



EN Suction lifter
 PL Uchwyt-przyssawka do szyby
 DE Glassauger
 RU Стеклодомкрат
 CZ Podtlakový držák na sklo
 RO Ventuză
 HU Vákuumos üvegfogó tappancs
 ES Elevador de ventosa



No.	Ø [mm]	Max. lifting capacity / Maks. udźwig [kg]	
05300	115	40	48

EN Suction lifter
 PL Uchwyt-przyssawka do szyby
 DE Glassauger
 RU Стеклодомкрат
 CZ Podtlakový držák na sklo
 RO Ventuză
 HU Vákuumos üvegfogó tappancs
 ES Elevador de ventosa



No.	Ø [mm]	Max. lifting capacity / Maks. udźwig [kg]	
05302	115	100	12

EN Suction lifter
 PL Uchwyt-przyssawka do szyby
 DE Glassauger
 RU Стеклодомкрат
 CZ Podtlakový držák na sklo
 RO Ventuză
 HU Vákuumos üvegfogó tappancs
 ES Elevador de ventosa



No.	Ø [mm]	Max. lifting capacity / Maks. udźwig [kg]	
05312	115	70	10

EN Pump suction cup
 PL Przyssawka z pompką próżniową
 DE Saugheber mit Vakuumpumpe
 RU Присоска вакуумная
 CZ Vakuový držák
 RO Ventuză cu pompă
 HU Vákuumos tapadókorong
 ES Ventosa con bomba de vacío



No.	Ø [mm]	Max. lifting capacity / Maks. udźwig [kg]	
05325	204	100	10

EN Suction lifter
 PL Uchwyt-przyssawka do szyby
 DE Glassauger
 RU Стеклодомкрат
 CZ Podtlakový držák na sklo
 RO Ventuză
 HU Vákuumos üvegfogó tappancs
 ES Elevador de ventosa

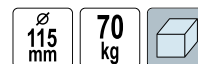

No.	Ø [mm]	Max. lifting capacity / Maks. udźwig [kg]	
05301	115	70	24

EN Suction lifter
 PL Uchwyt-przyssawka do szyby
 DE Glassauger
 RU Стеклодомкрат
 CZ Podtlakový držák na sklo
 RO Ventuză
 HU Vákuumos üvegfogó tappancs
 ES Elevador de ventosa



No.	Ø [mm]	Max. lifting capacity / Maks. udźwig [kg]	
05311	115	40	50

EN Pump suction cup
 PL Przyssawka z pompką próżniową
 DE Saugheber mit Vakuumpumpe
 RU Присоска вакуумная
 CZ Vakuový držák
 RO Ventuză cu pompă
 HU Vákuumos tapadókorong
 ES Ventosa con bomba de vacío

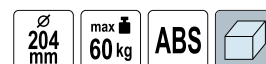

No.	Ø [mm]	Max. lifting capacity / Maks. udźwig [kg]	
05319	204	60	10



EN Hook
 PL Hak budowlany
 DE Mauerhaken
 RU Крюк строительный
 CZ Stavební hák
 RO Cârlig pt. dreptar
 HU Építőipari horog
 ES Gancho de obra



JUCO

No.		
34950		25

EN Deep hole pencil with leads
 PL Ołówek do głębokich otworów z rysikami
 DE Tieflochmarker mit Ersatzminen
 RU Карандаш для глубоких отверстий со сменными стержнями
 CZ Tužka do hlubokých otvorů s náhradními náplněmi
 RO Creion cu mine pt. găuri adânci
 HU Mélylyuk jelölő hegyekkel
 ES Lápiz para orificios profundos con puntas de trazar



VOREL

No.		
09200		10/100

EN Wax refills for automatic pencil
 PL Zestaw rysików woskowych do markera
 DE Ersatzwachsmineinsatz für Marker
 RU Набор восковых стержней для маркера
 CZ Voskové náplně do automatické tužky
 RO Rezervă de ceară pt. creioane automat
 HU Tartalék hegy szett automata ceruzához
 ES Conjunto de rellenos de cera para marcador



VOREL

For 09204
 Dla 09204

No.	For / Dla	pcs / szt.	
09207	09204	10	10/100

EN Wire tying twister hook
 PL Klucz do wiązania drutu zbrojeniowego
 DE Rödeldraht-Drillkurbel
 RU Крючок для вязки арматуры
 CZ Radlovačka
 RO Dispozitiv pt. legat fier beton
 HU Huzalsodró
 ES Gancho para amarrar alambre



VOREL

No.	L [mm]	
49830	240	20

EN Carpenter's pencil
 PL Ołówek stolarski
 DE Zimmermannsbleistift
 RU Карандаш столярный
 CZ Tesařská tužka
 RO Creion de tâmplărie
 HU Asztalos ceruza
 ES Lápiz de carpintero

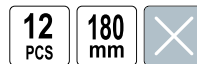

No.	L [mm]	pcs / szt.	
09180	180	12	60/240

EN Automatic wax pencil
 PL Marker woskowy automatyczny
 DE Automatischer Wachsmarker
 RU Маркер восковой автоматический
 CZ Automatická vosková tužka
 RO Creion tehnic cu ceară
 HU Automata viasz ceruza
 ES Marcador de cera automático

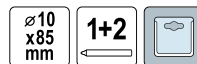

VOREL

No.		
09204		10/100

EN Carpenter's pencil sharpener
 PL Temperówka do ołówek stolarskich
 DE Zimmermann-Bleistift-Anspitzer
 RU Точилка для столярных карандашей
 CZ Ořezávkto na tesařskou tužku
 RO Ascuzitoare pt. creioane de tamplarie
 HU Ceruzahegyező
 ES Sacapuntas para lápiz de carpintero



VOREL

No.		
09190		40/240

EN Sheet metal bending machine
 PL Giętarka do blach
 DE Blechbiegemaschine
 RU Гибочный станок для листового металла
 CZ Ohýbačka plechu
 RO Mașină de îndoiti tablă
 HU Lemezhajlító gép
 ES Plegadora de chapa



VOREL

No.	Working width / Szerokość robocza [mm]	
49900	460	1

- EN Rebar bender
 PL Klucz do gięcia prętów
 DE Betonstahl-Bieger
 RU Ручной ключ для гибки арматуры
 CZ Klíč pro ohýbání tyčí
 RO Dispozitiv indoit fier beton
 HU Kézi betonacél hajlító
 ES Dobladora manual de barras

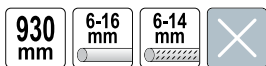

No.	L [mm]	
49810	930	4

- EN Rebar bender
 PL Giętarka do prętów
 DE Betonstahl-Bieger
 RU Станок для гибки арматуры
- CZ Ohýbačka tyčí
 RO Dispozitiv indoit sârmă
 HU Betonvas hajlító
 ES Dobladora de barras



11



No.	Ø [mm]	Dimensions / Wymiary [mm]	
49800	6-8	16x12x5	4
49801	10-12	25x16x6	4
49802	14-16	25x16x6	2

- EN Rod extractor
 PL Wyciągacz do prętów
 DE Stangenauszieher
 RU Ручной вытягиватель прутка
 CZ Vytahovač tyčí
 RO Extractor bare de armare
 HU Rúdkihúzó
 ES Extractor de varillas



No.	Rod diameter / Średnica pręta [mm]	
35007	8-28	6

- EN Rebar bender
 PL Giętarka do prętów
 DE Betonstahl-Bieger
 RU Станок для гибки арматуры
- CZ Ohýbačka tyčí
 RO Dispozitiv indoit sârmă
 HU Betonvas hajlító
 ES Dobladora de barras



No.	Ø [mm]	Dimensions / Wymiary [mm]	Bearing / Łożysko [mm]	
49805	6-8	17x17x5	35x15	2
49806	10-14	25x20x5	45x20	2

- EN Hand tamper
 PL Ubijak brukarski
 DE Pflasterstampfer
 RU Ручная трамбовка для уплотнения грунта
 CZ Pěchovadlo na pokládku dlažby
 RO Compactor manual
 HU Kézi döngölő
 ES Compactador manual de adoquines



No.	
35000	1

- EN Longitudinal clamp
 PL Chwytnik brukarski wzdlużny regulowany
 DE Bordstein-Verlegezange
 RU Захват-клещи для бордюра продольные
- CZ Kleště na obrubníky podélné
 RO Cleste pt. borduri
 HU Hosszirányúszegélykő emelő fogó
 ES Pinza de colocación de rebordes mecánica



No.	Grip range / Zakres chwytu [mm]	
35010	980-1170	2

EN Lateral clamp
PL Chwytnak poprzeczny, podwójny
DE Bordsteinverlegezange
RU Захват-клевши для бордюра поперечные

CZ Kleště na obrubníky příčné
RO Cleste pt. borduri
HU Keresztirányúszegegykő emelő fogó
ES Pavimentación pinza doble



VOREL

No.	Grip range / Zakres chwytu [mm]	
35012	90-360	2

EN Grapple for cobblestones
PL Chwytnak zbiorczy do kostki brukowej
DE Pflastersteinträger
RU Захват ручной для переноса бордюрного камня и блоков

CZ Nosič na cihly
RO Cleste pt. borduri
HU Emelő fogó
ES Pinza para bordillos longitudinal



VOREL

No.	Grip range / Zakres chwytu [mm]	
35015	700-1100	4

EN Brick tongs
PL Chwytnak do podnoszenia płyt lub cegieł
DE Greifer zum Heben von Platten oder Ziegeln
RU Захват для подъема плит или кирпича
CZ Nástroj pro přenášení desek a cihel
RO Cleste caramida
HU Csempé- és téglafogó
ES Pinzas para transportar placas o ladrillos

410-680
mm



VOREL

No.	Grip range / Zakres chwytu [mm]	
35018	410-680	3/12

EN Rubber for lateral clamp
PL Zapasowe końcówki do chwytnaka
DE Ersatzgummi für Bordsteinverlegezange
RU Запасные наконечники
CZ Náhradní gumový úchyt
RO Tamponae de cauciuc pt. dispozitiv montat pavaj
HU Gumi alkatrészek
ES Punta de repuesto

4
PCS



VOREL

No.	For / Dla	pcs / szt.	
35013	35012	4	10

EN Paving slab lifter
PL Chwytnak brukarski wysoki
DE Hoher Pflastergreifer
RU Захват для бордюра
CZ Držák na dlažební kostky
RO Dispozitiv pt. ridicat dale de pavaj
HU Magas térkőkiemelő
ES Pinza para adoquines alta



VOREL

No.	Grip range / Zakres chwytu [mm]	
35014	220-500	5

EN Slabgrabber
PL Chwytnak brukarski jednoręczny regulowany
DE Pflasterstein- und Klinker-Träger
RU Захваты для тротуарной плитки кирпича, блоков
CZ Kleště na dlažbu a cihly
RO Cleste pt. pavele
HU Burkolólap fogó
ES Pinza de colocación de losas



VOREL

No.	Grip range / Zakres chwytu [mm]	
35017	255-400	4

EN Paver puller
PL Imak brukarski regulowany
DE Steinzieger-Steinheber
RU Захват для камня

CZ Kleště na vytahování dlažby
RO Dispozitiv pt. manipulat pavele
HU Térkőkiemelő szerszám
ES Extractor de adoquines



VOREL

No.	Grip range / Zakres chwytu [mm]	
35020	80-275	4

EN Blades for paver puller
 PL Zapasowe ostrza do imaka
 DE Ersatzklingen für Steinzieher-Steinheber
 RU Запасные лезвия
 CZ Náhradní čepel
 RO Lama de rezervă pt. extractor pavaj
 HU Lama de rezerva
 ES Cuchillas de repuesto



No.	For / Dla	pcs / szt.	
35021	35020	2	20

EN Blade for paver adjuster
 PL Ostrze do formy brukarskiego
 DE Ersatzklingen für Richtleisen
 RU Запасные лезвия
 CZ Náhradní čepel
 RO Lama de rezerva
 HU Tartalék penge
 ES Cuchillas de repuesto



No.	For / Dla	
35026	35025	20

11

EN Paver lifter
 PL Zgarniacz brukarski do podsypki
 DE Plan-Abzieher für Pflasterbau
 RU Правило для выравнивания основания под тротуарную плитку
 CZ Stahovací lišta
 RO Dispozitiv pt. nivelare
 HU Ágyazat lehűző rendszer
 ES Sistema de enrasado manual

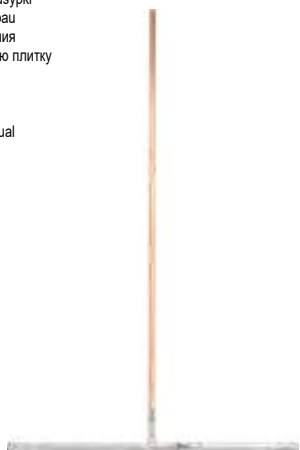

No.	L [cm]	
35033	75	1
35032	120	1

EN Garden paving stone mould
 PL Forma do kostki brukowej
 DE Pflasterform
 RU Форма для брусчатки
 CZ Forma pro dlažební kostky
 RO Șablon decorativ pt. pavaj
 HU Térkö-minta sablon
 ES Plantilla para adoquines



No.	Dimensions / Wymiary [mm]	
35060	430x425x40	10

EN Paver adjuster
 PL Łom wyważak brukarski
 DE Richtleisen für Pflasterbau
 RU Лом с упором для демонтажа тротуарной плитки
 CZ Tyč pro opravu dlažby
 RO Dispozitiv pt. aliniere pavaj
 HU Térkö-sorrendező
 ES Barra alineadora de adoquines



No.	
35025	4

EN Paver lifter
 PL Zgarniacz brukarski do podsypki
 DE Plan-Abzieher für Pflasterbau
 RU Правило для выравнивания основания под тротуарную плитку
 CZ Stahovací lišta
 RO Dispozitiv pt. nivelare
 HU Ágyazat lehűző rendszer
 ES Sistema de enrasado manual

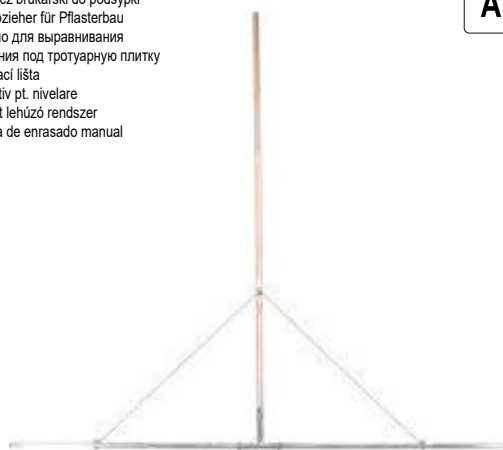

No.	L [cm]	
35031	150	1
35030	200	1

EN Garden paving stone mould
 PL Forma do kostki brukowej
 DE Pflasterform
 RU Форма для брусчатки

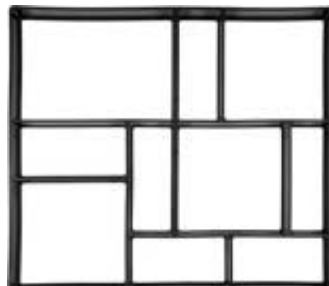

No.	Dimensions / Wymiary [mm]	
35061	450x400x40	10

EN Garden paving stone mould
 PL Forma do kostki brukowej
 DE Pflasterform
 RU Форма для брусчатки
 CZ Forma pro dlažební kostky
 RO Șablon decorativ pt. pavaj
 HU Térkő-minta sablon
 ES Plantilla para adoquines

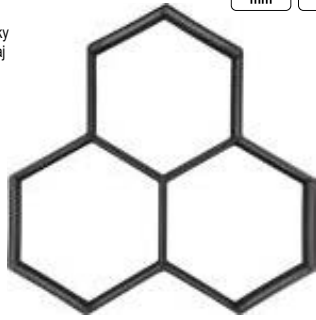

No.	Dimensions / Wymiary [mm]	
35062	360x360x40	10

EN Garden paving stone mould
 PL Forma do kostki brukowej
 DE Pflasterform
 RU Форма для брусчатки
 CZ Forma pro dlažební kostky
 RO Șablon decorativ pt. pavaj
 HU Térkő-minta sablon
 ES Plantilla para adoquines

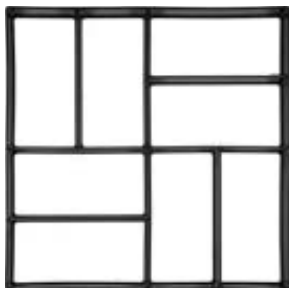

No.	Dimensions / Wymiary [mm]	
35064	400x400x40	10

EN Garden paving stone mould
 PL Forma do kostki brukowej
 DE Pflasterform
 RU Форма для брусчатки
 CZ Forma pro dlažební kostky
 RO Șablon decorativ pt. pavaj
 HU Térkő-minta sablon
 ES Plantilla para adoquines

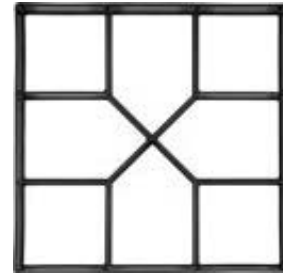

No.	Dimensions / Wymiary [mm]	
35063	400x400x40	10

EN Construction wheelbarrow
 PL Taczka budowlana
 DE Bauschubkarre
 RU Тачка строительная

CZ Stavební kolečko
 RO Roaba constructii
 HU Építési talicska
 ES Carretilla de obra



No.	Capacity / Pojemność [l]	Steel sheet thickness / Grubość blachy [mm]	
78690	80	1.2	10
78691	80	1.8	10

Memo

12

Measuring tools Narzędzia miernicze

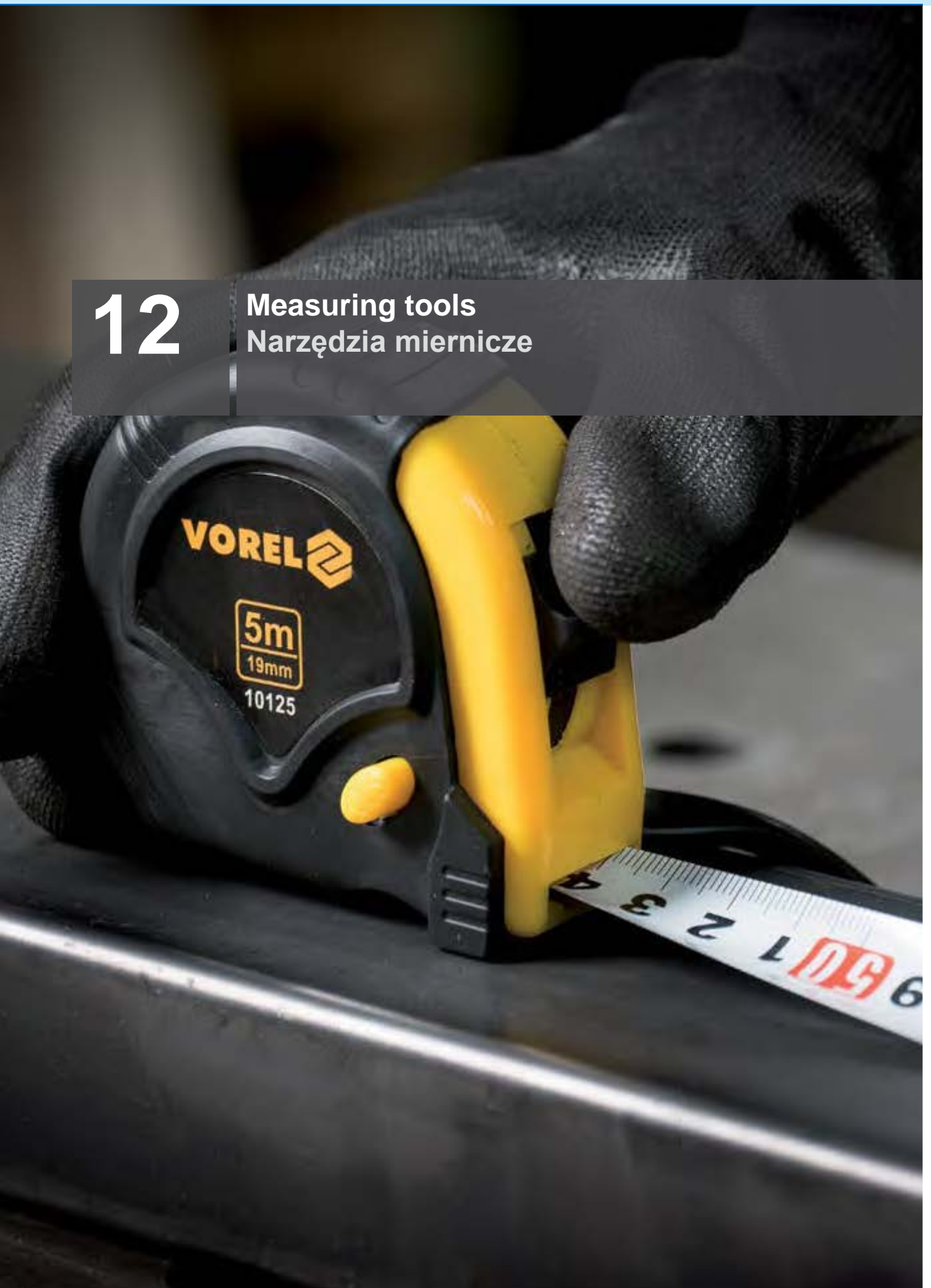

Measuring tapes
 Miary zwijane

.....190-191

Wooden folding rules
 Miary składane drewniane

.....191

Plastic folding rules
 Miary składane z tworzywa

.....191

Feeler gauges
 Szczelinomierze

.....191

Vernier calipers
 Suwmiarki

.....191-192

Chalk lines
 Sznury traserskie

.....192-193

Ropes
 Sznury

.....193-194

Plumb bobs
 Piony murarskie

.....194-195

Try squares
 Kątowniki stolarskie

.....195-197

Rulers
 Przymiary

.....198

Electronic measuring tools
 Elektroniczne urządzenia pomiarowe

.....198-201

Levels
 Poziomnice

.....201-202

Scales
 Wagi

.....202

Magnifiers
 Lupy

.....202-203



EN Measuring tape
 PL Miara zwijana
 DE Rollbandmass
 RU Рулетка
 CZ Měřicí pásmo
 RO Ruletă
 HU Mérőszalag
 ES Flexómetro



No.	L [m]	W [mm]	
10101	2.0	16	12/120
10104	3.0	16	12/120
10106	5.0	16	12/120
10109	7.5	19	6/60
10111	10.0	25	6/60

EN Measuring tape
 PL Miara zwijana
 DE Rollbandmass
 RU Рулетка
 CZ Měřicí pásmo
 RO Ruletă
 HU Mérőszalag
 ES Flexómetro



No.	L [m]	W [mm]	
10122	2.0	16	12/120
10123	3.0	16	12/120
10125	5.0	19	12/120
10128	7.5	25	6/60
10129	10.0	25	6/60

EN Steel measuring tape
 PL Taśma miernicza stalowa
 DE Rollbandmass
 RU Мерная лента стальная
 CZ Měřicí pásmo ocelové
 RO Ruleta din oțel
 HU Acél mérőszalag
 ES Cinta de medir de acero



No.	L [m]	W [mm]	
12100	10	10	25/50
12200	20	10	25/50
12300	30	10	10/30
12500	50	10	10/30

EN Measuring tape
 PL Miara zwijana
 DE Rollbandmass
 RU Рулетка
 CZ Měřicí pásmo
 RO Ruletă
 HU Mérőszalag
 ES Flexómetro



No.	L [m]	W [mm]	
10061	3.0	16	12/120
10062	5.0	19	12/120
10063	5.0	25	12/96
10064	7.5	25	6/72
10065	10.0	25	6/60

EN Measuring tape
 PL Miara zwijana
 DE Rollbandmass
 RU Рулетка
 CZ Měřicí pásmo
 RO Ruletă
 HU Mérőszalag
 ES Flexómetro



No.	L [m]	W [mm]	
10130	2.0	16	12/120
10133	3.0	16	12/120
10135	5.0	16	12/120
10138	8.0	25	6/60
10139	10.0	25	6/60

EN Steel measuring tape
 PL Taśma miernicza stalowa, geodezyjna
 DE Rollbandmass
 RU Мерная лента стальная геодезическая

CZ Měřicí pásmo ocelové
 RO Ruleta cu picior
 HU Acél mérőszalag
 ES Cinta de medir de acero geodezico



No.	L [m]	
13200	20	10/20
13300	30	10/20
13500	50	10/20

EN Fibreglass measuring tape
 PL Taśma miernicza z włókna szklanego
 DE Rollbandmass
 RU Мерная лента фиброглассовая

CZ Měřicí pásmo (skleněné vlákno)
 RO Ruleta fibra sticla
 HU Úvegszálal mérőszalag
 ES Cinta de medir de fibra de vidrio



No.	L [m]	Package	
14100	10		20/100
14200	20		12/60
14300	30		12/60
14500	50		10/30

EN Wooden folding rule
 PL Miara drewniana, składana, okuta
 DE Gliedermasstab
 RU Метр складной деревянный
 CZ Měřicí pásmo dřevěné skladané (okované)
 RO Metru tamplar lemn
 HU Összehajtható fa mérőlécc
 ES Metro de madera, plegable (articulado)



VOREL

No.	L [m]	Series / Seria	
15004	1	PERFECT B-Z	20/200
15006	2	PERFECT B-Z	10/100

EN Plastic folding rule
 PL Miara plastikowa
 DE Kunststoffgliedmasstab
 RU Метр складной пластмассовый
 CZ Měřicí pásmo plastové skladané
 RO Metru de plastic
 HU Műanyag, összecusukható mérce
 ES Metro de plástico, plegable



No.	L [m]	
15050	1	20/200
15070	2	12/120

EN Plastic caliper
 PL Suwmiarka plastikowa
 DE Kunststoff-Bremssattel
 RU Штангенциркуль пластиковый
 CZ Plastové posuvné měřtko
 RO Subler din plastic
 HU Műanyag tolomerő
 ES Calibre vernier regla, plástico



EN Wooden folding rule
 PL Miara drewniana, składana, okuta
 DE Gliedermasstab
 RU Метр складной деревянный

CZ Měřicí pásmo dřevěné skladané (okované)
 RO Metru tamplar lemn
 HU Összehajtható fa mérőlécc
 ES Metro de madera, plegable (articulado)



No.	L [m]	
15010	1	24/480
15020	2	12/240

EN Wooden folding rule
 PL Miara drewniana, składana, okuta
 DE Gliedermasstab
 RU Метр складной деревянный
 CZ Měřicí pásmo dřevěné skladané (okované)
 RO Metru tamplar lemn
 HU Összehajtható fa mérőlécc
 ES Metro de madera, plegable (articulado)



VOREL

No.	L [m]	Series / Seria	
15005	1	PERFECT B	20/200
15007	2	PERFECT B	10/100

EN Feeler
 PL Szczelinomierz
 DE Fühlerlehre
 RU Щупы
 CZ Spároměr
 RO Lere
 HU Hézagmérő
 ES Calibre de fisuras



VOREL

No.	Gauge thickness / Grubość listka [mm]	Gauge quantity / Liczba listków	
15130	0.05, 0.10, 0.15, 0.20, 0.25, 0.30, 0.40, 0.50, 0.60, 0.70, 0.80, 0.90, 1.0	13	15/300
15200	0.05, 0.10, 0.15, 0.20, 0.25, 0.30, 0.35, 0.40, 0.45, 0.50, 0.55, 0.60, 0.65, 0.70, 0.75, 0.80, 0.85, 0.90, 0.95, 1.0	20	10/200



VOREL

No.	Measuring range / Zakres pomiaru [mm]	Measurement accuracy / Dokładność pomiarowa [mm]	
15120	0-150	± 0.05	50/500

EN Vernier caliper
 PL Suwmiarka
 DE Messschieber
 RU Штангенциркуль
 CZ Posuvné měřítko
 RO Șubler
 HU Tolómérő
 ES Calibrador vernier

0-150 mm +/- 0.02 mm mm inch



No.	Measuring range / Zakres pomiaru [mm]	Measurement accuracy / Dokładność pomiarowa [mm]	Package
15115	0-150	± 0.02	10/100

EN Vernier caliper
 PL Suwmiarka
 DE Messschieber
 RU Штангенциркуль
 CZ Posuvné měřítko
 RO Șubler
 HU Tolómérő
 ES Calibrador vernier

0-150 mm



No.	Measuring range / Zakres pomiaru [mm]	Measurement accuracy / Dokładność pomiarowa [mm]	Package
15110	0-150	± 0.02	10/100
15100	0-150	± 0.05	10/100

EN Digital caliper
 PL Suwmiarka elektroniczna
 DE Digital Messschieber
 RU Электронный штангенциркуль
 CZ Posuvné měřítko elektronické
 RO Șubler electronic
 HU Elektronikus tolómérő
 ES Calibrador vernier digital

0-150 mm +/- 0.03 mm mm inch SS STAINLESS STEEL STAL NIERDZEWNA 1x SR44



No.	Measuring range / Zakres pomiaru [mm]	Measurement accuracy / Dokładność pomiarowa [mm]	Package
15240	0-150	± 0.03	10/40

EN Chalk line
 PL Sznur traserski
 DE Schnurlot
 RU Шнур-отвес малярный
 CZ Orýsovací šňůra
 RO Șnur de trasat
 HU Kicsapózsínor
 ES Cordel tizador

15m



No.	L [m]	Package
17500	15	10/100

EN Dial caliper
 PL Suwmiarka zegarowa
 DE Präzisions-Uhrmessschieber
 RU Штангенциркуль стрелочный
 CZ Posuvné měřítko hodinové
 RO Șubler cu cadran
 HU Órás tolómérő
 ES Calibre dial

0-150 mm +/- 0.02 mm mm inch



No.	Measuring range / Zakres pomiaru [mm]	Measurement accuracy / Dokładność pomiarowa [mm]	Package
15220	0-150	± 0.02	10/50

EN Carbon fibre vernier caliper
 PL Suwmiarka elektroniczna z włókna węglowego
 DE Elektronischer Messschieber aus Kohlefaser
 RU Электронный штангенциркуль из углеродного волокна
 CZ Elektronické posuvné měřidlo z uhlíkového vlákna
 RO Șubler din carbon
 HU Elektromos szénszálas tolómérő
 ES Calibrador vernier digital de fibra de carbono

0-150 mm +/- 0.2 mm mm inch

LCD CARBON FIBER WŁOKNO WĘGLOWE 1x LR44



No.	Measuring range / Zakres pomiaru [mm]	Measurement accuracy / Dokładność pomiarowa [mm]	Package
15113	0-150	± 0.2	25/100

Battery not included
 Baterii nie dołączono

EN Chalk line
 PL Sznur traserski
 DE Schnurlot
 RU Шнур-отвес малярный
 CZ Orýsovací šňůra
 RO Șnur de trasat
 HU Kicsapózsínor
 ES Cordel tizador

15m Al



No.	L [m]	Package
17501	15	10/100

EN Chalk line & blue chalk
 PL Sznur traserski z kredą niebieską
 DE Schlagschnur mit Kreide
 RU Шнур-отвес малярный + краска
 CZ Orýsovací šňůra
 RO Fir trasare si praf de creta albastra
 HU Kicsapozsínór
 ES Cordel tizador con tiza azul

15m 115g

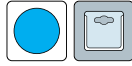

VOREL

No.	L [m]	m [g]	
17505	15	115	10/60

EN Blue/red chalk
 PL Kreda traserska
 DE Kreide blau/rot
 RU Краска для шнура
 CZ Křída trasovací
 RO Praf de creta pt. trasat
 HU Jelölő krétapör
 ES Tiza azul/rojo

115g



VOREL

No.	m [g]	Color / Kolor	
17507	115	niebieski	20/80
17508	115	czerwony	20/80

EN Builders line
 PL Sznurek murarski
 DE Maurerschnur
 RU Шнур - причалка
 CZ Šňůra zednická
 RO Sfoară pt. zidari
 HU Kőműves zsinór
 ES Cuerda de albañil

75m



PE



VOREL

No.	L [m]	
17495	75	12/48

EN Builders line
 PL Sznurek murarski
 DE Maurerschnur
 RU Шнур - причалка
 CZ Šňůra zednická
 RO Sfoară pt. zidari
 HU Kőműves zsinór
 ES Cuerda de albañil

200m 1.2mm

1.2mm

EASY ROLL-UP LATWIE ZWIJANIE

PP



VOREL

No.	Ø [mm]	L [m]	
17498	1.2	200	12/48

EN Chalk line
 PL Sznur traserski w pojemniku
 DE Schlagschnurroller
 RU Шнур для разметки в контейнере
 CZ Značkovací provázek v obalu
 RO Fir trasat cu creta
 HU Jelölőzsinór dobozban
 ES Tiralineas para marcar

30m ABS



SPEEDY RETRACTING SZYBKIE ZWIJANIE



VOREL

No.	L [m]	
17506	30	12/48

EN Builders line
 PL Sznurek murarski
 DE Maurerschnur
 RU Шнур - причалка
 CZ Šňůra zednická
 RO Sfoară pt. zidari
 HU Kőműves zsinór
 ES Cuerda de albañil

40m



No.	L [m]	
17490	40	80

EN Builders line
 PL Sznurek murarski
 DE Maurerschnur
 RU Шнур - причалка
 CZ Šňůra zednická
 RO Sfoară pt. zidari
 HU Kőműves zsinór
 ES Cuerda de albañil

75m 1.2mm

EASY ROLL-UP LATWIE ZWIJANIE

PP



VOREL

No.	Ø [mm]	L [m]	
17497	1.2	75	12/48

EN Builders line
 PL Sznurek murarski
 DE Maurerschnur
 RU Шнур - причалка
 CZ Šňůra zednická
 RO Sfoară pt. zidari
 HU Kőműves zsinór
 ES Cuerda de albañil



No.	L [m]	Color / Kolor	
17488	50	zółty	60
17489	100	zółty	60

EN Polypropylene bricklayer's string
 PL Sznurek murarski polipropylenowy
 DE Maurerschnur aus Polypropylen
 RU Шнур каменщика
 CZ Šňůra zednická polypropylenová
 RO Șnur de zidărie din polietilena
 HU Kőműves zsinór polipropilén
 ES Cordel de albañilería



VOREL

No.	Ø [mm]	L [m]	
17470	1.7	50	60/240
17471	1.7	100	30/120
17473	2.0	50	60/240
17474	2.0	100	30/120

EN Line blocks with brick lines
 PL Uchwyty kątowe do linki murarskiej
 DE Maurerschnur Spannklotze mit Richtschnur
 RU Строительные уголки для причального шнура
 CZ Stavební rožky pro zednické provázky
 RO Dispozitiv pt. aliniere caramizi
 HU Építési rudak falazott húrokhoz
 ES Pareja de angulares para cuerda de albañil acha

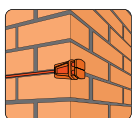

VOREL

No.	L [m]	
17430	18	48/96

EN Plumb bob
 PL Pion murarski
 DE Senklot
 RU Строительный отвес
 CZ Zednická olovnice
 RO Fir cu plumb
 HU Kőműves függőőn
 ES Plomada de albañil



VOREL

No.	Size / Rozmiar [mm]	
17300	15x70	100

EN Plumb bob
 PL Pion murarski
 DE Senklot
 RU Строительный отвес
 CZ Zednická olovnice
 RO Fir cu plumb
 HU Kőműves függőőn
 ES Plomada de albañil



VOREL

No.	Size / Rozmiar [mm]	L [m]	
17302	19x88	4.5	25/100

EN Polyethylene bricklayer's string
 PL Sznurek murarski polietylenowy
 DE Maurerschnur aus Polyäthylen
 RU Полиэтиленовый шнур каменщика
 CZ Šňůra zednická polyetylenová
 RO Șnur de zidărie din polietilena
 HU Kőműves zsinór poliétlén
 ES Cordel de albañilería de poliétileno



VOREL

No.	Ø [mm]	L [m]	
17480	1.7	50	60/240
17481	1.7	100	30/120
17483	2.0	50	60/240
17484	2.0	100	30/120

EN Steel pins for fixing masonry lines / hd line pin
 PL Szpilki murarskie stalowe
 DE Maurerstifte aus Stahl
 RU Стальные шпильки для кладки
 CZ Zednické hřebíky ocelové
 RO Cuie pt. fixare sfoara de trasat
 HU Falazósínör rögzítő szeg
 ES Pasadores de acero para mampostería



VOREL

No.	Ø [mm]	L	
17435	8	160 mm (szpilki), 10 m (linka)	10/40

EN Plumb bob
 PL Pion murarski
 DE Senklot
 RU Строительный отвес
 CZ Zednická olovnice
 RO Fir cu plumb
 HU Kőműves függőőn
 ES Plomada de albañil



VOREL

No.	Size / Rozmiar [mm]	L [m]	
17301	12x62	5	10/150

EN Plumb bob
 PL Pion murarski
 DE Senklot
 RU Строительный отвес
 CZ Zednická olovnice
 RO Fir cu plumb
 HU Kőműves függőőn
 ES Plomada de albañil



VOREL

No.	Size / Rozmiar [mm]	L [m]	
17303	22x115	6	10/60

EN Plumb bob
 PL Pion murarski
 DE Senklot
 RU Строительный отвес
 CZ Zednická olovnice
 RO Fir cu plumb
 HU Kőműves függőbón
 ES Plomada de albañil

4.5m 300g



No.	Size / Rozmiar [mm]	L [m]	
17304	27x88	4.5	9/36

EN Try square
 PL Kątownik stolarski
 DE Zimmermannswinkel
 RU Угольник столярный

CZ Truhlářský úhelník
 RO Echer de tâmplărie
 HU Asztalos derékszög
 ES Escuadra de metal



No.	L [mm]	
18250	250	12/120
18300	300	12/120
18350	350	12/120

EN Aluminium try square
 PL Kątownik aluminiowy
 DE Alu-Zimmermannswinkel
 RU Угольник столярный алюминиевый

CZ Truhlářský úhelník
 RO Echer de tâmplărie
 HU Asztalos derékszög
 ES Escuadra

45° 90°



No.	L [mm]	
18360	250	10/60
18361	300	10/60
18362	350	10/60

EN Try square set
 PL Zestaw kątowników metalowych ze stopką i libellą
 DE Metall-Anschlagwinkel-Set mit Fuß und Libelle
 RU Комплект металлических уголков с ножкой и пузырьком
 CZ Sada kovových úhelníků s nohou a vodováhou
 RO Set 3 echere
 HU Fém asztalos derékszög készlet talppal és libellával
 ES Juego de escuadras metálicas con pie y nivel



No.	L [mm]	
18390	150, 400, 700	25

EN Magnetic plumb bob
 PL Pion murarski magnetyczny
 DE Senklot mit Magnet
 RU Магнитный строительный отвес
 CZ Olovnice magnetická
 RO Fir cu plumb magnetic
 HU Fügőbón mágneses
 ES Plomada de albañil magnética

6m 400g



No.	L [m]	
17310	6	6/36

EN Try square
 PL Kątownik stolarski
 DE Zimmermannswinkel
 RU Угольник столярный

CZ Truhlářský úhelník
 RO Echer de tâmplărie
 HU Asztalos derékszög
 ES Escuadra de metal



No.	Size / Rozmiar [mm]	
18201	200x300	24/48
18200	400x600	12/24

EN Try square
 PL Kątownik metalowy ze stopką i libellą
 DE Metall-Anschlagwinkel mit Fuß und Libelle
 RU Металлический угольник с опорой и ампулой
 CZ Kovový úhelník s nohou a vodováhou
 RO Echer
 HU Fém asztalos derékszög talppal és libellával
 ES Escuadra metálica con pie y nivel

mm inch 90° x1



No.	L [mm]	
18380	150	10/60
18382	700	10/60

3 PCS 150 mm 400 mm

700 mm mm inch 90°



EN Angle bar with a support
 PL Kątownik z podpórką
 DE Winkel mit Stütze
 RU Угольник столярный с откидным упором

CZ Úhelník s dorazem
 RO Echer tâmplărie cu tablă
 HU Támaszos derékszögelő
 ES Escuadra con soporte



No.	L [mm]	
18501	350	30
18502	500	30
18503	750	20
18504	1000	10

EN Aluminium try square
 PL Kątownik aluminiowy
 DE Alu-Zimmermannswinkel
 RU Угольник столярный алюминиевый
 CZ Truhlářský úhelník
 RO Echer reglabil
 HU Asztalos derékszög
 ES Escuadra de aluminio



No.	Size / Rozmiar [mm]	
18374	600x320	6/12
18375	1200x600	6/12

EN Bevel protractor
 PL Kątomierz nastawny
 DE Winkelmesser
 RU Угломер регулируемый со шкалой
 CZ Nastavitelný úhloměr
 RO Echer reglabil
 HU Állítható szögmérő
 ES Calibrador de biselas



No.	L [mm]	
18797	350	10
18798	500	10
18799	750	10

EN Aluminium try square
 PL Kątownik aluminiowy
 DE Alu-Zimmermannswinkel
 RU Угольник столярный алюминиевый
 CZ Truhlářský úhelník
 RO Echer de tâmplărie
 HU Asztalos derékszög
 ES Escuadra de aluminio



No.	Size / Rozmiar [mm]	
18370	600x390	2/10
18372	1200x390	2/10

EN Aluminium try square
 PL Kątownik aluminiowy
 DE Alu-Zimmermannswinkel
 RU Угольник столярный алюминиевый
 CZ Truhlářský úhelník
 RO Echer de tâmplărie
 HU Asztalos derékszög
 ES Escuadra de aluminio



No.	Size / Rozmiar [mm]	
18355	400x210	100
18356	600x210	60
18357	1000x210	60

EN Protractor with level
 PL Kątomierz z libelą i ruchomym ramieniem
 DE Winkelmesser
 RU Транспортир
 CZ Protractor
 RO Raportor cu braț mobil
 HU Szögmérő
 ES Transportador

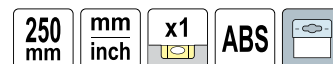

No.	L [mm]	Vials / Libelle	
18473	250	1	10/60

EN Protractor electronic with spirit level
 PL Kątomierz elektroniczny z poziomnicą
 DE Digital Winkelmesser mit Wasserwaage
 RU Транспортёр элeктронный с уровнем
 CZ Protractor electronic s urovní
 RO Raportor cu afişaj digital
 HU Szögmérő elektronikusak szint
 ES Con el nivel electrónico transportador

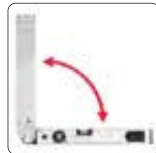

No.	L [mm]	Vials / Libelle	
17570	400	2	20

EN Bevel protractor
 PL Skośnica
 DE Schmiege
 RU Угольник
 CZ Nastavitelný úhloměr
 RO Echer
 HU Szögmásoló
 ES Falsa escuadra



No.	L [mm]	
18800	270	80
18810	400	60

EN Triangle ruler
 PL Kątownik ciesielski do krokwi
 DE Lineal Winkelmesser
 RU Угольник для плотника и столяра
 CZ Tesařský úhelník
 RO Echer pt. tâmplărie
 HU Fém derékszög
 ES Escuadra



No.	L [mm]	
18530	180	100

EN Multipurpose angle finder
 PL Kątomierz budowlany
 DE Bauwinkelmesser
 RU Строительный угомер
 CZ Stavební úhloměr
 RO Raportor multifuncțional
 HU Építési szögmérő
 ES Escuadra de construcción

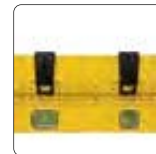
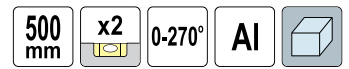

No.	L [mm]	Vials / Libelle	
18790	500	2	10

EN Adjustable ruler
 PL Kątownik nastawny do przenoszenia wymiarów
 DE Multifunktionales Messlineal
 RU Разметочный инструмент линейка-шаблон

CZ Pokosník nastavitelní
 RO Echer reglabil
 HU Szögmérőek
 ES Medición del ángulo



No.	
18470	20/60

EN Aluminium triangle ruler with foot
 PL Kątownik aluminiowy ze stopką
 DE Aluminiumwinkel mit Fuß
 RU Алюминиевый угольник с основанием
 CZ Hliníkový úhelník s patkou
 RO Echer aluminiu cu talpa
 HU Talpas alumínium derékszög
 ES Escuadra de aluminio con pie



No.	Dimensions / Wymiary [mm]	
18377	180x180x250	12/120

EN Carpenter's ruler
 PL Przymiar do tapet
 DE Zeichen-Masstab
 RU Линейка стальная с деревянной ручкой

CZ Měřidlo stavební
 RO Rigla de tamplarie
 HU Kőműves vonalzó
 ES Regla de obra



No.	L [mm]	
19750	750	10/40

EN Aluminium ruler, 2 vials
 PL Przymiar aluminiowy, uchwyt, 2 libelki
 DE Alu Zeichen-Masstab mit Griff und 2 Libellen
 RU Линейка алюминиевая 2 глазка с ручкой
 CZ Hliníkové pravítko s rukojetí a vodováhou
 RO Riglă aluminiu cu 2 bule
 HU Alumínium vonalzó, 2 buborék
 ES Regla de aluminio con mango y nivel

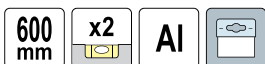

No.	L [mm]	Vials / Libelle	
19770	600	2	12/24

EN Laser distance meter
 PL Dalmierz laserowy
 DE Laserentfernungsmesser
 RU Лазерный дальномер
 CZ Laserový měřič vzdálenosti
 RO Telemetru cu laser
 HU Lézeres távolságmérő
 ES Medidor de distancia láser

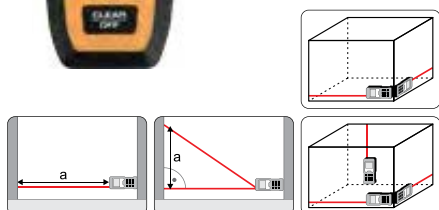

No.	
81791	10/50

EN Aluminium ruler, 2 vials
 PL Przymiar aluminiowy, uchwyt, 2 libelki
 DE Alu Zeichen-Masstab mit Griff und 2 Libellen
 RU Линейка алюминиевая 2 глазка с ручкой
 CZ Hliníkové pravítko s rukojetí a vodováhou
 RO Riglă aluminiu cu 2 bule
 HU Alumínium vonalzó, 2 buborék
 ES Regla de aluminio con mango y nivel

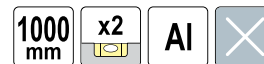

No.	L [mm]	Vials / Libelle	
19755	1000	2	24

EN Aluminium ruler
 PL Przymiar aluminiowy
 DE Alu Zeichen-Masstab
 RU Линейка алюминиевая
 CZ Hliníkové pravítko
 RO Riglă aluminiu
 HU Alumínium vonalzó
 ES Regla de aluminio



No.	Dimensions / Wymiary [mm]	
19763	150x28x1.8	20/120
19765	300x28x1.8	20/120
19766	600x28x1.8	20/120
19767	1000x28x1.8	10/100

EN Laser distance meter
 PL Dalmierz laserowy
 DE Laserentfernungsmesser
 RU Лазерный дальномер
 CZ Laserový měřič vzdálenosti
 RO Telemetru cu laser
 HU Lézeres távolságmérő
 ES Medidor de distancia láser

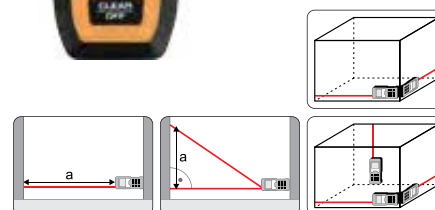
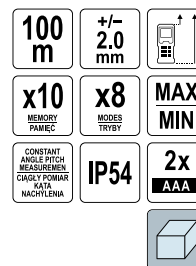

No.	
81795	10/50

EN Cross line green laser
 PL Laser krzyżowy zielony
 DE Grüne Kreuzlinien-Laser
 RU Лазерный уровень зеленый крест
 CZ Laser zelený křížový
 RO Nivelă cu laser verde
 HU Zöld keresztlézér
 ES Nivel láser verde en cruz



± 3.0 mm / 10 m LASER ACCURACY DOKŁADNOŚĆ LASERA	± 4° SELF-REGULATION SAMOREGULACJA	510-530 nm
1/4" (6.3 mm) TRIPOD THREAD GMAINT STĄTAWY	8h	°C - 10 + 50
≤ 1 mW	CLASS I KLASA I	IP54
3V	2x AA	



STHOR

No.		
18002		30

EN Aluminium tripod
 PL Statyw aluminiowy
 DE Aluminium-Stativ
 RU Алюминиевый штатив
 CZ Hliníkový stativ
 RO Trepid aluminiu
 HU Alumínium állvány
 ES Trípode de aluminio



1500 500 mm	AI	
----------------	----	--

VOREL

No.	H [mm]	
18020	500-1500	12

EN Metal and voltage detector
 PL Wykrywacz metalu i przewodów
 DE Ortungsgerät für Metal und Leitungen
 RU Детектор металла и токоведущих проводов
 CZ Detektor kovu a elektrických vodičů
 RO Detector cabluri și profile
 HU Fém- és feszültség detektor
 ES Detector de metalo y cables



2 in 1 2 w 1	METAL
LED LIGHT DIODE	
6h	
3x LR44	

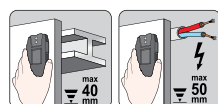

VOREL

No.		
81786		10/80

EN Aluminium tripod
 PL Statyw aluminiowy
 DE Aluminium-Stativ
 RU Алюминиевый штатив
 CZ Hliníkový stativ
 RO Trepid aluminiu
 HU Alumínium állvány
 ES Trípode de aluminio



500 250 mm	AI	
---------------	----	--

VOREL

No.	H [mm]	
18021	250-500	12

EN Laser mounting pole
 PL Tyczka do montażu lasera
 DE Laser Teleskopstange
 RU Штанга для лазерного уровня
 CZ Tyč pro montáž laseru
 RO Tijă telescopică pt. nivele laser
 HU Lézer teleszköprúd
 ES Barra para láser



max 3.6 m	AI	
-----------	----	--



VOREL

No.	H [m]	
18010	maks. 3.6	6

EN Metal and voltage detector
 PL Wykrywacz metalu i przewodów
 DE Ortungsgerät für Metal und Leitungen
 RU Детектор металла и токоведущих проводов
 CZ Detektor kovu a elektrických vodičů
 RO Detector cabluri și profile
 HU Fém- és feszültség detektor
 ES Detector de metalo y cables



3 in 1 3 w 1	STEEL STAL
WOOD DREWING	LCD
9 V G22	

VOREL

No.		
81785		20

- EN Hygrometer
- PL Higrometr
- DE Hygrometer
- RU Гигрометр
- CZ Hygrometr
- RO Higrometru
- HU Higrométer
- ES Higrómetro



1.5-33%	6-60%
±2% ACCURACY DOKŁADNOŚĆ	0-40 °C
LCD	2x AAA



No.	
81751	72

- EN Infrared thermometer
- PL Pirometr
- DE Pyrometer
- RU Пирометр
- CZ Pyrometr
- RO Termometru cu infrarosu
- HU Pirométer
- ES Pirómetro



°C -50 +380	1	MAX MIN
°C °F	LCD BACKLIGHT PODSWIETLENIE	
AUTO POWER OFF AUTOMATYCZNE WYŁĄCZANIE	2x AAA	



No.	
84400	20/80

- EN Digital lux meter
- PL Miernik natężenia światła
- DE Lichtstärkemesser
- RU Измеритель интенсивности света
- CZ Měřič intenzity světla
- RO Luxmetru digital
- HU Fényerősség mérő
- ES Luxómetro



0-200 klx	lx / fc
°C 9.9 +49.9	°C °F
MAX MIN	
REL RELATIVE VALUE WARTOŚĆ WZGLĘDNA	DATA RECORD ZAPIS DANYCH
DATA HOLD	LCD BACKLIGHT PODSWIETLENIE
1/4" (6.3 mm) TRIPOD THREAD GWINT STĄTOWY	AUTO POWER OFF AUTOMATYCZNE WYŁĄCZANIE
3x AAA	



No.	
81713	10/60

- EN Battery tester
- PL Tester baterii
- DE Batterietester
- RU Тестер заряда батареи
- CZ Tester baterii
- RO Tester baterii
- HU Elemeszteszter
- ES Comprobador de pilas



1.5 V	1.5 V	9 V	
-------	-------	-----	--



No.	
81700	25/100

- EN Digital sound level meter
- PL Miernik natężenia dźwięku
- DE Schallpegelmesser
- RU Измеритель интенсивности звука
- CZ Měřič intenzity zvuku
- RO Sonometru digital
- HU Hangerősség mérő
- ES Sonómetro



30-130 dBA	MAX MIN
DATA HOLD	>82 dBA
LCD BACKLIGHT PODSWIETLENIE	1/4" (6.3 mm) TRIPOD THREAD GWINT STĄTOWY
AUTO POWER OFF AUTOMATYCZNE WYŁĄCZANIE	3x AAA



No.	
81711	10/60

- EN Humidity and temperature meter
- PL Miernik wilgotności względnej i temperatury otoczenia
- DE Messgerät für relative Luftfeuchtigkeit und Temperatur
- RU Измеритель влажности и температуры
- CZ Měřič relativní vlhkosti a teploty okolí
- RO Termohigrometru
- HU Levegő hőmérséklet és páratartalom mérő műszer
- ES Termohigrometro



RH 0-100%	
°C -20 +70	°C °F
DEW POINT PUNKT ROSY	
WET BULB TEMPERATURE TEMPERATURA MOKROGO TERMOMETRU	MAX MIN
DATA RECORD ZAPIS DANYCH	DATA HOLD
LCD BACKLIGHT PODSWIETLENIE	1/4" (6.3 mm) TRIPOD THREAD GWINT STĄTOWY
AUTO POWER OFF AUTOMATYCZNE WYŁĄCZANIE	3x AAA



No.	
81716	10/60

EN Digital anemometer
 PL Miernik prędkości wiatru
 DE Windgeschwindigkeitsmesser
 RU Измеритель скорости ветра
 CZ Měřič rychlosti větru
 RO Anemometru digital
 HU Szélsebesség mérő
 ES Anemómetro



0~30 m/s	0~90 km/h	0~65 mph
0~5860 ft/min	0~55 knots	°C -10 +45
°C °F	MAX AVG	
BEAUFORT SCALE SKALA BEAUFORTA	DATA RECORD ZAPIS DANYCH	DATA HOLD
LCD BACKLIGHT PODSWETLENIE	1/4" (6.3 mm) TRIPOD THREAD GWINT STĄTYWY	AUTO POWER OFF AUTOMATYCZNE WYŁĄCZANIE
3x AAA		



No.		
81719		10/60

EN Torpedo level
 PL Poziomnica torpeda
 DE Torpedo-Wasserwaage
 RU Уровень торпедо

CZ Vodováha torpeda
 RO Nivelă Torpedo
 HU Vízmerék torpedó
 ES Nivel torpedo

230 mm	x3	0.027° 0.5 mm/m ACCURACY DOKŁADNOŚĆ



No.	L [mm]	Vials / Libelle	
16300	230	3	100

EN Post level
 PL Poziomnica do słupków
 DE Pfostenwasserwaage
 RU Уровни на должности
 CZ Hladiny do míst
 RO Nivelă pt. colțuri
 HU Szinték üzenete
 ES Los niveles a los mensajes

x3		ABS
----	--	-----



No.	Vials / Libelle	
16012	3	25/100

EN Trapezoidal spirit level
 PL Poziomnica trapezowa
 DE Trapezförmige Wasserwaage
 RU Трапецидальный уровень

CZ Vodováha trapezová
 RO Nivelă trapezoidală
 HU Vízmerék trapéz
 ES Trapezoides nivel

500 mm	x2
0.027° 0.5 mm/m ACCURACY DOKŁADNOŚĆ	



No.	L [mm]	Vials / Libelle	
16280	500	2	50

EN Torpedo level
 PL Poziomnica torpeda
 DE Torpedo-Wasserwaage
 RU Уровень торпедо

CZ Vodováha torpeda
 RO Nivelă Torpedo
 HU Vízmerék torpedó
 ES Nivel torpedo

230 mm	x3	0.027° 0.5 mm/m ACCURACY DOKŁADNOŚĆ



No.	L [mm]	Vials / Libelle	
16301	230	3	100

EN Aluminium level
 PL Poziomnica aluminiowa
 DE Alu-Wasserwaage
 RU Алюминиевый уровень
 CZ Hliníková vodováha
 RO Nivelă cu bulă din aluminiu
 HU Alumínium vízmerék
 ES Nivel de burbuja de aluminio

x3	AI	
----	----	--



No.	L [mm]	Vials / Libelle	
16340	400	3	20/60
16360	600	3	20/60
16380	800	3	20/60
16400	1000	3	20/60

EN Aluminium level
 PL Poziomnica aluminiowa
 DE Alu-Wasserwaage
 RU Алюминиевый уровень
 CZ Hliníková vodováha
 RO Nivelă cu bulă din aluminiu
 HU Alumínium vízmérték
 ES Nivel de burbuja de aluminio



VOREL

No.	L [mm]	Vials / Libelle	
16551	400	3	25/50
16552	600	3	25/50
16553	800	3	25/50
16554	1000	3	25/50
16555	1200	3	15/30
16556	1500	3	15/30
16557	2000	3	10/20

EN Water level
 PL Poziomnica wodna
 DE Schlauchwaage
 RU Гидроуровень
 CZ Vodováha vodní
 RO Furtun de nivel
 HU Slag vízmérték
 ES Nivel de agua



VOREL

No.	L [cm]	Ø [mm]	
16000	15	10	15
16001	20	10	15
16002	25	10	15

EN Spring weight measurer
 PL Waga sprężynowa z miarką zwijaną
 DE Federwaage
 RU Ручные пружинные весы
 CZ Váha pefová
 RO Cântar de mână
 HU Akasztós mérleg
 ES Balanza de resorte

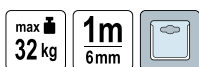

VOREL

No.	Max. load capacity / Maks. obciążenie [kg]	
15301	32	36

EN Aluminium level
 PL Poziomnica aluminiowa
 DE Alu-Wasserwaage
 RU Алюминиевый уровень
 CZ Hliníková vodováha
 RO Nivelă cu bulă din aluminiu
 HU Alumínium vízmérték
 ES Nivel de burbuja de aluminio



VOREL

No.	L [mm]	Vials / Libelle	
17606	600	3	20/60
17608	800	3	20/60
17610	1000	3	20/60
17612	1200	3	15/30
17615	1500	3	15/30
17620	2000	3	10/20

EN Spring weight measurer
 PL Waga sprężynowa
 DE Federwaage
 RU Ручные пружинные весы
 CZ Váha pefová
 RO Cântar de mână
 HU Akasztós mérleg
 ES Balanza de resorte



VOREL

No.	Max. load capacity / Maks. obciążenie [kg]	
15291	25	72
15292	50	48

EN Head magnifier
 PL Lupa z opaską na głowę
 DE Lupe mit Stirband
 RU Лупа биноклярная наголовная
 CZ Lupa s hlavou
 RO Lupă cu bandă
 HU Fejpántos nagyító szett
 ES Lupa con cabeza



VOREL

No.	
73503	6/24

EN Magnifier
PL Szkló powiększające
DE Vergrößerungsglas
RU Увеличительное стекло
CZ Lupa
RO Lupă
HU Nagyító üveg
ES Lupa de mano



No.



73490

40/480

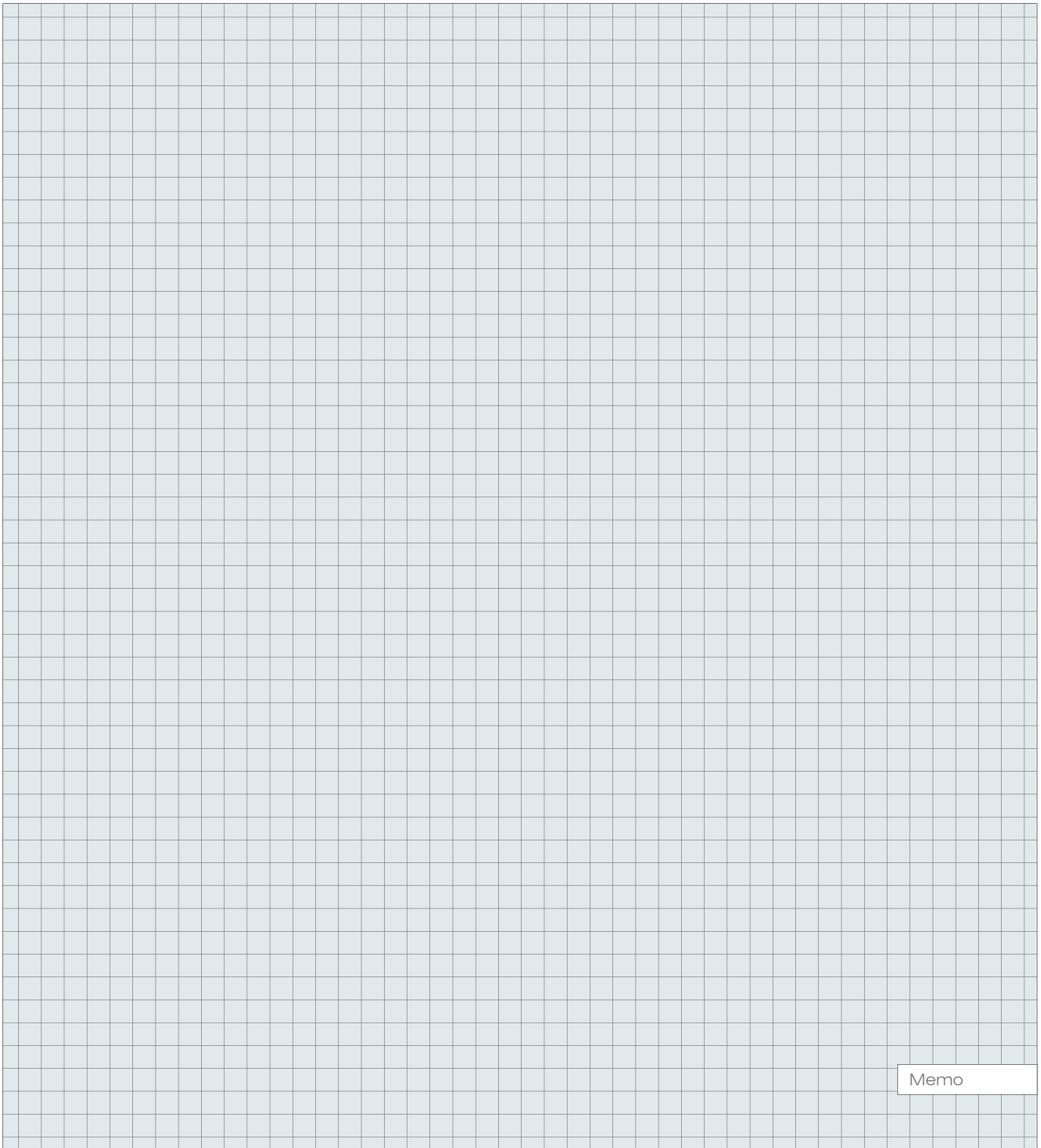

Memo

13

Pneumatic tools Narzędzia pneumatyczne



Air tools
Narzędzia pneumatyczne

206-208

Impact wrenches

Klucze udarowe..... 206

Pneumatic grinders

Szlifierki pneumatyczne..... 206

Pneumatic ratchets

Grzechotki pneumatyczne..... 207

Pneumatic hammers

Młotki pneumatyczne..... 208

Multi-purpose air tools

Wielofunkcyjne narzędzia pneumatyczne..... 208

Tire inflating guns & heads
Pistolety do pompowania kół
i głowice

208-209

Pneumatic painting equipment
Narzędzia do malowania

209-211

Spray guns

Pistolety lakiernicze..... 209

Blow guns

Pistolety do przedmuchiwania..... 210

Washing guns

Pistolety do ropowania..... 211

Pneumatic accessories
Akcesoria instalacji
pneumatycznej

211-213

Air filters, regulators & lubricators

Filtry, reduktory i smarownice..... 211

Spiral hoses

Węże spiralne..... 212

Reinforced hoses

Węże zbrojone..... 212

Couplers

Złącza..... 212

Air grease guns
Smarownice pneumatyczne

213

Pneumatic riveters
Nitownice pneumatyczne

213



- EN Impact wrench
- PL Klucz pneumatyczny
- DE Druckluft-Schlagschrauber
- RU Ударный пневматический гайковерт
- CZ Klíč pneumatický
- RO Pistol pneumatic
- HU Pneumatikus ütvecsavarozó
- ES Llave neumática de percusión

1/2" 12.7mm	0.63 MPa	0-7000 min ⁻¹	226 l/min
	340 Nm	STANDARD	



$L_{pa} = 92,6$ dB; $L_{wa} = 103,6$ dB; $a_h = 2,8$ m/s²

No.	Ø	Required air flow / Wymagany przepływ powietrza [l/min]	Max. torque / Maks. moment obrotowy [Nm]	
81100	1/2" (12.7 mm)	226	340	10

- EN Air grinder
- PL Szlifierka pneumatyczna prosta
- DE Drucklufteinhandschleifer
- RU Шлифмашина пневматическая
- CZ Bruska přímá pneumatická
- RO Polizor pneumatic
- HU Pneumatikus egyenescsiszoló
- ES Lijadora neumática recta

0.63 MPa	25000 min ⁻¹	100 l/min
6 mm	STANDARD	



$L_{pa} = 88,0 \pm 3,0$ dB; $L_{wa} = 99,0 \pm 3,0$ dB; $a_h = 2,9 \pm 1,5$ m/s²

No.	Toolholder size / Rozmiar uchwyty narzędziowego	Required air flow / Wymagany przepływ powietrza [l/min]	Ø [min ⁻¹]	
81107	1/4" (6.3 mm)	100	25000	20

- EN Air angle grinder
- PL Szlifierka pneumatyczna kątowa
- DE Ruckluft-Winkelschleifer
- RU Пневматическая угловая шлифовальная машина
- CZ Pneumatické úhlovou brusku
- RO Polizor unghiular pneumatic
- HU Pneumatikus sarokcsiszoló
- ES Amoladora angular neumática

0.63 MPa	0-20000 min ⁻¹	100 l/min
6 mm	STANDARD	



$L_{pa} = 90,1$ dB; $L_{wa} = 101,1$ dB; $a_h = 0,7$ m/s²

No.	Toolholder size / Rozmiar uchwyty narzędziowego	Required air flow / Wymagany przepływ powietrza [l/min]	Ø [min ⁻¹]	
81110	1/4" (6.3 mm)	100	0-20000	16

- EN Air impact kit
- PL Klucz pneumatyczny z nasadkami
- DE Druckluft-Schlagschrauber mit Kräfteinsätzen
- RU Гайковерт пневматический с набором головок
- CZ Klíč pneumatický s nástavci
- RO Pistol pneumatic cu accesorii
- HU Pneumatikus ütvecsavarozó készlet
- ES Llave neumático de percusión

16 PCS	1/2" 12.7mm	0.63 MPa	0-7000 min ⁻¹
226 l/min	340 Nm	CrV	STANDARD



$L_{pa} = 95,0 \pm 3,0$ dB; $L_{wa} = 106,0 \pm 3,0$ dB; $a_h = 9,1 \pm 1,5$ m/s²

No.	Ø	Required air flow / Wymagany przepływ powietrza [l/min]	Max. torque / Maks. moment obrotowy [Nm]	
81101	1/2" (12.7 mm)	226	340	5

- EN Air grinder
- PL Szlifierka pneumatyczna prosta
- DE Drucklufteinhandschleifer
- RU Шлифмашина пневматическая
- CZ Bruska přímá pneumatická
- RO Polizor pneumatic
- HU Pneumatikus egyenescsiszoló
- ES Lijadora neumática recta

0.63 MPa	0-22000 min ⁻¹	127 l/min
6 mm	STANDARD	



$L_{pa} = 82,8$ dB; $L_{wa} = 93,8$ dB; $a_h = 0,9$ m/s²

No.	Toolholder size / Rozmiar uchwyty narzędziowego	Required air flow / Wymagany przepływ powietrza [l/min]	Ø [min ⁻¹]	
81108	1/4" (6.3 mm)	127	0-22000	20

- EN Die grinder kit
- PL Szlifierka pneumatyczna prosta z akcesoriami
- DE Druckluft-Schrauber mit Schleifaufsätzen
- RU Прямая пневматическая шлифмашина и принадлежности
- CZ Bruska přímá pneumatická s příslušenstvím
- RO Masina de polizat pneumatica
- HU Pneumatikus köszőrű készlet
- ES Lijadora neumática recta

15 PCS	0.63 MPa	0-22000 min ⁻¹
127 l/min	3.6 mm	STANDARD



$L_{pa} = 88,0 \pm 3,0$ dB; $L_{wa} = 99,0 \pm 3,0$ dB; $a_h = 2,9 \pm 1,5$ m/s²

No.	Toolholder size / Rozmiar uchwyty narzędziowego	Required air flow / Wymagany przepływ powietrza [l/min]	Ø [min ⁻¹]	
81109	3 mm, 1/4" (6.3 mm)	127	0-22000	8

EN Air micro die grinder kit
 PL Zestaw pneumatyczny szlifierka mini
 DE Luft Sterben Schleifer Kit
 RU Пневмошлифмашина мини в наборе
 CZ Pneumatická bruska mini
 RO Freză pneumatică tip stilou
 HU Pneumatikus mini-csiszoló
 ES Amoladora biax recta neumatica

16 PCS **0.63** MPa **0-54000** min⁻¹ **3 mm**    



$L_{pa} = 79,0 \pm 3,0$ dB; $L_{wa} = 90,0 \pm 3,0$ dB; $a_n = <2,5$ m/s²

No.	Toolholder size / Rozmiar uchwyty narzędziowego [mm]	Ω [min ⁻¹]	
80970	3	0-54000	10



EN Disc for air sander
 PL Tarcza polerska do szlifierki pneumatycznej
 DE Stützteller für Druckluftexcenterschleifer
 RU Диск для эксцентриковой шлифмашины
 CZ Disk pro pneumatickou brusku
 RO Disc pt. polizoare pneumatice
 HU Csiszolókorong pneumatikus gépekhez
 ES Recambio disco lijadora orbital neumatica

150 mm **0-10000** min⁻¹ **M8** 



No.	\varnothing [mm]	Ω [min ⁻¹]	
81115	150	0-10000	10/100

EN Ratchet air wrench
 PL Grzechotka pneumatyczna
 DE Druckluft-Ratschenschrauber
 RU Пневмотрещотка
 CZ Pneumatická ráčna
 RO Antrenor pneumatic
 HU Préslevégős behajtó szerszám
 ES Carraca neumática



1/2" **0.63** MPa **0-160** min⁻¹ **141** l/min **68** Nm  



$L_{pa} = 91,0 \pm 3,0$ dB; $L_{wa} = 102,0 \pm 3,0$ dB; $a_n = 3,27 \pm 1,5$ m/s²

No.	\varnothing	Required air flow / Wymagany przepływ powietrza [l/min]	Max. torque / Maks. moment obrotowy [Nm]	
81118	1/2" (12.7 mm)	141	68	10

EN Air sander
 PL Szlifierka pneumatyczna mimośrodowa
 DE Druckluft- Excenterschleifer
 RU Экцентриковая шлифмашина
 CZ Bruska pneumatická
 RO Masina de slefuit pneumatica
 HU Pneumatikus sarokcsiszológép
 ES Lijadora neumática excéntrica



0.63 MPa **0-10000** min⁻¹ **113** l/min **150** mm **M8**  



$L_{pa} = 72,7$ dB; $L_{wa} = 83,7$ dB; $a_n = 1,44$ m/s²

No.	Disc diameter / Średnica tarczy [mm]	Ω [min ⁻¹]	
81114	150	0-10000	10

EN Ratchet air wrench
 PL Grzechotka pneumatyczna
 DE Druckluft-Ratschenschrauber
 RU Пневмотрещотка
 CZ Pneumatická ráčna
 RO Antrenor pneumatic
 HU Préslevégős behajtó szerszám
 ES Carraca neumática



1/2" **0.63** MPa **0-150** min⁻¹ **141** l/min **61** Nm  



$L_{pa} = 92,1$ dB; $L_{wa} = 103,1$ dB; $a_n = 0,8$ m/s²

No.	\varnothing	Required air flow / Wymagany przepływ powietrza [l/min]	Max. torque / Maks. moment obrotowy [Nm]	
81117	1/2" (12.7 mm)	141	61	10

EN Ratchet air wrench
 PL Grzechotka pneumatyczna
 DE Druckluft-Ratschenschrauber
 RU Пневмотрещотка
 CZ Pneumatická ráčna
 RO Antrenor pneumatic
 HU Préslevégős behajtó szerszám
 ES Carraca neumática

1/2" **0.63** MPa **0-160** min⁻¹ **113** l/min **69** Nm  



$L_{pa} = 94,0 \pm 3,0$ dB; $L_{wa} = 105,0 \pm 3,0$ dB; $a_n = 9,0 \pm 1,5$ m/s²

No.	\varnothing	Required air flow / Wymagany przepływ powietrza [l/min]	Max. torque / Maks. moment obrotowy [Nm]	
81119	1/2" (12.7 mm)	113	69	10

EN Air hammer
 PL Młotek pneumatyczny
 DE Druckluft-Schlaghammer
 RU Зубило пневматическое
 CZ Sekáč vzduchový
 RO Ciocan pneumatic
 HU Pneumatikus vésőgép
 ES Martillo neumático

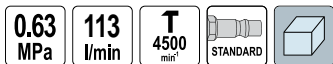

$L_{pA} = 85,0 \pm 3,0$ dB; $L_{wA} = 96,0 \pm 3,0$ dB; $a_n = 9,4 \pm 1,5$ m/s²

No.	Required air flow / Wymagany przepływ powietrza [l/min]	Box icon
81133	113	8

EN Pneumatic tool set
 PL Zestaw narzędzi pneumatycznych z akcesoriami
 DE Druckluftwerkzeugsatz mit Zubehör
 RU Пневматический ударный инструмент в наборе
 CZ Sada pneumatického nářadí
 RO Set scule și accesorii pneumatice
 HU Légszerszámok készlet
 ES Juego de herramientas neumáticas con accesorios



No.	Ø	Toolholder size / Rozmiar uchwyty narzędziowego	pcs / szt.	Box icon
81142	1/2" (12.7 mm)	1/4" (6.3 mm)	33	2

EN Inflating gun
 PL Pistolet do pompowania
 DE Inflatorpistole
 RU Пистолет для накачивания
 CZ Pistole na čerpání z manometrem
 RO Pistol cu manometru
 HU Pumpáló pisztoly nyomásmérővel
 ES Pistola de bombeo con manometro

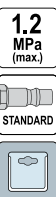

$L_{wA} = <70$ dB; $a_n = <2,5$ m/s²

No.	Box icon
81650	10/40

EN Multi-purpose oscillating air tool
 PL Wielofunkcyjne narzędzie oscylacyjne pneumatyczne
 DE Druckluft-Multifunktionswerkzeuge
 RU Пневматический многофункциональный инструмент
 CZ Pneumatická oscilační multifunkční bruska
 RO Unealtă oscilantă multifuncțională pneumatică
 HU Pneumatikus oszcilláló multifunkciós csiszoló
 ES Estuche herramienta neumática multifunción

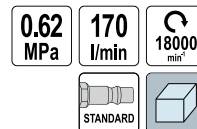

$L_{pA} = 87,5 \pm 3,0$ dB; $L_{wA} = 98,5 \pm 3,0$ dB; $a_n = 4,511 \pm 1,5$ m/s²

No.	Required air flow / Wymagany przepływ powietrza [l/min]	Ø [min"]	Box icon
81060	170	18000	10

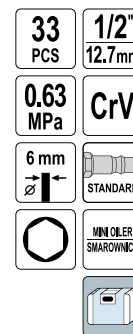

EN Inflating gun
 PL Pistolet do pompowania
 DE Inflatorpistole
 RU Пистолет для накачивания
 CZ Pistole na čerpání z manometrem
 RO Pistol cu manometru
 HU Pumpáló pisztoly nyomásmérővel
 ES Pistola de bombeo con manometro



$L_{pA} = 88,0 \pm 3,0$ dB; $L_{wA} = 99,0 \pm 3,0$ dB; $a_n = <2,5$ m/s²

No.	Box icon
81651	30

EN Inflating head
 PL Glowica do pompowania
 DE Klemmnippel (universal)
 RU Насадка на насос под шланг

CZ Hlava na čerpání
 RO Cap pt. pompă de umflat
 HU Pumpafej
 ES Cabeza de bombeo

1.2 MPa (max)

BRASS MOSIÁZS



No.	Connector diameter / Średnica króćca [mm]	
81653	8	50/300
81661	6	50/300

EN Spray gun with fluid cup
 PL Pistolet natryskowy
 DE Lackierpistole mit Fliessbecher
 RU Пистолет-распылитель с бачком
 CZ Pistolet na lakování z nádrží
 RO Pistol de vopsit cu rezervor
 HU Festékszóró pisztoly
 ES Pistola de barniz

1.4 mm 0.2-0.35 MPa

118-201 l/min 0.6 L

HVLP



$L_{PA} = 61,2 \text{ dB}$; $L_{WA} = 72,2 \text{ dB}$

No.	Nozzle diameter / Średnica dyszy [mm]	
80901	1.4	10

EN Spray gun with fluid cup
 PL Pistolet natryskowy
 DE Lackierpistole mit Fliessbecher
 RU Пистолет-распылитель с бачком
 CZ Pistolet na lakování z nádrží
 RO Pistol de vopsit cu rezervor
 HU Festékszóró pisztoly
 ES Pistola de barniz

1.8 mm 0.35 MPa

198 l/min 1000 ml

HVLP



$L_{PA} = 58,2 \text{ dB}$; $L_{WA} = 69,2 \text{ dB}$

No.	Nozzle diameter / Średnica dyszy [mm]	
80902	1.4	10

EN Spray gun with fluid cup
 PL Pistolet natryskowy
 DE Lackierpistole mit Fliessbecher
 RU Краскораспылитель верхний бак
 CZ Pistolet na lakování z nádrží
 RO Pistol de vopsit cu rezervor
 HU Festőpisztoly alsó tartállyal
 ES Pistola de barniz

1.5 mm 0.4 MPa

450 l/min 1000 ml

STANDARD



$L_{PA} = 85,0 \pm 2,5 \text{ dB}$; $L_{WA} = 98,9 \pm 2,5 \text{ dB}$

No.	Nozzle diameter / Średnica dyszy [mm]	
80903	1.8	10

EN Spray gun with fluid cup
 PL Pistolet natryskowy
 DE Lackierpistole mit Fliessbecher
 RU Краскораспылитель верхний бак
 CZ Pistolet na lakování z nádrží
 RO Pistol de vopsit cu rezervor
 HU Festőpisztoly alsó tartállyal
 ES Pistola de barniz

1.5 mm 0.4 MPa

450 l/min 0.68L

STANDARD



$L_{WA} = <70 \text{ dB}$; $a_n = <2,5 \text{ m/s}^2$

No.	Nozzle diameter / Średnica dyszy [mm]	
81617	1.5	20



$L_{WA} = <70 \text{ dB}$; $a_n = <2,5 \text{ m/s}^2$

No.	Nozzle diameter / Średnica dyszy [mm]	
81618	1.5	20

- EN Spray gun kit
- PL Zestaw lakierniczy
- DE Lackierspritzsatz
- RU Набор покрасочный пневматический
- CZ Laková souprava
- RO Set pt. vopsit
- HU Részes fényezőkészlet
- ES Juego de barniz

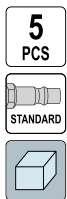
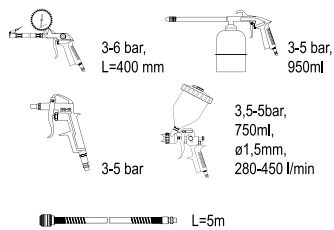

No.	pcs / szt.	
81638	5	10

- EN Blow gun
- PL Pistolet do przedmuchiwania
- DE Ausblaspistole
- RU Пистолет для продувки
- CZ Ofukovací pistole
- RO Pistol pt. suflat
- HU Lefűvő pisztoly
- ES Pistola de soplado

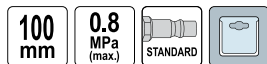

$L_{PA} = 91,0 \pm 3,0$ dB; $L_{WA} = 102,0 \pm 3,0$ dB; $a_n < 2,5$ m/s²

No.	Nozzle pipe length / Długość dyszy [mm]	
81631	100	10/40

- EN Blow gun
- PL Pistolet do przedmuchiwania
- DE Ausblaspistole
- RU Пистолет для продувки
- CZ Ofukovací pistole
- RO Pistol pt. suflat
- HU Lefűvő pisztoly
- ES Pistola de soplado

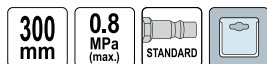

$L_{PA} = 91,0 \pm 3,0$ dB; $L_{WA} = 102,0 \pm 3,0$ dB; $a_n < 2,5$ m/s²

No.	Nozzle pipe length / Długość dyszy [mm]	
81633	300	10/40

- EN Blow gun
- PL Pistolet do przedmuchiwania
- DE Ausblaspistole
- RU Пистолет для продувки
- CZ Ofukovací pistole
- RO Pistol pt. suflat
- HU Lefűvő pisztoly
- ES Pistola de soplado

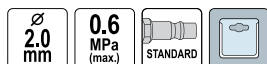

$L_{WA} < 70$ dB; $a_n < 2,5$ m/s²

No.		
81643		100

- EN Blow gun
- PL Pistolet do przedmuchiwania
- DE Ausblaspistole
- RU Пистолет для продувки
- CZ Ofukovací pistole
- RO Pistol pt. suflat
- HU Lefűvő pisztoly
- ES Pistola de soplado

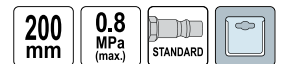

$L_{PA} = 91,0 \pm 3,0$ dB; $L_{WA} = 102,0 \pm 3,0$ dB; $a_n < 2,5$ m/s²

No.	Nozzle pipe length / Długość dyszy [mm]	
81632	200	10/40

- EN Blow gun
- PL Pistolet do przedmuchiwania
- DE Ausblaspistole
- RU Пистолет для продувки
- CZ Ofukovací pistole
- RO Pistol pt. suflat
- HU Lefűvő pisztoly
- ES Pistola de soplado

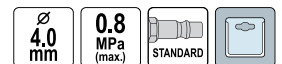

$L_{WA} < 70$ dB; $a_n < 2,5$ m/s²

No.		
81640		20/40

- EN Blow gun with extension
- PL Pistolet do przedmuchiwania z przedłużką
- DE Ausblaspistole mit Verlängerung
- RU Пистолет для продувки с удлинителем
- CZ Ofukovací pistole s nástavcem
- RO Pistol pt. suflat cu extensie
- HU Lefűvő pisztoly hosszú toldattal
- ES Pistola de soplado con extensión

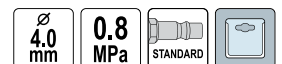

$L_{WA} < 70$ dB; $a_n < 2,5$ m/s²

No.		
81644		20/40

EN Air blow gun kit
 PL Zestaw do przedmuchiwania
 DE Druckluft-Ausblaspistole Satz
 RU Набор для продувки
 CZ Ofukovací pistole sada
 RO Pistol pt. suflat cu furturn
 HU Fuvató pisztoly szett
 ES Juego de pistola de aire



3
PCS

PE

$L_{pa} = 90,0 \text{ dB}$; $L_{wa} = 101,0 \text{ dB}$; $a_n = <2,5 \text{ m/s}^2$



No.		
81634		10/20

EN Filter
 PL Filtr
 DE Filter
 RU Минифильтр
 CZ Filtr
 RO Minifiltru
 HU Szűrő
 ES Filtro



G 1/4
BSPT



No.	Thread size / Rozmiar gwintu	
81560	G1/4	10/50

EN Pressure reducing valve with manometer
 PL Reduktor ciśnienia z manometrem
 DE Druckminderer mit Manometer
 RU Клапан уменьшения давления с манометром
 CZ Redukční ventil s manometrem
 RO Valvă reducere presiune cu manometru
 HU Nyomáscsökkentő szelep nyomásmérővel
 ES Reductor + manometro



3/8"
9.5 mm

0-1.2
MPa



No.	Thread size / Rozmiar gwintu	
81562	G3/8	50

EN Air filter, regulator and lubricator
 PL Zespół filtrujący, reduktor i smarownica
 DE Druckluft-Filterregler mit Öler
 RU Фильтр-влажгодделитель с редуктором и лубрикаторм
 CZ Redukční ventil s filtrem a maznicí
 RO Filtru cu reduktor și rezervor de ulei
 HU Szűrő, nyomá szabályzó, olajzó
 ES Filtro de aire, regulador y lubricador



No.	Thread size / Rozmiar gwintu	
81556	G1/2	20

EN Air washing gun
 PL Pistolet do ropowania
 DE Druckluft-Sprühpistole
 RU Пистолет для нефтывания
 CZ Pistole na ropování
 RO Pistol pt. spălat
 HU Olajzó pisztoly
 ES Pistola de petrolear



0.8
MPa

0.95L

STANDARD



No.		
81647		10/20

EN In-line air tool oiler
 PL Naolejacz do narzędzi pneumatycznych
 DE Öl für Druckluftwerkzeuge
 RU Масленка для пневматического инструмента
 CZ Olejníčka do pneumatických nářadí
 RO Gresor scule pneumatice
 HU Pneumatikus szerszám olajozó
 ES Lubricador para herramientas neumáticas



G 1/4
BSPT

0.8
MPa
(max.)

5
ml



No.		
81570		20/100

EN Air filter and regulator
 PL Filtr z reduktorem
 DE Druckluft-Filterregler
 RU Фильтр-влажгодделитель с редуктором
 CZ Redukční ventil s filtrem
 RO Filtru cu reduktor
 HU Szűrő-nyomá szabályzó
 ES Filtro y regulador de aire



1/2"
12.7 mm

0-0.1
MPa

PC

°C -10
+60



No.	Thread size / Rozmiar gwintu	
81553	G1/2	20



1/2"
12.7 mm

0-1
MPa

PC

°C -10
+60

EN Spiral hose with quick couplers
 PL Wąż spiralny z szybkozłączami
 DE Spiralschlauch mit Schnellkupplung
 RU Шланг спиральный с быстроразъемными соединениями
 CZ Spirálová vzduchová hadice s rychlospojkami
 RO Furtun spiralat cu cuple rapide
 HU Spiráltömlő gyorscsatlakozós
 ES Manguera espiral con conectores rápidos



No.	Internal diameter / Średnica wewnętrzna [mm]	External diameter / Średnica zewnętrzna [mm]	L [m]	
81490	5	8	5	50
81491	5	8	10	25
81492	5	8	15	25

EN Reinforced hose
 PL Wąż zbrojony
 DE Verstärkter Schlauch
 RU Шланг армированный

CZ Hadice vyztužená
 RO Furtun tehnic
 HU Megerősített tömlő
 ES Manguera armada



No.	Internal diameter / Średnica wewnętrzna [mm]	L [m]	Wall thickness / Grubość ścianki [mm]	ATM	
81519	6	50	2.5	10/40	1
81520	8	50	2.5	10/40	1
81521	10	50	2.5	10/40	1
81522	12	50	2.5	10/40	1
81523	14	50	3.0	10/40	1
81524	16	50	3.0	10/40	1
81525	19	50	3.5	10/40	1
81527	25	50	4.0	10/40	1

EN Spiral hose with quick couplers
 PL Wąż spiralny z szybkozłączami
 DE Spiralschlauch mit Schnellkupplung
 RU Шланг спиральный с быстроразъемными соединениями
 CZ Spirálová vzduchová hadice s rychlospojkami
 RO Furtun spiralat cu cuple rapide
 HU Spiráltömlő gyorscsatlakozós
 ES Manguera espiral con conectores rápidos

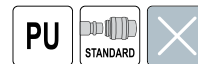

No.	Internal diameter / Średnica wewnętrzna [mm]	External diameter / Średnica zewnętrzna [mm]	L [m]	
81500	5	8	5	50
81501	5	8	10	25
81502	5	8	15	25



13

EN Quick coupler
 PL Szybkozłącze
 DE Schnellkupplung
 RU Быстрое соединение
 CZ Rychlospojka
 RO Mufă rapidă pt. aer comprimat
 HU Gyorscsatlakozó
 ES Conexión de la entrada de aire

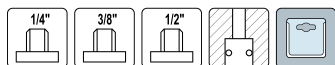

No.	Thread size / Rozmiar gwintu	
81370	G1/4	20/120
81371	G3/8	20/120
81372	G1/2	20/120

EN Quick coupler
 PL Szybkozłącze
 DE Schnellkupplung
 RU Быстрое соединение
 CZ Rychlospojka
 RO Mufă rapidă pt. aer comprimat
 HU Gyorscsatlakozó
 ES Conexión de la entrada de aire

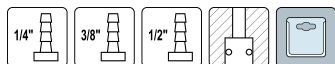

No.	Connector diameter / Średnica krócca [mm]	
81378	6	20/120
81379	8	20/120
81380	10	20/120

EN Quick coupler
 PL Szybkozłącze
 DE Schnellkupplung
 RU Быстрое соединение
 CZ Rychlospojka
 RO Mufă rapidă pt. aer comprimat
 HU Gyorscsatlakozó
 ES Conexión de la entrada de aire

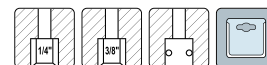

No.	Thread size / Rozmiar gwintu	
81373	G1/4	20/120
81374	G3/8	20/120

EN Quick coupler
 PL Szybkozłącze
 DE Schnellkupplung
 RU Быстрое соединение
 CZ Rychlospojka
 RO Mufă rapidă pt. aer comprimat
 HU Gyorscsatlakozó
 ES Conexión de la entrada de aire

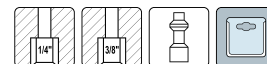

No.	Thread size / Rozmiar gwintu	
81390	G1/4	50/250
81391	G3/8	50/250

EN Quick coupler
 PL Szybkozłącze
 DE Schnellkupplung
 RU Быстрое соединение
 CZ Rychlospojka
 RO Mufă rapidă pt. aer comprimat
 HU Gyorscsatlakozó
 ES Conexión de la entrada de aire



No.	Thread size / Rozmiar gwintu	
81387	G1/4	50/250

EN Pneumatic grease injector
 PL Smarownica pneumatyczna
 DE Druckluft-Fettpresse
 RU Пневматический нагнетатель смазки
 CZ Pneumatické čerpadlo na maziva
 RO Pompă pneumatică pt. gresat
 HU Pneumatikus zsírító
 ES Bomba de engrase neumática lubricar



$L_{pa} = 81,34 \pm 3,0$ dB, $L_{ma} = 95,0 \pm 3,0$ dB

No.	l	
77990	12	1

EN Quick coupler
 PL Szybkozłącze
 DE Schnellkupplung
 RU Быстрое соединение
 CZ Rychlospojka
 RO Mufă rapidă pt. aer comprimat
 HU Gyorscsatlakozó
 ES Conexión de la entrada de aire

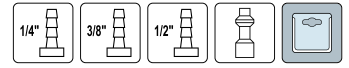

No.	Connector diameter / Średnica króćca [mm]	
81399	6	50/250
81400	8	50/250
81401	10	50/250

EN Pneumatic riveting machine
 PL Nitownica pneumatyczna
 DE Druckluft Nietzange
 RU Пневматический заклепочник
 CZ Pneumatická nýťovačka
 RO Presa pneumatică pt. nituit
 HU Pneumatikus popszegecshűző
 ES Máquina remachadora

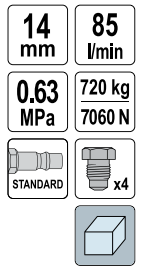

$L_{pa} = 76,1 \pm 3$ dB; $L_{ma} = 87,1 \pm 3$ dB; $a_n = 0,85 \pm 0,59$ m/s²

No.	Ø [mm]	Max. piston stroke / Maks. skok tłoka siłownika [mm]	F [kg]	F [N]	
70280	2,4, 3,2, 4, 4,8	14	720	7060	10

14

Special automotive tools & equipment Narzędzia i wyposażenie warsztatu samochodowego



Cabinets**Szafki**

216-221

Roller cabinets with tools insert

Szafki serwisowe z narzędziami..... 216

Tool cabinets

Szafki serwisowe..... 218

Workbenches & workshop desks

Stoły i biurka warsztatowe..... 220

Lubrication tools**Narzędzia do smarowania**

221-225

Grease guns & oil transfer pumps

Smarownice ręczne i pompy transferowe do oleju..... 221

Manual oil pumps

Pompy ręczne do oleju..... 223

Oil cans

Oliwiarki..... 224

Oil filter wrenches

Klucze do filtra oleju..... 224

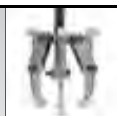
Pullers**Ściągacze**

226-227

Gear pullers

Ściągacze do łożysk..... 226

Spring pullers

Ściągacze do sprężyn..... 226

Ball joint removers

Ściągacze do sworzni kulistych..... 227

Workshop tools**Narzędzia warsztatowe**

227-234

Wheel wrenches

Klucze do kół..... 227

Piston ring compressors

Zaciskacze do pierścieni..... 228

Spark plug sockets

Klucze do świec..... 228

Vacuum pumps

Pompki podciśnieniowe..... 229

Brake system tools

Narzędzia do obsługi układu hamulcowego..... 229

Paint thickness & car voltage testers

Tester grubości lakieru i samochodowe próbniki napięcia..... 229

Magnetic pick up tools

Chwytaaki magnetyczne..... 230

Workshop seats

Taborety warsztatowe..... 230

Impact wrenches

Klucze udarowe..... 231

Bottle & floor jacks

Dźwigniki słupkowe i podnośniki..... 231

Scissors jacks

Podnośniki mechaniczne..... 232

Accessories for jacks

Akcesoria do podnośników..... 232

Jack stands

Podstawki pod samochód..... 232

Porta power kits

Rozpieraki hydrauliczne..... 232

Pull-back rams

Ściągacze blacharskie hydrauliczne..... 233

Battery chargers

Prostowniki..... 233

Battery testers

Testery akumulatorów..... 234

Tire pressure gauges

Mierniki ciśnienia..... 234

Chain blocks

Wciągarki łańcuchowe..... 234

Car accessories**Akcesoria samochodowe**

235-244

Air compressors

Kompresory..... 235

Bags

Worki..... 235

Air wedges

Poduszki montażowe..... 235

Tow ropes

Linki holownicze..... 236

Battery clamp cleaners

Szczotki do czyszczenia klem..... 237

Battery hydrometers

Próbniki akumulatorowe..... 237

Booster cables

Wiązki przewodów awaryjnych..... 237

Scrapers & brushes

Skrabaczki i szczotki..... 237

Flexible funnels

Lejki..... 238

Car vacuum cleaners

Odkurzacze samochodowe..... 239

First aid kits

Apteczki..... 240

Safety triangles

Trójkąty ostrzegawcze..... 240

License plate frames

Ramki pod tablicę rejestracyjną..... 240

Ratchet tie downs

Taśmy do bagażu..... 240

EN Service tool cabinet with tools
 PL Szafka serwisowa z narzędziami
 DE Werkstattwagen mit Werkzeug
 RU Сервисная тележка с инструментами
 CZ Vozík servisní s náradím
 RO Dulap echipat cu scule
 HU Szerszámkocsi szerszámokkal
 ES Carro taller con herramientas

177 PCS 901x770 x458 mm 6x DRAWERS LOCKING BLOKADA SZUFLAD CENTRAL LOCK BLOKADA CENTRALNA 2xT Ø125mm 2x BRAKE HAMULEC BALL BEARINGS ŁOŻYSKA KULKOWE NON SLIP WORKTOP BLAT ANTY-POŚLĘGOWY UNIVERSAL PERFORATION UNIWERSALNA PERFORACJA

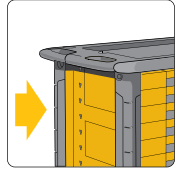

14

12 interchangeable trays with tools

12 wymiennych modułów z narzędziami



No.	Drawer quantity / Liczba szuflad	
58540	6	1

Drawer 1 / Szuflada 1

- 1/2" (12.7 mm): 10, 11, 12, 13, 14, 15, 16, 17, 18, 19, 20, 21, 22, 23, 24, 27, 30, 32 mm; CrV 50BV30;
- 1/2" (12.7 mm); (127 mm); CrV 50BV30;
- 1/2" (12.7 mm); CrV 50BV30;
- 1/2" (12.7 mm); (255 mm); 72T; CrV 6140;
- 1/2" (12.7 mm); (255 mm); CrV 50BV30;
- 1/2" (12.7 mm); 16, 21 mm; CrV 50BV30;
- 3/8" (9.5 mm): 6, 7, 8, 9, 10, 11, 12, 13, 14, 15, 16, 17, 18, 19, 20, 21, 22 mm; CrV 50BV30;
- 3/8" (9.5 mm); (76, 152.4 mm); CrV 50BV30;
- 3/8" (9.5 mm); CrV 50BV30;
- 3/8" (9.5 mm); (200 mm); 72T; CrV 6140;
- 3/8" (9.5 mm); (198 mm); CrV 50BV30;
- 1/4" (6.3 mm): 3.5, 4, 4.5, 5, 5.5, 6, 7, 8, 9, 10, 11, 12, 13, 14 mm; CrV 50BV30;
- 1/4" (6.3 mm); 8, 10, 11, 12, 13 mm; CrV 50BV30;
- 1/4" (6.3 mm); (50.8, 101.6 mm); CrV 6140;
- 1/4" (6.3 mm); CrV 50BV30;
- 1/4" (6.3 mm); (155 mm); 72T; CrV 6140;
- 1/4" (6.3 mm); (150 mm); CrV 50BV30;
- 1/4" (6.3 mm); (152.4 mm); CrV 50BV30

Drawer 2 / Szuflada 2

- 3x75 mm, 5x100 mm, 5x150 mm, 6x38 mm, 6x100 mm, 6x150 mm, 8x150 mm; CrV;
- PH0x100 mm, PH1x75 mm, PH1x100 mm, PH2x38 mm, PH2x100 mm, PH2x150 mm, PH3x150 mm; CrV;
- 180 mm;
- 160 mm;
- 160 mm;
- 160 mm; bent / wygięte

Drawer 3 / Szuflada 3

- 6x7, 8x9, 10x11, 12x13, 14x15, 16x17, 18x19 mm;
- 22, 24, 27, 28, 30, 32 mm;
- 6, 7, 8, 9, 10, 11, 12, 13, 14, 15, 16, 17, 18, 19, 20, 21 mm

Drawer 4 / Szuflada 4

- 1/2" (12.7 mm): 8, 9, 10, 11, 12, 13, 14, 15, 16, 17, 18, 19, 20, 21 mm (L=76 mm); CrV 50BV30;
- 1/2" (12.7 mm), 3/8" (9.5 mm);
- 4, 5, 6, 7, 8, 10, 12 mm (L=30 mm); 4, 5, 6, 7, 8, 10, 12 mm (L=75 mm); CrV;
- M5, M6, M7, M10, M12 (L=30 mm); M5, M6, M7, M10, M12 (L=75 mm); CrV;
- T20, T25, T30, T40, T45, T50, T55 (L=30 mm); T20, T25, T30, T40, T45, T50, T55 (L=75 mm); CrV;
- 300 g (L=300 mm);
- 40 mm (L=300 mm);
- 10x8x142 mm, 12x10x152 mm, 16x13x170 mm

EN Service tool cabinet with tools
 PL Szafka serwisowa z narzędziami
 DE Werkstattwagen mit Werkzeug
 RU Сервисная тележка с инструментами
 CZ Vozík servisní s nářadím
 RO Dulap echipat cu scule
 HU Szerszámokosí szerszámokkal
 ES Carro taller con herramientas



Drawer 1 / Szufłada 1

- 1/2" (12.7 mm): 10, 11, 12, 13, 14, 15, 16, 17, 18, 19, 20, 21, 22, 23, 24, 27, 30, 32 mm; CrV;
- 1/2" (12.7 mm): 45T; CrV;
- 1/2" (12.7 mm); CrV;
- 1/2" (12.7 mm); CrV;
- 1/2" (12.7 mm): 16, 21 mm; CrV;
- 3/8" (9.5 mm): 6, 7, 8, 9, 10, 11, 12, 13, 14, 15, 16, 17, 18, 19, 20, 21, 22 mm; CrV;
- 3/8" (9.5 mm): 2 PCS; CrV;
- 3/8" (9.5 mm); CrV;
- 3/8" (9.5 mm): 45T; CrV;
- 3/8" (9.5 mm); CrV;
- 1/4" (6.3 mm): 3.5, 4, 4.5, 5, 5.5, 6, 7, 8, 9, 10, 11, 12, 13, 14 mm; CrV;
- 1/4" (6.3 mm): E4, E5, E6, E7, E8; CrV;
- 1/4" (6.3 mm); CrV;
- 1/4" (6.3 mm): 2 PCS; CrV;
- 1/4" (6.3 mm); CrV;
- 1/4" (6.3 mm); CrV;
- 1/4" (6.3 mm): 45T; CrV;
- 1/4" (6.3 mm) x 1/4" (6.3 mm); CrV 50BV30;
- 1/4" (6.3 mm): 3, 4, 5.5, 6.5, 7, 8, 9 mm;
- 1/4" (6.3 mm): PH0, PH1, PH2, PH3;
- 1/4" (6.3 mm): PZ0, PZ1, PZ2, PZ3;
- 1/4" (6.3 mm): T8, T9, T10, T15, T20, T25, T27, T30;
- 1/4" (6.3 mm): T8, T9, T10, T15, T20, T25, T27, T30;
- 1/4" (6.3 mm): 3, 4, 5, 6, 7, 8 mm;
- 1/4" (6.3 mm): S0, S1, S2;
- 1/4" (6.3 mm): 4, 5.5, 6.5 mm; CrV;
- 1/4" (6.3 mm): PH1, PH2, PH3; CrV;
- 1/4" (6.3 mm): PZ1, PZ2, PZ3; CrV;
- 1/4" (6.3 mm): T8, T10, T15, T20, T25, T27, T30; CrV;
- 1/4" (6.3 mm): 5, 6, 7, 8 mm; CrV

Drawer 2 / Szufłada 2

- 3/8" (9.5 mm): 4, 5, 6, 7, 8, 10, 12 mm (L=30 mm); 4, 5, 6, 7, 8, 10, 12 mm (L=75 mm); AISI S2;
- 3/8" (9.5 mm): M5, M6, M8, M10, M12 (L=30 mm); M5, M6, M8, M10, M12 (L=75 mm); AISI S2;
- 3/8" (9.5 mm): T20, T25, T30, T40, T45, T50, T55 (L=30 mm); T20, T25, T30, T40, T45, T50, T55 (L=75 mm); AISI S2;
- 1/2" (12.7 mm) x 3/8" (9.5 mm), 3/8" (9.5 mm) x 3/8" (9.5 mm); CrV 6150;
- 1/2" (12.7 mm): 14, 15, 17, 19, 22 mm; CrV;
- 1/2" (12.7 mm): E18, E20, E24; CrV;
- 3/8" (9.5 mm): E10, E11, E12, E14, E16; CrV;
- 1/2" (12.7 mm); CrV;
- 1/2" (12.7 mm); CrV;
- 6, 7, 8, 9, 10, 11, 12, 13, 14, 15, 16, 17, 18, 19, 20, 21 mm

Drawer 3 / Szufłada 3

- 5/32" (4 mm); CrV 6150;
- 5/32" (4 mm): 1.0, 1.5, 2.0, 2.5, 3.0, 3.5 mm; CrV 6150;
- 5/32" (4 mm): PH000, PH00, PH0, PH1; CrV 6150;
- 5/32" (4 mm): PZ0, PZ1; CrV 6150;
- 5/32" (4 mm): T4, T5, T6, T7, T8, T9, T10, T15, T20; CrV 6150;
- 5/32" (4 mm): 0.7, 0.9, 1.3, 2.0, 2.5, 3.0, 4.0 mm; CrV 6150;
- 5/32" (4 mm): 2.5, 3.0, 3.5, 4.0, 4.5, 5.0, 5.5 mm;
- CrV;
- 2.0, 2.5, 3.0, 4.0, 5.0, 5.5, 6.0, 8.0, 10.0, 12 mm; CrV;
- T10, T15, T20, T25, T27, T30, T40, T45, T50; CrV;
- external straight / proste zewnętrzne;
- internal straight / proste wewnętrzne;
- external bent / wygięte zewnętrzne;
- internal bent / wygięte wewnętrzne;

Drawer 4 / Szufłada 4

- 30 Og;
- Ø28 mm;
- 12x150 mm, 16x170 mm;
- 1.5x150 mm, 3x150 mm, 5x150 mm, 8x150 mm;
- 6x100 mm, 2x140 mm;
- 3x75 mm, 5x100 mm, 6x100 mm, 8x150 mm; CrV;
- PH0x75 mm, PH1x100 mm, PH2x100 mm, PH3x150 mm; CrV;
- 300 mm;
- 300 mm;
- 300 mm;
- 300 mm;

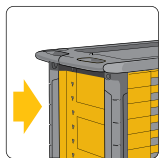

12 interchangeable trays with tools

12 wymiennych modułów z narzędziami



No.	Drawer quantity / Liczba szuflad	
58550	6	1

- EN Roller cabinet
- PL Szafka serwisowa
- DE Werkstattrollwagen
- RU Инструментальная тележка
- CZ Vozík servisní na nářadí
- RO Dulap de scule
- HU Szerszámok kocsi
- ES Carro para herramientas

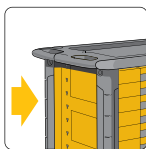
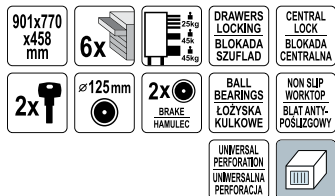

No.	Drawer quantity / Liczba szuflad	
58539	6	1

14

- EN Workshop cabinet
- PL Szafka warsztatowa
- DE Werkstattschrank
- RU Тумба инструментальная
- CZ Dílenská skříň na nářadí
- RO Dulap pt. atelier
- HU Szerszámok szekrény
- ES Armario de taller



No.	Dimensions / Wymiary [mm]	Drawer quantity / Liczba szuflad	
58430	775x525x485	1+1	1

- EN Roller cabinet
- PL Szafka serwisowa
- DE Werkstattrollwagen
- RU Инструментальная тележка
- CZ Vozík servisní na nářadí
- RO Dulap de scule
- HU Szerszámok kocsi
- ES Carro para herramientas

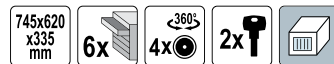

No.	Drawer quantity / Liczba szuflad	
81830	6	1

- EN Workshop cabinet
- PL Szafka warsztatowa
- DE Werkstattschrank
- RU Тумба инструментальная
- CZ Dílenská skříň na nářadí
- RO Dulap pt. atelier
- HU Szerszámok szekrény
- ES Armario de taller

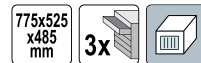

No.	Dimensions / Wymiary [mm]	Drawer quantity / Liczba szuflad	
58433	775x525x485	3	1

EN Workshop cabinet
 PL Szafka warsztatowa
 DE Werkstattschrank
 RU Тумба инструментальная
 CZ Dílenská skříň na nářadí
 RO Dulap pt. atelier
 HU Szerszámok szekrény
 ES Armario de taller



No.	Dimensions / Wymiary [mm]	Drawer quantity / Liczba szuflad	
58434	775x525x485	4	1

EN Workshop trolley
 PL Wózek warsztatowy
 DE Werkstatt-Servicewagen
 RU Инструментальная тележка
 CZ Dílenský policový vozík
 RO Cărucior pt. atelier
 HU Műhelykocsi
 ES Carro para taller



No.	Tray quantity / Liczba pólek	
81863	3	1

EN Workshop trolley
 PL Wózek warsztatowy
 DE Werkstatt-Servicewagen
 RU Инструментальная тележка
 CZ Dílenský policový vozík
 RO Cărucior pt. atelier
 HU Műhelykocsi
 ES Carro para taller



No.	Tray quantity / Liczba pólek	
81860	3	1

EN Wall cabinet
 PL Szafka wisząca
 DE Hängeschrank
 RU Подвесной шкаф
 CZ Závěsná skříňka
 RO Dulap de perete
 HU Faliszekrény
 ES Armario de pared



No.	Dimensions / Wymiary [mm]	
58440	1125x265x630	1

- EN Wall cabinet
- PL Szafka wisząca
- DE Hängeschrank
- RU Подвесной шкаф
- CZ Závěsná skříňka
- RO Dulap de perete
- HU Faliszekrény
- ES Armario de pared



No.	Dimensions / Wymiary [mm]	Box icon
58441	1580x265x630	1

- EN Workshop desk
- PL Biurko warsztatowe
- DE Schreibtisch für Werkstatt
- RU Письменный стол для мастерской
- CZ Pracovní stůl
- RO Masa de lucru
- HU Munkaasztal
- ES Escritorio de trabajo

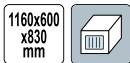

No.	Dimensions / Wymiary [mm]	Box icon
58450	1160x600x830	1

- EN Magnetic tool holder
- PL Zestaw listew magnetycznych
- DE Magnet Werkzeughalter
- RU Магнитная рейка
- CZ Magnetický držák nářadí
- RO Suport magnetic
- HU Mágneses tartó
- ES Bandeja de accesorios magnética

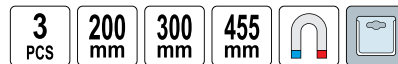

No.	pcs / szt.	Box icon
57830	3	6/12

- EN Service utility key
- PL Klucz do szafek serwisowych
- DE Schaltschrank-Schlüssel für Gängige Schränke
- RU Ключ для сервисных шкафов
- CZ Klíč na rozvodné skříně
- RO Cheie universală pt. cămine utilităţi
- HU Kapcsolószekrény kulcs
- ES Llaves para armarios de control



No.	Box icon
78477	12/72

- EN Workbench
- PL Stół warsztatowy
- DE Werkstatttisch
- RU Верстак
- CZ Pracovní stůl
- RO Banc de lucru
- HU Munkaasztal
- ES Mesa de trabajo

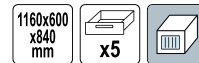

No.	Drawer quantity / Liczba szuflad	Dimensions / Wymiary [mm]	Box icon
58455	5	1160x600x840	1

EN Workbench
 PL Stół warsztatowy
 DE Werkstatttisch
 RU Верстак
 CZ Pracovní stůl
 RO Banc de lucru
 HU Munkasztal
 ES Mesa de trabajo

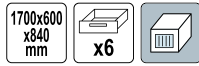

No.	Drawer quantity / Liczba szuflad	Dimensions / Wymiary [mm]	
58456	6	1700x600x840	1

EN Grease gun
 PL Smarownica ręczna
 DE Handhebel-Fettpresse
 RU Шприц для смазки ручной
 CZ Maznice páková
 RO Pistol de gresat
 HU Karos zsírzó
 ES Pistola de engrase manual



No.	Tank capacity / Pojemność zbiornika [cm³]	
78040	400	10

EN Grease gun
 PL Smarownica ręczna
 DE Handhebel-Fettpresse
 RU Шприц для смазки ручной
 CZ Maznice páková
 RO Pistol de gresat
 HU Karos zsírzó
 ES Pistola de engrase manual

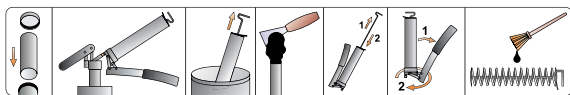
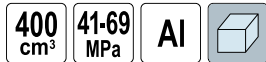

No.	Tank capacity / Pojemność zbiornika [cm³]	
78041	400	5/10

EN Work bench
 PL Stolik monterski
 DE Montagetisch
 RU Монтажный столик
 CZ Montérský stůl
 RO Banc de lucru
 HU Szerelőasztal
 ES Mesa para bricolaje



No.	
29420	1

EN Grease gun
 PL Smarownica ręczna
 DE Handhebel-Fettpresse
 RU Шприц для смазки ручной
 CZ Maznice páková
 RO Pistol de gresat
 HU Karos zsírzó
 ES Pistola de engrase manual



No.	Tank capacity / Pojemność zbiornika [cm³]	
78046	400	10

EN Grease gun
 PL Smarownica ręczna
 DE Handhebel-Fettpresse
 RU Шприц для смазки ручной
 CZ Maznice páková
 RO Pistol de gresat
 HU Karos zsírzó
 ES Pistola de engrase manual

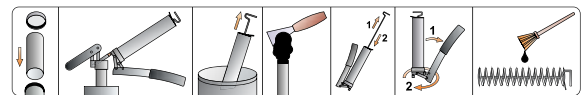
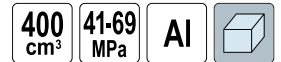

No.	Tank capacity / Pojemność zbiornika [cm³]	
78042	400	5/10

- EN Grease gun
- PL Smarownica ręczna
- DE Handhebel-Fettpresse
- RU Шприц для смазки ручной
- CZ Maznice páková
- RO Pistol de gresat
- HU Karos zsírzó
- ES Pistola de engrase manual

500 cm³ 



No.	Tank capacity / Pojemność zbiornika [cm ³]	
78047	500	10

- EN Grease gun
- PL Smarownica ręczna
- DE Handhebel-Fettpresse
- RU Шприц для смазки ручной
- CZ Maznice páková
- RO Pistol de gresat
- HU Karos zsírzó
- ES Pistola de engrase manual

600 cm³ 41-69 MPa AI 

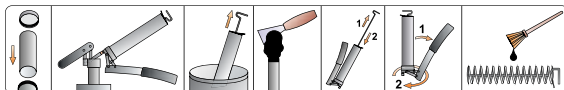

No.	Tank capacity / Pojemność zbiornika [cm ³]	
78043	600	6/12

- EN Grease gun
- PL Smarownica ręczna
- DE Handhebel-Fettpresse
- RU Шприц для смазки ручной

- CZ Maznice páková
- RO Pistol de gresat
- HU Karos zsírzó
- ES Pistola de engrase manual

120 g AI 

14



No.	Tank capacity / Pojemność zbiornika [g]	
78039	120	30

- EN Heavy duty jaw couplers
- PL Zestaw końcówek czterozszczękowych do smarownic
- DE Mundstücksatz für Handhebel-Fettpressen
- RU Соединительные патроны для масляного листопада
- CZ Sada koncovek k mazacímu lisu
- RO Cap gresor
- HU Tömítő csatlakozó karos zsírzóhoz
- ES Juego de boquillas para engrasadores

4 PCS Ø 15 mm 6-7 mm G 1/8-28 



No.	Ø [mm]	pcs / szt.	
78061	15	4	20/80

- EN Push type grease gun
- PL Smarownica wyciskowa
- DE Press-Fettspritze
- RU Шприц смазочный нажимной
- CZ Rázový mazací lis
- RO Gresor
- HU Kézi olajozó
- ES Engrasador

80 g 



No.	Tank capacity / Pojemność zbiornika [g]	
78037	80	40

- EN Flexible tube for grease gun
- PL Wężyk do townotnicy
- DE Schlauch für Fettpresse
- RU Шприц для перекачки масел
- CZ Hadička na maznice na šmír
- RO Furtun flexibil pt. pistol de gresat
- HU Tömítő a zsírzóhoz
- ES Manguera para engrasador

240 mm 



No.	L [mm]	
78045	240	50/250

- EN Flexible hose for grease gun
- PL Wężyk giętki do smarownic
- DE Schlauch für Fettpresse
- RU Гибкий шланг для товотницы
- CZ Hadička na maznice na šmír
- RO Furtun flexibil pt. pistol de gresat
- HU Tömítő a zsírzóhoz
- ES Manguera para engrasador

6-7 mm G 1/8-28 31 MPa 



No.	L [mm]	Max. pressure / Maks. ciśnienie [MPa]	
78067	300	31	50/250
78068	500	31	50/250

EN Manual oil pump
 PL Pompa ręczna do oleju
 DE Öl-Umfüllpumpe
 RU Ручной насос для перекачки масел
 CZ Pumpa ruční na olej
 RO Pompă manuală pt. ulei
 HU Kézi olajszivattyú
 ES Bomba manual para aceite



19
l/min
 FOR OIL
DO
OLEJU



No.	Max. capacity / Maks. wydajność [l/min]	
78000	19	5

EN Manual oil pump
 PL Pompa ręczna do oleju
 DE Öl-Umfüllpumpe
 RU Ручной насос для перекачки масел
 CZ Pumpa ruční na olej
 RO Pompă manuală pt. ulei
 HU Kézi olajszivattyú
 ES Bomba manual para aceite



20
l/min
 x3
PIPE
RURA
 FOR OIL
DO
OLEJU
AI



No.	Max. capacity / Maks. wydajność [l/min]	
78002	20	10

EN Manual oil pump
 PL Minipompa ręczna do oleju
 DE Öl-Umfüllpumpe
 RU Ручной насос для перекачки масел
 CZ Pumpa ruční na olej
 RO Pompă manuală pt. ulei
 HU Kézi olajszivattyú
 ES Bomba manual para aceite



15
l/min
MINI
 FOR OIL
DO
OLEJU
AI



No.	Max. capacity / Maks. wydajność [l/min]	
78003	15	20

EN Self-priming fuel pump
 PL Samozasysający wąż do paliwa
 DE Selbstansaugender Kraftstoffschlauch
 RU Шланг с обратным клапаном для перекачки топлива
 CZ Přečerpávací hadice se samonasávacím ventilem
 RO Furtun pt. transfer lichide
 HU Üzemanyag légtelenítő kézi pumpa
 ES Manguera aspiración manual



13
mm
180
cm
 SELF-
PRIMING
SAMO-
ZASYSAJĄCY
PVC



No.	
83009	6/24

EN Electric engine oil extractor pump
 PL Elektryczna pompa do odsysania oleju silnikowego
 DE Elektrische Ölabsaugpumpe
 RU Электрический насос для перекачки масла
 CZ Elektrické čerpadlo na odsávání oleje
 RO Pompă electrică de scos ulei
 HU Elektromos olaj szivattyú
 ES Bomba eléctrica extractora de aceite de motor



80
W
12V
3
l/min



No.	Power / Moc [W]	
78007	80	10

EN Oil drainer
 PL Odsysarka ręczna do oleju
 DE Öl-Absaugpumpe
 RU Ручной шприц для откачки масла
 CZ Ruční odsávačka oleje
 RO Pompă de ulei
 HU Kézi olajszivattyú
 ES Bomba manual de trasvase



200
cm³



No.	Tank capacity / Pojemność zbiornika [cm ³]	
78030	200	10

EN Oil drainer
 PL Odsysarka ręczna do oleju
 DE Öl-Absaugpumpe
 RU Ручной шприц для откачки масла
 CZ Ruční odsávačka oleje
 RO Pompă de ulei
 HU Kézi olajszivattyú
 ES Bomba manual de trasvase



400
cm³



No.	Tank capacity / Pojemność zbiornika [cm ³]	
78031	400	10

- EN Oil drainer
- PL Odsysarka ręczna do oleju
- DE Öl-Absaugpumpe
- RU Ручной шприц для откачки масла
- CZ Ruční odsávačka oleje
- RO Pompă extras ulei
- HU Kézi olajszivattyú
- ES Bomba manual de trasvase

500 cm³ 

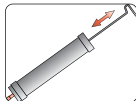

No.	Tank capacity / Pojemność zbiornika [cm ³]	
78044	500	10/20

- EN Manual car oil pump
- PL Odsysarka ręczna do oleju
- DE Manuelle Öl-Absaugpumpe
- RU Ручной насос для откачки масла
- CZ Ruční vakuová odsávačka oleje
- RO Pompă extracție ulei
- HU Kézi olajleszívó pumpa
- ES Bomba manual para extracción de aceite



6L 
 4 
 SUCTION PROBES
 SONDEZ SŔACE
 HDPE 
 FOR OIL
 DO
 OLEJU 



No.	Tank capacity / Pojemność zbiornika [l]	
78032	6	4

- EN Oil can with a flexible applicator
- PL Oliwiarka z elastycznym aplikatorem
- DE Ölkanne mit elastischem Applikator
- RU Масленка с гибким наконечником
- CZ Olejníčka s flexibilním hrdlem
- RO Pompită de ulei cu aplicator flexibil
- HU Hajlékony csövű olajozó
- ES Aceitera con aplicador flexible



200 ml 



No.	Capacity / Pojemność [ml]	
78306	200	10/60

- EN Oil can
- PL Oliwiarka
- DE Ölkanne
- RU Масленка
- CZ Olejníčka
- RO Pompită de ulei
- HU Olajozó
- ES Aceitera



300 ml 



No.	Capacity / Pojemność [ml]	
78303	300	10/60

- EN Manual oil pump
- PL Pompa ręczna do oleju
- DE Öl-Umfüllpumpe
- RU Ручной насос для перекачки масел

- CZ Pumpa ruční na olej
- RO Pompă manuală pt. ulei
- HU Kézi olajszivattyú
- ES Bomba manual para aceite

500 cm³ 



No.	Tank capacity / Pojemność zbiornika [cm ³]	
78035	500	10

- EN Oil can with a flexible applicator
- PL Oliwiarka z elastycznym aplikatorem
- DE Ölkanne mit elastischem Applikator
- RU Масленка с гибким наконечником
- CZ Olejníčka s flexibilním hrdlem
- RO Pompită de ulei cu aplicator flexibil
- HU Hajlékony csövű olajozó
- ES Aceitera con aplicador flexible

300 ml 



No.	Capacity / Pojemność [ml]	
78300	300	15/60

- EN Oil can
- PL Oliwiarka
- DE Ölkanne
- RU Масленка
- CZ Olejníčka
- RO Pompită de ulei
- HU Olajozó
- ES Aceitera

250 ml 



No.	Capacity / Pojemność [ml]	
78301	250	6/72

- EN Oil filter wrench
- PL Klucz do filtra oleju
- DE Ölfilterschlüssel
- RU Съёмник масляного фильтра
- CZ Klíč na olejový filtr
- RO Cheie pt. filtru de ulei
- HU Olajszűrő leszedő
- ES Llave para filtro de aceite

1/2" 12.7mm  3/8" 9.5mm  Ø 65-110mm 



No.	Ø	Ø [mm]	
57600	1/2" (12.7 mm), 3/8" (9.5 mm)	65-110	6/36

EN Oil filter wrench
 PL Klucz do filtra oleju zaciskowy
 DE Ölfilterschlüssel
 RU Съёмник масляных фильтров зажимной

CZ Klíč na filtr oleju svěrácí
 RO Cheie pt. filtru de ulei
 HU Olajszűrő kulcs, patintós
 ES Llave de filtro de aceite

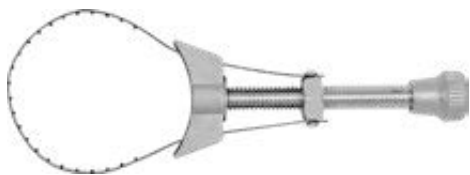
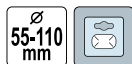

No.	Ø [mm]	
57610	55-110	10/50

EN Oil filter wrench
 PL Klucz do filtra oleju
 DE Ölfilterschlüssel
 RU Съёмник масляного фильтра

CZ Klíč na olejový filtr
 RO Cheie pt. filtru de ulei
 HU Olajszűrő leszedő
 ES Llave para filtro de aceite



No.		
57630		10/40

EN Oil filter wrench
 PL Klucz do filtra oleju
 DE Ölfilterschlüssel
 RU Съёмник масляного фильтра

CZ Klíč na olejový filtr
 RO Cheie pt. filtru de ulei
 HU Olajszűrő leszedő
 ES Llave para filtro de aceite



No.	Ø	Ø [mm]	
57660	3/8"	9.5 mm	6/36

EN Oil filter wrench
 PL Klucz do filtra oleju
 DE Ölfilterschlüssel
 RU Съёмник масляного фильтра

CZ Klíč na olejový filtr
 RO Cheie pt. filtru de ulei
 HU Olajszűrő leszedő
 ES Llave para filtro de aceite



No.	Ø [mm]	
57612	73-85	6/36
57613	83-95	6/36
57614	93-111	6/36

EN Oil filter wrench
 PL Klucz do filtra oleju
 DE Ölfilterschlüssel
 RU Съёмник масляного фильтра

CZ Klíč na olejový filtr
 RO Cheie pt. filtru de ulei
 HU Olajszűrő leszedő
 ES Llave para filtro de aceite



No.		
57620		10/100

EN Oil filter wrench
 PL Klucz do filtra oleju
 DE Ölfilterschlüssel
 RU Съёмник масляного фильтра

CZ Klíč na olejový filtr
 RO Cheie pt. filtru de ulei
 HU Olajszűrő leszedő
 ES Llave para filtro de aceite



No.		
57640		25/100

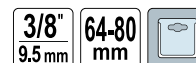

EN Strap wrench set
 PL Zestaw kluczy taśmowych do filtrów oleju
 DE Ölfilter-Bandschlüssel-Set
 RU Набор ленточных ключей для масляных фильтров

CZ Sada řemenových klíčů na olejové filtry
 RO Set chei cu banda
 HU Olajszűrő leszedő készlet
 ES Juego de llaves de correa para filtros de aceite

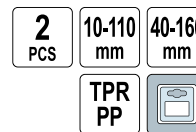

No.	Ø [mm]	pcs / szt.	
57616	10-110, 40-160	2	6/24

EN Gear puller
 PL Ściągacz do łożysk
 DE Lagerabzieher
 RU Съёмник подшипников
 CZ Stahovák na ložiska
 RO Extractor pt. rulmenți
 HU Csapágyelhűző
 ES Extractor de cojinetes



No.	Size / Rozmiar	Jaws range / Rozstaw szczęk [mm]	Arm quantity / Liczba ramion	
80500	3"	75	3	4/40
80510	4"	100	3	5/30
80520	6"	150	3	2/20
80530	8"	200	3	2/12

EN Coil spring compressor
 PL Ściągacz do sprężyn
 DE Federspanner
 RU Съёмник пружин
 CZ Stahovák pružin
 RO Presă pt. arcuiri
 HU Rugóösszehűző
 ES Desmontador para los resortes



No.	pcs / szt.	
80600	2	6/12

EN Coil spring compressor
 PL Ściągacz do sprężyn
 DE Federspanner
 RU Съёмник пружин
 CZ Stahovák pružin
 RO Presă pt. arcuiri
 HU Rugóösszehűző
 ES Desmontador para los resortes



No.	Ø [mm]	L [mm]	pcs / szt.	
80602	82	370	2	12

EN Removal tool set
 PL Zestaw łomów
 DE Brechstangensatz
 RU Набор ломов
 CZ Sada páčidel
 RO Set leviere
 HU Feszítővas készlet
 ES Juego de palancas



No.	Size / Rozmiar [mm]	pcs / szt.	
34182	16x305, 21x450	2	6/24

EN Gear puller
 PL Ściągacz do łożysk
 DE Lagerabzieher
 RU Съёмник подшипников
 CZ Stahovák na ložiska
 RO Extractor pt. rulmenți
 HU Csapágyelhűző
 ES Extractor de cojinetes



No.	Size / Rozmiar	Jaws range / Rozstaw szczęk [mm]	Wrench size / Rozmiar klucza [mm]	Arm quantity / Liczba ramion	
80470	3"	75	14	2	30
80471	4"	100	17	2	24
80472	5"	127	17	2	20
80473	6"	150	19	2	12
80474	8"	200	22	2	6

EN Coil spring compressor
 PL Ściągacz do sprężyn
 DE Federspanner
 RU Съёмник пружин
 CZ Stahovák pružin
 RO Presă pt. arcuiri
 HU Rugóösszehűző
 ES Desmontador para los resortes



No.	pcs / szt.	
80601	2	10

EN Precision screwdriver and hook set
 PL Zestaw precyzyjnych wkręteków i haczyków
 DE Präzisions-Schraubendreher- und Haken-Satz
 RU Набор прецизионных отвёрток и крючков
 CZ Sada přesných šroubováků a háčků
 RO Set șurubelnițe de precizie
 HU Precíziós csavarhúzó és kampó készlet
 ES Set de destornilladores precisos y ganchos

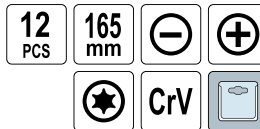

⊖ 2.5, 3.5 mm; ⊕ PH00, PH0; ⚙ T6, T7, T8, T10; ⚡ 45°, 90°, 135°, 180°

No.	pcs / szt.	
64555	12	10/40

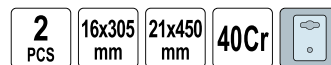

EN Removal tool set
 PL Zestaw łomów
 DE Brechstangensatz
 RU Набор ломов
 CZ Sada páčidel
 RO Set leviere
 HU Feszítővas készlet
 ES Juego de palancas

4 PCS
 11x195 mm
 16x305 mm
 21x445 mm
 21x600 mm
 40Cr



VOREL

No.	Size / Rozmiar [mm]	pcs / szt.	
34184	11x195, 16x305, 21x445, 21x600	4	2/12

EN Tie rod end lifter
 PL Ściągacz do sworzni kulistych
 DE Universal-Kugelgelenk-Abzieher
 RU Съёмник шаровых опор
 CZ Stahovák kulových čepů řízení
 RO Extractor pt. articulatii sferice
 HU Gömbfej kinyomó
 ES Extractor de pernos esféricos



VOREL

No.		
80640		25

EN Cross rim wrench
 PL Krzyżakowy klucz do kół
 DE Kreuzschlüssel
 RU Ключ-крест балонный
 CZ Klíč na kola křížový
 RO Cheie în cruce pt. roți
 HU Kereszt kerékkulcs
 ES Llave cruz para ruedas



VOREL

No.	Size / Rozmiar	
57000	17x19x22x13*16" (20.6 mm)	20

EN Cross rim wrench
 PL Krzyżakowy klucz do kół
 DE Kreuzschlüssel
 RU Ключ-крест балонный
 CZ Klíč na kola křížový
 RO Cheie în cruce pt. roți
 HU Kereszt kerékkulcs
 ES Llave cruz para ruedas

VOREL

No.	Size / Rozmiar	
57020	17x19x21x12" (12.7 mm)	10

EN Tie rod end lifter
 PL Ściągacz do sworzni kulistych
 DE Universal-Kugelgelenk-Abzieher
 RU Съёмник шаровых опор
 CZ Stahovák kulových čepů řízení
 RO Extractor pt. articulatii sferice
 HU Gömbfej kinyomó
 ES Extractor de pernos esféricos



VOREL

No.	
80620	25/50

EN Tire lever set
 PL Zestaw łyżek do opon
 DE Reifenlöffel-Satz
 RU Набор шинных ложек
 CZ Sada lžic na pneumatiky
 RO Set leviere
 HU Abroncs leszedő szerszámkészlet
 ES Juego de palancas para neumáticos

4 PCS
 12" 300 mm
 16" 395 mm
 20" 495 mm
 24" 595 mm
 HARDENED STEEL
 STAL HARTOWANA

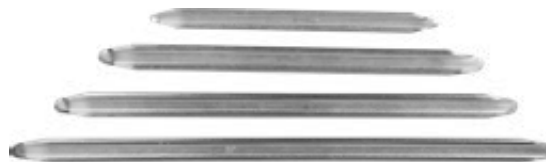

VOREL

No.	pcs / szt.	
56980	4	10

EN Cross rim wrench
 PL Krzyżakowy klucz do kół
 DE Kreuzschlüssel
 RU Ключ-крест балонный
 CZ Klíč na kola křížový
 RO Cheie în cruce pt. roți
 HU Kereszt kerékkulcs
 ES Llave cruz para ruedas



No.	Size / Rozmiar [mm]	
57010	17x19x21x23	20



EN Cross rim wrench
 PL Krzyżakowy klucz do kół
 DE Kreuzschlüssel
 RU Ключ-крест балонный
 CZ Klíč na kola křížový
 RO Cheie în cruce pt. roți
 HU Kereszt kerékkulcs
 ES Llave cruz para ruedas



No.	Size / Rozmiar [mm]	Icon
57030	17x19x22x23	20

EN L-type wheel wrench
 PL Klucz do kół rozsuwany
 DE Teleskop-Radmutternschlüssel
 RU Ключ баллонный телескопический
 CZ Teleskopický klíč na kola
 RO Cheie pt. roți extensibilă
 HU Kihúzható kerékkulcs
 ES Llave para ruedas extensible



1/2" (12.7 mm): 17 x 19 mm



No.	Size / Rozmiar [mm]	L [mm]	Ø	Icon
57100	17x19	360-510	1/2" (12.7 mm)	10/20

14

EN Spark plug wrench
 PL Klucz do światec
 DE Zündkerzenschlüssel
 RU Ключ свечной
 CZ Svíčkový klíč
 RO Cheie pt. bujii
 HU Gyertyakulcs
 ES Llave para bujias



No.	Size / Rozmiar [mm]	L [mm]	Icon
57160	16	150	25/50
57210	21	150	25/50

EN Spark plug wrench
 PL Klucz do światec
 DE Zündkerzenschlüssel
 RU Ключ свечной
 CZ Svíčkový klíč
 RO Cheie pt. bujii
 HU Gyertyakulcs
 ES Llave para bujias



No.	Size / Rozmiar [mm]	L [mm]	Icon
57220	16	260	50
57221	21	260	50

EN Cross rim wrench
 PL Krzyżakowy klucz do kół
 DE Kreuzschlüssel
 RU Ключ-крест балонный
 CZ Klíč na kola křížový
 RO Cheie în cruce pt. roți
 HU Kereszt kerékkulcs
 ES Llave cruz para ruedas



No.	Size / Rozmiar	Icon
57050	24x27x32x3/4" (19.0 mm)	5

EN Piston ring compressor
 PL Zaciskacz do pierścieni
 DE Kolbenring-Spannband
 RU Зажим колец
 CZ Svěrka na kroužky
 RO Presă segmentj auto
 HU Gyűrűbepattintó
 ES Pinza para anillos

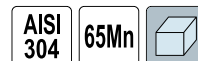

No.	Ø [mm]	H [mm]	Icon
80660	50-125	75	36
80661	75-175	100	36

EN Spark plug wrench
 PL Klucz do światec
 DE Zündkerzenschlüssel
 RU Ключ свечной
 CZ Svíčkový klíč
 RO Cheie pt. bujii
 HU Gyertyakulcs
 ES Llave para bujias



No.	Size / Rozmiar [mm]	L [mm]	Icon
57260	16/21	150	25/50

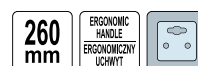

EN Hand-held vacuum pump
 PL Pompka podciśnieniowa z akcesoriami
 DE Unterdruckpumpe mit Zubehör
 RU Насос вакуумметрического давления с принадлежностями
 CZ Podtlaková pumpa s příslušenstvím
 RO Pompa de vidare cu accesorii
 HU Vákuum- és ac-pumpa mérő, tartozékokkal
 ES Bomba de subpresión con accesorios

16 PCS -0.1 MPa



No.		
81690		10

EN Brake piston wind back
 PL Separator do zacisków hamulcowych
 DE Separator für Bremssättel
 RU Сепаратор для тормозных суппортов
 CZ Oddělovač brzdových třmenů
 RO Presă etrier frână
 HU Féknyereg dugattyú
 ES Separador para pinzas de freno

5 PCS



Audi, VW, Ford, Honda, Jaguar, Mazda, Mitsubishi, Nissan, Rover, Saab, Subaru, Skoda, Toyota, Volvo



No.		
57730		10/20

EN Paint thickness tester
 PL Miernik grubości lakieru
 DE Lackdickenmessgerät
 RU Толщиномер лакокрасочного покрытия
 CZ Měřič tloušťky laku
 RO Tester pt. grosime vopsea
 HU Rétegvastagság mérő
 ES Medidor de espesor de recubrimiento

0-2.0 mm ±2% ACCURACY DOKLADNOSC ALUMINIUM ALUMINIUM STEEL STEEL



No.		
81731		40/80

EN Automotive circuit tester
 PL Wskaźnik elektryczny samochodowy
 DE KFZ-Spannungsprüfer
 RU Пробник автомобильный
 CZ Automobilová zkušební napětí
 RO Tester pt. circuite auto
 HU Autós fázisceruza
 ES Comprobador de voltaje para auto

No.	Measuring range / Zakres pomiaru [V d.c.]	
65270	6-24	20/200

EN Flare nut wrenches
 PL Klucze do przewodów hamulcowych
 DE Bremsleitungsschlüsselsatz
 RU Набор ключей разрезных
 CZ Klíče na vedení brzd
 RO Set chei inelare semideschise
 HU Fékcsőkulcs
 ES Llaves para tubería de frenado

3 PCS



No.	pcs / szt.	
57700	3	12/60

EN Disc brake piston tool
 PL Uniwersalny klucz do wkręcania zacisków hamulcowych
 DE Bremskolbenrücksteller universal
 RU Ключ для тормозного поршня
 CZ Univerzální klíč k montáži brzdových třmenů
 RO Dispozitiv pt. impins etrier
 HU Féknyereg összenyomó
 ES Llave para comprimir pistones del freno de disco

3/8" 9.5mm



General Motors, Ford, Chrysler, VW, Fiat



No.		
57740	3/8" (9.5 mm)	6/72

EN Automotive circuit tester
 PL Wskaźnik elektryczny samochodowy
 DE KFZ-Spannungsprüfer
 RU Пробник автомобильный
 CZ Automobilová zkušební napětí
 RO Tester pt. circuite auto
 HU Autós fázisceruza
 ES Comprobador de voltaje para auto

6-24V



No.	Measuring range / Zakres pomiaru [V d.c.]	
65260	6-24	20/200

6-24V



- EN Pick-up tool
- PL Łapka do podnoszenia
- DE Starrer Greifer
- RU Гибкий захват „Pick-up”
- CZ Patka pro zdvihání
- RO Recuperator flexibil
- HU Emelőlapka
- ES Grifo para recoger pick up



No.	L [mm]	Icon
78400	600	50/150

- EN Flexible pick-up handle, magnetic
- PL Łapka magnetyczna, giętka
- DE Magnetisch flexibler Greifer
- RU Гибкий магнитный захват
- CZ Vytahovák magnetický ohebný
- RO Surubelinta flexibila magnetica
- HU Mágneses felszedő eszköz, hajlékony nyél
- ES Grifo magnético flexible



No.	L [mm]	Icon
78401	600	50/100

- EN LED magnetic pick up tool
- PL Chwytnak teleskopowy LED
- DE LED Magnet Heber
- RU Захват магнитный телескопический с подсветкой
- CZ Patka magnetická teleskopická LED
- RO Telescop magnetic cu LED
- HU LED felszedő mágnes teleszkópos nyéllel
- ES Herramienta para levantar, telescópica, con LED

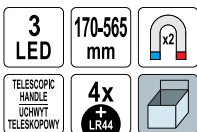

No.	Light source / Źródło światła [LED]	Battery type / Rodzaj baterii	Icon
78405	3	4x LR44	12/48

- EN Workshop seat with drawer
- PL Taboret warsztatowy z szufladą
- DE Werkstattthocker mit Schublade
- RU Табурет рабочий с ящиком
- CZ Dilenský taburet se zásuvkou
- RO Taburet atelier cu sertar
- HU Műhely zsámoly fiókkal
- ES Taburete de taller con cajón



No.	Max. load capacity / Maks. obciążenie [kg]	Icon
81824	90	4

- EN Telescopic pick up and mirror set
- PL Zestaw inspekcyjny: lusterko + chwytak
- DE Inspektionsatz: Spiegel + Greifer
- RU Проверочный набор - держатель и зеркальце
- CZ Inspekční souprava: zrcadlo + držák
- RO Set control: oglindă + telescop magnetic
- HU Teleszkópos ellenőrző készlet: tükör + felvevő
- ES Juego de inspección: espejo + cuchara de mordazas



No.	pcs / szt.	Icon
78410	2	25/100

- EN Magnetic wristband
- PL Opaska magnetyczna
- DE Haftmagnet
- RU Браслет магнитный
- CZ Magnetický pás
- RO Manșetă magnetică
- HU Mágneses szalag
- ES Banda magnética



No.	L [mm]	Icon
78756	320	12/96

- EN Workshop creeper
- PL Leżanka warsztatowa
- DE Werkstatt-Liege
- RU Лежак ремонтный
- CZ Montážní lehátko
- RO Targă service
- HU Fekpad guruló
- ES Camilla para mecánico



No.	Dimensions / Wymiary [mm]	Icon
81827	910x410x120	1

- EN Workshop seat
- PL Taboret warsztatowy
- DE Werkstatt-Sitz
- RU Табурет рабочий
- CZ Dilenský taburet
- RO Taburet atelier
- HU Műhely zsámoly
- ES Taburete de taller

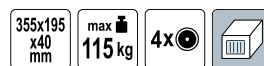

No.	Max. load capacity / Maks. obciążenie [kg]	Icon
81822	115	5

EN Pneumatic car seat
 PL Taboret warsztatowy teleskopowy
 DE Werkstattocker, teleskopisch
 RU Табурет рабочий подъемный
 CZ Dílenský taburet teleskopický
 RO Scaun atelier telescopic
 HU Teleszkópos műhely zsámoly
 ES Taburete de taller telescópico

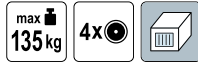

No.	Max. load capacity / Maks. obciążenie [kg]	Box
81825	135	4

EN Electric impact wrench
 PL Elektryczny klucz udarowy
 DE Elektro-Schlagschrauber
 RU Электрический гайковерт
 CZ Elektrický rázový uťahovák
 RO Pistol de impact electric
 HU Elektromos ütvecsavarozó
 ES llave de impacto eléctrica

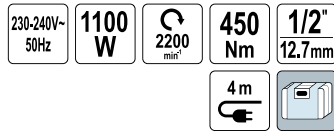

17, 19, 21, 22 mm



$L_{pa} = 89,0 \pm 3,0$ dB; $L_{wa} = 100,0 \pm 3,0$ dB; $a_p = 10,04 \pm 1,5$ m/s²

No.	Power / Moc [W]	Speed [min ⁻¹]	Box
57092	1100	2200	2

EN Hydraulic bottle jack
 PL Podnośnik hydrauliczny stupkowy
 DE Hydraulischer Stempelwagenheber
 RU Домкрат гидравлический бутылочный

CZ Hydraulický pístový zvedák
 RO Cric hidraulic
 HU Hidraulikus palack emelő
 ES Gato hidráulico de botella



No.	Max. lifting capacity / Maks. udźwig [t]	Lifting range / Zakres podnoszenia [mm]	Box
80012	2	140-260	6
80022	3	168-326	6
80032	5	185-355	4
80042	8	190-365	4
80052	10	195-375	4
80062	12	200-380	3
80072	15	205-390	2
80082	20	217-402	2

EN Electric impact wrench
 PL Elektryczny klucz udarowy
 DE Elektro-Schlagschrauber
 RU Электрический гайковерт
 CZ Elektrický rázový uťahovák
 RO Pistol de impact electric
 HU Elektromos ütvecsavarozó
 ES llave de impacto eléctrica



17, 19, 21, 22 mm



$L_{pa} = 87,5 \pm 3,0$ dB; $L_{wa} = 98,5 \pm 3,0$ dB; $a_p = 9,93 \pm 1,5$ m/s²

No.	Power / Moc [W]	Speed [min ⁻¹]	Box
57091	800	2200	5

EN Electric impact wrench
 PL Elektryczny klucz udarowy
 DE Elektro-Schlagschrauber
 RU Электрический гайковерт
 CZ Elektrický rázový uťahovák
 RO Pistol de impact electric
 HU Elektromos ütvecsavarozó
 ES llave de impacto eléctrica

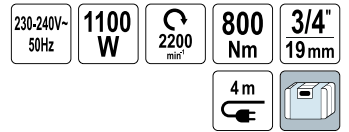

24, 30, 32, 36 mm



$L_{pa} = 89,0 \pm 3,0$ dB; $L_{wa} = 100,0 \pm 3,0$ dB; $a_p = 10,04 \pm 1,5$ m/s²

No.	Power / Moc [W]	Speed [min ⁻¹]	Box
57097	1100	2200	2

EN Hydraulic floor jack
 PL Podnośnik hydrauliczny
 DE Hydraulischer Rangierwagenheber
 RU Домкрат гидравлический
 CZ Pístový zvedák hydraulický
 RO Cric tip crocodil
 HU Krokodil emelő
 ES Gato hidráulico



No.	Max. lifting capacity / Maks. udźwig [t]	Lifting range / Zakres podnoszenia [mm]	Box
80111	2	135-340	1

EN Scissors jack
 PL Podnośnik mechaniczny trapezowy
 DE Trapezwagenheber
 RU Домкрат механический ромбовый
 CZ Lichoběžníkový zvedák
 RO Cric mecanic
 HU Trapézemelő
 ES Gato mecanico-trapezoidal



No.	Max. lifting capacity / Maks. udźwig [t]	Lifting range / Zakres podnoszenia [mm]	
80252	1.5	95-390	5

EN Rubber pad for jacks
 PL Podkładka gumowa do podnośnika
 DE Gummiauflage für Wagenheber
 RU Резиновая шайба для домкрата
 CZ Gumová podložka zvedáku
 RO Tampon de cauciuc pt. cric crocodil
 HU Gumpogácsa krokodilemelőhöz
 ES Almohadilla de caucho para gatos



No.	Ø [mm]	
80107	97	200

EN Jack stand
 PL Podstawa pod samochód
 DE Unterstellbock
 RU Подставка автомобильная
 CZ Podstavec pod auto
 RO Set capre auto
 HU Gépkocsi alátét
 ES Caballete para auto



No.	Max. load capacity / Maks. obciążenie [t]	Lifting range / Zakres podnoszenia [mm]	pcs / szt.	
80307	2	265-390	2	4
80308	3	275-415	2	4
80309	6	360-585	2	1

EN Porta power repair kit
 PL Rozpierań hydrauliczny
 DE Hydraulischer Richt und Ausbeulsatz
 RU Гидравлическая распорная стойка в наборе

CZ Hydraulický rozpěrák
 RO Trusa pompa hidraulica + accesorii
 HU Hidraulikus bontó
 ES Gato carrocerro hidráulico



No.	Max. load capacity / Maks. obciążenie [t]	
80402	4	1

EN Scissors jack
 PL Podnośnik mechaniczny trapezowy
 DE Trapezwagenheber
 RU Домкрат механический ромбовый
 CZ Lichoběžníkový zvedák
 RO Cric mecanic
 HU Trapézemelő
 ES Gato mecanico-trapezoidal



No.	Max. lifting capacity / Maks. udźwig [t]	Lifting range / Zakres podnoszenia [mm]	
80271	1.2	100-350	4

EN Jack stand
 PL Podstawa pod samochód
 DE Unterstellbock
 RU Подставка автомобильная
 CZ Podstavec pod auto
 RO Set capre auto
 HU Gépkocsi alátét
 ES Caballete para auto

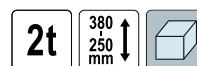

No.	Max. load capacity / Maks. obciążenie [t]	Lifting range / Zakres podnoszenia [mm]	
80300	2	250-380	5

EN Jack stand
 PL Podstawa pod samochód
 DE Unterstellbock
 RU Подставка автомобильная
 CZ Podstavec pod auto
 RO Set capre auto
 HU Gépkocsi alátét
 ES Caballete para auto

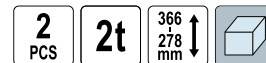

No.	Max. load capacity / Maks. obciążenie [t]	Lifting range / Zakres podnoszenia [mm]	pcs / szt.	
80312	2	278-366	2	5



EN Porta power repair kit
 PL Rozpieraak hydrauliczny
 DE Hydraulischer Richt und Ausbeulsatz
 RU Гидравлическая распорная стойка в наборе

CZ Hydraulický rozpěrák
 RO Trusa pompa hidraulica + accesorii
 HU Hidraulikus bontó
 ES Gato carrocero hidráulico



No.	Max. load capacity / Maks. obciążenie [t]	
80412	10	1

EN Pull-back ram
 PL Ściągacz blacharski hydrauliczny
 DE Hydraulische Zugzylindereinheit
 RU Гидравлическая стяжка-крюк
 CZ Klempířské stahovadlo hydraulické
 RO Cârîg hidraulic
 HU Hidraulikus lemezkihúzó
 ES Extractor de latonería de fontanero



No.	Max. load capacity / Maks. obciążenie [t]	Operating pressure / Ciśnienie robocze [MPa]	
80450	10	55	4

EN Electronic battery charger
 PL Prostownik elektroniczny
 DE Elektronisches Ladegerät
 RU Электронное зарядное устройство
 CZ Elektronická nabíječka
 RO Redresor electric
 HU Elektronikus akkumulátortöltő
 ES Cargador de batería para coche



No.	Charging voltage / Napiecie ładowania [V d.c.]	Charging current / Prąd ładowania [A]	Charging battery capacity / Pojemność ładowanego akumulatora [Ah]	
82541	12	2.8	8-60	10

EN Accessories for porta power
 PL Pompa do rozpieraka hydraulicznego
 DE Druckeinheit für hydraulischer Spreizer
 RU Ручной насос для гидравлической распорной стойки
 CZ Pumpa na hydraulický rozpěrák
 RO Pompa hidraulica
 HU Szivattyú hidraulikus bontóhoz
 ES Bomba hidraulica para gato carrocero



No.	Max. load capacity / Maks. obciążenie [t]	
80320	4	2
80330	10	2

EN Accessories for porta power
 PL Siłownik do rozpieraka hydraulicznego
 DE Kraftzylinder für hydraulischer Spreizer
 RU Сервомотор для гидравлической распорной стойки
 CZ Servomotor na hydraulický rozpěrák
 RO Accesorii pompa hidraulica
 HU Erőátvitel a hidraulikus bontóhoz
 ES Cilindro para gato carrocero



No.	Max. load capacity / Maks. obciążenie [t]	
80340	4	4
80350	10	4

EN Electronic battery charger
 PL Prostownik elektroniczny
 DE Elektronisches Ladegerät
 RU Электронное зарядное устройство
 CZ Elektronická nabíječka
 RO Redresor electric
 HU Elektronikus akkumulátortöltő
 ES Cargador de batería para coche



No.	Charging voltage / Napiecie ładowania [V d.c.]	Charging current / Prąd ładowania [A]	Charging battery capacity / Pojemność ładowanego akumulatora [Ah]	
82542	12	4.2	12-90	10

- EN Electronic battery charger
- PL Prostownik elektroniczny
- DE Elektronisches Ladegerät
- RU Электронное зарядное устройство
- CZ Elektronická nabíječka
- RO Redresor electric
- HU Elektronikus akkumulátortöltő
- ES Cargador de batería para coche



max 8A CHARGING CURRENT PRĄD ŁADOWANIA	230V~ 50Hz
6V	12V
5.8 A	12-120 Ah
WET MOKRY	LED DISPLAY WYŚWIETLACZ



No.	Charging voltage / Napięcie ładowania [V d.c.]	Charging current / Prąd ładowania [A]	Charging battery capacity / Pojemność ładowanego akumulatora [Ah]	
82543	6/12	5.8	12-120	5

- EN Battery tester
- PL Tester akumulatorów
- DE Batterieprüfgerät
- RU Тестер аккумуляторов
- CZ Tester akumulátorů
- RO Tester acumulatori
- HU Akkuteszter
- ES Tester para acumuladores



12V	BATTERY TEST TEST AKU- MULATORA	ALTERNATOR TEST TEST ALTERNATORA	
------------	--	--	--



No.	
81741	24/48

- EN Pressure gauge
- PL Wskaźnik ciśnienia
- DE Druckanzeige
- RU Манометр
- CZ Tlakomer
- RO Manometru
- HU Nyomásmérő
- ES Manómetro

0.05-0.75 MPa	
-------------------------	--



No.	Measuring range / Zakres pomiaru [MPa/bar]	
82650	0.05-0.75 / 0.5-7.5	25/50

- EN Electronic battery charger
- PL Prostownik elektroniczny
- DE Elektronisches Ladegerät
- RU Электронное зарядное устройство
- CZ Elektronická nabíječka
- RO Redresor electric
- HU Elektronikus akkumulátortöltő
- ES Cargador de batería para coche



max 12A CHARGING CURRENT PRĄD ŁADOWANIA	230V~ 50Hz
6V	12V
10.3 A	26-210 Ah
WET MOKRY	LED DISPLAY WYŚWIETLACZ



No.	Charging voltage / Napięcie ładowania [V d.c.]	Charging current / Prąd ładowania [A]	Charging battery capacity / Pojemność ładowanego akumulatora [Ah]	
82544	6/12	10.3	26-210	5

- EN Pressure gauge
- PL Wskaźnik ciśnienia
- DE Druckanzeige
- RU Манометр
- CZ Tlakomer
- RO Manometru
- HU Nyomásmérő
- ES Manómetro



0.05-0.75 MPa	
-------------------------	--



No.	Measuring range / Zakres pomiaru [MPa/bar]	
82610	0.05-0.75 / 0.5-7.5	25/150

- EN Pressure gauge
- PL Wskaźnik ciśnienia
- DE Druckanzeige
- RU Манометр
- CZ Tlakomer
- RO Manometru
- HU Nyomásmérő
- ES Manómetro



0.05-0.3 MPa	
------------------------	--



No.	Measuring range / Zakres pomiaru [MPa/bar]	
82611	0.05-0.3 / 0.5-3	10

- EN Chain block
- PL Wyciągarka łańcuchowa
- DE Kettenzug Flaschenzug
- RU Таль цепная
- CZ Zvedák řetězový
- RO Scripete cu lant
- HU Láncos csigaszor emelő
- ES Cabría de cadena



--



No.	Max. load capacity / Maks. obciążenie [kg]	Chain length / Długość łańcucha [m]	
80751	1000	3	1
80752	2000	3	1
80753	3000	3	1

EN Car air compressor
 PL Kompresor samochodowy
 DE Auto-Kompressor
 RU Автомобильный компрессор
 CZ Automobilový kompresor
 RO Compresor auto
 HU Autókompresszor
 ES Compresor de coche

12V 10A 1.7 MPa (max)



VOREL

No.	Voltage / Napiecie [V d.c.]	
82100	12	12

EN Car air compressor
 PL Kompresor samochodowy
 DE Auto-Kompressor
 RU Автомобильный компрессор
 CZ Automobilový kompresor
 RO Compresor auto
 HU Autókompresszor
 ES Compresor de coche

120 W 12V 35 l/min
 1.0 MPa 1 m 3 m



STMOR

No.	Voltage / Napiecie [V d.c.]	Power / Moc [W]	
82107	12	120	8

EN Air wedge
 PL Poduszka montażowa
 DE Luft Keil
 RU Монтажная подушка
 CZ Rozpínací montážní polštář
 RO Perna de aer
 HU Emelőpárna
 ES Cojines elevadores

50 mm max 135 kg
 TPU



VOREL

No.	Size / Rozmiar [mm]	
39000	160x160	120
39001	190x115	120
39002	130x270	60

EN Rechargeable air compressor
 PL Kompresor bezprzewodowy
 DE Kabelloser Kompressor
 RU Беспроводной компрессор
 CZ Bezdrátový kompresor
 RO Compresor de aer cu acumulator
 HU Vezeték nélküli kompresszor
 ES Compresor inalámbrico

0.69 MPa 25 l/min 7.4 V 2000mAh
 4-6h 40 cm USB CHARGING LADOWANIE



STMOR

No.	Battery voltage / Napiecie akumulatora [V d.c.]	
82120	7.4	20

EN Tire bags
 PL Worki na opony
 DE Reifensäcke
 RU Пакеты для шин
 CZ Pytle na pneumatiky
 RO Saci pt. cauciucuri auto
 HU Gumiabroncs tároló zsák
 ES Bolsas para neumáticos

8 PCS 180L 30 µm LDPE



VOREL

No.	Capacity / Pojemność [l]	Thickness / Grubość [µm]	pcs / szt.	
56991	180	30	8	25

EN Air pump wedge set
 PL Zestaw poduszek montażowych
 DE Montagekissen-Set
 RU Набор монтажных подушек
 CZ Rozpínací polštářky
 RO Set perne de aer
 HU Szerelőpárna készlet
 ES Juego de bolsas de cuña de aire

2 PCS 50 mm max 135 kg
 TPU



VOREL

No.	Size / Rozmiar [mm]	pcs / szt.	
39005	190x115, 130x270	2	60

EN Tow rope
 PL Linka holownicza
 DE Abschleppseil
 RU Трос буксировочный
 CZ Tažné lano
 RO Șufă pt. remorcare
 HU Vontató kötél
 ES Cuerda de remolque



No.	Gross vehicle mass GVM / Dopuszczalna masa całkowita pojazdu DMC [kg]	
82201	1500	20

EN Tow rope
 PL Linka holownicza
 DE Abschleppseil
 RU Трос буксировочный
 CZ Tažné lano
 RO Șufă pt. remorcare
 HU Vontató kötél
 ES Cuerda de remolque



No.	Gross vehicle mass GVM / Dopuszczalna masa całkowita pojazdu DMC [kg]	
82209	2500	8

EN Tow rope
 PL Linka holownicza
 DE Abschleppseil
 RU Трос буксировочный
 CZ Tažné lano
 RO Șufă pt. remorcare
 HU Vontató kötél
 ES Cuerda de remolque



No.	Gross vehicle mass GVM / Dopuszczalna masa całkowita pojazdu DMC [kg]	
82206	3500	12

EN Tow strap
 PL Taśma holownicza
 DE Abschleppgurt
 RU Трос буксировочный
 CZ Tažný pás
 RO Șufă pt. remorcare
 HU Vontató heveder
 ES Cinta de remolque



No.	Gross vehicle mass GVM / Dopuszczalna masa całkowita pojazdu DMC [kg]	
82232	2500	16

EN Tow rope
 PL Linka holownicza
 DE Abschleppseil
 RU Трос буксировочный
 CZ Tažné lano
 RO Șufă pt. remorcare
 HU Vontató kötél
 ES Cuerda de remolque



No.	Gross vehicle mass GVM / Dopuszczalna masa całkowita pojazdu DMC [kg]	
82205	2500	10

EN Tow rope
 PL Linka holownicza
 DE Abschleppseil
 RU Трос буксировочный
 CZ Tažné lano
 RO Șufă pt. remorcare
 HU Vontató kötél
 ES Cuerda de remolque



No.	Gross vehicle mass GVM / Dopuszczalna masa całkowita pojazdu DMC [kg]	
82200	3500	12

EN Tow rope
 PL Linka holownicza
 DE Abschleppseil
 RU Трос буксировочный
 CZ Tažné lano
 RO Șufă pt. remorcare
 HU Vontató kötél
 ES Cuerda de remolque

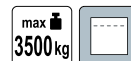

No.	Gross vehicle mass GVM / Dopuszczalna masa całkowita pojazdu DMC [kg]	
82227	3500	20

EN Tow strap
 PL Taśma holownicza
 DE Abschleppgurt
 RU Трос буксировочный
 CZ Tažný pás
 RO Șufă pt. remorcare
 HU Vontató heveder
 ES Cinta de remolque

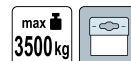

No.	Gross vehicle mass GVM / Dopuszczalna masa całkowita pojazdu DMC [kg]	
82234	3500	12

EN Tow strap
 PL Taśma holownicza
 DE Abschleppgurt
 RU Трос буксировочный
 CZ Tažný pás
 RO Șulă pt. remorcare
 HU Vontató heveder
 ES Cinta de remolque



No.	Gross vehicle mass GVM / Dopuszczalna masa całkowita pojazdu DMC [kg]	Box icon
82231	1500	20

EN Battery clamps cleaner
 PL Szczotka do czyszczenia klem
 DE Klemmbürste
 RU Щетка для зачистки клемм
 CZ Kartáč pro čištění svorek
 RO Perie curatat borne auto
 HU Akkumulátorsaru tisztító kefe
 ES Cepillo para limpiar bornes



No.	Box icon
82440	10/160

EN Battery clamps
 PL Zestaw klem do akumulatora
 DE Akku-Polklemmen
 RU Клеммы аккумуляторные
 CZ Sada svorek na akumulátor
 RO Set borne acumulator
 HU Akkumulátorsaru készlet
 ES Juego de bornes para acumulador



No.	pcs / szt.	Box icon
82431	2	12/120

EN Boosters cables
 PL Wiązka przewodów awaryjnych
 DE Starthilfekabel
 RU Старт-кабель
 CZ Spouštěcí kabele
 RO Cabluri pomire auto
 HU Indítókábel
 ES Pinzas de arranque



No.	Rated load / Obciążenie nominalne [A]	Box icon
82504	400	6
82506	600	6

EN Tow strap
 PL Taśma holownicza
 DE Abschleppgurt
 RU Трос буксировочный
 CZ Tažný pás
 RO Șulă pt. remorcare
 HU Vontató heveder
 ES Cinta de remolque

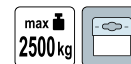

No.	Gross vehicle mass GVM / Dopuszczalna masa całkowita pojazdu DMC [kg]	Box icon
82233	2500	16

EN Battery clamps cleaner
 PL Szczotka do czyszczenia klem
 DE Klemmbürste
 RU Щетка для зачистки клемм
 CZ Kartáč pro čištění svorek
 RO Perie curatat borne auto
 HU Akkumulátorsaru tisztító kefe
 ES Cepillo para limpiar bornes



No.	Box icon
82445	10/100

EN Battery hydrometer
 PL Próbnik akumulatorowy
 DE Batteriesäureprüfer
 RU Ареометр аккумуляторный
 CZ Akumulátorový zkoušeč
 RO Instrument de verificare acumulator
 HU Akkumulátorpróbbáló
 ES Probador de acumulador



No.	Box icon
82520	10/100

EN Window squeegee
 PL Guma do szyb z drewnianą rączką
 DE Scheibenreiniger-Holzstiel
 RU Стеклоочиститель с резинкой
 CZ Guma do skel z dřevěnou rukojetí
 RO Dispozitiv cu mâner pt. spălat geamuri
 HU Vízlehúzó gumi fa nyéllel
 ES Goma para cristales con mango de madera



No.	Box icon
82920	50

EN Flexible funnel
 PL Lejek
 DE Trichter
 RU Воронка гибкая
 CZ Nálevka
 RO Pálnie
 HU Kétrészes tölcser
 ES Embudo



No.		
83000		30

EN Flexible funnel
 PL Lejek
 DE Trichter
 RU Воронка гибкая
 CZ Nálevka
 RO Pálnie
 HU Kétrészes tölcser
 ES Embudo



No.		
83002		30

EN Agricultural funnel
 PL Lejek rolniczy
 DE Trichter
 RU Воронка гибкая
 CZ Nálevka
 RO Pálnie
 HU Kétrészes tölcser
 ES Embudo



No.	Ø [mm]	
83004	210	25

EN Angled funnel with strainer
 PL Lejek skośny z sitkiem
 DE Schräger Trichter mit Sieb
 RU Наклонная воронка с фильтром
 CZ Třuchtýř šikmý se sítkem
 RO Pálnie înclinată cu sită
 HU Ferde tölcser szűrővel
 ES Embudo oblicuo con filtro



No.	Ø [mm]	
83017	130	70

EN Flexible funnel
 PL Lejek
 DE Trichter
 RU Воронка гибкая
 CZ Nálevka
 RO Pálnie
 HU Kétrészes tölcser
 ES Embudo



No.		
83001		30

EN Agricultural funnel
 PL Lejek rolniczy
 DE Trichter
 RU Воронка гибкая
 CZ Nálevka
 RO Pálnie
 HU Kétrészes tölcser
 ES Embudo



No.	Ø [mm]	
83003	210	25

EN Angled funnel with strainer
 PL Lejek skośny z sitkiem
 DE Schräger Trichter mit Sieb
 RU Наклонная воронка с фильтром
 CZ Třuchtýř šikmý se sítkem
 RO Pálnie înclinată cu sită
 HU Ferde tölcser szűrővel
 ES Embudo oblicuo con filtro



No.	Ø [mm]	
83016	130	70

EN Angled funnel with strainer
 PL Lejek skośny z sitkiem
 DE Schräger Trichter mit Sieb
 RU Наклонная воронка с фильтром
 CZ Třuchtýř šikmý se sítkem
 RO Pálnie înclinată cu sită
 HU Ferde tölcser szűrővel
 ES Embudo oblicuo con filtro



No.	Ø [mm]	
83018	130	70

EN Funnel
 PL Lejek
 DE Trichter
 RU Воронка гибкая

CZ Nálevka
 RO Pâlnie
 HU Kétrészes tölcsér
 ES Embudo



No.	Ø [mm]	H [mm]	pcs / szt.	
83005	52, 76, 100, 120	75, 110, 125, 152	4	30

EN Car vacuum cleaner
 PL Odkurzacz samochodowy
 DE Handsauger
 RU Ручной пылесос для автомобиля
 CZ Vysavač do auta
 RO Aspirator de mașină
 HU Autó porszívó
 ES Aspirador para coche



No.	Voltage / Napiecie [V d.c.]	Power / Moc [W]	
82952	12	100	20

EN Car vacuum cleaner
 PL Odkurzacz samochodowy
 DE Handsauger
 RU Ручной пылесос для автомобиля
 CZ Vysavač do auta
 RO Aspirator de mașină
 HU Autó porszívó
 ES Aspirador para coche



No.	Voltage / Napiecie [V d.c.]	Power / Moc [W]	
82967	12	100	9

EN Rechargeable car vacuum cleaner
 PL Odkurzacz samochodowy bezprzewodowy
 DE Kabelloser Auto-Staubsauger
 RU Беспроводной пылесос автомобиля
 CZ Bezdrátový automobilový vysavač
 RO Aspirator de mașină cu acumulator
 HU Vezeték nélküli autós porszívó
 ES Aspirador de coche inalámbrico



No.	Battery voltage / Napiecie akumulatora [V d.c.]	Power / Moc [W]	
82955	7.4	60	30

EN Car vacuum cleaner
 PL Odkurzacz samochodowy
 DE Handsauger
 RU Ручной пылесос для автомобиля
 CZ Vysavač do auta
 RO Aspirator de mașină
 HU Autó porszívó
 ES Aspirador para coche



No.	Voltage / Napiecie [V d.c.]	Vacuum cleaner power / Moc odkurzacza [W]	Compressor power / Moc kompresora [W]	
82953	12	80	120	12

EN Car vacuum cleaner
 PL Odkurzacz samochodowy
 DE Handsauger
 RU Ручной пылесос для автомобиля
 CZ Vysavač do auta
 RO Aspirator de mașină
 HU Autó porszívó
 ES Aspirador para coche

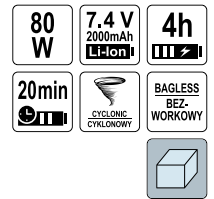

No.	Voltage / Napiecie [V d.c.]	Power / Moc [W]	
82954	7.4	80	20

EN Rechargeable car vacuum cleaner
 PL Odkurzacz samochodowy bezprzewodowy
 DE Kabelloser Auto-Staubsauger
 RU Беспроводной пылесос автомобиля
 CZ Bezdrátový automobilový vysavač
 RO Aspirator de mașină cu acumulator
 HU Vezeték nélküli autós porszívó
 ES Aspirador de coche inalámbrico



100 W	2600 mAh Li-Ion
5-6h	15-18 min
USB BATTERY CHARGER ŁADOWNIKA	CYCLONIC CYKLONOWY
BAGLESS BEZ- WORKOWY	



STOR

No.	Voltage / Napięcie [V d.c.]	Power / Moc [W]	
82970	5	100	9

EN First aid kit
 PL Apteczka samochodowa
 DE Verbandkasten
 RU Аптечка автомобильная

CZ Příruční lékárnička první pomoci
 RO Trusă medicală de prim-ajutor
 HU Elsősegély doboz
 ES Botiquín



No.	Type / Typ	
83260	E-01	10

EN Warning triangle
 PL Trójkąt ostrzegawczy
 DE Warndreieck
 RU Знак аварийной остановки
 CZ Výstražný trojúhelník
 RO Triunghi reflectorizant
 HU Elakadásjelző háromszög
 ES Triángulo de emergencia



No.	
83280	40

EN License plate frame
 PL Ramka pod tablicę rejestracyjną
 DE Kennzeichenhalter
 RU Рамка номерного знака

CZ Rámeček pod SPZ
 RO Cadru pt. plăcuțe de înmatriculare
 HU Rendszámtábla keret
 ES Portamatriculas



VOREL

No.	Dimensions / Wymiary [mm]	
83291	529x132x11	50

EN Rechargeable car vacuum cleaner
 PL Odkurzacz samochodowy bezprzewodowy
 DE Kabelloser Auto-Staubsauger
 RU Беспроводной пылесос автомобиля
 CZ Bezdrátový automobilový vysavač
 RO Aspirator de mașină cu acumulator
 HU Vezeték nélküli autós porszívó
 ES Aspirador de coche inalámbrico



100 W	2600 mAh Li-Ion
5-6h	15-18 min
USB BATTERY CHARGER ŁADOWNIKA	CYCLONIC CYKLONOWY
BAGLESS BEZ- WORKOWY	



STOR

No.	Voltage / Napięcie [V d.c.]	Power / Moc [W]	
82971	5	100	9

EN First aid kit
 PL Apteczka samochodowa
 DE Verbandkasten
 RU Аптечка автомобильная
 CZ Příruční lékárnička první pomoci
 RO Trusă medicală de prim-ajutor
 HU Elsősegély doboz
 ES Botiquín



No.	Type / Typ	
83262	E-03	5

EN License plate frame
 DE Kennzeichenhalter
 RU Рамка номерного знака

CZ Rámeček pod SPZ
 RO Cadru pt. plăcuțe de înmatriculare
 HU Rendszámtábla keret
 ES Portamatriculas



VOREL

No.	Dimensions / Wymiary [mm]	
83290	529x132x11	50

EN Elastic tie down
 PL Spinacz bagażu
 DE Gepäckspinnensatz
 RU Стяжка для багажа
 CZ Elastické spínatka
 RO Cordelină elastică pt. bagaje
 HU Csomagrögzítő pók
 ES Pulpo 8-ramion

Ø 8.0 mm	80 cm	X8 HOOKS HAKI	
----------	-------	---------------------	--



No.	L [cm]	Ø [mm]	Arm quantity / Liczba ramion	
82300	80	8	8	25/50

- EN Elastic straps
 PL Ściągacze elastyczne
 DE Gummispannseil
 RU Стяжка для багажа
- CZ Elastické spínatka
 RO Cordelină elastică pt. bagaje
 HU Rugalmas feszítő
 ES Pulpos



VOREL

No.	L [cm]	Ø [mm]	pcs / szt.	
82308	80	8	2	20/80
82310	100	8	2	20/80
82315	150	8	2	25/50
82320	200	8	2	25/50

- EN Elastic tie down
 PL Spinacz bagażu
 DE Gepäckspinnensatz
 RU Стяжка для багажа
 CZ Elastické spínatka
 RO Cordelină elastică pt. bagaje
 HU Csomagrögzítő pök
 ES Pulpo 8-ramion

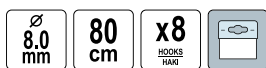

VOREL

No.	L [cm]	Ø [mm]	Arm quantity / Liczba ramion	
82301	80	8	8	25/50

- EN Elastic straps
 PL Płaskie ściągacze elastyczne
 DE Gummispannseil
 RU Стяжка для багажа
 CZ Elastické spínatka
 RO Cordelină elastică pt. bagaje
 HU Rugalmas feszítő
 ES Pulpos



VOREL

No.	L [cm]	pcs / szt.	
82360	80	2	25/50
82370	100	2	20/80

- EN Ratchet tie down
 PL Taśma do bagażu ze sprzączką
 DE Spanngurt
 RU Ремень для крепления груза с зажимом фиксатором
 CZ Pás na zavazadla
 RO Cordelina pt. bagaje cu clichet
 HU Csomagrögzítő pánt
 ES Cintas para equipaje



VOREL

No.	L [m]	W [mm]	
82341	5	25	12/48



- EN Elastic straps
 PL Ściągacze elastyczne
 DE Gummispannseil
 RU Стяжка для багажа
 CZ Elastické spínatka
 RO Cordelină elastică pt. bagaje
 HU Rugalmas feszítő
 ES Pulpos



VOREL

No.	L [cm]	Ø [mm]	pcs / szt.	
82305	120	12	2	12/24

- EN Ratchet tie down
 PL Taśma do bagażu ze sprzączką
 DE Spanngurt
 RU Ремень для крепления груза с зажимом фиксатором
 CZ Pás na zavazadla
 RO Cordelina pt. bagaje cu clichet
 HU Csomagrögzítő pánt
 ES Cintas para equipaje

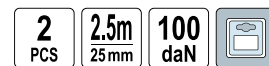

VOREL

No.	L [m]	W [mm]	pcs / szt.	
82331	2.5	25	2	10/80

- EN Ratchet tie down
 PL Taśma do bagażu
 DE Spanngurt
 RU Ремень для крепления багажа с трехоткой
 CZ Pás na zavazadla z napínáním
 RO Cordelina pt. bagaje cu clichet
 HU Csomagrögzítő pánt feszítővel
 ES Cinta para equipaje con carraca



No.	L [m]	W [mm]	Lashing capacity / Zdolność mocowania [daN]	
82377	2	35	1000	10
82378	4	35	1000	10
82379	6	35	1000	10
82380	8	35	1000	10

- EN Ratchet tie down
- PL Taśma do bagażu
- DE Spanngurt
- RU Ремень для крепления багажа с трещоткой
- CZ Pás na zavazadla z napínáním
- RO Cordelina pt. bagaje cu clicheț
- HU Csomagrögzítő pánt feszítővel
- ES Cinta para equipaje con carraca

2
PCS



No.	L [m]	W [mm]	Lashing capacity / Zdolność mocowania [daN]	
82372	4	50	1600	8
82373	6	50	1600	7
82374	8	50	1600	6
82375	10	50	1600	5
82384	6	50	2000	6
82386	8	50	2000	6
82388	10	50	2000	5
82390	12	50	2000	5

- EN Ratchet tie down
- PL Taśma do bagażu
- DE Spanngurt
- RU Ремень для крепления багажа с трещоткой
- CZ Pás na zavazadla z napínáním
- RO Cordelina pt. bagaje cu clicheț
- HU Csomagrögzítő pánt feszítővel
- ES Cinta para equipaje con carraca



2
PCS



- EN Ratchet tie down
- PL Taśma do bagażu
- DE Spanngurt
- RU Ремень для крепления багажа с трещоткой
- CZ Pás na zavazadla z napínáním
- RO Cordelina pt. bagaje cu clicheț
- HU Csomagrögzítő pánt feszítővel
- ES Cinta para equipaje con carraca



No.	L [m]	W [mm]	Lashing capacity / Zdolność mocowania [daN]	
82392	6	50	2500	6
82393	8	50	2500	6
82395	12	50	2500	5

2
PCS



14



No.	L [m]	W [mm]	Lashing capacity / Zdolność mocowania [daN]	
82401	2	38	1000	12
82402	4	38	1000	12
82403	6	38	1000	12
82404	8	38	1000	12
82405	4	50	1500	6
82406	6	50	1500	6
82407	8	50	1500	6
82408	10	50	1500	6

- EN Ratchet tie down
- PL Taśma do bagażu
- DE Spanngurt
- RU Ремень для крепления багажа с трещоткой
- CZ Pás na zavazadla z napínáním
- RO Cordelina pt. bagaje cu clicheț
- HU Csomagrögzítő pánt feszítővel
- ES Cinta para equipaje con carraca

5m
25mm



No.	L [m]	W [mm]	
82351	5	25	12/48

No.	L [m]	W [mm]	Lashing capacity / Zdolność mocowania [daN]	
82409	6	50	2000	6
82410	8	50	2000	6
82411	10	50	2000	6
82412	12	50	2000	6
82413	6	50	2500	6
82414	8	50	2500	6
82415	10	50	2500	6

- EN Ratchet tie down
- PL Taśma do bagażu
- DE Spanngurt
- RU Ремень для крепления багажа с трещоткой
- CZ Pás na zavazadla z napínáním
- RO Cordelina pt. bagaje cu clicheț
- HU Csomagrögzítő pánt feszítővel
- ES Cinta para equipaje con carraca

2
PCS

5m
25mm

125
daN



No.	L [m]	W [mm]	pcs / szt.	
82400	5	25	2	8/16

EN Ratchet tie down
 PL Taśma do bagażu
 DE Spanngurt
 RU Ремень для крепления багажа с трещоткой
 CZ Pás na zavazadla z napínáním
 RO Cordelina pt. bagaje cu clichet
 HU Csomagrögzítő pánt feszítővel
 ES Cinta para equipaje con carraca



No.	L [m]	W [mm]	Lashing capacity / Zdolność mocowania [daN]	
82343	4	25	1000	20

EN Webbing sling
 PL Zawiesz pasowe
 DE Flachgewebtes Hebeband
 RU Строп текстильный ленточный
 CZ Zvedací pás
 RO Chingă de ridicare
 HU Emelő heveder
 ES Eslinga plana

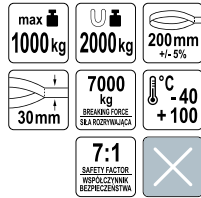

No.	L [m]	
82265	1 (± 3%)	100
82266	2 (± 3%)	60
82267	3 (± 3%)	50

EN Webbing sling
 PL Zawiesz pasowe
 DE Flachgewebtes Hebeband
 RU Строп текстильный ленточный
 CZ Zvedací pás
 RO Chingă de ridicare
 HU Emelő heveder
 ES Eslinga plana



No.	L [m]	
82280	3 (± 3%)	15
82281	4 (± 3%)	12
82282	6 (± 3%)	9

EN Ratchet tie down
 PL Taśma do bagażu
 DE Spanngurt
 RU Ремень для крепления багажа с трещоткой
 CZ Pás na zavazadla z napínáním
 RO Cordelina pt. bagaje cu clichet
 HU Csomagrögzítő pánt feszítővel
 ES Cinta para equipaje con carraca



No.	L [m]	W [mm]	Lashing capacity / Zdolność mocowania [daN]	
82397	5	25	500	20

EN Webbing sling
 PL Zawiesz pasowe
 DE Flachgewebtes Hebeband
 RU Строп текстильный ленточный
 CZ Zvedací pás
 RO Chingă de ridicare
 HU Emelő heveder
 ES Eslinga plana



No.	L [m]	
82270	1 (± 3%)	50
82271	2 (± 3%)	30
82272	3 (± 3%)	25
82273	4 (± 3%)	20
82274	5 (± 3%)	15
82275	6 (± 3%)	15

EN Customs securing rope
 PL Linka celna stalowa
 DE Zollschnur aus Stahl
 RU Стальная таможенный трос
 CZ Ocelové celní lanko
 RO Cablu vamal
 HU Acél árubiztosító kótél
 ES Cable de acero de seguridad



No.	Ø [mm]	L [m]	
85000	6	15	12
85001	6	16	12
85002	6	18	12
85003	6	34	12
85004	6	36	12
85005	6	42	10

EN Luggage net
 PL Siatka organizer z hakami do bagażnika
 DE Organizer Gepäcknetz mit Haken für Kofferraum
 RU Сетка-органайзер с крючками для багажника
 CZ Sítka organizér zavazadlového prostoru s háčky
 RO Plasa pt. bagaje
 HU Rendszerező csomagtartó háló kampókkal
 ES Red organizador con ganchos para maletero

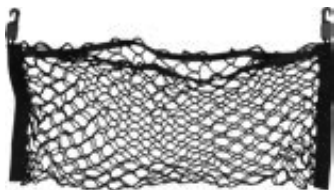

No.	Size / Rozmiar [mm]	
82260	700x300	24

EN Luggage net
 PL Siatka organizer do bagażnika z hakami
 DE Organizer Gepäcknetz mit Haken für Kofferraum
 RU Сетка-органайзер для багажника с крючками
 CZ Sítka organizér zavazadlového prostoru s háčky
 RO Plasa pt. bagaje
 HU Rendszerező csomagtartó háló kampókkal
 ES Red organizador para maletero, con ganchos

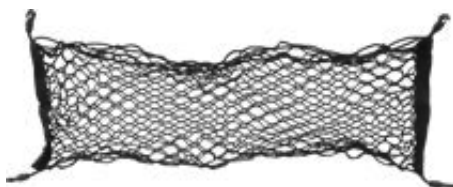

No.	Size / Rozmiar [mm]	
82262	900x300	50

EN Luggage net
 PL Siatka do bagażnika z hakami
 DE Gepäcknetz mit Haken für Kofferraum
 RU Сетка с крючками для багажника
 CZ Sítka do zavazadlového prostoru s háčky
 RO Plasa pt. bagaje
 HU Csomagtartó háló kampókkal
 ES Red con ganchos para maletero

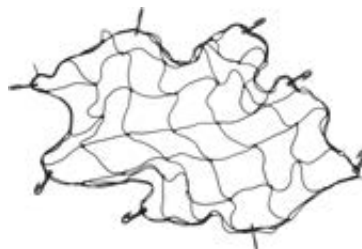

No.	Size / Rozmiar [mm]	
82261	900x900	50

EN Elastic tie down
 PL Ściągacze elastyczne z karabińczykiem
 DE Elastische Abzieher mit Karabinerhaken
 RU Эластичные шнуры для затягивания с карабином
 CZ Elastické stahovky s karabinkou
 RO Cordelină elastică cu carabină
 HU Rugalmas kötél karabinerekkel
 ES Elásticos con mosquetón

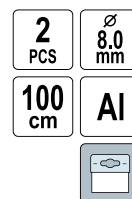

No.	Ø [mm]	L [mm]	pcs / szt.	
82322	8	1000	2	30

Memo

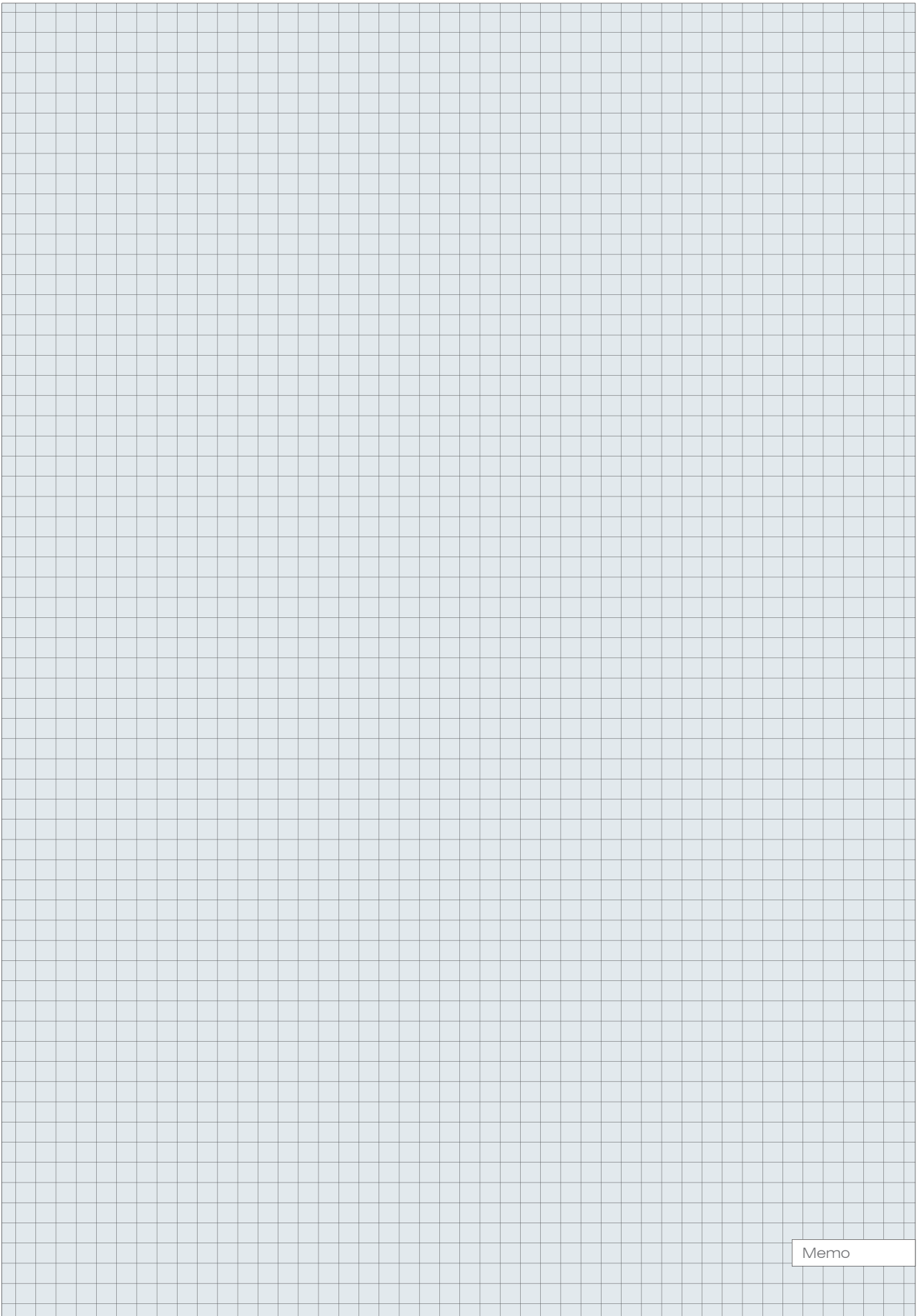

Memo

15

Power tools & accessories
Elektronarzędzia i akcesoria



Power tools STHOR
Elektronarzędzia STHOR

250-259

Impact drills	
Wiertarki udarowe.....	250
Rotary hammers	
Młoty udarowe.....	250
Cordless tools	
Urządzenia akumulatorowe.....	251
Angle grinders	
Szlifierki kątowe.....	256
Orbital sanders	
Szlifierki mimośrodowe.....	257
Finishing sanders	
Szlifierki oscylacyjne.....	257
Circular saws	
Pilarki tarczowe.....	257
Planers	
Strugi.....	257
Hot air guns	
Opalarki.....	258
Glue guns	
Pistolety do klejenia.....	258
Soldering guns	
Lutownice.....	259
Paint & mortar mixers	
Mieszarki do zapraw i farb.....	259
Water pumps	
Pompy wodne.....	259

Power tools LUND
Elektronarzędzia LUND

260-261

Knives for polystyrene foam	
Noże do styropianu.....	260
Car polishers	
Polerki samochodowe.....	260
Hot air guns	
Opalarki.....	260
Glue guns	
Pistolety do klejenia.....	260
Soldering guns	
Lutownice.....	261

**Power tools FLO
Elektronarzędzia FLO**

.....262-264



Water pumps

Pompy wodne..... 262

Hedge shears

Nożyce do żywopłotu..... 263

Chainsaws

Piłarki łańcuchowe..... 264

Soil millers

Glebogryzarki..... 264

Scarifiers

Wertykulatory..... 264

**Power tools
Elektronarzędzia**

.....266



Soldering guns

Lutownice..... 266

Accessories
Akcesoria

266-275

Accessories chainsaws	
Akcesoria do pił łańcuchowych.....	266
Accessories gasoline	
Akcesoria do do narzędzi spalinowych.....	266
Grass trimmer lines	
Żyłki tnące do podkaszarek.....	266
Drill chucks	
Uchwyty wiertarskie.....	270
Adapters	
Adaptory.....	271
Drill bit sharpeners	
Ostrzałki do wiertel.....	271
Stands for power tools	
Statywy do elektronarzędzi.....	271
Spare blades, brushes, etc. for power tools	
Zapassowe ostrza, szczotki, końcówki do elektronarzędzi.....	271
Soldering iron accessories	
Akcesoria do lutownic.....	272
Gasoline water pump accessories	
Akcesoria do pomp spalinowych.....	275

EN Impact drill
 PL Wiertarka udarowa
 DE Schlagbohrmaschine
 RU Ударная дрель
 CZ Příkladová vrtačka
 RO Bormașină cu percuteție
 HU Útvefűró
 ES Taladro de percusión



$L_{pa} = 90,0 \pm 3,0$ dB; $L_{wa} = 101,0 \pm 3,0$ dB; $a_n = 2,39 \pm 1,5 / 7,67 \pm 1,5$ m/s²

No.	Power / Moc [W]	ω [min ⁻¹]	
78992	600	0-3000	10

EN Impact drill
 PL Wiertarka udarowa
 DE Schlagbohrmaschine
 RU Ударная дрель
 CZ Příkladová vrtačka
 RO Bormașină cu percuteție
 HU Útvefűró
 ES Taladro de percusión

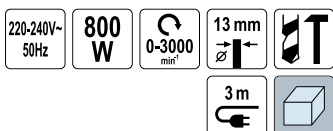

$L_{pa} = 98,06 \pm 3,0$ dB; $L_{wa} = 109,06 \pm 3,0$ dB; $a_n = 5,726 \pm 1,5 / 17,116 \pm 1,5$ m/s²

No.	Power / Moc [W]	ω [min ⁻¹]	
78997	800	0-3000	10

EN Rotary hammer
 PL Młotowiertarka
 DE Bohrhammer
 RU Перфоратор
 CZ Vrtací kladivo
 RO Ciocan rotopercurtor
 HU Fúrókalapács
 ES Martillo perforador



$L_{pa} = 92,0 \pm 3,0$ dB; $L_{wa} = 103,0 \pm 3,0$ dB; $a_n = 11,376 \pm 1,5 / 9,657 \pm 1,5$ m/s²

No.	Power / Moc [W]	ω [min ⁻¹]	
79054	620	0-870	5

EN Impact drill
 PL Wiertarka udarowa
 DE Schlagbohrmaschine
 RU Ударная дрель
 CZ Příkladová vrtačka
 RO Bormașină cu percuteție
 HU Útvefűró
 ES Taladro de percusión

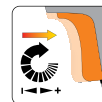
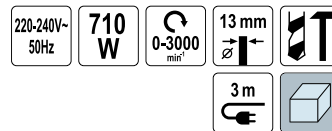

$L_{pa} = 98,06 \pm 3,0$ dB; $L_{wa} = 109,06 \pm 3,0$ dB; $a_n = 5,726 \pm 1,5 / 17,116 \pm 1,5$ m/s²

No.	Power / Moc [W]	ω [min ⁻¹]	
78995	710	0-3000	10

EN Rotary hammer
 PL Młotowiertarka
 DE Bohrhammer
 RU Перфоратор
 CZ Vrtací kladivo
 RO Ciocan rotopercurtor
 HU Fúrókalapács
 ES Martillo perforador

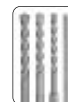

$L_{pa} = 92,3 \pm 3,0$ dB; $L_{wa} = 103,3 \pm 3,0$ dB; $a_n = 11,376 \pm 1,5 / 9,657 \pm 1,5$ m/s²

No.	Power / Moc [W]	ω [min ⁻¹]	
79049	500	0-850	5

EN Cordless drill/driver
 PL Akumulatorowa wiertarko-wkrętarka
 DE Akku-Bohrschrauber
 RU Аккумуляторная дрель-шуруповёрт
 CZ Akumulátorový vrtací šroubovák
 RO Mașină de găurit și înșurubat cu acumulator
 HU Akkus fúró-csavarozó
 ES Taladro atornillador a batería

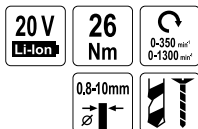

$L_{pa} = 70,3 \pm 5,0$ dB; $L_{wa} = 81,3 \pm 5,0$ dB; $a_n = 2,368 \pm 1,5$ m/s²

No.	Voltage / Napięcie [V d.c.]	∅ [min⁻¹]	Toolholder size / Rozmiar uchwyty narzędziowego [mm]	Battery capacity / Pojemność akumulatora [mAh]	⌚ [h]	Battery quantity / Liczba akumulatorów w zestawie	Package	
78082	20	0-350 / 0-1300	0.8-10	2000	1	2		4
78081	20	0-350 / 0-1300	0.8-10	2000	1	1		4
78080	20	0-350 / 0-1300	0.8-10	-	-	brak		8

EN Cordless angle grinder
 PL Akumulatorowa szlifierka kątowa
 DE Akku-Winkelschleifer
 RU Аккумуляторная угловая шлифмашина
 CZ Akumulátorová úhlová bruska
 RO Polizor unghiular cu acumulator
 HU Akkus saroksziszoló
 ES Amoladora angular a batería



$L_{pa} = 85,5 \pm 3,0$ dB; $L_{wa} = 96,5 \pm 3,0$ dB; $a_n = 6,173 \pm 1,5 / 5,741 \pm 1,5$ m/s²

No.	Voltage / Napięcie [V d.c.]	∅ [min⁻¹]	Battery capacity / Pojemność akumulatora [mAh]	⌚ [h]	Battery quantity / Liczba akumulatorów w zestawie	Package
78091	20	8000	2000	1	1	
78090	20	8000	-	-	brak	

EN Cordless impact screwdriver
 PL Akumulatorowa zakrętarka udarowa
 DE Akku-Schlagschrauber
 RU Аккумуляторный ударный винтовёрт
 CZ Akumulátorový rázový utahovák
 RO Șurubelniță cu impact fără acumulator
 HU Akkus ütvecsavarozó
 ES Atornillador de impacto a batería

$L_{pa} = 75,8 \pm 3,0$ dB; $L_{wa} = 86,8 \pm 3,0$ dB; $a_n = 0,414 \pm 1,5$ m/s²

No.	Voltage / Napięcie [V d.c.]	∅ [min⁻¹]	Package
78113	20	0-2500	

EN Brushless cordless drill/driver
 PL Bezszczotkowa wiertarko-wkrętarka akumulatorowa
 DE Bürstenloser Akku-Bohrschrauber
 RU Бесщеточный аккумуляторный дрель-шуруповёрт
 CZ Bezcartáčový akumulátorový vrtací šroubovák
 RO Mașină de găurit și înșurubat cu acumulator, fără perii
 HU Akkus fúró-csavarozó szénkefe nélkül
 ES Taladro atornillador a batería sin escobillas



$L_{pa} = 75,3 \pm 5,0$ dB; $L_{wa} = 86,3 \pm 5,0$ dB; $a_n = 2,041 \pm 1,5$ m/s²

No.	Voltage / Napięcie [V d.c.]	∅ [min⁻¹]	Toolholder size / Rozmiar uchwyty narzędziowego [mm]	Battery capacity / Pojemność akumulatora [mAh]	⌚ [h]	Battery quantity / Liczba akumulatorów w zestawie	Package	
78085	20	0-450 / 0-1600	0.8-10	2000	1	1		4
78084	20	0-450 / 0-1600	0.8-10	-	-	brak		8

EN Cordless rotary hammer
 PL Akumulatorowa młotowiertarka
 DE Akku-Bohrhammer
 RU Аккумуляторный перфоратор
 CZ Akumulátorové vrtací kladivo
 RO Ciocan rotopercutor fără acumulator
 HU Akkus fúrókalapács
 ES Martillo perforador a batería

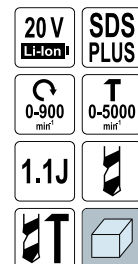

$L_{pa} = 88,0 \pm 3,0$ dB; $L_{wa} = 99,0 \pm 3,0$ dB; $a_n = 8,9 \pm 1,5$ m/s²

No.	Voltage / Napięcie [V d.c.]	∅ [min⁻¹]	Package
78107	20	0-900	

Battery not included
 Ohne Akku / Bez akumulatora
 Без аккумулятора / Bez aku
 Akumulátor nélkül /
 Fără baterie / Sans batterie
 Senza batteria / Sin batería
 没有电池

15

EN Cordless impact screwdriver
 PL Akumulatorowa zakrętarka udarowa
 DE Akku-Schlagschrauber
 RU Аккумуляторный ударный винтовёрт
 CZ Akumulátorový rázový utahovák
 RO Șurubelniță cu impact fără acumulator
 HU Akkus ütvecsavarozó
 ES Atornillador de impacto a batería

$L_{pa} = 75,8 \pm 3,0$ dB; $L_{wa} = 86,8 \pm 3,0$ dB; $a_n = 0,414 \pm 1,5$ m/s²

No.	Voltage / Napięcie [V d.c.]	∅ [min⁻¹]	Package
78113	20	0-2500	

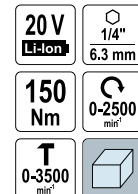

Battery not included
 Ohne Akku / Bez akumulatora
 Без аккумулятора / Bez aku
 Akumulátor nélkül /
 Fără baterie / Sans batterie
 Senza batteria / Sin batería
 没有电池

- EN Cordless circular saw
- PL Akumulatorowa pilarka tarczowa
- DE Akku-Handkreissäge
- RU Аккумуляторная циркулярная пила
- CZ Akumulátorová okružní pila
- RO Fierăstrău circular cu acumulator
- HU Akkus körfűrész
- ES Sierra circular a batería



STHOR

$L_{pA} = 85,9 \pm 3,0$ dB; $L_{wA} = 96,9 \pm 3,0$ dB; $a_n = 0,905 \pm 1,5$ m/s²

No.	Voltage / Napięcie [V d.c.]	ω [min ⁻¹]	Battery capacity / Pojemność akumulatora [mAh]	ω [h]	Battery quantity / Liczba akumulatorów w zestawie	
78133	20	4000	2000	1	1	4
78132	20	4000	-	-	brak	4

- EN Cordless sabre saw
- PL Akumulatorowa pila szablasta
- DE Akku-Sabellsäge
- RU Аккумуляторная сабельная пила
- CZ Akumulátorová pila osacka
- RO Fierăstrău sabie cu acumulator
- HU Akkus szablyafűrész
- ES Sierra sable de batería

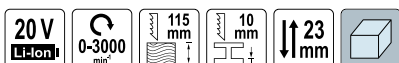

STHOR

$L_{pA} = 83,4 \pm 3,0$ dB; $L_{wA} = 94,4 \pm 3,0$ dB; $a_n = 10,847 \pm 1,5 / 9,852 \pm 1,5$ m/s²

No.	Voltage / Napięcie [V d.c.]	ω [min ⁻¹]	Battery capacity / Pojemność akumulatora [mAh]	ω [h]	Battery quantity / Liczba akumulatorów w zestawie	
78139	20	0-3000	2000	1	1	5
78138	20	0-3000	-	-	brak	5

- EN Cordless mini grinder
- PL Miniszlifierka akumulatorowa
- DE Akku-Mini-Schleifmaschine
- RU Гравер аккумуляторный
- CZ Akumulátorová mini bruska
- RO Mini freză cu acumulator
- HU Akkus mini köszörű
- ES Miniamoladora a batería



STHOR

$L_{pA} = 79,0 \pm 3,0$ dB; $L_{wA} = 90,0 \pm 3,0$ dB; $a_n = 1,177 \pm 1,5$ m/s²

No.	Voltage / Napięcie [V d.c.]	ω [min ⁻¹]	
78125	3,6	5000 / 10000 / 15000	10

- EN Cordless jig saw
- PL Akumulatorowa wyrzynarka
- DE Akku-Stichsäge
- RU Аккумуляторная лобиковая пила
- CZ Akumulátorová přimočará pila
- RO Fierăstrău pendular cu acumulator
- HU Akkus szűrőfűrész
- ES Sierra de calar a batería

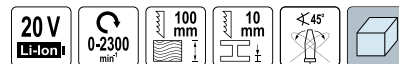

STHOR

$L_{pA} = 87,8 \pm 3,0$ dB; $L_{wA} = 98,8 \pm 3,0$ dB; $a_n = 4,372 \pm 1,5 / 6,627 \pm 1,5$ m/s²

No.	Voltage / Napięcie [V d.c.]	ω [min ⁻¹]	Battery capacity / Pojemność akumulatora [mAh]	ω [h]	Battery quantity / Liczba akumulatorów w zestawie	
78137	20	0-2300	2000	1	1	4
78136	20	0-2300	-	-	brak	6

- EN Cordless random orbital sander
- PL Szlifierka oscylacyjna akumulatorowa
- DE Akku-Schwingschleifer
- RU Аккумуляторная шлифовальная машина
- CZ Akumulátorová bruska
- RO Șlefuitor orbital fără acumulator
- HU Akkulátoros csiszoló
- ES Lijadora orbital inalámbrica



Battery not included
 Ohne Akku / Bez akumulatora
 Bez Gărnapeu / Bez aku
 Akumulátor nélkül
 Fără baterie / Sans batterie
 Senza batteria / Sin batería
 没有电池

STHOR

$L_{pA} = 77,1 \pm 3,0$ dB; $L_{wA} = 88,1 \pm 3,0$ dB; $a_n = 7,511 \pm 1,5$ m/s²

No.	Voltage / Napięcie [V d.c.]	ω [min ⁻¹]	
78143	20	5000-10000	6

- EN Cordless multi-purpose oscillating tool
- PL Akumulatorowe wielofunkcyjne narzędzie oscylacyjne
- DE Akku-Multifunktionswerkzeug
- RU Аккумуляторный многофункциональный инструмент
- CZ Akumulátorová multifunkční pila
- RO Unealtă multifuncțională fără acumulator
- HU Akkus multifunkcionális vágószerszám
- ES Multiherramienta a batería



Battery not included
 Ohne Akku / Bez akumulatora
 Bez Gărnapeu / Bez aku
 Akumulátor nélkül
 Fără baterie / Sans batterie
 Senza batteria / Sin batería
 没有电池

STHOR

$L_{pA} = 84,6 \pm 3,0$ dB; $L_{wA} = 95,6 \pm 3,0$ dB; $a_n = 16,22 \pm 1,5$ m/s²

No.	Voltage / Napięcie [V d.c.]	ω [min ⁻¹]	
78151	20	19000	6

- EN Cordless glue gun
- PL Akumulatorowy pistolet do klejenia
- DE Akku-Heißklebepistole
- RU Аккумуляторный клеевой пистолет
- CZ Akumulátorová lepicí pistole
- RO Pistol pt. lipit fără acumulator
- HU Akkus ragasztópisztoly
- ES Pistola de cola a batería



Battery not included
 Ohne Akku / Bez akumulatora
 Без батареи / Bez aku
 Akumulátor nélkül
 Fără baterie / Sans batterie
 Senza batteria / Sin batería
 没有电池



No.	Voltage / Napiecie [V d.c.]	Box icon
78155	20	10

- EN Cordless stapler
- PL Zszywacz akumulatorowy
- DE Akku-Heftgerät
- RU Стеллер аккумуляторный
- CZ Akumulátorová sponkovačka
- RO Capsator fără acumulator
- HU Akkumulátoros tűzőgép
- ES Grapadora a batería

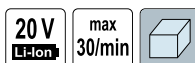

$L_{pA} = 89,6 \pm 3,0$ dB; $L_{wA} = 100,6 \pm 3,0$ dB; $a_n = 8,501 \pm 1,5$ m/s²

No.	Voltage / Napiecie [V d.c.]	Box icon
78158	20	6

- EN Cordless hedge trimmer
- PL Akumulatorowe nożyce do żywoplotu
- DE Akku-Teleskop-Heckenschere
- RU Аккумуляторный телескопический кусторез
- CZ Akumulátorové teleskopické nůžky na živý plot
- RO Foarfecă gard viu telescopică cu acumulator
- HU Akkus magassági sövénynyágó
- ES Tijera cortasetos telescópica a batería



$L_{pA} = 77,9 \pm 3,0$ dB; $L_{wA} = 87,8 \pm 3,0$ dB; $a_n = 2,55 \pm 1,5 / 2,48 \pm 1,5$ m/s²

No.	Voltage / Napiecie [V d.c.]	Cutting speed / Prędkość cięcia [min ⁻¹]	Battery capacity / Pojemność akumulatora [mAh]	Battery quantity / Liczba akumulatorów w zestawie	Box icon
78185	20	1200	2000	1	2
78184	20	1200	-	-	brak

- EN Cordless grass trimmer
- PL Akumulatorowa podkaszarka do trawy
- DE Akku-Rasentrimmer
- RU Аккумуляторный триммер
- CZ Akumulátorová strunová sekačka
- RO Trimmer de gazon cu acumulator
- HU Akkus szegélynyíró
- ES Desbrozadora a batería



$L_{pA} = 72,3 \pm 3,0$ dB; $L_{wA} = 90,0 \pm 1,96$ dB; $a_n = 3,293 \pm 1,5 / 3,117 \pm 1,5$ m/s²

No.	Voltage / Napiecie [V d.c.]	Speed [min ⁻¹]	Battery capacity / Pojemność akumulatora [mAh]	Battery quantity / Liczba akumulatorów w zestawie	Box icon
78181	20	8000	2000	1	4
78180	20	8000	-	-	brak

- EN Cordless telescopic pole saw
- PL Akumulatorowa okrzyszawarka na wysięgniku
- DE Akku-Teleskop-Hochentaster
- RU Аккумуляторный телескопический высоторез
- CZ Akumulátorová teleskopická vyvívavací pila
- RO Drujbă telescopică cu acumulator
- HU Akkus magassági ágfavágó fűrész
- ES Sierra de pértiga telescópica a batería

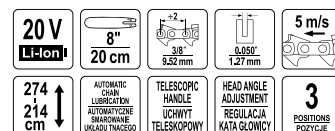

$L_{pA} = 78,2 \pm 3,0$ dB; $L_{wA} = 89,0 \pm 3,0$ dB; $a_n = 2,74 \pm 1,5 / 2,69 \pm 1,5$ m/s²

No.	Voltage / Napiecie [V d.c.]	Battery capacity / Pojemność akumulatora [mAh]	Battery quantity / Liczba akumulatorów w zestawie	Box icon
78204	20	2000	1	2
78203	20	-	-	brak

- EN Cordless mini chainsaw
- PL Akumulatorowa minipilarka łańcuchowa
- DE Mini Akku-Kettensäge
- RU Аккумуляторная цепная мини пила
- CZ Akumulatorová mini řetězová pila
- RO Mini drujbă cu acumulator
- HU Akkus mini láncfűrész
- ES Mini motosierra inalámbrica

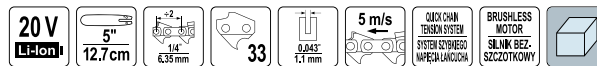

$L_{pA} = 82.0 \pm 3.0$ dB; $L_{wA} = 90.0 \pm 3.0$ dB; $a_n = 2.5 \pm 1.5$ m/s²

STHOR

No.	Voltage / Napięcie [V d.c.]	Battery capacity / Pojemność akumulatora [mAh]	⏱️ [h]	Battery quantity / Liczba akumulatorów w zestawie	📦
78211	20	2000	1	1	6
78210	20	-	-	brak	6

- EN Cordless hedge trimmer
- PL Akumulatorowe nożyce do żywoplotu
- DE Akku-Heckenschere
- RU Аккумуляторный кусторез
- CZ Akumulatorové nůžky na živý plot
- RO Foarfecă de tăiat gard viu cu acumulator
- HU Akkus sövényvágó
- ES Cortasetos inalámbrico



$L_{pA} = 81.3 \pm 3.0$ dB; $L_{wA} = 92.9 \pm 3.0$ dB; $a_n = 2.459 \pm 1.5 / 1.754 \pm 1.5$ m/s²

No.	Voltage / Napięcie [V d.c.]	Cutting speed / Prędkość cięcia [min ⁻¹]	Battery capacity / Pojemność akumulatora [mAh]	⏱️ [h]	Battery quantity / Liczba akumulatorów w zestawie	📦
78187	20	1200	2000	1	1	2
78186	20	1200	-	-	brak	2

15

- EN Cordless tool kit
- PL Zestaw narzędzi akumulatorowych
- DE Akku-Werkzeug-Set
- RU Набор аккумуляторных инструментов
- CZ Sada akumulatorového nářadí
- RO Set scule cu acumulator
- HU Akkumulátoros szerszámkészlet
- ES Conjunto de herramientas a batería



$L_{pA} = 70.3 \pm 5.0$ dB; $L_{wA} = 81.3 \pm 5.0$ dB; $a_n = 2.368 \pm 1.5$ m/s²

$L_{pA} = 85.5 \pm 3.0$ dB; $L_{wA} = 96.5 \pm 3.0$ dB; $a_n = 6.173 \pm 1.5 / 5.741 \pm 1.5$ m/s²

No.	Voltage / Napięcie [V d.c.]	⊖ [min ⁻¹]	Toolholder size / Rozmiar uchwyty narzędziowego [mm]	📦
78097	20	0-350 / 0-1300 (wierarko-wkrętarka), 8000 (szlifierka kątowna)	0.8-10	4

- EN Cordless blower
- PL Dmuchawa akumulatorowa
- DE Akku-Gebläse
- RU Воздуходувка аккумуляторная
- CZ Akumulatorový zahradní fukar
- RO Sulfantă grădină fără acumulator
- HU Akkus légfúvó
- ES Soplador a batería

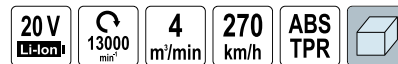

Battery not included
 Ohne Akku / Bez akumulatora
 Bez ładowarki / Bez aku
 Akumulator nešči
 Fără baterie / Sans batterie
 Senza batteria / Sin battery
 沒有電池

$L_{pA} = 76.3 \pm 3.0$ dB; $L_{wA} = 84.7 \pm 3.0$ dB; $a_n = 1.37 \pm 1.5$ m/s²

No.	Voltage / Napięcie [V d.c.]	⊖ [min ⁻¹]	📦
78190	20	13000	4

- EN Starter kit (batteries and charger)
- PL Zestaw startowy (akumulatory i ładowarka)
- DE Starter-Kit (Akkus und Ladegerät)
- RU Стартовый набор (аккумуляторы и зарядное устройство)
- CZ Startovací sada (baterie a nabíječka)
- RO Kit de pornire (acumulatori și încărcător)
- HU Kezdőkészlet (akkumulátorok és töltő)
- ES Conjunto de arranque (baterías y cargador)

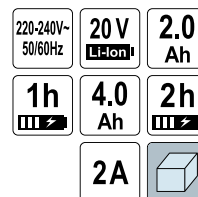

No.	Operating voltage / Napięcie robocze [V d.c.]	📦
78262	20	6

EN Battery
 PL Akumulator
 DE Akkumulator
 RU Аккумулятор
 CZ Akumulátor
 RO Acumulator
 HU Akkumulátor
 ES Bateria



STIHL

No.	Voltage / Napięcie [V d.c.]	Battery capacity / Pojemność akumulatora [mAh]	Charging time / Czas ładowania [h]	
78250	20	2000	1	24

EN Battery charger
 PL Ładowarka
 DE Ladegerät
 RU Зарядное устройство
 CZ Nabíječka
 RO Încărcător
 HU Töltő
 ES Cargador



STIHL

No.	Operating voltage / Napięcie robocze [V d.c.]	
78260	20	12

EN Cordless drill/driver
 PL Akumulatorowa wiertarko-wkrętarka
 DE Akku-Bohrschrauber
 RU Аккумуляторная дрель-шуруповёрт
 CZ Akumulátorový vrtací šroubovák
 RO Mașină de găurit și înșurubat cu acumulator
 HU Akkus fűró-csavarozó
 ES Taladro atornillador a batería

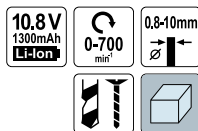

STIHL

$L_{pA} = 89,0 \pm 3,0$ dB; $L_{wA} = 100,0 \pm 3,0$ dB; $a_h = 0,854 \pm 1,5 / 2,069 \pm 1,5$ m/s²

No.	Voltage / Napięcie [V d.c.]	∅ [min ⁻¹]	Toolholder size / Rozmiar uchwyty narzędziowego [mm]	
78981	10.8	0-700	0.8-10	5

EN Battery
 PL Akumulator
 DE Akkumulator
 RU Аккумулятор
 CZ Akumulátor
 RO Acumulator
 HU Akkumulátor
 ES Bateria



STIHL

No.	Voltage / Napięcie [V d.c.]	Battery capacity / Pojemność akumulatora [mAh]	Charging time / Czas ładowania [h]	
78252	20	4000	2	12

EN Battery charger
 PL Ładowarka
 DE Ladegerät
 RU Зарядное устройство
 CZ Nabíječka
 RO Încărcător
 HU Töltő
 ES Cargador



STIHL

No.	Operating voltage / Napięcie robocze [V d.c.]	
78261	20	12

EN Cordless drill/driver
 PL Akumulatorowa wiertarko-wkrętarka
 DE Akku-Bohrschrauber
 RU Аккумуляторная дрель-шуруповёрт
 CZ Akumulátorový vrtací šroubovák
 RO Mașină de găurit și înșurubat cu acumulator
 HU Akkus fűró-csavarozó
 ES Taladro atornillador a batería



STIHL

$L_{pA} = 87,0 \pm 3,0$ dB; $L_{wA} = 98,0 \pm 3,0$ dB; $a_h = 1,292 \pm 1,5 / 2,312 \pm 1,5$ m/s²

No.	Voltage / Napięcie [V d.c.]	∅ [min ⁻¹]	Toolholder size / Rozmiar uchwyty narzędziowego [mm]	
78982	14.4	0-700	0.8-10	5

- EN Cordless drill/driver
- PL Akumulatorowa wiertarko-wkrętarka
- DE Akku-Bohrschrauber
- RU Аккумуляторная дрель-шуруповёрт
- CZ Akumulátorový vrtací šroubovák
- RO Mașină de găurit și înșurubat cu acumulator
- HU Akkus fűró-csavarozó
- ES Taladro atornillador a batería

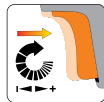
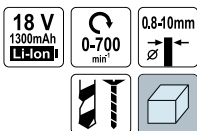

STKOR

$L_{pa} = 89,0 \pm 3,0$ dB; $L_{wa} = 100,0 \pm 3,0$ dB; $a_h = 1,001 \pm 1,5 / 2,629 \pm 1,5$ m/s²

No.	Voltage / Napięcie [V d.c.]	⊖ [min ⁻¹]	Toolholder size / Rozmiar uchwytu narzędziowego [mm]	
78983	18	0-700	0.8-10	5

- EN Battery charger
- CZ Nabíječka
- PL Ładowarka
- RO Încărcător
- DE Ladegerät
- HU Töltő
- RU Зарядное устройство
- ES Cargador

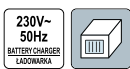

15

STKOR

No.	Output voltage / Napięcie wyjściowe [V d.c.]	Output current / Prąd wyjściowy [mA]	For / Dla	
79087	15	400	79084	30
79088	18	400	79085	30
79089	24	400	79086	20

- EN Cordless impact drill/driver
- PL Akumulatorowa wiertarko-wkrętarka udarowa
- DE Akku-Schlagbohrschrauber
- RU Аккумуляторная ударная дрель-шуруповёрт
- CZ Akumulátorový vrtací šroubovák s příklepem
- RO Mașină de găurit și înșurubat cu percuzie cu acumulator
- HU Akkus ütvefűró-csavarozó
- ES Taladro atornillador con percusión a batería

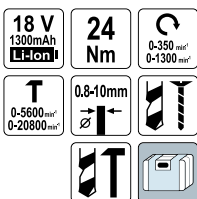

STKOR

$L_{pa} = 89,0 \pm 3,0$ dB; $L_{wa} = 100,0 \pm 3,0$ dB; $a_h = 15,25 \pm 1,5$ m/s²

No.	Voltage / Napięcie [V d.c.]	⊖ [min ⁻¹]	Toolholder size / Rozmiar uchwytu narzędziowego [mm]	
78974	18	0-350 / 0-1300	0.8-10	5

- EN Battery
- PL Akumulator
- DE Akkumulator
- RU Аккумулятор
- CZ Akumulátor
- RO Acumulator
- HU Akkumulátor
- ES Bateria

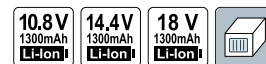

STKOR

No.	Voltage / Napięcie [V d.c.]	For / Dla	
78985	10.8	78118, 78981	50
78986	14.4	78982	50
78987	18	78972, 78974, 78961, 78963	50

- EN Cordless drill/driver
- PL Akumulatorowa wiertarko-wkrętarka
- DE Akku-Bohrschrauber
- RU Аккумуляторная дрель-шуруповёрт
- CZ Akumulátorový vrtací šroubovák
- RO Mașină de găurit și înșurubat cu acumulator
- HU Akkus fűró-csavarozó
- ES Taladro atornillador a batería

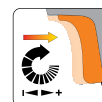

STKOR

$L_{pa} = 89,0 \pm 3,0$ dB; $L_{wa} = 100,0 \pm 3,0$ dB; $a_h = 1,001 \pm 1,5 / 2,629 \pm 1,5$ m/s²

No.	Voltage / Napięcie [V d.c.]	⊖ [min ⁻¹]	Toolholder size / Rozmiar uchwytu narzędziowego [mm]	
78972	18	0-350 / 0-1300	0.8-10	5

- EN Angle grinder
- PL Szlifierka kątowna
- DE Winkelschleifmaschine
- RU Углошлифовальная машина
- CZ Úhlová bruska
- RO Polizor unghiular
- HU Sarokcsiszoló
- ES Amoladora angular



STKOR

$L_{pa} = 99,0 \pm 3,0$ dB; $L_{wa} = 107,0 \pm 3,0$ dB; $a_h = 2,8 \pm 1,5$ m/s²

No.	Power / Moc [W]	⊖ [min ⁻¹]	
79093	900	11500	8

EN Angle grinder
 PL Szlifierka kątowa
 DE Winkelschleifmaschine
 RU Углошлифовальная машина
 CZ Úhlová bruska
 RO Polizor unghilular
 HU Sarokcsiszoló
 ES Amoladora angular

230-240V~50Hz
2000 W
 6500 min⁻¹
 230 mm
M14
 SOFT START
 MIEKKI START



$L_{pA} = 97,0 \pm 3,0$ dB; $L_{wA} = 105,0 \pm 3,0$ dB; $a_n = 6,2 \pm 1,5$ m/s²

No.	Power / Moc [W]	ω [min ⁻¹]	
79135	2000	6500	4

EN Finishing sander
 PL Szlifierka oscylacyjna
 DE Schwing schleifer
 RU Виброшлифмашина
 CZ Oscilační bruska
 RO Șlefuitor oscilant
 HU Vibrációs csiszológép
 ES Lijadora de oscilación

230V~50Hz
135 W
 10000 min⁻¹
 90x187 mm



$L_{pA} = 84,0 \pm 3,0$ dB; $L_{wA} = 95,0 \pm 3,0$ dB; $a_n = 3,7 \pm 1,5$ m/s²

No.	Power / Moc [W]	ω [min ⁻¹]	
79491	135	10000	6

EN Circular saw
 PL Pilarka tarczowa
 DE Handkreissäge
 RU Циркулярная пила
 CZ Okružní pila
 RO Fierăstrău circular de mână
 HU Kézi körfűrész
 ES Sierra circular

230-240V~50Hz
1400 W
 4800 min⁻¹
 65 mm
 185x20 x2,4 mm
24T
 0-45°
 90°-65 mm
 45°-44 mm



$L_{pA} = 94,0 \pm 3,0$ dB; $L_{wA} = 105,0 \pm 3,0$ dB; $a_n = 6,84 \pm 1,5$ m/s²

No.	Power / Moc [W]	ω [min ⁻¹]	
79257	1400	4800	4

EN Orbital sander
 PL Szlifierka mimośrodowa
 DE Exzentrische Schleifmaschine
 RU Эксцентриковая шлифовальная машина
 CZ Excentrická bruska
 RO Șlefuitor orbital
 HU Excenter csiszoló
 ES Pulidor excentrico

230V~50Hz
430 W
 6000-13000 min⁻¹
 125 mm



$L_{pA} = 81,0 \pm 3,0$ dB; $L_{wA} = 92,0 \pm 3,0$ dB; $a_n = 10,8 \pm 1,5$ m/s²

No.	Power / Moc [W]	ω [min ⁻¹]	
79309	430	6000-13000	6

EN Circular saw
 PL Pilarka tarczowa
 DE Handkreissäge
 RU Циркулярная пила
 CZ Okružní pila
 RO Fierăstrău circular de mână
 HU Kézi körfűrész
 ES Sierra circular

230-240V~50Hz
1200 W
 4800 min⁻¹
 52 mm
 160x20 x2,2 mm
18T
 0-45°
 90°-52 mm
 45°-37 mm



$L_{pA} = 94,0 \pm 3,0$ dB; $L_{wA} = 105,0 \pm 3,0$ dB; $a_n = 6,84 \pm 1,5$ m/s²

No.	Power / Moc [W]	ω [min ⁻¹]	
79254	1200	4800	4

EN Electric planer
 PL Strug elektryczny
 DE Elektrohobel
 RU Электрорубанок
 CZ Elektrický hoblík
 RO Rindea electrica
 HU Elektromos gyalu
 ES Garlopa electrica

230V~50Hz
600 W
 16000 min⁻¹
 0-2 mm
 82 mm



$L_{pA} = 83,0 \pm 3,0$ dB; $L_{wA} = 94,0 \pm 3,0$ dB; $a_n = 6,84 \pm 1,5$ m/s²

No.	Power / Moc [W]	ω [min ⁻¹]	
79416	600	16000	6

EN Hot air gun
 PL Opalarka
 DE Heissluftpistole
 RU Строительный фен
 CZ Opalovací stroj
 RO Pistol cu aer cald
 HU Hőlégfúvó
 ES Secadora

230V~
50Hz I-1000W II-2000W I-350°C II-550°C



STIHL

No.	Power / Moc [W]	Blast temperature / Temperatura nadmuchu [°C]	Icon
79320	1000 (I) / 2000 (II)	350 (I) / 550 (II)	10

EN Hot air gun with accessories
 PL Opalarka z akcesoriami
 DE Heissluftpistole
 RU Строительный фен в наборе
 CZ Opalovací stroj s příslušenstvím
 RO Pistol cu aer cald cu accesorii
 HU Hőlégfúvó tartozékokkal
 ES Secadora con accesorios

230V~
50Hz I-1000W II-1500W I-300°C II-500°C



STIHL

No.	Power / Moc [W]	Blast temperature / Temperatura nadmuchu [°C]	Icon
79328	1000 (I) / 1500 (II)	300 (I) / 500 (II)	5

EN Electric glue gun
 PL Pistolet do klejenia
 DE Heissklebepistole
 RU Пистолет для клея
 CZ Pistole na lepení
 RO Pistol pt. lipit cu batoane
 HU Ragasztópisztoly
 ES Pistola de cola

230V~
50Hz 15(100) W 180-200 °C 3-6 min
15 g/min 2x Ø 11mm



STIHL

No.	Power / Moc [W]	Glue stick diameter / Średnica wkładu klejowego [mm]	Capacity / Wydajność [g/min]	Icon
73052	15 (100)	11	15	12/48

EN Hot air gun
 PL Opalarka
 DE Heissluftpistole
 RU Строительный фен
 CZ Opalovací stroj
 RO Pistol cu aer cald
 HU Hőlégfúvó
 ES Secadora

230V~
50Hz I-1000W II-1500W I-300°C II-500°C



STIHL

No.	Power / Moc [W]	Blast temperature / Temperatura nadmuchu [°C]	Icon
79327	1000 (I) / 1500 (II)	300 (I) / 500 (II)	10

EN Electric glue gun
 PL Pistolet do klejenia
 DE Heissklebepistole
 RU Пистолет для клея
 CZ Pistole na lepení
 RO Pistol pt. lipit cu batoane
 HU Ragasztópisztoly
 ES Pistola de cola

230V~
50Hz 15(40) W 200 °C 3-5 min
8-12 g/min 2x Ø 11mm



STIHL

No.	Power / Moc [W]	Glue stick diameter / Średnica wkładu klejowego [mm]	Capacity / Wydajność [g/min]	Icon
73056	15 (40)	11	8-12	6/48

EN Electric glue gun
 PL Pistolet do klejenia
 DE Heissklebepistole
 RU Пистолет для клея
 CZ Pistole na lepení
 RO Pistol pt. lipit cu batoane
 HU Ragasztópisztoly
 ES Pistola de cola

230V~
50Hz 23(80) W 200 °C 3-5 min
14-16 g/min 2x Ø 11mm



STIHL

No.	Power / Moc [W]	Glue stick diameter / Średnica wkładu klejowego [mm]	Capacity / Wydajność [g/min]	Icon
73057	23 (80)	11	14-16	6/48

EN Soldering iron
 PL Lutownica oporowa
 DE LötKolben
 RU Электропаяльник
 CZ Pájka odporová
 RO Ciocan de lipit
 HU Forrasztópáka
 ES Soldador de resistencia



STIHL

No.	Power / Moc [W]	
79365	30	25/50
79366	40	25/50
79367	60	25/50
79368	80	25/50

EN Electric paddle mixer
 PL Mieszarka do zapraw
 DE Mörtelmischgerät
 RU Строительный миксер
 CZ Míchadlo na maltu
 RO Malaxor pt. mortar
 HU Habarcskeverő
 ES Mezcladora de mortero

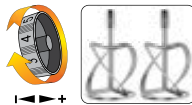

$L_{PA} = 87,0 \pm 3,0$ dB; $L_{WA} = 98,0 \pm 3,0$ dB; $a_n = 5,45 \pm 1,5$ m/s²

STIHL

No.	Power / Moc [W]	ω [min ⁻¹]	
78855	850	0-900	4

EN Dirty water submersible pump
 PL Pompa zatapiałna do wody brudnej
 DE Tauchpumpe für Schmutzwasser
 RU Погружной насос для грязной воды
 CZ Ponorné čerpadlo pro špinavú vodu
 RO Pompă submersibilă
 HU Búvárszivattyú
 ES Bomba sumergible para agua sucia



STIHL

No.	Power / Moc [W]	Max. capacity / Maks. wydajność [l/h]	Max. head / Maks. wysokość tłoczenia [m]	
79781	400	8000	5.5	4
79782	500	10000	6.5	4
79783	600	11500	7.0	4

EN Transformer soldering gun
 PL Lutownica transformatorowa
 DE Lötpistole
 RU Электрический паяльник
 CZ Transformátorová páječka
 RO Pistol de lipit
 HU Forrasztópáka
 ES Soldador transformador



STIHL

No.	Power / Moc [W]	
79354	100	10

EN Dirty water submersible pump
 PL Pompa zatapiałna do wody brudnej
 DE Tauchpumpe für Schmutzwasser
 RU Погружной насос для грязной воды
 CZ Ponorné čerpadlo pro špinavú vodu
 RO Pompă submersibilă
 HU Búvárszivattyú
 ES Bomba sumergible para agua sucia

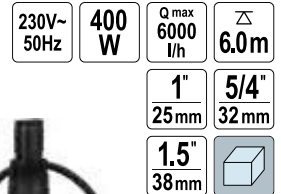

STIHL

No.	Power / Moc [W]	Max. capacity / Maks. wydajność [l/h]	Max. head / Maks. wysokość tłoczenia [m]	
79909	400	6000	6	6

EN Membrane deep well water pump
 PL Pompa membranowa zatapiałna
 DE Tauch-Membranpumpe
 RU Насос погружной мембранный
 CZ Ponorné membránové čerpadlo
 RO Pompă submersibilă cu membrană
 HU Membrános búvárszivattyú
 ES Bomba sumergible para agua limpia

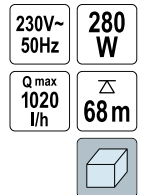

STIHL

No.	Power / Moc [W]	Max. capacity / Maks. wydajność [l/h]	Max. head / Maks. wysokość tłoczenia [m]	
79943	280	1020	68	4

EN Hot knife for polystyrene foam
 PL Nóż termiczny do styropianu
 DE Thermomesser für Styropor
 RU Термомож для пенопласта
 CZ Termický nůž na polystyrén
 RO Cuțit termic pt. polistiren
 HU Polisztirolvágó hőkés
 ES Cuchillo térmico para poliestireno



INCLUDED:

- 3 interchangeable tips: wire 17 cm, hot knife 12 cm, engraving tool 3.5 cm

- Base

- Additional cutting wire (1 pcs)

W ZESTAWIE:

- 3 wymienne końcówki: drut 17 cm, nóż do cięcia na gorąco 12 cm, nasadka do grzewowania 3.5 cm

- Podstawa

- Zapasowy drut tnący (1 szt.)



LUND

No.	Power / Moc [W]	Box
78894	9	20

EN Car polisher
 PL Polerka samochodowa
 DE Autopoliermaschine
 RU Полировальная машина
 CZ Autoleštička
 RO Aparat de polișat
 HU Polírozógép
 ES Pulidora para coche



LUND

$L_{pA} = 55.0 \pm 3.0$ dB; $L_{wA} = 66.0 \pm 3.0$ dB; $a_n = 14.8 \pm 1.5$ m/s²

No.	Power / Moc [W]	ω [min ⁻¹]	Box
82942	120	3200	6

EN Hot air gun with accessories
 PL Opalarka z akcesoriami
 DE Heissluftpistole
 RU Строительный фен в наборе
 CZ Opalovací stroj s příslušenstvím
 RO Pistol cu aer cald cu accesorii
 HU Hőlégfúvó tartozékokkal
 ES Secadora con accesorios

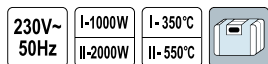

LUND

No.	Power / Moc [W]	Blast temperature / Temperatura nadmuchu [°C]	Box
79325	1000 (I) / 2000 (II)	350 (I) / 550 (II)	10

EN Mini grinder
 PL Uniwersalna szlifierka wielofunkcyjna
 DE Universal-Mehrweckschleifmaschine
 RU Универсальная шлифовальная машина
 CZ Všeúčelová univerzální bruska
 RO Mini freză electrică
 HU Univerzális daugjafunkcis szífuoklis
 ES Lijadora multifunción

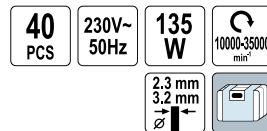

LUND

$L_{pA} = 72.0 \pm 3.0$ dB; $L_{wA} = 83.0 \pm 3.0$ dB; $a_n = 2.6 \pm 1.5$ m/s²

No.	Power / Moc [W]	ω [min ⁻¹]	Box
79314	135	10 000 (I) / 15 000 (II) / 20 000 (III) / 25 000 (IV) / 30 000 (V) / 33 000 (VI) / 35 000 (max)	10

EN Hot air gun
 PL Opalarka
 DE Heissluftpistole
 RU Строительный фен
 CZ Opalovací stroj
 RO Pistol cu aer cald
 HU Hőlégfúvó
 ES Secadora



LUND

No.	Power / Moc [W]	Blast temperature / Temperatura nadmuchu [°C]	Box
79324	750 (I) / 1500 (II)	300 (I) / 500 (II)	10

EN Electric glue gun
 PL Pistolet do klejenia
 DE Heissklebepistole
 RU Пистолет для клея
 CZ Pistolet na lepení
 RO Pistol pt. lipit cu batona
 HU Ragasztópisztoly
 ES Pistola de cola

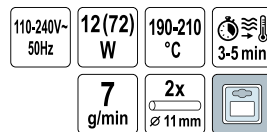

LUND

No.	Power / Moc [W]	Glue stick diameter / Średnica wkładu klejowego [mm]	Capacity / Wydajność [g/min]	Box
73051	12 (72)	11	7	12/48

EN Electric glue gun
 PL Pistolet do klejenia
 DE Heissklebepistole
 RU Пистолет для клея
 CZ Pistole na lepení
 RO Pistol pt. lipit cu batoane
 HU Ragasztópisztoly
 ES Pistola de cola

230V~ 50Hz	16 W	200 °C	11 g/min
	3-5 min		11 mm



LUND

No.	Power / Moc [W]	Glue stick diameter / Średnica wkładu klejowego [mm]	Capacity / Wydajność [g/min]	
73060	16	11	11	10

EN Wood burning kit
 PL Lutownica i pirograf do drewna
 DE Holzofen Kit
 RU Пирографии набор
 CZ Souprava pro spalování dřeva
 RO Set pirogravură
 HU Pirográf készlet
 ES Pirograbado de madera kit

230V~ 50Hz	30 W	400 °C	
---------------	---------	-----------	---



LUND

No.	Power / Moc [W]	
78890	30	15

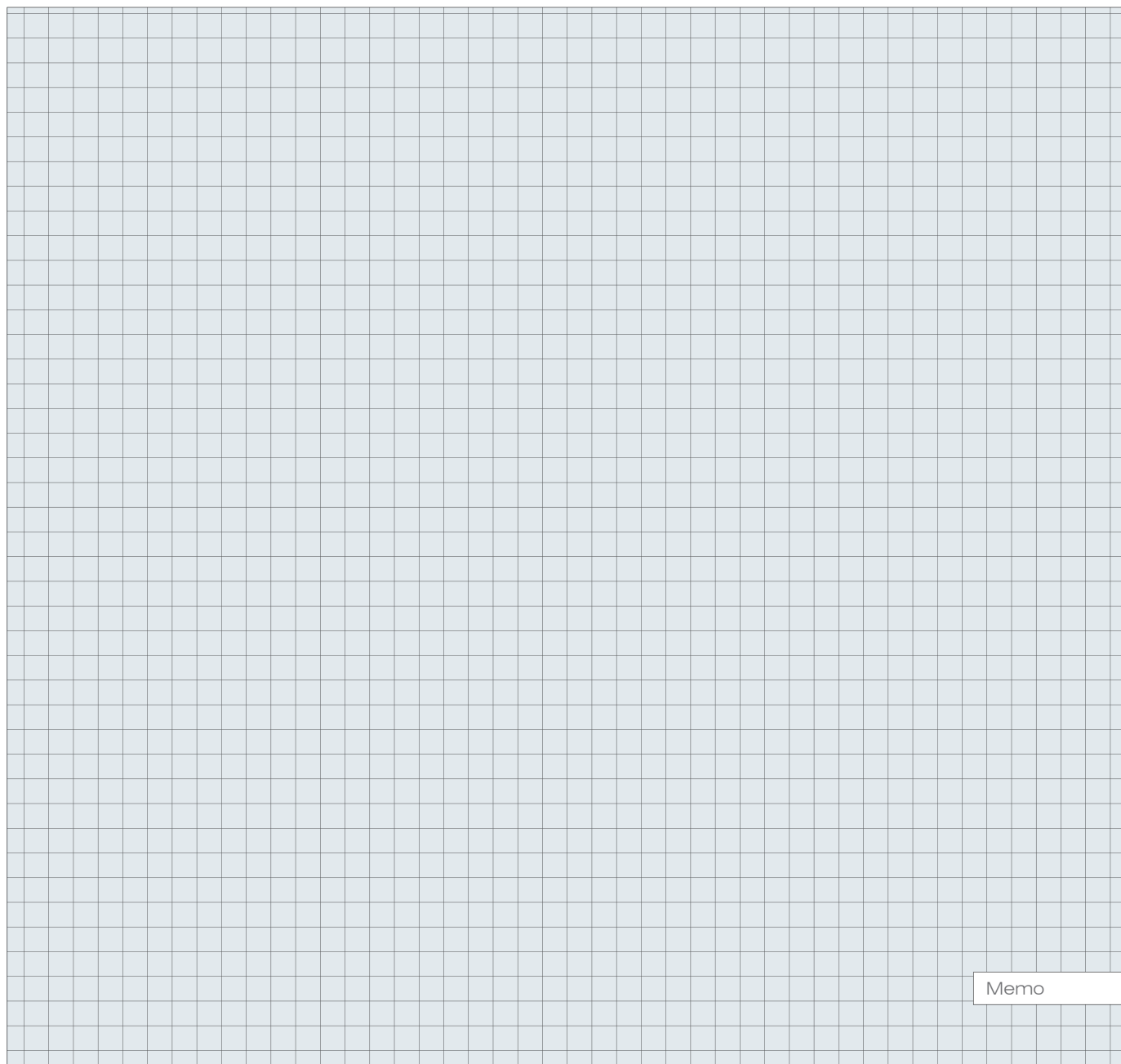

Memo

EN Dirty water submersible pump
 PL Pompa zatapialna do wody brudnej
 DE Tauchpumpe für Schmutzwasser
 RU Погружной насос для грязной воды
 CZ Ponorné čerpadlo pro špinavú vodu
 RO Pompă submersibilă
 HU Búvárszivattyú
 ES Bomba sumergible para agua sucia

230V~
50Hz

1"
25mm

5/4"
32mm

1.5"
38mm



FLO

No.	Power / Moc [W]	Max. capacity / Maks. wydajność [l/h]	Max. head / Maks. wysokość tłoczenia [m]	
79771	400	10000	6.5	4
79772	550	11500	7.0	4
79773	750	14000	7.5	4
79774	900	16000	8.5	4
79775	1100	16000	8.5	4

EN Membrane deep well water pump
 PL Pompa membranowa zatapialna
 DE Tauch-Membranpumpe
 RU Насос погружной мембранный
 CZ Ponorné membránové čerpadlo
 RO Pompă submersibilă cu membrană
 HU Membrános búvárszivattyú
 ES Bomba sumergible para agua limpia

220-230V~
50Hz

350
W

Q max
1200
l/h

70 m



FLO

No.	Power / Moc [W]	Max. capacity / Maks. wydajność [l/h]	Max. head / Maks. wysokość tłoczenia [m]	
79944	350	1200	70	4

EN Garden pump
 PL Pompa ogrodowa
 DE Gartenpumpe
 RU Насос садовый

CZ Zahradní čerpadlo
 RO Pompă de grădină
 HU Kerti szivattyú
 ES Bomba de jardín

FLO

$L_{WA} = 95,0 \pm 3,0$ dB

No.	Power / Moc [W]	Max. capacity / Maks. wydajność [l/h]	Max. lifting height / Maks. wysokość podnoszenia [m]	Max. pumping pressure / Maks. ciśnienie tłoczenia [bar]	
79810	600	2800	35	3.5	1
79811	800	3600	40	4.0	1
79812	1000	3800	44	4.4	1

EN Dirty water submersible pump
 PL Pompa zatapialna do wody brudnej
 DE Tauchpumpe für Schmutzwasser
 RU Погружной насос для грязной воды
 CZ Ponorné čerpadlo pro špinavú vodu
 RO Pompă submersibilă
 HU Búvárszivattyú
 ES Bomba sumergible para agua sucia

230V~
50Hz

1"
25mm

5/4"
32mm

1.5"
38mm

INOX



FLO

No.	Power / Moc [W]	Max. capacity / Maks. wydajność [l/h]	Max. head / Maks. wysokość tłoczenia [m]	
79790	750	14000	7.5	2
79791	900	16000	8.5	2
79792	1100	20000	9.0	2

EN Submersible pump for dirty water and wastewater
 PL Pompa zatapialna do wody brudnej i ścieków
 DE Tauchpumpe für Schmutzwasser
 RU Погружной насос для грязной воды
 CZ Ponorné čerpadlo pro odpadní vody
 RO Pompă submersibilă pt. apă murdară
 HU Búvárszivattyú szennyvíz
 ES Bomba sumergible para aguas residuales

230V~
50Hz

450
W

Q max
16000
l/h



FLO

No.	Power / Moc [W]	Max. capacity / Maks. wydajność [l/h]	Max. head / Maks. wysokość tłoczenia [m]	
79880	450	16000	9	1

230V~
50Hz



EN Fountain pump
 PL Pompa fontannaowa
 DE Springbrunnenpumpe
 RU Фонтанный насос
 CZ Fontánová pumpa
 RO Pompa pt. fantana arteziana
 HU Pumpa szökőkúthoz
 ES Bomba para las fuentes



230V~
50Hz

3
NOZZLES
DYSE

IPX8



No.	Power / Moc [W]	Max. capacity / Maks. wydajność [l/h]	Max. head / Maks. wysokość tłoczenia [m]	
79926	8	600	1.0	12
79927	16	800	1.3	12
79928	22	1000	1.6	12

EN Fountain pump
 PL Pompa fontannaowa
 DE Springbrunnenpumpe
 RU Фонтанный насос
 CZ Fontánová pumpa
 RO Pompa pt. fantana arteziana
 HU Pumpa szökőkúthoz
 ES Bomba para las fuentes



230V~
50Hz

5
NOZZLES
DYSE

IP68

10 m



No.	Power / Moc [W]	Max. capacity / Maks. wydajność [l/h]	Max. head / Maks. wysokość tłoczenia [m]	
79931	55	2000	2.5	8
79932	85	3000	3.5	8
79933	100	4500	4.5	6

EN Cordless grass and shrub shears
 PL Akumulatorowe nożyce do trawy i krzewów
 DE Akku Gras- und Strauchschere
 RU Аккумуляторные ножницы для травы и кустов
 CZ Akumulátorové nůžky na trávu a keře
 RO Foarfecă pt. iarbă și gard viu cu acumulator
 HU Akkumulátoros fű- és bokornyíró
 ES Tijeras a batería para hierba y arbustos

2in1

∅ 8 mm

3.6 V
1500mAh
Li-Ion

1100
min²

90 mm

120 mm

1h



$L_{pA} = 55,5 \pm 3,0$ dB; $L_{wA} = 75,5 \pm 3,0$ dB; $a_n = 0,912 \pm 1,5$ m/s²

No.	Voltage / Napięcie [V d.c.]	Cutting speed / Prędkość cięcia [min ⁻¹]	
79503	3.6	1100	6

EN Fountain pump
 PL Pompa fontannaowa
 DE Springbrunnenpumpe
 RU Фонтанный насос
 CZ Fontánová pumpa
 RO Pompa pt. fantana arteziana
 HU Pumpa szökőkúthoz
 ES Bomba para las fuentes



230V~
50Hz

5
NOZZLES
DYSE

IPX8



No.	Power / Moc [W]	Max. capacity / Maks. wydajność [l/h]	Max. head / Maks. wysokość tłoczenia [m]	
79929	28	1400	2.0	8
79930	40	1800	2.5	8

EN Cordless grass and shrub shears
 PL Akumulatorowe nożyce do trawy i krzewów
 DE Akku Gras- und Strauchschere
 RU Аккумуляторные ножницы для травы и кустов
 CZ Akumulátorové nůžky na trávu a keře
 RO Foarfecă pt. iarbă și gard viu cu acumulator
 HU Akkumulátoros fű- és bokornyíró
 ES Tijeras a batería para hierba y arbustos

2in1

∅ 8 mm

3.6 V
1500mAh
Li-Ion

1100
min²

90 mm

120 mm

1h



15

$L_{pA} = 55,5 \pm 3,0$ dB; $L_{wA} = 75,5 \pm 3,0$ dB; $a_n = 0,912 \pm 1,5$ m/s²



No.	Voltage / Napięcie [V d.c.]	Cutting speed / Prędkość cięcia [min ⁻¹]	
79502	3.6	1100	10

EN Electric hedge trimmer
 PL Elektryczne nożyce do żywoplotu
 DE Elektrische Heckenschere
 RU Электрический кусторез
 CZ Elektrické nůžky na živý plot
 RO Foarfecă electrică pt. gard viu
 HU Elektromos sövényvágó
 ES Cortasetos eléctrico

230V~
50Hz

550
W

1700
min²

510
mm



$L_{pA} = 88,0 \pm 3,0$ dB; $L_{wA} = 99,0 \pm 3,0$ dB; $a_n = 1,982 \pm 1,5 / 1,778 \pm 1,5$ m/s²

No.	Power / Moc [W]	Cutting speed / Prędkość cięcia [min ⁻¹]	Cutting length / Długość cięcia [mm]	
79448	550	1700	510	4

EN Electric chainsaw
 PL Elektryczna pilarka łańcuchowa
 DE Elektrische Kettensäge
 RU Электрическая цепная пила
 CZ Elektrická řetězová pila
 RO Fierăstrau electric cu lanț
 HU Elektromos láncfűrész
 ES Sierra de cadena eléctrica

230-240V~ 50Hz	1600 W	7000 min ⁻¹	14" 35.5 cm
3/8" 9.52 mm	0.05" 1.3 mm	13 m/s	0.11 L



$L_{pa} = 90,2 \pm 3,0$ dB; $L_{wa} = 103,2 \pm 3,0$ dB; $a_h = 8,393 \pm 1,5 / 6,002 \pm 1,5$ m/s²

No.	Power / Moc [W]	
79675	1600	2

EN Electric scarifier
 PL Wertrykulator elektryczny
 DE Elektrischer Vertikutierer
 RU Электрический скарификатор
 CZ Elektrický vertikutátor
 RO Scarificator electric
 HU Elektromos gyepszellőztető
 ES Escarificador eléctrico

15



$L_{pa} = 84,5 \pm 3,0$ dB; $L_{wa} = 97,3 \pm 1,05$ dB; $a_h = 4,265 \pm 1,5$ m/s²

No.	Power / Moc [W]	
79734	1500	1

EN Electric soil tiller
 PL Glebogryzarka elektryczna
 DE Elektro-Bodenhacke
 RU Электрический культиватор
 CZ Elektrický kultivátor
 RO Motoșapă electrică
 HU Elektromos kapálógép
 ES Motoazada eléctrica

230-240V~ 50Hz	750 W
220 mm	320 mm
∅ 205 mm	



$L_{pa} = 79,0 \pm 3,0$ dB; $L_{wa} = 91,87 \pm 0,48$ dB; $a_h = 1,153 \pm 1,5 / 1,158 \pm 1,5$ m/s²

No.	Power / Moc [W]	
79725	750	1



230-240V~ 50Hz	1500 W	3000 min ⁻¹
max 12mm	320 mm	30 L
	INTERCHANGEABLE ROLLERS WYMIENNE WALKI	
	x20	

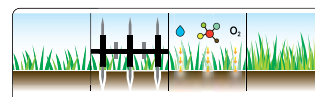

Memo

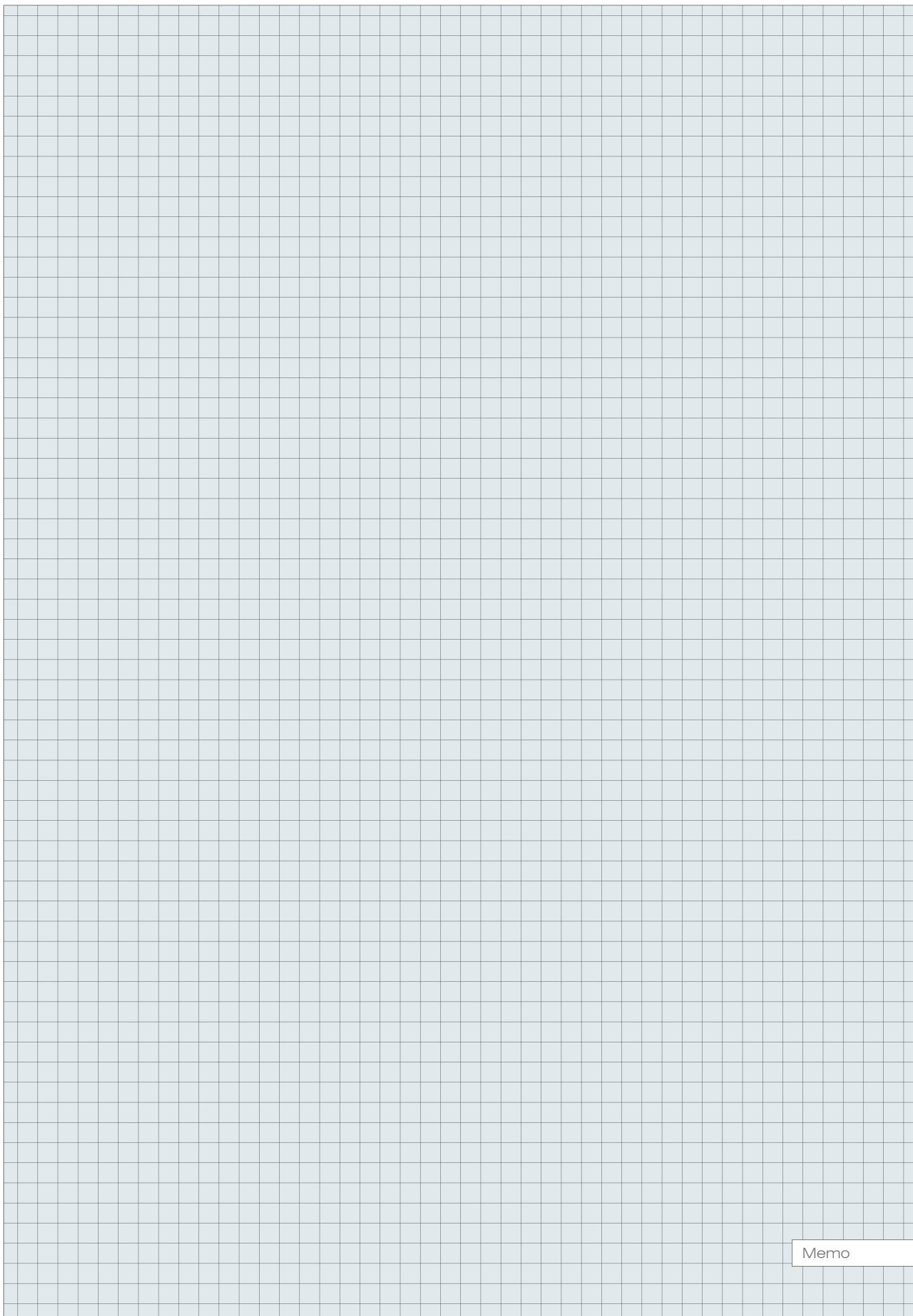

Memo

EN Soldering iron
 PL Lutownica pistoletowa
 DE DelötKolben
 RU Электропаяльник

CZ Pájka odporová
 RO Ciocan de lipit
 HU Huforrasztópáka
 ES Soldador de resistencia

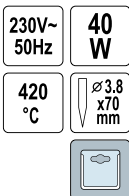

VOREL

No.	Power / Moc [W]	
79358	40	25/50

EN Chain saw file
 PL Pilnik okrągły do łańcuchów
 DE Runde Kettenfeile
 RU Цилиндрический напильник для цепей
 CZ Kulatý pilník na řetězy
 RO Pilă rotundă pt. lanț drujbă
 HU Láncvágó körfűrész
 ES Lima redonda para cadenas



FLO

No.	L [mm]	Chain pitch / Podziałka łańcucha	Ø [mm]	pcs / szt.	
79861	200	3/8 picco	4.0	3	4/200
79862	200	microlite	4.5	3	4/200
79863	200	.325	4.8	3	4/200

EN Universal wrench for gasoline machines
 PL Klucz uniwersalny do narzędzi spalinowych
 DE Universalschlüssel für Benzin Maschinen
 RU Универсальный ключ для бензинового инструмента

CZ Univerzální klíč pro benzínové stroje
 RO Cheie universală pt. drujbă
 HU Kulccsal benzin eszköz
 ES Llave universal para máquinas de gasolina

FLO

No.		
79869		10/100

EN Line head
 PL Głowica żyłkowa
 DE Trimmerkopf
 RU Головка с леской
 CZ Strunová hlava
 RO Cap trimmer
 HU Damil fej
 ES Cabezal de hilo



FLO

No.	Ø [mm]	
79550	2.0-2.4	10/40

EN Transformer soldering gun
 PL Lutownica transformatorowa
 DE Lötpistole
 RU Электрический паяльник

CZ Transformátorová páječka
 RO Pistol de lipit
 HU Forrasztópáka
 ES Soldador transformador

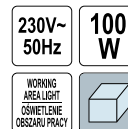

No.	Power / Moc [W]	
79350	100	24

EN Guide for chain saw file
 PL Prowadnik do pilnika do łańcuchów
 DE Führung für die Kettenfeile
 RU Направляющая для напильника для цепей
 CZ Vedení pro pilník na řetězy
 RO Ghidaj pt. pilă ascuțit lanț drujbă
 HU Megvezető a láncfűrészhez
 ES Guía de lima para cadenas



FLO

No.	Chain pitch / Podziałka łańcucha	Ø [mm]	
79865	3/8 picco	4.0	50/150
79866	microlite	4.5	50/150
79867	.325	4.8	50/150



EN Line head
 PL Głowica żyłkowa
 DE Trimmerkopf
 RU Головка с леской
 CZ Strunová hlava
 RO Cap trimmer
 HU Damil fej
 ES Cabezal de hilo

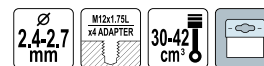

FLO

No.	Ø [mm]	
79551	2.4-2.7	10/40

EN Line head
 PL Glowica żyłkowa
 DE Trimmerkopf
 RU Головка с леской
 CZ Strunová hlava
 RO Cap trimmer
 HU Damil fej
 ES Cabezal de hilo



No.	Ø [mm]	
79552	2.4-2.7	10/40

EN 2-tooth brushcutter blade
 PL Tarcza tnąca dwuzębna
 DE 2-Zahn Dickichtmesser
 RU Нож для мотокосы двухлопастной
 CZ Žací nůž 2-zubý
 RO Cuțit motocoasă cu 2 dinți
 HU 2-ágú bozótváágó kés
 ES Cuchilla de 2 puntas para desbrozadora



No.		
79560		25/50

EN Brushcutter chisel-tooth blade
 PL Tarcza tnąca z zębami przecinakowymi
 DE Meißelzahn-Sägeblatt für Motorsensen
 RU Нож для мотокосы
 CZ Rezací kotouč s dlátovými zuby
 RO Lama cu dinte tip dalta pt. motocoasă
 HU Fűrészkorong vágótárcsa
 ES Disco de corte para desbrozadora



No.		
79561		15/30

EN 3-tooth brushcutter blade
 PL Tarcza tnąca trójzębna
 DE 3-Zahn Dickichtmesser
 RU Нож трехлопастной
 CZ Žací nůž 3-zubý
 RO Lamă pt. motocoasă cu 3 dinți
 HU 3 fogú vágókés
 ES Cuchilla de 3 puntas para desbrozadora



No.		
79564		25/50

EN Line head
 PL Glowica żyłkowa
 DE Trimmerkopf
 RU Головка с леской
 CZ Strunová hlava
 RO Cap trimmer
 HU Damil fej
 ES Cabezal de hilo



No.	Ø [mm]	For / Dia	
79468	1.2	79467	20/100

EN Brushcutter shredder blade
 PL Nóż rozdrabniający
 DE Mulchmesser
 RU Нож для мотокосы
 CZ Žací nůž mulčovací
 RO Lamă pt. motocoasă
 HU Bozótváágó penge
 ES Cuchilla de triturar

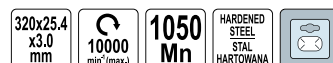

No.		
79563		20/40

EN 8-tooth brushcutter blade
 PL Tarcza tnąca ośmiozębna
 DE 8-Zahn Dickichtmesser
 RU Диск для мотокосы
 CZ Žací nůž 8-zubý
 RO Disc pt. motocoasă cu 8 dinți
 HU 8 fogú bozótváágó tárcsa
 ES Disco de 8 dientes para desbrozadora

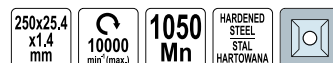

No.		
79562		20/40

EN 3-tooth brushcutter blade
 PL Tarcza tnąca trójzębna
 DE 3-Zahn Dickichtmesser
 RU Нож трехлопастной
 CZ Žací nůž 3-zubý
 RO Lamă pt. motocoasă cu 3 dinți
 HU 3 fogú vágókés
 ES Cuchilla de 3 puntas para desbrozadora

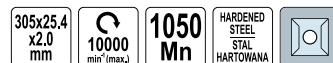

No.		
79565		25/50

EN Brushcutter saw blade
 PL Tarcza tnąca z zębami ukośnymi
 DE Spitzzahn-Sägeblatt für Motorsensen
 RU Диск для мотокосы
 CZ Pílový kotouč se špičatými zuby
 RO Lamă pt. motocoasă
 HU Fűkasza vágótárcsa
 ES Disco cortahierbas con dientes en pico

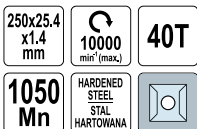

No.	
79566	25/50

EN Grass trimmer line
 PL Żyłka tnąca
 DE Mähfaden
 RU Леска для триммера

CZ Struna do sekačky
 RO Fir trimmer
 HU Damil szegélynyíró géphez
 ES Hilo de cortar



10m



No.	Ø [mm]	L [m]	Cutting line profile / Przekrój żyłki	
89401	1.3	10	○	20/240
89402	1.6	10	○	20/240
89403	2.0	10	○	20/240
89404	2.4	10	○	12/144
89405	2.6	10	○	12/144
89406	3.0	10	○	12/144

EN Grass trimmer line
 PL Żyłka tnąca
 DE Mähfaden
 RU Леска для триммера

CZ Struna do sekačky
 RO Fir trimmer
 HU Damil szegélynyíró géphez
 ES Hilo de cortar



10m



No.	Ø [mm]	L [m]	Cutting line profile / Przekrój żyłki	
89411	1.3	10	□	20/240
89412	1.6	10	□	20/240
89413	2.0	10	□	20/240
89414	2.4	10	□	12/144
89415	2.6	10	□	12/144
89416	3.0	10	□	12/144

EN 4-tooth brushcutter blade
 PL Tarcza tnąca czterozębna
 DE 4-Zahn Dickichtmesser
 RU Диск для мотокосы
 CZ Žací nůž 4-zubý
 RO Lamă pt. motocoasă cu 4 dinți
 HU 4-ágú bozótívágó kés
 ES Disco de 4 puntas para desbrozadora

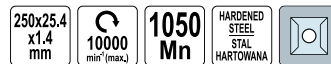

No.	
79567	25/50

EN Grass trimmer line
 PL Żyłka tnąca
 DE Mähfaden
 RU Леска для триммера
 CZ Struna do sekačky
 RO Fir trimmer
 HU Damil szegélynyíró géphez
 ES Hilo de cortar



No.	Ø [mm]	L [m]	Cutting line profile / Przekrój żyłki	
89441	2.0	120	○	27
89442	2.4	90	○	27
89443	2.6	70	○	27
89444	3.0	56	○	27

EN Grass trimmer line
 PL Żyłka tnąca
 DE Mähfaden
 RU Леска для триммера
 CZ Struna do sekačky
 RO Fir trimmer
 HU Damil szegélynyíró géphez
 ES Hilo de cortar



No.	Ø [mm]	L [m]	Cutting line profile / Przekrój żyłki	
89452	2.4	90	□	16
89453	2.6	70	□	16
89454	3.0	56	□	16

EN Grass trimmer line
 PL Żyłka tnąca
 DE Mähfaden
 RU Леска для триммера

CZ Struna do sekačky
 RO Fir trimmer
 HU Damil szegélynyíró géphez
 ES Hilo de cortar



No.	Ø [mm]	L [m]	Cutting line profile / Przekrój żyłki	
89421	1.3	15	☆	24/288
89422	1.6	15	☆	20/240
89423	2.0	15	☆	16/192
89424	2.4	15	☆	12/144
89425	2.6	15	☆	12/144
89426	3.0	15	☆	10/120



EN Grass trimmer line
 PL Żyłka tnąca
 DE Mähfaden
 RU Леска для триммера
 CZ Struna do sekačky
 RO Fir trimmer
 HU Damil szegélynyíró géphez
 ES Hilo de cortar



No.	Ø [mm]	L [m]	Cutting line profile / Przekrój żyłki	
89456	2.0	90	☆	9/27
89457	2.4	90	☆	9/27
89458	2.6	90	☆	9/27
89459	3.0	60	☆	9/27

EN Grass trimmer line
 PL Żyłka tnąca
 DE Mähfaden
 RU Леска для триммера
 CZ Struna do sekačky
 RO Fir trimmer
 HU Damil szegélynyíró géphez
 ES Hilo de cortar

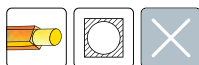

No.	Ø [mm]	L [m]	Cutting line profile / Przekrój żyłki	
89465	2.4	90	□	10/20
89466	2.7	70	□	10/20
89467	3.0	60	□	10/20

EN Grass trimmer line
 PL Żyłka tnąca
 DE Mähfaden
 RU Леска для триммера
 CZ Struna do sekačky
 RO Fir trimmer
 HU Damil szegélynyíró géphez
 ES Hilo de cortar



No.	Ø [mm]	L [m]	Cutting line profile / Przekrój żyłki	
89473	2.4	90	△	10/20
89474	2.7	70	△	10/20
89475	3.0	60	△	10/20

EN Grass trimmer line
 PL Żyłka tnąca
 DE Mähfaden
 RU Леска для триммера
 CZ Struna do sekačky
 RO Fir trimmer
 HU Damil szegélynyíró géphez
 ES Hilo de cortar

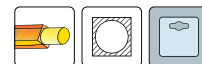

No.	Ø [mm]	L [m]	Cutting line profile / Przekrój żyłki	
89462	2.4	15	□	10/120
89463	2.7	15	□	10/120
89464	3.0	12	□	10/120

EN Grass trimmer line
 PL Żyłka tnąca
 DE Mähfaden
 RU Леска для триммера
 CZ Struna do sekačky
 RO Fir trimmer
 HU Damil szegélynyíró géphez
 ES Hilo de cortar



No.	Ø [mm]	L [m]	Cutting line profile / Przekrój żyłki	
89470	2.4	15	△	10/120
89471	2.7	15	△	10/120
89472	3.0	12	△	10/120

EN Grass trimmer line
 PL Żyłka tnąca
 DE Mähfaden
 RU Леска для триммера
 CZ Struna do sekačky
 RO Fir trimmer
 HU Damil szegélynyíró géphez
 ES Hilo de cortar

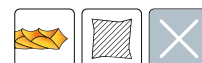

No.	Ø [mm]	L [m]	Cutting line profile / Przekrój żyłki	
89483	2.0	90	▨	10/20
89484	2.4	90	▨	10/20
89485	2.7	70	▨	10/20
89486	3.0	60	▨	10/20

EN Grass trimmer line
 PL Żyłka tnąca
 DE Mähfaden
 RU Леска для триммера

CZ Struna do sekačky
 RO Fir trimmer
 HU Damil szegélynyíró géphez
 ES Hilo de cortar



No.	Ø [mm]	L [m]	Cutting line profile / Przekrój żyłki	
89478	1.6	15		20/240
89479	2.0	15		10/120
89480	2.4	15		10/120
89481	2.7	15		10/120
89482	3.0	12		10/120

EN Connection for submersible pumps
 PL Przyłącze do pomp zatopialnych
 DE Tauchpumpen-Anschluss
 RU Переходник для погружных насосов
 CZ Přípojka pro ponorná čerpadla
 RO Ștuf de fixare furtun pompă
 HU Búvárszivattyú tömlőcsatlakozó
 ES Conexión para bombas sumergibles

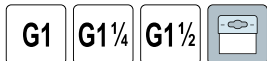

No.	For / Dla	
79919	79771, 79772, 79773, 79774, 79775, 79790, 79791, 79792	100

EN Brass straight connection
 PL Króciec mosiężny do pomp
 DE Messingstutzen für Pumpen
 RU Латунный патрубок для насосов
 CZ Mosazná přípojka pro čerpadla
 RO Conector alama
 HU Sárgaréz csatlakozó szivattyúkhöz
 ES Conector de latón para bombas



No.	Hose diameter / Średnica węży	
79924	1" (25 mm)	10/80

EN Self-locking drill chuck
 PL Uchwyt wiertarski samozaciskowy
 DE Schnellspannbohrfutter
 RU Патрон самозакимной для дрели
 CZ Sklíčidlo vrtačkové samosvorné
 RO Mandrină rapidă
 HU Gyorsbefogó fúrótokmány
 ES Portabrocas de sujeción rápida



No.	Toolholder size / Rozmiar uchwyty narzędziowego [mm]	Thread size / Rozmiar gwintu	
79580	2-13	G1/2	5/40



EN Connection for submersible pumps
 PL Przyłącze do pomp zatopialnych
 DE Tauchpumpen-Anschluss
 RU Переходник для погружных насосов
 CZ Přípojka pro ponorná čerpadla
 RO Ștuf de fixare furtun pompă
 HU Búvárszivattyú tömlőcsatlakozó
 ES Conexión para bombas sumergibles

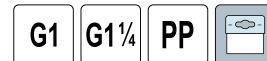

No.	For / Dia	
79911	79781, 79782, 79783	100

EN Self-locking drill chuck
 PL Uchwyt wiertarski samozaciskowy
 DE Schnellspannbohrfutter
 RU Патрон самозакимной для дрели
 CZ Sklíčidlo vrtačkové samosvorné
 RO Mandrină rapidă
 HU Gyorsbefogó fúrótokmány
 ES Portabrocas de sujeción rápida

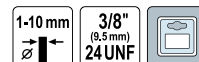

No.	Toolholder size / Rozmiar uchwyty narzędziowego [mm]	Thread size / Rozmiar gwintu	
79570	1-10	G3/8	10/40

EN Key-type drill chuck
 PL Uchwyt wiertarski z kluczem
 DE Zahnkranzbohrfutter mit Schlüssel
 RU Патрон для дрели ключевой
 CZ Vrtačkové sklíčidlo s kličkou
 RO Mandrină cu cheie
 HU Fúrótokmány kulccsal
 ES Portabrocas con llave

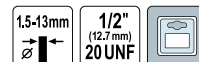

No.	Toolholder size / Rozmiar uchwyty narzędziowego [mm]	Thread size / Rozmiar gwintu	
79630	1.5-13	G1/2	5/40

EN Adapter SDS-plus - UNF 1/2"
 PL Adapter SDS-plus - UNF 1/2"
 DE Adapter SDS-plus - UNF 1/2"
 RU Переходник SDS-plus - UNF 1/2"
 CZ Přenoska SDS-plus - UNF 1/2"
 RO Adaptor SDS-plus - UNF 1/2"
 HU Adapter SDS-plus - UNF 1/2"
 ES Adaptor SDS-plus - UNF 1/2"



STIHL

No.	Thread size / Rozmiar gwintu	
79800	G1/2	12/144

EN Multi-function sharpener
 PL Ostrzałka wielofunkcyjna
 DE Multifunktionales Schärfgerät
 RU Многофункциональный заточной станок
 CZ Všeúčelová bruska
 RO Mașină de ascuțit multifuncțională
 HU Multifunkciós élezőgép
 ES Afilador multifuncional



$L_{pA} = 80,0 \pm 3,0$ dB; $L_{wA} = 93,0 \pm 3,0$ dB

STIHL

No.	Power / Moc [W]	
73473	150	2

EN Drill stand
 PL Statyw do wiertarki
 DE Bohrmaschinen-Ständer
 RU Стойка для дрели
 CZ Stativ do vrtačky
 RO Suport masina de gaurit
 HU Fűrőállvány
 ES Soporte para taladro

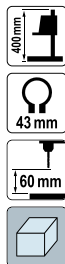

VOREL

No.	H [mm]	
79640	400	10

EN Spare cutting knife for electric planer
 PL Zapasowe ostrza do struga elektrycznego
 DE Hobelmesser für Elektrohobel
 RU Лезвия для электрорубанка

CZ Náhradní nůž pro elektr. hoblíku
 RO Lamă de rezervă pt. rindea electrică
 HU Tartalék gyalukés elektromos gyalogéphez
 ES Filos de repuesto para cepillo eléctrico

STIHL

No.	pcs / szt.	
79346	2	30/360

EN Multipurpose drill bit sharpener
 PL Wielofunkcyjna ostrzałka do wiertel
 DE Vielzweck Bohrerschleifgerät
 RU Машина для заточки свёрл
 CZ Ošťička pro ostření vrtáků
 RO Mașină de ascuțit burghie
 HU Fűrőélező
 ES Afiladora de brocas



$L_{pA} = 61,0 \pm 3,0$ dB; $L_{wA} = 74,0 \pm 3,0$ dB

No.	Power / Moc [W]	
73470	70	6

EN Angle grinder stand
 PL Statyw do szlifierki katowej
 DE Winkelschleif-Trennständer
 RU Стойка для угловой шлифовальной машины
 CZ Stojan pro úhlovou brusku
 RO Suport pt. polizor unghiular
 HU Állvány sarokcsiszolóhoz
 ES Soporte para amoladora angular

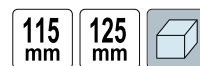

VOREL

No.	
79641	4

EN Drill stand
 PL Statyw do wiertarki
 DE Bohrmaschinen-Ständer
 RU Стойка для дрели
 CZ Stativ do vrtačky
 RO Suport masina de gaurit
 HU Fűrőállvány
 ES Soporte para taladro



VOREL

No.	H [mm]	
79639	400	8



EN Mounted stone set
 PL Kamienie szlifierskie trzpieniowe
 DE Schleifsteinaufsätze
 RU Набор абразивных наконечников
 CZ Brusné kámeny hrotové
 RO Set pietre abrazive cu tija
 HU Csiszolókő készlet, csapszárú
 ES Discos de esmeril

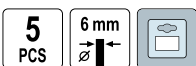

No.	Chuck diameter / Średnica trzpienia [mm]	pcs / szt.	
25400	6	5	25/200

EN Mini grinder accessories set
 PL Zestaw końcówek do szlifierki
 DE Schleifaufsätze
 RU Набор шлифовальных и полировочных насадок
 CZ Soustava koncovek na brusku
 RO Set accesorii de șlefuit pt. mini freză
 HU Fejkészlet csiszológéphez
 ES Juego de puntas de pulir



VOREL

No.	pcs / szt.	
25410	13	10/50

EN Mini grinder accessories set
 PL Zestaw końcówek do szlifierki
 DE Schleifaufsätze
 RU Набор шлифовальных и полировочных насадок
 CZ Soustava koncovek na brusku
 RO Set accesorii de șlefuit pt. mini freză
 HU Fejkészlet csiszológéphez
 ES Juego de puntas de pulir



VOREL

No.	pcs / szt.	
25412	22	10/50

EN Helping hand with magnifying glass
 PL Zestaw „trzecia ręka” z lupą
 DE Dritte Hand mit Lupe
 RU Комплект „третья ручка” с лупой
 CZ Držák třetí ruka s lupou
 RO Lupă cu suport reglabil
 HU Paneltartó állvány „harmadik kéz”
 ES Tercera mano con lupa



No.	Lenses diameter / Średnica soczewek [mm]	
73500	62	10/40

EN Rotary rasp set
 PL Zestaw tamików trzpieniowych
 DE Profiliraspel-Satz
 RU Набор борфрез
 CZ Sada rotačních rašplí
 RO Set freze
 HU Csiszolófej készlet
 ES Juego de escofinas



No.	Chuck diameter / Średnica trzpienia [mm]	pcs / szt.	
25450	6	5	25/200

EN Mini grinder accessories set
 PL Zestaw końcówek do szlifierki
 DE Schleifaufsätze
 RU Набор шлифовальных и полировочных насадок
 CZ Soustava koncovek na brusku
 RO Set accesorii de șlefuit pt. mini freză
 HU Fejkészlet csiszológéphez
 ES Juego de puntas de pulir



VOREL

No.	pcs / szt.	
25411	17	10/50

EN Polishing covers
 PL Nakładki polerujące
 DE Polierscheibe
 RU Полировочные накладки
 CZ Leštící kotouč
 RO Perii pt. polisat
 HU Polírozó korong
 ES Fundas



VOREL

No.	Ø [mm]	For / Dia	pcs / szt.	
82941	245	82940	2	10/100

EN Soldering iron stand
 PL Stojak do lutownicy
 DE Lötcolbenständer
 RU Подставка для паяльника
 CZ Stojan na pájku
 RO Suport pt. ciocan lipit
 HU Forrasztópáka tartó
 ES Caballete de soldador



VOREL

No.		
79386		50/100

EN Soldering accessories
 PL Zestaw narzędzi lutowniczych
 DE Lötzubehör
 RU Принадлежности для пайки
 CZ Pájecí příslušenství
 RO Accesorii de lipit
 HU Forrasztó tartozékok
 ES Jooteseadmed tarvikud

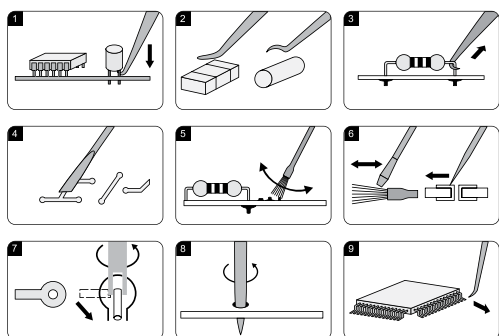

No.	pcs / szt.	Box
79398	6	25/100

EN Solder
 PL Spoiwo lutownicze
 DE Lötzinn
 RU Припой
 CZ Pájka
 RO Cositor
 HU Forrasztó ón
 ES Estaño plata



No.	Ø [mm]	m [g]	Box
76830	1	16	25/250

EN Solder stick
 PL Cyna w lasce
 DE Stangenlötzinn
 RU Припой
 CZ Pájka v tyčkách
 RO Bare de cositor
 HU Forrasztó rúd
 ES Barra estaño plomo



No.	Dimensions / Wymiary [mm]	m [kg]	Box
76832	7x7x322	5	1

EN Solder
 PL Spoiwo lutownicze
 DE Lötzinn
 RU Припой
 CZ Pájka
 RO Cositor
 HU Forrasztó ón
 ES Estaño plata



No.	Ø [mm]	m [g]	Box
76800	0.5	100	30
76806	0.7	100	30
76807	0.7	250	20
76810	1.0	100	30
76811	1.0	250	20
76814	1.5	100	30
76815	1.5	250	20
76818	2.0	100	30
76819	2.0	250	20
76822	2.5	100	30
76823	2.5	250	20
76826	3.0	100	30

EN Lead free solder
 PL Spoiwo lutownicze bezolowiowe
 DE Bleifreier Lötdraht
 RU Бессвинцовый припой
 CZ Bezolovnaté pájkové poivo
 RO Cositor fără plumb
 HU Ólommentes forrasztóón
 ES Estaño para soldar sin plomo



No.	Ø [mm]	m [g]	Box
76850	0.5	100	30
76851	0.7	100	30
76852	1.0	100	30
76853	1.0	250	20
76854	1.5	100	30
76855	1.5	250	20
76856	2.0	100	30
76857	2.0	250	20
76858	2.5	100	30
76859	3.0	100	30

- EN Lead free solder in a phial
 PL Spoiwo lutownicze bezolowiowe fiołka
 DE Bleifreier Lötdraht im Spenderröhrchen
 RU Бессвинцовый припой флакон
 CZ Bezolovnaté rájkové pojivo lahvička
 RO Tub de cositor fără plumb
 HU Ólommentes forrasztóó fiola
 ES Estaño para soldar sin plomo, en ampolla



Sn99.3
Cu07



No.	Ø [mm]	m [g]	
76870	1.0	14	250

- EN Solder rods without flux
 PL Pręty lutownicze bez topnika
 DE Lötstangen ohne Flussmittel
 RU Паяльные стержни без флюса
 CZ Rájecí tyče bez tavidla
 RO Bare de cositor
 HU Forrasztórúd gyanta nélkül
 ES Barras de soldadura sin fundente

Sn99.3
Cu07



No.	Ø [mm]	m [g]	
76877	0.4	200	30

- EN Solder paste
 PL Pasta lutownicza
 DE Lotpaste
 RU Паяльная паста
 CZ Rájecí pasty
 RO Pastă decapantă
 HU Forrasztó paszta
 ES Pasta de soldar

FLUX
TOPNIK
1:1,2:C
PN EN 29454



No.	m [g]	
76835	40	50

- EN Desoldering pump
 PL Odsysacz do cyny
 DE Entlötsaugpumpe
 RU Шприц для удаления припоя
 CZ Odrájecí sací pumpa
 RO Pompa fluidor
 HU Ónszippantó
 ES Bomba desoldadora

PTFE



No.	
79390	100/400

- EN Soft solder
 PL Spoiwo do instalacji miedzianych
 DE Lötdraht für Kupferinstallationen
 RU Припой для медных установок
 CZ Pojivo pro měděné instalace
 RO Cositor fără plumb
 HU Forrasztóó rézhéz
 ES Aglutinante para instalaciones de cobre

Sn97
Cu3



No.	Ø [mm]	m [g]	
76880	1.5	100	60
76881	2.0	100	60
76882	2.0	250	50
76883	2.5	100	60
76884	2.5	250	50

- EN Rosin
 PL Kalafonia lutownicza
 DE Kolophonium
 RU Канифоль
 CZ Kalafuna
 RO Colofoniu
 HU Forrasztó gyanta
 ES Colofonia



No.	m [g]	
76836	45	50

- EN Desoldering pump
 PL Odsysacz do cyny
 DE Entlötsaugpumpe
 RU Шприц для удаления припоя
 CZ Odrájecí sací pumpa
 RO Pompa fluidor
 HU Ónszippantó
 ES Bomba desoldadora

PTFE



No.	
79391	70/140

EN Pumping hose for motor pumps with terminals
 PL Wąż tłoczny do motopomp z końcówkami
 DE Druckschlauch für Motorpumpen mit Anschlussstücken
 RU Напорный рукав для мотопомп с наконечниками
 CZ Výtlačná hadice s koncovkami pro motorová čerpadla
 RO Furtun pt. motopompe cu capete
 HU Szivattyú nyomótömlő kapszokkal szerelve
 ES Manguera para bombear para motobombas con terminales



No.	L [m]	Ø	Max. operating pressure / Maks. ciśnienie robocze [bar]	Bursting pressure / Ciśnienie rozrywające [bar]	
79977	20	2" (50.0 mm)	6	24	1
79978	20	3" (75.0 mm)	6	24	1
79979	20	4" (100.0 mm)	6	24	1

EN Suction hose
 PL Wąż ssawny do pomp
 DE Saugschlauch für Pumpen
 RU Всасывающий шланг для насосов
 CZ Sací hadice do čerpadel
 RO Furtun aspiratie
 HU Szivattyútömlő
 ES Manguera de succión para bomba



No.	L [m]	Water outlet diameter / Średnica przyłącza wody	
79823	5	1" (25.0 mm)	6
79824	7	1" (25.0 mm)	4

EN Pumping hose for motor pumps
 PL Wąż tłoczny do motopomp
 DE Druckschlauch für Motorpumpen
 RU Напорный рукав для мотопомп
 CZ Výtlačná hadice pro motorová čerpadla
 RO Furtun pt. motopompe
 HU Szivattyú nyomótömlő
 ES Manguera para bombear para motobombas



No.	L [m]	Ø	Max. operating pressure / Maks. ciśnienie robocze [bar]	Bursting pressure / Ciśnienie rozrywające [bar]	
79982	50	1" (25.0 mm)	2	6	1
79983	50	2" (50.0 mm)	2	6	1
79984	50	3" (75.0 mm)	2	6	1



Memo

16

Welding equipment Sprzęt spawalniczy

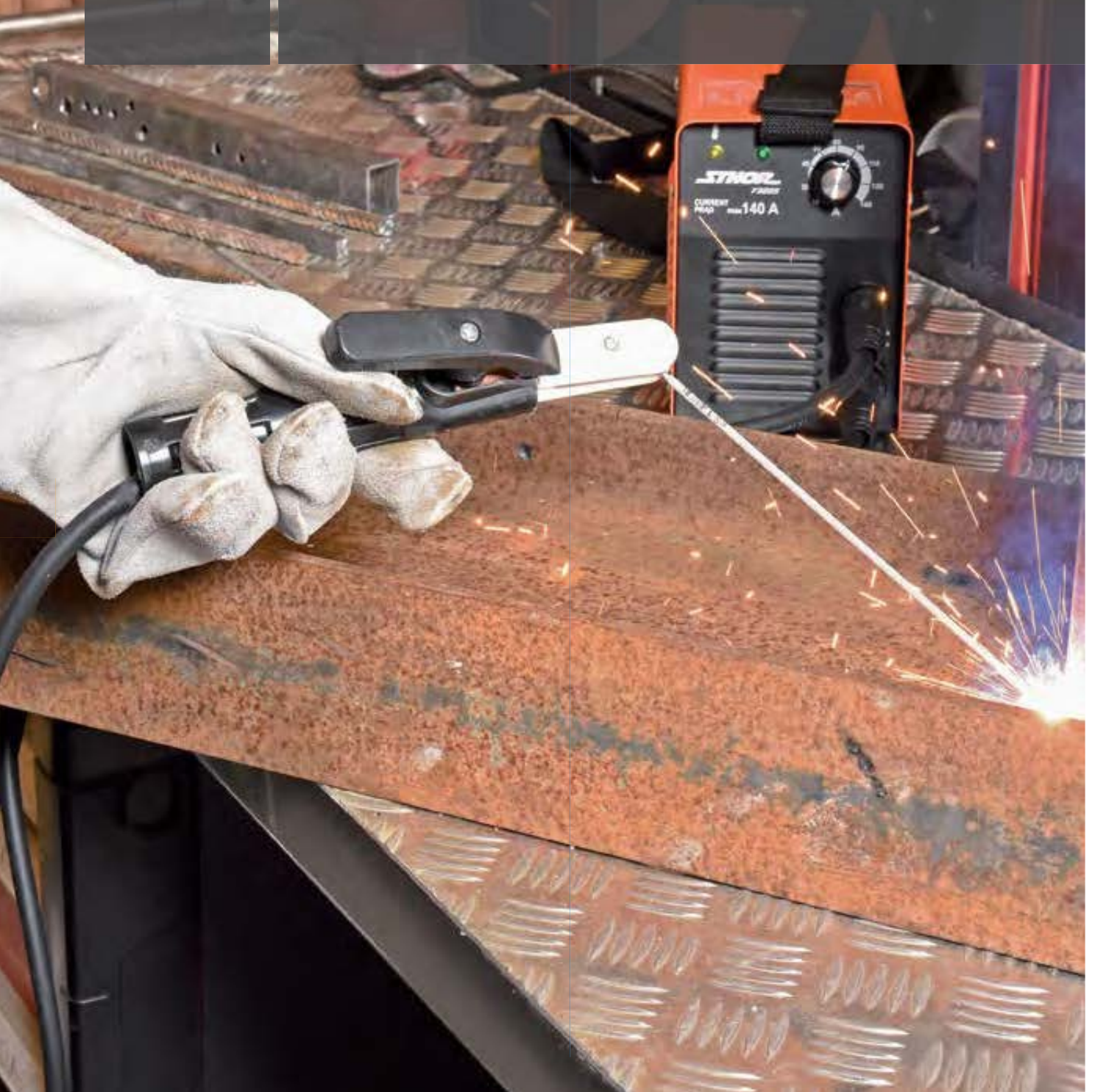

Welding accessories
Akcesoria spawalnicze

.....278-281

Clamps

Zaciski spawalnicze..... 278

Welding goggles & masks

Okulary i maski spawalnicze..... 278

- EN Clamp
- PL Zacisk spawalniczy biegunowo-kleszczowy
- DE Schweisseklemme
- RU Клещи для сварки
- CZ Kľeště svářečské zemnicí
- RO Clește pt. sudura
- HU Testkábel-csatlakozó
- ES Cocodrilo para soldar



No.	Max. welding current / Maks. prąd spawania [A]	Earthing cable diameter / Średnica przewodu masowego [mm ²]	Max. jaws range / Maks. rozwarcie szczęk [mm]	m [kg]	Type / Typ	
74420	160	35	50	0.21	ZBK-35	25
74421	315	70	60	0.25	ZBK-70	25
74422	520	95	70	0.29	ZBK-95	25

- EN Welding goggles
- PL Okulary spawalnicze
- DE Schweisserbrille
- RU Очки газосварщика
- CZ Brýle svářečské
- RO Ochelari pt. sudura
- HU Hegesztőszemüveg
- ES Gafas para soldar



No.	
74410	5/100

- EN Welding mask
- PL Maska spawalnicza
- DE Schweissermaske
- RU Щиток сварщика
- CZ Svářečská maska
- RO Mască de sudură
- HU Hegesztőpajzs
- ES Mascara de soldador



No.	Type / Typ	
74440	TSM-3	30

- EN Electrode holder
- PL Uchwyt spawalniczy elektrodowy
- DE Schweisselektrodengriff
- RU Клещи для сварки (электродные)
- CZ Držák elektrod
- RO Clește portelectrod
- HU Elektrodafogó
- ES Abrazadera para soldar, de electrodos



No.	Max. welding current / Maks. prąd spawania [A]	Welding electrode clamping range / Zakres zaciskanych elektrod [mm]	Welding cable cross section / Przekrój przewodu spawalniczego [mm ²]	m [kg]	Type / Typ	
74430	200 (X=60%) / 315 (X=35%)	2-5	35-50	0.32	UE-200	25
74431	315 (X=60%) / 400 (X=35%)	2.5-6.3	50-70	0.42	UE-300	25
74432	430 (X=60%) / 530 (X=35%)	3.5-6.3	70-95	0.5	UE-400	25

- EN Welding goggles
- PL Okulary spawalnicze
- DE Schweisserbrille
- RU Очки газосварщика
- CZ Brýle svářečské
- RO Ochelari pt. sudura
- HU Hegesztőszemüveg
- ES Gafas para soldar



No.	
74411	10/100

- EN Welding mask
- PL Maska spawalnicza
- DE Schweissermaske
- RU Щиток сварщика
- CZ Svářečská maska
- RO Mască de sudură
- HU Hegesztőpajzs
- ES Mascara de soldador



No.	Type / Typ	
74442	TSM	30

EN Welding mask
 PL Przyłbica spawalnicza z podglądem
 DE Schweissermaske
 RU Щиток сварщика с подсмотром
 CZ Svářečská přilba s nakoukáváním
 RO Mască de sudură
 HU Hegesztősisak kitekintővel
 ES Mascara de soldador con mirador



No.	Type / Typ	
74443	TSPM	20

EN Welding mask
 PL Przyłbica spawalnicza z podglądem
 DE Schweissermaske
 RU Щиток сварщика с подсмотром
 CZ Svářečská přilba s nakoukáváním
 RO Mască de sudură
 HU Hegesztősisak kitekintővel
 ES Mascara de soldador con mirador



No.	Type / Typ	
74447	PSMP	20

EN Welding mask
 PL Przyłbica spawalnicza
 DE Schweissermaske
 RU Щиток сварщика
 CZ Svářecí kukla
 RO Mască de sudură
 HU Hegesztőpajzs
 ES Pantalla de soldar



VOREL

No.	
74457	20

EN Welding mask
 PL Maska spawalnicza
 DE Schweissermaske
 RU Щиток сварщика
 CZ Svářečská maska
 RO Mască de sudură
 HU Hegesztőpajzs
 ES Mascara de soldador



No.	Type / Typ	
74450	TSD-3	18

EN Welding mask
 PL Maska spawalnicza
 DE Schweissermaske
 RU Щиток сварщика
 CZ Svářečská maska
 RO Mască de sudură
 HU Hegesztőpajzs
 ES Mascara de soldador

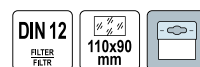

VOREL

No.	
74441	20

EN Auto-darkening welding helmet
 PL Przyłbica spawalnicza samościenniająca
 DE Selbstverdunkelnde Schweißmaske
 RU Маска сварщика с автос затемнением
 CZ Samostmívající svářecí kukla
 RO Mască de sudură auto-întunecare
 HU Magától sötétedő hegesztőpajzs
 ES Pantalla de soldar con oscurecimiento automático



STIKOR

No.	
74480	6

- EN Auto-darkening welding helmet
- PL Przyłbica spawalnicza samościemniająca
- DE Selbstverdunkelnde Schweißmaske
- RU Маска сварщика с автозатемнением
- CZ Samostmívací sváreční kukla
- RO Mască de sudură auto-întunecare
- HU Magától sötétedő hegesztőpajzs
- ES Pantalla de soldar con oscurecimiento automático

TRUE COLOR	DIN 9-13	DIN 4	1 1 1 2 <small>OPTICAL CLASS KLASA OPTYCZNA</small>	92x42 mm
2 <small>ARC SENSOR CZUJNIKI ŁUKU</small>	1/25000s <small>REACTION TIME CZAS REAKCJI</small>	0.1-1.0s	DIN 16 UV/IR	SOLAR CELL OGNIWO SŁONECZNE
1x <small>CR2032</small>	3-POINT HEADGEAR WIEŻBA 3-PUNKTOWA	°C -5 +55	MIG/MAG MMA/TIG	TITLED FRAME UCHYLNIA OPRAWA
		GRINDING SZLIFOWANIE		



STHOR

No.	6
74487	6

- EN Auto-darkening welding helmet
- PL Przyłbica spawalnicza samościemniająca
- DE Selbstverdunkelnde Schweißmaske
- RU Маска сварщика с автозатемнением
- CZ Samostmívací sváreční kukla
- RO Mască de sudură auto-întunecare
- HU Magától sötétedő hegesztőpajzs
- ES Pantalla de soldar con oscurecimiento automático

TRUE COLOR	DIN 9-13	DIN 4	1 1 1 2 <small>OPTICAL CLASS KLASA OPTYCZNA</small>	92x42 mm
2 <small>ARC SENSOR CZUJNIKI ŁUKU</small>	1/25000s <small>REACTION TIME CZAS REAKCJI</small>	0.1-1.0s	DIN 16 UV/IR	SOLAR CELL OGNIWO SŁONECZNE
1x <small>CR2032</small>	3-POINT HEADGEAR WIEŻBA 3-PUNKTOWA	°C -5 +55	MIG/MAG MMA/TIG	TITLED FRAME UCHYLNIA OPRAWA
		GRINDING SZLIFOWANIE		



STHOR

No.	6
74486	6

- EN Auto-darkening welding helmet
- PL Przyłbica spawalnicza samościemniająca
- DE Selbstverdunkelnde Schweißmaske
- RU Маска сварщика с автозатемнением
- CZ Samostmívací sváreční kukla
- RO Mască de sudură auto-întunecare
- HU Magától sötétedő hegesztőpajzs
- ES Pantalla de soldar con oscurecimiento automático

TRUE COLOR	DIN 11	DIN 3	1 1 1 2 <small>OPTICAL CLASS KLASA OPTYCZNA</small>	90x35 mm
2 <small>ARC SENSOR CZUJNIKI ŁUKU</small>	1/15000s <small>REACTION TIME CZAS REAKCJI</small>	0.4 s	DIN 16 UV/IR	SOLAR CELL OGNIWO SŁONECZNE
1x <small>CR2032</small>	3-POINT HEADGEAR WIEŻBA 3-PUNKTOWA	°C -5 +55	MIG/MAG MMA	TITLED FRAME UCHYLNIA OPRAWA



STHOR

No.	6
74485	6

- EN Filter shield
- PL Oslona filtra
- DE Filterabdeckung
- RU Кожух фильтра
- CZ Ochrana filtru
- RO Filtru mască de sudură
- HU Szűrőfedél
- ES Protección de filtro



No.	Filter size / Rozmiar filtra [mm]	Dark state / Stan ciemny [DIN]	6
74451	50x100	0	100

- EN Welding filter
- PL Filtr spawalniczy
- DE Vorsatzglas
- RU Фильтр для сварки
- CZ Filtr svářečský
- RO Filtru mască sudură
- HU Hegesztőszűrő
- ES Pantalla de filtro de soldador



No.	Filter size / Rozmiar filtra [mm]	Dark state / Stan ciemny [DIN]	6
74452	50x100	8	100
74453	50x100	9	100
74454	50x100	10	100
74455	50x100	11	100

- EN Self-dimming helmet filter protection
- PL Osłona filtra przyłbicy samościemniającej
- DE Filtereinsatz eines selbstabdunkelnden Schutzhelmes
- RU Кожух фильтра самозатемняющегося щитка
- CZ Ochranná fólie filtru samostmívací kukly
- RO Carcasă filtru vizieră helimată
- HU Hegesztőpajzs szűrő, önsötétedő
- ES Protección del filtro de visera autooscurecedora



No.	Filter size / Rozmiar filtra [mm]	pcs / szt.	
74439	90x110	5	20

Memo

17

Safes, padlocks & locks Sejfy, klódky i zamki



Safes
Sejfy

.....284

**Key boxes**
Skrzynki na klucze

.....284

**Cash boxes**
Kasetki na pieniądze

.....284-285

**Padlocks**
Kłódki

.....285-287

**Cast iron padlocks**

Kłódki żeliwne

.....285

Brass padlocks

Kłódki mosiężne

.....286

Steel padlocks

Kłódki stalowe

.....287

Lock cylinders & bodies
Wkładki do zamków i zamki

.....287-288

**Brass lock cylinders**

Wkładki mosiężne

.....287

Safety chains

Łańcuchy do drzwi

.....288

EN Safe with digital lock
 PL Sejf z zamkiem cyfrowym
 DE Seif mit Digitalschloss
 RU Сейф с электронным замком

CZ Pancéřová pokladna z digitálním zámkem
 RO Seif cu închidere electronică
 HU Számszáras széf
 ES Caja de seguridad con cerradura digital

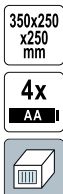

No.	Dimensions / Wymiary [mm]	
78641	350x250x250	1

EN Key box
 PL Skrzynka na klucze
 DE Schlüsselkasten
 RU Ящик для ключей
 CZ Skříňka na klíče
 RO Cutie pt. chei
 HU Kulcstartó doboz
 ES Caja para llaves

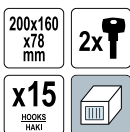

No.	Dimensions / Wymiary [mm]	
78432	200x160x78	20

EN Key box
 PL Skrzynka na klucze
 DE Schlüsselkasten
 RU Ящик для ключей
 CZ Skříňka na klíče
 RO Cutie pt. chei
 HU Kulcstartó doboz
 ES Caja para llaves



No.	Dimensions / Wymiary [mm]	
78436	450x380x80	5

EN Cash box
 PL Kasetka na pieniądze
 DE Geldkassette
 RU Ящик для денег
 CZ Kazeta na peníze
 RO Casetă (cutie) pt. bani
 HU Pénzes kasszeta
 ES Caja para efectivo



No.	Dimensions / Wymiary [mm]	Color / Kolor	
78622	200x160x90	czarny	10

EN Safe with digital lock
 PL Sejf z zamkiem cyfrowym
 DE Seif mit Digitalschloss
 RU Сейф с электронным замком

CZ Pancéřová pokladna z digitálním zámkem
 RO Seif cu închidere electronică
 HU Számszáras széf
 ES Caja de seguridad con cerradura digital

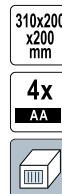

No.	Dimensions / Wymiary [mm]	
78642	310x200x200	1

EN Key box
 PL Skrzynka na klucze
 DE Schlüsselkasten
 RU Ящик для ключей
 CZ Skříňka na klíče
 RO Cutie pt. chei
 HU Kulcstartó doboz
 ES Caja para llaves

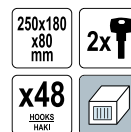

No.	Dimensions / Wymiary [mm]	
78434	250x180x80	10

EN Cash box
 PL Kasetka na pieniądze
 DE Geldkassette
 RU Ящик для денег
 CZ Kazeta na peníze
 RO Casetă (cutie) pt. bani
 HU Pénzes kasszeta
 ES Caja para efectivo

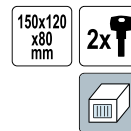

No.	Dimensions / Wymiary [mm]	Color / Kolor	
78620	150x120x80	czarny	20

EN Cash box
 PL Kasetka na pieniądze
 DE Geldkassette
 RU Ящик для денег
 CZ Kazeta na peníze
 RO Casetă (cutie) pt. bani
 HU Pénzes kasszeta
 ES Caja para efectivo

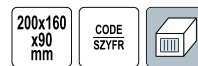

No.	Dimensions / Wymiary [mm]	Color / Kolor	
78624	200x160x90	czarny	10

EN Cash box
 PL Kasetka na pieniądze
 DE Geldkassette
 RU Ящик для денег
 CZ Kasetka na peníze
 RO Casetă (cutie) pt. bani
 HU Pénzes kasszeta
 ES Caja para efectivo

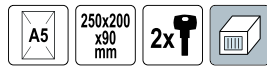

No.	Dimensions / Wymiary [mm]	Color / Kolor	
78626	250x200x90	czarny	10

EN Cash box
 PL Kasetka na pieniądze
 DE Geldkassette
 RU Ящик для денег
 CZ Kasetka na peníze
 RO Casetă (cutie) pt. bani
 HU Pénzes kasszeta
 ES Caja para efectivo

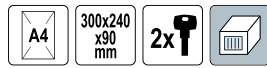

No.	Dimensions / Wymiary [mm]	Color / Kolor	
78630	300x240x90	czarny	10

EN Iron padlock
 PL Kłódka żelazna
 DE Vorhängeschloss
 RU Замок навесной
 CZ Stavební visací zámek
 RO Lacăt pt. construcții
 HU Óriás lakat
 ES Candado de hierro fundido



No.	Size / Rozmiar [mm]	
77061	32	12/120
77062	38	12/120
77063	50	6/60
77064	63	6/36

EN Cash box
 PL Kasetka na pieniądze
 DE Geldkassette
 RU Ящик для денег
 CZ Kasetka na peníze
 RO Casetă (cutie) pt. bani
 HU Pénzes kasszeta
 ES Caja para efectivo

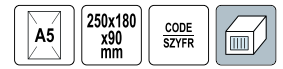

No.	Dimensions / Wymiary [mm]	Color / Kolor	
78628	250x180x90	czarny	10

EN Cash box
 PL Kasetka na pieniądze
 DE Geldkassette
 RU Ящик для денег
 CZ Kasetka na peníze
 RO Casetă (cutie) pt. bani
 HU Pénzes kasszeta
 ES Caja para efectivo



No.	Dimensions / Wymiary [mm]	Color / Kolor	
78632	180x115x55	czarny	24
78633	240x155x55	czarny	20

EN Alloy covered iron padlock
 PL Kłódka żelazna powlekana
 DE Vorhängeschloss
 RU Замок навесной
 CZ Stavební visací zámek
 RO Lacăt pt. construcții
 HU Óriás lakat
 ES Candado de hierro fundido



No.	Size / Rozmiar [mm]	
77004	40	12/96
77005	50	12/72
77006	60	12/48

- EN Rectangular brass padlock
- PL Klódka trzypieniowa
- DE Messigvorhängeschloss
- RU Стержневой навесной замок латунный
- CZ Visací zámek čerový
- RO Lacăt dreptunghiular
- HU Réz hengerzáras u lakat
- ES Candado de latón de mandril



No.	Size / Rozmiar [mm]	
77210	50	6/120
77211	65	6/96
77212	75	6/60
77213	90	6/36

- EN Combination padlock
- PL Klódka szyfrowa
- DE Vorhängezahlenschloss
- RU Замок навесной кодовый
- CZ Visací zámek s číselným kódem
- RO Lacăt alama cu cifru
- HU Számszáras lakat
- ES Candado combinación

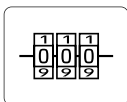

No.	Size / Rozmiar [mm]	
77606	25	12/120

17

- EN Combination padlock
- PL Klódka szyfrowa
- DE Vorhängezahlenschloss
- RU Замок навесной кодовый
- CZ Visací zámek s číselným kódem
- RO Lacăt alama cu cifru
- HU Számszáras lakat
- ES Candado combinación

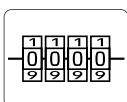

No.	Size / Rozmiar [mm]	
77608	40	12/120

- EN Plated brass padlock
- PL Klódka mosiężna
- DE Vorhängeschloss
- RU Замок навесной латунный
- CZ Zámek visací mosazný
- RO Lacăt alamă
- HU Lakat sárgaréz
- ES Candado de latón



No.	Size / Rozmiar [mm]	
77250	25	12/600
77300	30	12/480
77350	35	12/300
77400	40	12/240
77500	50	12/144
77600	60	12/144

- EN Combination padlock
- PL Klódka szyfrowa
- DE Vorhängezahlenschloss
- RU Замок навесной кодовый
- CZ Visací zámek s číselným kódem
- RO Lacăt alama cu cifru
- HU Számszáras lakat
- ES Candado combinación

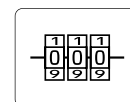

No.	
77607	12/120

- EN Combination padlock
- PL Klódka szyfrowa
- DE Vorhängezahlenschloss
- RU Замок навесной кодовый
- CZ Visací zámek s číselným kódem
- RO Lacăt alama cu cifru
- HU Számszáras lakat
- ES Candado combinación

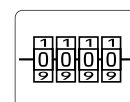

No.	Size / Rozmiar [mm]	
77609	50	6/48

EN Combination padlock
 PL Kłódka sztyfrowa
 DE Vorhängezählenschloss
 RU Замок навесной кодовый
 CZ Visací zámek s číselným kódem
 RO Lacăt alama cu cifru
 HU Számszáras lakat
 ES Candado combinación

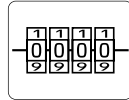

VOREL

No.	Size / Rozmiar [mm]	
77612	50	6/48

EN Plated brass padlock
 PL Kłódka mosiężna
 DE Vorhängeschloss
 RU Замок навесной латунный
 CZ Zámek visací mosazný
 RO Lacăt alamă
 HU Lakat sárgaréz
 ES Candado de latón



No.	Size / Rozmiar [mm]	
77700	40x105	12/240

EN Wire safety padlock with nylon isolation
 PL Kłódka powlekana nylonem z linką
 DE Vorhängeschloss nylonbeschichtet mit Seil
 RU Навесной замок с нейлоновым покрытием и тросиком
 CZ Visací zámek potažený nylonem s lanekem
 RO Lacăt cu coardă din oțel
 HU Nylon burkolatú huzalos lakat
 ES Candado revestido con nailon y cable



VOREL

No.	
77705	10/120

EN Aluminium safety lock out hasp
 PL Aluminiowa blokada kłammerowa
 DE Multi-Schließklammer aus Aluminium
 RU Алюминиевый замок-скоба
 CZ Sponková blokáda hliníková
 RO Siguranta blocare din aluminiu
 HU Alumínium lakatolható csatos zár
 ES Aldaba de seguridad de aluminio

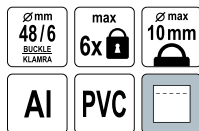

VOREL

No.	L [mm]	Size / Rozmiar [mm]	Key quantity / Liczba kluczy	
77200	62	31/31	3	12/72
77203	72	31/41	3	12/72
77204	67	31/36	3	12/72
77205	87	36/51	3	12/72

EN Combination padlock
 PL Kłódka sztyfrowa
 DE Vorhängezählenschloss
 RU Замок навесной кодовый
 CZ Visací zámek s číselným kódem
 RO Lacăt alama cu cifru
 HU Számszáras lakat
 ES Candado combinación

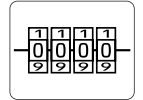

VOREL

No.	Size / Rozmiar [mm]	
77618	50	6/48

EN Safety padlock with nylon isolated body
 PL Kłódka specjalna z korpusem zabezpieczonym tworzywem
 DE Spezielles Vorhängeschloss, Körper mit Kunststoff gesichert
 RU Специальный навесной замок с пластиковой защитой
 CZ Speciální visací zámek, tělo zajištěno plastem
 RO Lacăt cu corp izolat din nailon
 HU Speciális lakat műanyaggal védett ház
 ES Candado especial cuerpo, protegido con plástico



VOREL

No.	
77700	10/100

EN Steel safety lock out hasp
 PL Stalowa blokada kłammerowa
 DE Multi-Schließklammer aus Stahl
 RU Стальной замок-скоба
 CZ Svonková blokáda ocelová
 RO Dispozitiv multi-lacăt
 HU Acél lakatolható csatos zár
 ES Aldaba de seguridad de acero

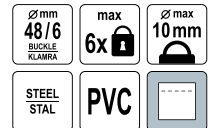

VOREL

No.	
77705	10/200

EN Lock cylinder
 PL Wkładka do zamka
 DE Schliesszylinder
 RU Личинка замка латунная



VOREL

No.	L [mm]	Size / Rozmiar [mm]	Key quantity / Liczba kluczy	
77200	62	31/31	3	12/72
77203	72	31/41	3	12/72
77204	67	31/36	3	12/72
77205	87	36/51	3	12/72

EN Lock cylinder
 PL Wkładka do zamka chromowana
 DE Schliesszylinder
 RU Личинка замка
 CZ Vložka na zámek
 RO Yală pt. broască
 HU Zárbetét
 ES Inserción cromado



No.	L [mm]	Size / Rozmiar [mm]	Key quantity / Liczba kluczy	
77170	62	31/31	3	12/72

EN Lock cylinder
 PL Wkładka do zamka chromowana
 DE Schliesszylinder
 RU Личинка замка
 CZ Vložka na zámek
 RO Yală pt. broască
 HU Zárbetét
 ES Inserción cromado



No.	L [mm]	Size / Rozmiar [mm]	Key quantity / Liczba kluczy	
77180	62	31/31	6	12/72

EN Safety chain
 PL Łańcuch do drzwi
 DE Türsicherungskette
 RU Замок-цепь для двери

CZ Řetěz na dveře
 RO Lanț pt. ușă
 HU Ajtólánc
 ES Cadena para puerta



No.		
77910		12/120

EN Lock cylinder
 PL Wkładka do zamka
 DE Schliesszylinder
 RU Личинка замка латунная
 CZ Vložka na zámek
 RO Yală pt. broască
 HU Zárbetét
 ES Inserción cromado



No.	L [mm]	Size / Rozmiar [mm]	Key quantity / Liczba kluczy	
77190	62	31/31	6	12/72
77191	67	31/36	6	12/72
77192	72	31/41	6	12/72
77193	87	36/51	6	12/72

EN Safety chain
 PL Łańcuch do drzwi
 DE Türsicherungskette
 RU Замок-цепь для двери

CZ Řetěz na dveře
 RO Lanț pt. ușă
 HU Ajtólánc
 ES Cadena para puerta



No.	
77900	12/120

EN Key holders
 PL Zawieszki plastikowe do kluczy
 DE Schlüsselanhänger
 RU Брелок для ключей
 CZ Přívěšek na klíče
 RO Breloc
 HU Kulcstartó
 ES Llaveros de plástico



No.	pcs / szt.	
77930	12	12/120

Memo

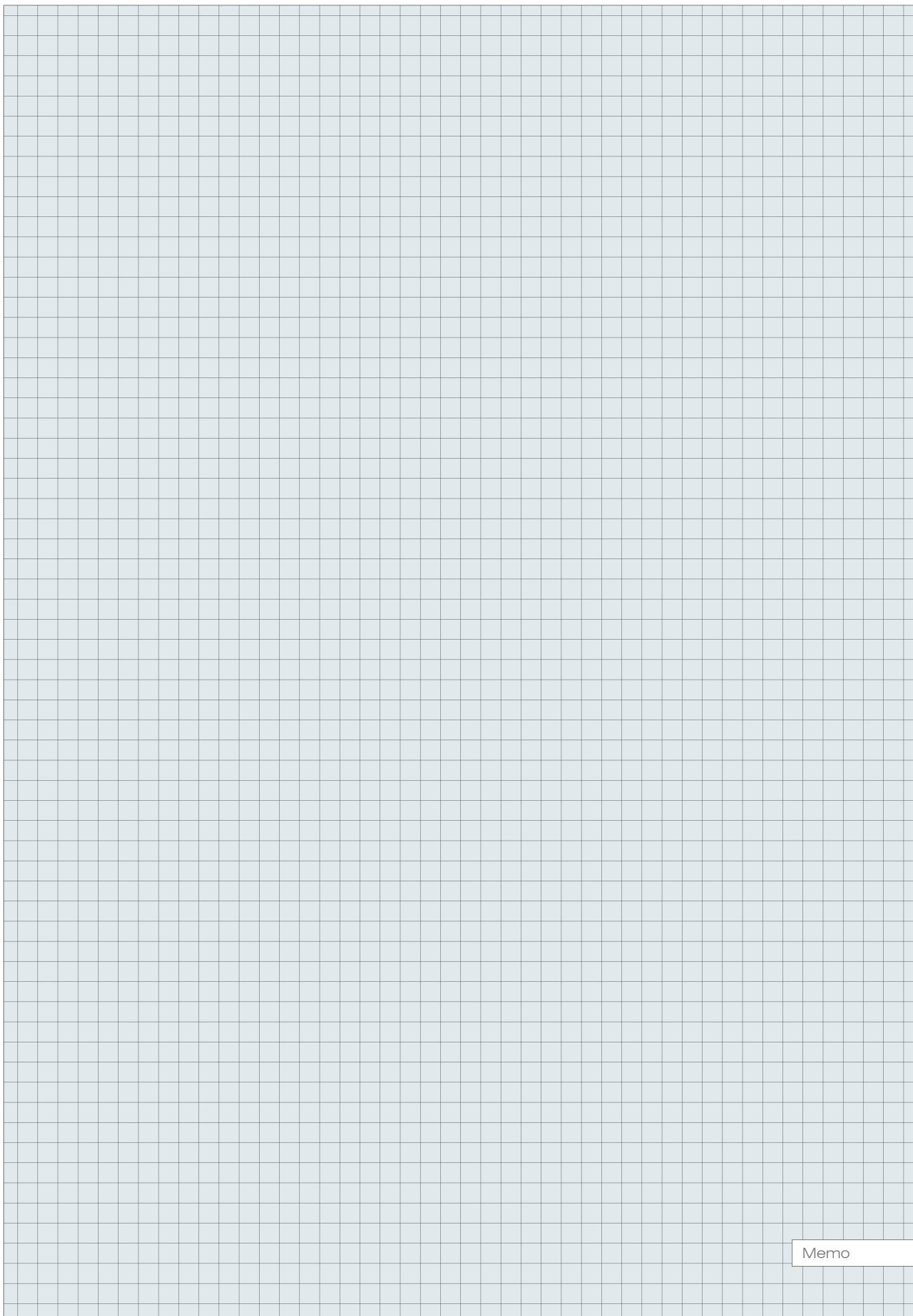





Memo

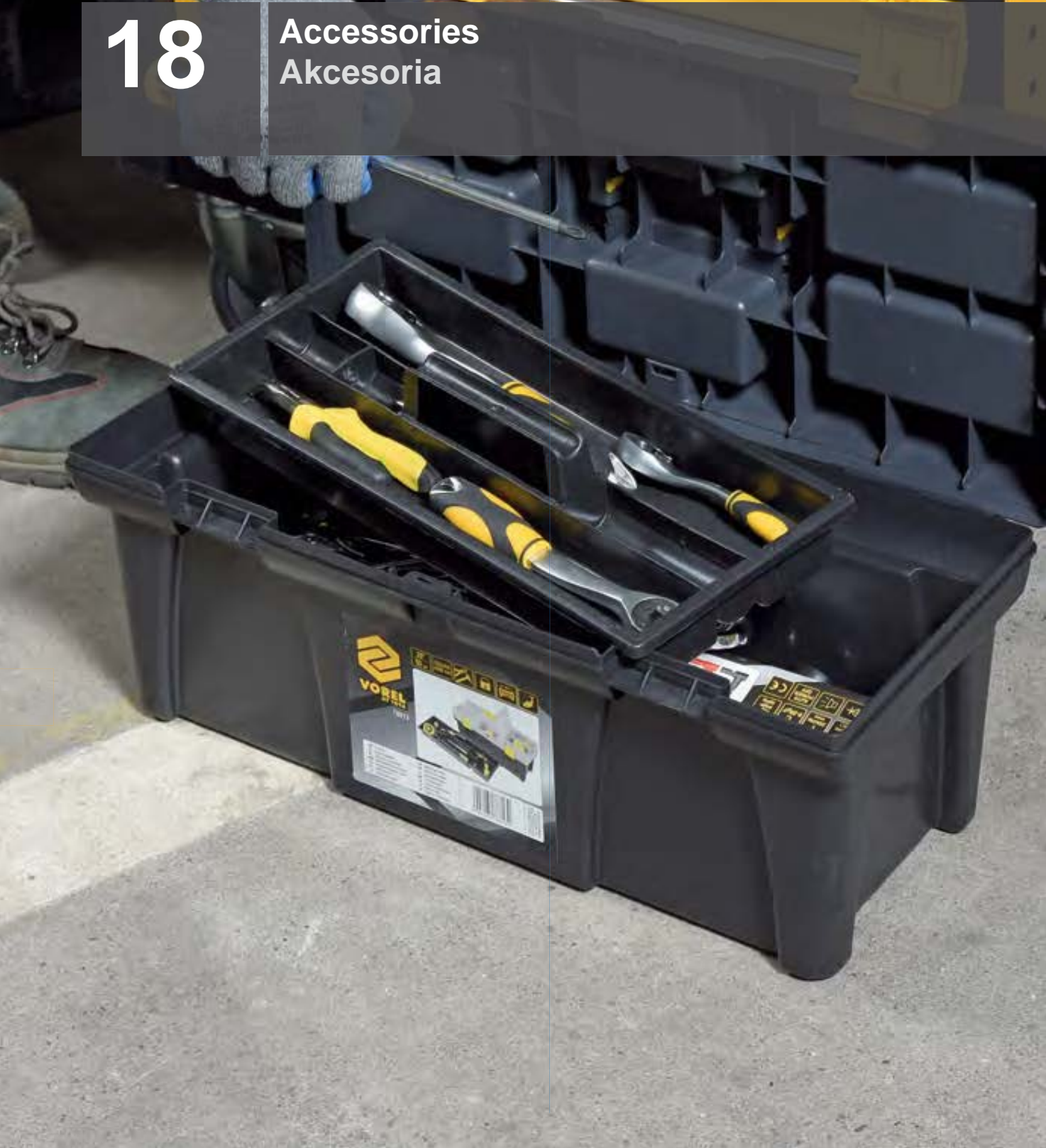

18

Accessories Akcesoria



Tool belts Pasy na narzędzia	
.....292	
Tool bags Torby narzędziowe	
.....292	
Trolley tool boxes Wózki narzędziowe	
.....292-293	
Tool boxes Skrzynki narzędziowe	
.....293-295	

- EN Tool belt with fixed bags
 PL Pas narzędziowy z naszytymi torbami
 DE Werkzeuggürtel mit Taschen
 RU Пояс для инструментов с карманами
 CZ Opasek na nářadí s taškami
 RO Centură de scule cu buzunare fixe
 HU Szerszám öv táská
 ES Cinturón para herramientas con bolsas



No.	
78751	24

- EN Tool belt
 PL Pas narzędziowy
 DE Werkzeuggürtel
 RU Инструмент пояса
- CZ Opasek s nářadím
 RO Centura scule
 HU Szerszám öv
 ES Cinturón para herramientas

No.	
78750	50

- EN Tool bag
 PL Torba narzędziowa
 DE Werkzeugtasche
 RU Сумка для инструментов
 CZ Brašna na nářadí
 RO Geantă pt. scule
 HU Szerszámtáska
 ES Bolsa para herramientas



18

No.	Dimensions / Wymiary [mm]	
78720	430x285x170	2

- EN Tool bag
 PL Torba narzędziowa
 DE Werkzeugtasche
 RU Сумка для инструментов
 CZ Brašna na nářadí
 RO Geantă pt. scule
 HU Szerszámtáska
 ES Bolsa para herramientas



No.	Dimensions / Wymiary [mm]	
78730	400x260x140	2

- EN Tool belt with sliding bags
 PL Pas narzędziowy stolarski z przesuwanymi torbami
 DE Werkzeuggürtel mit Taschen
 RU Пояс для инструментов со сменными карманами
 CZ Opasek na nářadí s taškami
 RO Centură de scule cu buzunare glisante
 HU Szerszám öv táská
 ES Cinturón para herramientas con bolsas



No.	
78752	24



- EN 2-module tool trolley
 PL Wózek narzędziowy 2-częściowy
 DE Werkzeugtrolley 2-teilig
 RU Тележка инструментальная 2 секции
 CZ Vozík na nářadí 2 sekce
 RO Troler pt. scule cu 2 module
 HU Kerekes szerszámosláda 2 részes
 ES Carro de herramientas con 2 módulos



No.	
78731	1

EN Tool trolley with removable organizer
 PL Wózek narzędziowy z wyjmowanym organizerem
 DE Werkzeugtrolley mit abnehmbarem Organizer
 RU Тележка инструментальная с вынимаемым органайзером
 CZ Vozík na nářadí s odnímatelným organizérem
 RO Troler pt. scule tip organizator
 HU Kerekesherszámoszláda kivehető szervezővel
 ES Caja de herramientas con ruedas y organizador



No.	
78734	1

EN 3-module tool trolley
 PL Wózek narzędziowy 3-częściowy
 DE Werkzeugtrolley 3-teilig
 RU Тележка инструментальная 3 секции
 CZ Vozík na nářadí 3 sekce
 RO Troler pt. scule cu 3 module
 HU Kerekesherszámoszláda 3 részes
 ES Carro de herramientas con 3 módulos



No.	
78738	1

EN 3-module tool trolley
 PL Wózek narzędziowy 3-częściowy
 DE Werkzeugtrolley 3-teilig
 RU Тележка инструментальная 3 секции
 CZ Vozík na nářadí 3 sekce
 RO Troler pt. scule cu 3 module
 HU Kerekesherszámoszláda 3 részes
 ES Carro de herramientas con 3 módulos



No.	
78736	1

EN Toolbox
 PL Skrzynka narzędziowa
 DE Werkzeugkoffer
 RU Ящик для инструментов

CZ Skříňka na nářadí
 RO Cutie pt. scule
 HU Herszámoszláda
 ES Caja de herramientas



No.	Size / Rozmiar	Dimensions / Wymiary [mm]	
78801	12" (300 mm)	312x167x130	1
78800	16" (400 mm)	415x226x200	1

EN Toolbox
 PL Skrzynka narzędziowa
 DE Werkzeugkoffer
 RU Ящик для инструментов
 CZ Skříňka na nářadí
 RO Cutie pt. scule
 HU Szerszámosláda
 ES Caja de herramientas



VOREL

No.	Size / Rozmiar	Dimensions / Wymiary [mm]	
78802	20" (500 mm)	525x256x246	1

EN Toolbox
 PL Skrzynka narzędziowa
 DE Werkzeugkoffer
 RU Ящик для инструментов
 CZ Skříňka na nářadí
 RO Cutie pt. scule
 HU Szerszámosláda
 ES Caja de herramientas

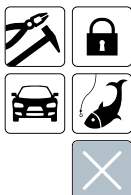

VOREL

No.	Size / Rozmiar	Dimensions / Wymiary [mm]	Load capacity / Nośność [kg]	
78814	20" (500 mm)	525x256x325	25+3	1

EN Storage bin cabinet
 PL Organizer modułowy
 DE Werkstatt-Schubladenwandregal
 RU Модульный органайзер
 CZ Box na nářadí s přihrádkami
 RO Organizator modular
 HU Moduláris szervező
 ES Organizador modular



VOREL

No.	Dimensions / Wymiary [mm]	Compartment quantity / Liczba przegródek	
78780	475x380x160	39 (9x duża, 30x mała)	4

EN Toolbox
 PL Skrzynka narzędziowa
 DE Werkzeugkoffer
 RU Ящик для инструментов
 CZ Skříňka na nářadí
 RO Cutie pt. scule
 HU Szerszámosláda
 ES Caja de herramientas



VOREL

No.	Size / Rozmiar	Dimensions / Wymiary [mm]	
78811	12" (300 mm)	312x167x130	1
78812	16" (400 mm)	415x226x200	1
78813	20" (500 mm)	525x256x246	1
78815	26" (650 mm)	595x337x316	1

EN Wall tool organizer
 PL Tablica narzędziowa
 DE Werkzeugtafel
 RU Панель для инструментов
 CZ Stěna na nářadí
 RO Panou cu organizatoare
 HU Fali panel szerszámokhoz
 ES Organizador de herramientas en pared



VOREL

No.	Compartment dimensions / Wymiary modulu [mm]	pcs / szt.	
78771	475x272x15	48	1

EN Organizer set
 PL Zestaw organizerów
 DE Organizer-Set
 RU Набор органайзеров
 CZ Organizéry na nářadí
 RO Set organizatore
 HU Szerszámtartó láda készlet
 ES Juego de organizadores

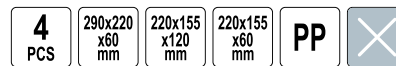

VOREL

No.	Dimensions / Wymiary [mm]	pcs / szt.	
78788	290x220x60, 220x155x120, 220x155x60	4	8

EN Workshop drawers
 PL Szufladki warsztatowe
 DE Werkstattschubfächer
 RU Ящики для инструментов
 CZ Skříňka se zásobníky
 RO Organizator cu sertare
 HU Műhely zsámoly fiókkal
 ES Cajones para taller



225x155
x100
mm



No.	Dimensions / Wymiary [mm]	Compartment quantity / Liczba przegródek	
78785	225x155x100	10	20

EN Organizer
 PL Organizer
 DE Werkzeugkaste
 RU Органайзер
 CZ Organizér
 RO Organizator
 HU Csavartartó doboz
 ES Caja



360x270
mm



No.	Dimensions / Wymiary [mm]	
78794	360x270	5

EN Storage case
 PL Pojemnik magazynowy
 DE Lagersichtbox
 RU Ящик для склада

CZ Box skladovací
 RO Cutie pt. depozitare
 HU Tárolók
 ES Contenedor de almacén



No.	Dimensions / Wymiary [mm]	Type / Typ	
78821	108x110x75	P-1	40
78822	160x115x75	P-2	40
78824	235x173x125	P-4	20
78825	340x200x150	P-5	9

EN Organizer
 PL Organizer
 DE Werkzeugkaste
 RU Органайзер
 CZ Organizér
 RO Organizator
 HU Csavartartó doboz
 ES Caja



300x220
x55
mm



No.	Dimensions / Wymiary [mm]	Compartment quantity / Liczba przegródek	
78791	300x220x55	10	10

EN Organizer
 PL Organizer
 DE Werkzeugkaste
 RU Органайзер
 CZ Organizér
 RO Organizator
 HU Csavartartó doboz
 ES Caja



460x320
mm



No.	Dimensions / Wymiary [mm]	
78819	460x320	5

EN Storage case
 PL Pojemnik magazynowy
 DE Lagersichtbox
 RU Ящик для склада

CZ Box skladovací
 RO Cutie pt. depozitare
 HU Tárolók
 ES Contenedor de almacén



No.	Dimensions / Wymiary [mm]	Type / Typ	
78830	116x112x75	XS	270
78831	116x161x75	S	190
78833	170x240x126	M	44
78834	204x340x155	L	27
78835	333x500x187	XL	7

19

Bicycle accessories Akcesoria rowerowe



Bicycle & motorcycle locks

Zamknięcia do rowerów i motocykli

.....298-299

**Bicycle pumps**

Pompki rowerowe

.....299-300

**Bicycle tools**

Narzędzia rowerowe

.....301



EN Bicycle lock
 PL Linka rowerowa
 DE Fahrradschloss
 RU Замок велосипедный
 CZ Zámek jízdního kola
 RO Antifurt pt. bicicleta
 HU Kerékpárzár
 ES Cable antirrobo para bicicletas



No.	L [cm]	Ø [mm]	Color / Kolor	
77830	65	8	czarny, niebieski, czerwony	12/120

EN Bicycle lock
 PL Linka rowerowa
 DE Fahrradschloss
 RU Замок велосипедный
 CZ Zámek jízdního kola
 RO Antifurt pt. bicicleta
 HU Kerékpárzár
 ES Cable antirrobo para bicicletas



No.	L [cm]	Ø [mm]	Color / Kolor	
77833	120	8	czarny, niebieski, czerwony	10/60
77834	120	10	czarny, niebieski, czerwony	10/60
77835	180	10	czarny, niebieski, czerwony	10/60

EN Bicycle lock
 PL Linka rowerowa
 DE Fahrradschloss
 RU Замок велосипедный
 CZ Zámek jízdního kola
 RO Antifurt pt. bicicleta
 HU Kerékpárzár
 ES Cable antirrobo para bicicletas

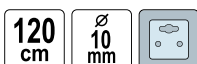

No.	L [cm]	Ø [mm]	Color / Kolor	
77845	120	10	czarny, niebieski, czerwony	20/40

EN Bicycle lock
 PL Linka rowerowa
 DE Fahrradschloss
 RU Замок велосипедный
 CZ Zámek jízdního kola
 RO Antifurt pt. bicicleta
 HU Kerékpárzár
 ES Cable antirrobo para bicicletas



No.	L [cm]	Ø [mm]	Color / Kolor	
77831	65	8	czarny, niebieski, czerwony	12/120

EN Bicycle lock
 PL Linka rowerowa
 DE Fahrradschloss
 RU Замок велосипедный
 CZ Zámek jízdního kola
 RO Antifurt pt. bicicleta
 HU Kerékpárzár
 ES Cable antirrobo para bicicletas



No.	L [cm]	Ø [mm]	Color / Kolor	
77837	120	8	czarny, niebieski, czerwony	10/60
77838	150	10	czarny, niebieski, czerwony	10/60

EN Bicycle lock
 PL Linka rowerowa
 DE Fahrradschloss
 RU Замок велосипедный
 CZ Zámek jízdního kola
 RO Antifurt pt. bicicleta
 HU Kerékpárzár
 ES Cable antirrobo para bicicletas



No.	L [cm]	Ø [mm]	Color / Kolor	
77840	180	12	czarny, niebieski, czerwony	10/40

EN Security cable and lock
 PL Linka stalowa z kłódką
 DE Stahlseil mit Vorhängeschloss
 RU Канат стальной с замком
 CZ Ocelové lanko s visacím zámkem
 RO Cablu de oțel cu lacăt
 HU Drótkötél, lakattal
 ES Cuerda de acero con candado

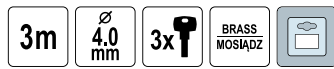

No.	L [m]	Ø [mm]	
77815	3	4	12/48

EN Motorcycle lock
 PL Zapięcie motocyklowe
 DE Stahlgliederschloss
 RU Замок до мотоцикла
 CZ Zámek na kolo
 RO Anti-furt motocicletă
 HU Láncaklat motorbiciklihez
 ES Candado para Moto



No.	L [cm]	Ø [mm]	
77861	150	25	6/12

EN Double cylinder aluminium hand pump
 PL Teleskopowa pompka aluminiumowa
 DE Aluminium Handpumpe Doppelzylinder
 RU Насос телескопический алюминиевый
 CZ Pumpa ruční double-pístové hliníkové
 RO Pompă telescopică pt. bicicletă
 HU Pumpa alumínium dupla dugattyús
 ES Bomba de mano de doble cilindro de aluminio



No.	
82031	60

EN Foot pump with gauge
 PL Pompka nożna z manometrem
 DE Fusspumpe
 RU Насос ножный с манометром

CZ Nožní pumpa s manometrem
 RO Pompă de picior cu manometru
 HU Lábpumpa nyomásmérővel
 ES Bomba de pierna con manometro



No.	
82000	20

EN Bicycle lock
 PL Zapięcie rowerowe
 DE Fahrradschloss
 RU Замок велосипедный
 CZ Zámek jízdního kola
 RO Antifurt pt. bicicleta
 HU Kerékpárzár
 ES Cable antirrobo para bicicletas

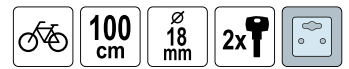

No.	L [cm]	Ø [mm]	
77850	100	18	12/24

EN Chain lock
 PL Zapięcie łańcuchowe z zamkiem
 DE Kettenverschluss mit Schloss
 RU Цепь с замком
 CZ Bezpečnostní řetěz se zámekem
 RO Lanț antifurt
 HU Kerékpár lakat
 ES Candado de cadena con cerradura

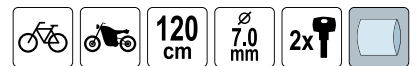

No.	L [cm]	Ø [mm]	
77881	120	7	12

EN Bike hand pump
 PL Pompka rowerowa
 DE Fahrradpumpe
 RU Велосипед ручной насос
 CZ Pumpička na kolo
 RO Pompă de bicicletă
 HU Kerékpár pumpa
 ES Bomba de bicicleta



No.	
82032	60

EN Foot pump with gauge
 PL Pompka nożna z manometrem
 DE Fusspumpe
 RU Насос ножный с манометром

CZ Nožní pumpa s manometrem
 RO Pompă de picior cu manometru
 HU Lábpumpa nyomásmérővel
 ES Bomba de pierna con manometro





No.	Measuring range / Zakres pomiaru [MPa]	
82005	0-0.7	5

- EN Foot pump with gauge
 PL Pompka nożna z manometrem
 DE Fusspumpe
 RU Насос ножный с манометром
- CZ Nožní pumpa s manometrem
 RO Pompă de picior cu manometru
 HU Lábpumpa nyomásmérővel
 ES Bomba de pierna con manometro

0-0.7 MPa

UNIVERSAL DOUBLE HEAD
 UNIVERSALNA GŁOWICA
 PODWÓJNA





No.	Measuring range / Zakres pomiaru [MPa]	
82001	0-0.7	12

- EN Hand pump
 PL Pompka słupkowa ręczna
 DE Hand-Luftpumpe
 RU Насос ручной
 CZ Hustička ruční
 RO Pompa de mana
 HU Kézi pumpa
 ES Bomba de barrote de mano

0.3 MPa



No.	Measuring range / Zakres pomiaru [MPa]	
82020	0-0.3	20

- EN Hand pump with manometer
 PL Pompka słupkowa z manometrem
 DE Hand-Luftpumpe mit Manometer
 RU Насос ручной с манометром
 CZ Pumpa s manometrem
 RO Pompa de mana cu manometru
 HU Kézi pumpa manométerrel
 ES Bomba de barrote con manometro

0-1.1 MPa

60 cm

UNIVERSAL DOUBLE HEAD
 UNIVERSALNA GŁOWICA
 PODWÓJNA



No.	Measuring range / Zakres pomiaru [MPa]	
82022	0-1.1	10

- EN Foot pump with gauge
 PL Pompka nożna z manometrem
 DE Fusspumpe
 RU Насос ножный с манометром
 CZ Nožní pumpa s manometrem
 RO Pompă de picior cu manometru
 HU Lábpumpa nyomásmérővel
 ES Bomba de pierna con manometro

0-0.7 MPa

UNIVERSAL DOUBLE HEAD
 UNIVERSALNA GŁOWICA
 PODWÓJNA

TWIN PISTON
 PODWÓJNY TŁOK





No.	Measuring range / Zakres pomiaru [MPa]	
82015	0-0.7	6

- EN Hand pump with manometer
 PL Pompka słupkowa z manometrem
 DE Hand-Luftpumpe mit Manometer
 RU Насос ручной с манометром
 CZ Pumpa s manometrem
 RO Pompa de mana cu manometru
 HU Kézi pumpa manométerrel
 ES Bomba de barrote con manometro

0-1 MPa

50 cm





No.	Measuring range / Zakres pomiaru [MPa]	
82021	0-1	10

- EN Hand pump with manometer
 PL Pompka słupkowa z manometrem
 DE Hand-Luftpumpe mit Manometer
 RU Насос ручной с манометром
 CZ Pumpa s manometrem
 RO Pompa de mana cu manometru
 HU Kézi pumpa manométerrel
 ES Bomba de barrote con manometro

0-1.1 MPa

100 cm

UNIVERSAL DOUBLE HEAD
 UNIVERSALNA GŁOWICA
 PODWÓJNA





No.	Measuring range / Zakres pomiaru [MPa]	
82023	0-1.1	10

EN Bike repair stand
 PL Stojak do obsługi rowerów
 DE Fahrrad Montagesänder
 RU Стенд для ремонта велосипедов
 CZ Montážní stojan
 RO Stand pt. repararea bicicletei
 HU Kerékpár szerelő
 ES Soporte de reparación

105-145 cm	360°	max  30 kg	max \varnothing 25-90 mm	
---------------	------	---	----------------------------	---



No.	
77715	2

Memo	
------	--

20

Kitchen & home appliance
Sprzęt AGD



Kitchen appliance
Sprzęt AGD do kuchni



.....304-325

Home appliance
Sprzęt AGD do domu



.....325-333

EN Multifunctional kitchen robot
 PL Robot kuchenny
 DE Küchenmaschine
 RU Кухонный робот
 CZ Kuchyňský robot
 RO Robot de bucătărie
 HU Robotgép
 ES Robot de cocina

220-240V~50/60Hz 150 W 3 in 1 180 min

FUNCTIONS:

- Thin slicing
- Thick slicing
- Thin shredding
- Thick shredding
- Puree blade

FUNKCJE:

- Krojenie cienkich plasterów
- Krojenie grubych plasterów
- Tarcie drobne
- Tarcie grube
- Tarcie placzków



LUND

No.	Power / Moc [W]	
67961	150	6

EN Hand mixer
 PL Mikser ręczny
 DE Handmixer
 RU Ручной миксер
 CZ Ruční mixér
 RO Mixer
 HU Kézi turmixgép
 ES Batidora de mano

220-240V~50-60Hz 150 W x5



LUND

No.	Power / Moc [W]	
67780	150	10

EN Stand mixer
 PL Mikser planetarny
 DE Küchenmaschine
 RU Кухонный комбайн
 CZ Kuchyňský robot
 RO Robot bucătărie multifuncțional
 HU Komplex konyhai robotgép
 ES Robot de cocina

220-240V~50Hz max 1400 W 800 W
 5.5 L x6 TURBO
 SS STAINLESS STEEL STAL NERDZIEWA



LUND

No.	Power / Moc [W]	
67805	800	2

EN Hand mixer
 PL Mikser ręczny
 DE Handmixer
 RU Ручной миксер
 CZ Ruční mixér
 RO Mixer
 HU Kézi turmixgép
 ES Batidora de mano

220-240V~50-60Hz 200 W x5
 TURBO SS STAINLESS STEEL STAL NERDZIEWA



LUND

No.	Power / Moc [W]	
67781	200	8

EN Hand mixer with bowl
 PL Mikser ręczny z misą
 DE Handmixer mit Schale
 RU Ручной миксер с чашей
 CZ Ruční mixér s mísou
 RO Mixer cu bol
 HU Kézi turmixgép tállal
 ES Batidora de mano con bol



LUND

No.	Power / Moc [W]	Box
67790	200	6

EN Food chopper
 PL Rozdrabniacz do żywności
 DE Zerkleinerer für Lebensmittel
 RU Дробилка для сухой пищи
 CZ Drtič potravin
 RO Tocător electric pt. alimente
 HU Ételaprító
 ES Picadora de alimentos



INCLUDED:
 - Glass bowl 2 l
 - Steel blades
 - Part for peeling garlic
 - Part for whisking
 - Scraper

W ZESTAWIE:
 - Szklana misa 2 l
 - Ostrza ze stali nierdzewnej
 - Część do obierania czosnku
 - Część do ubijania
 - Skrobak



LUND

No.	Power / Moc [W]	Box
67920	500	6

EN Hand blender
 PL Blender ręczny
 DE Stabmixer
 RU Ручной блендер

CZ Ruční mixér
 RO Blender de mana
 HU Botmixer
 ES Batidora de mano



INCLUDED:
 - Blender 700 W
 - Stainless steel blade
 - Cup 0.5 l
 - Stainless steel whisk
 - Chopper 0.5 l with stainless steel blade
 - BPA free tritan bottle 0.6 l with blade and cap
 - Holder for blade and whisk

W ZESTAWIE:
 - Blender 700 W
 - Ostrze ze stali nierdzewnej
 - Pojemnik 0.5 l
 - Trzepaczka ze stali nierdzewnej
 - Malakser 0.5 l z ostrzem ze stali nierdzewnej
 - Butelka 0.6 l wolna od BPA, wykonana z tritanu, z ostrzem i zakrętką
 - Podstawa na ostrze i trzepaczkę



LUND

No.	Power / Moc [W]	Box
67700	700	6

EN Smoothie blender
 PL Blender kielichowy do smoothie
 DE Standmixer
 RU Блендер

CZ Smoothie mixér
 RO Blender pt. smoothie
 HU Smoothie turmixgép
 ES Batidora smoothie

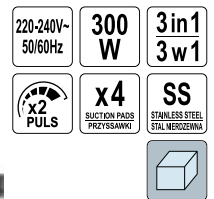

INCLUDED:
 - Blender 300 W
 - Stainless steel blade
 - Jar 1 l
 - Bottle 0.57 l
 - Bottle 0.4 l

W ZESTAWIE:
 - Blender 300 W
 - Ostrze ze stali nierdzewnej
 - Kielich 1 l
 - Butelka 0.57 l
 - Butelka 0.4 l



LUND

No.	Power / Moc [W]	Box
67702	300	6

EN Smoothie blender
 PL Blender kielichowy do smoothie
 DE Standmixer
 RU Блендер

CZ Smoothie mixér
 RO Blender pt. smoothie
 HU Smoothie turmixgép
 ES Batidora smoothie

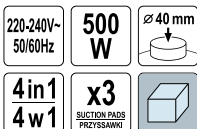

- INCLUDED:**
- Blender 500 W
 - Stainless steel blade
 - Glass jar 0.6 l
 - Bottle 0.57 l
 - Bottle 0.4 l
 - Grinder

- W ZESTAWIE:**
- Blender 500 W
 - Ostrze ze stali nierdzewnej
 - Szklany kielich 0.6 l
 - Butelka 0.57 l
 - Butelka 0.4 l
 - Młynek



LUND

No.	Power / Moc [W]	Box
67703	500	4

EN Bottle
 PL Butelka
 DE Flasche
 RU Бутылка
 CZ Láhev
 RO Sticla
 HU Üveg
 ES Botella



LUND

No.	Capacity / Pojemność [l]	For / Dla	Box
67709	0.57	67702, 67703, 67707	12

EN Stand blender
 PL Blender kielichowy
 DE Standmixer
 RU Блендер
 CZ Stolní mixér
 RO Blender
 HU Turmixgép
 ES Batidora de vaso



- INCLUDED:**
- Blender 600 W
 - Stainless steel blade
 - Jar 1.5 l

- W ZESTAWIE:**
- Blender 600 W
 - Ostrze ze stali nierdzewnej
 - Kielich 1.5 l



LUND

No.	Power / Moc [W]	Box
67705	600	4

EN Stand blender
 PL Blender kielichowy
 DE Standmixer
 RU Блендер
 CZ Stolní mixér
 RO Blender
 HU Turmixgép
 ES Batidora de vaso

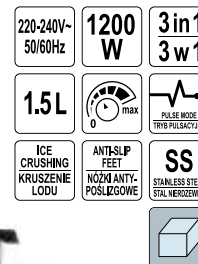

- INCLUDED:**
- Glass jar 1.5 l
 - Stainless steel grinder 500 g
 - Tritan bottle 0.6 l

- W ZESTAWIE:**
- Szklany kielich 1.5 l
 - Młynek ze stali nierdzewnej 500 g
 - Butelka z trytanu 0.6 l



LUND

No.	Power / Moc [W]	Box
67707	1200	4

EN Portable blender USB
 PL Blender przenośny USB
 DE Mobiler USB-Stabmixer
 RU Портативный USB-блендер
 CZ Přenosný USB mixér
 RO Blender portabil USB
 HU Hordozható USB turmix
 ES Licuadora portátil USB

7.4 V
1600mAh
Li-Ion

60 W

0.35L

1.5h

USB
BATTERY CHARGER
LADÓVÁRKA

FEATURES:

- Working time: 10-15 cycles
- 1 cycle = 40 sec

CECHY:

- Czas pracy: 10-15 cykli
- Cykl = 40 sek.



LUND

No.	Power / Moc [W]	
67710	60	10

EN Slow juicer
 PL Wyciskarka wolnoobrotowa do soków
 DE Langsam laufende Saftpresse
 RU Соковыжималка шнековая
 CZ Nizkootáčkový odšťavňovač
 RO Storcator de fructe
 HU Gyümölcscentrifuga
 ES Saca jugo

220-240V~
50/60Hz

150 W

65 min¹

3 FILTERS
FILTRY



FEATURES:

- Prepares fruit and vegetable juices, mousses, ice creams, dairy cocktails
- Keep more nutrition and original taste than traditional juicers
- Reverse gear
- Dishwasher safe for a quick and easy clean up
- Anti-drip cap
- Anti-slip feet
- Comfortable handle
- Low noise <60 db

CECHY:

- Możliwość przygotowania soków owocowych i warzywnych, przecierów, lodów i koktajli mlecznych
- Zachowuje więcej witamin i smaku niż tradycyjna sokowirówka
- Bieg wsteczny
- Szybkie i łatwe czyszczenie, możliwość mycia w zmywarce
- Korek niekapek
- Nóżki antypoślizgowe
- Wygodny uchwyt do przenoszenia
- Cicha praca <60 db



LUND

No.	Power / Moc [W]	
67840	150	2

EN Juicer
 PL Sokowirówka
 DE Entsafter
 RU Соковыжималка

CZ Odšťavňovač
 RO Storcator fructe
 HU Gyümölcscentrifuga
 ES Licuadora

220-240V~
50-60Hz

600 W

13000 min¹

65 mm

ANTI-SLIP FEET
NOŻKI ANTY-POŚLIZGOWE

SS
STAINLESS STEEL
STAL NIERDZEWNA

INCLUDED:

- Pulp container 1.5 l
- Juicer cup 0.45 l
- Stainless steel grater
- Anti-drip tap

W ZESTAWIE:

- Pojemnik na pulpe 1.5 l
- Pojemnik na sok 0.45 l
- Tarca ze stali nierdzewnej
- Kranik zapobiegający kapaniu



LUND

No.	Power / Moc [W]	
67851	600	6

EN Slow juicer
 PL Wyciskarka wolnoobrotowa do soków
 DE Langsam laufende Saftpresse
 RU Соковыжималка шнековая
 CZ Nizkootáčkový odšťavňovač
 RO Storcator de fructe
 HU Gyümölcscentrifuga
 ES Saca jugo

220-240V~
50/60Hz

150 W

65 min¹

75 mm

3 FILTERS
FILTRY

SS
STAINLESS STEEL
STAL NIERDZEWNA

FEATURES:

- Prepares fruit and vegetable juices, mousses, ice creams, dairy cocktails
- Keep more nutrition and original taste than traditional juicers
- Reverse gear
- Dishwasher safe for a quick and easy clean up
- Anti-drip cap
- Anti-slip feet
- Comfortable handle
- Low noise <60 db

CECHY:

- Możliwość przygotowania soków owocowych i warzywnych, przecierów, lodów i koktajli mlecznych
- Zachowuje więcej witamin i smaku niż tradycyjna sokowirówka
- Bieg wsteczny
- Szybkie i łatwe czyszczenie, możliwość mycia w zmywarce
- Korek niekapek
- Nóżki antypoślizgowe
- Wygodny uchwyt do przenoszenia
- Cicha praca <60 db



LUND

No.	Power / Moc [W]	
67841	150	2

EN Meat mincer
 PL Maszynka do mielenia mięsa
 DE Fleischwolf
 RU Мясорубка
 CZ Mlýnek na maso
 RO Mașină de tocat carne
 HU Húsdaráló
 ES Picadora de carne

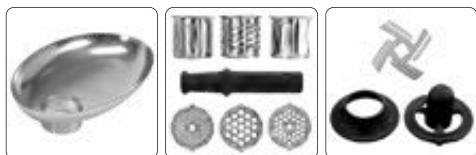

LUND

No.	Power / Moc [W]	
67900	550	4

EN Electric kettle
 PL Czajnik elektryczny
 DE Wasserkocher
 RU Электрический чайник
 CZ Rychlovární konvice
 RO Fierbător electric
 HU Elektromos vízforraló
 ES Hervidor eléctrico



FEATURES:

- Automatic switch off
- Boil dry protection
- Removable and washable mesh filter
- Cable storage
- Cable length: 80 cm
- Stainless steel housing

CECHY:

- Automatische wyłączenie po zagotowaniu wody
- Ochrona przed przegrzaniem
- Filtr siatkowy z możliwością wyjęcia i umycia
- Możliwość zwinięcia kabla pod podstawką
- Długość kabla: 80 cm
- Obudowa ze stali nierdzewnej



LUND

No.	Power / Moc [W]	
68172	1850-2200	8

EN Meat mincer
 PL Maszynka do mielenia mięsa
 DE Fleischwolf
 RU Мясорубка
 CZ Mlýnek na maso
 RO Mașină de tocat carne
 HU Húsdaráló
 ES Picadora de carne

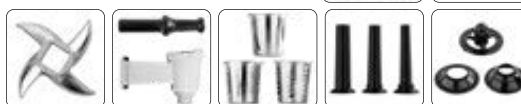
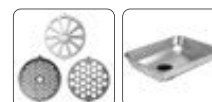

LUND

No.	Power / Moc [W]	
67901	1200	1

EN Electric kettle
 PL Czajnik elektryczny
 DE Wasserkocher
 RU Электрический чайник
 CZ Rychlovární konvice
 RO Fierbător electric
 HU Elektromos vízforraló
 ES Hervidor eléctrico

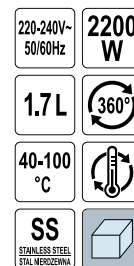

FEATURES:

- Automatic switch off
- Boil dry protection
- Cable storage
- Cable length: 80 cm
- Stainless steel housing
- Temperature control: 40-100° (40°-50°-60°-70°-80°-90°-100°)
- Keep warm

CECHY:

- Automatische wyłączenie po zagotowaniu wody
- Ochrona przed przegrzaniem
- Możliwość zwinięcia kabla pod podstawką
- Długość kabla: 80 cm
- Obudowa ze stali nierdzewnej
- Regulacja temperatury: 40-100° (40°-50°-60°-70°-80°-90°-100°)
- Funkcja utrzymywania temperatury



LUND

No.	Power / Moc [W]	
68173	1850-2200	8

EN Electric kettle
 PL Czajnik elektryczny
 DE Wasserkocher
 RU Электрический чайник
 CZ Rychlovarná konvice
 RO Fierbător electric
 HU Elektromos vízforráló
 ES Hervidor eléctrico

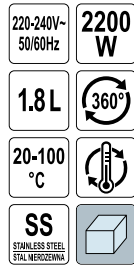

FEATURES:

- Automatic switch off
- Boil dry protection
- Removable and washable mesh filter
- Cable length: 75 cm
- Stainless steel housing
- Temperature control: 20-100° (20°-25°-30°...-95°-100°)
- Keep warm

CECHY:

- Automatyczne wyłączenie po zagotowaniu wody
- Ochrona przed przegrzaniem
- Filtr siatkowy z możliwością wyjęcia i umycia
- Długość kabla: 75 cm
- Obudowa ze stali nierdzewnej
- Regulacja temperatury: 20-100° (20°-25°-30°...-95°-100°)
- Funkcja utrzymywania temperatury



LUND

No.	Power / Moc [W]	Icon
68174	1850-2200	6

EN Electric kettle
 PL Czajnik elektryczny
 DE Wasserkocher
 RU Электрический чайник
 CZ Rychlovarná konvice
 RO Fierbător electric
 HU Elektromos vízforráló
 ES Hervidor eléctrico



FEATURES:

- Automatic switch off
- Boil dry protection
- Removable and washable mesh filter
- Cable storage
- Double layer
- Cool touch

CECHY:

- Automatyczne wyłączenie po zagotowaniu wody
- Ochrona przed przegrzaniem
- Filtr siatkowy z możliwością wyjęcia i umycia
- Możliwość zwinięcia kabla pod podstawką
- Podwójne ścianki
- Nie nagzewająca się obudowa



LUND

No.	Power / Moc [W]	Icon
68206	1850-2200	8

EN Electric kettle
 PL Czajnik elektryczny
 DE Wasserkocher
 RU Электрический чайник
 CZ Rychlovarná konvice
 RO Fierbător electric
 HU Elektromos vízforráló
 ES Hervidor eléctrico

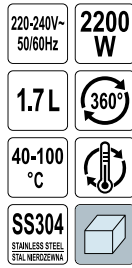

FEATURES:

- Automatic switch off
- Boil dry protection
- Removable and washable mesh filter
- Cable storage
- Cable length: 70 cm
- Water gauge
- Stainless steel 304 heating plate and body
- Temperature control (40-45-50...-95-100)
- Keep warm

CECHY:

- Automatyczne wyłączenie po zagotowaniu wody
- Ochrona przed przegrzaniem
- Filtr siatkowy z możliwością wyjęcia i umycia
- Możliwość zwinięcia kabla pod podstawką
- Długość kabla: 70 cm
- Wskaźnik poziomu wody
- Płyta grzewcza oraz obudowa ze stali nierdzewnej 304
- Regulacja temperatury (40-45-50...-95-100)
- Funkcja utrzymywania temperatury



LUND

No.	Power / Moc [W]	Icon
68194	1850-2200	8

EN Electric kettle
 PL Czajnik elektryczny
 DE Wasserkocher
 RU Электрический чайник
 CZ Rychlovarná konvice
 RO Fierbător electric
 HU Elektromos vízforráló
 ES Hervidor eléctrico



FEATURES:

- Automatic switch off
- Boil dry protection
- Removable and washable mesh filter
- Cable storage
- Double layer
- Cool touch

CECHY:

- Automatyczne wyłączenie po zagotowaniu wody
- Ochrona przed przegrzaniem
- Filtr siatkowy z możliwością wyjęcia i umycia
- Możliwość zwinięcia kabla pod podstawką
- Podwójne ścianki
- Nie nagzewająca się obudowa



LUND

No.	Power / Moc [W]	Icon
68207	1850-2200	8

EN Electric kettle
 PL Czajnik elektryczny
 DE Wasserkocher
 RU Электрический чайник
 CZ Rychlovárná konvice
 RO Fierbător electric
 HU Elektromos vízforráló
 ES Hervidor eléctrico



FEATURES:

- Automatic switch off
- Boil dry protection
- Removable and washable mesh filter
- Cable storage
- Double layer
- Cool touch

CECHY:

- Automatyczne wyłączenie po zagotowaniu wody
- Ochrona przed przegrzaniem
- Filtr siatkowy z możliwością wyjęcia i umycia
- Możliwość zwinięcia kabla pod podstawką
- Podwójne ścianki
- Nienagrzewająca się obudowa



EN Electric kettle
 PL Czajnik elektryczny
 DE Wasserkocher
 RU Электрический чайник
 CZ Rychlovárná konvice
 RO Fierbător electric
 HU Elektromos vízforráló
 ES Hervidor eléctrico



FEATURES:

- Automatic switch off
- Boil dry protection
- Removable and washable mesh filter
- Cable storage
- Double layer
- Cool touch

CECHY:

- Automatyczne wyłączenie po zagotowaniu wody
- Ochrona przed przegrzaniem
- Filtr siatkowy z możliwością wyjęcia i umycia
- Możliwość zwinięcia kabla pod podstawką
- Podwójne ścianki
- Nienagrzewająca się obudowa



LUND

No.	Power / Moc [W]	
68208	1850-2200	8

EN Electric kettle
 PL Czajnik elektryczny
 DE Wasserkocher
 RU Электрический чайник
 CZ Rychlovárná konvice
 RO Fierbător electric
 HU Elektromos vízforráló
 ES Hervidor eléctrico

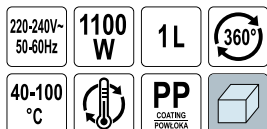

FEATURES:

- Automatic switch off
- Boil dry protection
- Removable and washable mesh filter
- Cable storage
- Double layer
- Cool touch
- Borosilicate glass
- LED control panel

CECHY:

- Automatyczne wyłączenie po zagotowaniu wody
- Ochrona przed przegrzaniem
- Filtr siatkowy z możliwością wyjęcia i umycia
- Możliwość zwinięcia kabla pod podstawką
- Podwójne ścianki
- Nienagrzewająca się obudowa
- Szkło borokrzemowe
- Panel sterowania LED



LUND

No.	Power / Moc [W]	
68209	1850-2200	8

EN Electric kettle
 PL Czajnik elektryczny
 DE Wasserkocher
 RU Электрический чайник
 CZ Rychlovárná konvice
 RO Fierbător electric
 HU Elektromos vízforráló
 ES Hervidor eléctrico



FEATURES:

- Automatic switch off
- Boil dry protection
- Removable and washable mesh filter
- Cable storage
- Double layer
- Cool touch
- LED control panel

CECHY:

- Automatyczne wyłączenie po zagotowaniu wody
- Ochrona przed przegrzaniem
- Filtr siatkowy z możliwością wyjęcia i umycia
- Możliwość zwinięcia kabla pod podstawką
- Podwójne ścianki
- Nienagrzewająca się obudowa
- Panel sterowania LED



LUND

No.	Power / Moc [W]	
68216	900-1100	8

LUND

No.	Power / Moc [W]	
68217	1850-2200	8

EN Electric kettle
 PL Czajnik elektryczny
 DE Wasserkocher
 RU Электрический чайник
 CZ Rychlovarná konvice
 RO Fierbător electric
 HU Elektromos vízforraló
 ES Hervidor eléctrico

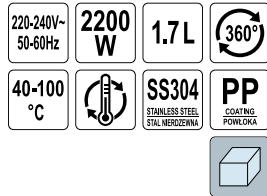

FEATURES:

- Automatic switch off
- Boil dry protection
- Removable and washable mesh filter
- Cable storage
- Double layer
- Cool touch
- LED control panel

CECHY:

- Automatische wyłączenie po zagotowaniu wody
- Ochrona przed przegrzaniem
- Filtr siatkowy z możliwością wyjęcia i umycia
- Możliwość zwinięcia kabla pod podstawką
- Podwójne ścianki
- Nienagrzewająca się obudowa
- Panel sterowania LED



LUND

No.	Power / Moc [W]	
68218	1850-2200	8

EN Electric kettle
 PL Czajnik elektryczny
 DE Wasserkocher
 RU Электрический чайник
 CZ Rychlovarná konvice
 RO Fierbător electric
 HU Elektromos vízforraló
 ES Hervidor eléctrico

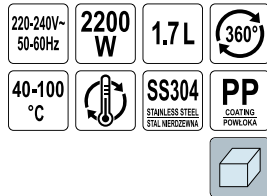

FEATURES:

- Automatic switch off
- Boil dry protection
- Removable and washable mesh filter
- Cable storage
- Double layer
- Cool touch
- LED control panel

CECHY:

- Automatische wyłączenie po zagotowaniu wody
- Ochrona przed przegrzaniem
- Filtr siatkowy z możliwością wyjęcia i umycia
- Możliwość zwinięcia kabla pod podstawką
- Podwójne ścianki
- Nienagrzewająca się obudowa
- Panel sterowania LED



LUND

No.	Power / Moc [W]	
68223	1850-2200	8

EN Electric kettle
 PL Czajnik elektryczny
 DE Wasserkocher
 RU Электрический чайник
 CZ Rychlovarná konvice
 RO Fierbător electric
 HU Elektromos vízforraló
 ES Hervidor eléctrico

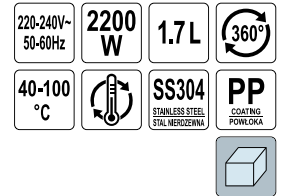

FEATURES:

- Automatic switch off
- Boil dry protection
- Removable and washable mesh filter
- Cable storage
- Double layer
- Cool touch
- LED control panel

CECHY:

- Automatische wyłączenie po zagotowaniu wody
- Ochrona przed przegrzaniem
- Filtr siatkowy z możliwością wyjęcia i umycia
- Możliwość zwinięcia kabla pod podstawką
- Podwójne ścianki
- Nienagrzewająca się obudowa
- Panel sterowania LED



LUND

No.	Power / Moc [W]	
68219	1850-2200	8



EN Rechargeable milk frother
 PL Bezprzewodowy sieniacz do mleka
 DE Kabelloser Milchaufschäumer
 RU Беспроводной вспениватель молока
 CZ Ruční šlehač mléka
 RO Mixer pt. spumat lapte reîncărcabil
 HU Vezeték nélküli tejhabosító
 ES Espumador de leche inalámbrico

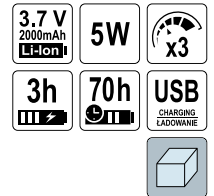

FEATURES:

- Automatic switch off
- Boil dry protection
- Removable and washable mesh filter
- Cable storage
- Double layer
- Cool touch
- LED control panel

CECHY:

- Automatische wyłączenie po zagotowaniu wody
- Ochrona przed przegrzaniem
- Filtr siatkowy z możliwością wyjęcia i umycia
- Możliwość zwinięcia kabla pod podstawką
- Podwójne ścianki
- Nienagrzewająca się obudowa
- Panel sterowania LED



LUND

No.	Power / Moc [W]	
68477	5	42

EN Milk frother
 PL Spieniacz do mleka
 DE Milchaufschäumer
 RU Всениватель молока
 CZ Napeňovač mlieka
 RO Aparat pt. spumat laple
 HU Tejhabosító
 ES Espumador de leche



FEATURES:

- Hot and cold froth function

CECHY:

- Funkcja spieniania na zimno i ciepło



LUND

No.	Power / Moc [W]	
68470	500	12

EN Air fryer
 PL Frytkownica beztłuszczowa
 DE Heissluftfritteuse
 RU Фритюрница
 CZ Horkovzdušná fritéza
 RO Friteuză
 HU Olajsütő olaj nélküli
 ES Freidora sin aceite



FUNCTIONS:
 - Defrost
 - Reheat
 - Bake
 - Fry
 - Grill

FUNKCJE:
 - Rozmraża
 - Podgrzewa
 - Piecze
 - Smaży
 - Grilluje

FEATURES:

- Up to 80% less oil than in conventional fryer
 - Easy to use, timer and temperature control
 - Dishwasher safe for a quick and easy clean up
 - Faster heating up than in traditional oven
 - Preparation: fries, meat, fish, vegetables, cakes and more

CECHY:

- Nawet 80% mniej oleju niż w standardowej frytkownicy
 - Łatwa, intuicyjna obsługa dzięki regulacji temperatury i czasu
 - Szybkie i łatwe czyszczenie, możliwość mycia w zmywarce
 - Szybsze nagrzewanie niż w tradycyjnym piekarniku
 - Przygotowanie m.in. frytek, mięsa, ryb, warzyw, ciastek



LUND

No.	Power / Moc [W]	
67573	1800	1

EN Air fryer
 PL Frytkownica beztłuszczowa
 DE Heissluftfritteuse
 RU Фритюрница
 CZ Horkovzdušná fritéza
 RO Friteuză
 HU Olajsütő olaj nélküli
 ES Freidora sin aceite



FEATURES:

- Up to 80% less oil than in conventional fryer
 - Easy to use, timer and temperature control
 - Dishwasher safe for a quick and easy clean up
 - Faster heating up than in traditional oven
 - Preparation: fries, meat, fish, vegetables, cakes and more

CECHY:

- Nawet 80% mniej oleju niż w standardowej frytkownicy
 - Łatwa, intuicyjna obsługa dzięki regulacji temperatury i czasu
 - Szybkie i łatwe czyszczenie, możliwość mycia w zmywarce
 - Szybsze nagrzewanie niż w tradycyjnym piekarniku
 - Przygotowanie m.in. frytek, mięsa, ryb, warzyw, ciastek

FUNCTIONS:
 - Defrost
 - Reheat
 - Bake
 - Fry
 - Grill

FUNKCJE:
 - Rozmraża
 - Podgrzewa
 - Piecze
 - Smaży
 - Grilluje

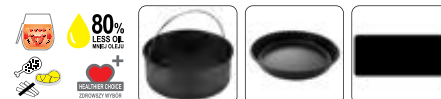

LUND

No.	Power / Moc [W]	
67572	1400	1

EN Air fryer
 PL Frytkownica beztłuszczowa
 DE Heissluftfritteuse
 RU Фритюрница

CZ Horkovzdušná fritéza
 RO Friteuză
 HU Olajsütő olaj nélküli
 ES Freidora sin aceite

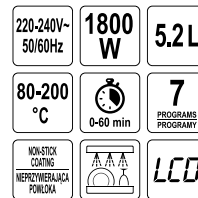

FEATURES:

- Up to 80% less oil than in conventional fryer
 - Easy to use, timer and temperature control
 - Dishwasher safe for a quick and easy clean up
 - Faster heating up than in traditional oven
 - Preparation: fries, meat, fish, vegetables, cakes and more

CECHY:

- Nawet 80% mniej oleju niż w standardowej frytkownicy
 - Łatwa, intuicyjna obsługa dzięki regulacji temperatury i czasu
 - Szybkie i łatwe czyszczenie, możliwość mycia w zmywarce
 - Szybsze nagrzewanie niż w tradycyjnym piekarniku
 - Przygotowanie m.in. frytek, mięsa, ryb, warzyw, ciastek

FUNCTIONS:

- Defrost
 - Reheat
 - Bake
 - Fry
 - Grill

FUNKCJE:

- Rozmraża
 - Podgrzewa
 - Piecze
 - Smaży
 - Grilluje



LUND

No.	Power / Moc [W]	
67574	1800	1

EN Air fryer
 PL Frytkownica beztłuszczowa
 DE Heißluftfritteuse
 RU Фритюрница
 CZ Horkovzdušná fritéza
 RO Friteuză
 HU Olajsütő olaj nélkül
 ES Freidora sin aceite

FUNCTIONS: FUNKCJE:
 - Defrost - Rozmraża
 - Reheat - Podgrzewa
 - Bake - Piecze
 - Fry - Smaży
 - Grill - Grilluje
 - Dry - Suszy



FEATURES:
 - Up to 80% less oil than in conventional fryer
 - Easy to use, timer and temperature control
 - Dishwasher safe for a quick and easy clean up
 - Faster heating up than in traditional oven
 - Preparation: fries, meat, fish, vegetables, cakes and more

CECHY:
 - Nawet 80% mniej oleju niż w standardowej frytkownicy
 - Łatwa, intuicyjna obsługa dzięki regulacji temperatury i czasu
 - Szybkie i łatwe czyszczenie, możliwość mycia w zmywarce
 - Szybsze nagrzewanie niż w tradycyjnym piekarniku
 - Przygotowanie m.in. frytek, mięsa, ryb, warzyw, ciastek



LUND

No.	Power / Moc [W]	
67590	1800	1

EN Kitchen tongs
 PL Szczypce kuchenne
 DE Küchenzange
 RU Щипцы кухонные
 CZ Kuchyňské kleště
 RO Cleste bucatarie
 HU Konyhai csipesz
 ES Pinza de cocina



LUND

No.	L [mm]	
67589	220	30

EN Baking pan for air fryers
 PL Forma do pieczenia do frytkownicy beztłuszczowych
 DE Backblech für Heißluftfritteuse
 RU Форма для выпекания для аэрофритюрниц
 CZ Forma na pečení do horkovzdušné fritézy
 RO Tava de copt pt. friteuza cu aer
 HU Sütőforma zsírmentes fritőzhöz
 ES Molde para freidoras sin aceite



LUND

No.	For / Dla	
67586	67572, 67573, 67574, 67575, 67576	8

EN Pan for air fryers
 PL Patelnia do frytkownicy beztłuszczowych
 DE Pizzapfanne für Heißluftfritteuse
 RU Сковорода для аэрофритюрниц
 CZ Nízká pánev do horkovzdušné fritézy
 RO Tavă pt. friteuza cu aer
 HU Serpenyő zsírmentes fritőzhöz
 ES Sartén para freidoras sin aceite



LUND

No.	For / Dla	
67585	67572, 67573, 67574, 67575, 67576	16

EN Grate for air fryers
 PL Ruszt do frytkownicy beztłuszczowych
 DE Gitterrost für Heißluftfritteuse
 RU Решетка для аэрофритюрниц
 CZ Grilovací mřížka do horkovzdušné fritézy
 RO Gratar pt. friteuza cu aer
 HU Rács zsírmentes fritőzhöz
 ES Rejilla para freidoras sin aceite

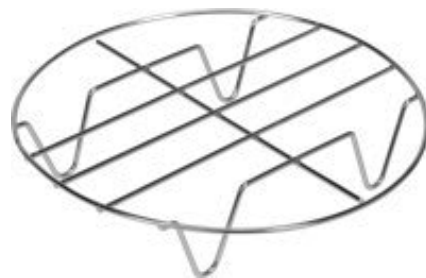

LUND

No.	For / Dla	
67587	67572, 67573, 67574, 67575, 67576	16

EN Halogen oven
 PL Kombiwar halogenowy
 DE Halogenofen
 RU Галогеновая печь
 CZ Halogenová trouba
 RO Cuptor cu halogen
 HU Halogén sütő
 ES Horno halogeno

FEATURES:

- Cooking time is 3 to 5 times faster than in conventional ovens
 - Cooking without fats or oil
 - Safe tempered glass body
 - Low usage of electricity
 - Excellent turbo wash function for self-cleaning
 - Easy to use, timer and temperature control
 - Evenly cooked foods (convection)
- CECHY:**
- Od 3 do 5 razy szybsze gotowanie w porównaniu z tradycyjnymi piekarnikami
 - Bez tłuszczowe gotowanie bez oleju
 - Bezpieczne, hartowane szkło
 - Niskie zużycie energii elektrycznej
 - Skuteczna funkcja autoczyszczenia misy
 - Łatwa, intuicyjna obsługa dzięki regulacji temperatury i czasu
 - Równomierne gotowanie potraw (termoobieg)

220-240V-50-60Hz **1400 W** 12+5L 65-250 °C 0-60 min

- FUNCTIONS:**
- Thaw
 - Reheat
 - Bake
 - Grill
 - Broil
 - Cook
 - Steam
- FUNKCJE:**
- Odmraża
 - Podgrzewa
 - Piecze
 - Grilluje
 - Opieka
 - Gotuje
 - Gotuje na parze

- ACCESSORIES:**
- Tongs
 - Bread rack
- AKCESORIA:**
- Szczypce
 - Stojak na chleb



LUND

No.	Power / Moc [W]	
67640	1200-1400	1

EN Halogen oven
 PL Kombiwar halogenowy
 DE Halogenofen
 RU Галогеновая печь
 CZ Halogenová trouba
 RO Cuptor cu halogen
 HU Halogén sütő
 ES Horno halogeno

FEATURES:

- Cooking time is 3 to 5 times faster than in conventional ovens
 - Cooking without fats or oil
 - Safe tempered glass body
 - Low usage of electricity
 - Excellent turbo wash function for self-cleaning
 - Easy to use, timer and temperature control
 - Evenly cooked foods (convection)
- CECHY:**
- Od 3 do 5 razy szybsze gotowanie w porównaniu z tradycyjnymi piekarnikami
 - Bez tłuszczowe gotowanie bez oleju
 - Bezpieczne, hartowane szkło
 - Niskie zużycie energii elektrycznej
 - Skuteczna funkcja autoczyszczenia misy
 - Łatwa, intuicyjna obsługa dzięki regulacji temperatury i czasu
 - Równomierne gotowanie potraw (termoobieg)

220-240V-50-60Hz **1400 W** 12+5L 65-250 °C 0-60 min

- FUNCTIONS:**
- Thaw
 - Reheat
 - Bake
 - Grill
 - Broil
 - Cook
 - Steam
- FUNKCJE:**
- Odmraża
 - Podgrzewa
 - Piecze
 - Grilluje
 - Opieka
 - Gotuje
 - Gotuje na parze

- ACCESSORIES:**
- Tongs
 - Bread rack
- AKCESORIA:**
- Szczypce
 - Stojak na chleb



LUND

No.	Power / Moc [W]	
67641	1200-1400	1

EN Halogen oven
 PL Kombiwar halogenowy
 DE Halogenofen
 RU Галогеновая печь
 CZ Halogenová trouba
 RO Cuptor cu halogen
 HU Halogén sütő
 ES Horno halogeno

FEATURES:

- Cooking time is 3 to 5 times faster than in conventional ovens
- Cooking without fats or oil
- Safe tempered glass body
- Low usage of electricity
- Excellent turbo wash function for self-cleaning
- Easy to use, timer and temperature control
- Evenly cooked foods (convection)

CECHY:

- Od 3 do 5 razy szybsze gotowanie w porównaniu z tradycyjnymi piekarnikami
- Bez tłuszczowe gotowanie bez oleju
- Bezpieczne, hartowane szkło
- Niskie zużycie energii elektrycznej
- Skuteczna funkcja autoczyszczenia misy
- Łatwa, intuicyjna obsługa dzięki regulacji temperatury i czasu
- Równomierne gotowanie potraw (termoobieg)

FUNCTIONS:

- Thaw
- Reheat
- Bake
- Grill
- Broil
- Cook
- Steam

FUNKCJE:

- Odmraża
- Podgrzewa
- Piecze
- Grilluje
- Opieka
- Gotuje
- Gotuje na parze



LUND

No.	Power / Moc [W]	
67642	1200-1400	1

EN Bread maker

PL Wypiekacz do chleba
DE Brotbackmaschine
RU Хлебобулочка
CZ Domáci pekárna chleba
RO Masina de facut paine
HU Kenyérüstő
ES Panificadora

FEATURES:

- Loaf size selection: 500 g, 750 g, 1000 g
- Adjustable crust control: light, middle, dark

CECHY:

- Wybór rozmiaru chleba: 500 g, 750 g, 1000 g
- Regulacja przyrumienienia skórki: jasna, średnia, ciemna

PROGRAMS:

- Bread: soft, multigrain, whole wheat, sweet, milk, natural sourdough, French, quick, sugar free, gluten free
- Cake
- Raw dough
- Leavened dough
- Bake
- Yogurt

PROGRAMY:

- Chleb: pszenny, wieloziarnisty, pełnoziarnisty, słodki, mleczny, naturalny zakwasowy, francuski, szybki, bez cukru, bez glutenu
- Ciasto na słodko
- Ciasto surowe
- Zaczyn
- Dopekanie
- Jogurt



LUND

No.	Power / Moc [W]	
68032	650	2

EN Food dehydrator

PL Suszarka spożywcza
DE Lebensmittelrockner
RU Сушилка для пищевых продуктов
CZ Sušička potravin
RO Deshidrator alimente
HU Ételszáritó
ES Secador de alimentos



DRIES:

- Fruit, vegetables, flowers, mushrooms, herbs, meat and much more

SUSZY:

- Owoce, warzywa, kwiaty, grzyby, zioła, mięso i wiele innych



LUND

No.	Power / Moc [W]	
68280	300-340	2

EN Bread maker

PL Wypiekacz do chleba
DE Brotbackmaschine
RU Хлебобулочка
CZ Domáci pekárna chleba
RO Masina de facut paine
HU Kenyérüstő
ES Panificadora

FEATURES:

- Automatic dispenser
- Loaf size selection: 500 g, 750 g, 1000 g
- Adjustable crust control: light, middle, dark

CECHY:

- Automatyczny dozownik
- Wybór rozmiaru chleba: 500 g, 750 g, 1000 g
- Regulacja przyrumienienia skórki: jasna, średnia, ciemna

PROGRAMS:

- Bread: soft, multigrain, whole wheat, sweet, milk, natural sourdough, French, quick, sugar free, gluten free
- Cake
- Raw dough
- Leavened dough
- Jam
- Bake
- Yogurt
- Sticky rice
- Stir-fry
- Ferment

PROGRAMY:

- Chleb: pszenny, wieloziarnisty, pełnoziarnisty, słodki, mleczny, naturalny zakwasowy, francuski, szybki, bez cukru, bez glutenu
- Ciasto na słodko
- Ciasto surowe
- Zaczyn
- Dżem
- Dopekanie
- Jogurt
- Kleisty ryż
- Prażenie
- Fermentacja



LUND

No.	Power / Moc [W]	
68033	710	2

EN Food dehydrator

PL Suszarka spożywcza
DE Lebensmittelrockner
RU Сушилка для пищевых продуктов
CZ Sušička potravin
RO Deshidrator alimente
HU Ételszáritó
ES Secador de alimentos

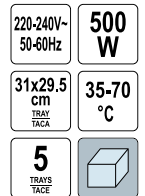

DRIES:

- Fruit, vegetables, flowers, mushrooms, herbs, meat and much more

SUSZY:

- Owoce, warzywa, kwiaty, grzyby, zioła, mięso i wiele innych



LUND

No.	Power / Moc [W]	
68270	420-500	4

EN Food dehydrator
 PL Suszarka spozywcza
 DE Lebensmittelrockner
 RU Сушилка для пищевых продуктов

CZ Sušička potravin
 RO Deshidrator alimente
 HU Ételszáritó
 ES Secador de alimentos

DRIES:
 - Fruit, vegetables, flowers, mushrooms, herbs, meat and much more

SUSZY:
 - Owoce, warzywa, kwiaty, grzyby, zioła, mięso i wiele innych

220-240V-50-60Hz **500 W**
 31x29.5 cm TRAY TACA **35-70 °C**
 0.5-19.5 h **5 TRAYS TACE**



LUND

No.	Power / Moc [W]	Icon
68271	420-500	4

EN Food dehydrator
 PL Suszarka spozywcza
 DE Lebensmittelrockner
 RU Сушилка для пищевых продуктов

CZ Sušička potravin
 RO Deshidrator alimente
 HU Ételszáritó
 ES Secador de alimentos

DRIES:
 - Fruit, vegetables, flowers, mushrooms, herbs, meat and much more

SUSZY:
 - Owoce, warzywa, kwiaty, grzyby, zioła, mięso i wiele innych

220-240V-50-60Hz **700 W**
 32.5x30 cm TRAY TACA **35-70 °C**
 0.5-19.5 h **9 TRAYS TACE**

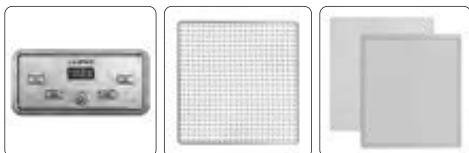
LUND

No.	Power / Moc [W]	Icon
68273	600-700	1

EN Food dehydrator
 PL Suszarka spozywcza
 DE Lebensmittelrockner
 RU Сушилка для пищевых продуктов

CZ Sušička potravin
 RO Deshidrator alimente
 HU Ételszáritó
 ES Secador de alimentos

DRIES:
 - Fruit, vegetables, flowers, mushrooms, herbs, meat and much more

SUSZY:
 - Owoce, warzywa, kwiaty, grzyby, zioła, mięso i wiele innych

220-240V-50-60Hz **500 W**
 32.5x30 cm TRAY TACA **35-70 °C**
 0.5-19.5 h **6 TRAYS TACE**





LUND

No.	Power / Moc [W]	Icon
68272	420-500	2

EN Tray for food dehydrator
 PL Tacka do suszarki spozywczej
 DE Tablett für Dörrgerät
 RU Лоток для пищевой сушилки
 CZ Táč do sušičky potravin
 RO Tava pt. dehidratarea alimentelor
 HU Tálca ételszáritóhoz
 ES Bandeja para secador de alimentos

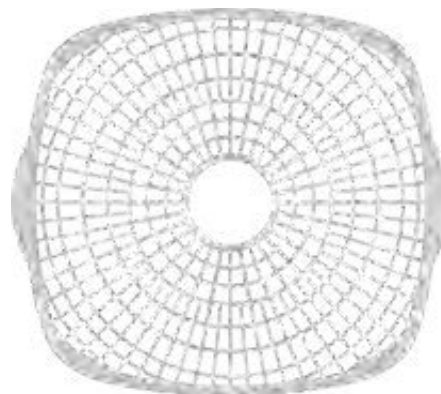
PC

LUND

No.	Size / Rozmiar [mm]	For / Dla	Icon
68269	310x295	68270, 68271	6

EN Slow cooker
 PL Wolnowar
 DE Schongarer
 RU Медленноварка
 CZ Pomalý hrnec
 RO Oală de gătit Slow Cooker
 HU Lassúfőző edény
 ES Olla de cocción lenta

FUNCTIONS:
 - Low temperature
 - High temperature
 - Keep warm

FUNKCJE:
 - Niska temperatura
 - Wysoka temperatura
 - Podtrzymywanie ciepła

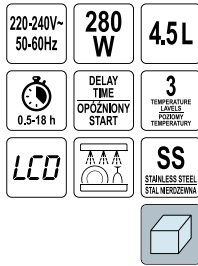

LUND

No.	Power / Moc [W]	
67660	280	2

EN Toaster
 PL Toster
 DE Toaster
 RU Тостер
 CZ Opékač topinek
 RO Aparat de prajit paine
 HU Kenyérpirító
 ES Tostadora

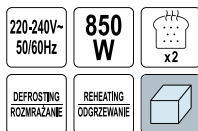

LUND

No.	Power / Moc [W]	
67500	700-850	6

EN Slow cooker
 PL Wolnowar
 DE Schongarer
 RU Медленноварка
 CZ Pomalý hrnec
 RO Oală de gătit Slow Cooker
 HU Lassúfőző edény
 ES Olla de cocción lenta

FUNCTIONS:
 - Low temperature
 - High temperature
 - Keep warm

FUNKCJE:
 - Niska temperatura
 - Wysoka temperatura
 - Podtrzymywanie ciepła

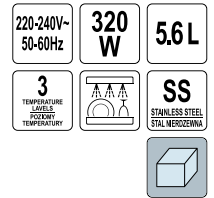

LUND

No.	Power / Moc [W]	
67661	320	2

EN Toaster
 PL Toster
 DE Toaster
 RU Тостер
 CZ Opékač topinek
 RO Aparat de prajit paine
 HU Kenyérpirító
 ES Tostadora

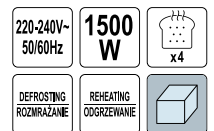

LUND

No.	Power / Moc [W]	
67501	1300-1500	4

EN Sandwich maker
 PL Opiekacz
 DE Sandwichmaker
 RU Сэндвичница
 CZ Sendvičovač
 RO Aparat pt. sandwich
 HU Szendvicssütő
 ES Sandwichera



LUND

No.	Power / Moc [W]	Box
67528	750	6

EN Sandwich maker
 PL Opiekacz
 DE Sandwichmaker
 RU Сэндвичница
 CZ Sendvičovač
 RO Aparat pt. sandwich
 HU Szendvicssütő
 ES Sandwichera

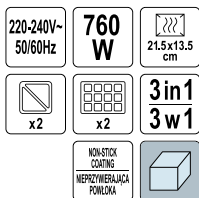

LUND

No.	Power / Moc [W]	Box
67525	640-760	6



EN Sandwich maker
 PL Opiekacz
 DE Sandwichmaker
 RU Сэндвичница
 CZ Sendvičovač
 RO Aparat pt. sandwich
 HU Szendvicssütő
 ES Sandwichera

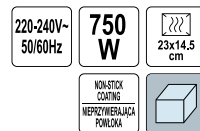

LUND

No.	Power / Moc [W]	Box
67526	750	6

EN Sandwich maker
 PL Opiekacz
 DE Sandwichmaker
 RU Сэндвичница
 CZ Sendvičovač
 RO Aparat pt. sandwich
 HU Szendvicssütő
 ES Sandwichera

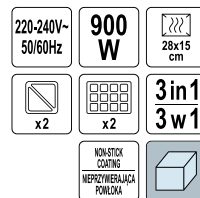

LUND

No.	Power / Moc [W]	Box
67530	900	3



EN Sandwich maker
 PL Opiekacz
 DE Sandwichmaker
 RU Сэндвичница

CZ Sendvičovač
 RO Aparat pt. sandwich
 HU Szendvicssütő
 ES Sandwichera

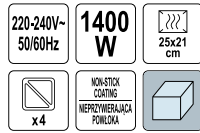

LUND

No.	Power / Moc [W]	Box
67520	1400	4

EN Contact grill
 PL Grill elektryczny
 DE Kontaktgrill
 RU Контактный гриль

CZ Kontaktní gril
 RO Grătar electric
 HU Elektromos grillsütő
 ES Parrilla de contacto

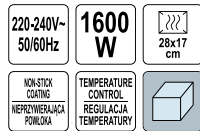

LUND

No.	Power / Moc [W]	Box
67458	1600	3

EN Cookie maker
 PL Opiekacz do ciastek
 DE Plätzchen-Toaster
 RU Вафельница для печенья
 CZ Opekač na cookies
 RO Aparat pt. fursecuri
 HU Sütemény készítő gép
 ES Tostadora de galletas



LUND

No.	Power / Moc [W]	Box
67527	1400	6

EN Contact grill
 PL Grill elektryczny
 DE Kontaktgrill
 RU Контактный гриль
 CZ Kontaktní gril
 RO Grătar electric
 HU Elektromos grillsütő
 ES Parrilla de contacto



LUND

No.	Power / Moc [W]	Box
67451	2200	3

EN Contact grill
 PL Grill elektryczny
 DE Kontaktgrill
 RU Контактный гриль
 CZ Kontaktní gril
 RO Grătar electric
 HU Elektromos grillstűtő
 ES Parrilla de contacto

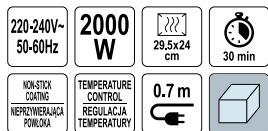

LUND

No.	Power / Moc [W]	
67457	2000	3

EN Electric table grill
 PL Grill stolowy elektryczny
 DE Elektro-Tischgrill
 RU Настольный электрический гриль
 CZ Elektrický stolní gril
 RO Grătar electric de masă
 HU Elektromos asztali grill
 ES Plancha de asar eléctrica

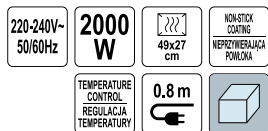

LUND

No.	Power / Moc [W]	
67453	2000	4

EN Contact grill
 PL Grill elektryczny
 DE Kontaktgrill
 RU Контактный гриль
 CZ Kontaktní gril
 RO Grătar electric
 HU Elektromos grillstűtő
 ES Parrilla de contacto

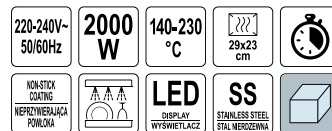

LUND

No.	Power / Moc [W]	
67450	2000	3

EN Electric table grill
 PL Grill stolowy elektryczny
 DE Elektro-Tischgrill
 RU Настольный электрический гриль
 CZ Elektrický stolní gril
 RO Grătar electric de masă
 HU Elektromos asztali grill
 ES Plancha de asar eléctrica

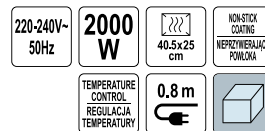

LUND

No.	Power / Moc [W]	
67455	2000	2

FEATURES:
 - 3 levels of preparation: rare, medium, well done
 - 5 functions: steak, chicken, fish, sandwich, hamburger

CECHY:
 - 3 poziomy przygotowania: słabo wysmażony, średnio wysmażony, dobrze wysmażony
 - 5 funkcji: stek, kurczak, ryba, kanapka (tost), hamburger

EN Electric grill with stand
 PL Grill elektryczny ze stojakiem
 DE Elektrogrill mit Ständer
 RU Электрический гриль с подставкой
 CZ Elektrický gril se stojanem
 RO Grătar electric cu stand
 HU Elektromos grill állványal
 ES Barbacoa eléctrica con soporte

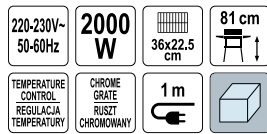

- FEATURES:**
- No smoking grill
 - Chromed warming rack
 - Detachable water bowl
 - Detachable stand

- CECHY:**
- Grill bezdymny
 - Chromowana kratka podgrzewająca
 - Misa na wodę
 - Możliwość odłączenia podstawy



LUND

No.	Power / Moc [W]	
67423	1800-2000	4

EN Electric grill with stand
 PL Grill elektryczny ze stojakiem
 DE Elektrogrill mit Ständer
 RU Электрический гриль с подставкой
 CZ Elektrický gril se stojanem
 RO Grătar electric cu stand
 HU Elektromos grill állványal
 ES Barbacoa eléctrica con soporte



LUND

No.	Power / Moc [W]	
67420	2000-2200	1

EN Electric grill with stand
 PL Grill elektryczny ze stojakiem
 DE Elektrogrill mit Ständer
 RU Электрический гриль с подставкой
 CZ Elektrický gril se stojanem
 RO Grătar electric cu stand
 HU Elektromos grill állványal
 ES Barbacoa eléctrica con soporte



- FEATURES:**
- No smoking grill
 - Plate with non-stick coating
 - Oil drip cup
 - Detachable stand

- CECHY:**
- Grill bezdymny
 - Płyta z nieprzywierającą powłoką
 - Pojemnik na tłuszcz
 - Możliwość odłączenia podstawy



LUND

No.	Power / Moc [W]	
67424	2200	2

EN Waffle maker
 PL Gofrownica
 DE Waffeleisen
 RU Вафельница
 CZ Vařovač
 RO Aparat de preparat waffle
 HU Gofrisütő
 ES Gofrera

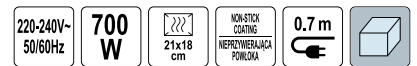

- FEATURES:**
- Rotation 180°
- CECHY:**
- Otwierana pod kątem 180°



LUND

No.	Power / Moc [W]	
68014	700	6

- EN Crepe maker
- PL Naleśnikarka
- DE Kreppmacher
- RU Плита для блинов
- CZ Plošna na palačinky
- RO Pliță pt. clătite
- HU Palacsintasütő
- ES Crepera eléct

220-240V~50/60Hz **1000 W** \varnothing 30cm

NON-STICK COATING
NEPRZYMIERZAJĄCA POWŁOKA

TEMPERATURE CONTROL
REGULACJA TEMPERATURY

0.8 m



LUND

No.	Power / Moc [W]	
67470	1000	6

- EN Pizza oven stone
- PL Kamień do pieca na pizzę
- DE Pizzaofen-Steinplatte
- RU Камень для печи для пиццы
- CZ Kámen do pece na pizzu
- RO Tava piatră pt. pizza
- HU Pizzakő kemencébe
- ES Piedra de horno para pizza

\varnothing 32cm

CORDIERITE
KORDIERYT



LUND

No.	Ø [mm]	For / Dla	
67481	320	67480	5

- EN Vacuum sealer
- PL Pakowarka próżniowa
- DE Vakuuierer
- RU Вакуумный упаковщик
- CZ Vakuová balíčka
- RO Aparat de ambalare in vid
- HU Vákuum csomagolóhoz
- ES Envasadora al vacío



LUND

No.	Power / Moc [W]	
67880	140	12

- EN Pizza maker
- PL Piec do pizzy
- DE Pizzaofen
- RU Печь для пиццы
- CZ Pec na pizzu
- RO Cuptor pizza
- HU Pizzasütő kemence
- ES Horno para pizza

220-240V~50/60Hz **1200 W** max°C **400** \varnothing 32cm

TEMPERATURE CONTROL
REGULACJA TEMPERATURY

0-15 min



LUND

No.	Power / Moc [W]	
67480	1200	1

- EN Vacuum sealer
- PL Pakowarka próżniowa
- DE Vakuuierer
- RU Вакуумный упаковщик
- CZ Vakuová balíčka
- RO Aparat de ambalare in vid
- HU Vákuum csomagolóhoz
- ES Envasadora al vacío

220-240V~50-60Hz **130 W** **-70 kPa** max **30cm**

8-10 l/min



LUND

No.	Power / Moc [W]	
67877	130	6

20

- EN Vacuum sealer
- PL Pakowarka próżniowa
- DE Vakuuierer
- RU Вакуумный упаковщик
- CZ Vakuová balíčka
- RO Aparat de ambalare in vid
- HU Vákuum csomagolóhoz
- ES Envasadora al vacío

230V~50Hz **140 W** **-60 kPa** max **22cm**

11 l/min



Bags not included
Produkt nie zawiera worków w zestawie



LUND

No.	Power / Moc [W]	
67880	140	12

EN Vacuum sealer
 PL Pakowarka próżniowa
 DE Vakuumierer
 RU Вакуумный упаковщик
 CZ Vakuová balíčka
 RO Aparat de ambalare in vid
 HU Vákuum csomagolóhoz
 ES Envasadora al vacío

220-240V~
50-60Hz

165 W

-90 kPa

max 32 cm

18 l/min

DOUBLE SEAL
PODWÓJNY ZGRZEW



LUND

No.	Power / Moc [W]	
67881	165	6

EN Vacuum bags
 PL Worki moletowane
 DE Goffrierte Vakuumbeutel
 RU Пакеты с накаткой для вакуумной упаковки
 CZ Vroubkované vakuové sáčky
 RO Pungi pt. vidat gofrate
 HU Légszatornás vákuumtasakok
 ES Bolsas gofradas para envasar al vacío

50 PCS

90 µm

PA PE



LUND

No.	Size / Rozmiar [cm]	Thickness / Grubość [µm]	For / Dla	pcs / szt.	
67887	20x30	90	67880	50	24
67888	25x35	90	67880, 67882	50	14
67889	30x40	90	67881, 67877	50	12

EN Vacuum food container
 PL Pojemnik próżniowy na żywność
 DE Vakuumbehälter
 RU Вакуумный контейнер
 CZ Vakuová dóza na potraviny
 RO Cutie alimente cu sistem vacuum
 HU Vákuumos doboz
 ES Tarros de vacío

2 PCS

0.75L

1.5L

DATE SETTING
USTAWIENIE
DATY



FEATURES:

- Help to keep freshness and taste
- Possibility to set a date on the lid

CECHY:

- Pomaga zachować świeżość i smak
- Możliwość zaznaczenia daty na pokrywie



LUND

No.	Capacity / Pojemność [l]	
67890	0.75, 1.5	12

EN Vacuum sealer
 PL Pakowarka próżniowa
 DE Vakuumierer
 RU Вакуумный упаковщик
 CZ Vakuová balíčka
 RO Aparat de ambalare in vid
 HU Vákuum csomagolóhoz
 ES Envasadora al vacío

230V~
50Hz

175 W

-80 kPa

max 28 cm

16 l/min

ADJUSTABLE VACUUM RATE
REGULACJA SIŁY SSANIA



Bags not included
 Produkt nie zawiera worków w zestawie



LUND

No.	Power / Moc [W]	
67882	175	6

EN Vacuum sealer roll
 PL Folia moletowana w rolce
 DE Goffrierte Vakuumrolle
 RU Фольга с накаткой в ролоне
 CZ Vakuovací vroubkovaná fólie na roli
 RO Rola folie gofrata pt. vidat
 HU Vákuumfólia tekerek
 ES Rollo gofrado para envasar al vacío

105 µm

PA PE



LUND

No.	Size / Rozmiar [cm]	Thickness / Grubość [µm]	For / Dla	
67883	25x600	105	67881, 67882, 67877	42
67884	28x600	105	67881, 67877	38
67885	30x600	105	67881	34

EN Hose for vacuum sealer
 PL Wąż do pakowarki próżniowej
 DE Vakuumierschlauch
 RU Шланг для вакуумного упаковщика
 CZ Hadice pro vakuovačku
 RO Furtun pt. aparat de vidat
 HU Összekötő cső tároló dobozokhoz
 ES Manguera para envasadora al vacío

40 cm



LUND

No.	L [mm]	For / Dla	
67872	400	67877, 67881, 67882	300

EN Kitchen scale
 PL Waga kuchenna
 DE Küchenwaage
 RU Кухонные весы
 CZ Kuchyňská váha
 RO Cantar bucatarie
 HU Konyhamérleg
 ES Báscula de cocina

FEATURES:
 - Weight units: oz, g, kg, lb
CECHY:
 - Jednostki wagi: oz, g, kg, lb



LUND

No.	Max. load capacity / Maks. obciążenie [g]	
68360	3000	12

EN Kitchen scale
 PL Waga kuchenna
 DE Küchenwaage
 RU Кухонные весы
 CZ Kuchyňská váha
 RO Cantar bucatarie
 HU Konyhamérleg
 ES Báscula de cocina

FEATURES:
 - Weight units: oz, g, kg, lb
 - Scale area: 15 x 17.5 cm

CECHY:
 - Jednostki wagi: oz, g, kg, lb
 - Powierzchnia ważenia: 15 x 17.5 cm



LUND

No.	Max. load capacity / Maks. obciążenie [g]	
68362	5000	12

EN Kitchen scale
 PL Waga kuchenna
 DE Küchenwaage
 RU Кухонные весы
 CZ Kuchyňská váha
 RO Cantar bucatarie
 HU Konyhamérleg
 ES Báscula de cocina

FEATURES:
 - Weight units: g, oz
 - Water and milk units: ml, fl oz
 - Removeable jug

CECHY:
 - Jednostki wagi: g, oz
 - Jednostki pomiaru wody, mleka: ml, fl oz
 - Możliwość wyjęcia pojemnika



LUND

No.	Max. load capacity / Maks. obciążenie [g]	
68364	2000	12

EN Kitchen scale
 PL Waga kuchenna
 DE Küchenwaage
 RU Кухонные весы
 CZ Kuchyňská váha
 RO Cantar bucatarie
 HU Konyhamérleg
 ES Báscula de cocina

FEATURES:
 - Weight units: oz, g, kg, lb
 - Removeable bowl
CECHY:
 - Jednostki wagi: oz, g, kg, lb
 - Możliwość wyjęcia misy



LUND

No.	Max. load capacity / Maks. obciążenie [g]	
68361	5000	12

EN Kitchen scale
 PL Waga kuchenna
 DE Küchenwaage
 RU Кухонные весы
 CZ Kuchyňská váha
 RO Cantar bucatarie
 HU Konyhamérleg
 ES Báscula de cocina

FEATURES:
 - Weight units: g, kg, ml
 - Scale area: 27 x 22.5 cm

CECHY:
 - Jednostki wagi: g, kg, ml
 - Powierzchnia ważenia: 27 x 22.5 cm



LUND

No.	Max. load capacity / Maks. obciążenie [g]	
68363	5000	12

EN Kitchen scale
 PL Waga kuchenna
 DE Küchenwaage
 RU Кухонные весы
 CZ Kuchyňská váha
 RO Cantar bucatarie
 HU Konyhamérleg
 ES Báscula de cocina

FEATURES:
 - Weight units: g, oz
 - Hold function
 - Summary function: max 3000 g

CECHY:
 - Jednostki wagi: g, oz
 - Funkcja utrzymania cyfry na wyświetlaczu
 - Funkcja sumowania: maks. 3000 g



LUND

No.	Max. load capacity / Maks. obciążenie [g]	
68365	300	50

EN Popcorn maker
 PL Urządzenie do popcornu
 DE Popcorngerät
 RU Аппарат для попкорна
 CZ Zařízení k výrobě popcornu
 RO Aparat de facut popcorn
 HU Popcorn gép
 ES Máquina de palomitas de maíz

220-240V-50/60Hz 1200 W ANTI-SLIP FEET NOŻKI ANTY-POŚLIZGOWE



FEATURES:

- Capacity: 50-60 g com
- Without oil
- Ready in 3 min.

CECHY:

- Pojemność: 50-60 g ziaren na cykl
- Bez użycia oleju
- Gotowe w 3 min

LUND

No.	Power / Moc [W]	
68260	1200	6

EN Cyclonic vacuum cleaner
 PL Odkurzacz cyklonowy
 DE Zyklonischer Staubsauger
 RU Циклонный пылесос
 CZ Cyklonový vysavač
 RO Aspirator ciclonic
 HU Cyclone porszívó
 ES Aspiradora ciclónica

220-240V-50/60Hz 700 W 1.5 L CYCLONIC CYKLONOWY HEPA H13 BAGLESS BEZ-WORKOWY 5 m



LUND

No.	Power / Moc [W]	
67090	700	1

EN Cyclonic vacuum cleaner
 PL Odkurzacz cyklonowy
 DE Zyklonischer Staubsauger
 RU Циклонный пылесос
 CZ Cyklonový vysavač
 RO Aspirator ciclonic
 HU Cyclone porszívó
 ES Aspiradora ciclónica



220-240V-50/60Hz 700 W 1.5 L CYCLONIC CYKLONOWY HEPA H13 BAGLESS BEZ-WORKOWY 5 m

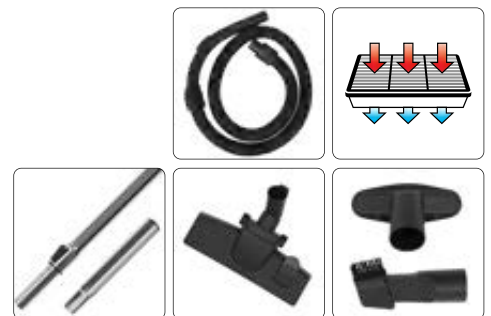

LUND

No.	Power / Moc [W]	
67091	700	1

EN Vacuum cleaner filter
 PL Filtr do odkurzacza
 DE Staubsaugerfilter
 RU Фильтр для пылесоса
 CZ Filtr pro vysavače
 RO Filtru aspirator
 HU Porszívó szűrő
 ES Filtro para aspirador

HEPA H13

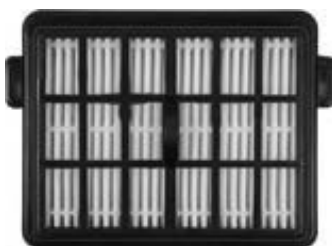

LUND

No.	For / Dla	
67093	67090	250

EN Vacuum cleaner filter
 PL Filtr do odkurzacza
 DE Staubsaugerfilter
 RU Фильтр для пылесоса
 CZ Filtr pro vysavače
 RO Filtru aspirator
 HU Porszívó szűrő
 ES Filtro para aspirador

HEPA H13

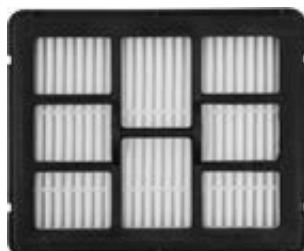

LUND

No.	For / Dla	
67094	67091, 67092	250

EN Vacuum cleaner filter
 PL Filtr do odkurzacza
 DE Staubsaugerfilter
 RU Фильтр для пылесоса
 CZ Filtr pro vysavače
 RO Filtru aspirator
 HU Porszívó szűrő
 ES Filtro para aspirador

HEPA H13

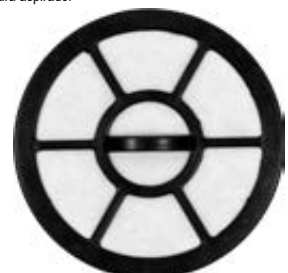

LUND

No.	For / Dla	
67095	67090, 67091, 67092	200

EN Cyclonic vacuum cleaner
 PL Odkurzacz cyklonowy
 DE Zyklonischer Staubsauger
 RU Циклонный пылесос
 CZ Cyklonový vysavač
 RO Aspirator ciclonic
 HU Cyclone porszívó
 ES Aspiradora ciclónica

220-240V-50/60Hz	800 W	1L
	BAGLESS BEZ-WORKOWY	HEPA H13
	4.8 m	



LUND

No.	Power / Moc [W]	
67110	800	4

EN Rechargeable vacuum cleaner
 PL Bezprzewodowy odkurzacz pionowy
 DE Akku-hand Bodenbürstsauger
 RU Перезаряжаемый пылесос
 CZ Akumulátorový vysavač
 RO Aspirator vertical cu acumulator
 HU Újratölhető porszívó
 ES Aspiradora recargable

22.2V 2200mAh Li-Ion	120 W	1L	4-5h	25-35 min	
					HEPA H13
					BAGLESS BEZ-WORKOWY



LUND

No.	Power / Moc [W]	
67120	120	4

EN Cyclonic vacuum cleaner
 PL Pionowy odkurzacz cyklonowy
 DE Zyklonischer Staubsauger
 RU Циклонный пылесос
 CZ Cyklonový vysavač
 RO Aspirator vertical ciclonic
 HU Cyclone porszívó
 ES Aspiradora ciclónica

220-240V-50Hz	800 W	1.5L	
	BAGLESS BEZ-WORKOWY	HEPA H13	4.8 m



LUND

No.	Power / Moc [W]	
67112	800	4

EN Rechargeable vacuum cleaner
 PL Bezprzewodowy odkurzacz pionowy
 DE Akku-hand Bodenbürstsauger
 RU Перезаряжаемый пылесос
 CZ Akumulátorový vysavač
 RO Aspirator vertical cu acumulator
 HU Újratölhető porszívó
 ES Aspiradora recargable

22.2V 2200mAh Li-Ion	200 W	10/20 kPa	4-5h	12-30 min	
					HEPA H13
					BAGLESS BEZ-WORKOWY
					BRUSHLESS MOTOR SILENK BEZ-SZCZOTKOWY



LUND

No.	Power / Moc [W]	
67121	200	4

EN Vacuum cleaner filter
 PL Filtr do odkurzacza
 DE Staubsaugerfilter
 RU Фильтр для пылесоса
 CZ Filtr pro vysavače
 RO Filtru aspirator
 HU Porszívó szűrő
 ES Filtro para aspirador



LUND

No.	For / Dla	
67115	67110, 67120	100
67116	67111	200

EN Roller for vacuum cleaner
 PL Walek do odkurzacza
 DE Staubsauger Bar-Rolle
 RU Валик для пылесоса
 CZ Váleček do vysavače
 RO Rolă pt. aspirator
 HU Porszívó tengely
 ES Rodillo de aspiradora



LUND

No.	For / Dla	
67123	67121	60

EN Carpet vacuum cleaner
 PL Odkurzacz piorący
 DE Waschstaubsauger
 RU Пылесос моющий
 CZ Vysavač s funkcí praní
 RO Aspirator cu spalare
 HU Szárás-nedves porszívó
 ES Lava-aspirador

220-240V~ 50-60Hz	1200 W	17 kPa	20/3L	WET AND DRY SUCHO I MOKRO	WASHING FUNCTION FUNKCJA PRANIA
BLOW FUNCTION FUNKCJA DMUCHAWY	HEPA	IPX4	3.9 m		

INCLUDED:

- Wet and dry floor brush
- Large carpet cleaning brush
- Small sofa cleaning brush
- Crevice nozzle
- Hose with handle and button
- HEPA filter
- Sponge filter

W ZESTAWIE:

- Dysza podłogowa do odkurzenia na sucho i mokro
- Szeroka szczotka do czyszczenia wykładzin
- Wąska końcówka do mycia
- Dysza szczelinowa
- Wąż z uchwytem i przyciskiem
- Filtr HEPA
- Filtr piankowy

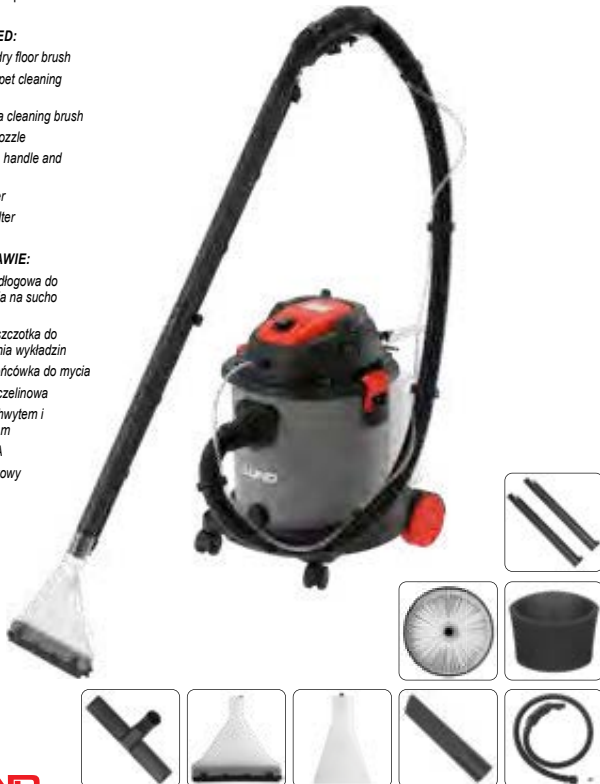

LUND

No.	Power / Moc [W]	
67125	1200	1

EN Vacuum cleaner filter
 PL Filtr do odkurzacza
 DE Staubsaugerfilter
 RU Фильтр для пылесоса
 CZ Filtr pro vysavače
 RO Filtru aspirator
 HU Porszívó szűrő
 ES Filtro para aspirador



LUND

No.	For / Dla	
67122	67121	100

EN Microfiber for vacuum cleaner
 PL Mikrofibra do odkurzacza
 DE Mikrofaser für Staubsauger
 RU Микрофибра для пылесоса
 CZ Mikrovlákno do vysavače
 RO Rezerva microfibra pt. aspirator
 HU Mikroszálás kendő porszívóhoz
 ES Microfibra de aspiradora



LUND

No.	Size / Rozmiar [cm]	For / Dla	
67124	23.5x9.5	67121	300

EN Vacuum cleaner filters
 PL Filtry do odkurzacza
 DE Staubsaugerfilter-Set
 RU Фильтры для пылесоса
 CZ Filtry pro vysavače
 RO Filtre pt. aspiratoare
 HU Porszívó szűrő szett
 ES Filtros para aspirador



LUND

No.	For / Dla	pcs / szt.	
67126	67125	2	100

- EN Steam cleaner
- PL Myjka parowa
- DE Dampfreiniger
- RU Паровой очиститель
- CZ Parní čistič
- RO Aparat de curățat cu abur
- HU Gőztisztító
- ES Limpiador a vapor

220-240V-50/60Hz	900-1050 W	0.3 MPa	350 ml
28 g/min	max °C 110	10 ELEMENTS ELEMENTY	2 m



LUND

No.	Power / Moc [W]	
67200	900-1050	6

- EN Accessories for steam cleaner
- PL Akcesoria do myjki parowej
- DE Dampfreiniger-Zubehör
- RU Аксессуары для пароочистителя
- CZ Příslušenství pro parní čistič
- RO Accesorii pt. curatator cu abur
- HU Tartozékok gőztisztítóhoz
- ES Accesorios para la limpiadora a vapor

4 PCS	
-------	--

- INCLUDED:**
- Brass brush
 - Bent nozzle
 - Round small nylon brush
 - Towel microfiber cloth
- W ZESTAWIE:**
- Szczotka z włosiem z mosiądzu
 - Zaokrąglona dysza
 - Mała okrągła szczotka
 - Mała nakładka z mikrofibry



LUND

No.	For / Dla	pcs / szt.	
67202	67200, 67201	4	200

20

- EN Microfibre for steam cleaner
- PL Mikrofibra do myjki parowej
- DE Mikrofaser-Bezug für Dampfreiniger
- RU Микрофибра для пароочистителя
- CZ Násada z mikrovlákna na parní čistič
- RO Rezerva microfibră pt. curatator cu abur
- HU Mikroszálas kendő gőztisztítóhoz
- ES Microfibra para la limpiadora a vapor



LUND

No.	Size / Rozmiar [cm]	For / Dla	pcs / szt.	
67204	35x11	67201	3	100

- EN Steam cleaner
- PL Myjka parowa
- DE Dampfreiniger
- RU Паровой очиститель
- CZ Parní čistič
- RO Aparat de curățat cu abur
- HU Gőztisztító
- ES Limpiador a vapor

220-240V-50/60Hz	900-1050 W	0.3 MPa
400 ml	28-40 g/min	max °C 110



LUND

No.	Power / Moc [W]	
67201	900-1050	4

- EN Tube for steam cleaner
 - PL Wąż do myjki parowej
 - DE Schlauch für Dampfreiniger
 - RU Шланг для пароочистителя
 - CZ Hadice pro parní čistič
 - RO Furtun pt. curățator cu abur
 - HU Tömlő gőztisztítóhoz
 - ES Manguera para la limpiadora a vapor
- INCLUDED:**
- Flexible tube with nozzle
- W ZESTAWIE:**
- Elastyczny wąż z dyszą

1 PCS	
-------	--



LUND

No.	L [cm]	For / Dla	
67203	55	67200, 67201	70

3 PCS	
-------	--

EN Steam mop
 PL Mop parowy
 DE Dampfmopp
 RU Паровая швабра
 CZ Parní mop
 RO Mop cu abur
 HU Gőztisztító mop
 ES Trapeador a vapor

220-240V~ 50/60Hz	1500 W
550 ml	10-26 g/min
max °C 110	14 ELEMENTS ELEMENTY
5 m	

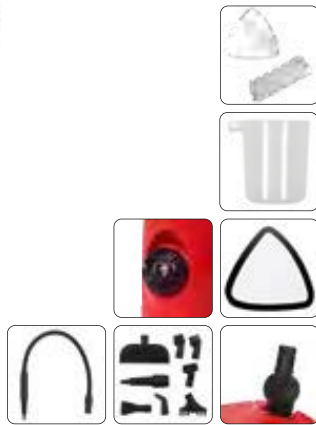

LUND

No.	Power / Moc [W]	
67220	1500	4

EN Tube and jet nozzle for steam mop
 PL Wąż i dysza do mopu parowego
 DE Schlauch und Düse für Dampfmopp
 RU Шланг и насадка для паровой швабры
 CZ Hadice a tryska pro parní mop
 RO Tub si duza jet pt. mop cu abur
 HU Tömlő és fúvóka gőzfelmosóhoz
 ES Manguera y boquilla para la mopa a vapor

2 PCS	80 cm	
-----------------	-----------------	--

INCLUDED:
 - Flexible tube
 - Jet nozzle

W ZESTAWIE:
 - Elastyczny wąż
 - Długa dysza



LUND

No.	L [cm]	For / Dla	pcs / szt.	
67225	80	67220, 67221	2	50

EN Microfibre for steam mop
 PL Mikrofibra do mopu parowego
 DE Mikrofaser-Bezug für Dampfmopp
 RU Микрофибра для паровой швабры
 CZ Násada z mikrovlákna na parní mop
 RO Rezerva microfibră pt. mop cu abur
 HU Mikroszálalás kendő gőzfelmosóhoz
 ES Microfibra para mopa a vapor

3 PCS		
-----------------	--	--



LUND

No.	For / Dla	pcs / szt.	
67222	67220	3	67

EN Accessories for steam mop
 PL Akcesoria do mopu parowego
 DE Dampfmopp-Zubehör
 RU Аксессуары для паровой швабры
 CZ Příslušenství pro parní mop
 RO Accesorii pt. mop cu abur
 HU Tartozékok gőzfelmosóhoz
 ES Accesorios para la mopa a vapor

INCLUDED:
 - Brass brush
 - Round small nylon brush
 - Round large nylon brush
 - Slender brush
 - Scrap shovel
 - Bent nozzle
 - Towel microfibre cloth

W ZESTAWIE:
 - Szczotka z włosiem z mosiądzu
 - Mała okrągła szczotka
 - Duża okrągła szczotka
 - Szczotka do fug
 - Skrobak
 - Zaokrąglona dysza
 - Mała nakładka z mikrofibry

7 PCS	
-----------------	--



LUND

No.	For / Dla	pcs / szt.	
67224	67220, 67221	7	150

EN Electric mop
 PL Mop elektryczny
 DE Elektrischer Wischmopp
 RU Электрическая швабра
 CZ Elektrický mop
 RO Mop electric
 HU Elektromos felmosó
 ES Mopa eléctrica

7.4 V 2000mAh 	200 min ²	200 ml
4h 	35-40 min 	
LED CHARGE INDICATOR WSKAZNIK NAŁADZIWANIA BATERII	TELESCOPIC HANDLE UCHWYT TELESKOPOWY	



LUND

No.	Battery voltage / Napięcie akumulatora [V d.c.]	
67182	7.4	6

- EN Microfiber pads for electric mops
- PL Mikrofibra do mopów elektrycznych
- DE Mikrofaser-Bezug für elektrische Wischmopps
- RU Микрофибра для электрических швабр
- CZ Tkanina z mikrovlnákná do elektrických mopů
- RO Rezervă microfibra pt. mop electric
- HU Mikroszálás feltét elektromos felmosóhoz
- ES Microfibra para mopa eléctrica



LUND

No.	For / Dla	pcs / szt.	
67183	67182	3	200

- EN Travel iron
- PL Żelazko turystyczne
- DE Kompakt-Bügeleisen
- RU Туристический утюг
- CZ Turistická žehlička
- RO Fier de calcat pt calatorii
- HU Hordozható vasaló
- ES Plancha de viaje

220-240V~110-120V~50-60Hz

1100 W

80 ml

10±3 g/min

CERAMIC SOLEPLATE CERAMICZNA STOPA

2 m

- FUNCTIONS:**
- Dry
 - Steam
 - Burst of steam
 - Temperature control
- FUNKCJE:**
- Prasowanie na sucho
 - Prasowanie z parą
 - Uderzenie pary
 - Regulacja temperatury



LUND

No.	Power / Moc [W]	
68100	1100	10

- EN Garment steamer
- PL Parownica do ubrań
- DE Dampfglätter
- RU Отпариватель для одежды
- CZ Oděv parník
- RO Aparat de calcat vertical
- HU Ruha gőztisztító
- ES Vapor de la ropa

220-240V~50-60Hz

1100 W

100 ml

10 g/min

13x7.5 cm

CERAMIC SOLEPLATE CERAMICZNA STOPA

2 m



LUND

No.	Power / Moc [W]	
68090	900-1100	10

- EN Steam iron
- PL Żelazko parowe
- DE Dampfbügeleisen
- RU Паровой утюг
- CZ Napařovací žehlička
- RO Fier de calcat cu abur
- HU Gőzölös vasaló
- ES Plancha de vapor

- FUNKCJE:**
- Prasowanie na sucho
 - Spryskiwacz
 - Prasowanie z parą
 - Uderzenie pary
 - Pionowy wyrzut pary
 - Funkcja samoczyszczenia
 - Blokada kapania
 - System antywapienny
 - Automatyczne wyłączenie
 - Regulacja temperatury

220-240V~50-60Hz

2800 W

320 ml

18±3 g/min

23.5x12.5 cm

CERAMIC SOLEPLATE CERAMICZNA STOPA

2 m

- FUNCTIONS:**
- Dry
 - Spray
 - Steam
 - Burst of steam
 - Vertical steam
 - Self-cleaning
 - Anti-drip
 - Anti-calcium
 - Auto shut off
 - Temperature control



LUND

No.	Power / Moc [W]	
68115	2800	10

- EN Convector heater
- PL Grzejnik konwektorowy
- DE Konvektorheizgerät
- RU Конвекторный обогреватель
- CZ Konvektor
- RO Încalzitor cu convector
- HU Konvektoros fűtőtest
- ES Calentador de convección

220-240V~50-60Hz

2000 W

- FEATURES:**
- 2 power modes: 1250 W, 2000 W
- CECHY:**
- 2 tryby mocy: 1250 W, 2000 W



LUND

No.	Power / Moc [W]	
68650	2000	1

EN Convector heater
 PL Grzejnik konwektorowy
 DE Konvektorheizgerat
 RU Конвекторный обогреватель
 CZ Konvektor
 RO Incalzitor cu convector
 HU Konvektoros futoetest
 ES Calentador de conveccion

FEATURES:
 - 3 power modes: 750 W, 1250 W, 2000 W
CECHY:
 - 3 tryby mocy: 750 W, 1250 W, 2000 W

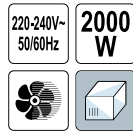

LUND

No.	Power / Moc [W]	Icon
68651	1800-2000	1

EN Convector heater with humidifier
 PL Grzejnik konwektorowy z nawilzaczem
 DE Konvektorheizgerat mit Luftbefeuchter
 RU Конвекторный обогреватель с увлажнителем воздуха
 CZ Konvektorový ohřivač se zvlhčovačem
 RO Incalzitor convector cu umidificator
 HU Konvektoros futoetest legnedvesitovel
 ES Calentador de conveccion con humidificador

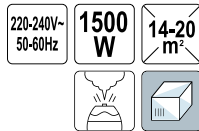

FEATURES:
 - 2 power modes: 750 W, 1500 W
CECHY:
 - 2 tryby mocy: 750 W, 1500 W



LUND

No.	Power / Moc [W]	Icon
68630	1500	1

EN Convection and radiant heater with humidifier
 PL Grzejnik konwektorowo-promiennikowy z nawilzaczem
 DE Konvektions- und Strahlungsheizung mit Luftbefeuchter
 RU Конвективно-инфракрасный обогреватель с увлажнителем воздуха
 CZ Konvektivní a sálavé topení se zvlhčovačem
 RO Incalzitor cu convecție și radiant cu umidificator
 HU Konvektoros hőszugárzó futoetest legnedvesitovel
 ES Calentador de convección-radiación con humidificador

FEATURES:
 - 2 power modes: 1000 W, 2000 W
CECHY:
 - 2 tryby mocy: 1000 W, 2000 W

LUND

No.	Power / Moc [W]	Icon
68632	2000	1

EN Convector heater
 PL Grzejnik konwektorowy
 DE Konvektorheizgerat
 RU Конвекторный обогреватель
 CZ Konvektor
 RO Incalzitor cu convector
 HU Konvektoros futoetest
 ES Calentador de conveccion

FEATURES:
 - 3 power modes: 1000 W, 1300 W, 2300 W
 - Temperature control: 5-37°
CECHY:
 - 3 tryby mocy: 1000 W, 1300 W, 2300 W
 - Regulacja temperatury: 5-37°

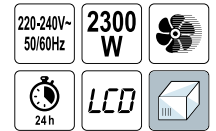

LUND

No.	Power / Moc [W]	Icon
68652	2300	1

EN Convector heater with humidifier
 PL Grzejnik konwektorowy z nawilzaczem
 DE Konvektorheizgerat mit Luftbefeuchter
 RU Конвекторный обогреватель с увлажнителем воздуха
 CZ Konvektorový ohřivač se zvlhčovačem
 RO Incalzitor convector cu umidificator
 HU Konvektoros futoetest legnedvesitovel
 ES Calentador de conveccion con humidificador



FEATURES:
 - 2 power modes: 1000 W, 2000 W
CECHY:
 - 2 tryby mocy: 1000 W, 2000 W



LUND

No.	Power / Moc [W]	Icon
68631	2000	1



EN Tower fan
 PL Wentylator kolumnowy
 DE Säulenventilator
 RU Вентилятор колонный
 CZ Sloupový ventilátor
 RO Ventilator turn
 HU Oszloplventilátor
 ES Ventilador de torre

FEATURES:
 - 3 wind modes (natural, normal, sleep)
 - Remote control
 - Control panel
 - LED display
 - Handle

CECHY:
 - 3 tryby podmuchu (naturalny, normalny, nocny)
 - Pilot
 - Panel sterowania
 - Wyświetlacz LED
 - Uchwyt

220-240V-50Hz

50 W

4 m³/min

x3

65°

max 45 dB

7.5h

LED DISPLAY WYŚWIETLACZ

TEMPERATURE INDICATOR WSKAŹNIK TEMPERATURY

81 cm

1.5 m



LUND

No.	Power / Moc [W]	
66841	50	1

EN Tower fan
 PL Wentylator kolumnowy
 DE Säulenventilator
 RU Вентилятор колонный
 CZ Sloupový ventilátor
 RO Ventilator turn
 HU Oszloplventilátor
 ES Ventilador de torre

FEATURES:
 - 3 wind modes (natural, normal, sleep)
 - Remote control
 - Control panel
 - LED display
 - Handle

CECHY:
 - 3 tryby podmuchu (naturalny, normalny, nocny)
 - Pilot
 - Panel sterowania
 - Wyświetlacz LED
 - Uchwyt

220-240V-50Hz

50 W

4 m³/min

x3

65°

max 45 dB

7.5h

LED DISPLAY WYŚWIETLACZ

TEMPERATURE INDICATOR WSKAŹNIK TEMPERATURY

95.5 cm

1.5 m



LUND

No.	Power / Moc [W]	
66842	50	1

EN Aroma diffuser
 PL Dyfuzor zapachu
 DE Aroma-Diffusor
 RU Диффузор запаха
 CZ Difuzér vůně
 RO Difuzor aromaterapie
 HU Illatdiffúzor
 ES Difusor de fragancias

FEATURES:
 - Work type: ultrasounds

CECHY:
 - Rodzaj pracy: ultradźwięki

5W

100 ml

15 ml/h

7 COLOURS KOLORY

15m²

3 h



LUND

No.	Power / Moc [W]	
66900	5	36

EN Aroma diffuser
 PL Dyfuzor zapachu
 DE Aroma-Diffusor
 RU Диффузор запаха
 CZ Difuzér vůně
 RO Difuzor aromaterapie
 HU Illatdiffúzor
 ES Difusor de fragancias

FEATURES:
 - Work type: ultrasounds
 - Mist type: low, high

CECHY:
 - Rodzaj pracy: ultradźwięki
 - Rodzaje mgiełki: niska, wysoka

12 W

100-240V-50/60Hz

120 ml

30 ml/h

7 COLOURS KOLORY

20m²

2 h



LUND

No.	Power / Moc [W]	
66901	12	24

EN Aroma diffuser
 PL Dyfuzor zapachu
 DE Aroma-Diffusor
 RU Диффузор запаха
 CZ Difuzér vůně
 RO Difuzor aromaterapie
 HU Illatdiffúzor
 ES Difusor de fragancias

FEATURES:
 - Work type: ultrasounds
 - Mist type: low, high

CECHY:
 - Rodzaj pracy: ultradźwięki
 - Rodzaje mgiełki: niska, wysoka

12 W

500 ml

40-60 ml/h

7 COLOURS KOLORY

50m²

1h 3h 6h



LUND

No.	Power / Moc [W]	
66902	12	12

EN Aroma diffuser
 PL Dyfuzor zapachu
 DE Aroma-Diffusor
 RU Диффузор запаха
 CZ Difuzér vůně
 RO Difuzor aromaterapie
 HU Illatdiffúzor
 ES Difusor de fragancias

FEATURES:
 - Work type: ultrasounds
 - Mist type: low, high

CECHY:
 - Rodzaj pracy: ultradźwięki
 - Rodzaje mgiełki: niska, wysoka

LUND

No.	Power / Moc [W]	
66903	12	12



12 W	100-240V~ 50/60Hz	500 ml	40-60 ml/h
7 COLOURS KOLORÓV	50m ²	1h 3h 6h	



EN Aroma diffuser
 PL Dyfuzor zapachu
 DE Aroma-Diffusor
 RU Диффузор запаха
 CZ Difuzér vůně
 RO Difuzor aromaterapie
 HU Illatdiffúzor
 ES Difusor de fragancias

FEATURES:
 - Work type: ultrasounds
 - Mist type: low, high

CECHY:
 - Rodzaj pracy: ultradźwięki
 - Rodzaje mgiełki: niska, wysoka

12 W	500 ml	40-60 ml/h	7 COLOURS KOLORÓV
50m ²	2h 4h		



LUND

No.	Power / Moc [W]	
66904	12	12

EN Air purifier
 PL Oczyszczacz powietrza
 DE Luftreiniger
 RU Очиститель воздуха
 CZ Čistička vzduchu
 RO Purificator aer
 HU Légtisztító
 ES Purificador de aire

FEATURES:
 - 4 stages of air purification: polypropylene pre filter, HEPA H10, carbon filter, ionizer
 - 3 levels of purification speed
 - Sleep mode
 - Smart mode
 - PM 2.5 detection
 - CADR 220 m³/h (Clean Air Delivery Rate for particulate matter PM 2.5)
 - Temperature detection and indicator
 - Odor sensor
 - Filter replace reminder

CECHY:
 - 4 etapy oczyszczania: filtr wstępny z polipropylenu, filtr HEPA H10, filtr węglowy, jonizator
 - 3 prędkości oczyszczania
 - Tryb uśpienia
 - Tryb automatyczny
 - Czujnik pyłu PM 2,5
 - CADR 220 m³/h (szybkość dostarczania czystego powietrza dla cząstek stałych PM 2,5)
 - Czujnik i wskaźnik temperatury
 - Czujnik zapachu
 - Funkcja przypominania o wymianie filtra

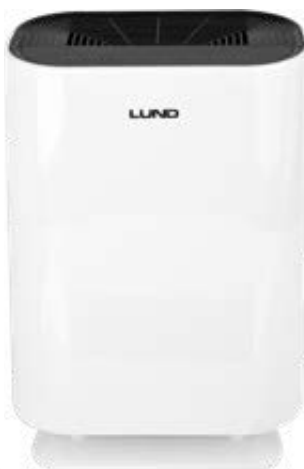

LUND

No.	Power / Moc [W]	
66930	40	1

EN Aroma diffuser
 PL Dyfuzor zapachu
 DE Aroma-Diffusor
 RU Диффузор запаха
 CZ Difuzér vůně
 RO Difuzor aromaterapie
 HU Illatdiffúzor
 ES Difusor de fragancias

FEATURES:
 - Work type: ultrasounds
 - Mist type: low, high

CECHY:
 - Rodzaj pracy: ultradźwięki
 - Rodzaje mgiełki: niska, wysoka

13 W	1000 ml	50-70 ml/h	7 COLOURS KOLORÓV
50m ²	3h 6h 9h		



LUND

No.	Power / Moc [W]	
66906	13	12

EN Air purifier filter
 PL Filtr do oczyszczacza powietrza
 DE Filter für Luftreiniger
 RU Фильтр для очистителя воздуха
 CZ Filtr do čističky vzduchu
 RO Filtru pt. purificator aer
 HU Légtisztító szűrő
 ES Filtro para purificador de aire

TYPE OF FILTERS:
 - Polypropylene pre-filter
 - HEPA H10
 - Carbon filter

TYPY FILTRÓV:
 - Filtr wstępny z polipropylenu
 - HEPA H10
 - Filtr węglowy

3 in 1 3 w 1	
-----------------	--



LUND

No.	For / Dla	
66931	66930	40



21

Household equipment
Gospodarstwo domowe



Mailboxes Skrzynki na listy	
.....	336-337
Coal stoves accessories Akcesoria do piecy węglowych	
.....	337-340
Brushes Szczotki	
.....	340-344
Multipurpose trays Podstawki gospodarcze	
.....	344
Bags Worki	
.....	344-345
Tarpaulins & accessories Plandeki i akcesoria	
.....	346-347
Vacuum cleaners, ash separators & accessories Odkurzacze, separatory popiołu i akcesoria	
.....	347-348
Syphon pumps Pompy syfonowe	
.....	348
Pumps Pompki	
.....	348

Vaselines Wazeliny techniczne	
.....	349
Hand trucks Wózki magazynowe	
.....	349-350
Floor conveyors Transport poziomy	
.....	350-351
Casters Kółka	
.....	351-353
Seals Uszczelnienia	
.....	353-354
Self-adhesive furniture pads Podkładki samoprzylepne pod meble	
.....	354-356
Hooks & furniture protection Haczyki i zabezpieczenia	
.....	357-359

EN Mailbox
 PL Skrzynka na listy
 DE Briefkasten
 RU Почтовый ящик
 CZ Schránka na dopisy
 RO Cutie poștală
 HU Levélláda
 ES Buzón

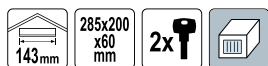

No.	Dimensions / Wymiary [mm]	Slot width / Szerokość wrzutu [mm]	Color / Kolor	
78540	285x200x60	143	czarny	12
78541	285x200x60	143	grafitowy	12
78542	285x200x60	143	brązowy	12
78543	285x200x60	143	zielony	12

EN Mailbox
 PL Skrzynka na listy
 DE Briefkasten
 RU Почтовый ящик
 CZ Schránka na dopisy
 RO Cutie poștală
 HU Levélláda
 ES Buzón

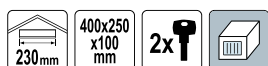

No.	Dimensions / Wymiary [mm]	Slot width / Szerokość wrzutu [mm]	Color / Kolor	
78570	400x250x100	230	czarny	6
78571	400x250x100	230	grafitowy	6
78572	400x250x100	230	brązowy	6

EN Mailbox
 PL Skrzynka na listy
 DE Briefkasten
 RU Почтовый ящик
 CZ Schránka na dopisy
 RO Cutie poștală
 HU Levélláda
 ES Buzón

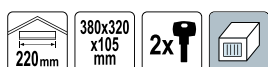

No.	Dimensions / Wymiary [mm]	Slot width / Szerokość wrzutu [mm]	Color / Kolor	
78580	380x320x105	220	czarny	5
78581	380x320x105	220	grafitowy	5
78582	380x320x105	220	brązowy	5

EN Mailbox
 PL Skrzynka na listy
 DE Briefkasten
 RU Почтовый ящик
 CZ Schránka na dopisy
 RO Cutie poștală
 HU Levélláda
 ES Buzón

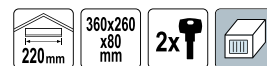

No.	Dimensions / Wymiary [mm]	Slot width / Szerokość wrzutu [mm]	Color / Kolor	
78555	360x260x80	220	czarny	6
78556	360x260x80	220	grafitowy	6
78557	360x260x80	220	brązowy	6

EN Mailbox
 PL Skrzynka na listy
 DE Briefkasten
 RU Почтовый ящик
 CZ Schránka na dopisy
 RO Cutie poștală
 HU Levélláda
 ES Buzón

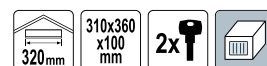

No.	Dimensions / Wymiary [mm]	Slot width / Szerokość wrzutu [mm]	Color / Kolor	
78575	310x360x100	320	czarny	6
78576	310x360x100	320	grafitowy	6
78577	310x360x100	320	brązowy	6

EN Mailbox
 PL Skrzynka na listy
 DE Briefkasten
 RU Почтовый ящик
 CZ Schránka na dopisy
 RO Cutie poștală
 HU Levélláda
 ES Buzón

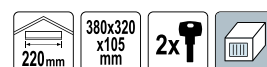

No.	Dimensions / Wymiary [mm]	Slot width / Szerokość wrzutu [mm]	Color / Kolor	
78585	380x320x105	220	czarny	5
78586	380x320x105	220	grafitowy	5
78587	380x320x105	220	brązowy	5

EN Mailbox
 PL Skrzynka na listy
 DE Briefkasten
 RU Почтовый ящик
 CZ Schránka na dopisy
 RO Cutie poștală
 HU Levélláda
 ES Buzón

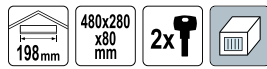

VOREL

No.	Dimensions / Wymiary [mm]	Slot width / Szerokość wrzutu [mm]	Color / Kolor	
78590	480x280x80	198	czarny	5
78591	480x280x80	198	grafitowy	5
78592	480x280x80	198	brązowy	5

EN Fireplace tool set
 PL Zestaw kominkowy
 DE Kaminset
 RU Каминный набор
 CZ Krbové nářadí
 RO Set unelte șemineu
 HU Kandalló tisztító készlet
 ES Herramientas de chimenea

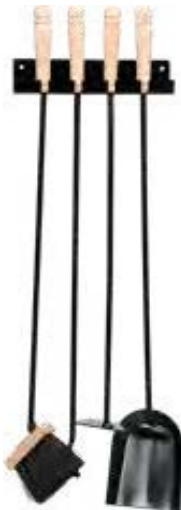

VOREL

No.	pcs / szt.	
72973	4	1

EN Stove metal plate
 PL Blacha przypiecowa
 DE Ofenplatte
 RU Напольный лист для печи
 CZ Podložka pod pec z plechu
 RO Tava protecție soba
 HU Hőterelő lemez kályhához
 ES Chapa para suelo estufas



VOREL

No.	Size / Rozmiar [mm]	Thickness / Grubość [mm]	
72936	500x600	0.5	10
72937	500x800	0.5	10

EN Fireplace tool set
 PL Zestaw kominkowy
 DE Kaminset
 RU Каминный набор
 CZ Krbové nářadí
 RO Set unelte șemineu
 HU Kandalló tisztító készlet
 ES Herramientas de chimenea



VOREL

No.	pcs / szt.	
72972	4	1

EN Stove metal plate
 PL Blacha przypiecowa
 DE Ofenplatte
 RU Напольный лист для печи
 CZ Podložka pod pec z plechu
 RO Tava protecție soba
 HU Hőterelő lemez kályhához
 ES Chapa para suelo estufas



VOREL

No.	Size / Rozmiar [mm]	Thickness / Grubość [mm]	
72933	300x500	0.5	10
72934	400x600	0.5	10
72935	500x650	0.5	10

EN Chimney brush
 PL Przetyskacz do wyczystki kominowej
 DE Kaminbürste
 RU Щетка для дымохода
 CZ Kominový kartáč
 RO Perie coș de fum
 HU Kéménykefe
 ES Brosse de cheminée

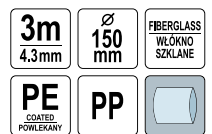

VOREL

No.	Brush diameter / Średnica wyciora [mm]	
72955	150	20

EN Chimney cleaner
 PL Wycior kominowy
 DE Schornsteinreiniger
 RU Щетка для трубочистов
 CZ Kartáč kominový
 RO Perie pt. coșul de fum
 HU Kéménytisztító kefe
 ES Arilla para baquetas de calefacción central



No.	Ø [mm]	
72948	120	15
72950	150	20
72951	175	18
72952	200	18

EN Chimney cleaner
 PL Wycior kominowy
 DE Schornsteinreiniger
 RU Щетка для трубочистов
 CZ Kartáč kominový
 RO Perie pt. coșul de fum
 HU Kéménytisztító kefe
 ES Arilla para baquetas de calefacción central



VOREL

No.	Ø [mm]	
72994	120	15
72995	150	20
72996	175	18
72997	200	18
72998	250	12

EN Chimneysweep ball
 PL Kula kominarska stalowa
 DE Zuggewicht aus Stahl
 RU Шар дымоходный для чистки дымоходов
 CZ Kominová koule
 RO Bilă curățare coș fum
 HU Acélgolyó kéménytisztításhoz
 ES Bola de chimenea de acero



VOREL

No.	m [kg]	
73025	1.3	5
73026	1.8	5
73027	2.5	5

EN Chimney cleaner
 PL Wycior kominowy
 DE Schornsteinreiniger
 RU Щетка для трубочистов
 CZ Kartáč kominový
 RO Perie pt. coșul de fum
 HU Kéménytisztító kefe
 ES Arilla para baquetas de calefacción central



VOREL

No.	Ø [mm]	
72953	250	12
72954	300	8

EN Chimney rope
 PL Lina kominarska
 DE Schornsteinfeger-Seil
 RU Трос для чистки дымоходов
 CZ Kominové lano
 RO Franghie pt. coș de fum
 HU Kémény kötél
 ES Cuerda de chimenea



VOREL

No.	Ø [mm]	L [m]	
73021	6	10	15
73022	8	10	15

EN Iron chimneysweep ball
 PL Kula kominarska żelazna
 DE Schornsteinfegerkugel
 RU Гиря для трубочистов
 CZ Kaminkrčcio kamuolys
 RO Bilă curățare coș fum
 HU Kéménytisztító golyó
 ES Esfera del dehornillador



No.	m [kg]	
72938	1.5	4
72939	2.5	4

EN Chimney brush with iron ball
 PL Zestaw kominiański
 DE Drahtbürste Schornsteinbesen mit Zuggewicht
 RU Набор для чистки дымохода

CZ Kominový set
 RO Set curățare coș fum
 HU Kéménytisztító szettek
 ES Redondo limpieza cepillo bola de acero



VOREL

No.	Brush diameter / Średnica wyciora [mm]	Ball weight / Masa kuli [kg]	Rope length / Długość liny [m]	
73031	125	1.3	10	1
73032	150	1.3	10	1
73033	175	1.8	10	1
73034	200	1.8	10	1
73035	250	2.5	10	1

EN Chimney wire
 PL Drut kominowy
 DE Schornsteindraht
 RU Проволока для трубочистов
 CZ Kamínkréčio trosas
 RO Sărmă pt. coșul de fum
 HU Kéménytisztító drót
 ES Alambre de chimeneas

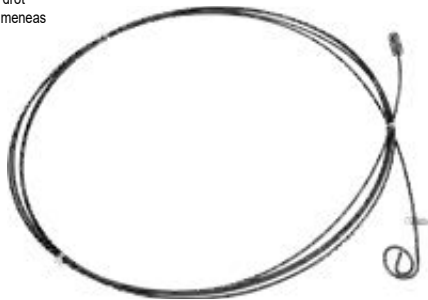

No.	Ø [mm]	L [m]	
72942	3.5	6	25
72943	3.5	8	20
72944	3.5	10	20
72945	3.5	12	20

EN Shovel
 PL Szufelka angielska
 DE Kehrschaufel
 RU Совок
 CZ Lopatka
 RO Făras pt. cenușă și cărbuni
 HU Lapát
 ES Recogedor

340
mm



VOREL

No.	W [mm]	L [mm]	
72974	340	200	18

EN Central heating cleaning rod
 PL Pręt do wyciorów
 DE Stab für die Reiniger der Zentralheizung
 RU Черенок для щеток – центральное отопление
 CZ Tyč k čištění
 RO Tijă pt. perie de curățat coș fum
 HU CO páca a füstcsőtisztító keféhez
 ES Baqueta para limpiar el sistema de calefacción central



No.	Ø [mm]	L [mm]	
72956	7	600	50
72958	7	800	50
72960	7	1000	50

EN Chimney cleaner
 PL Wycior do C.O.
 DE Schornsteinreiniger
 RU Щетка для трубочистов
 CZ Kartáč kominový
 RO Perie pt. coșul de fum
 HU Kéménytisztító kefe
 ES Arilla para baquetas de calefacción central



No.	Ø [mm]	
72963	30	50
72964	40	50
72965	50	50
72966	60	35
72967	70	35
72968	80	30
72969	90	20
72970	100	20

EN Shovel
 PL Szufelka
 DE Kehrschaufel
 RU Совок
 CZ Lopatka
 RO Lopată pt. cenușă și cărbuni
 HU Lapát
 ES Pala

220
mm



VOREL

No.	W [mm]	L [mm]	
72976	220	380	20

EN Poker
 PL Pogrzebacz
 DE Schürhaken
 RU Кочерга
 CZ Pohrabáč
 RO Vătrai
 HU Piszkavas
 ES Atizador

620 mm



No.	L [mm]	
72981	620	50

EN Shovel
 PL Szufelka
 DE Kehrschaufel
 RU Совок
 CZ Lopatka
 RO Lopată pt. cenușă și cărbuni
 HU Lapát
 ES Pala



No.	W [mm]	L [mm]	
72978	145	490	40
72977	180	550	30

EN Coal hod
 PL Węglarka
 DE Kohlenkasten
 RU Ведро для угля
 CZ Uhlák
 RO Cos carbuni
 HU Szenes kosár
 ES Cubo para carbón

385x210 x125 mm



No.	W [mm]	H [mm]	L [mm]	
72984	210	125	385	5

EN Coal hod
 PL Węglarka
 DE Kohlenkasten
 RU Ведро для угля
 CZ Uhlák
 RO Cos carbuni
 HU Szenes kosár
 ES Cubo para carbón

370x200 x175 mm



No.	W [mm]	H [mm]	L [mm]	
72985	200	175	370	5

EN Shovel
 PL Szufelka
 DE Kehrschaufel
 RU Совок
 CZ Lopatka
 RO Lopată pt. cenușă și cărbuni
 HU Lapát
 ES Pala

220 mm



No.	W [mm]	L [mm]	
72975	220	460	40

EN Shovel
 PL Szufelka
 DE Kehrschaufel
 RU Совок
 CZ Lopatka
 RO Lopată pt. cenușă și cărbuni
 HU Lapát
 ES Pala

110 mm



No.	W [mm]	L [mm]	
72979	110	500	5/30

EN Microfiber spray mop and window wiper
 PL Mop ze spryskiwaczem z myjką do okien
 DE Spritz Mop
 RU Спрей швабра
 CZ Stříkací mop
 RO Mop cu pulverizare
 HU Permetező mop
 ES Rociar fregona

350 ml

41x13 cm

x2

MICROFIBER



FEATURES:

- For every type of surface: wood, floor panel, tile, stone, PVC
- Multidirectional mop head

CECHY:

- Do każdego rodzaju powierzchni: drewna, paneli podłogowych, płytek, kamienia, PCV
- Wielokierunkowa stopa czyszcząca



No.	
67160	12

EN Double-sided microfiber spray mop
 PL Dwustronny mop ze spryskiwaczem
 DE Spritz Mop
 RU Спрей швабра
 CZ Stříkací mop
 RO Mop cu pulverizare
 HU Permetező mop
 ES Rocíar fregona

FEATURES:

- Wet & dry cleaning
- For every type of surface: wood, floor panel, tile, stone, PVC
- Multidirectional mop head

CECHY:

- Mycie na mokro i na sucho
- Do każdego rodzaju powierzchni: drewna, paneli podłogowych, płytek, kamienia, PCV
- Wielokierunkowa stopa czyszcząca

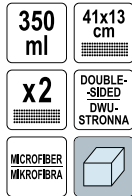

LUND

No.	12
67161	

EN Microfiber
 PL Mikrofibra
 DE Mikrofaser
 RU Микроволокно

CZ Mikrovlákno
 RO Microfibră
 HU Mikroszálás
 ES Microfibra



LUND

No.	Size / Rozmiar [mm]	For / Dla	100
67164	410x130	67161	

EN Microfiber
 PL Mikrofibra
 DE Mikrofaser
 RU Микроволокно
 CZ Mikrovlákno
 RO Microfibră
 HU Mikroszálás
 ES Microfibra



LUND

No.	Size / Rozmiar [mm]	For / Dla	500
67166	260x70	67162	

EN Microfiber spray mop and window wiper
 PL Mop ze spryskiwaczem z myjką do okien
 DE Spritz Mop
 RU Спрей швабра
 CZ Stříkací mop
 RO Mop cu pulverizare
 HU Permetező mop
 ES Rocíar fregona

FEATURES:

- For every type of surface: wood, floor panel, tile, stone, PVC
- Multidirectional mop head

CECHY:

- Do każdego rodzaju powierzchni: drewna, paneli podłogowych, płytek, kamienia, PCV
- Wielokierunkowa stopa czyszcząca

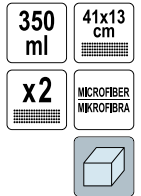

LUND

No.	12
67162	

EN Microfiber
 PL Mikrofibra
 DE Mikrofaser
 RU Микроволокно

CZ Mikrovlákno
 RO Microfibră
 HU Mikroszálás
 ES Microfibra



LUND

No.	Size / Rozmiar [mm]	For / Dla	125
67165	410x130	67160, 67162	

EN Floor sweeper
 PL Szczotka obrotowa
 DE Boden sweeper
 RU Турбо-щётка
 CZ Mechanický zametač
 RO Perie rotativă pt. perdoseli
 HU Forgó kefék
 ES Barredora de escoba

FEATURES:

- Great for pet hair
- Capacious basket
- For every type of surface: wood, floor panel, tile, stone, PVC

CECHY:

- Odpowiednia do sierści zwierząt
- Pojemny kosz
- Do każdego rodzaju powierzchni: drewna, paneli podłogowych, płytek, kamienia, PCV



LUND

No.	18
67163	

EN Broom
 PL Zamiatacz
 DE Feger
 RU Подметальная машина
 CZ Smeták
 RO Mătură
 HU Seprű fej
 ES Barredor

300 mm



No.	Working width / Szerokość robocza [mm]	
35930	300	10

EN Broom
 PL Zamiatacz z trzonkiem
 DE Feger
 RU Подметальная машина
 CZ Smeták
 RO Mătură
 HU Seprű fej
 ES Barredor

270 mm



No.	Working width / Szerokość robocza [mm]	
35932	270	18

EN Brush
 PL Zmiotka ręczna
 DE Handfeger
 RU Ручная щетка-веник
 CZ Smetáček
 RO Perie cu maner
 HU Kézi seprű
 ES Escoba manual

290 mm



No.	Working width / Szerokość robocza [mm]	
35940	290	25

EN Scrubbing brush
 PL Szczotka do szorowania
 DE Scheuerbürste
 RU Щетка для чистки
 CZ Rýžový kartáč
 RO Mătură
 HU Súrolókefe
 ES Cepillo para frotar

300 mm



No.	Working width / Szerokość robocza [mm]	
35964	300	10

EN Broom with handle
 PL Zamiatacz z trzonkiem
 DE Feger mit Stiel
 RU Подметальная машина с ручкой
 CZ Smeták s násadou
 RO Mătură cu coadă
 HU Seprű nyéllel
 ES Barredor con mango

300 mm

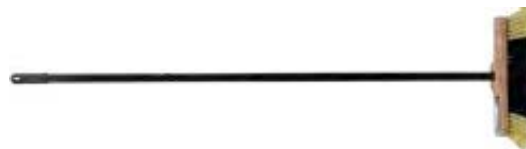

No.	Working width / Szerokość robocza [mm]	L [mm]	
35931	300	1180	12

EN Broom
 PL Zamiatacz z odbojnikiem
 DE Feger mit Puffer
 RU Подметальная машина с бампером
 CZ Smeták s chrániči
 RO Mătură cu protecție
 HU Seprű fej ütközővel
 ES Barredor con tope

290 mm



No.	Working width / Szerokość robocza [mm]	
35933	290	18

EN Scrubbing brush
 PL Szczotka do szorowania
 DE Scheuerbürste
 RU Щетка для чистки
 CZ Rýžový kartáč
 RO Mătură
 HU Súrolókefe
 ES Cepillo para frotar

300 mm



No.	Working width / Szerokość robocza [mm]	
35963	300	10

EN Scrubbing brush with a handle
 PL Szczotka z trzonkiem
 DE Bürste mit Stiel
 RU Щетка с черенком
 CZ Kartáč s násadou
 RO Mătură cu coadă
 HU Kéfe nyéllel
 ES Cepillo con mango

300 mm



No.	Working width / Szerokość robocza [mm]	L [mm]	
35968	300	1240	10

EN Hand scrub brush
 PL Szczotka ręczna
 DE Handbürste
 RU Ручная щетка
 CZ Ruční kartáč
 RO Perie de mana pt. curatat
 HU Kézi kefe
 ES Cepillo manual

200 mm



VOREL

No.	Working width / Szerokość robocza [mm]	
35970	200	10

EN Broom CZ Metla
 PL Miotła RO Mătură
 DE Besen HU Partvis
 RU Метла ES Escoba

250 mm



No.	
35869	10

EN Broom CZ Metla
 PL Miotła RO Mătură
 DE Besen HU Partvis
 RU Метла ES Escoba

NYLON



No.	Working width / Szerokość robocza [mm]	
35914	400	10
35915	500	10
35916	600	10
35918	800	10

EN Broom CZ Metla
 PL Miotła RO Mătură
 DE Besen HU Partvis
 RU Метла ES Escoba



No.	Working width / Szerokość robocza [mm]	
35867	300	10
35868	400	10

EN Broom
 PL Miotła
 DE Besen
 RU Метла
 CZ Metla
 RO Mătură
 HU Partvis
 ES Escoba



No.	Working width / Szerokość robocza [mm]	
35870	300	10
35872	400	10
35874	500	10
35875	600	10
35876	800	10
35877	1000	10

EN Wire broom for pavement
 PL Miotła druciana do bruku
 DE Stahldrahtbesen für Pflastersteine
 RU Проволочная метла для тротуара

CZ Drátěná metla do dlažby
 RO Matura pt. pavaje
 HU Drótspeprű járdákhoz
 ES Escoba de alambre para adoquines

STEEL WIRE DRUT STALOWY



VOREL

No.	Working width / Szerokość robocza [mm]	
35923	300	10
35924	400	10

EN Broom
PL Miotła
DE Besen
RU Метла
CZ Metla
RO Mătură
HU Partvis
ES Escoba



No.	Working width / Szerokość robocza [mm]	L [mm]	
35911	250	1150	200

EN Broom
PL Miotła
DE Besen
RU Метла
CZ Metla
RO Mătură
HU Partvis
ES Escoba



No.	Working width / Szerokość robocza [mm]	
35893	300	12
35894	400	12
35895	500	12

EN Broom
PL Miotła
DE Besen
RU Метла
CZ Metla
RO Mătură
HU Partvis
ES Escoba



No.	Working width / Szerokość robocza [mm]	
35899	250	12

EN Microfiber
PL Mikrofibra
DE Mikrofaser
RU Микроволокно
CZ Mikrovlákno
RO Microfibră
HU Mikroszálas
ES Microfibra



LUND

No.	Size / Rozmiar [mm]	For / Dla	
67171	250x70	67170	500

EN Waste bags
PL Worki na odpady
DE Müllsäcke
RU Пакеты для мусора
CZ Pytle na odpad
RO Saci de gunoi
HU Szemeteszsák
ES Bolsas para residuos



VOREL

No.	Capacity / Pojemność [l]	Thickness / Grubość [µm]	pcs / szt.	
09465	120	30	10	25
09466	160	40	10	15
09467	240	45	10	10

EN All purpose boot tray
PL Wielofunkcyjna podstawka gospodarcza
DE Garten- und Haushalt-Unterlage
RU Многофункциональный поднос

CZ Multifunkční podložka
RO Tava multifunctionala
HU Többfunkciós tálcá
ES Bandeja de arranque universal

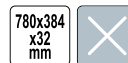

VOREL

No.	Dimensions / Wymiary [mm]	
67260	780x384x32	30

EN Waste bags
PL Worki na odpady
DE Müllsäcke
RU Пакеты для мусора
CZ Pytle na odpad
RO Saci de gunoi
HU Szemeteszsák
ES Bolsas para residuos

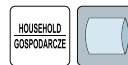

VOREL

No.	Capacity / Pojemność [l]	Thickness / Grubość [µm]	pcs / szt.	Material / Material	
09486	35	6	50	HDPE	40
09473	35	30	50	LDPE	10

EN Waste bags
 PL Worki na odpady
 DE Müllsäcke
 RU Пакеты для мусора
 CZ Pytle na odpad
 RO Saci de gunoi
 HU Szemeteszsák
 ES Bolsas para residuos



No.	Capacity / Pojemność [l]	Thickness / Grubość [µm]	pcs / szt.	
09487	35	11	30	45
09489	60	13	20	45

EN Waste bags
 PL Worki na odpady
 DE Müllsäcke
 RU Пакеты для мусора
 CZ Pytle na odpad
 RO Saci de gunoi
 HU Szemeteszsák
 ES Bolsas para residuos



No.	Capacity / Pojemność [l]	Thickness / Grubość [µm]	pcs / szt.	
09474	60	20	20	25

EN Waste bags
 PL Worki na odpady
 DE Müllsäcke
 RU Пакеты для мусора
 CZ Pytle na odpad
 RO Saci de gunoi
 HU Szemeteszsák
 ES Bolsas para residuos



No.	Capacity / Pojemność [l]	Thickness / Grubość [µm]	pcs / szt.	
10001	60	30	15	30
10011	120	40	10	25

EN Waste bags
 PL Worki na odpady
 DE Müllsäcke
 RU Пакеты для мусора
 CZ Pytle na odpad
 RO Saci de gunoi
 HU Szemeteszsák
 ES Bolsas para residuos



No.	Capacity / Pojemność [l]	Thickness / Grubość [µm]	pcs / szt.	
10003	60	30	15	30
10013	120	40	10	25

EN Waste bags
 PL Worki na odpady
 DE Müllsäcke
 RU Пакеты для мусора
 CZ Pytle na odpad
 RO Saci de gunoi
 HU Szemeteszsák
 ES Bolsas para residuos



No.	Capacity / Pojemność [l]	Thickness / Grubość [µm]	pcs / szt.	
09490	60	30	10	25

EN Waste bags
 PL Worki na odpady
 DE Müllsäcke
 RU Пакеты для мусора
 CZ Pytle na odpad
 RO Saci de gunoi
 HU Szemeteszsák
 ES Bolsas para residuos

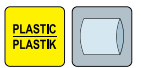

No.	Capacity / Pojemność [l]	Thickness / Grubość [µm]	pcs / szt.	
10000	60	30	15	30
10010	120	40	10	25

EN Waste bags
 PL Worki na odpady
 DE Müllsäcke
 RU Пакеты для мусора
 CZ Pytle na odpad
 RO Saci de gunoi
 HU Szemeteszsák
 ES Bolsas para residuos



No.	Capacity / Pojemność [l]	Thickness / Grubość [µm]	pcs / szt.	
10002	60	30	15	30
10012	120	40	10	25

EN Waste bags
 PL Worki na odpady
 DE Müllsäcke
 RU Пакеты для мусора

CZ Pytle na odpad
 RO Saci de gunoi
 HU Szemeteszsák
 ES Bolsas para residuos



No.	Capacity / Pojemność [l]	Thickness / Grubość [µm]	pcs / szt.	
10015	120	40	10	25

EN Tarpaulin CZ Plachta
 PL Plandeka RO Prelată
 DE Plane HU Ponyva
 RU Тент ES Toldo

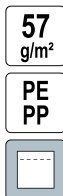

No.	Size / Rozmiar [m]	m [g/m ²]	
85122	2x3	57	30
85123	3x5	57	20
85124	4x5	57	10
85125	4x6	57	8
85126	5x8	57	5
85128	6x10	57	3
85129	8x12	57	2
85130	10x15	57	2

EN Tarpaulin CZ Plachta
 PL Plandeka RO Prelată
 DE Plane HU Ponyva
 RU Тент ES Toldo

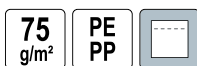

No.	Size / Rozmiar [m]	m [g/m ²]	
85112	2x3	75	30
85113	3x5	75	10
85114	4x5	75	10
85115	4x6	75	8
85116	5x8	75	5
85118	6x10	75	3
85119	8x12	75	2
85120	10x15	75	2

EN Tarpaulin clips
 PL Uchwyty zaciskowe ze śrubą do mocowania plandek
 DE Kunststoff Planenhalter
 RU Пластиковый клипс зажим для палаток и тентов
 CZ Držáky k zakrývacím plachtám
 RO Cleme pt. prelate
 HU Ponyvarógzító klipsz
 ES Pinzas para lonas

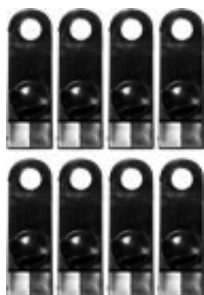

No.	pcs / szt.	
85170	8	12/48

EN Tarpaulin
 PL Plandeka
 DE Plane
 RU Тент
 CZ Plachta
 RO Prelată
 HU Ponyva
 ES Toldo



No.	Size / Rozmiar [m]	m [g/m ²]	
85131	2x3	57	30
85132	3x5	57	20
85133	4x5	57	10
85134	4x6	57	8
85135	5x8	57	5

EN Tarpaulin CZ Plachta
 PL Plandeka RO Prelată
 DE Plane HU Ponyva
 RU Тент ES Toldo



No.	Size / Rozmiar [m]	m [g/m ²]	
85020	2x3	90	30
85030	3x5	90	18
85040	4x5	90	9
85050	4x6	90	10
85060	5x8	90	5
85080	6x10	90	4
85090	8x12	90	2
85100	10x15	90	1

EN Tarpaulin clips
 PL Uchwyty zaciskowe do mocowania plandek
 DE Kunststoff Planenhalter
 RU Пластиковый клипс зажим для палаток и тентов
 CZ Držáky k zakrývacím plachtám
 RO Cleme pt. prelate
 HU Ponyvarógzító klipsz
 ES Pinzas para lonas

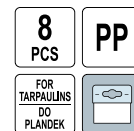

No.	pcs / szt.	
85172	8	72

EN Tarpaulin clips
 PL Uchwyty zaciskowe do mocowania plandek
 DE Kunststoff Planenhalter
 RU Пластиковый клипс зажим для палаток и тентов
 CZ Držáky k zakryvacím plachtám
 RO Cleme pt. prelate
 HU Ponyvárózigítő klipsz
 ES Pinzas para lonas

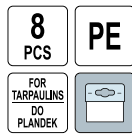

VOREL

No.	pcs / szt.	
85174	8	12/48

EN Ball bungee cords
 PL Guma mocująca z kulką
 DE Planenspanner Spanngummi mit Kunststoffkugel
 RU Резиновая петля с шариком
 CZ Upinací guma s plastovo kuličkou
 RO Cordelina elastica cu bila fixare
 HU Ponyva rögzítő gumipók
 ES Tensor de goma con bola de plástico



VOREL

No.	pcs / szt.	
85180	8	24/96

EN Tarpaulin repair tape
 PL Taśma klejąca do naprawy plandek
 DE Planen-Reparatur-Klebeband
 RU Самоклеящаяся лента тарпаулиновая для ремонта тентов

CZ Páska maskovací textilní pro plachtoviny
 RO Bandă adezivă de reparații pt. prelate
 HU Szövetszalag ezüst
 ES Cinta adhesiva de reparación para lonas



VOREL

No.	W [mm]	L [m]	
85190	50	8	72

VOREL

No.	W [mm]	L [m]	
85191	50	8	72

EN Ash separator
 PL Separator do popiołu
 DE Aschesabscheider
 RU Пелла сепаратор
 CZ Odlučovač popela
 RO Filtru pt. cenușă
 HU Hamuporszívó
 ES Separador de ceniza



No.		
72920		1

EN Ash cleaner
 PL Odkurzacz do popiołu
 DE Aschesauger
 RU Пылесос для золы
 CZ Vysavač popela
 RO Aspirator pt. cenușă
 HU Hamuporszívó
 ES Aspirador de cenizas



No.	Power / Moc [W]	
72928	800	1

EN Ash cleaner
 PL Odkurzacz do popiołu
 DE Aschesauger
 RU Пылесос для золы
 CZ Vysavač popela
 RO Aspirator pt. cenusa
 HU Hamuporszívó
 ES Aspirador de cenizas

220-240V~
50/60Hz

800
W

20L

16
kPa

FOR GRILL
AND FIREPLACE
DO GRILLA
I KAMINA

BLOW
FUNCTION
FUNKCJA
DMUCHAWY

FIREPROOF
HOSE
WAZ ZARO-
ODPORNY



No.	Power / Moc [W]	
78870	800	1

EN Metal hose
 PL Wąż metalowy
 DE Metallschlauch
 RU Металлический шланг
 CZ Kovová hadice
 RO Furtun metalic pt. aspirator cenușă
 HU Hajlékony, fém tömlő
 ES Manguera de metal

1m

∅ 38
mm

Al
23cm



VOREL

No.	For / Dla	
72932	72930	20

EN Syphon pump
 PL Pompa syfonowa
 DE Siphon-Pumpe
 RU Сифонный насос
 CZ Pumpa syfónová
 RO Pompa manuala pt. combustibil
 HU Szifon pumpa
 ES Bomba de sifón

10
l/min

∅25 mm
850 mm

∅22 mm
130 mm

5-50
°C



VOREL

No.		
78021		24

EN Vacuum cleaner filter
 PL Filtr do odkurzacza
 DE Staubsaugerfilter
 RU Фильтр для пылесоса
 CZ Filtr pro vysavače
 RO Filtru aspirator
 HU Porszívó szűrő
 ES Filtro para aspirador



VOREL

No.	For / Dla	
72931	78870	40

EN Metal hose
 PL Wąż metalowy
 DE Metallschlauch
 RU Металлический шланг
 CZ Kovová hadice
 RO Furtun metalic pt. aspirator cenușă
 HU Hajlékony, fém tömlő
 ES Manguera de metal



1m

∅ 38
mm

GALVANIZED
STEEL
STAL
OCYNKOWANA

VOREL

No.	For / Dla	
72922	72920	20

EN Syphon pump
 PL Pompa syfonowa
 DE Siphon-Pumpe
 RU Сифонный насос
 CZ Pumpa syfónová
 RO Pompa manuala pt. combustibil
 HU Szifon pumpa
 ES Bomba de sifón

6.2
l/min

∅14 mm
390 mm

∅12 mm
540 mm

5-50
°C



VOREL

No.		
78020		30/60

EN Multi-purpose pump
 PL Pompka wielofunkcyjna
 DE Multifunktionale Pumpe
 RU Многофункциональный насос
 CZ Univerzální pumpička
 RO Pompa multifuncțională
 HU Többfunkciós szivattyú
 ES Bomba multiusos

40
cm

3x120cm

WATER
OR
GASOLINE
WODA
LUB
BENZYNA

PP

PVC



VOREL

No.		
78022		6/24

EN Vaseline CZ Technická vazelína
 PL Wazelina techniczna RO Vaselină tehnică
 DE Vaseline HU Műszaki vazelin
 RU Вазелин технический ES Vaselina tecnica



No.	Capacity / Pojemność [ml]	
86700	50	50
86701	100	50

EN Folding hand truck
 PL Składany wózek magazynowy
 DE Klappbare Transportkarre
 RU Складная бытовая тележка
 CZ Skládací hliníkový rudi
 RO Cărucior transport pliabil
 HU Összecsukható kézikocsi
 ES Carretilla de mano plegable



No.	Max. load capacity / Maks. obciążenie [kg]	
78660	70	1

EN Folding hand truck
 PL Składany wózek magazynowy
 DE Klappbare Transportkarre
 RU Складная бытовая тележка
 CZ Skládací hliníkový rudi
 RO Cărucior transport pliabil
 HU Összecsukható kézikocsi
 ES Carretilla de mano plegable



No.	Max. load capacity / Maks. obciążenie [kg]	
78662	70	5

EN Folding hand truck
 PL Składany wózek magazynowy
 DE Klappbare Transportkarre
 RU Складная бытовая тележка
 CZ Skládací hliníkový rudi
 RO Cărucior transport pliabil
 HU Összecsukható kézikocsi
 ES Carretilla de mano plegable



No.	Max. load capacity / Maks. obciążenie [kg]	
78661	90	1

EN Folding hand truck
 PL Składany wózek magazynowy
 DE Klappbare Transportkarre
 RU Складная бытовая тележка
 CZ Skládací hliníkový rudi
 RO Cărucior transport pliabil
 HU Összecsukható kézikocsi
 ES Carretilla de mano plegable



No.	Max. load capacity / Maks. obciążenie [kg]	
78663	130	1

- EN Platform trolley
- PL Wózek platformowy
- DE Plattformwagen
- RU Тележка платформенная
- CZ Plošinový vozík
- RO Carucior platforma
- HU Platform kocs
- ES Carro de plataforma



No.	Max. load capacity / Maks. obciążenie [kg]	Box icon
78670	300	1

- EN Lifting and moving straps
- PL Pasy do przenoszenia mebli
- DE Gürtel zum Bewegen von Heben
- RU Ремни для переноски мебели
- CZ Pohyblivé pásy pro zvedání nábytku
- RO Curele pt. mutar obiecte
- HU Emelő mozgó pántok
- ES Cinturones para llevar muebles



No.	pcs / szt.	Box icon
74721	4	10/20

- EN Lifting and moving strap
- PL Pas do przenoszenia ładunku
- DE Gürtel zum Bewegen von Heben
- RU Такелажный ремень для переноски грузов
- CZ Pás pro ruční přenášení nákladu
- RO Curea pt. mutar obiecte
- HU Emelő mozgó pánt
- ES Cinturón para llevar carga

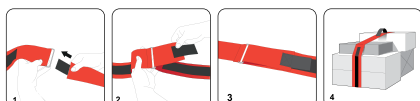

No.	Box icon
74723	32/128

- EN Hand truck
- PL Wózek magazynowy
- DE Transportkarre
- RU Бытовая тележка
- CZ Hliníkový rudi
- RO Carucior transport
- HU Molnárkocsi
- ES Carretilla de mano



No.	Max. load capacity / Maks. obciążenie [kg]	Box icon
78658	250	1

- EN Lifting and moving straps
- PL Pasy do przenoszenia mebli
- DE Gürtel zum Bewegen von Heben
- RU Ремни для переноски мебели
- CZ Pohyblivé pásy pro zvedání nábytku
- RO Curele pt. mutar obiecte
- HU Emelő mozgó pántok
- ES Cinturones para llevar muebles



No.	pcs / szt.	Box icon
74722	4	15/30

- EN Lifting and moving straps
- PL Pasy do przenoszenia mebli
- DE Gürtel zum Bewegen von Heben
- RU Ремни для переноски мебели
- CZ Pohyblivé pásy pro zvedání nábytku
- RO Curele pt. mutar obiecte
- HU Emelő mozgó pántok
- ES Cinturones para llevar muebles

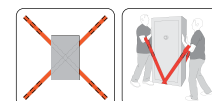

No.	pcs / szt.	Box icon
74724	2	33/66

EN Furniture transport roller set
 PL Zestaw rolek do transportu mebli
 DE Möbel transportroller set
 RU Набор для перемещения мебели
 CZ Sada na stěhování nábytku
 RO Set transport si ridicat mobila
 HU Bútorszállító készlet
 ES Muebles transporte conjunto



No.	pcs / szt.	Box icon
87245	5	12

EN Swivel caster
 PL Kółko skrętnie z czarną gumą
 DE Lenkrolle mit Feststeller
 RU Ролик с вращающийся опорой
 CZ Otočné kolečko
 RO Roată pivotantă pt. cărucior
 HU Szállítógörgők
 ES Rueda giratoria con freno



No.	Ø [mm]	W [mm]	H [mm]	Max. load capacity / Maks. obciążenie [kg]	Box icon
87311	75	23	97	40	48
87312	100	27	130	60	26
87313	125	34	155	100	20
87315	160	40	195	130	10
87317	200	46	235	150	6

EN Swivel caster
 PL Kółko skrętnie z czarną gumą
 DE Lenkrolle mit Feststeller
 RU Ролик с вращающийся опорой
 CZ Otočné kolečko
 RO Roată pivotantă pt. cărucior
 HU Szállítógörgők
 ES Rueda giratoria con freno



No.	Ø [mm]	W [mm]	H [mm]	Max. load capacity / Maks. obciążenie [kg]	Thread size / Rozmiar gwintu	Box icon
87331	75	22	97	40	M10	38
87332	100	26	130	60	M12	24
87333	125	33	153	100	M12	18
87335	160	39	190	130	M16	8
87337	200	44	230	150	M16	6

EN Fixed caster
 PL Kółko stałe
 DE Bockrolle
 RU Ролик с стационарной опорой
 CZ Pevné kolečko
 RO Roată fixă pt. cărucior
 HU Szállítógörgők
 ES Rueda fija



No.	Ø [mm]	W [mm]	H [mm]	Max. load capacity / Maks. obciążenie [kg]	Box icon
87301	75	23	97	40	60
87302	100	27	130	60	32
87303	125	34	155	100	22
87305	160	40	195	130	10
87307	200	46	235	150	8

EN Swivel caster
 PL Kółko skrętnie z czarną gumą
 DE Lenkrolle mit Feststeller
 RU Ролик с вращающийся опорой
 CZ Otočné kolečko
 RO Roată pivotantă pt. cărucior
 HU Szállítógörgők
 ES Rueda giratoria con freno

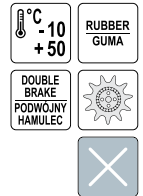

No.	Ø [mm]	W [mm]	H [mm]	Max. load capacity / Maks. obciążenie [kg]	Box icon
87321	75	23	97	40	40
87322	100	27	130	60	20
87323	125	34	155	100	16
87325	160	40	195	130	8
87327	200	46	235	150	6

EN Fixed caster
 PL Kółko stałe
 DE Bockrolle
 RU Ролик с стационарной опорой
 CZ Pevné kolečko
 RO Roată fixă pt. cărucior
 HU Szállítógörgők
 ES Rueda fija



No.	Ø [mm]	W [mm]	H [mm]	Max. load capacity / Maks. obciążenie [kg]	Box icon
87351	50	16	72	20	140
87352	75	21	104	30	60
87353	100	26	134	45	38
87354	125	27	161	50	25

EN Swivel caster
 PL Kółko skrętne z szarą gumą
 DE Lenkrolle mit Feststeller
 RU Ролик с вращающийся опорой
 CZ Otočné kolečko
 RO Roată pivotantă pt. cărucior
 HU Szállítógörgők
 ES Rueda giratoria con freno



°C -10 +50 RUBBER GUMA
 PLAIN BEARING ŁOŻYSKO ŚLIZGOWE



No.	Ø [mm]	W [mm]	H [mm]	Max. load capacity / Maks. obciążenie [kg]	
87361	50	16	72	20	100
87362	75	21	104	30	52
87363	100	26	134	45	28
87364	125	27	161	50	24

EN Swivel caster
 PL Kółko skrętne z szarą gumą
 DE Lenkrolle mit Feststeller
 RU Ролик с вращающийся опорой
 CZ Otočné kolečko
 RO Roată pivotantă pt. cărucior
 HU Szállítógörgők
 ES Rueda giratoria con freno



°C -10 +50 RUBBER GUMA
 BRAKE HAMULEC
 PLAIN BEARING ŁOŻYSKO ŚLIZGOWE



No.	Ø [mm]	W [mm]	H [mm]	Max. load capacity / Maks. obciążenie [kg]	
87381	50	16	72	20	96
87382	75	21	104	30	50
87383	100	26	134	45	26
87384	125	27	161	50	22

EN Swivel caster
 PL Kółko skrętne
 DE Lenkrolle mit Feststeller
 RU Ролик с вращающийся опорой
 CZ Otočné kolečko
 RO Roată pivotantă pt. cărucior
 HU Szállítógörgők
 ES Rueda giratoria con freno

°C -10 +50 RUBBER GUMA
 POM BEARING ŁOŻYSKO POM



No.	Ø [mm]	W [mm]	H [mm]	Max. load capacity / Maks. obciążenie [kg]	
87401	40	17	54	20	260
87402	50	22	65	25	120
87403	65	23	84	30	78

EN Swivel caster
 PL Kółko skrętne z szarą gumą
 DE Lenkrolle mit Feststeller
 RU Ролик с вращающийся опорой
 CZ Otočné kolečko
 RO Roată pivotantă pt. cărucior
 HU Szállítógörgők
 ES Rueda giratoria con freno



°C -10 +50 RUBBER GUMA
 BOLT HOLE OTWÓR MOCUJĄCY
 PLAIN BEARING ŁOŻYSKO ŚLIZGOWE



No.	Ø [mm]	W [mm]	H [mm]	Max. load capacity / Maks. obciążenie [kg]	
87371	50	16	70	20	120
87372	75	21	101	30	64
87373	100	26	132	45	34
87374	125	27	158	50	24

EN Fixed caster
 PL Kółko stałe
 DE Bockrolle
 RU Ролик с стационарной опорой
 CZ Pevné kolečko
 RO Roată fixă pt. cărucior
 HU Szállítógörgők
 ES Rueda fija



°C -10 +50 RUBBER GUMA
 POM BEARING ŁOŻYSKO POM



No.	Ø [mm]	W [mm]	H [mm]	Max. load capacity / Maks. obciążenie [kg]	
87391	40	17	54	20	280
87392	50	22	65	25	130
87393	65	23	84	30	90

EN Swivel caster
 PL Kółko skrętne
 DE Lenkrolle mit Feststeller
 RU Ролик с вращающийся опорой
 CZ Otočné kolečko
 RO Roată pivotantă pt. cărucior
 HU Szállítógörgők
 ES Rueda giratoria con freno

°C -10 +50 RUBBER GUMA
 BRAKE HAMULEC
 POM BEARING ŁOŻYSKO POM



No.	Ø [mm]	W [mm]	H [mm]	Max. load capacity / Maks. obciążenie [kg]	
87411	40	17	54	20	230
87412	50	22	65	25	110
87413	65	23	84	30	72

EN Swivel caster
 PL Kółko skrętnie
 DE Lenkrolle mit Feststeller
 RU Ролик с вращающийся опорой

CZ Otočné kolečko
 RO Roată pivotantă pt. cărucior
 HU Szállítógörgők
 ES Rueda giratoria con freno

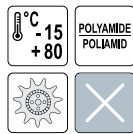

No.	Ø [mm]	W [mm]	H [mm]	Max. load capacity / Maks. obciążenie [kg]	
87431	75	23	97	40	60
87432	100	31	130	60	32
87433	125	33	155	100	26
87435	160	40	195	130	12
87437	200	40	235	150	8

EN Seal for windows and doors
 PL Uszczelka do okien i drzwi
 DE Dichtung für Fenster und Türen
 RU Уплотнители для окон и дверей
 CZ Těsnění oken a dveří
 RO Bandă etanșare pt. ferestre și uși
 HU Seal az ablakok és ajtók
 ES Sellar para ventanas y puertas

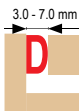

No.	Size / Rozmiar [mm]	L [m]	Type / Typ	Color / Kolor	
76752	9x7.4	6 (2x3)	D	biały	24
76762	9x7.4	6 (2x3)	D	brązowy	24

EN Seal for windows and doors
 PL Uszczelka do okien i drzwi
 DE Dichtung für Fenster und Türen
 RU Уплотнители для окон и дверей
 CZ Těsnění oken a dveří
 RO Bandă etanșare pt. ferestre și uși
 HU Seal az ablakok és ajtók
 ES Sellar para ventanas y puertas

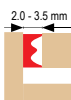

No.	Size / Rozmiar [mm]	L [m]	Type / Typ	Color / Kolor	
76750	9x4	6 (2x3)	E	biały	24
76760	9x4	6 (2x3)	E	brązowy	24

EN Wheel
 PL Kółko, czarna guma
 DE Transportrad
 RU Ролик

CZ Kolečko
 RO Roata de carucior
 HU Őnálló görgők
 ES Rueda



No.	Ø [mm]	W [mm]	Axle diameter / Srednica osi [mm]	Axle length / Długość osi [mm]	Max. load capacity / Maks. obciążenie [kg]	
87451	75	22	12	30	40	150
87452	100	26	12	40	60	66
87453	125	33	15	40	100	36
87454	150	39	20	55	110	22
87455	160	39	20	55	130	20
87456	200	44	20/25	55	150	12
87457	250	48	20/25	55	180	8

EN Seal for windows and doors
 PL Uszczelka do okien i drzwi
 DE Dichtung für Fenster und Türen
 RU Уплотнители для окон и дверей
 CZ Těsnění oken a dveří
 RO Bandă etanșare pt. ferestre și uși
 HU Seal az ablakok és ajtók
 ES Sellar para ventanas y puertas

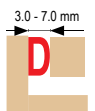

No.	Size / Rozmiar [mm]	L [m]	Type / Typ	Color / Kolor	
76757	9x7.4	100 (2x50)	D	biały	6
76767	9x7.4	100 (2x50)	D	brązowy	6

EN Seal for windows and doors
 PL Uszczelka do okien i drzwi
 DE Dichtung für Fenster und Türen
 RU Уплотнители для окон и дверей
 CZ Těsnění oken a dveří
 RO Bandă etanșare pt. ferestre și uși
 HU Seal az ablakok és ajtók
 ES Sellar para ventanas y puertas

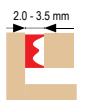

No.	Size / Rozmiar [mm]	L [m]	Type / Typ	Color / Kolor	
76755	9x4	150 (2x75)	E	biały	6
76765	9x4	150 (2x75)	E	brązowy	6

EN Seal for windows and doors
 PL Uszczelka do okien i drzwi
 DE Dichtung für Fenster und Türen
 RU Уплотнители для окон и дверей
 CZ Těsnění oken a dveří
 RO Bandă etanșare pt. ferestre și uși
 HU Seal az ablakok és ajtók
 ES Sellar para ventanas y puertas

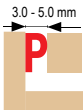

No.	Size / Rozmiar [mm]	L [m]	Type / Typ	Color / Kolor	
76751	9x5.5	6 (2x3)	P	biały	24
76761	9x5.5	6 (2x3)	P	brązowy	24

EN Self-adhesive pad for furniture
 PL Podkładka samoprzylepna, korkowa
 DE Klebgleiter für Möbel
 RU Самоклеящая подкладка под мебель

CZ Podložka samolepící pod nábytek
 RO Protecție pardoseală
 HU Őntapadó, bútortáblátét
 ES Arandela adhesiva bajo los muebles



No.	Ø [mm]	pcs / szt.	
74802	20	20	60/720
74804	28	12	60/720

EN Self-adhesive pad for furniture
 PL Podkładka samoprzylepna, antypoślizgowa
 DE Klebgleiter für Möbel
 RU Самоклеящая подкладка под мебель
 CZ Podložka samolepící pod nábytek
 RO Protecție pardoseală
 HU Őntapadó, bútortáblátét
 ES Arandela adhesiva bajo los muebles



No.	Ø [mm]	pcs / szt.	
74816	10	24	60/720
74818	20	20	60/720
74820	28	12	60/720

EN Self-adhesive pad for furniture
 PL Podkładka samoprzylepna z włókniny
 DE Klebgleiter für Möbel
 RU Самоклеящая подкладка под мебель

CZ Podložka samolepící pod nábytek
 RO Protecție pardoseală
 HU Őntapadó, bútortáblátét
 ES Arandela adhesiva bajo los muebles



EN Seal for windows and doors
 PL Uszczelka do okien i drzwi
 DE Dichtung für Fenster und Türen
 RU Уплотнители для окон и дверей
 CZ Těsnění oken a dveří
 RO Bandă etanșare pt. ferestre și uși
 HU Seal az ablakok és ajtók
 ES Sellar para ventanas y puertas

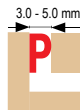

No.	Size / Rozmiar [mm]	L [m]	Type / Typ	Color / Kolor	
76756	9x5.5	100 (2x50)	P	biały	6
76766	9x5.5	100 (2x50)	P	brązowy	6

EN Self-adhesive pad for furniture
 PL Podkładka samoprzylepna, korkowa
 DE Klebgleiter für Möbel
 RU Самоклеящая подкладка под мебель

CZ Podložka samolepící pod nábytek
 RO Protecție pardoseală
 HU Őntapadó, bútortáblátét
 ES Arandela adhesiva bajo los muebles



No.	Size / Rozmiar [mm]	pcs / szt.	
74812	100x120	1	60/720

EN Self-adhesive pad for furniture
 PL Podkładka samoprzylepna, antypoślizgowa
 DE Klebgleiter für Möbel
 RU Самоклеящая подкладка под мебель
 CZ Podložka samolepící pod nábytek
 RO Protecție pardoseală
 HU Őntapadó, bútortáblátét
 ES Arandela adhesiva bajo los muebles



No.	Size / Rozmiar [mm]	pcs / szt.	
74828	100x120	1	60/720



EN Self-adhesive pad for furniture
 PL Podkładka samoprzylepna z włókniny mix
 DE Klebegleiter für Möbel
 RU Самоклеящая подкладка под мебель
 CZ Podložka samolepící pod nábytek
 RO Protecție pardoseală
 HU Őntapadó, bútorláb alátét
 ES Arandela adhesiva bajo los muebles



VOREL

No.	Ø [mm]	pcs / szt.	
74838	20, 38	12	60/720

EN Self-adhesive pad for furniture
 PL Podkładka samoprzylepna z włókniny
 DE Klebegleiter für Möbel
 RU Самоклеящая подкладка под мебель
 CZ Podložka samolepící pod nábytek
 RO Protecție pardoseală
 HU Őntapadó, bútorláb alátét
 ES Arandela adhesiva bajo los muebles



VOREL

No.	Size / Rozmiar [mm]	pcs / szt.	
74846	20x45	10	60/720

EN Self-adhesive pad for furniture
 PL Podkładka samoprzylepna z włókniny
 DE Klebegleiter für Möbel
 RU Самоклеящая подкладка под мебель
 CZ Podložka samolepící pod nábytek
 RO Protecție pardoseală
 HU Őntapadó, bútorláb alátét
 ES Arandela adhesiva bajo los muebles



VOREL

No.	Ø [mm]	pcs / szt.	
74858	20, 38	12	60/720

EN Self-adhesive pad for furniture
 PL Podkładka samoprzylepna z włókniny
 DE Klebegleiter für Möbel
 RU Самоклеящая подкладка под мебель
 CZ Podložka samolepící pod nábytek
 RO Protecție pardoseală
 HU Őntapadó, bútorláb alátét
 ES Arandela adhesiva bajo los muebles

VOREL

No.	Ø [mm]	pcs / szt.	
74851	20	20	60/720
74853	28	12	60/720
74855	40	4	60/720
74856	50	2	60/720

EN Self-adhesive pad for furniture
 PL Podkładka samoprzylepna z włókniny
 DE Klebegleiter für Möbel
 RU Самоклеящая подкладка под мебель
 CZ Podložka samolepící pod nábytek
 RO Protecție pardoseală
 HU Őntapadó, bútorláb alátét
 ES Arandela adhesiva bajo los muebles



VOREL

No.	Size / Rozmiar [mm]	pcs / szt.	
74841	20x20	20	60/720
74843	28x28	12	60/720

EN Self-adhesive pad for furniture
 PL Podkładka samoprzylepna z włókniny
 DE Klebegleiter für Möbel
 RU Самоклеящая подкладка под мебель
 CZ Podložka samolepící pod nábytek
 RO Protecție pardoseală
 HU Őntapadó, bútorláb alátét
 ES Arandela adhesiva bajo los muebles



VOREL

No.	Size / Rozmiar [mm]	pcs / szt.	
74849	100x120	1	60/720

EN Self-adhesive pad for furniture
 PL Podkładka samoprzylepna z włókniny
 DE Klebegleiter für Möbel
 RU Самоклеящая подкладка под мебель
 CZ Podložka samolepící pod nábytek
 RO Protecție pardoseală
 HU Őntapadó, bútorláb alátét
 ES Arandela adhesiva bajo los muebles



VOREL

No.	Size / Rozmiar [mm]	pcs / szt.	
74861	20x20	20	60/720
74863	28x28	12	60/720



EN Self-adhesive pad for furniture
 PL Podkładka samoprzylepna z włókna
 DE Klebgleiter für Möbel
 RU Самоклеящая подкладка под мебель
 CZ Podložka samolepící pod nábytek
 RO Protecție pardoseală
 HU Őntapadó, bútortábl alátét
 ES Arandela adhesiva bajo los muebles



No.	Size / Rozmiar [mm]	pcs / szt.	
74866	20x45	10	60/720

EN Self-adhesive pad for furniture
 PL Podkładka samoprzylepna, antypoślizgowa
 DE Klebgleiter für Möbel
 RU Самоклеящая подкладка под мебель
 CZ Podložka samolepící pod nábytek
 RO Protecție pardoseală
 HU Őntapadó, bútortábl alátét
 ES Arandela adhesiva bajo los muebles



No.	Ø [mm]	pcs / szt.	
74882	25	18	24/432

EN Self-adhesive silicone pad for furniture
 PL Podkładka samoprzylepna, silikonowa
 DE Klebgleiter für Möbel
 RU Самоклеящая подкладка под мебель
 CZ Podložka samolepící pod nábytek
 RO Bumbi de silicon pt. mobilier
 HU Őntapadó, bútortábl alátét
 ES Arandela adhesiva bajo los muebles



No.	Ø [mm]	pcs / szt.	
74910	8	25	32/576
74911	10	20	32/576
74912	13	12	32/576
74913	15	9	32/576
74914	19	6	32/576

EN Self-adhesive pad for furniture
 PL Podkładka samoprzylepna z włókna
 DE Klebgleiter für Möbel
 RU Самоклеящая подкладка под мебель
 CZ Podložka samolepící pod nábytek
 RO Protecție pardoseală
 HU Őntapadó, bútortábl alátét
 ES Arandela adhesiva bajo los muebles



No.	Size / Rozmiar [mm]	pcs / szt.	
74869	100x120	1	60/720

EN Self-adhesive pad for furniture
 PL Podkładka samoprzylepna, antypoślizgowa
 DE Klebgleiter für Möbel
 RU Самоклеящая подкладка под мебель
 CZ Podložka samolepící pod nábytek
 RO Protecție pardoseală
 HU Őntapadó, bútortábl alátét
 ES Arandela adhesiva bajo los muebles



No.	Ø [mm]	pcs / szt.	
74885	18	32	24/432
74886	25	18	24/432
74887	38	8	24/432

EN Felt & plastic furniture glides
 PL Podkładki plastikowo-filcowe na gwóźdź
 DE Kunststoff- und Filzgleiter zum Nageln
 RU Подкладки пластиковые фильцевые на гвоздь
 CZ Plastové podložky s píslí na hřebík
 RO Protecție pardoseală pt. mobila
 HU Műanyag-filc alátét szőghöz
 ES Arandelas de plástico y fieltro con clave



No.	Ø [mm]	pcs / szt.	
74920	17	16	16/288
74921	20	12	16/288
74922	24	12	16/288
74923	28	8	16/256
74924	30	8	16/256

EN Self-adhesive hanging hooks
 PL Haczyki naścienne samoprzylepne
 DE Selbstklebende Wandhaken
 RU Крючки настенные на липучках
 CZ Háčky nástěnné samolepící
 RO Cârlițe adezive de perete
 HU Műanyag, fali kampó, öntapadós
 ES Ganchos adhesivos para pared



VOREL

No.	Max. load capacity / Maks. obciążenie [kg]	pcs / szt.	
74730	1	3	12/144

EN Self-adhesive hanging hooks
 PL Haczyki naścienne samoprzylepne
 DE Selbstklebende Wandhaken
 RU Крючки настенные на липучках
 CZ Háčky nástěnné samolepící
 RO Cârlițe adezive de perete
 HU Műanyag, fali kampó, öntapadós
 ES Ganchos adhesivos para pared



VOREL

No.	Max. load capacity / Maks. obciążenie [kg]	pcs / szt.	
74731	0.8	3	18/216

EN Self-adhesive hanging hooks
 PL Haczyki naścienne samoprzylepne
 DE Selbstklebende Wandhaken
 RU Крючки настенные на липучках
 CZ Háčky nástěnné samolepící
 RO Cârlițe adezive de perete
 HU Műanyag, fali kampó, öntapadós
 ES Ganchos adhesivos para pared



VOREL

No.	Max. load capacity / Maks. obciążenie [kg]	pcs / szt.	
74734	0.4	6	12/192

EN Self-adhesive hanging hooks
 PL Haczyki naścienne samoprzylepne
 DE Selbstklebende Wandhaken
 RU Крючки настенные на липучках
 CZ Háčky nástěnné samolepící
 RO Cârlițe adezive de perete
 HU Műanyag, fali kampó, öntapadós
 ES Ganchos adhesivos para pared

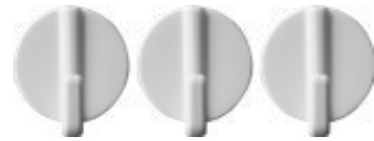

VOREL

No.	Max. load capacity / Maks. obciążenie [kg]	pcs / szt.	
74732	1	3	12/192

EN Self-adhesive hanging hooks
 PL Haczyki naścienne samoprzylepne
 DE Selbstklebende Wandhaken
 RU Крючки настенные на липучках
 CZ Háčky nástěnné samolepící
 RO Cârlițe adezive de perete
 HU Műanyag, fali kampó, öntapadós
 ES Ganchos adhesivos para pared



VOREL

No.	Max. load capacity / Maks. obciążenie [kg]	pcs / szt.	
74733	0.8	4	12/192

EN Self-adhesive hanging hooks
 PL Haczyki naścienne samoprzylepne
 DE Selbstklebende Wandhaken
 RU Крючки настенные на липучках
 CZ Háčky nástěnné samolepící
 RO Cârlițe adezive de perete
 HU Műanyag, fali kampó, öntapadós
 ES Ganchos adhesivos para pared



VOREL

No.	Max. load capacity / Maks. obciążenie [kg]	pcs / szt.	
74750	1	2	12/192

EN Self-adhesive hanging hooks
 PL Haczyki naścienne samoprzylepne
 DE Selbstklebende Wandhaken
 RU Крючки настенные на липучках
 CZ Háčky nástěnné samolepící
 RO Cârîlige adezive de perete
 HU Mûanyag, fali kampó, öntapadós
 ES Ganchos adhesivos para pared

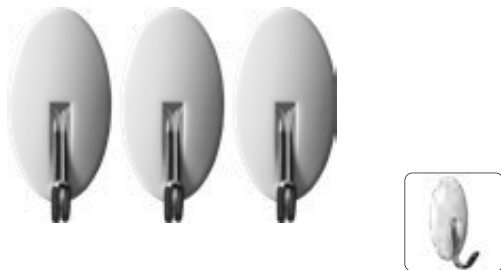

No.	Max. load capacity / Maks. obciążenie [kg]	pcs / szt.	
74751	0.8	3	16/192

EN Self-adhesive hanging hooks
 PL Haczyki naścienne samoprzylepne
 DE Selbstklebende Wandhaken
 RU Крючки настенные на липучках
 CZ Háčky nástěnné samolepící
 RO Cârîlige adezive de perete
 HU Mûanyag, fali kampó, öntapadós
 ES Ganchos adhesivos para pared



No.	Max. load capacity / Maks. obciążenie [kg]	pcs / szt.	
74753	0.4	5	16/288

EN Wall hooks with screws
 PL Haczyki naścienne na wkręt
 DE Wandhaken zum Anschrauben
 RU Крючки настенные на шурупах
 CZ Háčky nástěnné na šroub
 RO Cârîlige perete cu şurub
 HU Mûanyag, fali kampó, csavaros
 ES Ganchos atornillados para pared



No.	Max. load capacity / Maks. obciążenie [kg]	pcs / szt.	
74766	8	3	12/192

EN Corner cushions
 PL Ochraniacze na narożniki meblowe
 DE Eckenschoner für Möbel
 RU Насадки на углы мебели
 CZ Chrániče na rohy nábytku
 RO Protecție colțuri mobilă
 HU Bûtor sarokvédô
 ES Protectores esquineros para muebles



No.	pcs / szt.	
74772	4	16/288

EN Self-adhesive hanging hooks
 PL Haczyki naścienne samoprzylepne
 DE Selbstklebende Wandhaken
 RU Крючки настенные на липучках
 CZ Háčky nástěnné samolepící
 RO Cârîlige adezive de perete
 HU Mûanyag, fali kampó, öntapadós
 ES Ganchos adhesivos para pared

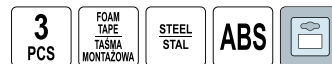

No.	Max. load capacity / Maks. obciążenie [kg]	pcs / szt.	
74752	1.2	3	18/216

EN Wall hooks with screws
 PL Haczyki naścienne na wkręt
 DE Wandhaken zum Anschrauben
 RU Крючки настенные на шурупах
 CZ Háčky nástěnné na šroub
 RO Cârîlige perete cu şurub
 HU Mûanyag, fali kampó, csavaros
 ES Ganchos atornillados para pared



No.	Max. load capacity / Maks. obciążenie [kg]	pcs / szt.	
74755	5	3	16/256

EN Corner cushions
 PL Ochraniacze na narożniki meblowe
 DE Eckenschoner für Möbel
 RU Насадки на углы мебели
 CZ Chrániče na rohy nábytku
 RO Protecție colțuri mobilă
 HU Bûtor sarokvédô
 ES Protectores esquineros para muebles



No.	pcs / szt.	
74771	4	16/288

EN Corner cushions
 PL Ochraniacze na narożniki meblowe
 DE Eckenschoner für Möbel
 RU Насадки на углы мебели
 CZ Chrániče na rohy nábytku
 RO Protecție colțuri mobilă
 HU Bûtor sarokvédô
 ES Protectores esquineros para muebles

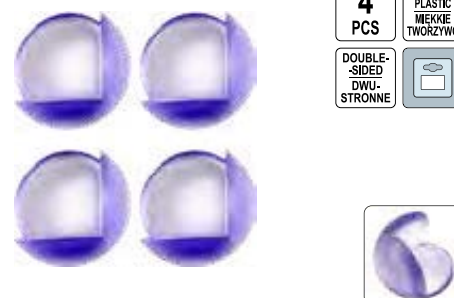

No.	pcs / szt.	
74772	4	16/288

EN Corner cushions
 PL Ochraniacze na narożniki meblowe
 DE Eckenschoner für Möbel
 RU Насадки на углы мебели
 CZ Chrániče na rohy nábytku
 RO Protecție colțuri mobilă
 HU Bútor sarokvédő
 ES Protectores esquineros para muebles

4 PCS SOFT PLASTIC MIEKKE TWORZYWO DOUBLE-SIDED DWU-STRONNE



No.	pcs / szt.	
74773	4	12/144

EN Multi-purpose latches
 PL Zabezpieczenie otwarcia drzwi meblowych
 DE Schutzsicherung gegen das Öffnen der Möbelltüren
 RU Блокатор открывания дверей мебели
 CZ Pojistka proti otevření nábytkových dveří
 RO Protecție deschidere ușii mobilă
 HU Bútorajtó-útköző
 ES Protectores para las portezuelas de muebles para prevenir su apertura

2 PCS SOFT PLASTIC MIEKKE TWORZYWO FOAM TAPE TĄSMA MONTAŻOWA ABS



No.	pcs / szt.	
74775	2	16/256

EN Multi-purpose latches
 PL Zabezpieczenie otwarcia drzwi meblowych
 DE Schutzsicherung gegen das Öffnen der Möbelltüren
 RU Блокатор открывания дверей мебели
 CZ Pojistka proti otevření nábytkových dveří
 RO Protecție deschidere ușii mobilă
 HU Bútorajtó-útköző
 ES Protectores para las portezuelas de muebles para prevenir su apertura

2 PCS SOFT PLASTIC MIEKKE TWORZYWO FOAM TAPE TĄSMA MONTAŻOWA ABS



No.	pcs / szt.	
74776	2	12/216

<p>Memo</p>	
-------------	--

22

Health & safety products
Artykuły BHP





Gloves Rękawice	
.....362-365	

Goggles & shields Okulary i osłony przeciwodpryskowe	
.....365-366	

Dust masks Maski przeciwpyłowe	
.....366-367	

Face shields Osłony twarzy	
.....367	

Knee pads Nakolanniki	
.....367-368	

Hearing protectors Nauszniki przeciwhałasowe	
.....369	

Safety helmets Kaski ochronne	
.....369	

Rain boots Kalosze	
.....369-370	

Shoes accessories Akcesoria do obuwia	
.....370	

Working clothes Odzież robocza	
.....370-372	

Hats Czapki.....	370
----------------------------	-----

Safety vests Kamizelki ostrzegawcze.....	371
--	-----

Waterproof jackets Kurtki przeciwdeszczowe.....	371
---	-----

EN Working gloves
 PL Rękawice robocze
 DE Arbeitshandschuhe
 RU Рабочие перчатки
 CZ Pracovní rukavice
 RO Mănuși de lucru
 HU Munkakesztyű
 ES Guantes de trabajo



8
SIZE / ROZMIAR

POLYESTER
 POLYESTER

COTTON
 BAWELNA

PVC

✕

No.	Size / Rozmiar	
74094	8	240

EN Working gloves
 PL Rękawice robocze
 DE Arbeitshandschuhe
 RU Рабочие перчатки
 CZ Pracovní rukavice
 RO Mănuși de lucru
 HU Munkakesztyű
 ES Guantes de trabajo



8
SIZE / ROZMIAR

COTTON
 BAWELNA

PVC

✕

No.	Size / Rozmiar	
74102	8	10/240

EN Working gloves
 PL Rękawice robocze
 DE Arbeitshandschuhe
 RU Рабочие перчатки
 CZ Pracovní rukavice
 RO Mănuși de lucru
 HU Munkakesztyű
 ES Guantes de trabajo



10
SIZE / ROZMIAR

POLYESTER
 POLYESTER

COTTON
 BAWELNA

PVC

✕

No.	Size / Rozmiar	
74108	10	240

EN Working gloves
 PL Rękawice robocze
 DE Arbeitshandschuhe
 RU Рабочие перчатки
 CZ Pracovní rukavice
 RO Mănuși de lucru
 HU Munkakesztyű
 ES Guantes de trabajo



No.	Size / Rozmiar	
74126	8	12/300
74132	9	12/300

EN Working gloves
 PL Rękawice robocze
 DE Arbeitshandschuhe
 RU Рабочие перчатки
 CZ Pracovní rukavice
 RO Mănuși de lucru
 HU Munkakesztyű
 ES Guantes de trabajo



10
SIZE / ROZMIAR

COTTON
 BAWELNA

PVC

☞



No.	Size / Rozmiar	
74100	10	12/300

EN Working gloves
 PL Rękawice robocze
 DE Arbeitshandschuhe
 RU Рабочие перчатки
 CZ Pracovní rukavice
 RO Mănuși de lucru
 HU Munkakesztyű
 ES Guantes de trabajo



10
SIZE / ROZMIAR

POLYESTER
 POLYESTER

COTTON
 BAWELNA

PVC

✕

No.	Size / Rozmiar	
74104	10	10/240

EN Working gloves
 PL Rękawice robocze
 DE Arbeitshandschuhe
 RU Рабочие перчатки
 CZ Pracovní rukavice
 RO Mănuși de lucru
 HU Munkakesztyű
 ES Guantes de trabajo



POLYESTER
 POLYESTER

PU

☞



No.	Size / Rozmiar	
74125	8	12/300
74130	9	12/300
74131	10	12/300

EN Working gloves
 PL Rękawice robocze
 DE Arbeitshandschuhe
 RU Рабочие перчатки
 CZ Pracovní rukavice
 RO Mănuși de lucru
 HU Munkakesztyű
 ES Guantes de trabajo



No.	Size / Rozmiar	
74127	8	12/300
74134	9	12/300
74135	10	12/300



POLYESTER
POLYESTER

PU



EN Working gloves
 PL Rękawice robocze
 DE Arbeitshandschuhe
 RU Рабочие перчатки
 CZ Pracovní rukavice
 RO Mănuși de lucru
 HU Munkakesztyű
 ES Guantes de trabajo



POLYESTER
POLYESTER

PU



EN Gardening gloves
 PL Rękawice ogrodnicze
 DE Gartenhandschuhe
 RU Перчатки садовые
 CZ Zahradní rukavice
 RO Mănuși pt. grădinărit
 HU Kerti kesztyű
 ES Guantes de jardinería



8
SIZE / ROZMIAR

POLYESTER
POLYESTER



No.	Size / Rozmiar	
74128	8	12/300
74136	9	12/300
74137	10	12/300

EN Gardening gloves
 PL Rękawice ogrodnicze
 DE Gartenhandschuhe
 RU Перчатки садовые
 CZ Zahradní rukavice
 RO Mănuși pt. grădinărit
 HU Kerti kesztyű
 ES Guantes de jardinería



8
SIZE / ROZMIAR

POLYESTER
POLYESTER



No.	Size / Rozmiar	
74117	8	50/1000

EN Gardening gloves
 PL Rękawice ogrodnicze
 DE Gartenhandschuhe
 RU Перчатки садовые
 CZ Zahradní rukavice
 RO Mănuși pt. grădinărit
 HU Kerti kesztyű
 ES Guantes de jardinería



8
SIZE / ROZMIAR

POLYESTER
POLYESTER



No.	Size / Rozmiar	
74121	8	50/1000

EN Gardening gloves
 PL Rękawice ogrodnicze
 DE Gartenhandschuhe
 RU Перчатки садовые
 CZ Zahradní rukavice
 RO Mănuși pt. grădinărit
 HU Kerti kesztyű
 ES Guantes de jardinería



8
SIZE / ROZMIAR

POLYESTER
POLYESTER



No.	Size / Rozmiar	
74123	8	50/1000

EN Gardening gloves
 PL Rękawice ogrodnicze
 DE Gartenhandschuhe
 RU Перчатки садовые
 CZ Zahradní rukavice
 RO Mănuși pt. grădinărit
 HU Kerti kesztyű
 ES Guantes de jardinería



8
SIZE / ROZMIAR

POLYESTER
POLYESTER



No.	Size / Rozmiar	
74113	8	50/1000



No.	Size / Rozmiar	
74115	8	50/1000

EN Working gloves
 PL Rękawice robocze
 DE Arbeitshandschuhe
 RU Рабочие перчатки
 CZ Pracovní rukavice
 RO Mănuși de lucru
 HU Munkakesztyű
 ES Guantes de trabajo

10 SIZE / ROZMIAR COTTON BAWELNA PVC



No.	Size / Rozmiar	
74150	10	12/120

EN Working gloves
 PL Rękawice robocze
 DE Arbeitshandschuhe
 RU Рабочие перчатки
 CZ Pracovní rukavice
 RO Mănuși de lucru
 HU Munkakesztyű
 ES Guantes de trabajo



9 SIZE / ROZMIAR COTTON BAWELNA RUBBER GUMA

No.	Size / Rozmiar	
74162	9	600

EN Working gloves
 PL Rękawice robocze
 DE Arbeitshandschuhe
 RU Рабочие перчатки
 CZ Pracovní rukavice
 RO Mănuși de lucru
 HU Munkakesztyű
 ES Guantes de trabajo



x12 PAIRS / PARY 10 SIZE / ROZMIAR 3143X EN 388 POLYESTER POLIESTER COTTON BAWELNA LATEX LATEKS



No.	Size / Rozmiar	Pairs / Pary	
74145	10	12	10

EN Working gloves
 PL Rękawice robocze
 DE Arbeitshandschuhe
 RU Рабочие перчатки
 CZ Pracovní rukavice
 RO Mănuși de lucru
 HU Munkakesztyű
 ES Guantes de trabajo



x12 PAIRS / PARY 3131X EN 388 NYLON POLYESTER POLIESTER PU



No.	Size / Rozmiar	Pairs / Pary	
74077	9	12	10
74078	10	12	10

EN Working gloves
 PL Rękawice robocze
 DE Arbeitshandschuhe
 RU Рабочие перчатки
 CZ Pracovní rukavice
 RO Mănuși de lucru
 HU Munkakesztyű
 ES Guantes de trabajo

10 SIZE / ROZMIAR COTTON BAWELNA PVC



No.	Size / Rozmiar	
74151	10	12/120

EN Working gloves
 PL Rękawice robocze
 DE Arbeitshandschuhe
 RU Рабочие перчатки
 CZ Pracovní rukavice
 RO Mănuși de lucru
 HU Munkakesztyű
 ES Guantes de trabajo



10 SIZE / ROZMIAR 3143X EN 388 POLYESTER POLIESTER COTTON BAWELNA LATEX LATEKS



No.	Size / Rozmiar	
74146	10	12/120

EN Working gloves
 PL Rękawice robocze
 DE Arbeitshandschuhe
 RU Рабочие перчатки
 CZ Pracovní rukavice
 RO Mănuși de lucru
 HU Munkakesztyű
 ES Guantes de trabajo



3131X EN 388 NYLON POLYESTER POLIESTER PU



No.	Size / Rozmiar	
74079	9	12/120
74080	10	12/120

EN Working gloves
 PL Rękawice robocze
 DE Arbeitshandschuhe
 RU Рабочие перчатки
 CZ Pracovní rukavice
 RO Mănuși de lucru
 HU Munkakesztyű
 ES Guantes de trabajo



3131X EN 388 NYLON POLYESTER POLIESTER PU



No.	Size / Rozmiar	
74081	9	12/120
74082	10	12/120

EN Insulated gloves
 PL Rękawice robocze ocieplane
 DE Arbeitshandschuh
 RU Перчатки
 CZ Pracovní rukavice
 RO Mănuși de protecție
 HU Védőkesztyű
 ES Guantes



No.	Size / Rozmiar	
74149	10	12/120

EN Assembly gloves
 PL Rękawice ochronne
 DE Arbeitshandschuhe
 RU Защитные перчатки
 CZ Ochranné rukavice
 RO Mănuși de protecție
 HU Védőkesztyű
 ES Guantes de protección



No.	Size / Rozmiar	
74060	10	10/120

EN Polycarbonate protection shield
 PL Osłona twarzy przeciwdpryskowa
 DE Gesichtsschutz
 RU Маска защитная
 CZ Ochranná přilba
 RO Vizieră de protecție
 HU Hegesztősisak
 ES Pantalla protectora antipedacitos



No.		
74459		25/50

EN Safety glasses
 PL Okulary ochronne
 DE Schutzbrille
 RU Очки защитные
 CZ Ochranné brýle
 RO Ochelari de protecție
 HU Védőszemüveg
 ES Gafa de seguridad



No.	Type / Typ	
74501	TVS	8/80

EN Insulated gloves
 PL Rękawice ocieplane
 DE Isolierhandschuhe
 RU Утепленные перчатки
 CZ Zimní rukavice
 RO Mănuși de protecție
 HU Szigetelt kesztyű
 ES Guantes aislados

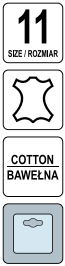

No.	Size / Rozmiar	
74003	11	10/120

EN Working gloves
 PL Rękawice robocze
 DE Arbeitshandschuhe
 RU Рабочие перчатки
 CZ Pracovní rukavice
 RO Mănuși de lucru
 HU Munkakesztyű
 ES Guantes de trabajo



No.	Size / Rozmiar	
74005	10	12/172

EN Polycarbonate protection shield
 PL Osłona twarzy przeciwdpryskowa
 DE Gesichtsschutz
 RU Маска защитная
 CZ Ochranná přilba
 RO Vizieră de protecție
 HU Hegesztősisak
 ES Pantalla protectora antipedacitos



No.		
74460		20

EN Safety glasses
 PL Okulary ochronne
 DE Schutzbrille
 RU Очки защитные
 CZ Ochranné brýle
 RO Ochelari de protecție
 HU Védőszemüveg
 ES Gafa de seguridad



No.	Type / Typ	
74505	STD SG-007	12/240

EN Safety glasses
 PL Okulary ochronne
 DE Schutzbrille
 RU Очки защитные
 CZ Ochranné brýle
 RO Ochelari de protecție
 HU Védőszemüveg
 ES Gafa de seguridad



No.	Type / Typ	
74503	DY-8525	12/240

EN Safety glasses
 PL Okulary ochronne
 DE Schutzbrille
 RU Очки защитные
 CZ Ochranné brýle
 RO Ochelari de protecție
 HU Védőszemüveg
 ES Gafa de seguridad



No.	Type / Typ	
74508	HF-103	10/120

EN Dust mask
 PL Półmaska filtrująca
 DE Staubschutzmaske
 RU Респиратор противоаэрозольный
 CZ Maska protiprašná
 RO Mască de praf
 HU Légzésvédő maszk
 ES Mascarilla para polvo



No.	pcs / szt.	
74540	5	50/50

EN Dust mask
 PL Półmaska filtrująca
 DE Staubschutzmaske
 RU Респиратор противоаэрозольный
 CZ Maska protiprašná
 RO Mască de praf
 HU Légzésvédő maszk
 ES Mascarilla para polvo



No.	pcs / szt.	
74542	5	50/50

EN Safety glasses
 PL Okulary ochronne
 DE Schutzbrille
 RU Очки защитные
 CZ Ochranné brýle
 RO Ochelari de protecție
 HU Védőszemüveg
 ES Gafa de seguridad



No.	Type / Typ	
74504	DY-8526	15/150

EN Safety glasses
 PL Okulary ochronne
 DE Schutzbrille
 RU Очки защитные
 CZ Ochranné brýle
 RO Ochelari de protecție
 HU Védőszemüveg
 ES Gafa de seguridad



No.	Type / Typ	
74509	HF-105	10/100

EN Dust mask
 PL Półmaska filtrująca
 DE Staubschutzmaske
 RU Респиратор противоаэрозольный
 CZ Maska protiprašná
 RO Mască de praf
 HU Légzésvédő maszk
 ES Mascarilla para polvo



No.	pcs / szt.	
74541	5	15/50

EN Dust mask
 PL Półmaska filtrująca
 DE Staubschutzmaske
 RU Респиратор противоаэрозольный
 CZ Maska protiprašná
 RO Mască de praf
 HU Légzésvédő maszk
 ES Mascarilla para polvo



No.	pcs / szt.	
74543	5	15/50

EN Anti-pollution mask
 PL Półmaska antysmogowa
 DE Anti-Smog-Maske
 RU Антисмоговая полумаска
 CZ Antismogová maska
 RO Mască de protecție
 HU Szmogellenes maszk
 ES Mascarilla anti smog



No.	Type / Typ	
74555	antysmogowa, VZ/PZ	50

EN Face shield
 PL Osłona siatkowa twarzy z nagłowiem
 DE Gesichtsschutz mit Maschenvisier
 RU Сеточная защитная маска с обвязкой для головы
 CZ Síťová ochrana tváře s postrojem
 RO Vizieră de protecție din plasă
 HU Hálós arcvédő
 ES Pantalla con visor de malla metálica



No.		
74468		25

EN Replacement visor
 PL Wymienna osłona
 DE Ersatz-Visier
 RU Заменяемая защита
 CZ Náhradní hledí
 RO Vizor de rezervă
 HU Cseré pajzs arcvédőhöz
 ES Visera de repuesto



No.	Size / Rozmiar [mm]	Type / Typ	For / Dla	
74466	350x200	OT 1-N	74460	10/100

EN Face shield with PC visor
 PL Przyłbica z osłoną wymienną
 DE Gesichtsschutz mit austauschbarer Visier
 RU Шлем с заменяемой защитой
 CZ Štít s vyměnitelným krytem
 RO Vizieră cu protecție schimbabilă
 HU Arcvédő cserélhető pajzsral
 ES Antifaz con protección reemplazable

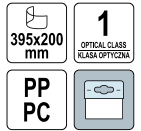

No.		
74471		25

EN Face shield with steel mesh and ear muff
 PL Przyłbica z osłoną wymienną i nausznikami przeciwhałasowymi
 DE Gesichtsschutz mit austauschbarem Visier und Gehörschutz
 RU Шлем с заменяемой защитой и наушниками против шума
 CZ Štít s vyměnitelným krytem a chrániči proti hluku
 RO Set vizieră și căști de protecție antifon
 HU Arcvédő cserélhető pajzsral és fülvédő kagylóval
 ES Antifaz con protección reemplazable y protectores de oídos



No.		
74462		40

EN Knee pads
 PL Nakolanniki
 DE Knieschützer
 RU Наколенники
 CZ Chrániče kolen
 RO Genunchiere
 HU Térdvédő
 ES Rodilleras



No.		
74600		50

EN Knee pads
 PL Nakolanniki
 DE Knieschützer
 RU Наколенники
 CZ Chrániče kolen
 RO Genunchiere
 HU Térdvédő
 ES Rodilleras



No. 74610  20

EN Knee pads
 PL Nakolanniki
 DE Knieschützer
 RU Наколенники
 CZ Chrániče kolen
 RO Genunchiere
 HU Térdvédő
 ES Rodilleras



VOREL
 No. 74624  12/24

EN Knee pads
 PL Nakolanniki
 DE Knieschützer
 RU Наколенники
 CZ Chrániče kolen
 RO Genunchiere
 HU Térdvédő
 ES Rodilleras



VOREL
 No. 74602  6/36

EN Knee pads
 PL Nakolanniki - wkładki
 DE Knieschützer
 RU Наколенники
 CZ Chrániče kolen
 RO Genunchiere
 HU Térdvédő
 ES Rodilleras



VOREL
 No. 74595  60

EN Knee pads
 PL Nakolanniki
 DE Knieschützer
 RU Наколенники
 CZ Chrániče kolen
 RO Genunchiere
 HU Térdvédő
 ES Rodilleras



No. 74622  36

EN Knee pads
 PL Nakolanniki
 DE Knieschützer
 RU Наколенники
 CZ Chrániče kolen
 RO Genunchiere
 HU Térdvédő
 ES Rodilleras



VOREL
 No. 74601  24

EN Knee pads
 PL Nakolanniki
 DE Knieschützer
 RU Наколенники
 CZ Chrániče kolen
 RO Genunchiere
 HU Térdvédő
 ES Rodilleras



VOREL
 No. 74604  20

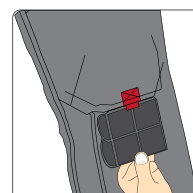

EN Safety earmuffs
 PL Nauszniki przeciwhałasowe
 DE Gehörschutz
 RU Противошумные наушники
 CZ Chránice sluchu
 RO Căști antifonice
 HU Hallásvédő fültek
 ES Auriculares de protección auditiva



No.		
74580		60

EN Safety helmet
 PL Kask ochronny
 DE Schutzhelm
 RU Каска защитная
 CZ Ochranná přilba
 RO Cască de protecție
 HU Védősisak
 ES Casco de protección



No.	Color / Kolor	
74171	pomarańczowy	30
74172	żółty	30
74173	biały	30
74174	czerwony	30
74175	niebieski	30
74176	zielony	30

EN Men's rain boots
 PL Kalosze męskie
 DE Gummistiefel für Herren
 RU Резиновые сапоги мужские
 CZ Pánské holínky
 RO Cizme de cauciuc bărbatești
 HU Férfi gumicsizma
 ES Botas de agua para hombre



No.	Size / Rozmiar	
73937	41	5
73938	42	5
73939	43	5
73940	44	5
73941	45	5
73942	46	5
73943	47	5

EN Safety earmuffs
 PL Nauszniki przeciwhałasowe
 DE Gehörschutz
 RU Противошумные наушники
 CZ Chránice sluchu
 RO Căști antifonice
 HU Hallásvédő fültek
 ES Auriculares de protección auditiva



No.		
74581		10/60

EN Women's rain boots
 PL Kalosze damskie
 DE Gummistiefel für Damen
 RU Резиновые сапоги женские
 CZ Dámské holínky
 RO Cizme de cauciuc damă
 HU Női gumicsizma
 ES Botas de agua para mujer



No.	Size / Rozmiar	
73931	36	7
73932	37	7
73933	38	7
73934	39	7
73935	40	7
73936	41	7

EN Women's rain boots
 PL Kalosze damskie
 DE Gummistiefel für Damen
 RU Резиновые сапоги женские
 CZ Dámské holínky
 RO Cizme de cauciuc damă
 HU Női gumicsizma
 ES Botas de agua para mujer



No.	Size / Rozmiar	
73945	37	5
73946	38	5
73947	39	5

- EN Men's rain boots
- PL Kalosze męskie
- DE Gummistiefel für Herren
- RU Резиновые сапоги мужские
- CZ Pánské holinky
- RO Cizme de cauciuc bărbătești
- HU Férfi gumicsizma
- ES Botas de agua para hombre



No.	Size / Rozmiar	
73950	41	5
73951	42	5
73952	43	5
73953	44	5
73954	45	5
73955	46	5

- EN Men's rain boots
- CZ Pánské holinky
- PL Kalosze męskie
- RO Cizme de cauciuc bărbătești
- DE Gummistiefel für Herren
- HU Férfi gumicsizma
- RU Резиновые сапоги мужские
- ES Botas de agua para hombre



No.	Size / Rozmiar	
73966	40	5
73967	41	5
73968	42	5
73969	43	5
73970	44	5
73971	45	5
73972	46	5
73973	47	5

- EN Antibacterial insole
- PL Antybakteryjna wkładka do butów
- DE Antibakterielle Einlage für Schuhe
- RU Антибактериальная стелька
- CZ Antibakteriální vložka do bot
- RO Branșuri antibacteriene
- HU Antibakteriális cipőbetét
- ES Plantilla antibacterial

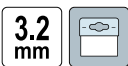

No.	Size / Rozmiar	Thickness / Grubość [mm]	
72683	39/40	3.2	50
72684	41/42	3.2	50
72685	43/44	3.2	50
72686	45/46	3.2	50

- EN Felt and PVC boots
- PL Buty gumowo-filcowe
- DE Filz-Gummistiefel
- RU Сапоги резиновые с войлоком
- CZ Holinky gumofilcové
- RO Cizme PVC cu păsă
- HU Gumí-filc csizma
- ES Botas de caucho fieltro



No.	Size / Rozmiar	
73958	40	5
73959	41	5
73960	42	5
73961	43	5
73962	44	5
73963	45	5
73964	46	5



- EN Winter hat
- PL Czapka zimowa
- DE Wintermütze
- RU Зимняя шапка
- CZ Zimní čepice
- RO Căciulă iarnă
- HU Télisapka
- ES Gorro de invierno



No.	Color / Kolor	
74230	czarny	200

- EN Winter hat
- PL Czapka zimowa
- DE Wintermütze
- RU Зимняя шапка
- CZ Zimní čepice
- RO Căciulă iarnă
- HU Télisapka
- ES Gorro de invierno



No.	Color / Kolor	
74231	szary	200

EN Winter hat
 PL Czapka zimowa
 DE Wintermütze
 RU Зимняя шапка
 CZ Zimní čepice
 RO Căciulă iarnă
 HU Téli sapka
 ES Gorro de invierno



No.	Color / Kolor	Icon
74232	ciemnoszary	200

EN Winter hat
 PL Czapka zimowa
 DE Wintermütze
 RU Зимняя шапка
 CZ Zimní čepice
 RO Căciulă iarnă
 HU Téli sapka
 ES Gorro de invierno



No.	Color / Kolor	Icon
74233	żółty	200

EN Balaclava
 PL Kominarka
 DE Kapuzenmütze
 RU Балаклава
 CZ Kukla
 RO Cagula
 HU Simaszok
 ES Pasamontañas



No.	Color / Kolor	Icon
74240	ciemnobrązowy	120

EN Reflective vest
 PL Kamizelka ostrzegawcza
 DE Warnweste
 RU Жилет безопасности
 CZ Výstražná vesta
 RO Vestă de avertizare
 HU Fényvisszaverő mellény
 ES chaleco reflectante



No.	Size / Rozmiar	Series / Seria	Icon
74660	L	VEST-0	100
74661	XL	VEST-0	100
74662	XXL	VEST-0	100
74663	XXXL	VEST-0	100

100% polyester
 100% poliester

EN Reflective vest
 PL Kamizelka ostrzegawcza
 DE Warnweste
 RU Жилет безопасности
 CZ Výstražná vesta
 RO Vestă de avertizare
 HU Fényvisszaverő mellény
 ES chaleco reflectante



No.	Size / Rozmiar	Series / Seria	Icon
74664	L	VEST-G	100
74665	XL	VEST-G	100
74666	XXL	VEST-G	100
74667	XXXL	VEST-G	100

100% polyester
 100% poliester

EN Waterproof jacket
 PL Kurtka przeciwdeszczowa
 DE Regenjacke
 RU Куртка-дождевик
 CZ Bunda do deště
 RO Geacă de ploaie
 HU Vízhatlan dzseki
 ES Chaqueta impermeable



CLOUDBURST

No.	Size / Rozmiar	Icon
74626	L	30
74627	XXL	30
74628	XXXL	30



70% PVC, 30% polyester
 70% PVC, 30% poliester

EN Raincoat
 PL Plaszcz przeciwdeszczowy
 DE Regenmantel
 RU Дождевик
 CZ Pláštěnka
 RO Pelerina ploaie
 HU Esőkabát
 ES Impermeable



NAVY COMPACT

No.	Size / Rozmiar	Icon
74653	L	20
74654	XL	20
74655	XXL	20



- EN Raincoat
- PL Płaszcz przeciwdeszczowy
- DE Regenmantel
- RU Дождевик
- CZ Pláštěnka
- RO Pelerina ploaie
- HU Esőkabát
- ES Impermeable



70% PVC, 30% polyester
70% PVC, 30% poliester



CLouDBURST

No.	Size / Rozmiar	
74631	XL	16
74632	XXL	16
74633	XXXL	16

- EN Rainsuit
- PL Zestaw przeciwdeszczowy
- DE Regenschutz-Set
- RU Противодождевой набор
- CZ Protidešťová sada
- RO Costum impermeabil
- HU Esővédő szett
- ES Juego impermeable



NAVY COMPACT

No.	Size / Rozmiar	
74657	L	16
74658	XL	16
74659	XXL	16

- EN Rain suit military style
- PL Zestaw przeciwdeszczowy moro
- DE Regenbekleidung militärischen Stil
- RU Дождь костюмы военный стиль
- CZ Oblek maskáčový do deště
- RO Îmbrăcămintă de ploaie camuflaj
- HU Eső ruházat
- ES Ropa de lluvia camo



70% PVC, 30% polyester
70% PVC, 30% poliester



MORO COMPACT

No.	Size / Rozmiar	
74646	L	20
74647	XXL	20

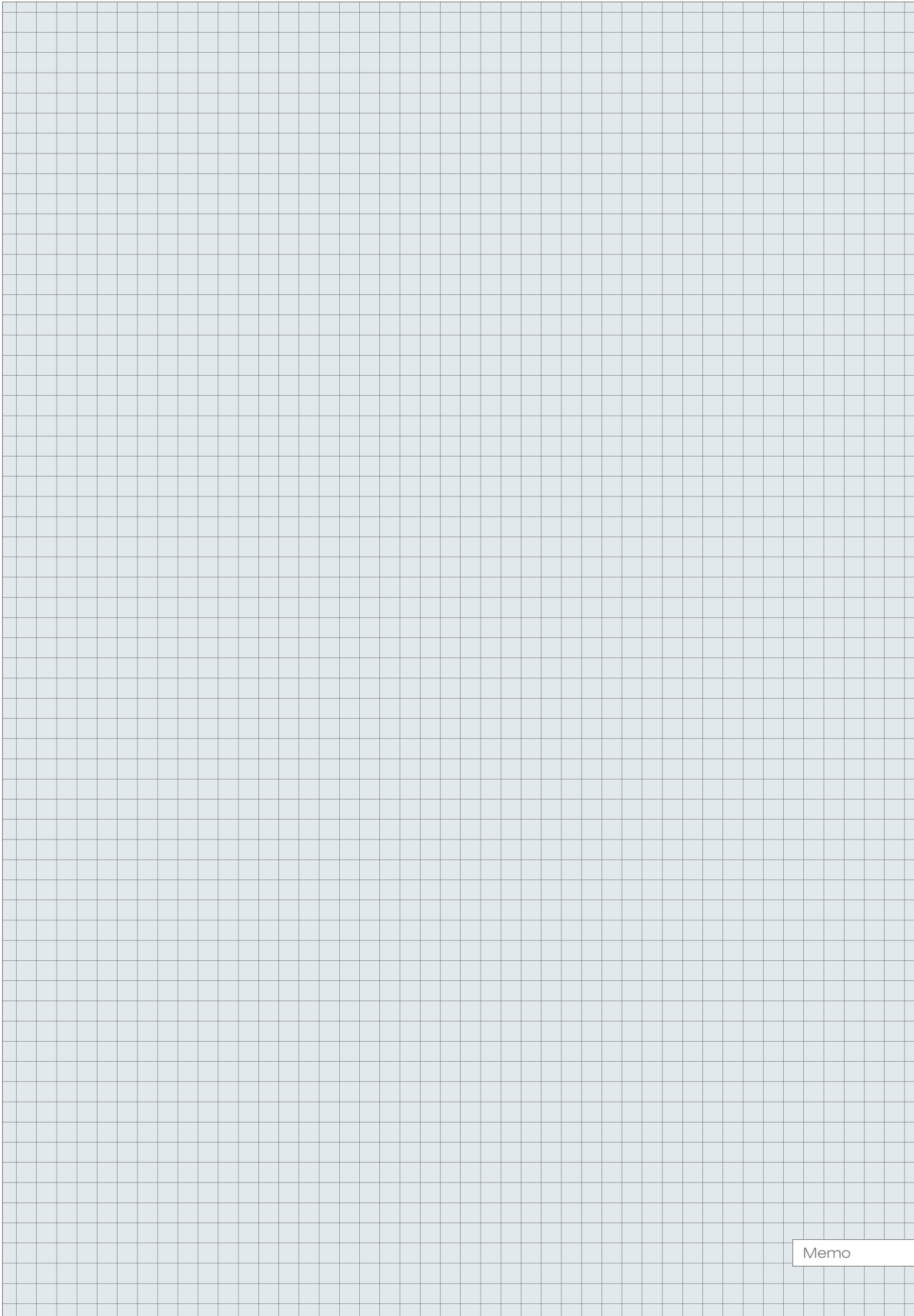

Memo

23

Electric products
Artykuły elektryczne

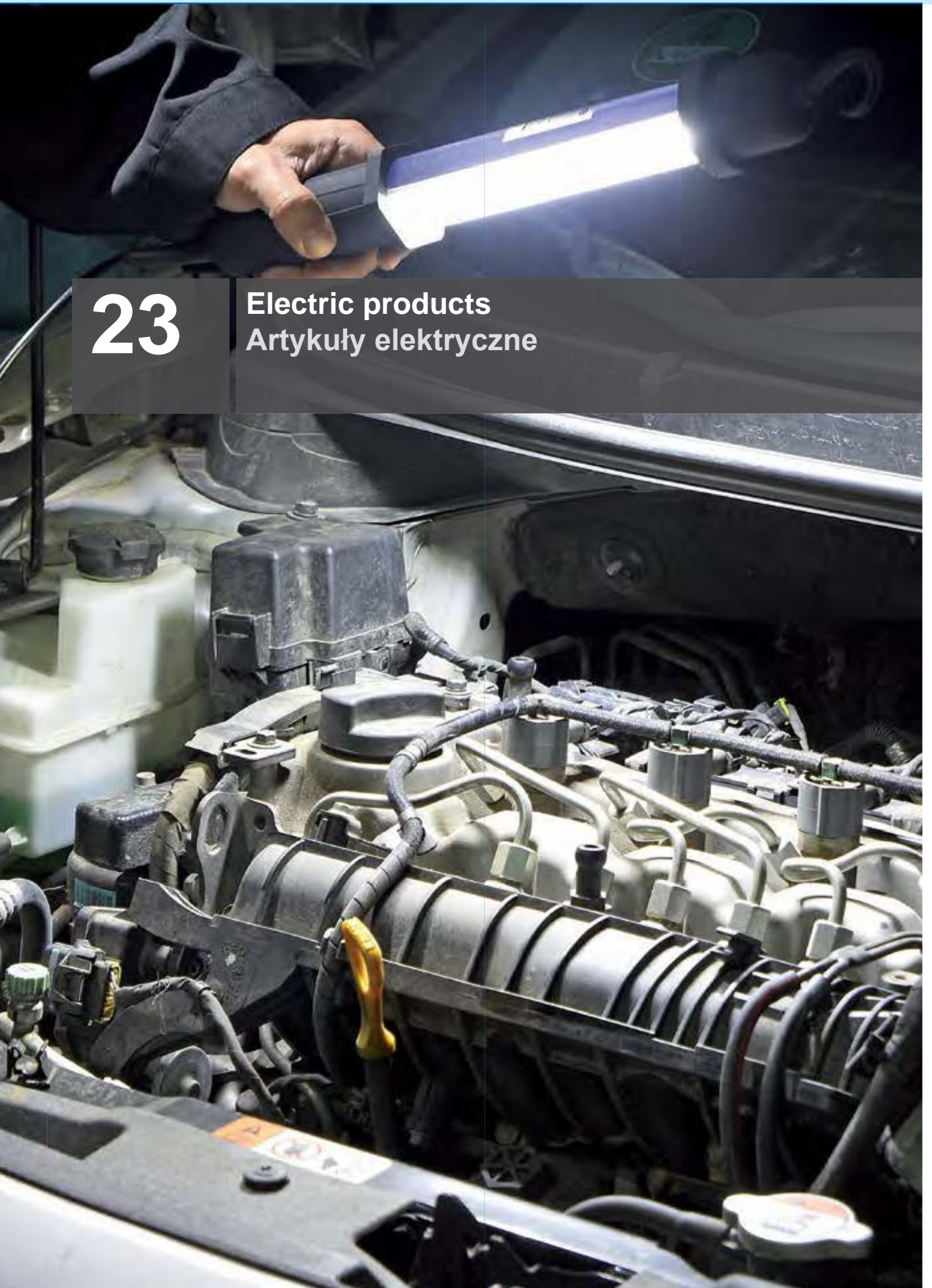

Extension cords & cable reels Przedłużacze listwowe i bębnowe

376-378



Extension cords French type

Przedłużacze elektryczne z uziemieniem..... 376

Extension cords

Przedłużacze elektryczne bez uziemienia..... 377

Cable reels French type

Przedłużacze bębnowe z uziemieniem..... 378

Travel adapters Adaptory podróżne

378



Adaptors Rozgałęźniki

378-379



Lamps Lampy

379-387



Halogen bulbs

Żarniki do lamp halogenowych..... 379

Floodlights

Naświetlacze..... 379

Workshop lamps

Lampy warsztatowe..... 380

LED flashlights

Latarki diodowe..... 382

Bicycle lamps

Lampy rowerowe..... 384

Night lamps

Lampki nocne..... 384

Infrared heaters

Promienniki podczerwieni..... 384

Insect killer lamps & accessories

Lampy owadobójcze i akcesoria..... 385

EN Surge protector power strip
 PL Listwa zasilająca przeciwprzepięciowa
 DE Überspannungsschutzleiste
 RU Колодка электрическая с защитой от перенапряжения
 CZ Prodlužovací kabel s přepětovou ochranou
 RO Prelungitor cu protecție
 HU Túlfeszültségvédő elosztó
 ES Regleta de protección contra sobretensiones

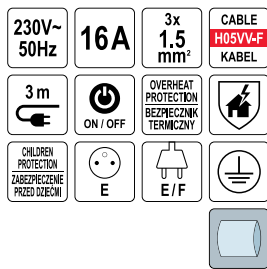

STIMOR

No.	L [m]	☺	Socket type / Typ gniazda	📦
72370	3	5	E	30
72371	3	6	E	20

EN Surge protector power strip
 PL Listwa zasilająca przeciwprzepięciowa
 DE Überspannungsschutzleiste
 RU Колодка электрическая с защитой от перенапряжения
 CZ Prodlužovací kabel s přepětovou ochranou
 RO Prelungitor cu protecție
 HU Túlfeszültségvédő elosztó
 ES Regleta de protección contra sobretensiones

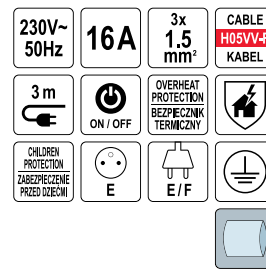

STIMOR

No.	L [m]	☺	Socket type / Typ gniazda	📦
72372	3	5	E	30
72373	3	6	E	20

EN Extension cord
 PL Przedłużacz elektryczny
 DE Verlängerungsschnur
 RU Удлинитель электрический
 CZ Elektrický prodlužovač
 RO Prelungitor electric
 HU Elektromos hosszabbító
 ES Extensión eléctrica



LUND

No.	L [m]	☺	Socket type / Typ gniazda	📦
72460	2	5	E	25

EN Extension cord
 PL Przedłużacz elektryczny
 DE Verlängerungskabel
 RU Удлинитель электрический
 CZ Elektrický prodlužovač
 RO Prelungitor electric
 HU Elektromos hosszabbító
 ES Extensión eléctrica

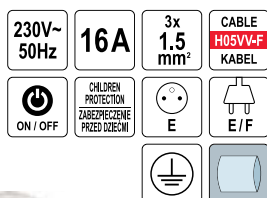

EN Cord extension with earthing
 PL Przedłużacz elektryczny z uziemieniem
 DE Verlängerungskabel mit Erdung
 RU Удлинитель электрический с заземлением
 CZ Elektrický prodlužovač
 RO Prelungitor electric
 HU Elektromos hosszabbító
 ES Extensión eléctrica

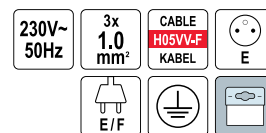

STIMOR

No.	L [m]	☺	Socket type / Typ gniazda	📦
72350	1.5	3	E	40
72351	3.0	3	E	40
72352	5.0	3	E	30
72353	1.5	4	E	30
72354	3.0	4	E	30
72355	5.0	4	E	20
72356	1.5	5	E	30
72357	3.0	5	E	30
72358	5.0	5	E	20

VOREL

No.	L [m]	☺	Socket type / Typ gniazda	📦
72500	1.5	3	E	30
72501	1.5	4	E	30
72504	3.0	3	E	30
72505	3.0	4	E	30
72506	3.0	5	E	1/30
72508	5.0	3	E	30
72509	5.0	4	E	30
72510	5.0	5	E	30

EN Cord extension with earthing
 PL Przedłużacz elektryczny z uziemieniem
 DE Verlängerungskabel mit Erdung
 RU Удлинитель электрический с заземлением
 CZ Elektrický prodloužovač
 RO Prelungitor electric
 HU Elektromos hosszabbító
 ES Extensión eléctrica

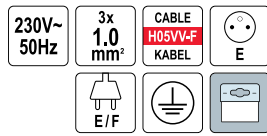

No.	L [m]	⊕	Socket type / Typ gniazda	📦
72615	1.5	3	E	30
72616	3.0	3	E	30
72617	5.0	3	E	30
72620	1.5	4	E	1/30
72621	3.0	4	E	30
72622	5.0	4	E	30

EN Cord extension with switch
 PL Przedłużacz elektryczny z wyłącznikiem
 DE Steckdosenleiste mit Schalter
 RU Удлинитель электрический с выключателем
 CZ Elektrický prodloužovač
 RO Prelungitor electric
 HU Elektromos hosszabbító
 ES Extensión para arbol de navidad verde

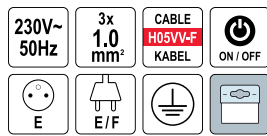

No.	L [m]	⊕	Socket type / Typ gniazda	📦
72625	1.5	3	E	30
72626	3.0	3	E	30
72627	5.0	3	E	30
72630	1.5	4	E	30
72631	3.0	4	E	30
72632	5.0	4	E	30

EN Garden extension cable
 PL Przedłużacz
 DE Gartenverlängerungskabel
 RU Электроудлинитель
 CZ Prodloužovací kabel zahradní
 RO Prelungitor electric
 HU Kerti hosszabbító
 ES Cable de extensión para jardín



No.	L [m]	📦
82671	10	10
82673	20	10
82675	30	5

EN Cord extension with switch
 PL Przedłużacz elektryczny z wyłącznikiem
 DE Steckdosenleiste mit Schalter
 RU Удлинитель электрический с выключателем
 CZ Elektrický prodloužovač
 RO Prelungitor electric
 HU Elektromos hosszabbító
 ES Extensión para arbol de navidad verde

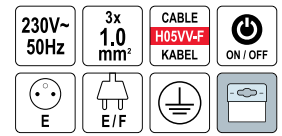

No.	L [m]	⊕	Socket type / Typ gniazda	📦
72524	1.5	3	E	30
72525	1.5	4	E	30
72526	1.5	5	E	30
72527	1.5	6	E	30
72528	3.0	3	E	30
72529	3.0	4	E	30
72530	3.0	5	E	30
72531	3.0	6	E	30
72532	5.0	3	E	30
72533	5.0	4	E	30
72534	5.0	5	E	30
72535	5.0	6	E	30

EN Cord extension without earthing
 PL Przedłużacz elektryczny bez uziemienia
 DE Steckdosenleiste ohne Zuleitung
 RU Удлинитель электрический без заземления
 CZ Elektrický prodloužovač
 RO Prelungitor electric
 HU Elektromos hosszabbító
 ES Extensión eléctrica

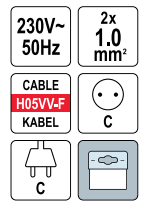

No.	L [m]	⊕	Socket type / Typ gniazda	📦
72484	1.5	3	C	30
72486	1.5	4	C	30
72489	3.0	3	C	30
72490	3.0	4	C	30
72493	5.0	3	C	30
72494	5.0	4	C	1/30

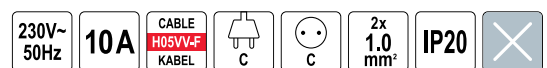

- EN Cable reel
- PL Przedłużacz bębnowy
- DE Kabeltrommel
- RU Удлинитель на катушке
- CZ Bubenový prodloužovač
- RO Prelungitor pe tambur
- HU Kábeldob
- ES Cable de prolongación de tambor



230V~ 50Hz	CABLE H05VV-F KABEL	E
E/F	OVERHEAT PROTECTION BEZPEČNÍK TERMICZNY	CHILDREN PROTECTION ZABEZPEČENIE PRZED ODCIEM



No.	L [m]	Wire section area / Pole przekroju przewodu [mm ²]		Socket type / Typ gniazda	
82682	25	3Gx1.0	4	E	2
82684	40	3Gx1.0	4	E	2
82685	50	3Gx1.5	4	E	2

- EN Travel adapter World to Europe
- PL Adapter podróżny Świat-Europa
- DE Reisestecker Welt-Europa
- RU Дорожный адаптер-переходник Мир-Европа
- CZ Cestovní adaptér Svět-Evropa
- RO Adaptor de călătorie World to Europe
- HU Utazó adapter Világ-Európa
- ES Adaptador de viaje Mundo-Europa



	EURO	UK
AUS	USA	EURO



No.	Socket type / Typ gniazda	
72440	universalne	100

- EN Travel adapter Europe to UK
- PL Adapter podróżny Europa-UK
- DE Reisestecker Europa-UK
- RU Дорожный адаптер-переходник Европа-Англия
- CZ Cestovní adaptér Evropa-UK
- RO Adaptor de călătorie din Europa-UK
- HU Utazó adapter Európa-UK
- ES Adaptador de viaje Europa-Gran Bretaña



EURO	UK	



No.	Socket type / Typ gniazda	
72442	F	100

- EN Cable reel
- PL Przedłużacz zwijany
- DE Einziehbares Verlängerungskabel
- RU Удлинитель электрический
- CZ Bubenový prodloužovač
- RO Prelungitor pe tambur
- HU Kábeldob
- ES Extensión eléctrica



230V~ 50Hz	CABLE H05VV-F KABEL	E
E/F	OVERHEAT PROTECTION BEZPEČNÍK TERMICZNY	CHILDREN PROTECTION ZABEZPEČENIE PRZED ODCIEM



No.	L [m]	Wire section area / Pole przekroju przewodu [mm ²]		Socket type / Typ gniazda	
72570	15	3Gx1.0	4	E	4
72572	25	3Gx1.0	4	E	4
72573	30	3Gx1.5	4	E	4

- EN Travel adapter Europe to USA
- PL Adapter podróżny Europa-USA
- DE Reisestecker Europa-USA
- RU Дорожный адаптер-переходник Европа-США
- CZ Cestovní adaptér Evropa-USA
- RO Adaptor de călătorie din Europa-SUA
- HU Utazó adapter Európa-USA
- ES Adaptador de viaje Europa-EE.UU.



EURO	USA	



No.	Socket type / Typ gniazda	
72441	F	100

- EN Adapter
- PL Rozgałęźnik
- DE Abzweigung
- RU Разветвитель
- CZ Rozdvojka
- RO Stecher
- HU Osztó
- ES Enchufe múltiple

230V~ 50Hz	16A	



No.		Socket type / Typ gniazda	
72404	2	E	100

EN Adapter
 PL Rozgałęźnik
 DE Abzweigung
 RU Разветвитель
 CZ Rozdvojka
 RO Stecher
 HU Osztó
 ES Enchufe múltiple



230V~
50Hz

16A



No.	Socket type / Typ gniazda	Quantity
72407	E	100

EN Halogen projector bulbs
 PL Żarniki do lamp halogenowych
 DE Halogenstab
 RU Галогенная трубка

CZ Žárovka do halogenové lampy
 RO Bec cu halogen pt. projector
 HU Halogén lámpaizzó
 ES Filamentos de bombillas halogenas

2 PCS

R7s



No.	Filament power / Moc żarnika halogenowego [W]	Luminous flux / Strumień świetlny [lm]	Lifetime / Żywotność [h]	Quantity
82771	120	2200	1000	50/200
82772	400	8600	1000	50/200

EN String floodlight set
 PL Zestaw reflektorów
 DE LED-Leuchten-Set
 RU Набор светильников
 CZ Sada reflektorů
 RO Șir de lumini LED
 HU Reflektorkészlet
 ES Conjunto de focos

220-240V~50Hz

CRI 80

5x

6W 600lm

TOTAL 30 W 3000lm

5000K

20000 h

LINKABLE MOŻLIWOŚĆ ŁĄCZENIA

CLIP HOOK KARABINCIK



F A G

SMD LED

No.	Power / Moc [W]	Luminous flux / Strumień świetlny [lm]	Lifetime / Żywotność [h]	Quantity
82861	6 x5	600 x5	20000	4

EN LED rechargeable floodlight
 PL Reflektor LED akumulatorowy
 DE Akku-LED-Strahler
 RU Светодиодный аккумуляторный прожектор
 CZ LED bateriový reflektor
 RO Reflector LED cu acumulator
 HU Újratölthető reflektor LED
 ES Reflector recargable LED

10 W

3.7 V 4400mAh Li-Ion

1000 lm

3-4h

2-4h

4400 mAh

2 LIGHTING MODELS TRÓJ SWIECEN

IP65

IK07

x1 HOOK HAK

USB

USB CABLE KABEL

ABS AL TPR

COB

LED



No.	Power / Moc [W]	Luminous flux / Strumień świetlny [lm]	Quantity
82870	10	1000 (100%), 500 (50%)	15

EN Adapter
 PL Rozgałęźnik
 DE Abzweigung
 RU Разветвитель
 CZ Rozdvojka
 RO Stecher
 HU Osztó
 ES Enchufe múltiple



230V~
50Hz

2.5 A



No.	Socket type / Typ gniazda	Quantity
72400	C	200
72401	C	20/100
72402	C	100



EN String floodlight set
 PL Zestaw reflektorów
 DE LED-Leuchten-Set
 RU Набор светильников
 CZ Sada reflektorů
 RO Șir de lumini LED
 HU Reflektorkészlet
 ES Conjunto de focos

220-240V~50Hz

CRI 80

5x

9W 900lm

TOTAL 45 W 4500lm

5000K

20000 h

LINKABLE MOŻLIWOŚĆ ŁĄCZENIA

CLIP HOOK KARABINCIK



F A G

COB LED

No.	Power / Moc [W]	Luminous flux / Strumień świetlny [lm]	Lifetime / Żywotność [h]	Quantity
82863	9 x5	900 x5	20000	4

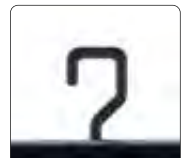

- EN LED rechargeable floodlight
- PL Reflektor LED akumulatorowy
- DE Akku-LED-Strahler
- RU Светодиодный аккумуляторный прожектор
- CZ LED bateriový reflektor
- RO Reflector LED cu acumulator
- HU Újratölhető reflektor LED
- ES Reflector recargable LED

20 W	3.7 V 6600mAh Li-Ion	2000 lm	5-6h	2-8h
6600 mAh	3 LIGHTING MODES TRZY ŚWIECENIA	IP65	IK07	x1 HOOK HAK
USB CABLE KABEL	USB CABLE KABEL		ABS AL TPR	

COB LED



STKOR

No.	Power / Moc [W]	Luminous flux / Strumień świetlny [lm]	
82871	20	2000 (100%), 1000 (50%), 500 (25%)	15

- EN LED rechargeable floodlight
- PL Reflektor LED akumulatorowy
- DE Akku-LED-Strahler
- RU Светодиодный аккумуляторный прожектор
- CZ LED bateriový reflektor
- RO Reflector LED cu acumulator
- HU Újratölhető reflektor LED
- ES Reflector recargable LED

20 W	3.7 V 4400mAh Li-Ion	2000 lm	5-6h	2-4h
2 LIGHTING MODES TRZY ŚWIECENIA	IP65	IK06	x1 HOOK HAK	USB CABLE KABEL
USB CABLE KABEL				

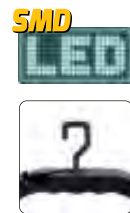

STKOR

No.	Power / Moc [W]	Luminous flux / Strumień świetlny [lm]	
82882	20	2000 (100%), 1000 (50%)	20

- EN LED work light
- PL Lampa robocza LED
- DE LED Handleuchte
- RU Светодиодный светильник для мастерской
- CZ Pracovní LED svítidla
- RO Lampa portabila cu LED
- HU LED szerelőlámpa
- ES Lámpara de taller LED

230V~ 50Hz	3.2 W	280 lm	16 LED
x1 HOOK HAK	5m		



VOREL

No.	Power / Moc [W]	Light source / Źródło światła [LED]	
82699	3.2	16	10/20

- EN LED rechargeable floodlight
- PL Reflektor LED akumulatorowy
- DE Akku-LED-Strahler
- RU Светодиодный аккумуляторный прожектор
- CZ LED bateriový reflektor
- RO Reflector LED cu acumulator
- HU Újratölhető reflektor LED
- ES Reflector recargable LED

10 W	3.7 V 2200mAh Li-Ion	1000 lm
3-4h	2-4h	2 LIGHTING MODES TRZY ŚWIECENIA
IP65	IK06	x1 HOOK HAK
USB CABLE KABEL	USB CABLE KABEL	



STKOR

No.	Power / Moc [W]	Luminous flux / Strumień świetlny [lm]	
82881	10	1000 (100%), 500 (50%)	20

- EN LED work light
- PL Lampa robocza LED
- DE LED Handleuchte
- RU Светодиодный светильник для мастерской
- CZ Pracovní LED svítidla
- RO Lampa portabila cu LED
- HU LED szerelőlámpa
- ES Lámpara de taller LED

3W	100 lm	2 LIGHTING MODES TRZY ŚWIECENIA	4h	3.7 V 800mAh Li-Ion
USB CABLE KABEL	x1 HOOK HAK			



VOREL

No.	Power / Moc [W]	Battery capacity / Pojemność akumulatora [mAh]	
82723	3	800	12/48

- EN LED work light
- PL Lampa robocza LED
- DE LED Handleuchte
- RU Светодиодный светильник для мастерской
- CZ Pracovní LED svítidla
- RO Lampa portabila cu LED
- HU LED szerelőlámpa
- ES Lámpara de taller LED

230V~ 50Hz	4.5 W	400 lm	24 LED
x1 HOOK HAK	5m		



VOREL

No.	Power / Moc [W]	Light source / Źródło światła [LED]	
82706	4.5	24	10/20

EN Workshop LED battery lamp
 PL Lampa warsztatowa LED akumulatorowa
 DE Akku-LED-Werkstattlampe
 RU Фонарик аккумуляторный для мастерской
 CZ Aku LED pracovní svítidla
 RO Lampă LED cu acumulator
 HU Akkumulátoros LED szerelőlámpa
 ES Lámpara de trabajo LED recargable

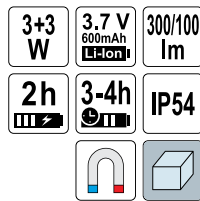

COB

LED



VOREL

No.	Power / Moc [W]	Battery capacity / Pojemność akumulatora [mAh]	Box
82734	3+3	600	120

EN LED work light
 PL Lampa robocza LED
 DE LED Handleuchte
 RU Светодиодный светильник для мастерской
 CZ Pracovní LED svítidla
 RO Lampa portabila cu LED
 HU LED szerelőlámpa
 ES Lámpara de taller LED

COB

LED



VOREL

No.	Battery type / Rodzaj baterii	Box
82724	3x1.5V; AAA	12/48

EN LED work light
 PL Lampa robocza LED
 DE LED Handleuchte
 RU Светодиодный светильник для мастерской
 CZ Pracovní LED svítidla
 RO Lampa portabila cu LED
 HU LED szerelőlámpa
 ES Lámpara de taller LED

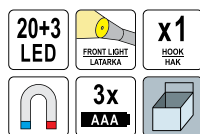

SMD

LED



VOREL

No.	Light source / Źródło światła [LED]	Battery type / Rodzaj baterii	Box
82730	20+3	3x1.5V; AAA	12/48

EN Workshop LED battery lamp
 PL Lampa warsztatowa LED akumulatorowa
 DE Akku-LED-Werkstattlampe
 RU Фонарик аккумуляторный для мастерской
 CZ Aku LED pracovní svítidla
 RO Lampă LED cu acumulator
 HU Akkumulátoros LED szerelőlámpa
 ES Lámpara de trabajo LED recargable

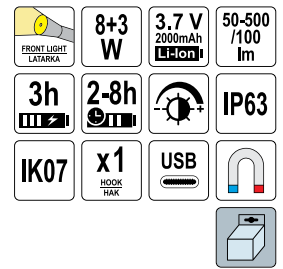

COB SMD

LED

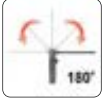

STMOR

No.	Power / Moc [W]	Battery capacity / Pojemność akumulatora [mAh]	Box
82743	8+3	2000	50

EN LED work light
 PL Lampa robocza LED
 DE LED Handleuchte
 RU Светодиодный светильник для мастерской
 CZ Pracovní LED svítidla
 RO Lampa portabila cu LED
 HU LED szerelőlámpa
 ES Lámpara de taller LED

COB

LED

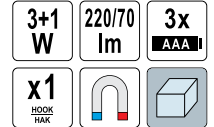

VOREL

No.	Battery type / Rodzaj baterii	Box
82733	3x1.5V; AAA	24/48

EN LED work light
 PL Lampa robocza LED
 DE LED Handleuchte
 RU Светодиодный светильник для мастерской
 CZ Pracovní LED svítidla
 RO Lampa portabila cu LED
 HU LED szerelőlámpa
 ES Lámpara de taller LED

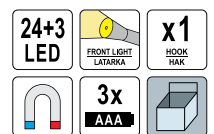

SMD

LED



VOREL

No.	Light source / Źródło światła [LED]	Battery type / Rodzaj baterii	Box
82731	24+3	3x1.5V; AAA	12/48

- EN LED work light
- PL Lampa robocza LED
- DE LED Handleuchte
- RU Светодиодный светильник для мастерской
- CZ Pracovní LED svítidla
- RO Lampa portabila cu LED
- HU LED szerelőlámpa
- ES Lámpara de taller LED



No.	Battery type / Rodzaj baterii	
82726	3x1.5V; AA	12/48

- EN Workshop LED battery lamp
- PL Lampa warsztatowa LED akumulatorowa
- DE Akku-LED-Werkstattlampe
- RU Фонарик аккумуляторный для мастерской
- CZ Aku LED pracovní svítidla
- RO Lampă LED cu acumulator
- HU Akkumulátoros LED szerelőlámpa
- ES Lámpara de trabajo LED recargable

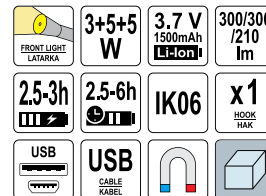

No.	Power / Moc [W]	Battery capacity / Pojemność akumulatora [mAh]	
82732	3+5+5	1500	24

- EN Under bonnet work lamp
- PL Lampa do oświetlenia komory silnika
- DE Motorhauben-Leuchte
- RU Лампа освещения моторного отсека
- CZ Dílnská lampa pro osvětlení motorového prostoru
- RO Lampă de lucru pt. compartimentul motor
- HU Motortér megvilágító lámpa
- ES Lámpara para capó de coche



No.	Power / Moc [W]	Battery capacity / Pojemność akumulatora [mAh]	
82707	15	4000	20

- EN UV LED flashlight and glasses set
- PL Zestaw latarka UV LED i okulary
- DE UV LED Taschenlampe mit UV Schutzbrille
- RU Комплект для проверки утечек хладагента - УФ фонарь с очками
- CZ UV LED svítidla + brýle
- RO Set lanternă LED UV și ochelari
- HU UV LED zseblámpa + szemüveg
- ES UV LED linterna con gafas para

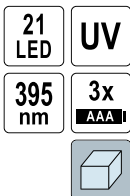

No.	Light source / Źródło światła [LED]	Battery type / Rodzaj baterii	
82756	21	3x1.5V; AAA	80

- EN LED flashlight
- PL Latarka LED
- DE LED Taschenlampe
- RU Светодиодный фонарь
- CZ LED svítidla
- RO Lanternă cu LED
- HU LED zseblámpa
- ES Linterna LED

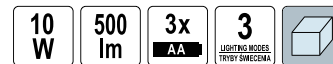

No.	Power / Moc [W]	Battery type / Rodzaj baterii	
88560	10	3x1.5V; AA	12/24



- EN LED flashlight
- PL Latarka LED
- DE LED Taschenlampe
- RU Светодиодный фонарь
- CZ LED svítidla
- RO Lanternă cu LED
- HU LED zseblámpa
- ES Linterna LED



No.	Power / Moc [W]	Battery type / Rodzaj baterii	
88555	5	3x1.5V; AAA	12/48



EN LED headlamp
 PL Latarka czołowa LED
 DE LED Kopflampe
 RU Налобный светодиодный фонарь
 CZ Čelová lampa LED
 RO Lanterna cu LED pt. cap
 HU LED fejlámpa
 ES Lámpara LED de cabeza

3 LIGHTING MODES TRYBY SWIECENIA
 3.7 V 850mAh Li-Ion
 5h
 3W
 130 lm
 4 LED
 160 lm
 USB CABLE KABEL





SMD
 LED
 POWER
 LED



No.		
88677		12/48

EN LED headlamp
 PL Latarka czołowa LED
 DE LED Kopflampe
 RU Налобный светодиодный фонарь
 CZ Čelová lampa LED
 RO Lanterna cu LED pt. cap
 HU LED fejlámpa
 ES Lámpara LED de cabeza

1 LED
 1W
 3 LIGHTING MODES TRYBY SWIECENIA
 3x AAA





POWER
 LED



No.	Battery type / Rodzaj baterii	
88674	3x1.5V; AAA	12/48

EN LED headlamp
 PL Latarka czołowa LED
 DE LED Kopflampe
 RU Налобный светодиодный фонарь
 CZ Čelová lampa LED
 RO Lanterna cu LED pt. cap
 HU LED fejlámpa
 ES Lámpara LED de cabeza

3W
 150 lm
 3x AAA



COB
 LED



No.	Battery type / Rodzaj baterii	
88676	3x1.5V; AAA	12/48

EN LED headlamp
 PL Latarka czołowa LED
 DE LED Kopflampe
 RU Налобный светодиодный фонарь
 CZ Čelová lampa LED
 RO Lanterna cu LED pt. cap
 HU LED fejlámpa
 ES Lámpara LED de cabeza

5 LIGHTING MODES TRYBY SWIECENIA
 3+3 W
 320/200 lm
 150m
 3.7 V 1200mAh Li-Po
 3.5h
 3-8h
 IPX4
 IK06
 USB CABLE KABEL



POWER COB
 LED



No.	Power / Moc [W]	
88681	3 (COB), 3 (POWER)	60/120

EN LED headlamp
 PL Latarka czołowa LED
 DE LED Kopflampe
 RU Налобный светодиодный фонарь
 CZ Čelová lampa LED
 RO Lanterna cu LED pt. cap
 HU LED fejlámpa
 ES Lámpara LED de cabeza

1 LED
 1W
 3 LIGHTING MODES TRYBY SWIECENIA
 3x AAA
 ELASTIC STRAP ELASTYCZNY PASEK





POWER
 LED



No.	Battery type / Rodzaj baterii	
88672	3x1.5V; AAA	12/60

EN LED headlamp
 PL Latarka czołowa LED
 DE LED Kopflampe
 RU Налобный светодиодный фонарь
 CZ Čelová lampa LED
 RO Lanterna cu LED pt. cap
 HU LED fejlámpa
 ES Lámpara LED de cabeza

1+2 LED
 100 lm
 3x AAA





POWER
 LED



No.	Battery type / Rodzaj baterii	
88675	3x1.5V; AAA	12/48

EN LED headlamp
 PL Latarka czołowa LED
 DE LED Kopflampe
 RU Налобный светодиодный фонарь
 CZ Čelová lampa LED
 RO Lanterna cu LED pt. cap
 HU LED fejlámpa
 ES Lámpara LED de cabeza

4 LIGHTING MODES TRYBY SWIECENIA
 5W 2x3W
 430/200 lm
 50m
 3.7 V 1200mAh Li-PO
 3.5-4h
 3-4h
 IP44
 IK06
 USB CABLE KABEL





POWER COB
 LED



No.	Power / Moc [W]	
88680	5 (COB), 3 x2 (POWER)	10/100



- EN LED bike light set
- PL Zestaw lamp rowerowych LED
- DE Fahrrad-Beleuchtungsset LED
- RU Набор светодиодных велосипедных фонарей
- CZ Set LED osvětlení na kolo
- RO Set lanterna bicicleta LED
- HU LED kerékpár lámpa szett
- ES Juego de luces LED para bicicleta

5 LED, 2x AAA, 3W, 150 lm, 3x AAA, ZOOM



POWER LED



No.	Battery type / Rodzaj baterii	
88422	3x1.5V; AAA, 2x1.5V; AAA	12/48

- EN Night lamp with body and light sensor
- PL Lampka nocna z czujnikiem ruchu i zmierzchu
- DE Nachtleuchte mit Bewegungsmelder und Helligkeitssensor
- RU Ночник с датчиком движения и сумеречного света
- CZ Noční lampka se senzorem pohybu a soumraku
- RO Lampa de veghe cu senzor lumina
- HU Mozgás- és szűrőletérzékelős éjjeli lámpa
- ES Luz de noche con sensor de movimiento y crepuscular

1W, 50 lm, 120°, 3m, 3x AAA



SMD LED



No.	Power / Moc [W]	Luminous flux / Strumień świetlny [lm]	
82831	1	50	25/100

- EN Infrared heater
- PL Promiennik podczerwieni
- DE Infrarotstrahler
- RU Инфракрасный обогреватель
- CZ Infrazářič
- RO Încălzitor cu infraroșu
- HU Infravörös melegítő
- ES Radiador infrarrojo

- FEATURES:**
- Remote control
 - LED control panel

- CECHY:**
- Pilot
 - Panel sterowania LED



No.	Power / Moc [W]	
68791	2000	1

- EN Night lamp with body and light sensor
- PL Lampka nocna z czujnikiem ruchu i zmierzchu
- DE Nachtleuchte mit Bewegungsmelder und Helligkeitssensor
- RU Ночник с датчиком движения и сумеречного света
- CZ Noční lampka se senzorem pohybu a soumraku
- RO Lampa de veghe cu senzor lumina
- HU Mozgás- és szűrőletérzékelős éjjeli lámpa
- ES Luz de noche con sensor de movimiento y crepuscular

3W, 120 lm, 120°, 3m, 3x AAA



COB LED



No.	Power / Moc [W]	Luminous flux / Strumień świetlny [lm]	
82830	3	120	25/100

- EN Night lamp with body and light sensor
- PL Lampka nocna z czujnikiem ruchu i zmierzchu
- DE Nachtleuchte mit Bewegungsmelder und Helligkeitssensor
- RU Ночник с датчиком движения и сумеречного света
- CZ Noční lampka se senzorem pohybu a soumraku
- RO Lampa de veghe cu senzor lumina
- HU Mozgás- és szűrőletérzékelős éjjeli lámpa
- ES Luz de noche con sensor de movimiento y crepuscular

1W, 50 lm, 120°, 3.7V 600mAh LiFePO4, 2h, 3h, USB BATTERY CHARGER LADÓKÁRKA

SMD LED



No.	Power / Moc [W]	Luminous flux / Strumień świetlny [lm]	Battery capacity / Pojemność akumulatora [mAh]	
82832	1	50	600	25/100



220-240V~50-60Hz, 2000 W, 25m², 2 s, 5000 h, 3 LIGHTING MODES (PIEBI ŚMIECZKA), CARBON FIBER WŁÓKNO WĘGLOWE, 24h, AI, IP34

EN Infrared heater
 PL Promiennik podczerwieni
 DE Infrarotstrahler
 RU Инфракрасный обогреватель
 CZ Infrazářič
 RO Încălzitor cu infraroșu
 HU Infravörös melegítő
 ES Radiador infrarrojo



220-240V~ 50/60Hz	2000 W
2100 1800 mm	25m²
20 s	5000 h
3 LIGHTING MODES TRYB ŚWIĘCZENIA	QUARTZ KWARCOWY
IP34	1.8 m

LUND

No.	Power / Moc [W]	
68792	2000	1

EN Insect killer lamp with fan
 PL Lampka owadobójcza z wentylatorem
 DE Insektizidlampe mit Ventilator
 RU Инсектицидная лампа с вентилятором
 CZ Lampka na hubení hmyzu s ventilátorem
 RO Lampă împotriva insectelor cu ventilator
 HU Ventilátoros rovarirtó lámpa
 ES Lámpara insecticida con ventilador

5W	UVA LED	365 nm	20000 h
30m²	USB CHARGING ŁADOWANIE	ANTI-SLIP FEET NOŻKI ANTY-POŚLIZGOWE	

FEATURES:
 - Funnel prevents insects from escaping
 - Storage box for insects

CECHY:
 - Lejek zabezpiecza przed ucieczką owadów
 - Pojemnik na owady



LUND

No.	Power / Moc [W]	
67011	5	12

EN Infrared heater
 PL Promiennik podczerwieni
 DE Infrarotstrahler
 RU Инфракрасный обогреватель
 CZ Infrazářič
 RO Încălzitor cu infraroșu
 HU Infravörös melegítő
 ES Radiador infrarrojo



220-240V~ 50-60Hz	2200 W
2100 1800 mm	25m²
20 s	5000 h
3 LIGHTING MODES TRYB ŚWIĘCZENIA	QUARTZ KWARCOWY
IP24	1.8 m

LUND

No.	Power / Moc [W]	
68793	2200	1

EN Insect killer lamp with fan
 PL Lampka owadobójcza z wentylatorem
 DE Insektizidlampe mit Ventilator
 RU Инсектицидная лампа с вентилятором
 CZ Lampka na hubení hmyzu s ventilátorem
 RO Lampă împotriva insectelor cu ventilator
 HU Ventilátoros rovarirtó lámpa
 ES Lámpara insecticida con ventilador

220-240V~ 50Hz	20 W
UVA T5 4W	365 nm
8000 h	25m²
1.1 m	

FEATURES:
 - Flap prevents insects from escaping
 - Storage box for insects
 - Free standing or hanging

CECHY:
 - Klapka zabezpieczająca przed ucieczką owadów
 - Pojemnik na owady
 - Możliwość postawienia lub zawieszenia



LUND

No.	Power / Moc [W]	
67026	20	6

EN Insect killer lamp with fan
 PL Lampa owadobójcza z wentylatorem
 DE Insektizidlampe mit Ventilator
 RU Инсектицидная лампа с вентилятором
 CZ Lampa na hubení hmyzu s ventilátorem
 RO Lampă împotriva insectelor cu ventilator
 HU Ventilátoros rovarirtó lámpa
 ES Lámpara insecticida con ventilador

FEATURES:

- Funnel prevents insects from escaping
- Storage box for insects

CECHY:

- Lejek zabezpiecza przed ucieczką owadów
- Pojemnik na owady



220-240V-50/60Hz	15 W
UVA 56V 7W	365 nm
3000 h	60m ²
1.9 m	



LUND

No.	Power / Moc [W]	
67012	15	6

EN Insect killer lamp with fan
 PL Lampa owadobójcza z wentylatorem
 DE Insektizidlampe mit Ventilator
 RU Инсектицидная лампа с вентилятором
 CZ Lampa na hubení hmyzu s ventilátorem
 RO Lampă împotriva insectelor cu ventilator
 HU Ventilátoros rovarirtó lámpa
 ES Lámpara insecticida con ventilador

FEATURES:

- Funnel prevents insects from escaping
- Storage box for insects
- Water tray
- Light sensor automatically recognize the brightness of natural light to switch ON/OFF
- Free standing or hanging
- Inside and outside use

CECHY:

- Lejek zabezpiecza przed ucieczką owadów
- Pojemnik na owady
- Tacka na wodę
- Czujnik światła automatycznie włącza i wyłącza urządzenie
- Możliwość postawienia lub zawieszenia
- Zastosowanie we wnętrzach i na zewnątrz



220-240V-50/60Hz	15 W
UVA 56V 7W	365 nm
3000 h	300m ²
IPX4	
3 m	



LUND

No.	Power / Moc [W]	
67014	15	2

EN Insect killer lamp UVA
 PL Lampa owadobójcza UVA
 DE UVA-Insektenlampe
 RU Лампа от насекомых УФА
 CZ UVA lampa na hubení hmyzu
 RO Lampă UVA împotriva insectelor
 HU UVA rovarirtó lámpa
 ES Lámpara de UVA insecticida

FEATURES:

- Free standing or hanging

CECHY:

- Możliwość postawienia lub zawieszenia

LUND

No.	Power / Moc [W]	
67033	26	6

EN Insect killer lamp with fan
 PL Lampa owadobójcza z wentylatorem
 DE Insektizidlampe mit Ventilator
 RU Инсектицидная лампа с вентилятором
 CZ Lampa na hubení hmyzu s ventilátorem
 RO Lampă împotriva insectelor cu ventilator
 HU Ventilátoros rovarirtó lámpa
 ES Lámpara insecticida con ventilador

FEATURES:

- Funnel prevents insects from escaping
- Storage box for insects
- Chain 65 cm
- Free standing or hanging
- Inside and outside use

CECHY:

- Lejek zabezpiecza przed ucieczką owadów
- Pojemnik na owady
- Łańcuch 65 cm
- Możliwość postawienia lub zawieszenia
- Zastosowanie we wnętrzach i na zewnątrz



220-240V-50/60Hz	15 W
UVA 56V 7W	365 nm
3000 h	300m ²
IPX4	3 m



LUND

No.	Power / Moc [W]	
67013	15	6

EN Insect killer lamp UVA
 PL Lampa owadobójcza UVA
 DE UVA-Insektenlampe
 RU Лампа от насекомых УФА
 CZ UVA lampa na hubení hmyzu
 RO Lampă UVA împotriva insectelor
 HU UVA rovarirtó lámpa
 ES Lámpara de UVA insecticida

FEATURES:

- Free standing or hanging

CECHY:

- Możliwość postawienia lub zawieszenia

220-240V-50Hz	2300V	17 W	
365 nm	8000 h	30m ²	1 m



LUND

No.	Power / Moc [W]	
67032	17	6

220-240V-50Hz	2300V	26 W		365 nm	8000 h	80m ²	1 m	
---------------	-------	------	--	--------	--------	------------------	-----	--



EN Insect killer lamp UVA
 PL Lampa owadobójcza UVA
 DE UVA-Insektenlampe
 RU Лампа от насекомых УФА
 CZ UVA lampa na hubení hmyzu
 RO Lampă UVA împotriva insectelor
 HU UVA rovarirtó lámpa
 ES Lámpara de UVA insecticida

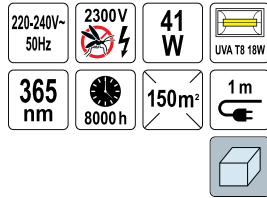

FEATURES:

- Free standing or hanging

CECHY:

- Możliwość postawienia lub zawieszania

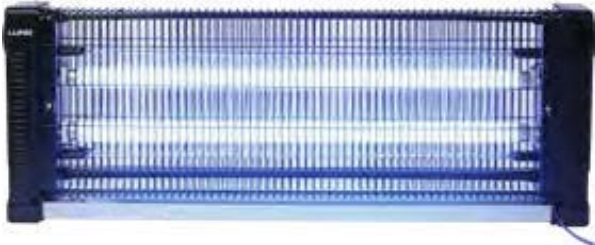

LUND

No.	Power / Moc [W]	
67034	41	4

EN UVA bulb for insect killer lamp
 PL Żarówka UVA do lamp owadobójczych
 DE UVA-Leuchte für Insektenlampen
 RU Лампочка УФА для ламп-убийц
 CZ UVA žárovka do lamp na hubení hmyzu
 RO Bec UVA pt. lampă împotriva insectelor
 HU UVA izzó rovarirtó lámpához
 ES Bombilla de UVA para lámparas insecticidas



LUND

No.	For / Dla	
67019	67012, 67013, 67014	200

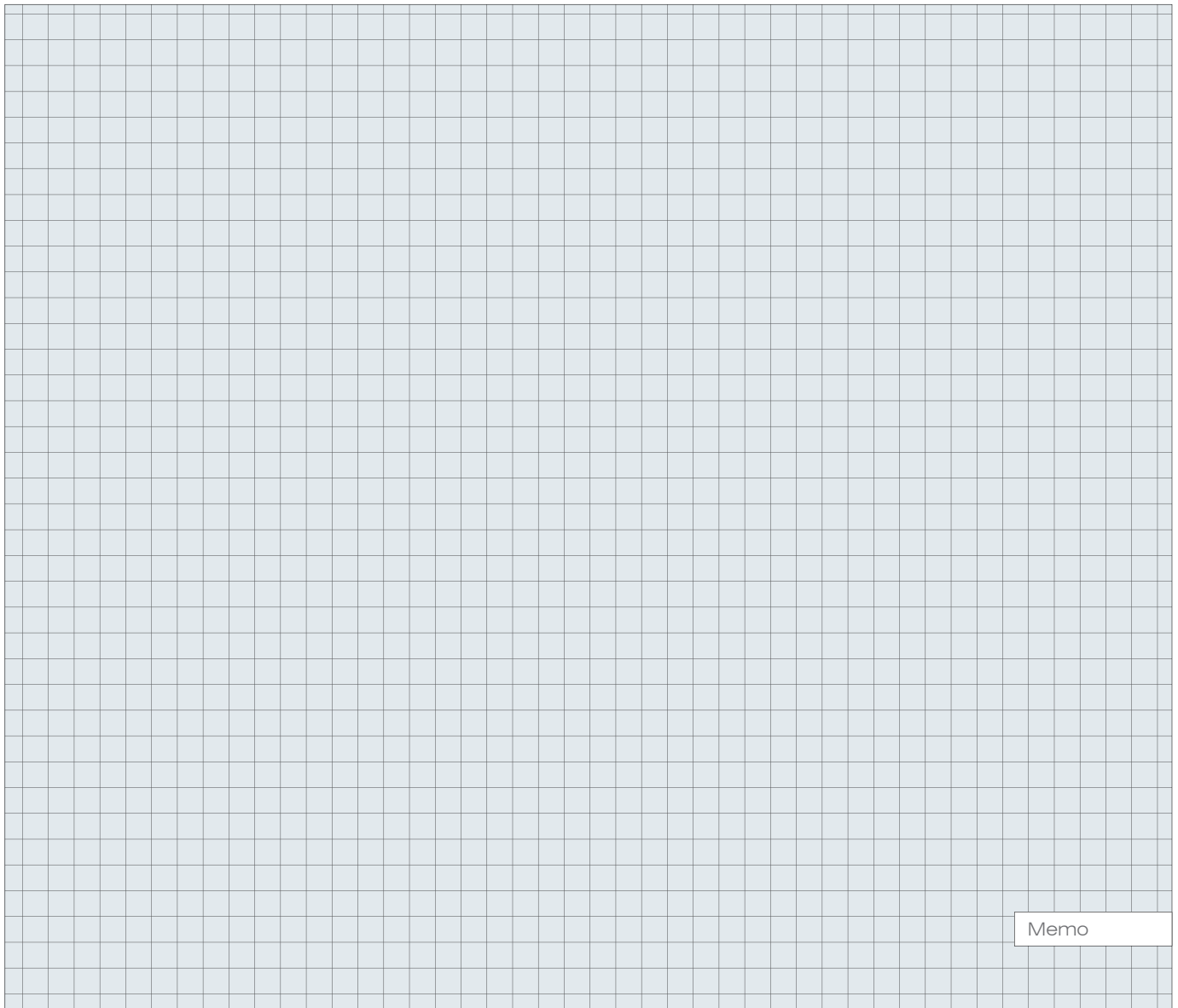

24

Garden tools & power tools Narzędzia i elektronarzędzia ogrodowe



Watering program
Program wodny

390-409

**Hose connectors, male connectors, couplings, hose menders**
Złącza, nypły, łączniki, rozgałęziacze, reparatory..... 390**Hose nozzles (sprinklers) & sets**
Zraszacze i zestawy..... 393**Garden hoses**
Wężę ogrodowe..... 398**Garden hose carts, holders & guides**
Wózki, stojaki i prowadnice do węży..... 400**Pumps**
Pompy..... 400**Irrigation valve boxes**
Skrzynki zaworowe..... 400**PE pipes adapters**
Złączki do rur PE..... 401**Water filters**
Filtry do wody..... 408**Pruners & shears**
Sekatory i nożyce ogrodowe

409-414

**Pruners**
Sekatory..... 409**Lopping shears**
Sekatory do gałęzi..... 412**Leverage tree pruners**
Sekatory gąsienicowe..... 413**Hedge shears**
Nożyce do żywopłotu..... 413**Grass shears**
Nożyce do trawy..... 414**Hand tools**
Narzędzia ręczne

414-431

**Small garden tools**
Małe narzędzia ogrodowe..... 414**Big garden tools**
Duże narzędzia ogrodowe..... 417**Handles**
Trzonki..... 429**Sprayers & accessories**
Opryskiwacze i akcesoria

431-434

**Garden accessories**
Akcesoria ogrodowe

434-444

**BBQ grills & accessories**
Grille i akcesoria

444-457

**Gas BBQ grills**
Grille gazowe..... 444**Charcoal BBQ grills**
Grille węglowe..... 448**Smokers**
Wędzarnie..... 452**Fire pits**
Paleniska ogrodowe..... 453**Accessories**
Akcesoria..... 455

EN Hose connector
 PL Złącze
 DE Schlauchkupplung
 RU Соединитель
 CZ Rychlospojka
 RO Conector
 HU Gyorscsatlakozó
 ES Conector



∅1/2" 12.7mm
 ∅3/4" 19mm
 ABS
 PP



No.	Hose diameter / Šrednica węža	Package	
89221	1/2" (12.7 mm)	✕	150/600
89222	1/2" (12.7 mm)	☑	24/288
89223	3/4" (19.0 mm)	✕	60/240
89224	3/4" (19.0 mm)	☑	24/288

EN Hose connector
 PL Złącze
 DE Schlauchkupplung
 RU Соединитель
 CZ Rychlospojka
 RO Conector
 HU Gyorscsatlakozó
 ES Conector



∅1/2" 12.7mm
 ∅3/4" 19mm
 STOP
 ABS
 PP



No.	Hose diameter / Šrednica węža	Package	
89225	1/2" (12.7 mm)	✕	150/600
89226	1/2" (12.7 mm)	☑	24/288
89227	3/4" (19.0 mm)	✕	60/240
89228	3/4" (19.0 mm)	☑	24/288

EN Brass hose connector
 PL Złącze mosiężne
 DE Schlauch-Schnellkupplung
 RU Быстросъемная муфта
 CZ Rychlospojka
 RO Conector furtun alamă
 HU Csatlakozó
 ES Conexión



∅1/2" 12.7mm
 ∅3/4" 19mm
 BRASS
 MOSIADZ



No.	Hose diameter / Šrednica węža	Package	
89100	1/2" (12.7 mm)		48
89102	3/4" (19.0 mm)		48

EN Hose mender
 PL Reparatör do węža
 DE Schlauchreparatur
 RU Муфта ремонтная для шланга

CZ Hadicová spojka
 RO Mufă îmbinare
 HU Tömítőoldó
 ES Reparador para manguera



No.	Hose diameter / Šrednica węža	Package	
89229	1/2" (12.7 mm)	✕	150/600
89230	1/2" (12.7 mm)	☑	24/288
89231	3/4" (19.0 mm)	✕	60/240
89232	3/4" (19.0 mm)	☑	24/288

EN Hose connector
 PL Złącze
 DE Schlauchkupplung
 RU Соединитель
 CZ Rychlospojka
 RO Conector
 HU Gyorscsatlakozó
 ES Conector



∅1/2" 12.7mm
 ∅3/4" 19mm
 ABS
 PP



No.	Hose diameter / Šrednica węža	
89001	1/2" (12.7 mm)	30/240
89002	3/4" (19.0 mm)	30/240

EN Hose connector
 PL Złącze
 DE Schlauchkupplung
 RU Соединитель
 CZ Rychlospojka
 RO Conector
 HU Gyorscsatlakozó
 ES Conector



∅1/2" 12.7mm
 ∅3/4" 19mm
 STOP
 ABS
 PP



No.	Hose diameter / Šrednica węža	
89003	1/2" (12.7 mm)	30/240
89004	3/4" (19.0 mm)	30/240

EN Brass hose connector
 PL Złącze mosiężne
 DE Schlauch-Schnellkupplung
 RU Быстросъемная муфта
 CZ Rychlospojka
 RO Conector furtun alamă cu stop
 HU Csatlakozó
 ES Conexión



∅1/2" 12.7mm
 ∅3/4" 19mm
 STOP
 BRASS
 MOSIADZ



No.	Hose diameter / Šrednica węža	Package	
89101	1/2" (12.7 mm)		48
89103	3/4" (19.0 mm)		48

∅1/2" 12.7mm
 ∅3/4" 19mm
 ABS
 PP



EN Hose mender
 PL Reparatör do węża
 DE Schlauchreparator
 RU Муфта ремонтная для шланга
 CZ Hadicová spojka
 RO Mufă îmbinare
 HU Tömítőoldó
 ES Reparatör para manguera



No.	Hose diameter / Średnica węża	Package
89007	1/2" (12.7 mm)	30/240
89008	3/4" (19.0 mm)	30/240

EN Hose reducer
 PL Reparatör redukcyjny do węża
 DE Reparaturstück mit Reduzierung
 RU Редуктор для шланга
 CZ Hadicová redukční spojka
 RO Mufă îmbinare
 HU Tömítő öszekötő
 ES Reductor de manguera

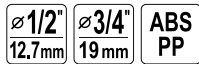

No.	Hose diameter / Średnica węża	Package
89233	1/2" (12.7 mm), 3/4" (19.0 mm)	60/240
89234	1/2" (12.7 mm), 3/4" (19.0 mm)	24/288

EN Tap adaptor
 PL Przyłącze do kranu
 DE Wasserhahnanschluss
 RU Адаптер для крана
 CZ Kohoutkový adaptér
 RO Adaptör robinet
 HU Csapcsatlakozó
 ES Conexión de grifo



No.	Package
89253	24/240

EN Tap adaptor
 PL Przyłącze do kranu
 DE Wasserhahnanschluss
 RU Адаптер для крана
 CZ Kohoutkový adaptér
 RO Adaptör robinet
 HU Csapcsatlakozó
 ES Conexión de grifo



No.	Connector thread size / Rozmiar gwintu przyłącza	Package
89015	G3/4	30/240

EN Hose mender
 PL Reparatör do węża
 DE Schlauchreparator
 RU Муфта ремонтная для шланга
 CZ Hadicová spojka
 RO Mufă îmbinare
 HU Tömítőoldó
 ES Reparatör para manguera



No.	Hose diameter / Średnica węża	Package
89104	1/2" (12.7 mm)	48
89105	3/4" (19.0 mm)	48

EN Hose reducer
 PL Reparatör redukcyjny do węża
 DE Reparaturstück mit Reduzierung
 RU Редуктор для шланга
 CZ Hadicová redukční spojka
 RO Mufă îmbinare
 HU Tömítő öszekötő
 ES Reductor de manguera

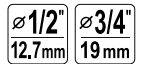

No.	Hose diameter / Średnica węża	Package
89011	1/2" (12.7 mm), 3/4" (19.0 mm)	30/240

EN Tap adaptor
 PL Przyłącze do kranu
 DE Wasserhahnanschluss
 RU Адаптер для крана
 CZ Kohoutkový adaptér
 RO Adaptör robinet
 HU Csapcsatlakozó
 ES Conexión de grifo



No.	Connector thread size / Rozmiar gwintu przyłącza	Package
89239	G3/4	250/1000
89240	G3/4	24/288

EN Tap adaptor
 PL Przyłącze do kranu
 DE Wasserhahnanschluss
 RU Адаптер для крана
 CZ Kohoutkový adaptér
 RO Adaptör robinet
 HU Csapcsatlakozó
 ES Conexión de grifo



No.	Connector thread size / Rozmiar gwintu przyłącza	Package
89110	G3/4	48

EN Tap adaptor
 PL Przyłącze do kranu
 DE Wasserhahnanschluss
 RU Адаптер для крана
 CZ Kohoutkový adaptér
 RO Adaptor robinet
 HU Csapcsatlakozó
 ES Conexión de grifo

(F) G3/4 ABS



No.	Connector thread size / Rozmiar gwintu przyłącza	Package	
89235	G3/4		250/1000
89236	G3/4		24/288

EN Tap adaptor
 PL Przyłącze do kranu
 DE Wasserhahnanschluss
 RU Адаптер для крана
 CZ Kohoutkový adaptér
 RO Adaptor robinet
 HU Csapcsatlakozó
 ES Conexión de grifo

(F) G3/4 (F) G1 BRASS MOSIADZ



No.	Connector thread size / Rozmiar gwintu przyłącza	
89106	G3/4	48
89107	G1	48

EN Tap adaptor
 PL Przyłącze do kranu
 DE Wasserhahnanschluss
 RU Адаптер для крана
 CZ Kohoutkový adaptér
 RO Adaptor robinet
 HU Csapcsatlakozó
 ES Conexión de grifo

(F) G1/2 (F) G3/4 (F) G1 ABS



No.	Connector thread size / Rozmiar gwintu przyłącza	
89017	G1/2, G3/4	30/240
89018	G3/4, G1	30/240

EN Hose coupling
 PL Łącznik
 DE Schlauchkupplung
 RU Соединитель
 CZ Spojka
 RO Racord
 HU Tömlőcsatlakozás
 ES Acoplador

ABS



No.	Water outlet diameter / Średnica przyłącza wody	Package	
89245	1/2" (12.7 mm)		125/500
89246	1/2" (12.7 mm)		24/288

EN Tap adaptor
 PL Przyłącze do kranu
 DE Wasserhahnanschluss
 RU Адаптер для крана
 CZ Kohoutkový adaptér
 RO Adaptor robinet
 HU Csapcsatlakozó
 ES Conexión de grifo

(F) G3/4 ABS



No.	Connector thread size / Rozmiar gwintu przyłącza	
89013	G3/4	30/240

EN Tap adaptor
 PL Przyłącze do kranu
 DE Wasserhahnanschluss
 RU Адаптер для крана
 CZ Kohoutkový adaptér
 RO Adaptor robinet
 HU Csapcsatlakozó
 ES Conexión de grifo

(F) G1/2 (F) G3/4 (F) G1 ABS



No.	Connector thread size / Rozmiar gwintu przyłącza	Package	
89241	G1/2, G3/4		250/1000
89242	G1/2, G3/4		24/288
89251	G3/4, G1		100/1000
89252	G3/4, G1		24/288

EN Tap adaptor
 PL Przyłącze do kranu
 DE Wasserhahnanschluss
 RU Адаптер для крана
 CZ Kohoutkový adaptér
 RO Adaptor robinet
 HU Csapcsatlakozó
 ES Conexión de grifo

(F) G1/2 (F) G3/4 (F) G1 BRASS MOSIADZ



No.	Connector thread size / Rozmiar gwintu przyłącza	
89108	G1/2, G3/4	48
89109	G3/4, G1	48

EN Hose coupling
 PL Łącznik
 DE Schlauchkupplung
 RU Соединитель
 CZ Spojka
 RO Racord
 HU Tömlőcsatlakozás
 ES Acoplador

ABS



No.		
89020		30/240

EN Hose coupling
 PL Łącznik
 DE Schlauchkupplung
 RU Соединитель
 CZ Spojka
 RO Racord
 HU Tömlőcsatlakozás
 ES Acoplador



No.	Package
89113	48

EN Y-switch coupling with swivel
 PL Rozdzielacz z zaworami
 DE 2-Wege Ventil
 RU Распределитель внешний
 CZ Rozbočovač s uzavíracími ventily
 RO Racord tip "Y" cu robinet
 HU Y-elágazó, 2 db elzáróval
 ES Distribuidor tipo „Y”



No.	Connector thread size / Rozmiar gwintu przyłącza	Package
89247	G3/4	24/240
89248	G3/4	12/96

EN Adjustable spray nozzle
 PL Zraszacz prosty regulowany
 DE Einstellbare Spritze
 RU Поливочный регулируемый наконечник
 CZ Postřikovač nastavitelný
 RO Duză de stropit
 HU Egyszerű szabályozható szórófej
 ES Rociador de pico ajustable



No.	Package
89201	25/100
89202	12/120

EN Adjustable spray nozzle
 PL Zraszacz prosty regulowany
 DE Einstellbare Spritze
 RU Распылитель поливочный
 CZ Postřikovač nastavitelný
 RO Duză de stropit
 HU Egyszerű szabályozható szórófej
 ES Rociador de pico ajustable



No.	Package
89187	48

EN Hose coupling
 PL Rozdzielacz
 DE Wasserverteiler
 RU Тройник-соединитель
 CZ Rozdělovač
 RO Racord 3 căi
 HU Vízelosztó
 ES Divisor de manguera



No.	Package
89243	125/250
89244	24/288

EN Y-switch coupling with swivel
 PL Rozdzielacz z zaworami
 DE 2-Wege Ventil
 RU Распределитель внешний
 CZ Rozbočovač s uzavíracími ventily
 RO Racord tip "Y" cu robinet
 HU Y-elágazó, 2 db elzáróval
 ES Distribuidor tipo „Y”



No.	Connector thread size / Rozmiar gwintu przyłącza	Package
89022	G1/2, G3/4	12/120

EN Adjustable spray nozzle
 PL Zraszacz prosty regulowany
 DE Einstellbare Spritze
 RU Поливочный регулируемый наконечник
 CZ Postřikovač nastavitelný
 RO Duză de stropit
 HU Egyszerű szabályozható szórófej
 ES Rociador de pico ajustable



No.	Package
89200	25/200

EN Straight nozzle
 PL Zraszacz prosty
 DE Spritze
 RU Распылитель поливочный
 CZ Postřikovač
 RO Duză de stropit
 HU Szórófej
 ES Rociador simple



No.	Package
89120	48

EN Adjustable spray gun
 PL Pistolet zraszający regulowany
 DE Regelbare Sprühpistole
 RU Регулируемый оросительный пистолет
 CZ Kropící pistole regulovatelná
 RO Pistol de stropit reglabil
 HU Öntöző pisztoly állítható sugarú
 ES Pistola rociadora ajustable

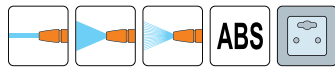

FLO

No.	12/48
89210	

EN Adjustable spray gun
 PL Pistolet zraszający regulowany
 DE Regelbare Sprühpistole
 RU Регулируемый оросительный пистолет
 CZ Kropící pistole regulovatelná
 RO Pistol de stropit reglabil
 HU Öntöző pisztoly állítható sugarú
 ES Pistola rociadora ajustable

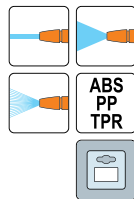

FLO

No.	12/48
89214	

EN Adjustable spray gun
 PL Pistolet zraszający regulowany
 DE Regelbare Sprühpistole
 RU Регулируемый оросительный пистолет
 CZ Kropící pistole regulovatelná
 RO Pistol de stropit reglabil
 HU Öntöző pisztoly állítható sugarú
 ES Pistola rociadora ajustable

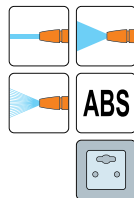

FLO

No.	12/48
89193	

EN Adjustable spray gun
 PL Pistolet zraszający regulowany
 DE Regelbare Sprühpistole
 RU Регулируемый оросительный пистолет
 CZ Kropící pistole regulovatelná
 RO Pistol de stropit reglabil
 HU Öntöző pisztoly állítható sugarú
 ES Pistola rociadora ajustable



FLO

No.	12/24
89215	

EN Adjustable spray gun
 PL Pistolet zraszający regulowany
 DE Regelbare Sprühpistole
 RU Регулируемый оросительный пистолет
 CZ Kropící pistole regulovatelná
 RO Pistol de stropit reglabil
 HU Öntöző pisztoly állítható sugarú
 ES Pistola rociadora ajustable

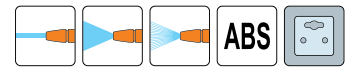

FLO

No.	12/48
89213	

EN Adjustable spray gun
 PL Pistolet zraszający regulowany
 DE Regelbare Sprühpistole
 RU Регулируемый оросительный пистолет
 CZ Kropící pistole regulovatelná
 RO Pistol de stropit reglabil
 HU Öntöző pisztoly állítható sugarú
 ES Pistola rociadora ajustable

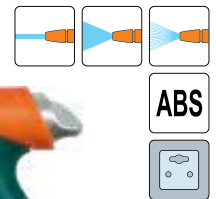

FLO

No.	12/48
89189	

EN Adjustable spray gun
 PL Pistolet zraszający regulowany
 DE Regelbare Sprühpistole
 RU Регулируемый оросительный пистолет
 CZ Kropící pistole regulovatelná
 RO Pistol de stropit reglabil
 HU Öntöző pisztoly állítható sugarú
 ES Pistola rociadora ajustable

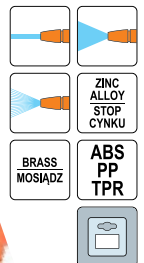

FLO

No.	12/48
89190	

EN Sprinkling gun
 PL Pistolet zraszający
 DE Spritzpistole
 RU Оросительный пистолет
 CZ Postřikovací pistole
 RO Pistol de stropit
 HU Öntöző pisztoly
 ES Pistola para regar



FLO

No.	12/48
89209	

EN Multifunction sprinkling gun
 PL Wielofunkcyjny pistolet zraszający
 DE Multifunktions-Spritzpistole
 RU Многофункциональный оросительный пистолет
 CZ Multifunkční postřikovací pistole
 RO Pistol de stropit
 HU Többfunkciós öntöző pisztoly
 ES Pistola para regar multifuncional

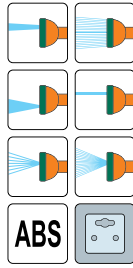

No.	
89220	12/48

EN Multifunction sprinkling gun
 PL Wielofunkcyjny pistolet zraszający
 DE Multifunktions-Spritzpistole
 RU Многофункциональный оросительный пистолет
 CZ Multifunkční postřikovací pistole
 RO Pistol de stropit
 HU Többfunkciós öntöző pisztoly
 ES Pistola para regar multifuncional

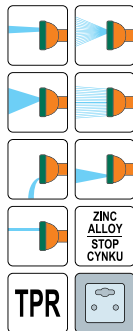

No.	
89192	12/48

EN Multifunction sprinkling gun
 PL Wielofunkcyjny pistolet zraszający
 DE Multifunktions-Spritzpistole
 RU Многофункциональный оросительный пистолет
 CZ Multifunkční postřikovací pistole
 RO Pistol de stropit
 HU Többfunkciós öntöző pisztoly
 ES Pistola para regar multifuncional

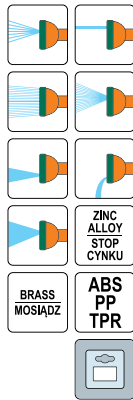

No.	
89191	12/48

EN Basic hose set with adjustable spray gun
 PL Zestaw złączek ze zraszaczem pistoletowym
 DE Spritzbrause und Anschlusset
 RU Набор поливочный
 CZ Rozprašovací pistole na vodu + spojky
 RO Pistol reglabil cu și accesorii
 HU Részecs készlet – os tömlőhöz
 ES Juego de rociar para manguera

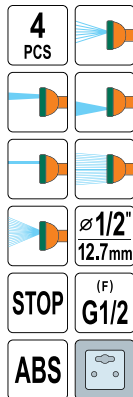

No.	Hose diameter / Šrednica węža	Connector thread size / Rozmiar gwintu przyłącza	pcs / szt.	
89206	1/2" (12.7 mm)	G1/2	4	12/48

EN Multifunction sprinkling gun
 PL Wielofunkcyjny pistolet zraszający
 DE Multifunktions-Spritzpistole
 RU Многофункциональный оросительный пистолет
 CZ Multifunkční postřikovací pistole
 RO Pistol de stropit
 HU Többfunkciós öntöző pisztoly
 ES Pistola para regar multifuncional

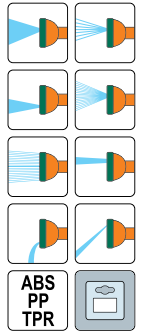

No.	
89211	12/48

EN Multifunction sprinkling gun
 PL Wielofunkcyjny pistolet zraszający
 DE Multifunktions-Spritzpistole
 RU Многофункциональный оросительный пистолет
 CZ Multifunkční postřikovací pistole
 RO Pistol de stropit
 HU Többfunkciós öntöző pisztoly
 ES Pistola para regar multifuncional



No.	
89195	6/24

EN Basic hose set with straight nozzle
 PL Zestaw złączek ze zraszaczem prostym
 DE Bewässerungs Spritz und Anschlusset
 RU Набор поливочный
 CZ Sada postřikovač a spojky
 RO Șut furtun apă cu accesorii pt. robinet
 HU Készlet gyorskapocsos csaphoz
 ES Juego de rociar tubuladura de grifo

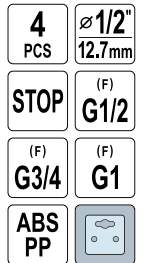

No.	Hose diameter / Šrednica węža	Connector thread size / Rozmiar gwintu przyłącza	pcs / szt.	
89203	1/2" (12.7 mm)	G3/4, G1	4	12/72
89204	1/2" (12.7 mm)	G1/2, G3/4	4	12/72

EN Basic hose set with adjustable spray gun
 PL Zestaw złączek ze zraszaczem pistoletowym
 DE Spritzbrause und Anschlusset
 RU Набор поливочный
 CZ Rozprašovací pistole na vodu + spojky
 RO Pistol reglabil cu și accesorii
 HU Részecs készlet – os tömlőhöz
 ES Juego de rociar para manguera

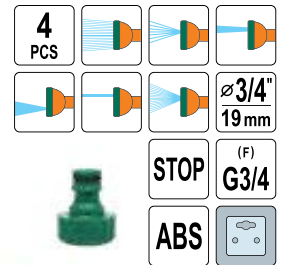

No.	Hose diameter / Šrednica węža	Connector thread size / Rozmiar gwintu przyłącza	pcs / szt.	
89207	3/4" (19.0 mm)	G3/4	4	12/48

EN Basic hose set with adjustable spray gun
 PL Zestaw złączek ze zraszaczem pistoletowym
 DE Spritzbrause und Anschlusset
 RU Набор поливочный
 CZ Rozprašovací pistole na vodu + spojky
 RO Pistol reglabil cu și accesorii
 HU Részcs készlet – os tömlőhöz
 ES Juego de rociar para manguera

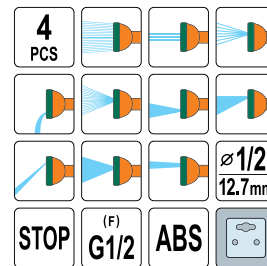

No.	Hose diameter / Średnica węży	Connector thread size / Rozmiar gwintu przyłącza	pcs / szt.	
89208	1/2" (12.7 mm)	G1/2	4	12/48

EN Coil hose set with spray gun
 PL Wąż spiralny z pistoletem zraszającym
 DE Spiralschlauch mit Multifunktionsbrause
 RU Спиральный шланг в наборе с пистолетом
 CZ Pištol striekacia s vinutou hadicou
 RO Furtun spirala cu pistol pt. stropit
 HU Locsoló pisztoly tömlővel
 ES Manguera espiral con rociador



No.	Hose length / Długość węży [m]	
89351	15	8

EN Sprinkling lance
 PL Lanza zraszająca wielofunkcyjna
 DE Multifunktions-Spritzstab
 RU Пика для распылителя многофункциональная
 CZ Multifunkční postřikovací nadstavec
 RO Pistol de stropit cu lance
 HU Többfunkciós esőztető fej
 ES Lanza para regar multifuncional

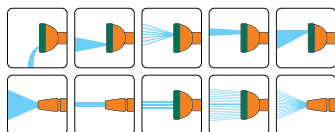

No.	
89218	12

EN 3-arms revolving sprinkler
 PL Zraszacz 3-ramienny
 DE 3-Arm Kreis-Regner
 RU Трехсторонний распылитель
 CZ Rozprašovač třiramenný
 RO Aspersor cu 3 brațe
 HU Forgó locsoló leszűrhető
 ES Rociador 3-brazos



No.	
89272	12/48

EN Garden shower
 PL Prysznik ogrodowy
 DE Gartendusche
 RU Распылитель садовый
 CZ Zahradní sprcha
 RO Duș pt. grădina
 HU Kerti zuhany
 ES Regadera para jardín



No.	
89390	6

EN 3-arms revolving sprinkler
 PL Zraszacz 3-ramienny
 DE 3-Arm Kreis-Regner
 RU Трехсторонний распылитель
 CZ Rozprašovač třiramenný
 RO Aspersor cu 3 brațe
 HU Forgó locsoló leszűrhető
 ES Rociador 3-brazos



No.	
89263	12/48

EN Impulse sprinkler
 PL Zraszacz impulsowy
 DE Impulssprenger
 RU Распылитель импульсный на пике
 CZ Postřikovač
 RO Aspersor cu impuls
 HU Impulzus szórófej
 ES Rociador

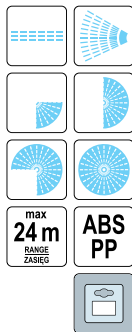

EN Impulse sprinkler
 PL Zraszacz impulsowy
 DE Impulssprenger
 RU Распылитель импульсный на пике
 CZ Postřikovač
 RO Aspersor cu impuls
 HU Impulzus szórófej
 ES Rociador

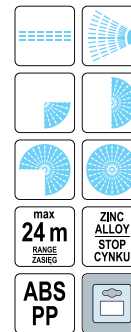

FLO

No.	89269	12/48
-----	-------	-------

FLO

No.	89259	48
-----	-------	----

EN Impulse sprinkler
 PL Zraszacz impulsowy
 DE Impulssprenger
 RU Распылитель импульсный на пике
 CZ Postřikovač
 RO Aspersor cu impuls
 HU Impulzus szórófej
 ES Rociador

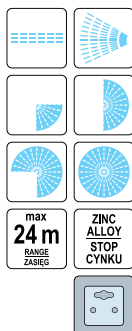

EN Sprinkler
 PL Zraszacz szpilkowy
 DE Sprenger
 RU Дождеватель
 CZ Kolkový zavlažovač
 RO Aspersor
 HU Esőztető
 ES Aspersor

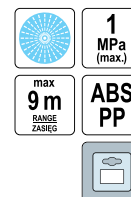

FLO

No.	89260	12/48
-----	-------	-------

FLO

No.	89257	20/120
-----	-------	--------

EN Impulse sprinkler
 PL Zraszacz impulsowy
 DE Impulssprenger
 RU Распылитель импульсный на пике
 CZ Postřikovač
 RO Aspersor cu impuls
 HU Impulzus szórófej
 ES Rociador



EN Swing joint
 PL Łącznik elastyczny do zraszaczy
 DE Regneranschluss für Sprinkler
 RU Гибкий соединитель для оросителя
 CZ Elastická spojka do postřikovačů
 RO Legătură flexibilă pt. aspersor
 HU Rugalmas locsoló összekötő
 ES Conector flexible para aspersor

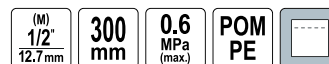

FLO

No.	89275	48
-----	-------	----

FLO

No.	Connector thread size / Rozmiar gwintu przyłącza	100
88925	G1/2 (M)	

EN Oscillating sprinkler
 PL Zraszacz oscylacyjny
 DE Rechteckregner
 RU Распылитель осциллирующий
 CZ Obdélníkový zavlažovač
 RO Aspersor oscilant
 HU Oszillációs szórófej
 ES Aspersor oscilante

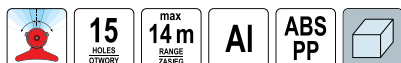

FLO

No.	89277	12
-----	-------	----

EN Impulse pop-up sprinkler
 PL Zraszacz wynurzalny
 DE Tauchimpulssprinkler
 RU Дождеватель выдвжной
 CZ Zavlažovač výsuvný
 RO Aspersor cu impuls
 HU Esőztető szórófej
 ES Rociador de emerjer



FLO

No.	89280	12
-----	-------	----

EN Pop-up sprinkler
 PL Zraszacz wynurzalny
 DE Auftauch-Sprinkler
 RU Выдвижной спринклер
 CZ Výsuvný zavlažovač
 RO Aspersor pop-up
 HU Süllyesztett öntözőfej
 ES Aspersor emergente



(F) max 8m RANGE ZASIEG
 ABS POM PE



No.	
89162	100

EN Pop-up sprinkler
 PL Zraszacz wynurzalny
 DE Auftauch-Sprinkler
 RU Выдвижной спринклер
 CZ Výsuvný zavlažovač
 RO Aspersor pop-up
 HU Süllyesztett öntözőfej
 ES Aspersor emergente



(F) G1/2



No.	
89164	50

EN Nozzle for pop-up sprinkler
 PL Głowica zraszacza
 DE Sprinklerkopf
 RU Спринклерная головка
 CZ Zavlažovací hlavice
 RO Duză pt. aspersor subteran
 HU Öntözőfej
 ES Cabez de aspersor



max 4.2m RANGE ZASIEG SS STAINLESS STEEL STAL NIERDZEWNA
 POM



No.	
89166	30/1200

EN Garden hose
 PL Wąż ogrodowy
 DE Gartenschlauch
 RU Поливочный шланг
 CZ Zahradní hadice
 RO Furtun de grădină
 HU Kerti tömlő
 ES Manguera de jardín



No.	L [m]	Diameter / Średnica	
89302	20	1/2" (12.7 mm)	1
89303	30	1/2" (12.7 mm)	1
89305	50	1/2" (12.7 mm)	1
89307	20	3/4" (19.0 mm)	1
89308	30	3/4" (19.0 mm)	1
89310	50	3/4" (19.0 mm)	1
89298	20	1" (25.0 mm)	1
89299	30	1" (25.0 mm)	1
89300	50	1" (25.0 mm)	1

EN Pop-up sprinkler
 PL Zraszacz wynurzalny
 DE Auftauch-Sprinkler
 RU Выдвижной спринклер
 CZ Výsuvný zavlažovač
 RO Aspersor pop-up
 HU Süllyesztett öntözőfej
 ES Aspersor emergente



(F) G1/2



No.	
89163	100

EN Nozzle for pop-up sprinkler
 PL Głowica zraszacza
 DE Sprinklerkopf
 RU Спринклерная головка
 CZ Zavlažovací hlavice
 RO Duză pt. aspersor subteran
 HU Öntözőfej
 ES Cabez de aspersor



max 5.2m RANGE ZASIEG SS STAINLESS STEEL STAL NIERDZEWNA
 POM



No.	
89165	30/1200

EN Nozzle for pop-up sprinkler
 PL Głowica zraszacza
 DE Sprinklerkopf
 RU Спринклерная головка
 CZ Zavlažovací hlavice
 RO Duză pt. aspersor subteran
 HU Öntözőfej
 ES Cabez de aspersor



max 3m RANGE ZASIEG SS STAINLESS STEEL STAL NIERDZEWNA
 POM



No.	
89167	30/1200

8 bar 15 bar 100% PNEUMATICALLY TESTED
 -5°C +50°C Juv



EN Garden hose
 PL Wąż ogrodowy
 DE Gartenschlauch
 RU Поливочный шланг
 CZ Zahradní hadice
 RO Furtun de grădină
 HU Kerti tömlő
 ES Manguera de jardín

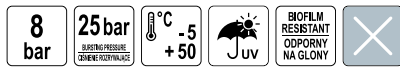

No.	L [m]	Diameter / Šrednica	
89311	20	1/2" (12.7 mm)	1
89312	30	1/2" (12.7 mm)	1
89313	50	1/2" (12.7 mm)	1
89314	20	3/4" (19.0 mm)	1
89315	30	3/4" (19.0 mm)	1
89316	50	3/4" (19.0 mm)	1
89318	20	1" (25.0 mm)	1
89319	30	1" (25.0 mm)	1
89320	50	1" (25.0 mm)	1

EN Garden hose
 PL Wąż ogrodowy
 DE Gartenschlauch
 RU Поливочный шланг
 CZ Zahradní hadice
 RO Furtun de grădină
 HU Kerti tömlő
 ES Manguera de jardín

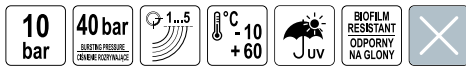

No.	L [m]	Diameter / Šrednica	
89380	15	1/2" (12.7 mm)	1
89381	25	1/2" (12.7 mm)	1
89382	35	1/2" (12.7 mm)	1
89383	45	1/2" (12.7 mm)	1
89384	15	3/4" (19.0 mm)	1
89385	25	3/4" (19.0 mm)	1
89386	35	3/4" (19.0 mm)	1
89387	45	3/4" (19.0 mm)	1

EN Drip hose
 PL Wąż kropłujący
 DE Tropfschlauch
 RU Капельный шланг
 CZ Kapačí hadice
 RO Furtun cu picurător
 HU Locsolótömlő
 ES Manguera de goteo

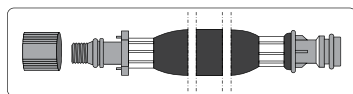
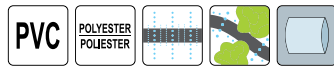

No.	L [m]	
89370	7.5	32
89371	15.0	15
89372	22.5	12
89373	30.0	8

EN Garden hose
 PL Wąż ogrodowy
 DE Gartenschlauch
 RU Поливочный шланг
 CZ Zahradní hadice
 RO Furtun de grădină
 HU Kerti tömlő
 ES Manguera de jardín

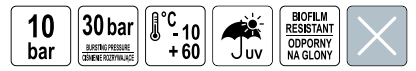

No.	L [m]	Diameter / Šrednica	
89290	20	1/2" (12.7 mm)	1
89291	30	1/2" (12.7 mm)	1
89292	50	1/2" (12.7 mm)	1
89293	20	3/4" (19.0 mm)	1
89294	30	3/4" (19.0 mm)	1
89295	50	3/4" (19.0 mm)	1

EN Soaker hose
 PL Wąż zraszający
 DE Einweichen Schlauch
 RU Спринклерный шланг
 CZ Hádiový zavlažovač
 RO Furtun perforat tip aspersor
 HU Esőztetőtömlő
 ES Manguera de remojo

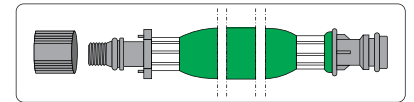
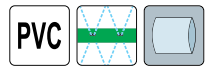

No.	L [m]	
89360	7.5	32
89361	15.0	15

EN Drain hose
 PL Wąż odpływowy
 DE Abflussschlauch
 RU Сливной шланг
 CZ Vyušťovací hadice
 RO Furtun de evacurare
 HU Vízvezető tömlő
 ES Manguera de desagüe



No.	L [m]	Diameter / Šrednica	Wall thickness / Grubość ścianki [mm]	
79960	10	1" (25.0 mm)	1.2	15
79962	20	1" (25.0 mm)	1.2	8
79963	30	1" (25.0 mm)	1.2	6
79965	50	1" (25.0 mm)	1.2	3
79968	20	1-1/4" (32.0 mm)	1.4	6
79971	50	1-1/4" (32.0 mm)	1.4	3

EN Hose holder
 PL Stojak do węży ogrodowego
 DE Gartenschlauchträger
 RU Барабан для намотки поливочного шланга
 CZ Stojan navijeci na zahradní hadici
 RO Suport pt. furtun de grădină
 HU Utartódob locsolótömlőhöz
 ES Estante para manguera de jardín

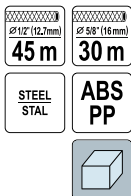

No. 89330  5

EN Hose holder
 PL Stojak do węży ogrodowego
 DE Gartenschlauchträger
 RU Барабан для намотки поливочного шланга
 CZ Stojan navijeci na zahradní hadici
 RO Suport pt. furtun de grădină
 HU Utartódob locsolótömlőhöz
 ES Estante para manguera de jardín

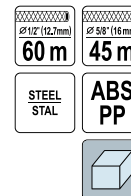

No. 89331  5

EN Hose cart
 PL Wózek do węży ogrodowego
 DE Gartenschlauchwagen
 RU Барабан для намотки поливочного шланга
 CZ Stojan navijeci na zahradní hadici
 RO Suport pt. furtun de grădină
 HU Utartódob locsolótömlőhöz
 ES Carretilla para manguera de jardín

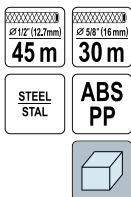

No. 89335  5

EN Hose cart
 PL Wózek do węży ogrodowego
 DE Gartenschlauchwagen
 RU Барабан для намотки поливочного шланга
 CZ Stojan navijeci na zahradní hadici
 RO Suport pt. furtun de grădină
 HU Utartódob locsolótömlőhöz
 ES Carretilla para manguera de jardín

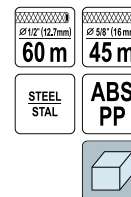

No. 89336  5

EN Hose hanger
 PL Wieszak na wąż ogrodowy
 DE Gartenschlauchträger
 RU Кронштейн настенный для шланга
 CZ Věšák na hadici zahradní
 RO Suport de perete pt. furtunde grădină
 HU Kertitömlő-akasztó
 ES Colgador para manguera de jardín



No. 89345  60

EN Hand pump
 PL Pompa ręczna
 DE Schwengepumpe
 RU Насос ручной
 CZ Pumpa ruční
 RO Pompa manuala
 HU Kézi szivattyú
 ES Bomba de mano



EN Pump base
 PL Podstawa pod pompę
 DE Pumpenständer
 RU Подставка для насоса
 CZ Podstavec pumpy
 RO Suport pt. pompa
 HU Szivattyútálp
 ES Soporite para bomba



EN Round irrigation valve box
 PL Okrągła skrzynka zaworowa ogrodowa
 DE Rundes Gartenventilgehäuse
 RU Круглый садовый вентиляный ящик
 CZ Kulatý zahradní ventilyový box
 RO Cutie rotundă pt. electrovalve
 HU Kerek kerti szelepdoboz
 ES Caja redonda para válvulas, jardín



No. 89552  1



No. 89553 For / Dia 89552  1



No. 88780  10

EN Irrigation valve box
 PL Skrzynka zaworowa ogrodowa
 DE Gartenventilgehäuse
 RU Садовый вентиляный ящик
 CZ Zahradní ventiliový box
 RO Cutie protecție electrovalve
 HU Kerti szelepdoboz
 ES Caja para válvulas, jardín

420x290
 520x390
 x320(H)
 mm



No.

88783



4

EN Irrigation valve box
 PL Skrzynka zaworowa ogrodowa
 DE Gartenventilgehäuse
 RU Садовый вентиляный ящик
 CZ Zahradní ventiliový box
 RO Cutie protecție electrovalve
 HU Kerti szelepdoboz
 ES Caja para válvulas, jardín

550x390
 650x500
 x320(H)
 mm



No.

88784



2

EN Quick coupler valve
 PL Zawór szybkozłączny
 DE Schnellkupplungsventil
 RU Клапан быстрого соединения
 CZ Rychloupínací ventil
 RO Valvă conectare rapidă
 HU Gyorscsatlakozó szelep
 ES Válvula de conexión rápida



(F)
 1
 25mm

QUICK
 RELEASE
 SZYBKO-
 ZŁĄCZE

WATER
 STOP VALVE
 ZAWÓR
 ODCINAJĄCY
 WODĘ

POM



No.

88926

Connector thread size / Rozmiar gwintu przyłącza

G1 (F)



40/80

EN Quick coupler valve key
 PL Klucz do zaworu szybkozłącznego
 DE Schlüssel für Schnellkupplungsventil
 RU Ключ для клапана быстрого соединения
 CZ Klíč rychloupínacího ventilu
 RO Cheie pt. valvă conectare rapidă
 HU Kulcs gyorscsatlakozó szelephez
 ES Llave para la válvula de conexión rápida



(M)
 3/4"
 19mm

QUICK
 RELEASE
 SZYBKO-
 ZŁĄCZE

POM



No.

88927

Connector thread size / Rozmiar gwintu przyłącza

G3/4 (M)



40/160

EN Adapter
 PL Złączka do rur
 DE Rohrverbindung
 RU Ниппель для труб
 CZ Trubková spojka
 RO Racord compresiune
 HU Csatlakozó csőhöz
 ES Conector de tubos



(M)
 G1 1/4

Ø
 32
 mm

1
 MPa
 (max.)

PP



No.

88897

Connector thread size / Rozmiar gwintu przyłącza / Średnica przyłącza wody [mm]

G1-1/4 (M)

32



30/180

EN Adapter
 PL Złączka do rur
 DE Rohrverbindung
 RU Ниппель для труб
 CZ Trubková spojka
 RO Racord compresiune
 HU Csatlakozó csőhöz
 ES Conector de tubos



(M)
 G1

Ø
 25
 mm

1
 MPa
 (max.)

PP



No.

88851

Connector thread size / Rozmiar gwintu przyłącza

G1 (M)

Water outlet diameter / Średnica przyłącza wody [mm]

25



30/240

EN Adapter
 PL Złączka do rur
 DE Rohrverbindung
 RU Ниппель для труб
 CZ Trubková spojka
 RO Racord compresiune
 HU Csatlakozó csőhöz
 ES Conector de tubos



(M)
 G1

Ø
 32
 mm

1
 MPa
 (max.)

PP



No.

88896

Connector thread size / Rozmiar gwintu przyłącza

G1 (M)

Water outlet diameter / Średnica przyłącza wody [mm]

32



30/180

EN Adapter
 PL Złączka do rur
 DE Rohrverbindung
 RU Ниппель для труб
 CZ Trubková spojka
 RO Racord compresiune
 HU Csatlakozó csőhöz
 ES Conector de tubos



(M)
 G3/4

Ø
 25
 mm

1
 MPa
 (max.)

PP



No.

88850

Connector thread size / Rozmiar gwintu przyłącza

G3/4 (M)

Water outlet diameter / Średnica przyłącza wody [mm]

25



50/200

EN Adapter
 PL Złączka do rur
 DE Rohrverbindung
 RU Ниппель для труб
 CZ Trubková spojka
 RO Racord compresiune
 HU Csatlakozó csőhöz
 ES Conector de tubos



(M)
 G3/4

Ø
 32
 mm

1
 MPa
 (max.)

PP



No.

88895

Connector thread size / Rozmiar gwintu przyłącza

G3/4 (M)

Water outlet diameter / Średnica przyłącza wody [mm]

32



30/180

EN Adapter
 PL Złączka do rur
 DE Rohrverbindung
 RU Ниппель для труб
 CZ Trubková spojka
 RO Racord compresiune
 HU Csatlakozó csőhöz
 ES Conector de tubos

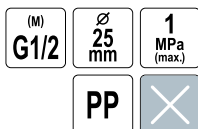

No.	Connector thread size / Rozmiar gwintu przyłącza	Water outlet diameter / Średnica przyłącza wody [mm]	
88849	G1/2 (M)	25	30/240

EN Adapter
 PL Złączka do rur
 DE Rohrverbindung
 RU Ниппель для труб
 CZ Trubková spojka
 RO Racord compresiune
 HU Csatlakozó csőhöz
 ES Conector de tubos

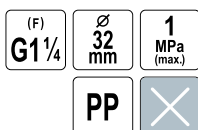

No.	Connector thread size / Rozmiar gwintu przyłącza	Water outlet diameter / Średnica przyłącza wody [mm]	
88893	G1-1/4 (F)	32	30/180

EN Adapter
 PL Złączka do rur
 DE Rohrverbindung
 RU Ниппель для труб
 CZ Trubková spojka
 RO Racord compresiune
 HU Csatlakozó csőhöz
 ES Conector de tubos

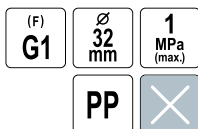

No.	Connector thread size / Rozmiar gwintu przyłącza	Water outlet diameter / Średnica przyłącza wody [mm]	
88892	G1 (F)	32	30/180

EN Adapter
 PL Złączka do rur
 DE Rohrverbindung
 RU Ниппель для труб
 CZ Trubková spojka
 RO Racord compresiune
 HU Csatlakozó csőhöz
 ES Conector de tubos

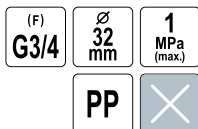

No.	Connector thread size / Rozmiar gwintu przyłącza	Water outlet diameter / Średnica przyłącza wody [mm]	
88891	G3/4 (F)	32	30/180

EN Adapter
 PL Złączka do rur
 DE Rohrverbindung
 RU Ниппель для труб
 CZ Trubková spojka
 RO Racord compresiune
 HU Csatlakozó csőhöz
 ES Conector de tubos



No.	Connector thread size / Rozmiar gwintu przyłącza	Water outlet diameter / Średnica przyłącza wody [mm]	
88894	G1/2 (M)	32	30/180

EN Adapter
 PL Złączka do rur
 DE Rohrverbindung
 RU Ниппель для труб
 CZ Trubková spojka
 RO Racord compresiune
 HU Csatlakozó csőhöz
 ES Conector de tubos



No.	Connector thread size / Rozmiar gwintu przyłącza	Water outlet diameter / Średnica przyłącza wody [mm]	
88842	G1 (F)	25	30/240

EN Adapter
 PL Złączka do rur
 DE Rohrverbindung
 RU Ниппель для труб
 CZ Trubková spojka
 RO Racord compresiune
 HU Csatlakozó csőhöz
 ES Conector de tubos



No.	Connector thread size / Rozmiar gwintu przyłącza	Water outlet diameter / Średnica przyłącza wody [mm]	
88841	G3/4 (F)	25	30/240

EN Adapter
 PL Złączka do rur
 DE Rohrverbindung
 RU Ниппель для труб
 CZ Trubková spojka
 RO Racord compresiune
 HU Csatlakozó csőhöz
 ES Conector de tubos



No.	Connector thread size / Rozmiar gwintu przyłącza	Water outlet diameter / Średnica przyłącza wody [mm]	
88840	G1/2 (F)	25	30/240

EN Adapter
 PL Złącza do rur
 DE Rohrverbindung
 RU Ниппель для труб
 CZ Trubková spojka
 RO Racord compresiune
 HU Csatlakozó csőhöz
 ES Conector de tubos



(F) **G1/2** **32 mm** **1 MPa (max.)**
PP



No.	Connector thread size / Rozmiar gwintu przyłącza	Water outlet diameter / Średnica przyłącza wody [mm]	
88890	G1/2 (F)	32	30/180

EN Adapter - pipe plug
 PL Ząslepka do rur
 DE Rohrstopfen
 RU Затушка для труб
 CZ Záslepka do trubek
 RO Dop compresiune
 HU Elzáró sapka csőhöz
 ES Tapa de tubos



32 mm **1 MPa (max.)**
PP



No.	Water outlet diameter / Średnica przyłącza wody [mm]	
88920	32	30/240

EN Adapter
 PL Złącza do rur
 DE Rohrverbindung
 RU Ниппель для труб
 CZ Trubková spojka
 RO Mufă compresiune redusă
 HU Csatlakozó csőhöz
 ES Conector de tubos



32/25 mm **1.0 MPa (max.)** **PP**



No.	Water outlet diameter / Średnica przyłącza wody [mm]	
88859	32x25	15/90

EN Adapter 90°
 PL Kolanko do rur
 DE Rohrkrümmmer
 RU Колено для труб
 CZ Trubkový ohyb
 RO Cot compresiune
 HU Derékszög csőhöz
 ES Codo para tubos



90° **G1 1/4** **32 mm**
1 MPa (max.) **PP**



No.	Connector thread size / Rozmiar gwintu przyłącza	Water outlet diameter / Średnica przyłącza wody [mm]	
88917	G1-1/4 (M)	32	15/150

EN Adapter - pipe plug
 PL Ząslepka do rur
 DE Rohrstopfen
 RU Затушка для труб
 CZ Záslepka do trubek
 RO Dop compresiune
 HU Elzáró sapka csőhöz
 ES Tapa de tubos



25 mm **1 MPa (max.)**
PP



No.	Water outlet diameter / Średnica przyłącza wody [mm]	
88853	25	50/200

EN Adapter
 PL Ząslepka do rur
 DE Rohrstopfen
 RU Ниппель для труб
 CZ Záslepka do trubek
 RO Mufă compresiune
 HU Csatlakozó csőhöz
 ES Conector de tubos



25 mm **1 MPa (max.)**
PP



No.	Water outlet diameter / Średnica przyłącza wody [mm]	
88858	25x25	50/200

EN Adapter
 PL Ząslepka do rur
 DE Rohrverbindung
 RU Ниппель для труб
 CZ Trubková spojka
 RO Mufă compresiune
 HU Csatlakozó csőhöz
 ES Conector de tubos



32 mm **1 MPa (max.)** **PP**



No.	Water outlet diameter / Średnica przyłącza wody [mm]	
88899	32x32	15/90

EN Adapter 90°
 PL Kolanko do rur
 DE Rohrkrümmmer
 RU Колено для труб
 CZ Trubkový ohyb
 RO Cot compresiune
 HU Derékszög csőhöz
 ES Codo para tubos



90° **G1** **25 mm**
1 MPa (max.) **PP**



No.	Connector thread size / Rozmiar gwintu przyłącza	Water outlet diameter / Średnica przyłącza wody [mm]	
88870	G1 (M)	25	50/200

EN Adapter 90°
 PL Kolanko do rur
 DE Rohrkrümmmer
 RU Колено для труб
 CZ Trubkový ohyb
 RO Cot compresiune
 HU Derékszög csőhöz
 ES Codo para tubos

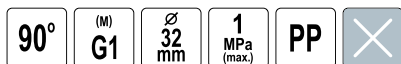

No.	Connector thread size / Rozmiar gwintu przyłącza	Water outlet diameter / Średnica przyłącza wody [mm]	
88916	G1 (M)	32	15/150

EN Adapter 90°
 PL Kolanko do rur
 DE Rohrkrümmmer
 RU Колено для труб
 CZ Trubkový ohyb
 RO Cot compresiune
 HU Derékszög csőhöz
 ES Codo para tubos

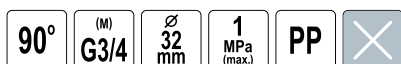

No.	Connector thread size / Rozmiar gwintu przyłącza	Water outlet diameter / Średnica przyłącza wody [mm]	
88915	G3/4 (M)	32	15/150

EN Adapter 90°
 PL Kolanko do rur
 DE Rohrkrümmmer
 RU Колено для труб
 CZ Trubkový ohyb
 RO Cot compresiune
 HU Derékszög csőhöz
 ES Codo para tubos

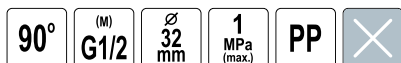

No.	Connector thread size / Rozmiar gwintu przyłącza	Water outlet diameter / Średnica przyłącza wody [mm]	
88914	G1/2 (M)	32	15/150

EN Adapter 90°
 PL Kolanko do rur
 DE Rohrkrümmmer
 RU Колено для труб
 CZ Trubkový ohyb
 RO Cot compresiune
 HU Derékszög csőhöz
 ES Codo para tubos

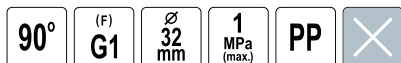

No.	Connector thread size / Rozmiar gwintu przyłącza	Water outlet diameter / Średnica przyłącza wody [mm]	
88913	G1 (F)	32	15/150

EN Adapter 90°
 PL Kolanko do rur
 DE Rohrkrümmmer
 RU Колено для труб
 CZ Trubkový ohyb
 RO Cot compresiune
 HU Derékszög csőhöz
 ES Codo para tubos

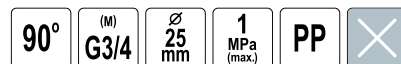

No.	Connector thread size / Rozmiar gwintu przyłącza	Water outlet diameter / Średnica przyłącza wody [mm]	
88869	G3/4 (M)	25	15/150

EN Adapter 90°
 PL Kolanko do rur
 DE Rohrkrümmmer
 RU Колено для труб
 CZ Trubkový ohyb
 RO Cot compresiune
 HU Derékszög csőhöz
 ES Codo para tubos

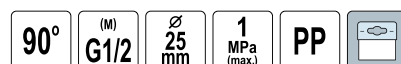

No.	Connector thread size / Rozmiar gwintu przyłącza	Water outlet diameter / Średnica przyłącza wody [mm]	
88871	G1/2 (M)	25	50/200

EN Adapter 90°
 PL Kolanko do rur
 DE Rohrkrümmmer
 RU Колено для труб
 CZ Trubkový ohyb
 RO Cot compresiune
 HU Derékszög csőhöz
 ES Codo para tubos



No.	Connector thread size / Rozmiar gwintu przyłącza	Water outlet diameter / Średnica przyłącza wody [mm]	
88874	G1 (F)	25	15/150

EN Adapter 90°
 PL Kolanko do rur
 DE Rohrkrümmmer
 RU Колено для труб
 CZ Trubkový ohyb
 RO Cot compresiune
 HU Derékszög csőhöz
 ES Codo para tubos

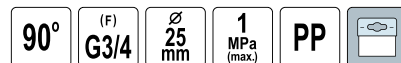

No.	Connector thread size / Rozmiar gwintu przyłącza	Water outlet diameter / Średnica przyłącza wody [mm]	
88857	G3/4 (F)	25	50/200

EN Adapter 90°
 PL Kolanko do rur
 DE Rohrkümmmer
 RU Колено для труб
 CZ Trubkový ohyb
 RO Cot compresiune
 HU Derékszög csőhöz
 ES Codo para tubos

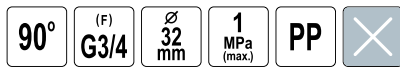

No.	Connector thread size / Rozmiar gwintu przyłącza	Water outlet diameter / Średnica przyłącza wody [mm]	
88912	G3/4 (F)	32	15/150

EN Adapter 90°
 PL Kolanko do rur
 DE Rohrkümmmer
 RU Колено для труб
 CZ Trubkový ohyb
 RO Cot compresiune
 HU Derékszög csőhöz
 ES Codo para tubos

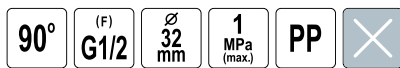

No.	Connector thread size / Rozmiar gwintu przyłącza	Water outlet diameter / Średnica przyłącza wody [mm]	
88911	G1/2 (F)	32	15/150

EN Adapter 90°
 PL Kolanko do rur
 DE Rohrkümmmer
 RU Колено для труб
 CZ Trubkový ohyb
 RO Cot compresiune
 HU Derékszög csőhöz
 ES Codo para tubos



No.	Water outlet diameter / Średnica przyłącza wody [mm]	
88910	32x32	15/90

EN Adapter
 PL Trójnik
 DE T-Stück
 RU Тройник
 CZ Rozdělovač
 RO Teu compresiune
 HU Hármás elosztó
 ES Tubos en T



No.	Connector thread size / Rozmiar gwintu przyłącza	Water outlet diameter / Średnica przyłącza wody [mm]	
88860	G1 (M)	25x25	50/200

EN Adapter 90°
 PL Kolanko do rur
 DE Rohrkümmmer
 RU Колено для труб
 CZ Trubkový ohyb
 RO Cot compresiune
 HU Derékszög csőhöz
 ES Codo para tubos

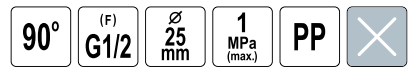

No.	Connector thread size / Rozmiar gwintu przyłącza	Water outlet diameter / Średnica przyłącza wody [mm]	
88872	G1/2 (F)	25	15/150

EN Adapter 90°
 PL Kolanko do rur
 DE Rohrkümmmer
 RU Колено для труб
 CZ Trubkový ohyb
 RO Cot compresiune
 HU Derékszög csőhöz
 ES Codo para tubos



No.	Water outlet diameter / Średnica przyłącza wody [mm]	
88856	25x25	50/200

EN Adapter
 PL Trójnik
 DE T-Stück
 RU Тройник
 CZ Rozdělovač
 RO Teu compresiune
 HU Hármás elosztó
 ES Tubos en T



No.	Connector thread size / Rozmiar gwintu przyłącza	Water outlet diameter / Średnica przyłącza wody [mm]	
88908	G1-1/4 (M)	32x32	15/90

EN Adapter
 PL Trójnik
 DE T-Stück
 RU Тройник
 CZ Rozdělovač
 RO Teu compresiune
 HU Hármás elosztó
 ES Tubos en T



No.	Connector thread size / Rozmiar gwintu przyłącza	Water outlet diameter / Średnica przyłącza wody [mm]	
88907	G1 (M)	32x32	15/90

EN Adapter
 PL Trójnik
 DE T-Stück
 RU Тройник
 CZ Rozdělovač
 RO Teu compresiune
 HU Hármás elosztó
 ES Tubos en T



No.	Connector thread size / Rozmiar gwintu przyłącza	Water outlet diameter / Średnica przyłącza wody [mm]	
88861	G3/4 (M)	25x25	50/200

EN Adapter
 PL Trójnik
 DE T-Stück
 RU Тройник
 CZ Rozdělovač
 RO Teu compresiune
 HU Hármás elosztó
 ES Tubos en T



No.	Connector thread size / Rozmiar gwintu przyłącza	Water outlet diameter / Średnica przyłącza wody [mm]	
88862	G1/2 (M)	25x25	50/200

EN Adapter
 PL Trójnik
 DE T-Stück
 RU Тройник
 CZ Rozdělovač
 RO Teu compresiune
 HU Hármás elosztó
 ES Tubos en T



No.	Connector thread size / Rozmiar gwintu przyłącza	Water outlet diameter / Średnica przyłącza wody [mm]	
88863	G1 (F)	25x25	50/200

EN Adapter
 PL Trójnik
 DE T-Stück
 RU Тройник
 CZ Rozdělovač
 RO Teu compresiune
 HU Hármás elosztó
 ES Tubos en T



No.	Connector thread size / Rozmiar gwintu przyłącza	Water outlet diameter / Średnica przyłącza wody [mm]	
88855	G3/4 (F)	25x25	50/200

EN Adapter
 PL Trójnik
 DE T-Stück
 RU Тройник
 CZ Rozdělovač
 RO Teu compresiune
 HU Hármás elosztó
 ES Tubos en T



No.	Connector thread size / Rozmiar gwintu przyłącza	Water outlet diameter / Średnica przyłącza wody [mm]	
88906	G3/4 (M)	32x32	15/90

EN Adapter
 PL Trójnik
 DE T-Stück
 RU Тройник
 CZ Rozdělovač
 RO Teu compresiune
 HU Hármás elosztó
 ES Tubos en T



No.	Connector thread size / Rozmiar gwintu przyłącza	Water outlet diameter / Średnica przyłącza wody [mm]	
88905	G1/2 (M)	32x32	15/90

EN Adapter
 PL Trójnik
 DE T-Stück
 RU Тройник
 CZ Rozdělovač
 RO Teu compresiune
 HU Hármás elosztó
 ES Tubos en T



No.	Connector thread size / Rozmiar gwintu przyłącza	Water outlet diameter / Średnica przyłącza wody [mm]	
88904	G1 (F)	32x32	15/90

EN Adapter
 PL Trójnik
 DE T-Stück
 RU Тройник
 CZ Rozdělovač
 RO Teu compresiune
 HU Hármás elosztó
 ES Tubos en T



No.	Connector thread size / Rozmiar gwintu przyłącza	Water outlet diameter / Średnica przyłącza wody [mm]	
88903	G3/4 (F)	32x32	15/90

EN Adapter
 PL Trójnik
 DE T-Stück
 RU Тройник
 CZ Rozdělovač
 RO Teu compresiune
 HU Hármás elosztó
 ES Tubos en T



No.	Connector thread size / Rozmiar gwintu przyłącza	Water outlet diameter / Średnica przyłącza wody [mm]	
88864	G1/2 (F)	25x25	50/200

EN Adapter
 PL Trójnik
 DE T-Stück
 RU Тройник
 CZ Rozdělovač
 RO Teu compresiune
 HU Hármás elosztó
 ES Tubos en T

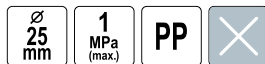

No.	Water outlet diameter / Średnica przyłącza wody [mm]	
88865	25x25x25	15/120

EN Adapter
 PL Trójnik
 DE T-Stück
 RU Тройник
 CZ Rozdělovač
 RO Teu compresiune
 HU Hármás elosztó
 ES Tubos en T

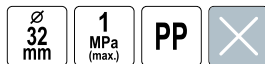

No.	Water outlet diameter / Średnica przyłącza wody [mm]	
88909	32x32x32	15/90

EN Ball valve
 PL Zawór kulowy
 DE Kugelhahn
 RU Кран шаровой
 CZ Kulový ventil
 RO Supapă cu bilă
 HU Golyóscsap
 ES Válvula de bola



No.	Connector thread size / Rozmiar gwintu przyłącza	Water outlet diameter / Średnica przyłącza wody [mm]	
88962	G3/4 (F)	25	50/100
88963	G1 (F)	32	30/60

EN Adapter
 PL Trójnik
 DE T-Stück
 RU Тройник
 CZ Rozdělovač
 RO Teu compresiune
 HU Hármás elosztó
 ES Tubos en T



No.	Connector thread size / Rozmiar gwintu przyłącza	Water outlet diameter / Średnica przyłącza wody [mm]	
88900	G1/2 (F)	32x32	15/90

EN Adapter
 PL Trójnik
 DE T-Stück
 RU Тройник
 CZ Rozdělovač
 RO Teu compresiune
 HU Hármás elosztó
 ES Tubos en T

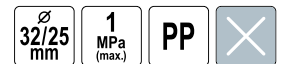

No.	Water outlet diameter / Średnica przyłącza wody [mm]	
88902	32x25x32	15/90

EN Ball valve
 PL Zawór kulowy
 DE Kugelhahn
 RU Кран шаровой
 CZ Kulový ventil
 RO Supapă cu bilă
 HU Golyóscsap
 ES Válvula de bola



No.	Water outlet diameter / Średnica przyłącza wody [mm]	
88960	25x25	40/80
88961	32x32	30/60

EN Ball valve
 PL Zawór kulowy
 DE Kugelhahn
 RU Кран шаровой
 CZ Kulový ventil
 RO Supapă cu bilă
 HU Golyóscsap
 ES Válvula de bola



No.	Connector thread size / Rozmiar gwintu przyłącza	Water outlet diameter / Średnica przyłącza wody [mm]	
88964	G3/4 (M)	25	40/80
88965	G1 (M)	32	30/60

EN Ball valve
 PL Zawór kulowy
 DE Kugelhahn
 RU Кран шаровой
 CZ Kulový ventil
 RO Supapă cu bilă
 HU Golyóscsap
 ES Válvula de bola



No.	Connector thread size / Rozmiar gwintu przyłącza	
88966	G1/2 (F) x G1/2 (F)	100/200
88967	G3/4 (F) x G3/4 (F)	60/120
88968	G1 (F) x G1 (F)	40/80
88969	G1-1/4 (F) x G1-1/4 (F)	30/60
88970	G1-1/2 (F) x G1-1/2 (F)	20/40

EN Ball valve
 PL Zawór kulowy
 DE Kugelhahn
 RU Кран шаровой
 CZ Kulový ventil
 RO Supapă cu bilă
 HU Golyóscsap
 ES Válvula de bola



No.	Connector thread size / Rozmiar gwintu przyłącza	
88985	G1/2 (M) x G1/2 (M)	100/200
88986	G3/4 (M) x G3/4 (M)	60/120
88987	G1 (M) x G1 (M)	40/80
88988	G1-1/4 (M) x G1-1/4 (M)	30/60
88989	G1-1/2 (M) x G1-1/2 (M)	20/40

EN Water filter
 PL Filtr wody
 DE Wasserfilter
 RU Фильтр очистки воды
 CZ Vodní filtr
 RO Filtru apa
 HU Vízszűrő
 ES Filtro de agua



No.	Connector thread size / Rozmiar gwintu przyłącza	
88931	G1 BSP (M)	24

EN Ball valve
 PL Zawór kulowy
 DE Kugelhahn
 RU Кран шаровой
 CZ Kulový ventil
 RO Supapă cu bilă
 HU Golyóscsap
 ES Válvula de bola

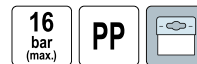

No.	Connector thread size / Rozmiar gwintu przyłącza	
88980	G1/2 (F) x G1/2 (M)	100/200
88981	G3/4 (F) x G3/4 (M)	60/120
88982	G1 (F) x G1 (M)	40/80
88983	G1-1/4 (F) x G1-1/4 (M)	30/60
88984	G1-1/2 (F) x G1-1/2 (M)	20/40

EN Water filter
 PL Filtr wody
 DE Wasserfilter
 RU Фильтр очистки воды
 CZ Vodní filtr
 RO Filtru apa
 HU Vízszűrő
 ES Filtro de agua



No.	Connector thread size / Rozmiar gwintu przyłącza	
88930	G3/4 BSP (M)	24

EN Water filter
 PL Filtr wody
 DE Wasserfilter
 RU Фильтр очистки воды
 CZ Vodní filtr
 RO Filtru apa
 HU Vízszűrő
 ES Filtro de agua



No.	Connector thread size / Rozmiar gwintu przyłącza	
88932	G1-1/2 BSP (M)	9

EN Water filter
 PL Filtr wody
 DE Wasserfilter
 RU Фильтр очистки воды
 CZ Vodní filtr
 RO Filtru apa
 HU Vízsűrű
 ES Filtro de agua



0.8 MPa (M) G2 BSP
 Q max 22000 l/h 130 µm
 PP



No.	Connector thread size / Rozmiar gwintu przyłącza	
88933	G2 BSP (M)	9

EN Filter element of screen filter
 PL Wkład siatkowy do filtra wody
 DE Mascheneinsatz für Wasserfilter
 RU Сетчатый картридж для фильтра очистки воды
 CZ Síťovaná vložka vodního filtru
 RO Sita filtru
 HU Hálós betét vízszűrőbe
 ES Cartucho de malla para filtro de agua



(M) G1½ BSP (M) G2 BSP
 120 MESH SITO PP
 SS STAINLESS STEEL STAŁ NIERDZEWNA



No.	Connector thread size / Rozmiar gwintu przyłącza	For / Dla	
88936	G1-1/2 BSP (M), G2 BSP (M)	88932, 88933	32

EN Filter element of disc filter
 PL Wkład dyskowy do filtra wody
 DE Scheibenfiltereinsatz für Wasserfilter
 RU Дискový картридж для фильтра очистки воды
 CZ Disková vložka do vodního filtru
 RO Disc filtru
 HU Lemezkes betét vízszűrőbe
 ES Cartucho de disco para filtro de agua



(M) G1½ BSP (M) G2 BSP
 130 µm PP



No.	Connector thread size / Rozmiar gwintu przyłącza	For / Dla	
88939	G1-1/2 BSP (M), G2 BSP (M)	88932, 88933	32

EN Bypass pruner
 PL Sekator nożycowy
 DE Gartenschere
 RU Садовый секатор
 CZ Dvoubřité zahradní nůžky
 RO Foarfecă de grădină
 HU Metszőolló
 ES Tijera de poda bypass

190 mm ø15 mm



No.	L [mm]	
99194	190	12/120

EN Filter element of screen filter
 PL Wkład siatkowy do filtra wody
 DE Mascheneinsatz für Wasserfilter
 RU Сетчатый картридж для фильтра очистки воды
 CZ Síťovaná vložka vodního filtru
 RO Sita filtru
 HU Hálós betét vízszűrőbe
 ES Cartucho de malla para filtro de agua



(M) G3/4 BSP (M) G1 BSP
 120 MESH SITO PP
 SS STAINLESS STEEL STAŁ NIERDZEWNA



No.	Connector thread size / Rozmiar gwintu przyłącza	For / Dla	
88935	G3/4 BSP (M), G1 BSP (M)	88930, 88931	144

EN Filter element of disc filter
 PL Wkład dyskowy do filtra wody
 DE Scheibenfiltereinsatz für Wasserfilter
 RU Дискový картридж для фильтра очистки воды
 CZ Disková vložka do vodního filtru
 RO Disc filtru
 HU Lemezkes betét vízszűrőbe
 ES Cartucho de disco para filtro de agua



(M) G3/4 (M) G1
 130 µm PP



No.	Connector thread size / Rozmiar gwintu przyłącza	For / Dla	
88938	G3/4 BSP (M), G1 BSP (M)	88930	144

EN Bypass pruner
 PL Sekator nożycowy
 DE Gartenschere
 RU Садовый секатор
 CZ Dvoubřité zahradní nůžky
 RO Foarfecă de grădină
 HU Metszőolló
 ES Tijera de poda bypass

180 mm ø10 mm



No.	L [mm]	
99193	180	12/120

EN Bypass pruner
 PL Sekator nożycowy
 DE Gartenschere
 RU Садовый секатор
 CZ Dvoubřité zahradní nůžky
 RO Foarfecă de grădină
 HU Metszőolló
 ES Tijera de poda bypass

200 mm



No.	L [mm]	
99230	200	20/60

EN Bypass pruner
 PL Sekator nożycowy
 DE Gartenschere
 RU Садовый секатор
 CZ Dvoubříté zahradní nůžky
 RO Foarfecă de grădină
 HU Metszőolló
 ES Tijera de poda bypass



FLO

No.	L [mm]	
99190	200	18/72

EN Bypass pruner
 PL Sekator nożycowy
 DE Gartenschere
 RU Садовый секатор
 CZ Dvoubříté zahradní nůžky
 RO Foarfecă de grădină
 HU Metszőolló
 ES Tijera de poda bypass



FLO

No.	L [mm]	
99202	180	18/72

EN Bypass pruner
 PL Sekator nożycowy
 DE Gartenschere
 RU Садовый секатор
 CZ Dvoubříté zahradní nůžky
 RO Foarfecă de grădină
 HU Metszőolló
 ES Tijera de poda bypass



FLO

No.	L [mm]	
99204	220	20/60

EN Bypass pruner
 PL Sekator nożycowy
 DE Gartenschere
 RU Садовый секатор
 CZ Dvoubříté zahradní nůžky
 RO Foarfecă de grădină
 HU Metszőolló
 ES Tijera de poda bypass



FLO

No.	L [mm]	
99206	210	20/60

EN Bypass pruner
 PL Sekator nożycowy
 DE Gartenschere
 RU Садовый секатор
 CZ Dvoubříté zahradní nůžky
 RO Foarfecă de grădină
 HU Metszőolló
 ES Tijera de poda bypass



FLO

No.	L [mm]	
99209	215	6/48

EN Bypass pruner
 PL Sekator nożycowy
 DE Gartenschere
 RU Садовый секатор
 CZ Dvoubříté zahradní nůžky
 RO Foarfecă de grădină
 HU Metszőolló
 ES Tijera de poda bypass



FLO

No.	L [mm]	
99203	205	20/60

EN Bypass pruner
 PL Sekator nożycowy
 DE Gartenschere
 RU Садовый секатор
 CZ Dvoubříté zahradní nůžky
 RO Foarfecă de grădină
 HU Metszőolló
 ES Tijera de poda bypass



FLO

No.	L [mm]	
99208	200	12/60

EN Anvil pruner
 PL Sekator kowadełkowy
 DE Amboss-Gartenschere
 RU Секатор с наковальней
 CZ Kovadlinkové zahradní nůžky
 RO Foarfecă cu nicovală
 HU Űllős metszőolló
 ES Tijera de poda de yunque



FLO

No.	L [mm]	
99207	205	20/60

EN Anvil pruner
 PL Sekator kowadełkowy
 DE Amboss-Gartenschere
 RU Секатор с наковальной
 CZ Kovadlinkové zahradní nůžky
 RO Foarfecă cu nicovaia
 HU Üllős metszőolló
 ES Tijera de poda de yunque



No.	L [mm]	
99191	200	18/72

EN Bypass pruners set
 PL Zestaw sekatorów
 DE Gartenscheren-Set
 RU Набор секаторов
 CZ Sada zahradních nůžek
 RO Set foarfecă pt. pomi
 HU Metszőolló készlet
 ES Juego de tijeras de poda



No.	L [mm]	
99195	150	24

EN Floral scissors
 PL Nożyce florystyczne
 DE Blumenschere
 RU Цветочные ножницы
 CZ Květinové nůžky
 RO Foarfecă pt. flori
 HU Virágolló
 ES Tijera para florista

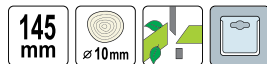

No.	L [mm]	
99181	145	12/120

EN Floral scissors
 PL Nożyce florystyczne
 DE Blumenschere
 RU Цветочные ножницы
 CZ Květinové nůžky
 RO Foarfecă pt. flori
 HU Virágolló
 ES Tijera para florista



No.	L [mm]	
99182	165	12/120

EN Grafting tool
 PL Sekator do szczepień
 DE Gartenschere zum Pfropfen
 RU Секатор для прививки
 CZ Roubovací nůžky
 RO Instrument pt. altoit
 HU Oltó olló
 ES Tijera injertadora



No.		
99250		20

EN Fruit and flower shears
 PL Sekator do obcinania zawiązków
 DE Blumen- und Traubenschere
 RU Секатор садовый виноградный
 CZ Zahradnické nůžky na řepeny
 RO Foarfecă pt. grădină
 HU Zöldség- és gyümölcs metszőolló
 ES Tijera para podar fruta



No.	L [mm]	
99240	190	12/72

EN Floral scissors
 PL Nożyce florystyczne
 DE Blumenschere
 RU Цветочные ножницы
 CZ Květinové nůžky
 RO Foarfecă pt. flori
 HU Virágolló
 ES Tijera para florista



No.	L [mm]	
99180	170	12/120

EN Bypass lopper
 PL Sekator nożycowy do gałęzi
 DE Bypass-Astscherer
 RU Сучкорез садовый
 CZ Nůžky na větve dvoubřité
 RO Foarfecă pt. crengi
 HU Bypass ágvágo olló
 ES Tijera corta ramas bypass



No.	L [mm]	
99101	430	12

EN Bypass lopper
 PL Sekator nożycowy do gałęzi
 DE Bypass-Astscherer
 RU Сучкорез садовый
 CZ Nůžky na větve dvoubřité
 RO Foarfecă pt. crengi
 HU Bypass ágváágó olló
 ES Tijera corta ramas bypass



FLO

No.	L [mm]	
99103	535	12

EN Bypass lopper
 PL Sekator nożycowy do gałęzi
 DE Bypass-Astscherer
 RU Сучкорез садовый
 CZ Nůžky na větve dvoubřité
 RO Foarfecă pt. crengi
 HU Bypass ágváágó olló
 ES Tijera corta ramas bypass



FLO

No.	L [mm]	
99109	660	12

EN Bypass lopper
 PL Sekator do gałęzi nożycowy teleskopowy
 DE Teleskop-Bypass-Astscherer
 RU Сучкорез телескопический
 CZ Teleskopické nůžky na větve dvoubřité
 RO Foarfecă telescopică pt. crengi
 HU Teleszkópos bypass ágváágó olló
 ES Tijera corta ramas bypass telescópica



FLO

No.	L [mm]	
99111	700	12

EN Telescopic bypass lopper
 PL Sekator do gałęzi kowadełkowy teleskopowy
 DE Teleskop-Amboss-Astscherer
 RU Сучкорез телескопический с наковальней
 CZ Teleskopické nůžky na větve kovadlinkové
 RO Foarfecă telescopică pt. crengi
 HU Teleszkópos üllős ágváágó olló
 ES Tijera corta ramas de yunque telescópica

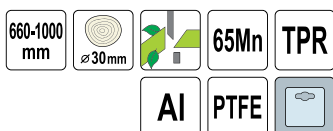

FLO

No.	L [mm]	
99114	660-1000	12

EN Bypass lopper
 PL Sekator nożycowy do gałęzi
 DE Bypass-Astscherer
 RU Сучкорез садовый
 CZ Nůžky na větve dvoubřité
 RO Foarfecă pt. crengi
 HU Bypass ágváágó olló
 ES Tijera corta ramas bypass



FLO

No.	L [mm]	
99104	630	12

EN Bypass lopper
 PL Sekator nożycowy do gałęzi
 DE Bypass-Astscherer
 RU Сучкорез садовый
 CZ Nůžky na větve dvoubřité
 RO Foarfecă pt. crengi
 HU Bypass ágváágó olló
 ES Tijera corta ramas bypass



FLO

No.	L [mm]	
99116	690	12

EN Telescopic bypass lopper
 PL Sekator do gałęzi nożycowy teleskopowy
 DE Teleskop-Bypass-Astscherer
 RU Сучкорез телескопический
 CZ Teleskopické nůžky na větve dvoubřité
 RO Foarfecă telescopică pt. crengi
 HU Teleszkópos bypass ágváágó olló
 ES Tijera corta ramas bypass telescópica



FLO

No.	L [mm]	
99119	660-910	12

EN Telescopic anvil lopper
 PL Sekator do gałęzi kowadełkowy teleskopowy
 DE Teleskop-Amboss-Astscherer
 RU Сучкорез телескопический с наковальней
 CZ Teleskopické nůžky na větve kovadlinkové
 RO Foarfecă telescopică pt. crengi
 HU Teleszkópos üllős ágváágó olló
 ES Tijera corta ramas de yunque telescópica

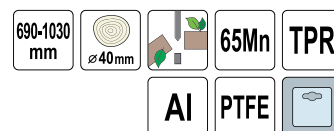

FLO

No.	L [mm]	
99113	690-1030	6

EN Telescopic bypass lopper
 PL Sekator do gałęzi nożycowy teleskopowy
 DE Teleskop-Bypass-Astscherer
 RU Сучкорез телескопический
 CZ Teleskopické nůžky na větve dvoubřitě
 RO Foarfecă telescopică pt. crengi
 HU Teleszkópos bypass ágváágó olló
 ES Tijera corta ramas bypass telescópica

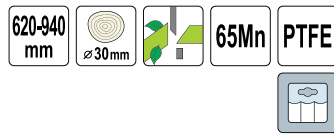

FLO

No.	L [mm]	
99115	620-940	12

EN Anvil lopper
 PL Sekator kowadełkowy do gałęzi
 DE Amboss-Astscherer
 RU Сучкорез с наковальной
 CZ Nůžky na větve kovadlinkové
 RO Foarfecă pt. crengi
 HU Üllős ágváágó olló
 ES Tijera corta ramas de yunque



FLO

No.	L [mm]	
99112	690	12

EN Telescopic handle for tree pruner
 PL Przedłużka teleskopowa do sekatora gasienicowego
 DE Teleskopstange für Teleskop-Astscherer
 RU Телескопическая ручка для штангового сучкореза
 CZ Teleskopická tyč pro nůžky
 RO Prelungitor telescopic pt. foarfecă de grădină
 HU Teleszkópos nyél hernyózó ollóhoz
 ES Poste telescópico para tijera de podar



FLO

No.	L [mm]	
99315	1300-2370	12

EN Hedge shears
 PL Nożyce do żywoplotu
 DE Hand-Heckenschere
 RU Кусторез
 CZ Nůžky na živý plot
 RO Foarfecă pt. gard viu
 HU Sónyenyváágó olló
 ES Tijera corta setos



FLO

No.	L [mm]	
99005	550	20

EN Anvil lopper
 PL Sekator kowadełkowy do gałęzi
 DE Amboss-Astscherer
 RU Сучкорез с наковальной
 CZ Nůžky na větve kovadlinkové
 RO Foarfecă pt. crengi
 HU Üllős ágváágó olló
 ES Tijera corta ramas de yunque



FLO

No.	L [mm]	
99110	660	12

EN Leverage tree pruner
 PL Sekator gasienicowy z piłą
 DE Baumsäge mit Astschere
 RU Сучкорез штанговый с пилой
 CZ Nůžky na větve s pilkou
 RO Foarfecă si fierăstrău pt. crengi
 HU Hernyózó olló fűrészel
 ES Sierra de podar con tijeras



FLO

No.	L [mm]	
99310	330	12/24

EN Hedge shears
 PL Nożyce do żywoplotu
 DE Hand-Heckenschere
 RU Кусторез
 CZ Nůžky na živý plot
 RO Foarfecă pt. gard viu
 HU Sónyenyváágó olló
 ES Tijera corta setos

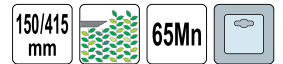

FLO

No.	L [mm]	
99001	415	12

EN Hedge shears
 PL Nożyce do żywoplotu
 DE Hand-Heckenschere
 RU Кусторез
 CZ Nůžky na živý plot
 RO Foarfecă pt. gard viu
 HU Sónyenyváágó olló
 ES Tijera corta setos



FLO

No.	L [mm]	
99006	630	12

EN Hedge shears
 PL Nożyce do żywopłotu
 DE Hand-Heckenschere
 RU Кусторез
 CZ Nůžky na živý plot
 RO Foarfecă pt. gard viu
 HU Sövényvágó olló
 ES Tijera corta setos

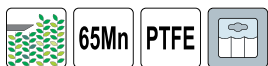

FLO

No.	L [mm]	Blade length / Długość ostrza [mm]	
99007	590	185	18
99008	620	215	18

EN Grass shears
 PL Nożyce do trawy wielopozycyjne
 DE Handgrassschere
 RU Ножницы для стрижки травы

CZ Nožnice na trávu
 RO Foarfeca pt. gazon
 HU Forgatható fűvirító olló
 ES Tijeras de césped

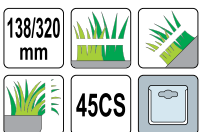

FLO

No.	L [mm]	
99300	320	12/48

EN Pruning saw
 PL Pila ogrodnicza do gałęzi
 DE Gartensäge
 RU Пила для обрезки ветвей

CZ Zahradní pilka na větvě
 RO Fierăstrău pt. crengi
 HU Kerti fűrész
 ES Sierra de jardín para ramas

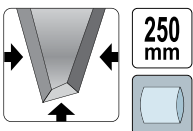

FLO

No.	L [mm]	
28640	250	12/120

EN Pruning saw with sheath
 PL Pila ogrodnicza z kaburą
 DE Gartensäge mit Holster
 RU Пила садовая с кабурой
 CZ Zahradní pilka s pouzdrém
 RO Fierăstrău pt. crengi cu toc
 HU Keti fűrész tokkal
 ES Sierra para jardín con funda



FLO

No.	L [mm]	
28642	300	12/36

EN Telescopic hedge shears
 PL Teleskopowe nożyce do żywopłotu
 DE Teleskop-Hand-Heckenschere
 RU Кусторез с телескопическими ручками
 CZ Teleskopické nůžky na živý plot
 RO Foarfecă telescopică pt. gard viu
 HU Teleszkópos sövényvágó olló
 ES Tijera corta setos telescópica

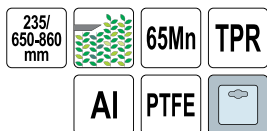

FLO

No.	L [mm]	
99009	650-860	12

EN Grass shears
 PL Nożyce do trawy wielopozycyjne
 DE Handgrassschere
 RU Ножницы для стрижки травы
 CZ Nožnice na trávu
 RO Foarfeca pt. gazon
 HU Forgatható fűvirító olló
 ES Tijeras de césped



FLO

No.	L [mm]	
99301	300	12/48

EN Folding pruning saw
 PL Pila ogrodnicza składana
 DE Klappgartensäge
 RU Пила садовая складная

CZ Skládací zahradní pilka
 RO Fierăstrău pliabil pt. crengi
 HU Összecsukható kerti fűrész
 ES Sierra para jardín plegable

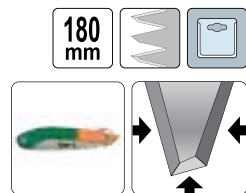

FLO

No.	L [mm]	
28641	180	20/60

EN Pruning saw with sheath
 PL Pila ogrodnicza z kaburą
 DE Gartensäge mit Holster
 RU Пила садовая с кабурой
 CZ Zahradní pilka s pouzdrém
 RO Fierăstrău pt. crengi cu toc
 HU Keti fűrész tokkal
 ES Sierra para jardín con funda

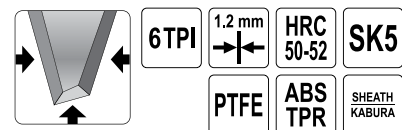

FLO

No.	L [mm]	Package	
28611	240		24
28612	300		24

EN Folding pruning saw
 PL Piła ogrodnicza składana
 DE Klappgartensäge
 RU Пила садовая складная
 CZ Skládací zahradní pilka
 RO Fierastrău pliabil pt. crengi
 HU Összecsukható kerti fűrészt
 ES Sierra para jardín plegable



150 mm	6 TPI	1.0 mm	HRC 50-52
SK5	PTFE	ABS TPR	



No.	L [mm]	
28630	150	10/40

EN Folding pruning saw
 PL Piła ogrodnicza składana
 DE Klappgartensäge
 RU Пила садовая складная
 CZ Skládací zahradní pilka
 RO Fierastrău pliabil pt. crengi
 HU Összecsukható kerti fűrészt
 ES Sierra para jardín plegable

7 TPI	1.0 mm	65 Mn	ABS TPR	
-------	--------	-------	---------	--

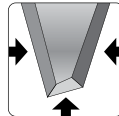

No.	L [mm]	
28631	210	12/72
28632	250	12/72

EN Transplanter
 PL Łopátka
 DE Blumenkelle
 RU Совок посадочный
 CZ Lopátka
 RO Mini-lopată gradinarit
 HU Ásó
 ES Paleta estrecha



350 mm	
--------	--



No.	L [mm]	
99048	350	25/100

EN Rake
 PL Grabki
 DE Blumenrechen
 RU Грабли
 CZ Hračičky
 RO Mini grebla
 HU Cereblye
 ES Rastrillo



300 mm	
--------	--



No.	L [mm]	
99051	300	25/100

EN Curved pruning saw
 PL Piła ogrodnicza zakrzywiona
 DE Gebogene Gartensäge
 RU Пила садовая с изогнутым полотном
 CZ Zahradní pilka zahnutá
 RO Fierastrău curbat pt. crengi
 HU Ívelt kerti fűrészt
 ES Sierra para jardín curvada

330 mm	6 TPI	1.2 mm	HRC 50-52
SK5	PTFE	ABS TPR	SHEATH KABURA



No.	L [mm]	
28613	330	24

EN Transplanter
 PL Łopátka
 DE Blumenkelle
 RU Совок посадочный
 CZ Lopátka
 RO Mini-lopată gradinarit
 HU Ásó
 ES Paleta estrecha



350 mm	
--------	--



No.	L [mm]	
99047	350	25/100

EN Hoe and cultivator
 PL Motyczka z pazurkami
 DE Doppelhacke
 RU Рыхлитель комбинированный
 CZ Motyčka s kultivátorem
 RO Săpăligă cu cultivator
 HU Kerti villás kapa
 ES Escarificador y azadilla



300 mm	
--------	--



No.	L [mm]	
99050	300	50

EN Hoe
 PL Motyczka
 DE Garten Handhacke
 RU Мотыжка
 CZ Motyčka
 RO Săpăligă
 HU Kerti kapa
 ES Azadilla

300 mm



FLO

No.	L [mm]	
99052	300	100

EN Transplanter
 PL Łopátka
 DE Blumenkelle
 RU Сокос посадочный
 CZ Lopátka
 RO Mini-lopata gradinarit
 HU Ásó
 ES Paleta estrecha

320 mm



FLO

No.	L [mm]	
35765	320	50

EN Cultivator
 PL Pazurki
 DE Grubber
 RU Рыхлитель
 CZ Kultivátor
 RO Cultivator
 HU Kultivátor
 ES Escarifi cador

330 mm



FLO

No.	L [mm]	
35767	330	50

EN Transplanter
 PL Łopátka
 DE Blumenkelle
 RU Сокос посадочный
 CZ Lopátka
 RO Mini-lopata gradinarit
 HU Ásó
 ES Paleta estrecha

330 mm



FLO

No.	L [mm]	
99035	330	24/48

EN Cultivator
 PL Pazurki
 DE Grubber
 RU Рыхлитель
 CZ Kultivátor
 RO Cultivator
 HU Kultivátor
 ES Escarifi cador

310 mm



FLO

No.	L [mm]	
99049	310	25/100

EN Hoe
 PL Motyczka
 DE Garten Handhacke
 RU Мотыжка
 CZ Motyčka
 RO Săpăligă
 HU Kerti kapa
 ES Azadilla

350 mm



FLO

No.	L [mm]	
35768	350	50

EN Transplanter
 PL Łopátka
 DE Blumenkelle
 RU Сокос посадочный
 CZ Lopátka
 RO Mini-lopata gradinarit
 HU Ásó
 ES Paleta estrecha

330 mm



FLO

No.	L [mm]	
99034	330	24/48

EN Rake
 PL Grabki
 DE Blumenrechen
 RU Грабли
 CZ Hrábky
 RO Mini grebla
 HU Gereblye
 ES Rastrillo

300 mm



FLO

No.	L [mm]	
99036	300	24/48

EN Hoe and cultivator
 PL Motyczka z pazurkami
 DE Doppelhacke
 RU Рыхлитель комбинированный
 CZ Motyčka s kultivátorem
 RO Săpăligă cu cultivator
 HU Kerti villás kapa
 ES Escarificador y azadilla

300 mm



FLO

No.	L [mm]	
99037	300	24/48

EN Garden rake
 PL Grabki wachlarzowe
 DE Landschaftsbesen
 RU Грабли веерные
 CZ Hrabičky
 RO Grebla de gradina
 HU Kerti gereblye
 ES Rastrillo de abanico de hojalata

400 mm



FLO

No.	L [mm]	
99039	400	24/48

EN Bulb planter
 PL Sadzarka do cebulek
 DE Blumenweibelpflanzer
 RU Конус посадочный для рассады
 CZ Sazeč cibulí
 RO Plantator pt. bulbi
 HU Hagymatűtő
 ES Plantador de bulbos



FLO

No.		
99033		10/60

EN Nut collector
 PL Zbieracz do orzechów
 DE Nussammler
 RU Полн для сбора ореха
 CZ Sběrač ořechů
 RO Culegător nuci
 HU Diógyűjtő
 ES Recolector de nueces



FLO

No.	L [cm]	
89890	127	2

EN Cultivator
 PL Pazurki
 DE Grubber
 RU Рыхлитель
 CZ Kultivátor
 RO Cultivator
 HU Kultivátor
 ES Escarifi cador

395 mm



FLO

No.	L [mm]	
99038	395	24/48

EN Patio weeder
 PL Chwastownik
 DE Fugenkratzer
 RU Очиститель щелевой
 CZ Čistič mezer
 RO Cultiț pt. curățat dale
 HU Fugakaparó
 ES Musgo cuchillo

320 mm



FLO

No.	L [mm]	
99040	320	24/48

EN Fruit pick up tool
 PL Zbierak do owoców
 DE Obstpflücker
 RU Съёмник для фруктов
 CZ Sběrač ovoce
 RO Culegator pt. fructe
 HU Karos gyümölcszedő
 ES Recolector de frutas

160 mm



FLO

No.	Ø [mm]	
89880	160	12/48

127 cm 28 cm SS STAINLESS STEEL ENL. WEGSCHEREN

EN Nut collector
 PL Zbieracz do orzechów
 DE Nusssammler
 RU Ропл для сбора ореха
 CZ Sběrač ořechů
 RO Culegător nuci
 HU Diógyűjtő
 ES Recolector de nueces

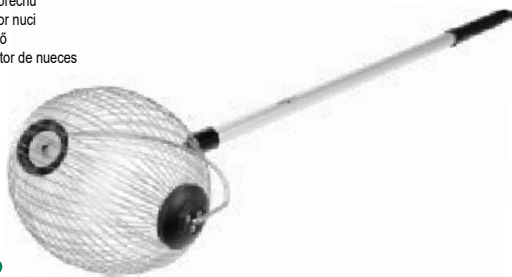

No.	L [cm]	
89891	105-145	2

EN Folding shovel
 PL Saperka składana
 DE Faltschaufel
 RU Складная лопата

CZ Lopatka skládací
 RO Lopata demontabila
 HU Őszecsukható ásó
 ES Zapadora desmontable



No.		
99054		36

EN Transplanting spade
 PL Szpadel szkółkarski
 DE Baumschulspaten
 RU Лопата для саженцев
 CZ Školkářský rýč
 RO Cazma pt. plantat
 HU Faiskolai ásó
 ES Pala de vivero



No.	Handle type / Typ trzonka	
35811	DY	140

EN Flat spade
 PL Szpadel prosty
 DE Rodespaten
 RU Заступ
 CZ Rýč rovný
 RO Cazma cu coadă
 HU Egyenes ásó
 ES Pala recta



No.	Handle type / Typ trzonka	
35809	DY	200

EN Multifunctional shovel
 PL Saperka wielofunkcyjna
 DE Kombi-Faltschaufel
 RU Складная лопата многофункциональная
 CZ Lopatka víceúčelová
 RO Lopata multifunctionala
 HU Többfunkciós ásó
 ES Zapadora multifuncion

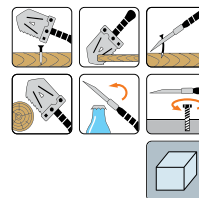

No.		
99053		36

EN Garden roller
 PL Walec ogrodowy
 DE Gartenwalze
 RU Каток газонный
 CZ Zahradní válec
 RO Tăvălug gazon
 HU Kerti henger
 ES Rodillo de jardín



No.	Working part width / Szerokość części roboczej [mm]	
88720	500	1

EN Flat spade
 PL Szpadel prosty
 DE Rodespaten
 RU Заступ
 CZ Rýč rovný
 RO Cazma cu coadă
 HU Egyenes ásó
 ES Pala recta



No.	Handle type / Typ trzonka	
35720	DY	140

EN Flat spade
 PL Szpadel prosty
 DE Rodespaten
 RU Заступ
 CZ Rýč rovný
 RO Cazma cu coadă
 HU Egyenes ásó
 ES Pala recta

120 cm FIBERGLASS WŁOKNO SZKLANE DY



No.	Handle type / Typ trzonka	
35836	DY	6

EN Sharp spade
 PL Szpadel ostry
 DE Scharfer Spaten
 RU Штыковая лопата
 CZ Rýč špičatý
 RO Hârleț ascuțit
 HU Hegyes ásó
 ES Pala puntiaguda

HRC 45 DY



No.	Handle type / Typ trzonka	
35721	DY	140

EN Mini shovel
 PL Szperka profilowana
 DE Feldspaten
 RU Лопата саперная
 CZ Vojenská lopata
 RO Lopată mică
 HU Profilozott ásó
 ES Zapa perfilada

DY



No.	Handle type / Typ trzonka	
35833	DY	200

EN Sand shovel
 PL Łopata piaskowa
 DE Sandschaufel
 RU Лопата для песка
 CZ Lopata na písek
 RO Lopată pt. nisip
 HU Homoklapát
 ES Pala para arena

HRC 45 DY



No.	Handle type / Typ trzonka	
35722	DY	120

EN Sharp spade
 PL Szpadel ostry
 DE Scharfer Spaten
 RU Штыковая лопата
 CZ Rýč špičatý
 RO Hârleț ascuțit
 HU Hegyes ásó
 ES Pala puntiaguda

DY



No.	Handle type / Typ trzonka	
35810	DY	140

EN Sharp spade
 PL Szpadel ostry
 DE Scharfer Spaten
 RU Штыковая лопата
 CZ Rýč špičatý
 RO Hârleț ascuțit
 HU Hegyes ásó
 ES Pala puntiaguda

120 cm FIBERGLASS WŁOKNO SZKLANE DY



No.	Handle type / Typ trzonka	
35837	DY	6

EN Sand shovel
 PL Łopata piaskowa
 DE Sandschaufel
 RU Лопата для песка
 CZ Lopata na písek
 RO Lopată pt. nisip
 HU Homoklapát
 ES Pala para arena

120 cm DY



No.	Handle type / Typ trzonka	
35843	DY	120

EN Sand shovel
 PL Łopata piaskowa
 DE Sandschaufel
 RU Лопата для песка
 CZ Lopata na písek
 RO Lopată pt. nisip
 HU Homoklapát
 ES Pala para arena

120 cm FIBERGLASS WŁOKNO SZKLANE DY



No.	Handle type / Typ trzonka	
35835	DY	6

EN Sand shovel
 PL Łopata piaskowa
 DE Sandschaufel
 RU Лопата для песка
 CZ Lopata na písek
 RO Lopată pt. nisip
 HU Homoklapát
 ES Pala para arena

130 cm DY



FLO

No.	Handle type / Typ trzonka	
35861	DY	120

EN Coal shovel
 PL Łopata węglowa
 DE Kohlschaufel
 RU Лопата для угля
 CZ Lopata na uhlí
 RO Lopată pt. carbune
 HU Szénlapát
 ES Pala para carbón

No 2 DY



FLO

No.	Handle type / Typ trzonka	
35863	DY	120

EN Rake
 PL Grabie
 DE Rechen
 RU Грабли
 CZ Hrábě
 RO Greblă
 HU Gereblye
 ES Rastrillo

130 cm P



FLO

No.	Number of teeth / Liczba zębów	Handle type / Typ trzonka	
35756	10	P	250
35757	12	P	250
35758	14	P	250
35759	16	P	250

EN Hand cultivator with handle
 PL Kultywator ręczny oprawiony
 DE Handkultivator, eingefasst
 RU Культиватор ручной садовый
 CZ Ruční kultivátor s násadou
 RO Cultivator cu maner
 HU Kézi kultivátor, nyeles
 ES Cultivador manual enmarcado

P



FLO

No.	Handle type / Typ trzonka	
35701	P	250

EN Gardening shovel
 PL Łopata kanadyjska
 DE Kanadischer Spaten
 RU Канадская лопата
 CZ Kanadská lopata
 RO Harlet gradina
 HU Kanadai lapát
 ES Pala canadiense

130 cm DY



FLO

No.	Handle type / Typ trzonka	
35855	DY	140

EN Digging fork
 PL Widły
 DE Grabegabel
 RU Вилы
 CZ Zahradnické vidlice
 RO Furcă pt. grădinărit
 HU Vasvilla
 ES Horca

DY



FLO

No.	Handle type / Typ trzonka	
35817	DY	200

EN Garden hoe
 PL Motyka ogrodowa
 DE Gartenhacke
 RU Тяпка садовая
 CZ Zahradní motyka
 RO Săpăligă grădină
 HU Kerti kapa
 ES Azada de jardín

120 cm P



FLO

No.	Working width / Szerokość robocza [mm]	Handle type / Typ trzonka	
35761	120	P	500
35762	140	P	500

EN Cultivator
 PL Pazaruki
 DE Grubber
 RU Рылитель
 CZ Kultivátor
 RO Cultivator
 HU Kultivátor
 ES Escarifi cador

P



FLO

No.	Handle type / Typ trzonka	
35705	P	500

EN Spring rake
 PL Grabie wachlarzowe
 DE Laubrechen
 RU Грабли веерные
 CZ Hrábě na listí
 RO Greblă evantai
 HU Lombseprű
 ES Rastrillo para hojas

120 cm



FLO

No.	Working width / Szerokość robocza [mm]	Number of teeth / Liczba zębów	
35799	400	21	250

EN Manual cultivator
 PL Kultywator ręczny
 DE Handgrubber
 RU Ручной культиватор
 CZ Ruční kultivátor
 RO Cultivator manual
 HU Kézi kultivátor
 ES Cultivador manual



22 mm 95x50 cm

FLO

No.	Working width / Szerokość robocza [mm]	
35677	500	12

EN Long handle steel edger
 PL Nóż do dami
 DE Rasenkantenstecher
 RU Полулунный нож для обрезки краев дерна
 CZ Nůz na okraje travníku
 RO Taietor de borduri
 HU Gyepgondozás
 ES Cortador de bordes para césped

T



FLO

No.	Working width / Szerokość robocza [mm]	Handle type / Typ trzonka	
35680	200	T	250

EN Flat spade
 PL Szpadel prosty
 DE Rodespaten
 RU Заступ
 CZ Rýč rovný
 RO Cazma cu coadă
 HU Egyenes ásó
 ES Pala recta

117 cm T



FLO

No.	Handle type / Typ trzonka	
35800	T	140

EN Earth auger
 PL Świder do gleby
 DE Erdbohrer
 RU Бур шнековый
 CZ Zemní vrták
 RO Burghiu pt. pământ
 HU Talajfúró
 ES Taladro de tierra



FLO

No.	Working diameter / Średnica robocza [mm]	
35667	110	50
35668	140	50
35670	170	50
35669	200	30
35672	230	25
35671	250	24

EN Cut lawn edger
 PL Obcinarka do krawędzi trawnika
 DE Kantenschneider
 RU Инструмент для обрезки края газона
 CZ Řezačka okrajů trávníku
 RO Dispozitiv pt. tăierea marginilor gazonului
 HU Gyepszegélyvágó
 ES Cortadora de bordes de césped

114 cm 150x1.5 mm 65Mn PVC EASY TRANSPORT LATWY TRANSPORT



FLO

No.	Working part diameter / Średnica części roboczej [mm]	
35685	150	1

EN Flat spade
 PL Szpadel prosty
 DE Rodespaten
 RU Заступ
 CZ Rýč rovný
 RO Cazma cu coadă
 HU Egyenes ásó
 ES Pala recta

117 cm T



FLO

No.	Handle type / Typ trzonka	
35802	T	140

EN Flat spade
 PL Szpadel prosty
 DE Rodespaten
 RU Заступ
 CZ Rýč rovný
 RO Cazma cu coadă
 HU Egyenes ásó
 ES Pala recta



No.	Handle type / Typ trzonka	
35801	T	200

EN Flat spade
 PL Szpadel prosty
 DE Rodespaten
 RU Заступ
 CZ Rýč rovný
 RO Cazma cu coadă
 HU Egyenes ásó
 ES Pala recta



No.	Handle type / Typ trzonka	
35805	DY	140

EN Drainage spade
 PL Szpadel drenarski
 DE Drainagespaten
 RU Дренажная лопата
 CZ Drenážní rýč
 RO Cazma îngusta
 HU Drénező ásó
 ES Pala de drenaje



No.	Handle type / Typ trzonka	
35807	T	140

EN Sand shovel
 PL Lopata piaskowa
 DE Sandschaufel
 RU Лопата для песка
 CZ Lopata na písek
 RO Lopată pt. nisip
 HU Homoklapát
 ES Pala para arena



No.	Handle type / Typ trzonka	
35839	DY	120

EN Flat spade
 PL Szpadel prosty
 DE Rodespaten
 RU Заступ
 CZ Rýč rovný
 RO Cazma cu coadă
 HU Egyenes ásó
 ES Pala recta



No.	Handle type / Typ trzonka	
35803	DY	140

EN Sharp spade
 PL Szpadel ostry
 DE Scharfer Spaten
 RU Штыковая лопата
 CZ Rýč spícatý
 RO Hârleț ascuțit
 HU Hegyes ásó
 ES Pala puntiaguda



No.	Handle type / Typ trzonka	
35806	DY	140

EN Drainage spade
 PL Szpadel drenarski
 DE Drainagespaten
 RU Дренажная лопата
 CZ Drenážní rýč
 RO Cazma îngusta
 HU Drénező ásó
 ES Pala de drenaje



No.	Handle type / Typ trzonka	
35808	DY	140

EN Sand shovel
 PL Lopata piaskowa
 DE Sandschaufel
 RU Лопата для песка
 CZ Lopata na písek
 RO Lopată pt. nisip
 HU Homoklapát
 ES Pala para arena



No.	Handle type / Typ trzonka	
35840	T	180

EN Shovel
 PL Łopata
 DE Schaufel
 RU Лопата
 CZ Lopata
 RO Lopată
 HU Lapát
 ES Pala

DY AI



No.	Handle type / Typ trzonka	
35846	DY	100

EN Coal shovel
 PL Łopata węglowa
 DE Kohlschaufel
 RU Лопата для угля
 CZ Lopata na uhlí
 RO Lopată pt. carbune
 HU Szénlapát
 ES Pala para carbón

№ 3 DY



No.	Handle type / Typ trzonka	
35860	DY	90

EN Digging fork
 PL Widły
 DE Grabegabel
 RU Вилы
 CZ Zahradnické vidlice
 RO Furcă pt. grădinărit
 HU Vasvilla
 ES Horca

P



No.	Number of teeth / Liczba zębów	Handle type / Typ trzonka	
35816	4	P	200

EN Digging fork
 PL Widły
 DE Grabegabel
 RU Вилы
 CZ Zahradnické vidlice
 RO Furcă pt. grădinărit
 HU Vasvilla
 ES Horca

x4 TEETH ZĘBY DY



No.	Number of teeth / Liczba zębów	Handle type / Typ trzonka	
35813	4	DY	140

EN Coal shovel
 PL Łopata węglowa
 DE Kohlschaufel
 RU Лопата для угля
 CZ Lopata na uhlí
 RO Lopată pt. carbune
 HU Szénlapát
 ES Pala para carbón

№ 2 T



No.	Handle type / Typ trzonka	
35850	T	120

EN Sand shovel
 PL Łopata piaskowa
 DE Sandschaufel
 RU Лопата для песка
 CZ Lopata na písek
 RO Lopată pt. nisip
 HU Homoklapát
 ES Pala para arena

130 cm P



No.	L [cm]	Handle type / Typ trzonka	
35842	130	P	100

EN Digging fork
 PL Widły
 DE Grabegabel
 RU Вилы
 CZ Zahradnické vidlice
 RO Furcă pt. grădinărit
 HU Vasvilla
 ES Horca

x4 TEETH ZĘBY DY



No.	Number of teeth / Liczba zębów	Handle type / Typ trzonka	
35865	4	DY	140

EN Digging fork
 PL Widły
 DE Grabegabel
 RU Вилы
 CZ Zahradnické vidlice
 RO Furcă pt. grădinărit
 HU Vasvilla
 ES Horca

x4 TEETH ZĘBY DY



No.	Number of teeth / Liczba zębów	Handle type / Typ trzonka	
35864	4	DY	140

EN Digging fork
 PL Widły
 DE Grabegabel
 RU Вилы
 CZ Zahradnické vidlice
 RO Furcă pt. grădinărit
 HU Vasvilla
 ES Horca

120 cm FIBERGLASS WŁÓKNO SZKLANE DY



No.	Number of teeth / Liczba zębów	Handle type / Typ trzonka	
35890	4	DY	6

EN Digging fork
 PL Widły
 DE Grabegabel
 RU Вилы
 CZ Zahradnické vidlice
 RO Furcă pt. grădinărit
 HU Vasvilla
 ES Horca

120 cm FIBERGLASS WŁÓKNO SZKLANE DY



No.	Number of teeth / Liczba zębów	Handle type / Typ trzonka	
35892	4	DY	6

EN Cultivator
 PL Pazaruki
 DE Grubber
 RU Рыхлитель

CZ Kultivátor
 RO Cultivator
 HU Kultivátor
 ES Escarifi cador

125 cm P



No.	Handle type / Typ trzonka	
35763	P	5

EN Rake
 PL Grabie
 DE Rechen
 RU Грабли
 CZ Hrábě
 RO Greblă
 HU Gereblye
 ES Rastrillo

150 cm



No.	L [cm]	Number of teeth / Liczba zębów	
35780	150	16	155

EN Household forks
 PL Widły gospodarcze
 DE Mistgabel
 RU Вилы хозяйственные
 CZ Hospodářské vidle
 RO Furca
 HU Szénavilla
 ES Horquilla

120 cm FIBERGLASS WŁÓKNO SZKLANE DY



No.	Number of teeth / Liczba zębów	Handle type / Typ trzonka	
35891	4	DY	6

EN Weed puller
 PL Wyrywacz chwastów
 DE Unkrautfemer
 RU Приспособление для вырывания сорняков
 CZ Vytrhávač plevelu
 RO Dispozitiv pt. smuls buruieni
 HU Gyomkihúzó
 ES Extractor de maleza

19 mm 98x21.5 cm ABS



No.	Working width / Szerokość robocza [mm]	
35673	215	12

EN Rake
 PL Grabie
 DE Rechen
 RU Грабли

CZ Hrábě
 RO Greblă
 HU Gereblye
 ES Rastrillo

P



No.	Number of teeth / Liczba zębów	Handle type / Typ trzonka	
35740	6	P	10
35741	8	P	10
35781	10	P	10
35782	12	P	10
35783	16	P	10
35784	14	P	10

EN Spring rake
 PL Grabie wachlarzowe
 DE Laubrechen
 RU Грабли веерные
 CZ Hrábě na listí
 RO Greblă evantai
 HU Lombseprű
 ES Rastrillo para hojas

390 mm



FLO

No.	Working width / Szerokość robocza [mm]	Number of teeth / Liczba zębów	
35798	390	21	58

EN Spring rake
 PL Grabie wachlarzowe
 DE Laubrechen
 RU Грабли веерные
 CZ Hrábě na listí
 RO Greblă evantai
 HU Lombseprű
 ES Rastrillo para hojas

530 mm



FLO

No.	Working width / Szerokość robocza [mm]	
99400	530	24

EN Hoe and cultivator
 PL Spulchniacz z motyczką
 DE Doppelhacke mit 2 Zinken
 RU Рыкатель с мотыгой
 CZ Kultivátor s motykou
 RO Săpăligă cu cultivator
 HU Kerti villás kapa
 ES Cultivador con azada

P



FLO

No.	Handle type / Typ trzonka	
35792	P	5

EN Garden hoe
 PL Motyka ogrodowa
 DE Gartenhacke
 RU Тяпка садовая
 CZ Zahradní motyka
 RO Săpăligă grădină
 HU Kerti kapa
 ES Azada de jardín

P



FLO

No.	Working width / Szerokość robocza [mm]	Handle type / Typ trzonka	
35773	120	P	500
35774	140	P	500
35776	160	P	500

EN Spring rake
 PL Grabie wachlarzowe
 DE Laubrechen
 RU Грабли веерные
 CZ Hrábě na listí
 RO Greblă evantai
 HU Lombseprű
 ES Rastrillo para hojas



FLO

No.	Working width / Szerokość robocza [mm]	L [cm]	Number of teeth / Liczba zębów	
35785	435	145	23	12

EN Hoe and cultivator
 PL Motyka z pazurkami
 DE Handhacke mit Krallen
 RU Мотыжка комбинированная
 CZ Motyka s kultivátorem
 RO Săpăligă cu cultivator
 HU Kerti villás kapa
 ES Escarificador y azadilla

P



FLO

No.	Handle type / Typ trzonka	
35764	P	5

EN Garden hoe
 PL Motyka ogrodowa
 DE Gartenhacke
 RU Тяпка садовая
 CZ Zahradní motyka
 RO Săpăligă grădină
 HU Kerti kapa
 ES Azada de jardín

P



FLO

No.	Working width / Szerokość robocza [mm]	Handle type / Typ trzonka	
35770	170	P	5

EN Garden hoe
 PL Motyka ogrodowa
 DE Gartenhacke
 RU Тяпка садовая
 CZ Zahradní motyka
 RO Săpăligă grădină
 HU Kerti kapa
 ES Azada de jardín

P



FLO

No.	Working width / Szerokość robocza [mm]	Handle type / Typ trzonka	
35777	170	P	5

EN Plastic rake
 PL Grabie plastikowe
 DE Plasteharken
 RU Грабли пластиковые
 CZ Plastové hrábě
 RO Greblă de plastic
 HU Műanyag gereblye
 ES Rastrillo de plástico



No.	Working width / Szerokość robocza [mm]	Number of teeth / Liczba zębów	
35788	550	16	10
35789	590	18	10

EN Rake
 PL Grabie
 DE Rechen
 RU Грабли
 CZ Hrábě
 RO Greblă
 HU Gereblye
 ES Rastrillo

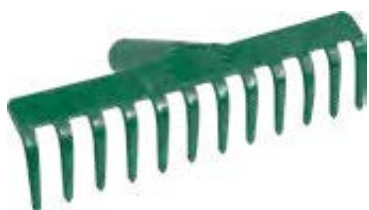

No.	Working width / Szerokość robocza [mm]	Number of teeth / Liczba zębów	
35750	270	12	48
35751	340	14	28

EN Spring rake
 PL Grabie wachlarzowe
 DE Laubrechen
 RU Грабли веерные
 CZ Hrábě na listí
 RO Greblă evantai
 HU Lombseprű
 ES Rastrillo para hojas



No.	Working width / Szerokość robocza [mm]	Number of teeth / Liczba zębów	
35786	435	23	10

EN Spring rake
 PL Grabie wachlarzowe
 DE Laubrechen
 RU Грабли веерные
 CZ Hrábě na listí
 RO Greblă evantai
 HU Lombseprű
 ES Rastrillo para hojas



No.	Working width / Szerokość robocza [mm]	Number of teeth / Liczba zębów	
35790	435	20	20
35791	580	27	20

EN Grass cultivator
 PL Wertykulator do trawy
 DE Schneidrechen
 RU Грабли азракторные
 CZ Kultivátor oboustranný
 RO Scarificator
 HU Kétoldalas talajlazító, gyephez
 ES Cultivador de dos lados



No.	Working width / Szerokość robocza [mm]	
35700	380	5/10

EN Rake
 PL Grabie
 DE Rechen
 RU Грабли
 CZ Hrábě
 RO Greblă
 HU Gereblye
 ES Rastrillo



No.	Working width / Szerokość robocza [mm]	Number of teeth / Liczba zębów	
35755	360	14	20

EN Spring rake
 PL Grabie wachlarzowe
 DE Laubrechen
 RU Грабли веерные
 CZ Hrábě na listí
 RO Greblă evantai
 HU Lombseprű
 ES Rastrillo para hojas



No.	Working width / Szerokość robocza [mm]	Number of teeth / Liczba zębów	
35787	460	20	10

EN Spring rake
 PL Grabie wachlarzowe
 DE Laubrechen
 RU Грабли веерные
 CZ Hrábě na listí
 RO Greblă evantai
 HU Lombseprű
 ES Rastrillo para hojas



No.	Working width / Szerokość robocza [mm]	
99390	410	40

EN Spring rake
 PL Grabie wachlarzowe
 DE Laubrechen
 RU Грабли веерные
 CZ Hrábě na listí
 RO Greblă evantai
 HU Lombseprű
 ES Rastrillo para hojas



460 mm



No.	Working width / Szerokość robocza [mm]	
99391	460	50

EN Cultivator
 PL Pazurki
 DE Grubber
 RU Рылитель
 CZ Kultivátor
 RO Cultivator
 HU Kultivátor
 ES Escarifi cador



100 mm



No.	Working width / Szerokość robocza [mm]	
35793	100	60
35794	130	40

EN Hoe
 PL Motyczka
 DE Garten Handhacke
 RU Мотыжка
 CZ Motyčka
 RO Săpăligă
 HU Kerti villás kapa
 ES Azadilla



160 mm



No.	Working width / Szerokość robocza [mm]	
35775	160	30

EN Hoe and cultivator
 PL Motyka z pazurkami
 DE Handhacke mit Krallen
 RU Мотыжка комбинированная
 CZ Motyčka s kultivátorem
 RO Săpăligă cu cultivator
 HU Kerti villás kapa
 ES Escarificador y azadilla



70 mm



No.	Working width / Szerokość robocza [mm]	
35795	70	60

EN Spring rake
 PL Grabie wachlarzowe
 DE Laubrechen
 RU Грабли веерные
 CZ Hrábě na listí
 RO Greblă evantai
 HU Lombseprű
 ES Rastrillo para hojas



425 mm



No.	Working width / Szerokość robocza [mm]	
99401	425	60

EN Cultivator
 PL Obsypnik
 DE Häufel
 RU Культиватор
 CZ Zásypávač
 RO Cultivator
 HU Kultivátor
 ES Arado



190 mm



No.	Working width / Szerokość robocza [mm]	
35710	190	5/15

EN Hoe and cultivator
 PL Motyka z pazurkami
 DE Handhacke mit Krallen
 RU Мотыжка комбинированная
 CZ Motyčka s kultivátorem
 RO Săpăligă cu cultivator
 HU Kerti villás kapa
 ES Escarificador y azadilla



75 mm



No.	Working width / Szerokość robocza [mm]	
35760	75	60

EN Broom
 PL Miotła
 DE Besen
 RU Метла
 CZ Metla
 RO Mătură
 HU Partvis
 ES Escoba



No.	Bristle length / Długość włosia [mm]	
35905	275	12

EN Broom
 PL Miotła
 DE Besen
 RU Метла
 CZ Metla
 RO Mătură
 HU Partvis
 ES Escoba



FLO

No.	Bristle length / Długość włosia [mm]	
35906	135	12

EN Broom
 PL Miotła
 DE Besen
 RU Метла
 CZ Metla
 RO Mătură
 HU Partvis
 ES Escoba



FLO

No.	Bristle length / Długość włosia [mm]	
35908	210	8

EN Broom
 PL Miotła
 DE Besen
 RU Метла
 CZ Metla
 RO Mătură
 HU Partvis
 ES Escoba



VOREL

No.	Bristle length / Długość włosia [mm]	
35901	290	12

EN Broom
 PL Miotła
 DE Besen
 RU Метла
 CZ Metla
 RO Mătură
 HU Partvis
 ES Escoba



VOREL

No.	Bristle length / Długość włosia [mm]	
35902	480	24

EN Wire paving brush
 PL Szczotka do bruku z radełkami
 DE Bürste mit Schaber für Reinigung von Pflastersteinen
 RU Щетка для тротуарной плитки с шипом
 CZ Kartáč do dlažby s rádílkem
 RO Perie din sarma pt. pavaj
 HU Járdakefe pengével
 ES Cepillo para adoquines, con ruedas de trazado



VOREL

No.	L [mm]	
35927	1460	10

EN Lawn mover brush
 PL Szczotka do kosiarńki
 DE Rasenmäher Reinigungsbürste mit Schaber
 RU Щетка для очистки газонокосилки
 CZ Kartáč na čištění sekačky
 RO Perie pt. curatat motocoase
 HU Ecset a kaszák tisztításához
 ES Cepillo limpieza



FLO

No.	Working width / Szerokość robocza [mm]	L [mm]	
35950	50	310	15

EN Sickle
 PL Sierp
 DE Sichel
 RU Сепр
 CZ Srp
 RO Secera
 HU Sarló
 ES Hoz



FLO

No.		
35832		30

EN Forged scythe
 PL Kosa kuta
 DE Sensenklinge geschmiedet
 RU Коса
 CZ Kosa kovaná
 RO Lama de coasa
 HU Kovácsolt kasza
 ES Guadana forjada



FLO

No.	Type / Typ	
35824	No 6	25
35826	No 7	25
35828	No 8	25

EN Ring for scythe
 PL Pierścień do kosy
 DE Sensenring
 RU Кольцо для косы
 CZ Kroužek na kosu
 RO Inel pt. coasa
 HU Kasza bilincs
 ES Anillo para guadaña

GALVANIZED
 STEEL
 STAL
 OCYNKOWANA



FLO

No.	
35823	30

EN Scythe handle
 PL Trzonek do kosy
 DE Sensenstiel
 RU Косовище
 CZ Násada na kosu
 RO Măner coasă
 HU Kaszanyél
 ES Mango para guadaña

174
 cm



FLO

No.	L [cm]	
35830	174	10

EN Shovel handle
 PL Trzonek do łopaty
 DE Schaufelstiel
 RU Черенок для лопаты
 CZ Násada na lopatu
 RO Coadă de lopată
 HU Lapátnyél
 ES Mango para pala

130
 cm



VOREL

No.	L [cm]	Type / Typ	
99410	130	P	10

EN Stake for scythe
 PL Klepadło do kosy
 DE Dengelamboss für Sensen
 RU Бабка для отбивки кос (наковальня)
 CZ Naklepávací kovadlinka
 RO Inel de slângere pt. coasă
 HU Kaszarögztítő gyűrű
 ES Anillo para guadanas



JUCO

No.	
35821	30

EN Wedge for scythe
 PL Klin do kosy
 DE Sense Keil
 RU Клиn для косы
 CZ Klín na kosu
 RO Pană pt. coasă
 HU Faék kaszához
 ES Cuña para guadaña



FLO

No.	
35831	12/144

EN Handle
 PL Trzonek
 DE Stiel
 RU Черенок
 CZ Násada
 RO Coadă
 HU Nyél
 ES Astil

P



FLO

No.	L [cm]	Ø [mm]	Type / Typ	
99403	100	28	P	25
99404	110	28	P	25
99402	130	28	P	25
99408	150	28	P	25

EN Spring rake handle
 PL Trzonek do grabi wachlarzowych
 DE Laubrechen Stiel
 RU Черенок для грабеля
 CZ Násada na hrábě
 RO Coadă pt. greble
 HU Lombseprű nyél
 ES Mango para rastrillo de hojas

130
 cm



FLO

No.	L [cm]	Ø [mm]	Type / Typ	
99415	130	22	P	25

EN Street broom handle
 PL Trzonek do miotły ulicznej
 DE Stiel für Straßenbesen
 RU Черенок для уличной метлы
 CZ Násada na silniční metlu
 RO Coadă pt. mătură stradală
 HU Utcaseprű nyél
 ES Palo de escoba de calle

125 cm



VOREL

No.	L [cm]	
99420	125	25

EN Handle with thread
 PL Trzonek z gwintem
 DE Stiel mit Gewinde
 RU Черенок с резьбой
 CZ Násada se závitem
 RO Coadă cu filet
 HU Menetes nyél
 ES Mango con rosca

120 cm

P



VOREL

No.	L [cm]	Ø [mm]	Type / Typ	
99416	120	22	P	25

EN Steel handle with thread
 PL Trzonek metalowy z gwintem
 DE Besenstiel mit Gewinde
 RU Черенок для лопаты
 CZ Násada na metlu se závitem
 RO Coadă cu filet
 HU Menetes seprűnyél
 ES Astil para escoba con rosca

118 cm

P



FLO

No.	L [cm]	Ø [mm]	
99419	118	21	24

EN Shovel handle
 PL Trzonek do łopaty
 DE Schaufelstiel
 RU Черенок для лопаты
 CZ Násada na lopatu
 RO Coadă de lopată
 HU Lapátnyél
 ES Mango para pala

115 cm

T



VOREL

No.	L [cm]	Type / Typ	
99409	115	T	10

EN Street broom handle
 PL Trzonek do miotły ulicznej
 DE Stiel für Straßenbesen
 RU Черенок для уличной метлы
 CZ Násada na silniční metlu
 RO Coadă pt. mătură stradală
 HU Utcaseprű nyél
 ES Palo de escoba de calle

150 cm



VOREL

No.	L [cm]	
99421	150	25

EN Handle with thread
 PL Trzonek z gwintem
 DE Stiel mit Gewinde
 RU Черенок с резьбой
 CZ Násada se závitem
 RO Coadă cu filet
 HU Menetes nyél
 ES Mango con rosca

120 cm

P



VOREL

No.	L [cm]	Type / Typ	
99418	120	P	25

EN Spade handle
 PL Trzonek do szpadła
 DE Spatenstiel
 RU Черенок для лопаты
 CZ Násada na rýč
 RO Coadă pt. cazma
 HU Ásónyél
 ES Mango para pala

90 cm

T



FLO

No.	L [cm]	Type / Typ	
99407	90	T	10

EN Handle
 PL Trzonek
 DE Stiel
 RU Черенок
 CZ Násada
 RO Coadă
 HU Nyél
 ES Astil

90 cm

DY



VOREL

No.	L [cm]	Type / Typ	
99412	90	DY	10

EN Handle
 PL Trzonek
 DE Stiel
 RU Черенок
 CZ Násada
 RO Coadă
 HU Nyél
 ES Astil



No.	L [cm]	Type / Typ	
99413	90	DY	10

EN Splitting maul handle
 PL Trzonek do siekierno-mlota
 DE Stiel für Spaltaxt
 RU Черенок для топора
 CZ Násada na sekerové kladivo
 RO Coadă pt. topor
 HU Fa hasító fejsze nyél
 ES Astil para hacha pesada



No.	L [cm]	For head / Do obucha [kg]	
99405	90	2.5	10
99406	90	4.0	10

EN Axe handle
 PL Trzonek do siekiery
 DE Axtstiel
 RU Черенок для топора
 CZ Násada na sekeru
 RO Coadă pt. topor
 HU Fejsze nyél
 ES Mango de hacha



No.	L [cm]	For head / Do obucha [kg]	
99430	80	1.8-2.0	25

EN Hammer handle
 PL Trzonek do młotka
 DE Hammerstiel
 RU Черенок для молотка

CZ Násada na kladivo
 RO Coadă pt. ciocan
 HU Kalapácsnyél
 ES Mango de martillo



No.	L [cm]	For head / Do obucha [kg]	
99435	28	0.1-0.3	65
99436	32	0.3-0.7	65
99438	36	0.7-1.5	65
99440	40	0.8-2.0	50
99442	50	2.0-3.0	50
99443	60	3.0-4.0	25
99444	70	4.0-6.0	25
99445	80	5.0-8.0	25
99446	90	8.0-10.0	10

EN Axe handle
 PL Trzonek do siekiery
 DE Axtstiel
 RU Черенок для топора
 CZ Násada na sekeru
 RO Coadă pt. topor
 HU Fejsze nyél
 ES Mango de hacha



No.	L [cm]	For head / Do obucha [kg]	
99425	36	0.6	75
99426	40	0.8	25

EN Axe handle
 PL Trzonek do siekiery
 DE Axtstiel
 RU Черенок для топора
 CZ Násada na sekeru
 RO Coadă pt. topor
 HU Fejsze nyél
 ES Mango de hacha



No.	L [cm]	For head / Do obucha [kg]	
99427	50	1.0	25
99428	60	1-1.25	25
99429	70	1.25-1.8	25

EN Pressure sprayer
 PL Spryskiwacz ciśnieniowy ręczny
 DE Drucksprüher
 RU Опрыскиватель ручной
 CZ Ruční tlakový postřikovač
 RO Vermorel
 HU Permetező kézi
 ES Rociador de presión, de mano



No.	Tank capacity / Pojemność zbiornika [l]	
89507	1.0	20
89508	1.5	15
89509	2.0	15

EN Pressure sprayer
 PL Opryskiwacz ciśnieniowy
 DE Drucksprüher
 RU Опрыскиватель ручной
 CZ Ruční tlakový postřikovač
 RO Pulverizator de mână
 HU Permetező kézi
 ES Rociador de presión

0.2 MPa 



No.	Tank capacity / Pojemność zbiornika [l]	
89515	5	6
89518	8	6

EN Pressure sprayer
 PL Opryskiwacz ciśnieniowy
 DE Drucksprüher
 RU Опрыскиватель ручной
 CZ Ruční tlakový postřikovač
 RO Pulverizator de mână
 HU Permetező kézi
 ES Rociador de presión

8 L
 0.2 MPa 



No.	Tank capacity / Pojemność zbiornika [l]	
89520	8	6

EN Pressure sprayer
 PL Opryskiwacz ciśnieniowy plecakowy
 DE Rücken-Drucksprüher
 RU Опрыскиватель ручной ранцевый
 CZ Tlakový postřikovač zádový
 RO Pulverizator de mână
 HU Permetező háti
 ES Rociador de presión tipo „mochila”

0.2 MPa 



No.	Tank capacity / Pojemność zbiornika [l]	
89526	15	1
89528	20	1

EN Battery sprayer
 PL Opryskiwacz akumulatorowy
 DE Akku-Sprühergerät
 RU Аккумуляторный опрыскиватель
 CZ Bateriový postřikovač
 RO Vermorel cu acumulator
 HU Akkumulátoros permetező
 ES Pulverizador a batería

12V 0.15-0.4 MPa
 3.1 l/min 16L
 8.0 Ah PE
 SS 
STAINLESS STEEL
 STAL NERDZIEŻNA



No.	Voltage / Napiecie [V d.c.]	Tank capacity / Pojemność zbiornika [l]	
89610	12	16	1

EN Battery sprayer
 PL Opryskiwacz akumulatorowy
 DE Akku-Sprühergerät
 RU Аккумуляторный опрыскиватель
 CZ Bateriový postřikovač
 RO Vermorel cu acumulator
 HU Akkumulátoros permetező
 ES Pulverizador a batería

12V 0.15-0.4 MPa
 3.1 l/min 16L
 8.0 Ah PE
 SS 
STAINLESS STEEL
 STAL NERDZIEŻNA



No.	Voltage / Napiecie [V d.c.]	Tank capacity / Pojemność zbiornika [l]	
89611	12	16	1

EN Pump for pressure sprayer
 PL Pompka do spryskiwacza
 DE Druckpumpe für Drucksprüher
 RU Насос на опрыскиватели

CZ Pumpa do postřikovače
 RO Pompa pt. vermored
 HU Szivattyú esőztetőhöz
 ES Bomba para el rociador



No.	For / Dla	
89536	89515, 89518, 89520	60

EN Straight nozzle for pressure sprayer
 PL Końcówka rozpylająca do spryskiwaczy
 DE Sprühdüse für Drucksprüher
 RU Распылитель на опрыскиватели

CZ Rozprašovací koncovka k postřikovači
 RO Vărf pulverizare pt. vermores
 HU Porlasztó tömlővég esőztetőhöz
 ES Puna de atomización para rociador



FLO

No.	For / Dla	
89537	89515, 89518, 89520	300

EN Shower spray gun
 PL Pistolet do opryskiwacza
 DE Spritzpistole
 RU Пистолет для опрыскивателей

CZ Rozprašovací pistole na vodu
 RO Pistol pt. pulverizator
 HU Locsoló pisztoly
 ES Pistola de pulverización ajustable



FLO

No.		
89539		200

EN Fibreglass spray lance
 PL Lanza z włókna szklanego
 DE Fibreglaslanze
 RU Трубка фиберглассовая

CZ Násadec postřikovače ze skleněného vlákna
 RO Lance din fibra de sticla
 HU Üvegyapot lándzsa
 ES Lanza de fibra de vidrio



FLO

No.	L [cm]	Ø [mm]	
89541	80	8	250

EN Telescopic handle
 PL Lanza teleskopowa
 DE Teleskoplanze
 RU Штанга телескопическая для опрыскивателя
 CZ Násadec teleskopický
 RO Lance telescopică pt. pulverizator
 HU Teleszkópos lándzsa
 ES Lanza telescópica

70-118
cm



FLO

No.	L [cm]	
89542	70-118	100

EN Spray nozzle set
 PL Zestaw końcówek rozpylających
 DE Spritzdüsenatz
 RU Форсунки сменные для опрыскивателей

CZ Sada rozprašovacích koncovok
 RO Set racorduri vermores
 HU Porlasztó tömlővég készlet
 ES Juego de boquillas rociadores



FLO

No.		
89538		100

EN Shower spray gun
 PL Pistolet do opryskiwacza
 DE Spritzpistole
 RU Пистолет для опрыскивателей

CZ Rozprašovací pistole na vodu
 RO Pistol pt. pulverizator
 HU Locsoló pisztoly
 ES Pistola de pulverización ajustable



FLO

No.		
89540		200

80
cm



EN 4-nozzle connector
 PL Przyłącze 4-dyszowe
 DE Querlanze mit 4 Düsen
 RU Штанга на 4 форсунки для опрыскивателя

CZ Připojka 4-trysková
 RO Sistem 4 duze pt. pulverizator
 HU 4-fúvókás csatlakozó
 ES Conexión de cuatro surtidores

645
mm



FLO

No.	L [cm]	
89543	64.5	100

EN Set of gaskets for pressure sprayer
 PL Zestaw uszczelkek do spryskiwaczy
 DE Dichtungssatz für Drucksprüher
 RU Набор прокладок для опрыскивателя
 CZ Sada těsnění k postřikovači
 RO Set de garnituri pt. vermores
 HU Tömítéskészlet esőztetőhöz
 ES Juego de juntas para rociadores



No.	For / Dla	
89545	89515, 89518, 89520	500

EN Slow release watering bag
 PL Worek nawadniający
 DE Bewässerungssack
 RU Мешок для орошения
 CZ Zavlažovací pytel
 RO Sac pt. irigat pomi
 HU Faöntöző zsák
 ES Bolsa de riego

60 L 92x98 cm

420 GSM PVC



No.	Capacity / Pojemność [l]	
89715	60	24

EN Slow release watering bag
 PL Worek nawadniający
 DE Bewässerungssack
 RU Мешок для орошения
 CZ Zavlažovací pytel
 RO Sac pt. irigat pomi
 HU Faöntöző zsák
 ES Bolsa de riego

75 L 145|1000 mm

550 GSM PVC

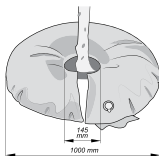

No.	Capacity / Pojemność [l]	
89722	75	20

EN Compressible rain barrel
 PL Zbiornik na wodę deszczową
 DE Regenwasserbehälter
 RU Бак для дождевой воды
 CZ Nádrž na dešťovou vodu
 RO Rezervor apă de ploaie
 HU Esővízgyűjtő tartály
 ES Depósito de agua pluvial

100 L 40x78 cm

3/4" 19mm PVC

PP Juv



No.	Capacity / Pojemność [l]	
89700	100	6

EN Set of gaskets for pressure sprayer
 PL Zestaw uszczelkek do spryskiwaczy
 DE Dichtungssatz für Drucksprüher
 RU Набор прокладок для опрыскивателя

CZ Sada těsnění k postřikovači
 RO Set de garnituri pt. vermores
 HU Tömítéskészlet esőztetőhöz
 ES Juego de juntas para rociadores



No.	For / Dla	
89547	89526, 89528	500

EN Slow release watering bag
 PL Worek nawadniający
 DE Bewässerungssack
 RU Мешок для орошения
 CZ Zavlažovací pytel
 RO Sac pt. irigat pomi
 HU Faöntöző zsák
 ES Bolsa de riego

55 L 145|900 mm

550 GSM PVC

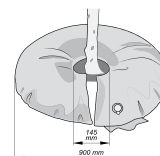

No.	Capacity / Pojemność [l]	
89720	55	20

EN Compressible rain barrel
 PL Zbiornik na wodę deszczową
 DE Regenwasserbehälter
 RU Бак для дождевой воды
 CZ Nádrž na dešťovou vodu
 RO Rezervor apă de ploaie
 HU Esővízgyűjtő tartály
 ES Depósito de agua pluvial

100 L 40x78 cm

3/4" 19mm PVC

PP Juv



No.	Capacity / Pojemność [l]	
89700	100	6



No.	Capacity / Pojemność [l]	
89702	250	6

EN Compressible rain barrel
 PL Zbiornik na wodę deszczową
 DE Regenwasserbehälter
 RU Бак для дождевой воды
 CZ Nádrž na dešťovou vodu
 RO Rezervor apă de ploaie
 HU Esővízgyűjtő tartály
 ES Depósito de agua pluvial



No.	Capacity / Pojemność [l]	
89704	500	4

EN Valves set
 PL Zestaw zaworów
 DE Ventil-Set
 RU Комплект клапанов
 CZ Sada ventilů
 RO Set valve
 HU Szelepkészlet
 ES Juego de válvulas

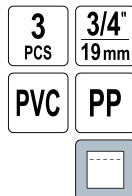

No.	Hose diameter / Średnica węży	pcs / szt.
89081	3/4" (19.0 mm)	3 50

EN Lawn edge
 PL Obrzeże trawnikowe, zielone
 DE Gartenumrandung
 RU Оградка для огорода
 CZ Plastový okraj trávníku
 RO Gărd plastic pt. grădină
 HU Ágyásszegély
 ES Borde para jardín



No.	H [mm]	L [m]	
88700	100	9	48
88701	150	9	36
88702	200	9	24

EN Lawn edge
 PL Obrzeże trawnikowe, brązowe
 DE Gartenumrandung
 RU Оградка для огорода
 CZ Plastový okraj trávníku
 RO Gărd plastic pt. grădină
 HU Ágyásszegély
 ES Borde para jardín



No.	H [mm]	L [m]	
88703	100	9	48
88704	150	9	36
88705	200	9	24

EN Flexible lawn edge with pegs
 PL Obrzeże trawnikowe ze szpilkami
 DE Rasenkantenband mit Bodenankern
 RU Бордюор для газона со шпильками
 CZ Pružný okraj trávníku s kolíky
 RO Margine flexibilă pt. gazon cu cuie
 HU Ágyás-gyepszegély karókkal
 ES Bordura para jardín con estacas

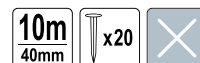

No.	H [mm]	L [m]	
88710	40	10	9

EN Edging pegs
 PL Szpilki do obrzeży
 DE Bodenanker für Rasenkanten
 RU Шпильки для газонного бордюра
 CZ Kotvíci kolíky na okraj trávníku
 RO Cuie universale pt. grădină
 HU Karók gyepszegélyhez
 ES Estacas para bordura



No.	L [mm]	pcs / szt.	
88713	180	25	60
88714	250	25	48

EN Plant protection fleece
 PL Agrowłóknina
 DE Agrotexilien
 RU Агроволокно
 CZ Agrovláknina
 RO Folie agriil pt. protecție a plantelor
 HU Geotextília
 ES Tela antiheladas



No.	Size / Rozmiar [m]	m [g/m²]	
91000	1.6x50	19	12
91003	1.6x50	50	1

EN Weed mat
 PL Agrotkanina
 DE Unkrautvlies
 RU Агротекстиль
 CZ Tkaná textilie
 RO Folie agrotextilă
 HU Agroszövet
 ES Malla antihierbas



FEATURES:
 - Enhanced protection and UV stabilizer 3%

CECHY:
 - Wzmocniona ochrona i stabilizator UV 3%



No.	Size / Rozmiar [m]	m [g/m ²]	
91046	1.6x10	70	10
91047	1.6x10	90	10
91048	1.6x20	70	10
91049	1.6x20	90	10
91050	1.6x50	70	1
91052	1.6x50	90	1

EN Ground cover pegs
 PL Kolki do agrowłókniny, agrotkaniny
 DE Bodenankern für Unkrautvlies, Gartenvlies
 RU Копышки для крепления агроткани
 CZ Hřebíky k upevnění textílií
 RO Cuie pt. folie agrotextilă
 HU Geotextília rögzítő tűske
 ES Clavos para malla antihierbas, tela antiheladas



No.	pcs / szt.	
91061	100	10

EN Shade cloth
 PL Mata do cieniowania
 DE Schattenmatte
 RU Коврик для тонировки
 CZ Podložka pro stínování
 RO Piasă umbrire
 HU Árnyékoló háló
 ES Tela de malla sombra

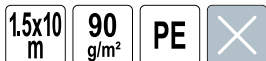

No.	Size / Rozmiar [m]	
88740	1.5x10	9

EN Ground cover pegs
 PL Szpilki do włókniny
 DE Anker für Bodenplanen
 RU Шпильки для крепления ткани
 CZ Upevňovací kotvící kolík do země
 RO Cuie pt. folie agrotextilă
 HU Rögzítő tűske
 ES Clavos de jardinería para tela



No.	L [mm]	pcs / szt.	
88715	120	25	40
88716	150	25	32

EN Ground cover staples
 PL Szpilki do agrowłókniny, agrotkaniny
 DE Erdankern für Unkrautvlies, Gartenvlies
 RU Шпильки для агроткани
 CZ Hřebíky ve tvaru U k upevnění textílií
 RO Cuie pt. folie agrotextilă
 HU Rögzítő tűske geotextíliához és agroszövethez
 ES Grapas para malla antihierbas, tela antiheladas



No.	pcs / szt.	
91060	100	10

EN Ground cover pegs
 PL Szpilki do włókniny
 DE Anker für Bodenplanen
 RU Шпильки для крепления ткани
 CZ Upevňovací kotvící kolík do země
 HU Rögzítő tűske
 ES Clavos de jardinería para tela



No.	L [mm]	pcs / szt.	
88718	250	20	25

EN Twist tie
 PL Drut ogrodniczy
 DE Gartendraht
 RU Проволока огородная

CZ Drát pro zahrádkáře
 RO Sârmă pt. grădină
 HU Kötöződrót
 ES Alambre de jardinero



No.	L [m]	
88801	50	12/48

- EN Twist tie with cutter
 PL Drut ogrodniczy powlekany z obcinaczem
 DE Gartendraht, beschichtet, mit Abschnneider
 RU Проволока огородная с диспенсером
 CZ Drát pro zahrádkáře potažený
 plastem s odřezávačem
 RO Sârmă pt. grădină izolată cu tăietor
 HU Galvanizált kötöződrót,
 darabolóval
 ES Alambre de jardinero
 cubierto con tronizador



FLO

No.	L [m]	
88805	30	24/144
88806	50	24/144

- EN Plant binding set
 PL Zestaw ogrodniczy do podwiązania roślin
 DE Gartensatz zum Abbinden von Pflanzen
 RU Набор огородный для подвязки растений

- CZ Souprava pro zahrádkáře k vyvazování rostlin
 RO Set pt. legarea plantelor
 HU Kertészeti szett növények felkötéséhez
 ES Juego para jardín para sujetar plantas

71
PCS



FLO

No.	pcs / szt.	
88811	71	24

- EN String set
 PL Zestaw sznurków
 DE Schnursatz
 RU Набор шнуров
 CZ Sada provázků
 RO Set mosoare
 HU Zsinórkészlet
 ES Juego de cuerdas

6 PCS
 1.0 mm COTTON / BAWELNA
 1.5 mm JUTE / JUTA
 1.5 mm JUTE / JUTA



FLO

No.	pcs / szt.	
88820	6	36

- EN Universal gardening tape
 PL Uniwersalna taśma ogrodnicza
 DE Universelles Pflanzen-Klebeband
 RU Универсальная садовая лента
 CZ Univerzální zahradnická páska
 RO Bandă pt. dispozitiv de legat plante
 HU Kertészeti univerzális szalag
 ES Cinta de jardín universal

FLO

No.	W [mm]	L [m]	→← [mm]	For / Dia	pcs / szt.	
88831	11	23	0.12	88830	20	25

- EN Garden flexible tie
 PL Drut ogrodniczy w osłonie z pianki
 DE Gartendraht, in einer Abdeckung aus Schaumstoff
 RU Проволока огородная покрытая пенкой
 CZ Drát pro zahrádkáře s pěnovým pláštěm
 RO Sârmă pt. grădină cu izolație din spumă
 HU Kötöződrót, plasztik bevonattal
 ES Alambre de jardinero en cubierta de espuma

10 mm 10m



FLO

No.	L [m]	
88809	10	40

- EN Plant clips set
 PL Klipsy do mocowania roślin
 DE Clips
 RU Зажимы
 CZ Klipy
 RO Set agrafe pt. legarea plantelor
 HU Csatok
 ES Clips

45 PCS
 3.4x3.0cm x15
 3.0x2.3cm x15
 2.3x2.0cm x15
 PP



FLO

No.	pcs / szt.	
88812	45	24/48

- EN Plant tying machine
 PL Zszywacz ogrodniczy
 DE Garten Bindevange
 RU Стеллер садовый для подвязки
 CZ Vázací kleště
 RO Dispozitiv pt. legat plante
 HU Kertészeti kötözőgép
 ES Atadora de jardín

ABS STEEL STAL SK5

- FUNCTIONS:
 - Fast and easy plant tying
 FUNKCJE:
 - Szybkie i łatwe podwiązanie roślin



Compatible with 88831 (tape), 88832 (staples)
 Kompatybilne z 88831 (taśma), 88832 (zszywki)

FLO

No.	
88830	20

PE



- EN Tying machine staples
- PL Zszywki do zszywacza ogrodniczego
- DE Heftklammern für Bindezange
- RU Скобы для садового степлера
- CZ Sponky pro vázací kleště
- RO Capse pt. dispozitiv de legat plante
- HU Kötözőgép kapocs
- ES Grapas para atadora de jardín



No.	Staple length / Długość zszywki [mm]	Staple thickness / Grubość zszywki [mm]	Staple width / Szerokość zszywki [mm]	For / Dla	pcs / szt.	
88832	4	0.55	6.95	88830	10000	100

- EN Plant antifreeze protective cover set
- PL Pokrowce przeciw zamarzaniu roślin
- DE Winterschutzsäcke für Pflanzen
- RU Чехлы для защиты от заморозания растений
- CZ Kryty proti zamrznání rostliny
- RO Set huse anti-îngheț pt. plante
- HU Fagyvédő fólia növényekre
- ES Cubre plantas



No.	Size / Rozmiar [cm]	pcs / szt.	
89753	80x75	3	24

- EN Vegetable growing house
- PL Miniszklarnia przydomowa
- DE Mini Garten-Gewächshaus
- RU Садовая мини-теплица
- CZ Mini skleník do zahrádky
- RO Sera pt. legume
- HU Mini kertü üvegház
- ES Mini invernadero doméstico

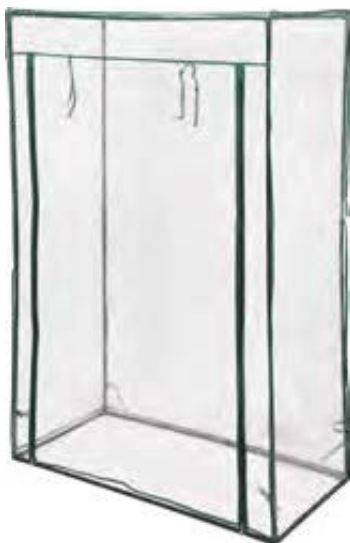

No.	Dimensions / Wymiary [cm]	
90000	100x50x150	1

- EN Frost protection fleece jacket
- PL Kaptur ochronny dla roślin
- DE Pflanzenschutzhaube
- RU Укрывной копак для растений
- CZ Ochranná kapuce na rostliny
- RO Protecție anti îngheț
- HU Védőgallér növényekre
- ES Saco protector para plantas



No.	Size / Rozmiar [cm]	
89750	120x180	24

- EN Black net tunnel
- PL Czarny tunel ochrony roślin
- DE Pflanzenschutztunnel schwarz
- RU Черный туннель для защиты растений
- CZ Černý tunel pro ochranu rostlin
- RO Protecție plante tip tunel
- HU Fekete védőalagút növényekre
- ES Túnel de malla negra para plantas



No.	Dimensions / Wymiary [cm]	
89770	300x45x45	12

- EN Vegetable growing house
- PL Miniszklarnia przydomowa
- DE Mini Garten-Gewächshaus
- RU Садовая мини-теплица
- CZ Mini skleník do zahrádky
- RO Sera pt. legume
- HU Mini kertü üvegház
- ES Mini invernadero doméstico



No.	Dimensions / Wymiary [cm]	
90001	120x60x60	1

EN 5-tier greenn house
 PL Miniszklarnia 5 poziomów
 DE Mini Gewächshaus 5 Regale
 RU Мини-теплица 5 уровней
 CZ 5 úroveňový mini skleník
 RO Sera cu 5 rafturi
 HU Mini üvegház 5 szintes
 ES Mini invernadero 5 niveles



No.	Dimensions / Wymiary [cm]	
90002	200x69x49	1

EN Walk-in greenhouse
 PL Szklarnia foliowa
 DE Folienwachshaus
 RU Пленочная теплица
 CZ Fóliový skleník
 RO Sera
 HU Fólia üvegház
 ES Invernadero de plástico



No.	Dimensions / Wymiary [cm]	
90031	143x143x195	1

EN Garden greenhouse
 PL Miniszklarnia naskrzyniowa
 DE Mini-Gewächshaus
 RU Мини-теплица грубобок
 CZ Mini skleník podstavec
 RO Mini seră
 HU Mini ládás üvegház
 ES Mini invernadero instalado en una base

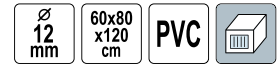

No.	Dimensions / Wymiary [cm]	
90003	60x80x120	1

EN Walk-in greenhouse
 PL Szklarnia foliowa
 DE Folienwachshaus
 RU Пленочная теплица
 CZ Fóliový skleník
 RO Sera
 HU Fólia üvegház
 ES Invernadero de plástico



No.	Dimensions / Wymiary [cm]	
90030	143x73x195	1

EN Germination tray set
 PL Doniczki torfowe do rozsad
 DE Torf-Anzuchtöpfen
 RU Торфяные горшки для рассады
 CZ Rašelinové květináče pro sazenice
 RO Set ghivece pt. răsăduri
 HU Tőzegcserép palántázáshoz
 ES Macetas de turba para plántulas



No.	pcs / szt.	
90350	10	40

EN Germination kit
 PL Zestaw do rozsad
 DE Anzuchtset
 RU Набор для рассады
 CZ Sada pro sazenice
 RO Set ghivece pt. răsăduri
 HU Palántázó készlet
 ES Kit para plántulas

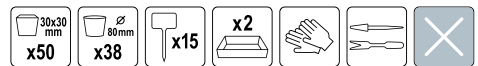

No.	pcs / szt.	
90360	63	24

EN Soil survey instrument
 PL Miernik ogrodniczy
 DE Gartmessgerät
 RU Измеритель опородный
 CZ Zahradnický měřicí přístroj
 RO Instrument verificare conditii sol
 HU Négyszögletes, kerti mérőműszer
 ES Medidor de horticultor

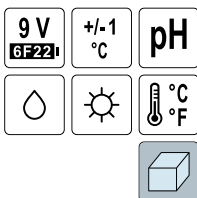

No.	Dimensions / Wymiary [cm]	Box icon
89000		10

EN Swing seat cover
 PL Pokrowiec na huśtawkę
 DE Schutzhülle für Schaukel
 RU Чехол для садовой качели
 CZ Ochranný kryt na houpačku
 RO Husa pt. balansoar terasa
 HU Kerti hintágy takaró
 ES Funda para columpio

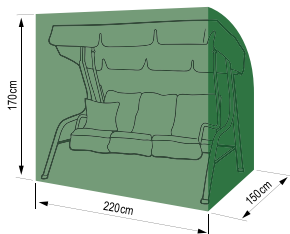
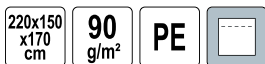

No.	Dimensions / Wymiary [cm]	Box icon
92105	220x150x170	8

EN Outdoor furniture cover
 PL Pokrowiec na meble ogrodowe
 DE Gartenmöbel-Schutzhülle
 RU Чехол для садовой мебели
 CZ Ochranný kryt na zahradní nábytek
 RO Husa mobilier de exterior
 HU Kerti butor takaró ponyva
 ES Funda para muebles de jardín

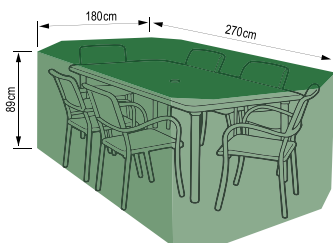
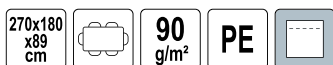

No.	Dimensions / Wymiary [cm]	Box icon
92115	270x180x89	12

EN Stackable patio chair cover
 PL Pokrowiec na krzesła ogrodowe
 DE Schutzhülle für Stapelstühle
 RU Чехол на садовые стулья
 CZ Ochranný kryt na zahradní křesla
 RO Husa pt. scaune terasa
 HU Takaró összerakott székekhez
 ES Funda para sillas de jardín

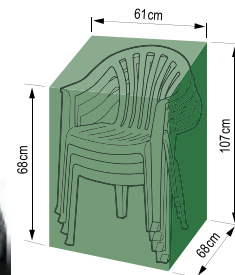
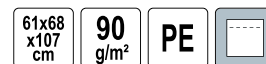

No.	Dimensions / Wymiary [cm]	Box icon
92100	61x68x107	24

EN Outdoor furniture cover
 PL Pokrowiec na meble ogrodowe
 DE Gartenmöbel-Schutzhülle
 RU Чехол для садовой мебели
 CZ Ochranný kryt na zahradní nábytek
 RO Husa mobilier de exterior
 HU Kerti butor takaró ponyva
 ES Funda para muebles de jardín

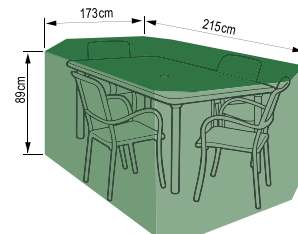
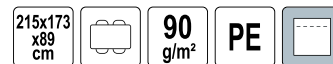

No.	Dimensions / Wymiary [cm]	Box icon
92110	215x173x89	12

EN Folding garden trash bag
 PL Kosz ogrodowy składany
 DE Klappbarer Gartenkorb
 RU Складная садовая корзина
 CZ Skládací zahradní koš
 RO Cos gunoi gradina pliable
 HU Összecsukható kerti szemetes
 ES Contenedor plegable para jardín

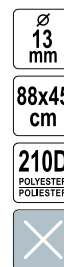

No.	Size / Rozmiar [mm]	Box icon
90150	880x450	12

EN Garden basket
 PL Kosz ogrodniczy
 DE Gartenkorb
 RU Корзина садовая
 CZ Zahradní koš
 RO Coș de grădină
 HU Kerti kosár
 ES Cesta de jardín



No.	Capacity / Pojemność [l]	
35610	25	480
35611	35	280

EN Garden bucket
 PL Wiadro ogrodnicze
 DE Garten Eimer
 RU Ведро огородное

CZ Zahradní vědro
 RO Găleată de grădină
 HU Kerti vödör
 ES Cubo de jardín



No.	Capacity / Pojemność [l]	
35600	15	500

EN Garden cart
 PL Wózek ogrodowy
 DE Gartenwagen
 RU Садовая тележка
 CZ Zahradní vozík
 RO Cărucior de grădină
 HU Kerti kocsi
 ES Carrito de jardín

FEATURES:
 - Pneumatic wheels

CECHY:
 - Kola pompowane



No.	Max. load capacity / Maks. obciążenie [kg]	Dimensions / Wymiary [mm]	
90200	300	1020x515x400	1

EN Universal grow bag
 PL Uniwersalna torba ogrodowa
 DE Mehrzweck-Gartentasche
 RU Универсальная садовая сумка
 CZ Univerzální zahradní taška
 RO Geantă de grădină universală din polipropilenă
 HU Univerzális kertésztaška
 ES Bolsa de jardín universal



No.	Size / Rozmiar [mm]	
90240	440x370	24

EN Bucket
 PL Wiadro
 DE Eimer
 RU Ведро
 CZ Vědro
 RO Găleată
 HU Vödör
 ES Cubo



No.	Capacity / Pojemność [l]	
89560	5	900
89561	7	750
89562	10	600
89563	12	500
89564	15	350

EN Garden tipping cart
 PL Wózek ogrodowy z wywrotką
 DE Gartenwagen mit Kippfunktion
 RU Садовая тележка-самосвал
 CZ Zahradní vozík sklápěcí
 RO Cărucior de grădină basculabil
 HU Kerti kocsi billenő funkcióval
 ES Carrito de jardín basculante

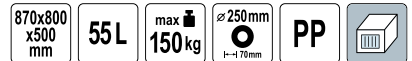

FEATURES:
 - Pneumatic wheels

CECHY:
 - Kola pompowane



No.	Max. load capacity / Maks. obciążenie [kg]	Dimensions / Wymiary [mm]	
90204	150	870x800x500	1

EN Garden tipping cart
 PL Wózek ogrodowy z wywrotką
 DE Gartenwagen mit Kippfunktion
 RU Садовая тележка-самосвал
 CZ Zahradní vozík sklápěcí
 RO Cărucior de grădină basculabil
 HU Kerti kocsí billenő funkcióval
 ES Carrito de jardín basculante

975x510 x1000 mm
 75L
 max 200 kg
 ø 260 mm
 PP



FEATURES:
 - Pneumatic wheels
 CECHY:
 - Kola pompowane



No.	Max. load capacity / Maks. obciążenie [kg]	Dimensions / Wymiary [mm]	
90205	200	975x510x1000	1

EN Waste bags
 PL Worki na odpady
 DE Müllsäcke
 RU Пакеты для мусора

CZ Pytle na odpad
 RO Saci de gunoi
 HU Szemeteszsák
 ES Bolsas para residuosos

STRING TAPE TKSMA SCIGAJĄCA

LDPE



No.	Capacity / Pojemność [l]	Thickness / Grubość [µm]	pcs / szt.
09480	60	60	10
09482	120	60	15

EN Waste bags
 PL Worki na odpady
 DE Müllsäcke
 RU Пакеты для мусора
 CZ Pytle na odpad
 RO Saci de gunoi
 HU Szemeteszsák
 ES Bolsas para residuosos

LDPE PERFORATED PERFOROWANE GARDEN OGRÓDOWE



No.	Capacity / Pojemność [l]	Thickness / Grubość [µm]	pcs / szt.
09483	120	35	10
09484	200	40	10

EN Composter
 PL Kompostownik
 DE Kompostierer
 RU Компостовник

CZ Kompostér
 RO Compostor
 HU Komposztáló láda
 ES Compostador



No.	Capacity / Pojemność [l]
35623	480

EN Trash gripper
 PL Ręczny chwytak do śmieci
 DE Manueller Abfall-Greifer
 RU Ручной захват для мусора

CZ Ruční sběrač odpadků
 RO Cleşte pt. adunat deşeurii
 HU Kézi szemétszedő
 ES Recogedor manual de basura

760 mm
 ø 14 mm
 AI
 ABS PP TPR



No.	L [mm]	
89896	760	24

EN Waste bags
 PL Worki na odpady
 DE Müllsäcke
 RU Пакеты для мусора
 CZ Pytle na odpad
 RO Saci de gunoi
 HU Szemeteszsák
 ES Bolsas para residuosos

10 PCS 120L 60 µm LDPE GARDEN OGRÓDOWE



No.	Capacity / Pojemność [l]	Thickness / Grubość [µm]	pcs / szt.
09481	120	60	10
			15

EN Compost and gravel sieve
 PL Sito do kompostu i żwiru
 DE Sieb für Kompost und Kies
 RU Сито для компоста и гравия
 CZ Prohazovací sito na kompost a štěrək
 RO Sită compost și zgură
 HU Rosta komposztáláshoz és sóderhez
 ES Cedazo para estiércol y guija



No.	Dimensions / Wymiary [cm]	Eyelet size / Rozmiar oczka [mm]
34949	60x100	20x20
		5/30

480L PP



EN Composter
 PL Kompostownik
 DE Kompostierer
 RU Компостовник
 CZ Kompostér
 RO Compostor
 HU Komposztáló láda
 ES Compostador

740L PP



No.	Capacity / Pojemność [l]	
35624	740	7

EN Composter
 PL Kompostownik
 DE Kompostierer
 RU Компостовник
 CZ Kompostér
 RO Compostor
 HU Komposztáló láda
 ES Compostador

1000L PP



No.	Capacity / Pojemność [l]	
35625	1000	6

EN Handheld spreader
 PL Rozsiewacz ręczny
 DE Handstreuer
 RU Разбрасыватель-сеялка ручная
 CZ Ruční rozmetadlo
 RO Dispozitiv imprăștiere semințe
 HU Kézi magszórő
 ES Esparcidor manual de semillas

3L PP



No.	Capacity / Pojemność [l]	
89860	3	12

EN Seed spreader
 PL Siewnik
 DE Streuwagen
 RU Сеялка садовая
 CZ Syrací vozík
 RO Semănătoare
 HU Kerti vetőgép
 ES Esparcidor de semillas



No.	Capacity / Pojemność [l]	
89870	12	1

12L
 PP
 AI

EN Broadcast spreader
 PL Siewnik rotacyjny
 DE Rotationsstreuer
 RU Сеялка ротационная
 CZ Rotální syrač
 RO Distributor semințe
 HU Rotációs műtrágyaszórő
 ES Carrito esparcidor rotativo

FEATURES:
 - For sowing grass, fertilization, spreading of salt and sand
CECHY:
 - Do siania trawy, nawożenia, rozsypania soli i piasku



No.	Capacity / Pojemność [l]	
89877	15	1

15L
 6-8 m
 12 3... 15
 8"
 PP

EN Garden rack
 PL Stojak ogrodowy
 DE Gartengeräteständer
 RU Садовая подставка
 CZ Zahradní stojan
 RO Organizator unelete de grădină
 HU Kerti állvány
 ES Soplete para herramientas de jardinería

84x74 x35 cm max 45 kg PP



No.	Dimensions / Wymiary [mm]	
89990	840x740x350	1

EN Multiple holder
 PL Wieszak na narzędzia
 DE Werkzeughalter
 RU Подвеска для инструмента
 CZ Věšák na nářadí
 RO Organizator scule
 HU Szerszámakasztó
 ES Colgador para herramientas

18-32 mm x5 x6 300 g TPR PP



No.		
89950		40

EN Gutter mesh with hooks
 PL Siatka zabezpieczająca rynny z uchwytami mocującymi
 DE Schutzgitter für Rinnen mit Spannvorrichtungen
 RU Защитная сетка желоба с монтажными ручками
 CZ Ochranná síť proti zanášení okapových žlabů s úchytkami
 RO Plasă de protecție pt. burlane
 HU Lombfogó háló rögzítő fűlekkel
 ES Malla de protección para la canaleta con mandriles de sujeción

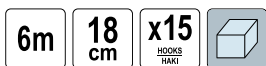

No.			
69851			30

EN Portable car shower set
 PL Samochodowy prysznic turystyczny
 DE Campingdusche
 RU Портативный автомобиль душ
 CZ Mobilní auto sprcha
 RO Dus portabil masina
 HU Autós hordozható zuhany
 ES Portátil ducha de coche

FUNCTIONS:
 - Taking shower, washing car, washing dishes and others

FUNKCJE:
 - Prysznic, mycie samochodu, mycie naczyń i inne

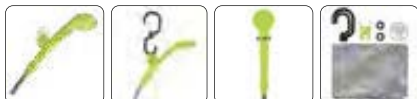

No.	Voltage / Napięcie [V d.c.]	
82991	12	10

EN Gas grill
 PL Grill gazowy
 DE Gasgrill
 RU Газовый гриль
 CZ Plynový gril
 RO Grătar pe gaz
 HU Gázgrill
 ES Barbacoa de gas

FEATURES:
 - Thermo gauge
 - Bowl for fat
 - Foldable side shelves

CECHY:
 - Termometr
 - Misa na tłuszcz
 - Składane półki boczne



No.	
99644	1

EN Rain pipe guard
 PL Osłona rynny - sito do rury spustowej
 DE Fallrohrschutz
 RU Защитный кожух водосточного желоба
 CZ Ochrana okapového svodu
 RO Protecție pt. burlane
 HU Sító eresz burkolat leeresztő csőhöz
 ES Protector de canalón tamiza para tubo de descarga

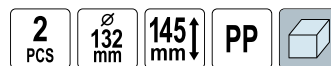

No.	Ø [mm]	pcs / szt.	
69860	132	2	24

EN Portable car shower set
 PL Samochodowy prysznic turystyczny
 DE Campingdusche
 RU Портативный автомобиль душ
 CZ Mobilní auto sprcha
 RO Dus portabil masina
 HU Autós hordozható zuhany
 ES Portátil ducha de coche

FUNCTIONS:
 - Taking shower, washing car, washing dishes, watering plants and others

FUNKCJE:
 - Prysznic, mycie samochodu, mycie naczyń, podlewanie roślin i inne

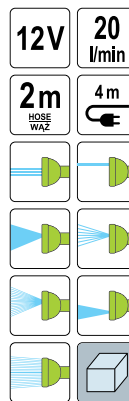

No.	Voltage / Napięcie [V d.c.]	
82992	12	10

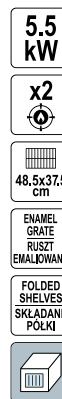

EN Gas grill
 PL Grill gazowy
 DE Gasgrill
 RU Газовый гриль
 CZ Plynový gril
 RO Grătar pe gaz
 HU Gázgrill
 ES Barbacoa de gas



FEATURES: - Bowl for fat
CECHY: - Misa na tłuszcz



LUND

No. 99657 1

EN Gas grill
 PL Grill gazowy
 DE Gasgrill
 RU Газовый гриль
 CZ Plynový gril
 RO Grătar pe gaz
 HU Gázgrill
 ES Barbacoa de gas



FEATURES: - Thermo gauge
 - Bowl for fat
CECHY: - Termometr
 - Misa na tłuszcz



LUND

No. 99645 1

EN Gas grill
 PL Grill gazowy
 DE Gasgrill
 RU Газовый гриль
 CZ Plynový gril
 RO Grătar pe gaz
 HU Gázgrill
 ES Barbacoa de gas

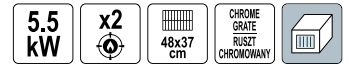

FEATURES: - Bowl for fat
 - Bottle opener
CECHY: - Misa na tłuszcz
 - Otwieracz do butelek



LUND

No. 99658 1

EN Gas grill
 PL Grill gazowy
 DE Gasgrill
 RU Газовый гриль
 CZ Plynový gril
 RO Grătar pe gaz
 HU Gázgrill
 ES Barbacoa de gas

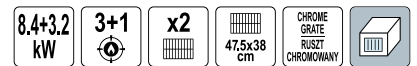

FEATURES: - Ignition in the knob
 - Thermo gauge
 - Sliding tray for fat
CECHY: - Zapalnik w pokrętle
 - Termometr
 - Wyszuwana taca na tłuszcz



LUND

No. 99646 1

EN Gas grill
 PL Grill gazowy
 DE Gasgrill
 RU Газовый гриль
 CZ Plynový gril
 RO Grătar pe gaz
 HU Gázgrill
 ES Barbacoa de gas

FEATURES:
 - Ignition in the knob
 - Thermo gauge
 - Sliding tray for fat

CECHY:
 - Zapalnik w pokrętle
 - Termometr
 - Wysuwana taca na tłuszcz

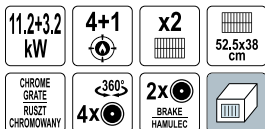

LUND

No. 99647 1

EN Gas grill
 PL Grill gazowy
 DE Gasgrill
 RU Газовый гриль
 CZ Plynový gril
 RO Grătar pe gaz
 HU Gázgrill
 ES Barbacoa de gas

FEATURES:
 - Ignition in the knob
 - Thermo gauge
 - Sliding tray for fat

CECHY:
 - Zapalnik w pokrętle
 - Termometr
 - Wysuwana taca na tłuszcz

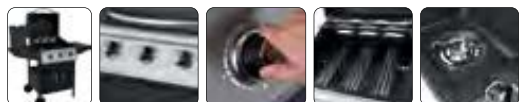

LUND

No. 99642 1

EN Gas and charcoal grill
 PL Grill gazowo-węglowy
 DE Gas- und Kohlegrill
 RU Газово-угольный гриль
 CZ Gril na plyn a uhlí
 RO Grătar pe gaz si cărbuni
 HU Kombinált grill, gáz, szén
 ES Barbacoa a gas y carbón

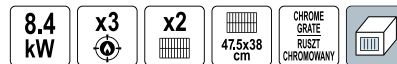

FEATURES:
 - Thermo gauges
 - Sliding trays for fat
 - Charcoal bowl
 - Foldable side shelves

CECHY:
 - Termometry
 - Wysuwane tace na tłuszcz
 - Płyta na węgiel
 - Składane półki boczne

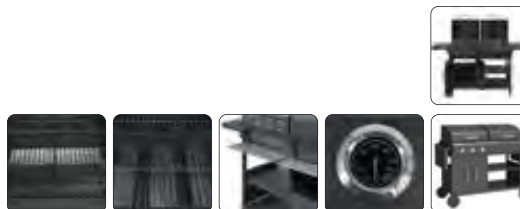

LUND

No. 99649 1

EN Gas grill
 PL Grill gazowy
 DE Gasgrill
 RU Газовый гриль
 CZ Plynový gril
 RO Grătar pe gaz
 HU Gázgrill
 ES Barbacoa de gas

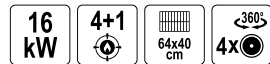

FEATURES:
 - Ignition in the knob
 - Thermo gauge
 - Sliding tray for fat
 - Side handles
 - Wheels with a brake

CECHY:
 - Zapalnik w pokrętle
 - Termometr
 - Wysuwana taca na tłuszcz
 - Uchwyty boczne
 - Kola z hamulcem



LUND

No. 99643 1

EN Gas grill
 PL Grill gazowy
 DE Gasgrill
 RU Газовый гриль
 CZ Plynový gril
 RO Grătar pe gaz
 HU Gázgrill
 ES Barbacoa de gas

FEATURES:
 - Ignition in the knob
 - Thermo gauge
 - Sliding tray for fat
 - Space for a gas bottle
 - Wheels with a brake

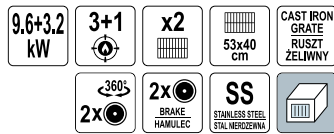

CECHY:
 - Zapalnik w pokrętle
 - Termometr
 - Wysuwana taca na tłuszcz
 - Miejsce na butlę gazową
 - Kola z hamulcem

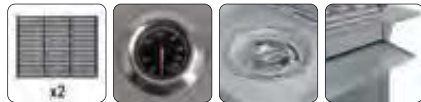

LUND

No. 99654

1

EN Gas grill
 PL Grill gazowy
 DE Gasgrill
 RU Газовый гриль
 CZ Plynový gril
 RO Grătar pe gaz
 HU Gázgrill
 ES Barbacoa de gas

FEATURES:
 - Ignition in the knob
 - Thermo gauge
 - Sliding tray for fat
 - Space for a gas bottle
 - Wheels with a brake

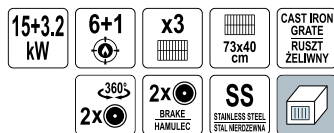

CECHY:
 - Zapalnik w pokrętle
 - Termometr
 - Wysuwana taca na tłuszcz
 - Miejsce na butlę gazową
 - Kola z hamulcem



LUND

No. 99656

1

EN Gas grill
 PL Grill gazowy
 DE Gasgrill
 RU Газовый гриль
 CZ Plynový gril
 RO Grătar pe gaz
 HU Gázgrill
 ES Barbacoa de gas

FEATURES:
 - Ignition in the knob
 - Thermo gauge
 - Sliding tray for fat
 - Space for a gas bottle
 - Wheels with a brake

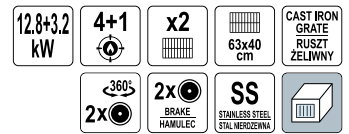

CECHY:
 - Zapalnik w pokrętle
 - Termometr
 - Wysuwana taca na tłuszcz
 - Miejsce na butlę gazową
 - Kola z hamulcem



LUND

No. 99655

1

EN Grill plate
 PL Płyta grillowa
 DE Grillplatte
 RU Пластина для гриля
 CZ Grilovací deska
 RO Placă pt. grătar
 HU Grill lap
 ES Plancha para barbacoa



LUND

No. 99659

For / Dla

99642, 99643, 99651, 99652, 99653, 99654, 99655

5

EN Gas regulator and hose
 PL Reduktor gazowy z węzłem
 DE Gasregler mit Schlauch
 RU Газовый редуктор со шлангом
 CZ Plynový regulátor a hadice
 RO Regulator de gaz cu furtun
 HU Nyomákszabályozó szett
 ES Regulador de gas con manguera



VOREL

No. 99670
 99671

L [m]
 1.0
 1.5

16
 16

EN Portable charcoal grill
 PL Grill węglowy przenośny
 DE Tragbarer Holzkohlegrill
 RU Переносной угольный гриль
 CZ Přenosný gril na dřevěné uhlí
 RO Grătar portabil cu cărbune
 HU Hordozható faszenes grill
 ES Barbacoa de carbón portátil



FEATURES:
 - Grate height: 18 cm
 - Enamelled charcoal plate
 - 3 buckles

CECHY:
 - Wysokość rusztu: 18 cm
 - Emalowana płyta na węgiel
 - 3 klamry

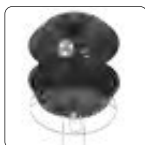

LUND

No.

99921



4

EN Charcoal grill
 PL Grill węglowy
 DE Holzkohlegrill
 RU Гриль угольный
 CZ Gril na dřevěné uhlí
 RO Grătar cărbuni
 HU Faszén grill
 ES Barbacoa de carbón

FEATURES:
 - Firebowl height: 59 cm
 - Metal shelf
 - Metal handle

CECHY:
 - Wysokość paleniska: 59 cm
 - Metalowa półka
 - Metalowy uchwyt



LUND

No.

99919



1

EN Charcoal grill
 PL Grill węglowy
 DE Holzkohlegrill
 RU Гриль угольный
 CZ Gril na dřevěné uhlí
 RO Grătar cărbuni
 HU Faszén grill
 ES Barbacoa de carbón

FEATURES:
 - Grate height: 57 cm
 - Air flow
 - Ashpan

CECHY:
 - Wysokość rusztu: 57 cm
 - Obieg powietrza
 - Popielnik

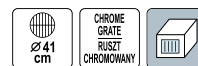

LUND

No.

99918



1

EN Portable charcoal grill
 PL Grill węglowy przenośny
 DE Tragbarer Holzkohlegrill
 RU Переносной угольный гриль
 CZ Přenosný gril na dřevěné uhlí
 RO Grătar portabil cu cărbune
 HU Hordozható faszenes grill
 ES Barbacoa de carbón portátil



FEATURES:
 - Grate height: 21 cm
 - Galvanized charcoal plate
 - 3 buckles

CECHY:
 - Wysokość rusztu: 21 cm
 - Galwanizowana płyta na węgiel
 - 3 klamry



LUND

No.

99922



4

EN Charcoal grill
 PL Grill węglowy
 DE Holzkohlegrill
 RU Гриль угольный
 CZ Gril na dřevěné uhlí
 RO Grătar cărbuni
 HU Faszén grill
 ES Barbacoa de carbón

FEATURES:
 - Firebowl height: 69.5 cm
 - Wooden handle
 - 2 wooden shelves

CECHY:
 - Wysokość paleniska: 69.5 cm
 - DREWNIANY UCHWYT
 - 2 drewniane półki

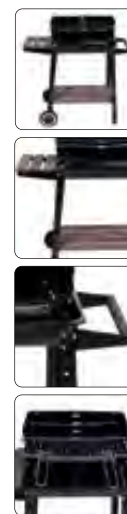
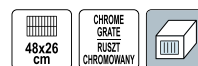

LUND

No.

99907



1



EN Charcoal grill
 PL Grill węglowy
 DE Holzkohlegrill
 RU Гриль угольный
 CZ Gril na dřevěné uhlí
 RO Grătar cărbuni
 HU Faszén grill
 ES Barbacoa de carbón

FEATURES:

- Grate height: 59 cm
- Air flow
- Ashpan
- Rain cover

CECHY:

- Wysokość rusztu: 59 cm
- Obieg powietrza
- Popielnik
- Pokrowiec przeciwdeszczowy



LUND

No.

99906



1

EN Charcoal grill
 PL Grill węglowy
 DE Holzkohlegrill
 RU Гриль угольный
 CZ Gril na dřevěné uhlí
 RO Grătar cărbuni
 HU Faszén grill
 ES Barbacoa de carbón

FEATURES:

- Firebowl height: 65 cm
- Warming rack: 45 x 8 cm
- 3 wooden shelves

CECHY:

- Wysokość paleniska: 65 cm
- Kształka podgrzewająca: 45 x 8 cm
- 3 drewniane półki



LUND

No.

99911



1

EN Charcoal grill
 PL Grill węglowy
 DE Holzkohlegrill
 RU Гриль угольный
 CZ Gril na dřevěné uhlí
 RO Grătar cărbuni
 HU Faszén grill
 ES Barbacoa de carbón

FEATURES:

- Air flow
- Metal shelf

CECHY:

- Obieg powietrza
- Metalowa półka



LUND

No.

99904



1

EN Charcoal grill
 PL Grill węglowy
 DE Holzkohlegrill
 RU Гриль угольный
 CZ Gril na dřevěné uhlí
 RO Grătar cărbuni
 HU Faszén grill
 ES Barbacoa de carbón

FEATURES:

- Grill adjustment
- 3 wooden shelves
- Air flow

CECHY:

- Regulacja rusztu
- 3 drewniane półki
- Obieg powietrza



LUND

No.

99905



1

EN Charcoal grill
 PL Grill węglowy
 DE Holzkohlegrill
 RU Гриль угольный
 CZ Gril na dřevěné uhlí
 RO Grătar carbuni
 HU Faszén grill
 ES Barbacoa de carbón



FEATURES:
 - Grate height: 52, 55, 59 cm

CECHY:
 - Wysokość rusztu: 52, 55, 59 cm



LUND

No.	1
99923	1

EN Charcoal grill
 PL Grill węglowy
 DE Holzkohlegrill
 RU Гриль угольный
 CZ Gril na dřevěné uhlí
 RO Grătar carbuni
 HU Faszén grill
 ES Barbacoa de carbón



FEATURES:
 - Thermo gauge
 - Air flow
 - Chimney

CECHY:
 - Termometr
 - Obieg powietrza
 - Komin



No.	1
99902	1

EN Charcoal grill
 PL Grill węglowy
 DE Holzkohlegrill
 RU Гриль угольный
 CZ Gril na dřevěné uhlí
 RO Grătar carbuni
 HU Faszén grill
 ES Barbacoa de carbón



FEATURES:
 - Thermo gauge
 - Air flow
 - Ashpan

CECHY:
 - Termometr
 - Obieg powietrza
 - Popielnik

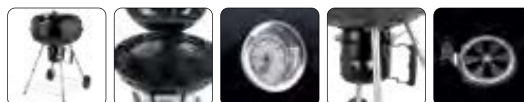

LUND

No.	1
99584	1

EN Charcoal grill with smoker
 PL Grill węglowy z wędzarnią
 DE Holzkohlegrill mit Räucherammer
 RU Гриль-копильня
 CZ Gril na dřevěné uhlí s udrinou
 RO Grătar carbuni cu afumătoare
 HU Faszén grill füstölővel
 ES Barbacoa de carbón con ahumador

FEATURES:
 - Thermo gauge
 - Smoker
 - Chimney

CECHY:
 - Termometr
 - Wędzarnia
 - Komin



No.	1
99901	1

EN Charcoal grill
 PL Grill węglowy
 DE Holzkohlegrill
 RU Гриль угольный
 CZ Gril na dřevěné uhlí
 RO Grătar cărbuni
 HU Faszén grill
 ES Barbacoa de carbón

FEATURES:
 - Firebowl height: 75 cm
 - 2 wooden shelves
 - Thermo gauge
 - Air flow
 - Ashpan

CECHY:
 - Wysokość paleniska: 75 cm
 - 2 drewniane półki
 - Termometr
 - Obieg powietrza
 - Popielnik



LUND

No.
99908

1

EN Charcoal grill with smoker
 PL Grill węglowy z wędzarnią
 DE Holzkohlegrill mit Räucherammer
 RU Гриль-копильня
 CZ Gril na dřevěné uhlí s udiťmou
 RO Grătar cărbuni cu afumătoare
 HU Faszén grill füstfővel
 ES Barbacoa de carbón con ahumador



FEATURES:
 - Firebowl height: 85.5 cm
 - Smoker
 - Thermo gauge
 - Air flow
 - Chimney
 - Ashpan



CECHY:
 - Wysokość paleniska: 85.5 cm
 - Wędzarnia
 - Termometr
 - Obieg powietrza
 - Komin
 - Popielnik

LUND

No.
99909

1

EN Charcoal grill
 PL Grill węglowy
 DE Holzkohlegrill
 RU Гриль угольный
 CZ Gril na dřevěné uhlí
 HU Faszén grill
 ES Barbacoa de carbón

FEATURES:
 - Metal fireplace
 - Thermo gauge
 - Air flow
 - Ashpan

CECHY:
 - Płyta żaroodporna
 - Termometr
 - Obieg powietrza
 - Popielnik



LUND

No.
99900

1

EN Charcoal grill
 PL Grill węglowy
 DE Holzkohlegrill
 RU Гриль угольный
 CZ Gril na dřevěné uhlí
 HU Faszén grill
 ES Barbacoa de carbón

FEATURES:
 - Firebowl height: 85 cm
 - Grill adjustment system
 - Air flow
 - Thermo gauge
 - Ashpan
 - Folding shelf

CECHY:
 - Wysokość paleniska: 85 cm
 - System regulacji rusztu
 - Obieg powietrza
 - Termometr
 - Popielnik
 - Składana półka



LUND

No.
99910

1

EN Charcoal grill
 PL Grill węglowy
 DE Holzkohleggrill
 RU Гриль угольный
 CZ Gril na dřevěné uhlí
 RO Grătar carbuni
 HU Faszén grill
 ES Barbacoa de carbón

FEATURES:

- Grate height: 85 cm
- Grill adjustment system
- Warming rack: 75 x 24 cm
- Thermo gauge
- Folding shelves
- Air flow
- Bottle opener
- Ashpan

CECHY:

- Wysokość rusztu: 85 cm
- System regulacji rusztu
- Kratka podgrzewająca: 75 x 24 cm
- Termometr
- Składane półki
- Obieg powietrza
- Otwieracz do butelek
- Popielnik



LUND

No. 99917 1

EN Smoker
 PL Wędzarnia
 DE Räucherei
 RU Коптильня
 CZ Udírna
 RO Afumătoare
 HU Füstölővel
 ES Ahumador

FEATURES:

- Thermo gauge
- 2 x cooking grill
- 2 x porcelain bowl
- 4 x vent

CECHY:

- Termometr
- 2 ruszty
- 2 porcelanowe miski
- 4 otwory wentylacyjne



LUND

No. 99916 1

EN Smoker
 PL Wędzarnia
 DE Räucherei
 RU Коптильня
 CZ Udírna
 RO Afumătoare
 HU Füstölővel
 ES Ahumador

FEATURES:

- Thermo gauge
- 2 x cooking grill
- 2 x porcelain bowl
- 4 x hangers
- Air flow

CECHY:

- Termometr
- 2 ruszty
- 2 porcelanowe miski
- 4 haczyki
- Obieg powietrza

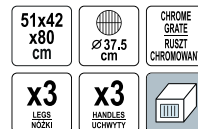

LUND

No. 99920 1

EN Tripod hanging grill
 PL Grill wiszący na trójnogu
 DE Dreibein-Schwenkgrill
 RU Гриль подвесной на штативе
 CZ Závěsný gril na stativu
 RO Grătar suspendat pe trepid
 HU Fűgő grill háromlábú állványon
 ES Barbacoa colgante en trípode



LUND

No. 99903 1

EN Tripod hanging grill
 PL Grill wiszący na trójnogu
 DE Dreibein-Schwenkgrill
 RU Гриль подвесной на штативе
 CZ Závěsný grill na stativu
 RO Grătar suspendat pe trepied
 HU Fűgő grill háromlábú állványal
 ES Barbacoa colgante en trípode



INCLUDED:

- Poker

W ZESTAWIE:

- Pogrzebacz

LUND

No.

99924



1

EN Fire pit
 PL Palenisko ogrodowe
 DE Gartenfeuerstelle
 RU Садовый очаг
 CZ Zahradní ohniště
 RO Vatră de foc pt. grădină
 HU Kerti tűzrakó
 ES Fogón para jardín

INCLUDED:

- Poker

W ZESTAWIE:

- Pogrzebacz

FEATURES:

- Folding legs

CECHY:

- Składane nóżki

56x39
cm

x3
LESS
NOZKI



LUND

No.

99912



1

EN Fire pit
 PL Palenisko ogrodowe
 DE Gartenfeuerstelle
 RU Садовый очаг
 CZ Zahradní ohniště
 RO Vatră de foc pt. grădină
 HU Kerti tűzrakó
 ES Fogón para jardín

INCLUDED:

- Poker

W ZESTAWIE:

- Pogrzebacz

42x53
cm

x4
LESS
NOZKI

x2
HANDLES
USHWYTY

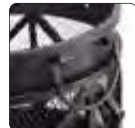

LUND

No.

99702



1

EN Fire pit
 PL Palenisko ogrodowe
 DE Gartenfeuerstelle
 RU Садовый очаг
 CZ Zahradní ohniště
 RO Vatră de foc pt. grădină
 HU Kerti tűzrakó
 ES Fogón para jardín

INCLUDED:

- Steel ash

- Poker

W ZESTAWIE:

- Stalowy popielnik

- Pogrzebacz

45x45
x34
cm



LUND

No.

99715



1

EN Fire pit
 PL Palenisko ogrodowe
 DE Gartenfeuerstelle
 RU Садовый очаг
 CZ Zahradní ohniště
 RO Vatră de foc pt. grădină
 HU Kerti tűzrakó
 ES Fogón para jardín

INCLUDED:

- Steel poker

- Log store

W ZESTAWIE:

- Stalowy pogrzebacz

- Drewnitnia

58x58
x55
cm



LUND

No.

99914



1

EN Fire pit
 PL Palenisko ogrodowe
 DE Gartenfeuerstelle
 RU Садовый очаг
 CZ Zahradní ohniště
 RO Vatră de foc pt. grădină
 HU Kerti tűzrakó
 ES Fogón para jardín

INCLUDED:

- Poker

W ZESTAWIE:

- Pogrzebacz

80x80
x61
cm



LUND

No.

99915



1

- EN Fire pit
- PL Palenisko ogrodowe
- DE Gartenfeuerstelle
- RU Садовый очаг
- CZ Zahradní ohniště
- RO Vatră de foc pt. grădină
- HU Kerti tűzrakó
- ES Fogón para jardín

INCLUDED:

- Poker

W ZESTAWIE:

- Pogrzebacz



LUND

No.	1
99913	1

- EN Fire pit
- PL Palenisko ogrodowe
- DE Gartenfeuerstelle
- RU Садовый очаг
- CZ Zahradní ohniště
- RO Vatră de foc pt. grădină
- HU Kerti tűzrakó
- ES Fogón para jardín



INCLUDED:

- Poker

W ZESTAWIE:

- Pogrzebacz



LUND

No.	1
99707	1

- EN Fire pit
- PL Palenisko ogrodowe
- DE Gartenfeuerstelle
- RU Садовый очаг
- CZ Zahradní ohniště
- RO Vatră de foc pt. grădină
- HU Kerti tűzrakó
- ES Fogón para jardín

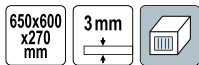

LUND

No.	1
99704	1

- EN Fire pit
- PL Palenisko ogrodowe
- DE Gartenfeuerstelle
- RU Садовый очаг
- CZ Zahradní ohniště
- RO Vatră de foc pt. grădină
- HU Kerti tűzrakó
- ES Fogón para jardín

INCLUDED:

- Wrought iron charcoal grate

- Poker

W ZESTAWIE:

- Kratka na węgiel z kutego żelaza

- Pogrzebacz

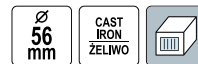

LUND

No.	1
99716	1

- EN Fire pit
- PL Palenisko ogrodowe
- DE Gartenfeuerstelle
- RU Садовый очаг
- CZ Zahradní ohniště
- RO Vatră de foc pt. grădină
- HU Kerti tűzrakó
- ES Fogón para jardín

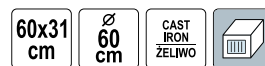

LUND

No.	1
99711	1

- EN Fire pit
- PL Palenisko ogrodowe
- DE Gartenfeuerstelle
- RU Садовый очаг
- CZ Zahradní ohniště
- RO Vatră de foc pt. grădină
- HU Kerti tűzrakó
- ES Fogón para jardín

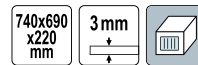

LUND

No.	1
99705	1

EN Fire pit
 PL Palenisko ogrodowe
 DE Gartenfeuerstelle
 RU Садовый очаг
 CZ Zahradní ohniště
 RO Vatră de foc pt. grădină
 HU Kerti tűzrakó
 ES Fogón para jardín

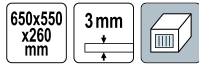

LUND

No.	1	
99706		

EN Grill cover
 PL Pokrowiec na grilla
 DE Grillabdeckung
 RU Чехол для гриля
 CZ Ochranný obal na gril
 RO Husă pt. grătar
 HU Grill takaróponyva
 ES Cubierta de barbacoa

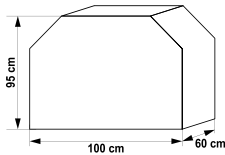

LUND

No.	Dimensions / Wymiary [cm]	For / Dla	1
99760	100x60x95	99495, 99512, 99514, 99519, 99586, 99588, 99595, 99644, 99645, 99646, 99900, 99902, 99908, 99910	20

EN Grill cover
 PL Pokrowiec na grilla
 DE Grillabdeckung
 RU Чехол для гриля
 CZ Ochranný obal na gril
 RO Husă pt. grătar
 HU Grill takaróponyva
 ES Cubierta de barbacoa

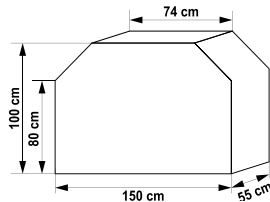

LUND

No.	Dimensions / Wymiary [cm]	For / Dla	1
99762	150x55x100	99643, 99649, 99652, 99653, 99655, 99656	20

EN Fire pit
 PL Palenisko ogrodowe
 DE Gartenfeuerstelle
 RU Садовый очаг
 CZ Zahradní ohniště
 RO Vatră de foc pt. grădină
 HU Kerti tűzrakó
 ES Fogón para jardín

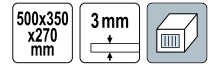

LUND

No.	1	
99708		

EN Grill cover
 PL Pokrowiec na grilla
 DE Grillabdeckung
 RU Чехол для гриля
 CZ Ochranný obal na gril
 RO Husă pt. grătar
 HU Grill takaróponyva
 ES Cubierta de barbacoa

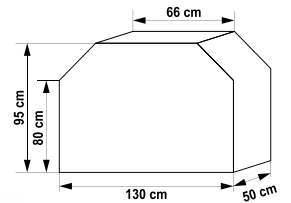

LUND

No.	Dimensions / Wymiary [cm]	For / Dla	1
99761	130x50x95	99642, 99647, 99649, 99651, 99654, 99917	20

EN BBQ apron
 PL Fartuch do grillowania
 DE Grillschürze
 RU Фартук для барбекю
 CZ Grilovací zástěra
 RO Șorț grătar
 HU Grill kötény
 ES Delantal de la parrilla



No.	60	
99782		

- EN BBQ apron with accessories
- PL Fartuch do grillowania z akcesoriami
- DE Grillschürze
- RU Фартук для барбекю
- CZ Grilovací zástěra
- RO Șort grătar cu accesorii
- HU Grill kőtény
- ES Delantal de la parrilla



No.		
99783		8/16

- EN Charcoal chimney
- PL Komin do rozpalania węgla
- DE Anzündkamin
- RU Устройство для зажигания угля
- CZ Zapalovací komin
- RO Dispozitiv pt. aprins carbuni
- HU Faszényújtó kémény
- ES Encendedor de carbón



LUND

No.	Ø [mm]	H [mm]	
99805	170	270	12

- EN Grill cleaning brush
- PL Szczotka do grilla
- DE Grillbürste
- RU Щетка для гриля
- CZ Kartáč na gril
- RO Perie pt. grătar
- HU Grillkefe
- ES Cepillo para barbacoa



VOREL

No.	L [mm]	
99528	305	16

- EN Barbecue fork
- PL Widelec ogniskowy
- DE Lagerfeuerspies
- RU Шампур-вилка для гриля
- CZ Vídlička na opékání
- RO Furculita pt. gratar
- HU Grillvilla
- ES Tenedor de fuego



No.	L [cm]	
99568	100	10/100

- EN Barbecue air blower
- PL Dmuchawa do rozpalania grilla
- DE Grillgebläse
- RU Ручной вентилятор для гриля и барбекю
- CZ Ruční dmychadlo ke grilu
- RO Suflantă de aer pt. grătar
- HU Kézi fúvó a grillezéshez
- ES Soplador para encender barbacoas



LUND

No.	L [mm]	
99800	250	36

- EN Heat resistant gloves
- PL Rękawice odporne na wysoką temperaturę
- DE Hitzebeständige Handschuhe
- RU Термостойкие перчатки
- CZ Tepelně odolné rukavice
- RO Mănuși rezistente la căldură
- HU Hőálló kesztyű
- ES Guantes para altas temperaturas



LUND

No.	
99820	50

- EN Barbecue fork
- PL Widelec ogniskowy
- DE Lagerfeuerspies
- RU Шампур-вилка для гриля
- CZ Vídlička na opékání
- RO Furculita pt. gratar
- HU Grillvilla
- ES Tenedor de fuego



No.	L [cm]	
99575	120	60



EN Barbecue fork
 PL Widelec ogniskowy
 DE Lagerfeuerspies
 RU Шампур-вилка для гриля
 CZ Vidička na opekání
 RO Furculita pt. gratar
 HU Grillvilla
 ES Tenedor de fuego



No.	L [cm]	
99576	120	60

Memo

24

25

Sanitary ware & hydraulics
Armatura sanitarna i hydraulika

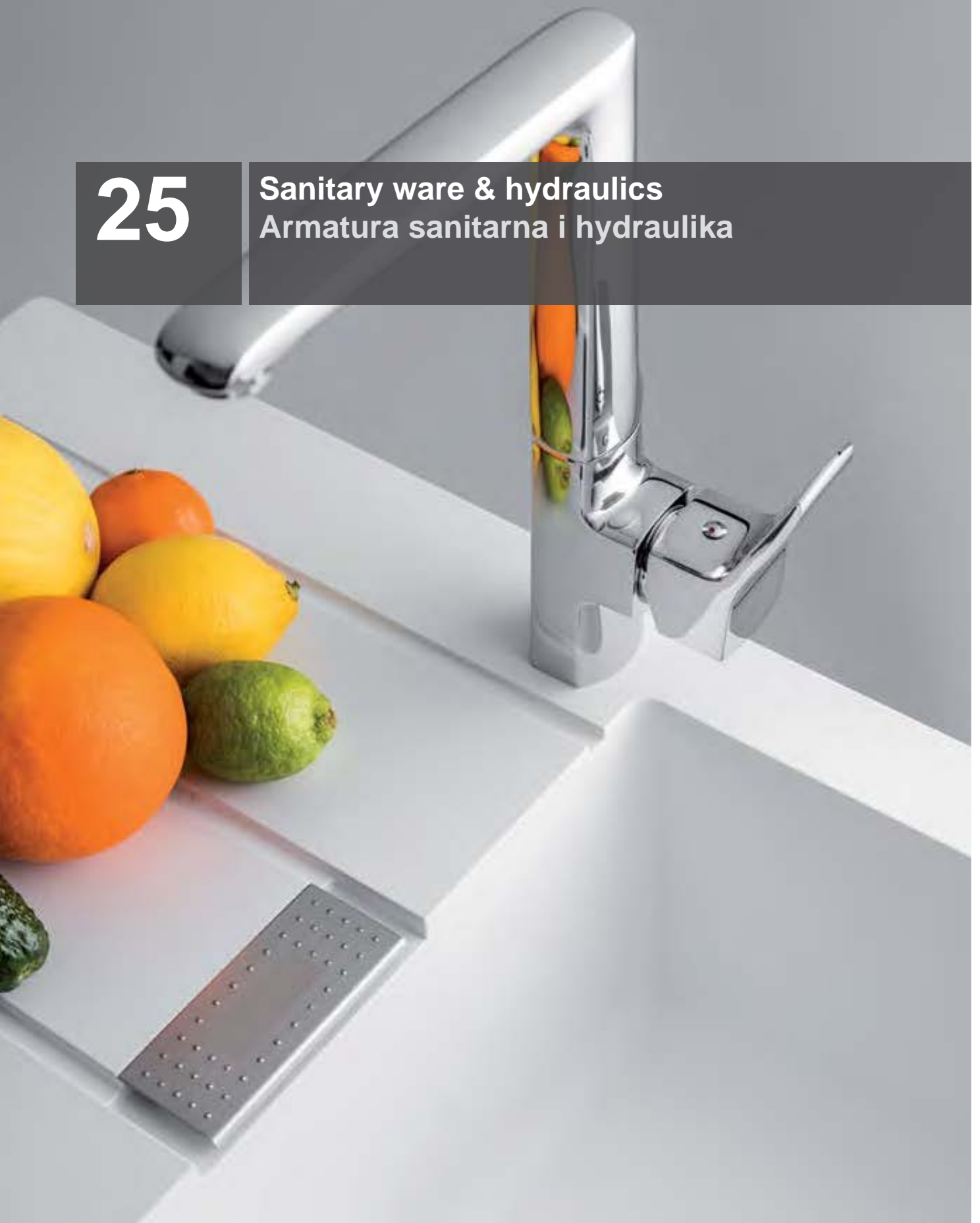

Mixers, faucets
Baterie

460-472

**Linear drains**
Odpływy liniowe

472-475

**Pop-up wastes**
Korki automatyczne

475-476

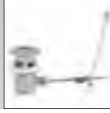
**Shower handles**
Słuchawki prysznicowe

476-479

**Shower & connecting hoses**
Wężę prysznicowe i przyłączeniowe

480-482

**Bathroom & shower sets**
Komplety łazienkowe i prysznicowe

483

**Bathroom accessories**
Akcesoria łazienkowe

483-486

**Toilet seats**
Deski toaletowe

486-487

**Plastic stools**
Stołki plastikowe

488

**Hydraulic accessories**
Akcesoria hydrauliczne

488-490



<p>The exclusive composition with sapphire hardness developed by famous spanish company.</p> <p>Głowica z wkładem ceramicznym o twardości szafiru renomowanego hiszpańskiego producenta.</p>  <p>CORUNDOx</p>	<p>Mixing water flow with intake air reduces consumption by half, without splashing.</p> <p>Zmieszany strumień wody z zasysanym powietrzem oszczędza zużycie o połowę i nie chlapie.</p>  <p>ECOflow</p>	<p>The most effective way to save water and energy - flowing only cold water when the lever is centered.</p> <p>Najefektywniejszy sposób oszczędzania wody i energii - dla uchwytu usytuowanego na wprost popłyne tylko zimna woda.</p>  <p>ECOstart</p>
<p>Nano-size cavities on the disc surface to keep the lubrication, provides a higher durability and an improved smooth feeling.</p> <p>Mikrozagiębnienia dzięki którym smar w głowicy nie wypłukuje się i głowica działa gładko przez wiele lat.</p>  <p>NANOCave</p>	<p>Rubbing the lime away with a finger and the stream is like in brand new faucet again.</p> <p>Przetarcie palcem usuwa kamień i przywraca strumień jak w nowej baterii.</p>  <p>SMARTclean</p>	<p>Reduced noise thanks to silencer in eccentric wall connector.</p> <p>Obniżony hałas dzięki użyciu tłumików w złączach.</p>  <p>LOWnoise</p>
<p>Ergonomic faucet provides more space for comfortable using.</p> <p>Ergonomiczna bateria zapewniająca przestrzeń dla wygodnego użytkownika.</p>  <p>ERGOsize</p>	<p>Simple and effective installation thanks to the large nut that screw without any tools.</p> <p>Łatwy i trwały montaż dzięki dużej nakrętkie, którą przykręcisz bez użycia jakiegokolwiek narzędzi.</p>  <p>SMARTnut</p>	<p>Improved lime protection: integrated honeycomb structure replaces conventional wire mesh screens prone to lime build-up.</p> <p>Lepsza ochrona przeciwkwapinna: struktura plastra miodu zastępuje klasyczne wkłady siateczkowe, które mają tendencję do zarastania.</p>  <p>HEXAGONal</p>
<p>Body without holes and nooks that could accumulate dirt and microorganisms.</p> <p>Korpus bez otworów i zakamarków, które gromadzą brud i mikroorganizmy.</p>  <p>CLEANbody</p>	<p>Innovative mounting system for hose nut and safe servicing aerator.</p> <p>Innowacyjny system montażu wężyków i bezpiecznego serwisowania aeratora.</p>  <p>SMARTtool</p>	<p>Multi-purpose hydraulic wrench for installation of faucet and small plumbing work.</p> <p>Wielofunkcyjny klucz hydrauliczny do montażu baterii i drobnych prac hydraulicznych.</p>  <p>SMARTtool</p>
<p>High quality stainless steel is characterized by increased resistance to chemicals, preserving its appearance even after many years of use.</p> <p>Wysokiej jakości stal nierdzewna charakteryzuje się zwiększoną odpornością na chemikalia, zachowując swój wygląd nawet po wielu latach użytkowania.</p>  <p>Sus304</p>	<p>Stainless steel is free of zinc and lead - toxic elements, which in micro quantities get into the water in brass faucets.</p> <p>Stal nierdzewna jest wolna od cynku i ołowiu - toksycznych pierwiastków, które w mikro ilościach dostają się do wody w mosiężnych kranach.</p>  <p>NOlead</p>	<p>All parts are made of stainless steel, so they are rust-resistant.</p> <p>Wszystkie części wykonane są ze stali nierdzewnej i są odporne na rdzę.</p>  <p>FULL STEEL</p>

- EN Basin mixer
- PL Bateria umywalkowa
- DE Einhand-Waschtischbatterie
- RU Смеситель для раковины
- CZ Umyvadlová baterie
- RO Bateria lavoar
- HU Mosdó csaptelep
- ES Monomando de lavabo



FALA

No.	Series / Seria	
75801	Steely 1	20

- EN Basin mixer
- PL Bateria umywalkowa
- DE Einhand-Waschtischbatterie
- RU Смеситель для раковины
- CZ Umyvadlová baterie
- RO Bateria lavoar
- HU Mosdó csaptelep
- ES Monomando de lavabo

- EN Basin mixer
- PL Bateria umywalkowa
- DE Einhand-Waschtischbatterie
- RU Смеситель для раковины
- CZ Umyvadlová baterie
- RO Bateria lavoar
- HU Mosdó csaptelep
- ES Monomando de lavabo



FALA

No.	Series / Seria	
75802	Steely 2	12

FALA

No.	Series / Seria	
75803	Steely 3	10



EN Shower column
 PL Kolumna prysznicowa
 DE Duschsäule
 RU Душевая штанга
 CZ Sprchový sloup
 RO Coloană de duș
 HU Zuhanyoszlop
 ES Columna de ducha



FALA

No.	Series / Seria	5
75662	Steely 1	5

EN Shower column
 PL Kolumna prysznicowa
 DE Duschsäule
 RU Душевая штанга
 CZ Sprchový sloup
 RO Coloană de duș
 HU Zuhanyoszlop
 ES Columna de ducha



FALA

No.	Series / Seria	5
75664	Steely 3	5

EN Single-lever sink mixer
 PL Bateria zlewozmywakowa
 DE Einhand-Spültischbatterie
 RU Смеситель для кухни
 CZ Dřezová baterie
 RO Baterie bucătărie
 HU Mosogató csaptelep
 ES Monomando de fregadero

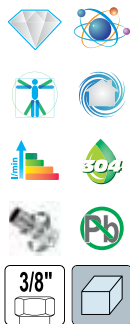

FALA

No.	Series / Seria	10
75716	Steely 1	10

EN Shower column
 PL Kolumna prysznicowa
 DE Duschsäule
 RU Душевая штанга
 CZ Sprchový sloup
 RO Coloană de duș
 HU Zuhanyoszlop
 ES Columna de ducha



FALA

No.	Series / Seria	5
75663	Steely 2	5

EN Shower column
 PL Kolumna prysznicowa
 DE Duschsäule
 RU Душевая штанга
 CZ Sprchový sloup
 RO Coloană de duș
 HU Zuhanyoszlop
 ES Columna de ducha



FALA

No.	Series / Seria	5
75665	Steely 4	5

EN Single-lever sink mixer
 PL Bateria zlewozmywakowa
 DE Einhand-Spültischbatterie
 RU Смеситель для кухни
 CZ Dřezová baterie
 RO Baterie bucătărie
 HU Mosogató csaptelep
 ES Monomando de fregadero

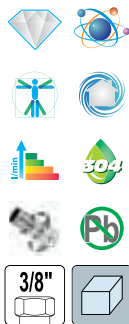

FALA

No.	Series / Seria	10
75718	Steely 2	10

EN Single-lever sink mixer
 PL Bateria zlewozmywakowa
 DE Einhand-Spültischbatterie
 RU Смеситель для кухни
 CZ Dřezová baterie
 RO Baterie bucătărie
 HU Mosogató csaptelep
 ES Monomando de fregadero



FALA

No.	Series / Seria	Box
75719	Steely 3	10

EN Built-in shower system
 PL Podtynkowy system prysznicowy
 DE Unterputz-duschsystem
 RU Душевой гарнитур скрытого монтажа
 CZ Sprchový podomítkový set
 RO Set de duș cu baterie încastrată
 HU Falsík alatti zuhanyszett
 ES Sistema dual de ducha empotrado



FALA

No.	Series / Seria	Box
75870	Steely R	4

EN Bath mixer
 PL Bateria wannowa
 DE Einhand-Wannenbatterie
 RU Смеситель для ванны
 CZ Vanové baterie
 RO Baterie cada / dus
 HU Egykaros kádcsaptelep
 ES Monomando para baño



FALA

No.	Series / Seria	Box
75808	Retro Black 1	12

EN Single-lever sink mixer
 PL Bateria zlewozmywakowa
 DE Einhand-Spültischbatterie
 RU Смеситель для кухни
 CZ Dřezová baterie
 RO Baterie bucătărie
 HU Mosogató csaptelep
 ES Monomando de fregadero



FALA

No.	Series / Seria	Box
75805	Steely 4	5

EN Basin mixer
 PL Bateria umywalkowa
 DE Einhand-Waschtischbatterie
 RU Смеситель для раковины
 CZ Umyvadlová baterie
 RO Baterie lavoar
 HU Mosdó csaptelep
 ES Monomando de lavabo



FALA

No.	Series / Seria	Box
75807	Retro Black 1	12

EN Shower column
 PL Kolumna prysznicowa
 DE Duschsäule
 RU Душевая штанга
 CZ Sprchový sloup
 RO Coloană de duș
 HU Zuhanyoszlop
 ES Columna de ducha



FALA

No.	Series / Seria	Box
75809	Retro Black 1	5

EN Basin mixer
 PL Bateria umywalkowa wysoka
 DE Einhand-Waschtischbatterie
 RU Смеситель для раковины
 CZ Umyvadlová baterie
 RO Baterie lavoar
 HU Mosdó csaptelep
 ES Monomando de lavabo



FALA

No.	Series / Seria	
75812	Retro Black 2	12

EN Basin mixer
 PL Bateria umywalkowa wysoka
 DE Einhand-Waschtischbatterie
 RU Смеситель для раковины
 CZ Umyvadlová baterie
 RO Baterie lavoar
 HU Mosdó csaptelep
 ES Monomando de lavabo



FALA

No.	Series / Seria	
75815	Retro Black 3	12

EN Shower column
 PL Kolumna prysznicowa
 DE Duschsäule
 RU Душевая штанга
 CZ Sprchový sloup
 RO Coloană de duș
 HU Zuhanyoszlop
 ES Columna de ducha



FALA

No.	Series / Seria	
75818	Retro Black 3	5

EN Shower column
 PL Kolumna prysznicowa
 DE Duschsäule
 RU Душевая штанга
 CZ Sprchový sloup
 RO Coloană de duș
 HU Zuhanyoszlop
 ES Columna de ducha



FALA

No.	Series / Seria	
75813	Retro Black 2	5

EN Single-lever shower mixer
 PL Bateria prysznicowa
 DE Einhand-Brausebatterie
 RU Смеситель для душа
 CZ Sprchová baterie
 RO Baterie dus
 HU Egykaros zuhanycsaptelep
 ES Monomando de ducha



FALA

No.	Series / Seria	
75817	Retro Black 3	12

EN Basin mixer
 PL Bateria umywalkowa
 DE Einhand-Waschtischbatterie
 RU Смеситель для раковины
 CZ Umyvadlová baterie
 RO Baterie lavoar
 HU Mosdó csaptelep
 ES Monomando de lavabo



FALA

No.	Series / Seria	
75827	Retro Bronze 1	12

EN Bath mixer
 PL Bateria wannowa
 DE Einhand-Wannenbatterie
 RU Смеситель для ванны
 CZ Vanové baterie
 RO Baterie cada / dus
 HU Egykaros kádcsaptelep
 ES Monomando para baño



FALA

No.	Series / Seria	
75828	Retro Bronze 1	12

EN Basin mixer
 PL Bateria umywalkowa
 DE Einhand-Waschtischbatterie
 RU Смеситель для раковины
 CZ Umyvadlová baterie
 RO Baterie lavoar
 HU Mosdó csaptelep
 ES Monomando de lavabo



FALA

No.	Series / Seria	
75836	Retro Bronze 2	12

EN Shower column
 PL Kolumna prysznicowa
 DE Duschsäule
 RU Душевая штанга
 CZ Sprchový sloup
 RO Coloană de duș
 HU Zuhanyoszlop
 ES Columna de ducha



FALA

No.	Series / Seria	
75838	Retro Bronze 2	5

EN Shower column
 PL Kolumna prysznicowa
 DE Duschsäule
 RU Душевая штанга
 CZ Sprchový sloup
 RO Coloană de duș
 HU Zuhanyoszlop
 ES Columna de ducha



FALA

No.	Series / Seria	
75829	Retro Bronze 1	5

EN Basin mixer
 PL Bateria umywalkowa wysoka
 DE Einhand-Waschtischbatterie
 RU Смеситель для раковины
 CZ Umyvadlová baterie
 RO Baterie lavoar
 HU Mosdó csaptelep
 ES Monomando de lavabo



FALA

No.	Series / Seria	
75837	Retro Bronze 2	12

EN Single-lever sink mixer
 PL Bateria zlewozmywakowa
 DE Einhand-Spültischbatterie
 RU Смеситель для кухни
 CZ Dřezová baterie
 RO Baterie bucătărie
 HU Mosogató csaptelep
 ES Monomando de fregadero



FALA

No.	Series / Seria	
75834	Retro Black 1	12

EN Single-lever sink mixer
 PL Bateria zlewozmywakowa
 DE Einhand-Spültischbatterie
 RU Смеситель для кухни
 CZ Dřezová baterie
 RO Baterie bucătărie
 HU Mosogató csaptelep
 ES Monomando de fregadero

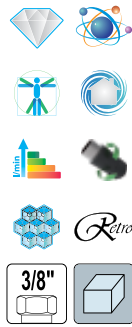

FALA

No.	Series / Seria	
75835	Retro Black 2	12

EN Single-lever sink mixer
 PL Bateria zlewozmywakowa
 DE Einhand-Spültischbatterie
 RU Смеситель для кухни
 CZ Dřezová baterie
 RO Baterie bucătărie
 HU Mosogató csaptelep
 ES Monomando de fregadero



FALA

No.	Series / Seria	
75830	Retro Bronze 1	12

EN Single-lever sink mixer
 PL Bateria zlewozmywakowa
 DE Einhand-Spültischbatterie
 RU Смеситель для кухни
 CZ Dřezová baterie
 RO Baterie bucătărie
 HU Mosogató csaptelep
 ES Monomando de fregadero

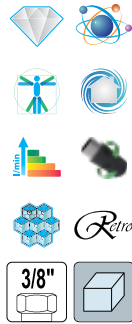

FALA

No.	Series / Seria	
75831	Retro Bronze 2	12

EN Single-lever sink mixer
 PL Bateria zlewozmywakowa
 DE Einhand-Spültischbatterie
 RU Смеситель для кухни
 CZ Dřezová baterie
 RO Baterie bucătărie
 HU Mosogató csaptelep
 ES Monomando de fregadero



FALA

No.	Series / Seria	
75832	Retro Bronze 3	12

EN Single-lever sink mixer
 PL Bateria zlewozmywakowa
 DE Einhand-Spültischbatterie
 RU Смеситель для кухни
 CZ Dřezová baterie
 RO Baterie bucătărie
 HU Mosogató csaptelep
 ES Monomando de fregadero

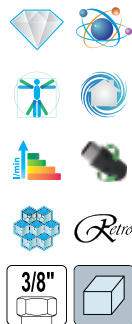

FALA

No.	Series / Seria	
75833	Retro Bronze 4	12

EN Single-lever sink mixer
 PL Bateria zlewozmywakowa
 DE Einhand-Spültischbatterie
 RU Смеситель для кухни
 CZ Dřezová baterie
 RO Baterie bucătărie
 HU Mosogató csaptelep
 ES Monomando de fregadero



FALA

No.	Series / Seria	
75884	Noir 1	12

EN Basin mixer
 PL Bateria umywalkowa
 DE Einhand-Waschtischbatterie
 RU Смеситель для раковины
 CZ Umyvadlová baterie
 RO Bateria lavoar
 HU Mosdó csaptelep
 ES Monomando de lavabo



FALA

No.	Series / Seria	Box
75885	Noir 2	12

EN Single-lever shower mixer
 PL Bateria prysznicowa
 DE Einhand-Brausebatterie
 RU Смеситель для душа
 CZ Sprchová baterie
 RO Bateria dus
 HU Egykaros zuhanycsaptelep
 ES Monomando de ducha



FALA

No.	Series / Seria	Box
75887	Noir 2	8

EN Shower column
 PL Kolumna prysznicowa
 DE Duschsäule
 RU Душевая штанга
 CZ Sprchový sloup
 RO Coloană de duș
 HU Zuhanyoszlop
 ES Columna de ducha



FALA

No.	Series / Seria	Box
75889	Noir 2	4

EN Basin mixer
 PL Bateria umywalkowa
 DE Einhand-Waschtischbatterie
 RU Смеситель для раковины
 CZ Umyvadlová baterie
 RO Bateria lavoar
 HU Mosdó csaptelep
 ES Monomando de lavabo



FALA

No.	Series / Seria	Box
75886	Noir 2	12

EN Bath mixer
 PL Bateria wannowa
 DE Einhand-Wannenbatterie
 RU Смеситель для ванны
 CZ Vanové baterie
 RO Bateria cada / dus
 HU Egykaros kádcsaptelep
 ES Monomando para baño



FALA

No.	Series / Seria	Box
75888	Noir 2	8

EN Single-lever sink mixer
 PL Bateria zlewozmywakowa
 DE Einhand-Spültischbatterie
 RU Смеситель для кухни
 CZ Dřezová baterie
 RO Bateria stativă bucatărie
 HU Mosogató csaptelep
 ES Monomando de fregadero



FALA

No.	Series / Seria	Box
75705	Flexible-Black	10



EN Single-lever sink mixer
 PL Bateria zlewozmywakowa
 DE Einhand-Spültischbatterie
 RU Смеситель для кухни
 CZ Dřezová baterie
 RO Baterie bucătărie
 HU Mosogató csaptelep
 ES Monomando de fregadero



FALA

No.	Series / Seria	Box
75706	Flexible-White	10

EN Single-lever sink mixer
 PL Bateria zlewozmywakowa
 DE Einhand-Spültischbatterie
 RU Смеситель для кухни
 CZ Dřezová baterie
 RO Baterie bucătărie
 HU Mosogató csaptelep
 ES Monomando de fregadero



FALA

No.	Series / Seria	Box
75708	Flexible-Orange	10

EN Single-lever sink mixer
 PL Bateria zlewozmywakowa
 DE Einhand-Spültischbatterie
 RU Смеситель для кухни
 CZ Dřezová baterie
 RO Baterie bucătărie
 HU Mosogató csaptelep
 ES Monomando de fregadero



FALA

No.	Series / Seria	Box
75710	Flexible-Light Grey	10

EN Single-lever sink mixer
 PL Bateria zlewozmywakowa
 DE Einhand-Spültischbatterie
 RU Смеситель для кухни
 CZ Dřezová baterie
 RO Baterie bucătărie
 HU Mosogató csaptelep
 ES Monomando de fregadero



FALA

No.	Series / Seria	Box
75707	Flexible-Red	10

EN Single-lever sink mixer
 PL Bateria zlewozmywakowa
 DE Einhand-Spültischbatterie
 RU Смеситель для кухни
 CZ Dřezová baterie
 RO Baterie bucătărie
 HU Mosogató csaptelep
 ES Monomando de fregadero



FALA

No.	Series / Seria	Box
75709	Flexible-Green	10

EN Single-lever sink mixer
 PL Bateria zlewozmywakowa
 DE Einhand-Spültischbatterie
 RU Смеситель для кухни
 CZ Dřezová baterie
 RO Baterie bucătărie
 HU Mosogató csaptelep
 ES Monomando de fregadero



FALA

No.	Series / Seria	Box
75711	Flexible-Dark Grey	10

EN Single-lever sink mixer
 PL Bateria zlewozmywakowa
 DE Einhand-Spültischbatterie
 RU Смеситель для кухни
 CZ Dřezová baterie
 RO Baterie bucătărie
 HU Mosogató csaptelep
 ES Monomando de fregadero



FALA

No.	Series / Seria	Box
75712	Flexible-Brown	10

EN Single-lever sink mixer
 PL Bateria zlewozmywakowa
 DE Einhand-Spültischbatterie
 RU Смеситель для кухни
 CZ Dřezová baterie
 RO Baterie bucătărie
 HU Mosogató csaptelep
 ES Monomando de fregadero



FALA

No.	Series / Seria	Box
75775	Black Flexible-Black	10

EN Single-lever sink mixer
 PL Bateria zlewozmywakowa
 DE Einhand-Spültischbatterie
 RU Смеситель для кухни
 CZ Dřezová baterie
 RO Baterie bucătărie
 HU Mosogató csaptelep
 ES Monomando de fregadero



FALA

No.	Series / Seria	Box
75777	Black Flexible-Red	10

EN Single-lever sink mixer
 PL Bateria zlewozmywakowa
 DE Einhand-Spültischbatterie
 RU Смеситель для кухни
 CZ Dřezová baterie
 RO Baterie bucătărie
 HU Mosogató csaptelep
 ES Monomando de fregadero



FALA

No.	Series / Seria	Box
75729	Flexible-Steely Black	10

EN Single-lever sink mixer
 PL Bateria zlewozmywakowa
 DE Einhand-Spültischbatterie
 RU Смеситель для кухни
 CZ Dřezová baterie
 RO Baterie bucătărie
 HU Mosogató csaptelep
 ES Monomando de fregadero



FALA

No.	Series / Seria	Box
75776	Black Flexible-White	10

EN Single-lever sink mixer
 PL Bateria zlewozmywakowa
 DE Einhand-Spültischbatterie
 RU Смеситель для кухни
 CZ Dřezová baterie
 RO Baterie bucătărie
 HU Mosogató csaptelep
 ES Monomando de fregadero



FALA

No.	Series / Seria	Box
75778	Black Flexible-Orange	10

EN Single-lever sink mixer
 PL Bateria zlewozmywakowa
 DE Einhand-Spültischbatterie
 RU Смеситель для кухни
 CZ Dřezová baterie
 RO Baterie bucătărie
 HU Mosogató csaptelep
 ES Monomando de fregadero



FALA

No.	Series / Seria	Box
75779	Black Flexible-Green	10

EN Single-lever sink mixer
 PL Bateria zlewozmywakowa
 DE Einhand-Spültischbatterie
 RU Смеситель для кухни
 CZ Dřezová baterie
 RO Baterie bucătărie
 HU Mosogató csaptelep
 ES Monomando de fregadero



FALA

No.	Series / Seria	Box
75676	Flexible 2 White	10

EN Single-lever sink mixer
 PL Bateria zlewozmywakowa
 DE Einhand-Spültischbatterie
 RU Смеситель для кухни
 CZ Dřezová baterie
 RO Baterie bucătărie
 HU Mosogató csaptelep
 ES Monomando de fregadero

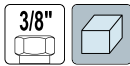
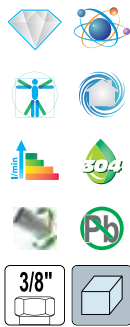

FALA

No.	Series / Seria	Box
75853	Steely Black 2	10

EN Single-lever sink mixer
 PL Bateria zlewozmywakowa
 DE Einhand-Spültischbatterie
 RU Смеситель для кухни
 CZ Dřezová baterie
 RO Baterie bucătărie
 HU Mosogató csaptelep
 ES Monomando de fregadero



FALA

No.	Series / Seria	Box
75675	Flexible 2 Black	10

EN Single-lever sink mixer
 PL Bateria zlewozmywakowa
 DE Einhand-Spültischbatterie
 RU Смеситель для кухни
 CZ Dřezová baterie
 RO Baterie bucătărie
 HU Mosogató csaptelep
 ES Monomando de fregadero

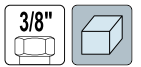
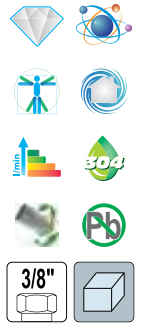

FALA

No.	Series / Seria	Box
75852	Steely Black 1	10

EN Single-lever sink mixer
 PL Bateria zlewozmywakowa scienna
 DE Einhand-Spültischbatterie
 RU Смеситель для кухни
 CZ Dřezová baterie
 RO Baterie bucătărie
 HU Mosogató csaptelep
 ES Monomando de fregadero

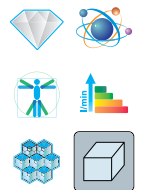

FALA

No.	Series / Seria	Box
75670	Flexible-Black	10

EN Single-lever sink mixer
 PL Bateria zlewozmywakowa ścienna
 DE Einhand-Spültischbatterie
 RU Смеситель для кухни
 CZ Dřezová baterie
 RO Baterie bucătărie
 HU Mosogató csaptelep
 ES Monomando de fregadero



FALA

No.	Series / Seria	Icon
75671	Flexible-White	10

EN Single-lever sink mixer
 PL Bateria zlewozmywakowa ścienna
 DE Einhand-Spültischbatterie
 RU Смеситель для кухни
 CZ Dřezová baterie
 RO Baterie bucătărie
 HU Mosogató csaptelep
 ES Monomando de fregadero



FALA

No.	Series / Seria	Icon
75672	Flexible-Red	10

EN Single-lever sink mixer
 PL Bateria zlewozmywakowa ścienna
 DE Einhand-Spültischbatterie
 RU Смеситель для кухни
 CZ Dřezová baterie
 RO Baterie bucătărie
 HU Mosogató csaptelep
 ES Monomando de fregadero



FALA

No.	Series / Seria	Icon
75673	Flexible-Orange	10

EN Single-lever sink mixer
 PL Bateria zlewozmywakowa ścienna
 DE Einhand-Spültischbatterie
 RU Смеситель для кухни
 CZ Dřezová baterie
 RO Baterie bucătărie
 HU Mosogató csaptelep
 ES Monomando de fregadero



FALA

No.	Series / Seria	Icon
75674	Flexible-Green	10

EN Organizer
 PL Organizer
 DE Organizer
 RU Органайзер
 CZ Organizér
 RO Organizator
 HU Szervező
 ES Organizador



FALA

No.	Icon
74785	144

EN Organizer
 PL Organizer
 DE Organizer
 RU Органайзер
 CZ Organizér
 RO Organizator
 HU Szervező
 ES Organizador



FALA

No.	Icon
74786	144

EN Organizer
 PL Organizator
 DE Organizer
 RU Организа́тор
 CZ Organizér
 RO Organizator
 HU Szervező
 ES Organizador



FALA

No.

74787



144

EN Organizer
 PL Organizator
 DE Organizer
 RU Организа́тор
 CZ Organizér
 RO Organizator
 HU Szervező
 ES Organizador



FALA

No.

74789



144

EN Mat
 PL Mata
 DE Matte
 RU Коврик
 CZ Podložka
 RO Suport antiderapant
 HU Lábtörő
 ES Alfombra



FALA

No.

74790



50/200

EN Mat
 PL Mata
 DE Matte
 RU Коврик
 CZ Podložka
 RO Suport antiderapant
 HU Lábtörő
 ES Alfombra



FALA

No.

74791



50/200

EN Mat
 PL Mata
 DE Matte
 RU Коврик
 CZ Podložka
 RO Suport antiderapant
 HU Lábtörő
 ES Alfombra



FALA

No.

74792



50/200

EN Mat
 PL Mata
 DE Matte
 RU Коврик
 CZ Podložka
 RO Suport antiderapant
 HU Lábtörő
 ES Alfombra



FALA

No.

74794



50/200

EN Soap dispenser
 PL Dozownik mydła w płynie
 DE Seifenspender
 RU Дозатор для мыла
 CZ Dávkovač mýdla
 RO Dozator sapun lichid
 HU Folyékonyszappan adagoló
 ES Dispensador de jabón



FALA

No.

69395



100

EN Soap dispenser
 PL Dozownik mydła w płynie
 DE Seifenspender
 RU Дозатор для мыла
 CZ Dávkovač mýdla
 RO Dozator sapun lichid
 HU Folyékonyszappan adagoló
 ES Dispensador de jabón



FALA

No.

69396



100

EN Soap dispenser
 PL Dozownik mydła w płynie
 DE Seifenspender
 RU Дозатор для мыла
 CZ Dávkovač mýdla
 RO Dozator sapun lichid
 HU Folyékonyszappan adagoló
 ES Dispensador de jabón



FALA

No.

69397



100

- EN Soap dispenser
- PL Dozownik mydła w płynie
- DE Seifenspender
- RU Дозатор для мыла
- CZ Dávkač mydla
- RO Dozator sapun lichid
- HU Folyékonyszappan adagoló
- ES Dispensador de jabón



FALA

No.		
69390		60

- EN Soap dispenser
- PL Dozownik mydła w płynie
- DE Seifenspender
- RU Дозатор для мыла
- CZ Dávkač mydla
- RO Dozator sapun lichid
- HU Folyékonyszappan adagoló
- ES Dispensador de jabón



FALA

No.		
69391		24

Special inspection window for 100% outflow control and comfortable cleaning.

Specjalne okienko rewizyjne to 100% kontroli drożności i wygodne czyszczenie.



SMARTthru

Easy to clean thanks to contained hook.

Łatwy do utrzymania w czystości dzięki dołączonemu haczykowi.



EASYclean

Stabilizing body grips, additional stiffening in the floor.

Uchwyty stabilizujące korpus. Dodatkowe usztywnienie konstrukcji w podłodze.



GRIPstrong

Waterproof cloth included – as essential part of waterproofing.

Mata uszczelniająca w zestawie – niezbędna część przy wykonywaniu hydroizolacji.



HYDROcloth

Effective and durable strainer which prevents clogging of the trap and makes cleaning easier.

Skuteczne i trwałe sito, które zapobiega zapychaniu syfonu oraz ułatwia bieżącą obsługę odpływu.



STRAINER

High quality precision welds guarantee no leaking of the drain.

Wysokiej jakości precyzyjne spawy gwarantujące szczelność odpływu.



HQwelding

Low siphon made of stainless steel AISI 304 makes installation easier.

Niski syfon wykonany ze stali nierdzewnej AISI 304 ułatwiający instalację.



52 mm

EXTRASlim

Wide range of height adjustment allows adjusting to the floor level.

Szeroki zakres regulacji wysokości, który umożliwi dopasowanie odpływu do powierzchni posadzki.



EASYfix

It can prevent stink and worms both in use and after dry (no water in siphon).

Zapobiega przedostawaniu się zapachów oraz robaków podczas używania jak i po wysuszeniu (brak wody w syfonie).



WET&DRY

- EN Linear drain
- PL Odpływ liniowy
- DE Duschrinne
- RU Душевой лоток
- CZ Odtokový žlab
- RO Rigola dus
- HU Zuhanyfolyóka
- ES Canal de ducha



- EN Linear drain
- PL Odpływ liniowy
- DE Duschrinne
- RU Душевой лоток
- CZ Odtokový žlab
- RO Rigola dus
- HU Zuhanyfolyóka
- ES Canal de ducha



FALA

No.	Body length / Długość rynny [mm]	Series / Seria	
75345	500	Rotary	5
75346	600	Rotary	5
75347	700	Rotary	5
75348	800	Rotary	5
75349	900	Rotary	5

FALA

No.	Body length / Długość rynny [mm]	Series / Seria	
75350	300	Brick	5
75351	400	Brick	5
75352	500	Brick	5
75353	600	Brick	5
75354	700	Brick	5
75355	800	Brick	5
75356	900	Brick	5

EN Linear drain
 PL Odpływ liniowy
 DE Duschrinne
 RU Душевой лоток

CZ Odtokový žlab
 RO Rigola dus
 HU Zuhanyfolyóka
 ES Canal de ducha



FALA

No.	Body length / Długość rynny [mm]	Series / Seria	Package	
75360	300	Madeira		6
75361	400	Madeira		6
75362	500	Madeira		6
75363	600	Madeira		6
75364	700	Madeira		6
75365	800	Madeira		6
75366	900	Madeira		6

EN Linear drain
 PL Odpływ liniowy
 DE Duschrinne
 RU Душевой лоток

CZ Odtokový žlab
 RO Rigola dus
 HU Zuhanyfolyóka
 ES Canal de ducha



FALA

No.	Body length / Długość rynny [mm]	Series / Seria	Package	
75374	300	Napo		6
75375	400	Napo		6
75376	500	Napo		6
75377	600	Napo		6
75378	700	Napo		6
75379	800	Napo		6
75380	900	Napo		6

EN Linear drain
 PL Odpływ liniowy
 DE Duschrinne
 RU Душевой лоток

CZ Odtokový žlab
 RO Rigola dus
 HU Zuhanyfolyóka
 ES Canal de ducha



FALA

No.	Body length / Długość rynny [mm]	Series / Seria	
71610	600	Wet & dry white glass	6
71611	700	Wet & dry white glass	6
71612	800	Wet & dry white glass	6

EN Linear drain
 PL Odpływ liniowy
 DE Duschrinne
 RU Душевой лоток

CZ Odtokový žlab
 RO Rigola dus
 HU Zuhanyfolyóka
 ES Canal de ducha



FALA

No.	Body length / Długość rynny [mm]	Series / Seria	Package	
75367	300	Tocantins		6
75368	400	Tocantins		6
75369	500	Tocantins		6
75370	600	Tocantins		6
75371	700	Tocantins		6
75372	800	Tocantins		6
75373	900	Tocantins		6

EN Linear drain
 PL Odpływ liniowy
 DE Duschrinne
 RU Душевой лоток

CZ Odtokový žlab
 RO Rigola dus
 HU Zuhanyfolyóka
 ES Canal de ducha



FALA

No.	Body length / Długość rynny [mm]	Series / Seria	
75381	600	White Glass	6
75382	700	White Glass	6
75383	800	White Glass	6
75384	900	White Glass	6

EN Linear drain
 PL Odpływ liniowy
 DE Duschrinne
 RU Душевой лоток

CZ Odtokový žlab
 RO Rigola dus
 HU Zuhanyfolyóka
 ES Canal de ducha



FALA

No.	Body length / Długość rynny [mm]	Series / Seria	
75386	600	Black Glass	6
75387	700	Black Glass	6
75388	800	Black Glass	6
75389	900	Black Glass	6

EN Linear drain
 PL Odpływ liniowy
 DE Duschrinne
 RU Душевой лоток
 CZ Odtokový žlab
 RO Rigola dus
 HU Zuhanyfolyóka
 ES Canal de ducha



FALA

No.	Body length / Długość rynny [mm]	Series / Seria	
71614	600	Wet & dry black glass	6
71615	700	Wet & dry black glass	6
71616	800	Wet & dry black glass	6

EN Linear drain
 PL Odpływ liniowy
 DE Duschrinne
 RU Душевой лоток
 CZ Odtokový žlab
 RO Rigola dus
 HU Zuhanyfolyóka
 ES Canal de ducha



FALA

No.	Body length / Długość rynny [mm]	Series / Seria	
75448	600	Line	6
75449	700	Line	6
75450	800	Line	6
75451	900	Line	6

EN Linear drain
 PL Odpływ liniowy
 DE Duschrinne
 RU Душевой лоток

CZ Odtokový žlab
 RO Rigola dus
 HU Zuhanyfolyóka
 ES Canal de ducha

FALA

No.	Body length / Długość rynny [mm]	Series / Seria	
71635	500	Slim black	5
71636	600	Slim black	5
71637	700	Slim black	5
71638	800	Slim black	5
71639	900	Slim black	5

EN Linear drain
 PL Odpływ liniowy
 DE Duschrinne
 RU Душевой лоток
 CZ Odtokový žlab
 RO Rigola dus
 HU Zuhanyfolyóka
 ES Canal de ducha



FALA

No.	Body length / Długość rynny [mm]	Series / Seria	
75421	600	Olimp	6
75422	700	Olimp	6
75423	800	Olimp	6
75424	900	Olimp	6

EN Linear drain
 PL Odpływ liniowy
 DE Duschrinne
 RU Душевой лоток
 CZ Odtokový žlab
 RO Rigola dus
 HU Zuhanyfolyóka
 ES Canal de ducha



FALA

No.	Body length / Długość rynny [mm]	Series / Seria	
71630	500	Slim	5
71631	600	Slim	5
71632	700	Slim	5
71633	800	Slim	5
71634	900	Slim	5



EN Linear drain
 PL Odpływ liniowy
 DE Duschrinne
 RU Душевой лоток
 CZ Odtokový žlab
 RO Rigola dus
 HU Zuhanyfolyóka
 ES Canal de ducha



FALA

No.	Body length / Długość rynny [mm]	Series / Seria	
71603	600	Wet & dry	6
71604	700	Wet & dry	6
71605	800	Wet & dry	6

EN Linear drain
 PL Odpływ liniowy
 DE Duschrinne
 RU Душевой лоток
 CZ Odtokový žlab
 RO Rigola dus
 HU Zuhanyfolyóka
 ES Canal de ducha



FALA

No.	Body size / Rozmiar rynny [mm]	Series / Seria	
71620	150x150	Wet & dry	10

EN Pop-up waste
 PL Korek do umywalki
 DE Waschbecken Stöpsel
 RU Автоматическая пробка
 CZ Automatická zátka
 RO Sifon chiuveta
 HU Mosdo lefolyó elzaro
 ES Tapón automat. para batería de lado



FALA

No.	
75498	12/48

EN Linear drain
 PL Odpływ liniowy
 DE Duschrinne
 RU Душевой лоток
 CZ Odtokový žlab
 RO Rigola dus
 HU Zuhanyfolyóka
 ES Canal de ducha

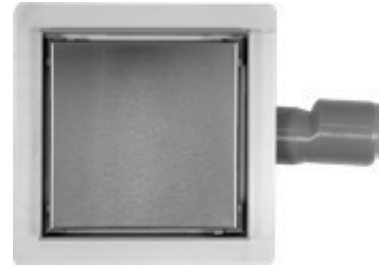

FALA

No.	Body size / Rozmiar rynny [mm]	Series / Seria	
75334	150x150	Quad	10
75335	200x200	Quad	10
75336	250x250	Quad	10

EN Aerator and sealing set for sanitary mixers
 PL Perlator i zestaw uszczelek do baterii
 DE Strahlregler- und Dichtungsgummissatz für Armatur
 RU Аэратор с набором прокладок для смесителя
 CZ Perlator a sada těsnění do baterie
 RO Sita si garnituri pt. baterii sanitare
 HU Levegőtétő és tömítőgumi készlet csaptelephez
 ES Aireado y juego de juntas



FALA

No.	
75327	25/200

EN Pop-up waste
 PL Korek do umywalki
 DE Waschbecken Stöpsel
 RU Автоматическая пробка
 CZ Automatická zátka
 RO Sifon chiuveta
 HU Mosdo lefolyó elzaro
 ES Tapón automat. para batería de lado



FALA

No.	
75499	12/48

- EN Pop-up waste
- PL Korek automatyczny
- DE Waschbecken Stöpsel
- RU Автоматическая пробка для умывальника
- CZ Automatická zátka
- RO Sifon chiuveta
- HU Mosdo lefolyo elzaro
- ES Tapón automat. para bateria de lado

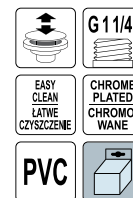

FALA

No. 48/96
75483

- EN Pop-up waste
- PL Korek automatyczny
- DE Waschbecken Stöpsel
- RU Автоматическая пробка для умывальника
- CZ Automatická zátka
- RO Sifon chiuveta
- HU Mosdo lefolyo elzaro
- ES Tapón automat. para bateria de lado

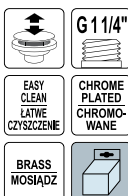

FALA

No. 20/40
75484

- EN Shower handle
- PL Słuchawka prysznicowa
- DE Handbrause
- RU Разбрызгиватель для душа
- CZ Ruční sprcha
- RO Cap duș
- HU Kézi zuhanyfej
- ES Ducha



FALA

No. 15/60
75544

- EN Shower handle
- PL Słuchawka prysznicowa
- DE Handbrause
- RU Разбрызгиватель для душа
- CZ Ruční sprcha
- RO Cap duș
- HU Kézi zuhanyfej
- ES Ducha



FALA

No. 30/60
75551

No. 30/60
75551

- EN Pop-up waste
- PL Korek automatyczny
- DE Waschbecken Stöpsel
- RU Автоматическая пробка для умывальника
- CZ Automatická zátka
- RO Sifon chiuveta
- HU Mosdo lefolyo elzaro
- ES Tapón automat. para bateria de lado

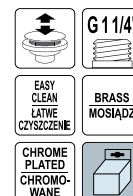

FALA

No. 20/40
75487

- EN Shower handle
- PL Słuchawka prysznicowa
- DE Handbrause
- RU Разбрызгиватель для душа
- CZ Ruční sprcha
- RO Cap duș
- HU Kézi zuhanyfej
- ES Ducha

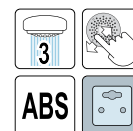

FALA

No. 15/60
75545

- EN Shower handle
- PL Słuchawka prysznicowa
- DE Handbrause
- RU Разбрызгиватель для душа
- CZ Ruční sprcha
- RO Cap duș
- HU Kézi zuhanyfej
- ES Ducha

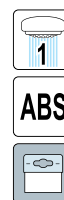

FALA

No. 30/60
75550

No. 30/60
75550

EN Shower handle
 PL Słuchawka prysznicowa
 DE Handbrause
 RU Разбрызгиватель для душа
 CZ Ruční sprcha
 RO Cap duș
 HU Kézi zuhanyfej
 ES Ducha

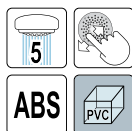

FALA

No.	Series / Seria	
75627	Delta	24/48

EN Shower handle
 PL Słuchawka prysznicowa
 DE Handbrause
 RU Разбрызгиватель для душа
 CZ Ruční sprcha
 RO Cap duș
 HU Kézi zuhanyfej
 ES Ducha



FALA

No.	Series / Seria	
75626	Kile	25/50

EN Shower handle
 PL Słuchawka prysznicowa
 DE Handbrause
 RU Разбрызгиватель для душа
 CZ Ruční sprcha
 RO Cap duș
 HU Kézi zuhanyfej
 ES Ducha



FALA

No.	Series / Seria	
75628	Deimos	12

EN Shower handle
 PL Słuchawka prysznicowa
 DE Handbrause
 RU Разбрызгиватель для душа
 CZ Ruční sprcha
 RO Cap duș
 HU Kézi zuhanyfej
 ES Ducha



FALA

No.	Series / Seria	
75633	Japet	12

EN Shower handle
 PL Słuchawka prysznicowa
 DE Handbrause
 RU Разбрызгиватель для душа
 CZ Ruční sprcha
 RO Cap duș
 HU Kézi zuhanyfej
 ES Ducha



FALA

No.	Series / Seria	
75631	Hermana	25/50

EN Shower handle
 PL Słuchawka prysznicowa
 DE Handbrause
 RU Разбрызгиватель для душа
 CZ Ruční sprcha
 RO Cap duș
 HU Kézi zuhanyfej
 ES Ducha

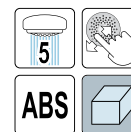

FALA

No.	Series / Seria	
75625	Delifos	25/50

EN Shower handle
 PL Słuchawka prysznicowa
 DE Handbrause
 RU Разбрызгиватель для душа
 CZ Ruční sprcha
 RO Cap duș
 HU Kézi zuhanyfej
 ES Ducha

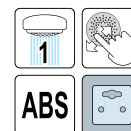

FALA

No.	Series / Seria	
75632	Fobos	12

EN Shower handle
 PL Słuchawka prysznicowa
 DE Handbrause
 RU Разбрызгиватель для душа
 CZ Ruční sprcha
 RO Cap duș
 HU Kézi zuhanyfej
 ES Ducha



FALA

No.	Series / Seria	
75634	Dione	12

EN Shower handle
 PL Słuchawka prysznicowa
 DE Handbrause
 RU Разбрызгиватель для душа
 CZ Ruční sprcha
 RO Cap duș
 HU Kézi zuhanyfej
 ES Ducha



FALA

No.	Series / Seria	Box
75635	Mimas	12

EN Shower handle
 PL Słuchawka prysznicowa
 DE Handbrause
 RU Разбрызгиватель для душа
 CZ Ruční sprcha
 RO Cap duș
 HU Kézi zuhanyfej
 ES Ducha



FALA

No.	Series / Seria	Box
75639	White Moon	12

EN Shower handle
 PL Słuchawka prysznicowa
 DE Handbrause
 RU Разбрызгиватель для душа
 CZ Ruční sprcha
 RO Cap duș
 HU Kézi zuhanyfej
 ES Ducha



FALA

No.	Series / Seria	Box
75619	Salto	25/50

EN Shower handle
 PL Słuchawka prysznicowa
 DE Handbrause
 RU Разбрызгиватель для душа
 CZ Ruční sprcha
 RO Cap duș
 HU Kézi zuhanyfej
 ES Ducha



FALA

No.	Series / Seria	Box
75621	Salto	25/50

EN Shower handle
 PL Słuchawka prysznicowa
 DE Handbrause
 RU Разбрызгиватель для душа
 CZ Ruční sprcha
 RO Cap duș
 HU Kézi zuhanyfej
 ES Ducha



FALA

No.	Series / Seria	Box
75636	Silver Moon	12

EN Shower handle
 PL Słuchawka prysznicowa
 DE Handbrause
 RU Разбрызгиватель для душа
 CZ Ruční sprcha
 RO Cap duș
 HU Kézi zuhanyfej
 ES Ducha

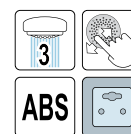

FALA

No.	Series / Seria	Box
75624	Salto	25/50

EN Shower handle
 PL Słuchawka prysznicowa
 DE Handbrause
 RU Разбрызгиватель для душа
 CZ Ruční sprcha
 RO Cap duș
 HU Kézi zuhanyfej
 ES Ducha



FALA

No.	Series / Seria	Box
75620	Salto	25/50

EN Shower handle
 PL Słuchawka prysznicowa
 DE Handbrause
 RU Разбрызгиватель для душа
 CZ Ruční sprcha
 RO Cap duș
 HU Kézi zuhanyfej
 ES Ducha



FALA

No.	Series / Seria	Box
75622	Salto	25/50

EN Shower handle
 PL Słuchawka prysznicowa
 DE Handbrause
 RU Разбрызгиватель для душа
 CZ Ruční sprcha
 RO Cap duș
 HU Kézi zuhanyfej
 ES Ducha



FALA

No.	Series / Seria	
75623	Salto	25/50

EN Shower holder
 PL Uchwyt do słuchawki prysznicowej
 DE Brauseporter
 RU Держатель душ
 CZ Držák s kloubem na sprchu
 RO Suport pt. dus
 HU Zuhanycső tartó
 ES Grifo para ducha



FALA

No.	
75535	100

EN Shower holder
 PL Uchwyt do słuchawki prysznicowej
 DE Brauseporter
 RU Держатель душ
 CZ Držák s kloubem na sprchu
 RO Suport pt. dus
 HU Zuhanycső tartó
 ES Grifo para ducha

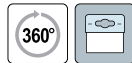

FALA

No.	
75537	100

EN Shower holder
 PL Uchwyt do słuchawki prysznicowej
 DE Brauseporter
 RU Держатель душ
 CZ Držák s kloubem na sprchu
 RO Suport pt. dus
 HU Zuhanycső tartó
 ES Grifo para ducha

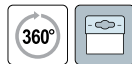

FALA

No.	
75564	50/200

EN Shower holder
 PL Uchwyt do słuchawki prysznicowej
 DE Brauseporter
 RU Держатель душ
 CZ Držák s kloubem na sprchu
 RO Suport pt. dus
 HU Zuhanycső tartó
 ES Grifo para ducha



FALA

No.	
75527	100

EN Shower holder
 PL Uchwyt do słuchawki prysznicowej
 DE Brauseporter
 RU Держатель душ
 CZ Držák s kloubem na sprchu
 RO Suport pt. dus
 HU Zuhanycső tartó
 ES Grifo para ducha



FALA

No.	
75536	100

EN Shower holder
 PL Uchwyt do słuchawki prysznicowej
 DE Brauseporter
 RU Держатель душ
 CZ Držák s kloubem na sprchu
 RO Suport pt. dus
 HU Zuhanycső tartó
 ES Grifo para ducha



FALA

No.	
75539	100

EN Shower holder
 PL Uchwyt do słuchawki prysznicowej
 DE Brauseporter
 RU Держатель душ
 CZ Držák s kloubem na sprchu
 RO Suport pt. dus
 HU Zuhanycső tartó
 ES Grifo para ducha



FALA

No.	
75565	30/180

EN Shower hose
 PL Wąż prysznicowy
 DE Brausenschlauch
 RU Шланг для душа
 CZ Sprchová hadice
 RO Furtun de duș
 HU Zuhanycső
 ES Flexo de ducha



FALA

No.	L [m]	☐
75553	1.5	30/60
75554	1.7	30/60

EN Shower hose
 PL Wąż prysznicowy
 DE Brausenschlauch
 RU Шланг для душа
 CZ Sprchová hadice
 RO Furtun de duș
 HU Zuhanycső
 ES Flexo de ducha

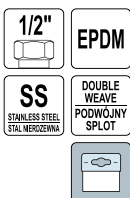

FALA

No.	L [m]	☐
75578	1.5	30/60
75579	1.7	30/60

EN Shower hose
 PL Wąż prysznicowy
 DE Brausenschlauch
 RU Шланг для душа
 CZ Sprchová hadice
 RO Furtun de duș
 HU Zuhanycső
 ES Flexo de ducha

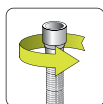
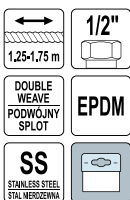

FALA

No.	L [m]	☐
75650	1.25-1.75	50

EN Shower hose
 PL Wąż prysznicowy
 DE Brausenschlauch
 RU Шланг для душа
 CZ Sprchová hadice
 RO Furtun de duș
 HU Zuhanycső
 ES Flexo de ducha



FALA

No.	L [m]	☐
75648	1.5	50
75649	2.0	50

EN Shower hose
 PL Wąż prysznicowy
 DE Brausenschlauch
 RU Шланг для душа
 CZ Sprchová hadice
 RO Furtun de duș
 HU Zuhanycső
 ES Flexo de ducha



FALA

No.	L [m]	☐
75645	1.50	50
75646	1.75	50
75647	2.00	50

EN Shower hose
 PL Wąż prysznicowy
 DE Brausenschlauch
 RU Шланг для душа
 CZ Sprchová hadice
 RO Furtun de duș
 HU Zuhanycső
 ES Flexo de ducha

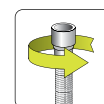
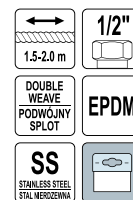

FALA

No.	L [m]	☐
75651	1.5-2.0	50

EN Shower hose
 PL Wąż prysznicowy
 DE Brausenschlauch
 RU Шланг для душа
 CZ Sprchová hadice
 RO Furtun de duș
 HU Zuhanycső
 ES Flexo de ducha

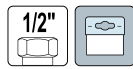

FALA

No.	L [m]	☐
75652	1.5	50
75653	2.0	50

EN Flexible connecting hose
 PL Wąż przyłączeniowy elastyczny
 DE Edelstahl Flexschlauch
 RU Гибкий шланг для смесителя
 CZ Flexibilní nerezové hadice na vodu
 RO Racord flexibil pt. apă
 HU Rugalmas rozsdamentes acél cső a víz
 ES Manguera flexible de acero inoxidable para el agua



FALA

No.	L [mm]	☐
71800	300	180
71801	400	150
71802	500	120
71803	600	120
71804	800	100
71805	1000	80

EN Flexible connecting hose
 PL Wąż przyłączeniowy elastyczny
 DE Edelstahl Flexschlauch
 RU Гибкий шланг для смесителя
 CZ Flexibilní nerezové hadice na vodu
 RO Racord flexibil pt. apă
 HU Rugalmas rozsdamentes acél cső a víz
 ES Manguera flexible de acero inoxidable para el agua

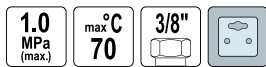

FALA

No.	L [mm]	☐
71814	300	180
71815	400	150
71816	500	120
71817	600	120
71818	800	100
71819	1000	80

EN Shower hose
 PL Wąż prysznicowy
 DE Brausenschlauch
 RU Шланг для душа
 CZ Sprchová hadice
 RO Furtun de duș
 HU Zuhanycső
 ES Flexo de ducha

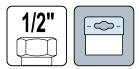

FALA

No.	L [m]	☐
75654	1.5	50
75655	2.0	50

EN Flexible connecting hose
 PL Wąż przyłączeniowy elastyczny
 DE Edelstahl Flexschlauch
 RU Гибкий шланг для смесителя
 CZ Flexibilní nerezové hadice na vodu
 RO Racord flexibil pt. apă
 HU Rugalmas rozsdamentes acél cső a víz
 ES Manguera flexible de acero inoxidable para el agua



FALA

No.	L [mm]	☐
71807	300	180
71808	400	150
71809	500	120
71810	600	120
71811	800	100
71812	1000	80

EN Flexible connecting hose
 PL Wąż przyłączeniowy elastyczny
 DE Edelstahl Flexschlauch
 RU Гибкий шланг для смесителя
 CZ Flexibilní nerezové hadice na vodu
 RO Racord flexibil pt. apă
 HU Rugalmas rozsdamentes acél cső a víz
 ES Manguera flexible de acero inoxidable para el agua

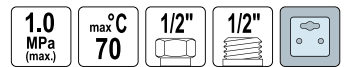

FALA

No.	L [mm]	☐
71820	300	180
71821	400	150
71822	500	120
71823	600	120
71824	800	10/100
71825	1000	80

EN Flexible connecting hose
 PL Wąż przyłączeniowy elastyczny
 DE Edelstahl Flexschlauch
 RU Гибкий шланг для смесителя
 CZ Flexibilní nerezové hadice na vodu
 RO Racord flexibil pt. apă
 HU Rugalmas rozsdamentes acél cső a víz
 ES Manguera flexible de acero inoxidable para el agua



FALA

No.	L [mm]	
71827	300	180
71828	400	150
71829	500	120
71830	600	120
71831	800	100
71832	1000	10/80

EN Flexible connecting hose
 PL Wąż przyłączeniowy elastyczny
 DE Edelstahl Flexschlauch
 RU Гибкий шланг для смесителя
 CZ Flexibilní nerezové hadice na vodu
 RO Racord flexibil pt. apă
 HU Rugalmas rozsdamentes acél cső a víz
 ES Manguera flexible de acero inoxidable para el agua



FALA

No.	L [mm]	
71840	300	200
71841	400	180
71842	500	150
71843	600	120
71844	800	100

EN Flexible connecting hose
 PL Wąż przyłączeniowy elastyczny
 DE Edelstahl Flexschlauch
 RU Гибкий шланг для смесителя
 CZ Flexibilní nerezové hadice na vodu
 RO Racord flexibil pt. apă
 HU Rugalmas rozsdamentes acél cső a víz
 ES Manguera flexible de acero inoxidable para el agua



FALA

No.	L [mm]	
71851	300	200
71852	400	180
71853	500	150
71854	600	120
71855	800	100

EN Flexible connecting hose
 PL Wąż przyłączeniowy elastyczny
 DE Edelstahl Flexschlauch
 RU Гибкий шланг для смесителя
 CZ Flexibilní nerezové hadice na vodu
 RO Racord flexibil pt. apă
 HU Rugalmas rozsdamentes acél cső a víz
 ES Manguera flexible de acero inoxidable para el agua



FALA

No.	L [mm]	
71833	300	180
71834	400	150
71835	500	120
71836	600	120
71838	1000	80

EN Flexible connecting hose
 PL Wąż przyłączeniowy elastyczny
 DE Edelstahl Flexschlauch
 RU Гибкий шланг для смесителя
 CZ Flexibilní nerezové hadice na vodu
 RO Racord flexibil pt. apă
 HU Rugalmas rozsdamentes acél cső a víz
 ES Manguera flexible de acero inoxidable para el agua



FALA

No.	L [mm]	
71846	300	200
71847	400	180
71848	500	150
71849	600	120
71850	800	100

EN Flexible connecting hose
 PL Wąż przyłączeniowy elastyczny
 DE Edelstahl Flexschlauch
 RU Гибкий шланг для смесителя
 CZ Flexibilní nerezové hadice na vodu
 RO Racord flexibil pt. apă
 HU Rugalmas rozsdamentes acél cső a víz
 ES Manguera flexible de acero inoxidable para el agua



FALA

No.	L [mm]	
71856	300	200
71857	400	180
71858	500	150
71859	600	120
71860	800	10/100

EN Bathroom set
 PL Zestaw łazienkowy
 DE Brausegarnitur
 RU Набор для душевой
 CZ Sprchová souprava
 RO Set pt. dus
 HU Zuhanyzó készlet
 ES Juego de baño ducha

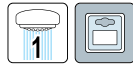

FALA

No.

75555



12

EN Bathroom set
 PL Zestaw łazienkowy
 DE Brausegarnitur
 RU Набор для душевой
 CZ Sprchová souprava
 RO Set pt. dus
 HU Zuhanyzó készlet
 ES Juego de baño ducha



FALA

No.

75558



12

EN Robe hook
 PL Naczek pojedynczy
 DE Einzelhaken
 RU Крючок одинарный
 CZ Háček
 RO Cârlig pt. prosop
 HU Fali akasztó
 ES Perchero de pared



FALA

No.

69311

Series / Seria

Quad Chrom



6/72

EN Toilet paper holder
 PL Uchwyt na papier toaletowy
 DE WC Papierhalter
 RU Держатель для туалетной бумаги
 CZ Držák na toaletní papír
 RO Suport hârtie igienică
 HU WC papír tartó
 ES Portarrollos para papel higiénico

FALA

No.

69314

Series / Seria

Quad Chrom



4/24

EN Bathroom set
 PL Zestaw łazienkowy
 DE Brausegarnitur
 RU Набор для душевой
 CZ Sprchová souprava
 RO Set pt. dus
 HU Zuhanyzó készlet
 ES Juego de baño ducha



FALA

No.

75559



16

EN Soap dish
 PL Mydelniczka
 DE Seifenschale
 RU Мыльница
 CZ Mydelnička
 RO Sapuniera
 HU Szappantartó tál
 ES Jabonera



FALA

No.

69313

Series / Seria

Quad Chrom



4/24



- EN Toilet paper holder
- PL Uchwyt na papier toaletowy
- DE WC Papierhalter
- RU Держатель для туалетной бумаги
- CZ Držák na toaletní papír
- RO Suport hârtie igienică
- HU WC papír tartó
- ES Portarrollos para papel higiénico

FALA

No.	Series / Seria	
69315	Quad Chrom	4/24

- EN Toilet paper holder
- PL Uchwyt na zapasowy papier
- DE Reservierpapierhalter
- RU Держатель для запасного рулона туалетной
- CZ Držák na toaletní papír
- RO Suport hârtie igienică
- HU WC papír tartó
- ES Portarrollos para papel higiénico



FALA

No.	Series / Seria	
69316	Quad Chrom	5/30

- EN Toilet brush holder
- PL Szczotka WC
- DE WC-Garnitur
- RU Туалетная щетка настенная
- CZ WC štětka
- RO Suport perie WC
- HU WC kefe
- ES Escobillero mura



FALA

No.	Series / Seria	
69320	Quad Chrom	4/8

- EN Soap dish
- PL Mydelniczka
- DE Seifenschale
- RU Мыльница
- CZ Mýdelnička
- RO Sapuniera
- HU Szappantartó tál
- ES Jabonera



FALA

No.	Series / Seria	
69339	Cuboid White	6/144



- EN Towel ring
- PL Uchwyt na ręcznik
- DE Handtuchring
- RU Кольцо для полотенца
- CZ Držák ručníků
- RO Portprosop
- HU Törölközőtartó
- ES Toallero anillo



FALA

No.	Series / Seria	
69319	Quad Chrom	4/24

- EN Glass shelf
- PL Półka szklana
- DE Ablagekonsole aus Glas
- RU Этaжерка настенная
- CZ Polička do koupelny
- RO Polita sticla
- HU Piperepolc - üveg
- ES Estante



FALA

No.	Series / Seria	
69321	Quad Chrom	4/8

- EN Lotion dispenser
- PL Dozownik mydła w płynie
- DE Seifenspender
- RU Дозатор для жидкого мыла
- CZ Dávkovač mýdla
- RO Dozator sapun
- HU Folyékony szappan adagoló
- ES Dosificador



FALA

No.	Series / Seria	
69340	Cuboid White	6/72

EN Toilet brush holder
 PL Szczotka WC
 DE WC-Bürste
 RU Щетка туалетная
 CZ WC kartáč
 RO Perie WC
 HU WC kefe tartó
 ES Escobillero



FALA

No.	Series / Seria	
69341	Cuboid White	6/48

EN Toothbrush holder
 PL Kubek na szczoteczki do zębów
 DE Zahnputzbecher
 RU Стакан для зубных щеток
 CZ Dóza na zubní kartáčky
 RO Suport pt. periute dinti
 HU Fogkefektartó pohár
 ES Portacepillos



FALA

No.	Series / Seria	
69351	Nickel	6/96

EN Lotion dispenser
 PL Dozownik mydła w płynie
 DE Seifenspender
 RU Дозатор для жидкого мыла
 CZ Dávkovač mýdla
 RO Dozator sapun
 HU Folyékony szappan adagoló
 ES Dosificador



FALA

No.	Series / Seria	
69353	Nickel	6/72

EN Robe hook
 PL Haczyk pojedynczy
 DE Einzelhaken
 RU Крючок одинарный
 CZ Háček
 RO Cârlig pt. prosop
 HU Fali akasztó
 ES Perchero de pared



FALA

No.	Series / Seria	
69370	Steely	165



EN Tumbler
 PL Kubek kosmetyczny
 DE Becher
 RU Стакан
 CZ Dóza
 RO Suport periuță
 HU Fürdőszobai pohár
 ES Vaso



FALA

No.	Series / Seria	
69350	Nickel	6/96

EN Soap dish
 PL Mydelniczka
 DE Seifenschale
 RU Мыльница
 CZ Mýdelnička
 RO Sapuniera
 HU Szappantartó tál
 ES Jabonera



FALA

No.	Series / Seria	
69352	Nickel	6/192

EN Toilet brush holder
 PL Szczotka WC
 DE WC-Bürste
 RU Щетка туалетная
 CZ WC kartáč
 RO Perie WC
 HU WC kefe tartó
 ES Escobillero



FALA

No.	Series / Seria	
69354	Nickel	6/24

EN Robe hook
 PL Haczyk pojedynczy
 DE Einzelhaken
 RU Крючок одинарный
 CZ Háček
 RO Cârlig pt. prosop
 HU Fali akasztó
 ES Perchero de pared



FALA

No.	Series / Seria	
69371	Steely	165



EN Robe hook
 PL Haczyk podwójny
 DE Einzelhaken
 RU Крючок одинарный
 CZ Háček
 RO Cârlig pt. prosop
 HU Fali akasztó
 ES Perchero de pared

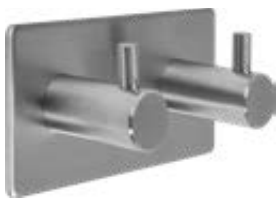

FALA

No.	Series / Seria	Box
69372	Steely	110

EN Towel ring
 PL Uchwyt na ręcznik
 DE Handtuchring
 RU Кольцо для полотенца
 CZ Držák ručníků
 RO Portprosop
 HU Törölközőtartó
 ES Toallero anillo



FALA

No.	Series / Seria	Box
69374	Steely	25

EN Shelf
 PL Półka
 DE Ablagekonsole
 RU Этажерка настенная

CZ Polička do koupelny
 RO Polita
 HU Piperepolc
 ES Estante

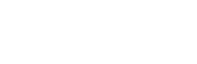

FALA

No.	Series / Seria	Box
69378	Steely	30

EN Toilet seat
 PL Deska sedesowa
 DE WC Deckel
 RU Сиденье для унитаза
 CZ WC sedátko
 RO Capac WC
 HU WC-ülőke
 ES Asiento de inodoro

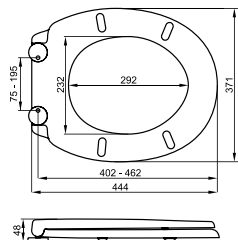

FALA

No.	Box
75465	5

EN Robe hook
 PL Haczyk podwójny
 DE Einzelhaken
 RU Крючок одинарный
 CZ Háček
 RO Cârlig pt. prosop
 HU Fali akasztó
 ES Perchero de pared



FALA

No.	Series / Seria	Box
69373	Steely	220

EN Toilet paper holder
 PL Uchwyt na papier toaletowy
 DE WC Papierhalter
 RU Держатель для туалетной бумаги
 CZ Držák na toaletní papír
 RO Suport hârtie igienică
 HU WC papír tartó
 ES Portarrollos para papel higiénico



FALA

No.	Series / Seria	Box
69375	Steely	50



EN Toilet seat
 PL Deska sedesowa
 DE WC Deckel
 RU Сиденье для унитаза
 CZ WC sedátko
 RO Capac WC
 HU WC-ülőke
 ES Asiento de inodoro

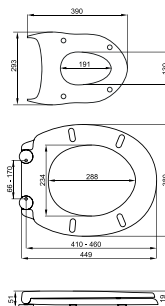

FALA

No.	Box
75467	5

EN Toilet seat
 PL Deska sedesowa
 DE WC Deckel
 RU Сиденье для унитаза
 CZ WC sedátko
 RO Capac WC
 HU WC-ülöke
 ES Asiento de inodoro

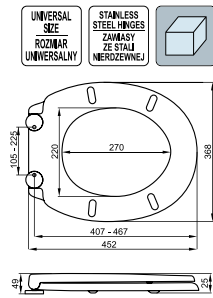

UNIVERSAL SIZE
 ROZMĚR UNIVERZÁLNĚ
 STAINLESS STEEL HINGES
 ZÁMĚSKY ZE STÁLÍ NERDZEVNĚJ



FALA

No.
 75469

5

EN Toilet seat
 PL Deska sedesowa
 DE WC Deckel
 RU Сиденье для унитаза
 CZ WC sedátko
 RO Capac WC
 HU WC-ülöke
 ES Asiento de inodoro



UNIVERSAL SIZE
 ROZMĚR UNIVERZÁLNĚ
 STAINLESS STEEL HINGES
 ZÁMĚSKY ZE STÁLÍ NERDZEVNĚJ

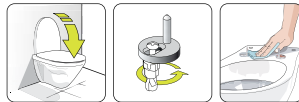

FALA

No.
 75470

6

EN Toilet seat
 PL Deska sedesowa
 DE WC Deckel
 RU Сиденье для унитаза
 CZ WC sedátko
 RO Capac WC
 HU WC-ülöke
 ES Asiento de inodoro

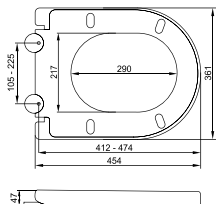

UNIVERSAL SIZE
 ROZMĚR UNIVERZÁLNĚ
 STAINLESS STEEL HINGES
 ZÁMĚSKY ZE STÁLÍ NERDZEVNĚJ



FALA

No.
 75472

5

EN Toilet seat
 PL Deska sedesowa
 DE WC Deckel
 RU Сиденье для унитаза
 CZ WC sedátko
 RO Capac WC
 HU WC-ülöke
 ES Asiento de inodoro

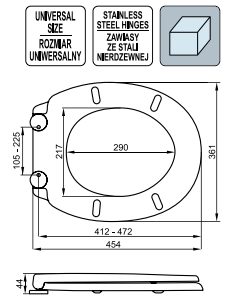

UNIVERSAL SIZE
 ROZMĚR UNIVERZÁLNĚ
 STAINLESS STEEL HINGES
 ZÁMĚSKY ZE STÁLÍ NERDZEVNĚJ



FALA

No.
 75464

5

EN Toilet seat
 PL Deska sedesowa
 DE WC Deckel
 RU Сиденье для унитаза
 CZ WC sedátko
 RO Capac WC
 HU WC-ülöke
 ES Asiento de inodoro



UNIVERSAL SIZE
 ROZMĚR UNIVERZÁLNĚ
 STAINLESS STEEL HINGES
 ZÁMĚSKY ZE STÁLÍ NERDZEVNĚJ

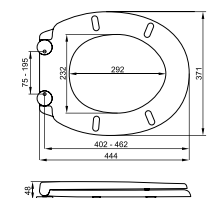

FALA

No.
 75471

5

EN LED toilet light
 PL Lampka LED do podświetlania WC
 DE WC LED Lampe
 RU LED ночник для туалета
 CZ WC LED světlo
 RO Lumină pt. toaletă
 HU LED WC megvilágítás
 ES WC LED lámpara



RGB LED



FALA

No.
 75455

100

EN Plastic stool
 PL Stolek plastikowy
 DE Kunststoff Hocker
 RU Пластиковый табурет
 CZ Plastová stolička
 RO Scaun de plastic
 HU Műanyag széket
 ES Taburete de plástico



FALA

No.	Dimensions / Wymiary [mm]	
75915	300x200x210	10/20

EN Waste pump for shower and basin
 PL Pompa łazienkowa do pryszniców i umywalk
 DE Haushaltspumpe für Dusche und Waschtisch
 RU Санитарный насос
 CZ Koupelnové čerpadlo pro sprchy
 RO Pompa pt. ape uzate - dus, lovoar
 HU Szivattyú zuhanyzóhoz
 ES Bomba de evacuación

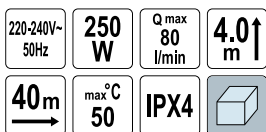

FALA

No.	Power / Moc [W]	
75944	250	4

EN Toilet pump
 PL Pompa sanitarna
 DE Abwasserpumpe
 RU Канализационный насос
 CZ Sanitární kalové čerpadlo
 RO Pompă de apă uzată
 HU Szennyvíz átemelő szivattyú
 ES Bomba de aguas residuales



FALA

No.	Power / Moc [W]	
75954	400	1

EN Plastic stool
 PL Stolek plastikowy
 DE Kunststoff Hocker
 RU Пластиковый табурет
 CZ Plastová stolička
 RO Scaun de plastic
 HU Műanyag széket
 ES Taburete de plástico



FALA

No.	Dimensions / Wymiary [mm]	
75916	300x200x210	10/20

EN Waste pump for shower and basin
 PL Pompa łazienkowa do pryszniców i umywalk
 DE Haushaltspumpe für Dusche und Waschtisch
 RU Санитарный насос
 CZ Koupelnové čerpadlo pro sprchy
 RO Pompa pt. ape uzate - dus, lovoar
 HU Szivattyú zuhanyzóhoz
 ES Bomba de evacuación



FALA

No.	Power / Moc [W]	
75945	250	1

EN Toilet pump
 PL Pompa sanitarna
 DE Abwasserpumpe
 RU Канализационный насос
 CZ Sanitární kalové čerpadlo
 RO Pompă de apă uzată
 HU Szennyvíz átemelő szivattyú
 ES Bomba de aguas residuales



FALA

No.	Power / Moc [W]	
75951	600	1

EN Toilet pump
 PL Pompa sanitarna
 DE Abwasserpumpe
 RU Канализационный насос
 CZ Sanitární kalové čerpadlo
 RO Pompă de apă uzată
 HU Szennyvíz áttemelő szivattyú
 ES Bomba de aguas residuales



220-240V~ 50Hz	600 W	Q max 150 l/min	9.5 m
max °C 45	2850 min ⁻¹	IP55	



FALA

No.	Power / Moc [W]	
75953	600	1

Convenient and easy to use.
 Wygodna i łatwa obsługa.

Rotation 360°

Mixing water flow with intake air reduces consumption by half, without splashing.
 Zmieszany strumień wody z zasysanym powietrzem oszczędza zużycie o połowę i nie chlapie.

ECOflow

Additional protection against contamination.
 Dodatkowa ochrona przed zanieczyszczeniami.

built-in-filter

Simple and effective installation thanks to the nut.
 Łatwy i trwały montaż dzięki nakrętce.

SMARTnut

EN Instant heating faucet
 PL Przepływowy podgrzewacz wody z baterią
 DE Elektrische Warmwasser-Armatur
 RU Миттевий водонагривач
 CZ Ohřívač vody
 RO Baterie instant
 HU Átfolyós vízmelegítő csaptelep
 ES Calefacción instantáneo grifo

220-240V~ 50-60Hz	3000 W	1/2"	0.04-0.6 MPa	200 mm
1.2 m				



FALA

No.	Series / Seria	
75930	Strokkur 1	10

EN Instant heating faucet
 PL Przepływowy podgrzewacz wody z baterią
 DE Elektrische Warmwasser-Armatur
 RU Миттевий водонагривач
 CZ Ohřívač vody
 RO Baterie instant
 HU Átfolyós vízmelegítő csaptelep
 ES Calefacción instantáneo grifo

220-240V~ 50-60Hz	3000 W	1/2"	0.04-0.6 MPa	100 mm
1.2 m				



FALA

No.	Series / Seria	
75931	Strokkur 2	10

EN Instant heating faucet
 PL Przepływowy podgrzewacz wody z baterią
 DE Elektrische Warmwasser-Armatur
 RU Миттевий водонагривач
 CZ Ohřívač vody
 RO Baterie instant
 HU Átfolyós vízmelegítő csaptelep
 ES Calefacción instantáneo grifo

220-240V~ 50-60Hz	3000 W	1/2"	0.04-0.6 MPa	200 mm
1.2 m				



FALA

No.	Series / Seria	
75932	Strokkur 3	10

EN Instant heating faucet
 PL Przepływowy podgrzewacz wody z baterią
 DE Elektrische Warmwasser-Armatur
 RU Миттевий водонагривач
 CZ Ohřívač vody
 RO Baterie instant
 HU Átfolyós vízmelegítő csaptelep
 ES Calefacción instantáneo grifo

230V~ 50Hz	3000 W	1/2"	0.1-0.6 MPa	
1.2 m				



FALA

No.	Series / Seria	
75921	Katla 1	10

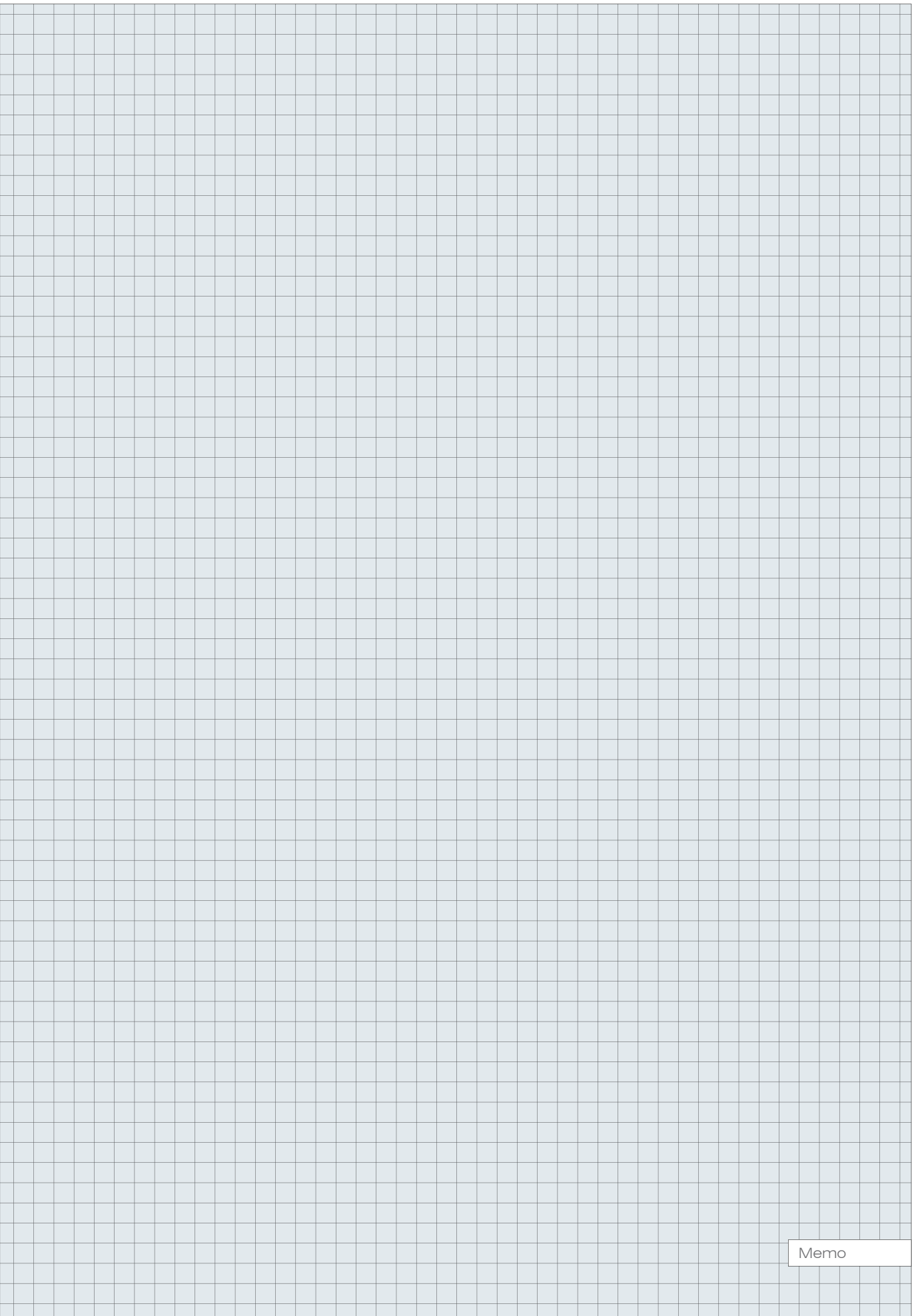

Memo

No.	Page	No.	Page	No.	Page	No.	Page	No.	Page	No.	Page	No.	Page	No.	Page
00250	150	04700	157	05902	170	06320	170	06840	109	07886	116	08585	116	08868	92
00300	146	04710	157	05903	170	06330	170	06860	109	07930	114	08630	90	08869	92
00320	146	04712	152	05904	170	06331	170	06930	101	07950	117	08631	90	08873	92
00610	146	04713	152	05905	170	06335	172	06940	101	07955	117	08633	90	08875	92
01060	146	04714	151	05906	170	06338	181	06950	101	07956	117	08635	90	08876	91
02300	146	04715	152	05911	170	06340	165	06960	101	07957	117	08639	90	08900	92
02400	146	04716	152	05912	170	06341	165	06963	101	07960	117	08640	90	09005	172
03150	146	04717	152	05913	170	06350	165	06964	101	07962	117	08641	90	09006	172
03160	146	04718	153	05914	170	06351	165	06965	102	07970	117	08642	90	09010	172
03220	146	04720	157	05915	170	06370	165	06970	102	07974	91	08644	90	09015	172
03221	147	04721	157	05916	170	06380	165	06971	102	07975	91	08646	90	09017	172
03225	147	04723	151	05921	170	06381	181	06972	102	07976	91	08663	91	09031	172
03240	83	04724	151	05922	170	06382	181	06973	102	07977	91	08665	91	09036	173
03241	83	04728	153	05923	170	06383	181	06974	102	07978	91	08669	91	09038	173
03245	84	04729	154	05924	170	06384	181	06975	102	07984	91	08671	91	09040	173
03246	84	04730	153	05925	170	06388	181	06976	102	07985	91	08674	91	09044	173
03300	85	04731	153	05926	170	06390	181	06977	102	07986	91	08683	91	09046	173
03301	85	04732	153	05950	168	06391	181	06978	102	07987	91	08711	89	09048	173
03900	148	04734	154	05960	169	06392	181	06979	102	07988	91	08712	89	09049	173
03940	148	04735	154	05971	169	06393	181	06980	102	08170	90	08714	89	09050	173
03960	148	04736	154	05972	169	06394	181	06981	102	08171	90	08715	89	09060	172
03963	148	04737	154	05980	169	06395	181	06982	102	08174	90	08731	89	09062	173
03990	84	04739	155	06001	169	06396	181	06983	102	08175	90	08732	89	09063	173
04000	147	04740	155	06002	169	06397	181	06985	102	08190	91	08734	89	09065	173
04020	147	04741	155	06003	169	06398	181	06986	102	08191	91	08751	89	09077	173
04022	147	04746	155	06004	169	06399	181	06987	103	08288	116	08752	89	09080	172
04050	148	04755	167	06005	169	06400	162	06988	103	08289	116	08754	89	09090	172
04060	149	04756	167	06006	169	06401	163	06989	103	08290	116	08755	89	09094	173
04100	148	04770	167	06010	169	06410	162	06990	103	08291	116	08780	89	09096	173
04200	147	05050	109	06011	169	06420	162	06992	103	08292	116	08781	89	09097	173
04300	132	05100	109	06012	169	06430	162	06993	103	08293	116	08782	89	09100	135
04301	132	05290	149	06013	169	06440	162	06994	103	08301	116	08783	89	09120	136
04320	134	05300	182	06014	169	06450	174	06995	103	08302	116	08785	89	09130	135
04360	170	05301	182	06015	169	06452	174	07060	115	08303	116	08786	89	09150	135
04405	148	05302	182	06030	167	06453	174	07080	115	08304	116	08788	89	09160	136
04410	147	05311	182	06040	167	06457	174	07100	115	08306	116	08790	89	09162	138
04440	147	05312	182	06050	167	06460	174	07120	115	08307	116	08791	89	09163	138
04450	136	05319	182	06060	167	06470	163	07180	115	08308	116	08792	89	09164	138
04451	136	05325	182	06080	167	06472	163	07240	115	08312	103	08793	89	09165	138
04452	136	05540	85	06100	167	06500	163	07320	115	08314	103	08811	90	09170	136
04490	149	05560	85	06110	165	06510	163	07400	115	08315	104	08819	90	09171	137
04500	149	05580	85	06120	165	06512	164	07506	115	08316	104	08820	90	09172	137
04510	149	05600	85	06121	165	06520	163	07508	115	08318	104	08821	90	09173	137
04540	149	05750	171	06130	167	06530	163	07510	115	08400	104	08822	90	09174	137
04542	149	05751	171	06140	168	06532	164	07512	115	08500	104	08825	90	09175	137
04544	150	05752	171	06150	168	06537	165	07530	115	08501	104	08827	90	09177	137
04546	150	05760	171	06290	168	06538	165	07540	115	08510	104	08828	90	09180	183
04600	156	05761	171	06294	168	06540	163	07560	115	08511	105	08829	90	09190	183
04610	156	05770	171	06295	168	06640	164	07580	115	08520	105	08831	90	09200	183
04620	156	05771	171	06296	168	06650	164	07610	115	08521	105	08832	90	09204	183
04630	156	05772	171	06297	168	06660	164	07620	115	08522	105	08833	90	09207	183
04640	156	05773	171	06298	168	06670	164	07630	115	08553	116	08834	90	09302	175
04650	156	05774	171	06299	168	06680	164	07664	116	08554	116	08835	90	09303	175
04677	155	05803	166	06300	168	06690	164	07665	116	08556	116	08837	90	09307	175
04680	156	05804	166	06301	168	06700	164	07666	116	08558	116	08838	90	09308	175
04681	156	05805	166	06302	168	06701	164	07667	116	08560	116	08845	90	09310	176
04682	156	05821	166	06303	168	06740	164	07668	116	08562	116	08851	90	09311	176
04683	156	05822	166	06304	168	06760	164	07879	116	08565	116	08853	90	09331	176
04684	156	05823	166	06305	168	06780	164	07880	116	08573	116	08854	90	09332	176
04690	150	05830	166	06306	168	06781	164	07881	116	08574	116	08855	90	09334	175
04691	150	05831	166	06307	168	06795	170	07882	116	08576	116	08860	92	09336	175
04692	151	05840	166	06308	168	06796	171	07883	116	08578	116	08861	92	09338	176
04693	151	05850	167	06309	168	06799	171	07884	116	08580	116	08864	92	09345	175
04699	150	05901	170	06310	170	06820	109	07885	116	08582	116	08865	92	09346	175

No.	Page	No.	Page	No.	Page	No.	Page	No.	Page	No.	Page	No.	Page	No.	Page
09359	175	09561	177	14300	191	17501	192	20200	77	22130	77	23402	82	23982	81
09365	176	09562	177	14500	191	17505	193	20250	77	22180	77	23403	82	23988	82
09370	175	09581	178	15004	191	17506	193	20280	77	22190	77	23411	82	23990	81
09371	175	09583	178	15005	191	17507	193	20300	77	22250	77	23412	82	23992	81
09372	175	09585	178	15006	191	17508	193	20320	77	22300	77	23413	82	23999	81
09373	175	09587	178	15007	191	17570	197	20350	77	22310	77	23414	82	24000	88
09375	176	09589	178	15010	191	17606	202	20400	77	22330	77	23415	82	24060	86
09377	176	09590	179	15020	191	17608	202	20420	77	22340	77	23416	82	24070	86
09385	176	09636	178	15050	191	17610	202	20450	77	22350	80	23417	82	24080	86
09390	177	09638	178	15070	191	17612	202	20500	77	22380	80	23418	82	24090	86
09395	177	09640	178	15100	192	17615	202	20550	77	22381	80	23419	82	24091	86
09397	174	09642	178	15110	192	17620	202	20600	77	22431	81	23420	82	24095	86
09398	174	09647	178	15113	192	17701	160	20650	77	22460	80	23421	82	24112	135
09400	181	09648	178	15115	192	17702	160	20700	77	22465	81	23422	82	24122	135
09406	176	09649	178	15120	191	17704	160	20800	77	22466	81	23423	82	24130	135
09408	176	09650	178	15130	191	17705	161	20850	77	22500	81	23424	82	24295	88
09413	176	09651	178	15200	191	17730	161	20900	77	22550	88	23460	83	24300	86
09421	177	09653	179	15220	192	17733	161	21000	77	22551	88	23590	82	24310	86
09422	177	09655	178	15240	192	18002	199	21100	77	22552	88	23591	82	24320	86
09430	177	09656	178	15291	202	18010	199	21200	77	22565	84	23592	83	24330	86
09445	174	09900	165	15292	202	18020	199	21250	77	22570	84	23593	83	24340	86
09446	174	09903	165	15301	202	18021	199	21300	77	22571	84	23594	83	24350	86
09457	179	09910	166	16000	202	18180	85	21400	77	22572	84	23601	82	24370	86
09459	179	09920	178	16001	202	18200	195	21600	77	22590	81	23602	82	24390	86
09462	179	09930	178	16002	202	18201	195	21650	78	22591	81	23603	83	24410	86
09463	179	09950	178	16012	201	18250	195	21686	79	22610	78	23604	83	24430	86
09464	179	10000	345	16030	148	18300	195	21688	79	22611	78	23605	83	24450	86
09465	344	10001	345	16280	201	18350	195	21690	79	22612	79	23606	83	24470	86
09466	344	10002	345	16300	201	18355	196	21691	79	22613	79	23620	81	24500	87
09467	344	10003	345	16301	201	18356	196	21692	79	22616	79	23640	81	24510	87
09468	179	10010	345	16340	201	18357	196	21700	85	22617	79	23650	81	24520	87
09469	179	10011	345	16360	201	18360	195	21701	85	22640	79	23660	81	24530	87
09470	179	10012	345	16380	201	18361	195	21702	85	23311	80	23670	81	24550	87
09471	179	10013	345	16400	201	18362	195	21703	85	23312	80	23680	81	24570	87
09472	179	10015	345	16551	202	18370	196	21704	85	23313	80	23690	81	24590	87
09473	344	10061	190	16552	202	18372	196	21705	85	23315	80	23692	81	24610	87
09474	345	10062	190	16553	202	18374	196	21706	85	23316	80	23693	81	24630	87
09475	179	10063	190	16554	202	18375	196	21709	85	23317	80	23694	81	24650	87
09476	179	10064	190	16555	202	18377	197	21900	78	23318	80	23710	81	24670	87
09477	179	10065	190	16556	202	18380	195	21905	78	23325	80	23720	81	24700	87
09478	179	10101	190	16557	202	18382	195	21910	78	23326	80	23722	81	24710	87
09479	179	10104	190	17300	194	18390	195	21915	78	23327	80	23723	81	24900	87
09480	442	10106	190	17301	194	18470	197	21919	78	23331	80	23724	81	24940	87
09481	442	10109	190	17302	194	18473	196	21921	78	23371	82	23730	81	24960	87
09482	442	10111	190	17303	194	18501	196	21924	78	23372	82	23740	81	24961	87
09483	442	10122	190	17304	195	18502	196	21927	78	23373	82	23750	81	24962	87
09484	442	10123	190	17310	195	18503	196	21929	78	23374	82	23752	81	24963	87
09486	344	10125	190	17430	194	18504	196	21932	78	23375	82	23800	81	24964	87
09487	345	10128	190	17435	194	18530	197	21934	78	23376	82	23820	81	24965	87
09489	345	10129	190	17470	194	18790	197	21936	78	23377	82	23830	81	24966	87
09490	345	10130	190	17471	194	18797	196	21941	78	23379	82	23832	81	25160	112
09521	177	10133	190	17473	194	18798	196	21944	78	23380	82	23840	81	25161	112
09522	177	10135	190	17474	194	18799	196	21948	78	23381	82	23850	81	25162	112
09523	177	10138	190	17480	194	18800	197	21950	78	23390	82	23860	81	25163	112
09524	177	10139	190	17481	194	18810	197	21951	78	23391	82	23862	81	25164	112
09525	177	12100	190	17483	194	19750	198	21952	78	23392	82	23880	81	25165	112
09531	177	12200	190	17484	194	19755	198	21955	78	23393	82	23882	81	25166	112
09532	177	12300	190	17488	193	19763	198	21956	78	23394	82	23883	81	25170	113
09533	177	12500	190	17489	193	19765	198	21958	78	23395	82	23920	81	25171	114
09534	177	13200	190	17490	193	19766	198	21959	78	23396	82	23930	81	25172	114
09535	177	13300	190	17495	193	19767	198	21961	78	23397	82	23932	81	25173	114
09536	177	13500	190	17497	193	19770	198	21963	78	23398	82	23960	81	25300	114
09537	177	14100	191	17498	193	20100	77	21966	78	23399	82	23962	81	25301	114
09560	177	14200	191	17500	192	20150	77	21998	78	23400	82	23980	81	25307	114

No.	Page	No.	Page	No.	Page	No.	Page	No.	Page	No.	Page	No.	Page	No.	Page
25310	115	27535	100	29050	97	31100	58	33530	61	35210	109	35775	427	35874	343
25351	113	27541	100	29210	98	31150	58	33532	61	35240	109	35776	425	35875	343
25352	113	27542	100	29220	98	31200	58	33535	61	35250	62	35777	425	35876	343
25353	113	27543	100	29311	98	31300	59	33550	60	35300	62	35780	424	35877	343
25360	113	27544	100	29312	98	31400	59	33555	61	35351	62	35781	424	35890	424
25370	113	27545	100	29313	98	31500	59	33557	61	35352	62	35782	424	35891	424
25380	113	27575	90	29317	98	31600	59	33650	60	35353	62	35783	424	35892	424
25390	113	27600	96	29318	98	31800	59	33655	61	35355	62	35784	424	35893	344
25400	272	27610	97	29319	98	32000	59	33657	61	35359	63	35785	425	35894	344
25405	88	27630	97	29323	98	32110	59	33900	60	35360	63	35786	426	35895	344
25410	272	27800	100	29400	161	32202	59	33905	61	35362	63	35787	426	35899	344
25411	272	27810	101	29401	161	32203	59	33907	61	35372	62	35788	426	35901	428
25412	272	27811	101	29404	161	32204	59	33925	61	35373	62	35789	426	35902	428
25420	117	27812	101	29410	162	32205	59	33950	61	35374	62	35790	426	35905	427
25450	272	27813	101	29420	221	32206	59	34182	226	35430	63	35791	426	35906	428
25500	61	27814	101	29440	162	32207	59	34184	227	35450	62	35792	425	35908	428
25510	61	27815	101	29444	162	32208	59	34204	63	35451	62	35793	427	35911	344
25511	61	27820	101	29445	162	32610	60	34205	63	35452	62	35794	427	35914	343
25512	61	27830	101	29993	59	32625	59	34206	63	35580	181	35795	427	35915	343
25513	61	27831	101	29994	59	32627	60	34207	63	35581	181	35798	425	35916	343
25514	61	27833	101	29995	59	32685	60	34208	63	35582	181	35799	421	35918	343
25515	61	27834	101	29996	59	32687	60	34210	63	35600	441	35800	421	35923	343
25516	61	27850	98	29997	59	32705	60	34212	63	35610	441	35801	422	35924	343
25517	61	28011	95	30010	58	32715	60	34220	64	35611	441	35802	421	35927	428
25518	61	28012	95	30020	58	32720	59	34222	64	35623	442	35803	422	35930	342
25519	61	28370	94	30030	58	32900	66	34225	64	35624	443	35805	422	35931	342
25520	61	28371	94	30040	58	32901	66	34243	63	35625	443	35806	422	35932	342
25521	61	28372	94	30050	58	32902	66	34245	63	35667	421	35807	422	35933	342
25530	62	28373	94	30060	58	32922	66	34247	63	35668	421	35808	422	35940	342
25570	62	28380	94	30080	58	32923	66	34251	63	35669	421	35809	418	35950	428
25700	62	28381	94	30100	58	32924	65	34254	63	35670	421	35810	419	35963	342
25830	111	28382	94	30150	58	32925	65	34256	63	35671	421	35811	418	35964	342
25881	111	28385	94	30200	58	32926	65	34300	63	35672	421	35813	423	35968	342
25885	111	28386	94	30220	58	32927	65	34600	63	35673	424	35816	423	35970	343
25886	111	28387	94	30222	58	32928	65	34750	63	35677	421	35817	420	36000	73
25887	111	28394	95	30224	58	32930	64	34900	63	35680	421	35821	429	36004	73
25971	111	28395	95	30310	58	32999	65	34944	172	35685	421	35823	429	36005	73
25972	111	28401	95	30320	58	33000	65	34945	172	35700	426	35824	429	36006	73
26130	113	28611	414	30330	58	33001	65	34946	172	35701	420	35826	429	36008	73
26131	113	28612	414	30340	58	33002	65	34947	172	35705	420	35828	429	36014	73
26132	113	28613	415	30350	58	33003	65	34949	442	35710	427	35830	429	36015	73
26140	113	28630	415	30360	58	33004	65	34950	183	35720	418	35831	429	36016	73
26150	115	28631	415	30380	58	33005	65	35000	184	35721	419	35832	428	36018	73
26200	115	28632	415	30390	58	33006	65	35007	184	35722	419	35833	419	36032	73
26210	115	28640	414	30395	58	33007	65	35010	184	35740	424	35835	419	36033	73
26220	115	28641	414	30400	58	33008	65	35012	185	35741	424	35836	419	36034	73
26225	115	28642	414	30410	58	33022	65	35013	185	35750	426	35837	419	36037	73
27000	96	28650	95	30420	58	33024	64	35014	185	35751	426	35839	422	36038	73
27100	96	28680	84	30430	58	33026	64	35015	185	35755	426	35840	422	36039	73
27200	96	28690	84	30440	58	33028	64	35017	185	35756	420	35842	423	36570	120
27322	96	28710	85	30450	58	33030	64	35018	185	35757	420	35843	419	36650	73
27333	96	28720	85	30460	58	33032	64	35020	185	35758	420	35846	423	37100	70
27495	96	28725	85	30480	58	33035	64	35021	186	35759	420	35850	423	37101	70
27500	99	28740	95	30500	58	33065	64	35025	186	35760	427	35855	420	37102	70
27501	99	28745	95	30510	58	33067	64	35026	186	35761	420	35860	423	37103	70
27502	99	28746	95	30520	58	33080	64	35030	186	35762	420	35861	420	37104	70
27505	99	28750	95	30531	58	33085	64	35031	186	35763	424	35863	420	37106	70
27506	99	28755	95	30532	58	33087	64	35032	186	35764	425	35864	423	37107	70
27510	99	28771	95	30533	58	33105	64	35033	186	35765	416	35865	423	37108	70
27511	99	28772	95	30534	58	33107	64	35060	186	35767	416	35867	343	37109	70
27513	99	28773	95	30535	58	33125	64	35061	186	35768	416	35868	343	37110	70
27520	99	28790	97	30536	58	33127	64	35062	187	35770	425	35869	343	37111	70
27530	99	28880	146	31050	58	33147	64	35063	187	35773	425	35870	343	37112	70
27533	99	29000	97	31070	58	33177	64	35064	187	35774	425	35872	343	37113	70

No.	Page	No.	Page	No.	Page	No.	Page	No.	Page	No.	Page	No.	Page	No.	Page
37114	70	40051	44	48080	92	51140	8	52659	10	53730	17	54901	123	56625	39
37115	70	40054	45	48081	93	51150	8	52660	10	54000	12	54902	123	56629	39
37150	70	40055	45	48082	93	51160	8	52661	10	54061	12	54903	123	56630	39
37200	70	40056	45	48100	92	51170	8	52680	11	54062	12	55100	121	56631	39
37250	70	40057	45	48150	93	51180	8	52700	11	54063	12	55150	121	56632	39
37300	70	40160	46	48200	93	51190	8	52730	11	54065	12	55200	121	56633	39
37380	70	40180	46	48330	93	51200	8	52740	11	54066	12	55210	121	56634	39
37400	70	40200	46	48350	94	51210	8	52750	11	54067	12	55211	121	56635	39
37430	70	40700	46	49200	93	51220	8	52770	11	54068	12	55212	121	56639	39
37500	70	41121	45	49450	94	51240	8	52790	11	54070	13	55215	121	56640	39
37800	70	41151	45	49600	94	51270	8	52820	11	54071	13	55216	121	56642	39
37900	70	41152	45	49770	94	51300	8	52900	11	54072	13	55217	121	56643	39
38150	70	41381	45	49771	94	51320	8	52935	12	54073	13	55220	121	56644	39
38200	70	41500	45	49772	94	51560	8	52936	12	54080	12	55221	121	56645	39
38401	70	41510	120	49773	94	51580	8	53002	16	54081	12	55222	121	56649	39
38402	70	42300	46	49774	94	51590	8	53003	16	54497	121	55250	120	56710	11
38403	70	42301	46	49775	94	51620	8	53100	16	54498	121	55300	120	56720	11
38404	70	42302	47	49800	184	51630	8	53120	16	54499	121	55350	120	56730	11
38406	70	42303	46	49801	184	51640	8	53130	16	54500	121	55400	127	56770	11
38407	70	42304	46	49802	184	51645	8	53140	16	54510	121	55500	126	56780	11
38408	70	42305	46	49805	184	51650	8	53150	16	54600	12	55505	126	56790	11
38409	70	42306	46	49806	184	51671	9	53170	16	54610	12	55541	126	56980	227
38430	72	42307	47	49810	184	51672	9	53180	16	54620	12	55542	126	56991	235
38431	72	42308	47	49830	183	51673	9	53190	16	54630	12	55544	127	57000	227
38432	72	42309	47	49840	133	51674	9	53220	16	54640	12	55545	127	57010	227
38433	72	43050	47	49841	133	51675	9	53240	16	54650	12	55620	120	57020	227
38434	72	43051	47	49900	183	51676	9	53332	16	54660	12	55625	120	57030	228
38435	72	43052	47	50070	10	51677	9	53335	16	54670	12	55630	120	57050	228
38436	72	43053	47	50090	10	51678	9	53336	16	54680	12	55635	120	57091	231
38490	71	43055	47	50100	10	51679	9	53337	16	54690	12	55645	120	57092	231
38493	71	43056	47	50110	10	51680	9	53338	16	54700	12	55660	120	57097	231
38497	71	43057	47	50120	10	51681	9	53339	16	54710	12	55690	120	57100	228
38500	71	43058	47	50130	10	51682	9	53340	16	54720	12	55740	125	57160	228
38515	71	43060	47	50150	10	51683	9	53341	16	54730	12	55792	121	57210	228
38525	71	43061	47	50170	10	51684	9	53400	16	54750	12	55820	120	57220	228
38531	72	43062	47	50190	10	51685	9	53410	16	54760	12	55830	120	57221	228
38620	71	43063	47	50220	10	51686	9	53420	16	54780	12	56040	40	57260	228
38641	71	43510	48	50270	10	51687	9	53430	16	54811	122	56050	40	57300	13
38642	71	43600	110	50330	10	51688	9	53440	16	54812	122	56060	40	57350	13
38643	71	43603	110	50560	10	51689	9	53450	16	54813	122	56070	40	57400	13
38750	72	44100	48	50580	10	51690	9	53460	16	54814	122	56080	40	57450	13
38751	72	44102	48	50590	10	51691	9	53470	16	54815	122	56100	40	57451	13
38830	72	44110	48	50610	10	51692	9	53480	16	54816	122	56120	40	57600	224
39000	235	44300	48	50630	10	51693	9	53490	16	54817	122	56130	40	57610	225
39001	235	44301	48	50850	8	51694	9	53500	17	54830	122	56140	40	57612	225
39002	235	44330	49	50861	8	51695	9	53520	17	54831	122	56170	40	57613	225
39005	235	44400	49	50871	8	51696	9	53540	17	54832	122	56380	40	57614	225
40010	44	44500	49	50880	9	51705	9	53560	17	54833	122	56390	40	57616	225
40011	44	45000	52	51040	8	51710	9	53561	17	54834	122	56391	40	57620	225
40012	44	45010	53	51042	8	51715	10	53563	17	54835	122	56392	40	57630	225
40013	44	45012	52	51044	8	51720	9	53571	17	54836	122	56393	40	57640	225
40014	44	45020	53	51046	8	51721	9	53572	17	54837	122	56400	40	57660	225
40015	44	45050	52	51047	8	51722	9	53573	17	54850	122	56470	40	57700	229
40016	44	45100	53	51048	8	51740	11	53575	18	54851	122	56473	40	57730	229
40017	44	45151	53	51049	8	51741	11	53576	18	54852	122	56475	41	57740	229
40018	44	45160	53	51051	8	52580	11	53577	18	54853	122	56477	41	57830	220
40041	44	45201	53	51060	8	52630	11	53580	18	54854	122	56478	41	58140	19
40042	44	45500	52	51070	8	52652	10	53600	16	54855	122	56505	41	58150	19
40043	44	45503	52	51080	8	52653	10	53610	16	54856	122	56506	41	58160	18
40044	44	45504	52	51090	8	52654	10	53630	16	54870	122	56507	41	58210	18
40045	44	48000	92	51100	8	52655	10	53650	16	54871	122	56600	41	58240	18
40047	44	48050	93	51110	8	52656	10	53670	16	54875	122	56622	39	58430	218
40048	44	48060	92	51120	8	52657	10	53700	17	54876	123	56623	39	58433	218
40050	44	48070	93	51130	8	52658	10	53710	17	54900	123	56624	39	58434	219

No.	Page	No.	Page	No.	Page	No.	Page	No.	Page	No.	Page	No.	Page	No.	Page
58440	219	60953	26	64654	29	67095	325	67661	317	68477	311	69609	143	71804	481
58441	220	60954	26	64655	30	67110	326	67700	305	68630	331	69610	143	71805	481
58450	220	60955	26	64658	30	67112	326	67702	305	68631	331	69612	143	71807	481
58455	220	60956	26	64660	31	67115	327	67703	306	68632	331	69613	143	71808	481
58456	221	60957	26	64952	30	67116	327	67705	306	68650	330	69630	142	71809	481
58539	218	60958	26	64960	30	67120	326	67707	306	68651	331	69631	142	71810	481
58540	216	60959	26	65025	31	67121	326	67709	306	68652	331	69635	142	71811	481
58550	217	60961	26	65041	30	67122	327	67710	307	68791	384	69637	142	71812	481
58600	18	60962	26	65045	32	67123	327	67780	304	68792	385	69851	444	71814	481
58602	18	60963	26	65100	32	67124	327	67781	304	68793	385	69860	444	71815	481
58633	19	60964	26	65105	30	67125	327	67790	305	69311	483	70000	130	71816	481
58634	19	60965	26	65120	31	67126	327	67805	304	69313	483	70020	130	71817	481
58640	19	60966	26	65123	31	67160	340	67840	307	69314	483	70023	130	71818	481
58641	19	60967	26	65124	32	67161	341	67841	307	69315	484	70030	130	71819	481
58643	20	60968	26	65150	32	67162	341	67851	307	69316	484	70035	130	71820	481
58661	20	60969	26	65233	54	67163	341	67872	323	69319	484	70100	130	71821	481
58685	20	60970	26	65235	54	67164	341	67877	322	69320	484	70160	131	71822	481
58687	20	60975	28	65260	229	67165	341	67880	322	69321	484	70201	131	71823	481
58688	21	60990	27	65270	229	67166	341	67881	323	69339	484	70202	131	71824	481
58690	21	61010	28	65700	35	67171	344	67882	323	69340	484	70210	131	71825	481
58691	22	61020	28	65705	35	67182	329	67883	323	69341	485	70270	131	71827	482
58693	23	61030	28	65800	36	67183	330	67884	323	69350	485	70280	213	71828	482
58700	22	61040	28	65840	38	67200	328	67885	323	69351	485	70320	131	71829	482
60750	28	61050	28	65850	38	67201	328	67887	323	69352	485	70330	131	71830	482
60780	27	61060	28	66080	37	67202	328	67888	323	69353	485	70340	131	71831	482
60781	27	61070	28	66112	38	67203	328	67889	323	69354	485	70400	131	71832	482
60782	27	61080	28	66113	38	67204	328	67890	323	69370	485	70410	131	71833	482
60783	27	61090	28	66200	38	67220	329	67900	308	69371	485	70420	131	71834	482
60785	27	61110	28	66210	38	67222	329	67901	308	69372	486	70430	131	71835	482
60880	26	61120	28	66301	35	67224	329	67920	305	69373	486	70480	131	71836	482
60881	26	61140	28	66302	35	67225	329	67961	304	69374	486	70490	131	71838	482
60882	26	61160	28	66310	36	67260	344	68014	321	69375	486	70500	131	71840	482
60883	26	61210	29	66330	36	67420	321	68032	315	69378	486	70510	131	71841	482
60885	26	61220	29	66400	36	67423	321	68033	315	69390	472	71000	132	71842	482
60886	26	61230	29	66410	36	67424	321	68090	330	69391	472	71040	132	71843	482
60887	26	61240	29	66570	36	67450	320	68100	330	69395	471	71050	132	71844	482
60888	26	61250	29	66580	37	67451	319	68115	330	69396	471	71052	132	71846	482
60889	26	61260	29	66710	37	67453	320	68172	308	69397	471	71060	132	71847	482
60890	26	61270	29	66720	37	67455	320	68173	308	69502	142	71080	133	71848	482
60891	26	61280	29	66760	37	67457	320	68174	309	69503	142	71160	133	71849	482
60912	26	61290	29	66770	37	67458	319	68194	309	69504	142	71603	475	71850	482
60913	26	61300	29	66841	332	67470	322	68206	309	69505	142	71604	475	71851	482
60914	26	61320	29	66842	332	67480	322	68207	309	69506	142	71605	475	71852	482
60915	26	61340	29	66900	332	67481	322	68208	310	69507	142	71610	473	71853	482
60916	26	61350	29	66901	332	67500	317	68209	310	69508	142	71611	473	71854	482
60917	26	61550	29	66902	332	67501	317	68216	310	69509	142	71612	473	71855	482
60918	26	64050	33	66903	333	67520	319	68217	310	69510	142	71614	474	71856	482
60920	26	64060	32	66904	333	67525	318	68218	311	69539	143	71615	474	71857	482
60921	26	64070	33	66906	333	67526	318	68219	311	69540	143	71616	474	71858	482
60922	26	64090	33	66930	333	67527	319	68223	311	69542	143	71620	475	71859	482
60923	26	64310	34	66931	333	67528	318	68260	325	69543	143	71630	474	71860	482
60924	26	64330	34	67011	385	67530	318	68269	316	69546	143	71631	474	71970	133
60931	26	64370	33	67012	386	67572	312	68270	315	69550	143	71632	474	71971	133
60932	26	64371	34	67013	386	67573	312	68271	316	69551	143	71633	474	71972	133
60933	26	64384	34	67014	386	67574	312	68272	316	69552	143	71634	474	71975	134
60934	26	64385	31	67019	387	67585	313	68273	316	69560	142	71635	474	71976	134
60935	26	64395	34	67026	385	67586	313	68280	315	69561	142	71636	474	71977	134
60936	26	64396	34	67032	386	67587	313	68360	324	69562	142	71637	474	71980	133
60937	26	64400	33	67033	386	67589	313	68361	324	69563	142	71638	474	71981	133
60938	26	64401	33	67034	387	67590	313	68362	324	69564	142	71639	474	71982	133
60939	26	64553	35	67090	325	67640	314	68363	324	69565	142	71800	481	71983	133
60950	26	64554	35	67091	325	67641	314	68364	324	69566	142	71801	481	71990	134
60951	26	64555	226	67093	325	67642	314	68365	324	69572	142	71802	481	71991	134
60952	26	64650	32	67094	325	67660	317	68470	312	69608	143	71803	481	71992	134

No.	Page	No.	Page	No.	Page	No.	Page	No.	Page	No.	Page	No.	Page	No.	Page
71993	134	72527	377	72974	339	73568	138	73935	369	74146	364	74604	368	74838	355
71994	134	72528	377	72975	340	73569	138	73936	369	74149	365	74610	368	74841	355
71995	134	72529	377	72976	339	73570	138	73937	369	74150	364	74622	368	74843	355
71996	134	72530	377	72977	340	73571	138	73938	369	74151	364	74624	368	74846	355
71997	134	72531	377	72978	340	73572	138	73939	369	74162	364	74626	371	74849	355
72000	134	72532	377	72979	340	73598	138	73940	369	74171	369	74627	371	74851	355
72001	134	72533	377	72981	340	73780	138	73941	369	74172	369	74628	371	74853	355
72010	134	72534	377	72984	340	73781	138	73942	369	74173	369	74631	372	74855	355
72011	134	72535	377	72985	340	73782	138	73943	369	74174	369	74632	372	74856	355
72012	134	72570	378	72994	338	73783	138	73945	369	74175	369	74633	372	74858	355
72013	134	72572	378	72995	338	73784	138	73946	369	74176	369	74646	372	74861	355
72015	134	72573	378	72996	338	73785	138	73947	369	74230	370	74647	372	74863	355
72016	134	72615	377	72997	338	73786	138	73950	370	74231	370	74653	371	74866	356
72017	134	72616	377	72998	338	73787	139	73951	370	74232	371	74654	371	74869	356
72018	134	72617	377	73021	338	73788	139	73952	370	74233	371	74655	371	74882	356
72019	134	72620	377	73022	338	73789	139	73953	370	74240	371	74657	372	74885	356
72020	134	72621	377	73025	338	73790	139	73954	370	74410	278	74658	372	74886	356
72021	134	72622	377	73026	338	73791	139	73955	370	74411	278	74659	372	74887	356
72022	134	72625	377	73027	338	73792	139	73958	370	74420	278	74660	371	74910	356
72040	133	72626	377	73031	339	73793	139	73959	370	74421	278	74661	371	74911	356
72060	133	72627	377	73032	339	73794	139	73960	370	74422	278	74662	371	74912	356
72080	133	72630	377	73033	339	73795	139	73961	370	74430	278	74663	371	74913	356
72100	133	72631	377	73034	339	73796	139	73962	370	74431	278	74664	371	74914	356
72120	133	72632	377	73035	339	73797	139	73963	370	74432	278	74665	371	74920	356
72140	133	72683	370	73051	260	73798	139	73964	370	74439	281	74666	371	74921	356
72350	376	72684	370	73052	258	73799	139	73966	370	74440	278	74667	371	74922	356
72351	376	72685	370	73056	258	73800	139	73967	370	74441	279	74721	350	74923	356
72352	376	72686	370	73057	258	73801	139	73968	370	74442	278	74722	350	74924	356
72353	376	72920	347	73060	261	73802	139	73969	370	74443	279	74723	350	75000	141
72354	376	72922	348	73260	140	73803	139	73970	370	74447	279	74724	350	75031	142
72355	376	72928	347	73270	140	73804	139	73971	370	74450	279	74730	357	75050	141
72356	376	72931	348	73271	140	73805	139	73972	370	74451	280	74731	357	75060	141
72357	376	72932	348	73300	140	73806	139	73973	370	74452	280	74732	357	75100	141
72358	376	72933	337	73325	158	73807	139	74003	365	74453	280	74733	357	75120	180
72370	376	72934	337	73330	158	73808	139	74005	365	74454	280	74734	357	75121	180
72371	376	72935	337	73331	158	73840	139	74060	365	74455	280	74750	357	75122	180
72372	376	72936	337	73340	159	73843	139	74077	364	74457	279	74751	358	75123	180
72373	376	72937	337	73341	159	73845	139	74078	364	74459	365	74752	358	75124	180
72400	379	72938	338	73342	159	73850	139	74079	364	74460	365	74753	358	75125	180
72401	379	72939	338	73343	159	73853	139	74080	364	74462	367	74765	358	75130	180
72402	379	72942	339	73350	160	73855	139	74081	364	74466	367	74766	358	75131	180
72404	378	72943	339	73351	160	73875	140	74082	364	74468	367	74771	358	75132	180
72407	379	72944	339	73352	160	73881	139	74094	362	74471	367	74772	358	75133	180
72440	378	72945	339	73353	160	73882	139	74100	362	74480	279	74773	359	75140	141
72441	378	72948	338	73360	160	73883	139	74102	362	74485	280	74775	359	75141	141
72442	378	72950	338	73362	160	73884	139	74104	362	74486	280	74776	359	75201	125
72460	376	72951	338	73400	157	73885	139	74108	362	74487	280	74785	470	75202	125
72484	377	72952	338	73403	157	73886	139	74113	363	74501	365	74786	470	75230	141
72486	377	72953	338	73404	157	73887	139	74115	363	74503	366	74787	471	75231	141
72489	377	72954	338	73410	158	73888	139	74117	363	74504	366	74789	471	75233	141
72490	377	72955	337	73412	158	73892	139	74121	363	74505	365	74790	471	75238	180
72493	377	72956	339	73413	158	73893	139	74123	363	74508	366	74791	471	75239	180
72494	377	72958	339	73420	157	73894	139	74125	362	74509	366	74792	471	75240	180
72500	376	72960	339	73430	159	73895	139	74126	362	74540	366	74794	471	75245	141
72501	376	72963	339	73470	271	73896	139	74127	363	74541	366	74802	354	75246	141
72504	376	72964	339	73473	271	73897	139	74128	363	74542	366	74804	354	75247	141
72505	376	72965	339	73490	203	73898	139	74130	362	74543	366	74812	354	75260	140
72506	376	72966	339	73500	272	73906	139	74131	362	74555	367	74816	354	75261	140
72508	376	72967	339	73503	202	73909	139	74132	362	74580	369	74818	354	75262	140
72509	376	72968	339	73561	138	73929	139	74134	363	74581	369	74820	354	75270	180
72510	376	72969	339	73562	138	73931	369	74135	363	74595	368	74828	354	75271	180
72524	377	72970	339	73563	138	73932	369	74136	363	74600	367	74831	354	75272	180
72525	377	72972	337	73565	138	73933	369	74137	363	74601	368	74833	354	75273	180
72526	377	72973	337	73567	138	73934	369	74145	364	74602	368	74835	354	75274	180

No.	Page	No.	Page	No.	Page	No.	Page	No.	Page	No.	Page	No.	Page	No.	Page
75285	180	75464	487	75672	470	75944	488	76822	273	77830	298	78184	253	78633	285
75286	180	75465	486	75673	470	75945	488	76823	273	77831	298	78185	253	78641	284
75287	180	75467	486	75674	470	75951	488	76826	273	77833	298	78186	254	78642	284
75288	180	75469	487	75675	469	75953	489	76830	273	77834	298	78187	254	78658	350
75295	140	75470	487	75676	469	75954	488	76832	273	77835	298	78190	254	78660	349
75300	180	75471	487	75705	466	76000	106	76835	274	77837	298	78203	253	78661	349
75301	180	75472	487	75706	467	76010	106	76836	274	77838	298	78204	253	78662	349
75302	180	75483	476	75707	467	76011	106	76850	273	77840	298	78210	254	78663	349
75303	180	75484	476	75708	467	76015	107	76851	273	77845	298	78211	254	78670	350
75304	180	75487	476	75709	467	76030	107	76852	273	77850	299	78250	255	78690	187
75327	475	75498	475	75710	467	76035	106	76853	273	77861	299	78252	255	78691	187
75334	475	75499	475	75711	467	76036	106	76854	273	77881	299	78260	255	78720	292
75335	475	75527	479	75712	468	76040	106	76855	273	77900	288	78261	255	78730	292
75336	475	75535	479	75716	461	76041	106	76856	273	77910	288	78262	254	78731	292
75345	472	75536	479	75718	461	76101	107	76857	273	77930	288	78300	224	78734	293
75346	472	75537	479	75719	462	76160	107	76858	273	77990	213	78301	224	78736	293
75347	472	75539	479	75729	468	76180	107	76859	273	78000	223	78303	224	78738	293
75348	472	75544	476	75775	468	76181	107	76870	274	78002	223	78306	224	78750	292
75349	472	75545	476	75776	468	76182	108	76877	274	78003	223	78340	124	78751	292
75350	472	75550	476	75777	468	76183	108	76880	274	78007	223	78341	124	78752	292
75351	472	75551	476	75778	468	76184	107	76881	274	78020	348	78342	124	78756	230
75352	472	75553	480	75779	469	76185	107	76882	274	78021	348	78345	124	78771	294
75353	472	75554	480	75801	460	76186	108	76883	274	78022	348	78370	123	78780	294
75354	472	75555	483	75802	460	76190	108	76884	274	78027	140	78375	124	78785	295
75355	472	75558	483	75803	460	76210	108	77004	285	78030	223	78381	124	78788	294
75356	472	75559	483	75805	462	76214	108	77005	285	78031	223	78385	125	78791	295
75360	473	75564	479	75807	462	76220	108	77006	285	78032	224	78388	124	78794	295
75361	473	75565	479	75808	462	76230	108	77061	285	78035	224	78400	230	78800	293
75362	473	75578	480	75809	462	76250	108	77062	285	78037	222	78401	230	78801	293
75363	473	75579	480	75812	463	76305	109	77063	285	78039	222	78405	230	78802	294
75364	473	75619	478	75813	463	76311	109	77064	285	78040	221	78410	230	78811	294
75365	473	75620	478	75815	463	76312	110	77100	287	78041	221	78412	284	78812	294
75366	473	75621	478	75817	463	76314	110	77105	287	78042	221	78434	284	78813	294
75367	473	75622	478	75818	463	76320	54	77170	288	78043	222	78436	284	78814	294
75368	473	75623	479	75827	463	76526	105	77180	288	78044	224	78477	220	78815	294
75369	473	75624	478	75828	464	76621	105	77190	288	78045	222	78540	336	78819	295
75370	473	75625	477	75829	464	76622	105	77191	288	78046	221	78541	336	78821	295
75371	473	75626	477	75830	465	76640	105	77192	288	78047	222	78542	336	78822	295
75372	473	75627	477	75831	465	76650	105	77193	288	78061	222	78543	336	78824	295
75373	473	75628	477	75832	465	76660	106	77200	287	78067	222	78555	336	78825	295
75374	473	75631	477	75833	465	76700	110	77203	287	78068	222	78556	336	78830	295
75375	473	75632	477	75834	464	76705	110	77204	287	78080	251	78557	336	78831	295
75376	473	75633	477	75835	465	76710	110	77205	287	78081	251	78570	336	78833	295
75377	473	75634	477	75836	464	76750	353	77210	286	78082	251	78571	336	78834	295
75378	473	75635	478	75837	464	76751	354	77211	286	78084	251	78572	336	78835	295
75379	473	75636	478	75838	464	76752	353	77212	286	78085	251	78575	336	78855	259
75380	473	75639	478	75852	469	76755	353	77213	286	78090	251	78576	336	78870	348
75381	473	75645	480	75853	469	76756	354	77250	286	78091	251	78577	336	78890	261
75382	473	75646	480	75870	462	76757	353	77300	286	78097	254	78580	336	78894	260
75383	473	75647	480	75884	465	76760	353	77350	286	78107	251	78581	336	78910	125
75384	473	75648	480	75885	466	76761	354	77400	286	78113	251	78582	336	78911	125
75386	473	75649	480	75886	466	76762	353	77500	286	78125	252	78585	336	78912	125
75387	473	75650	480	75887	466	76765	353	77600	286	78132	252	78586	336	78972	256
75388	473	75651	480	75888	466	76766	354	77606	286	78133	252	78587	336	78974	256
75389	473	75652	481	75889	466	76767	353	77607	286	78136	252	78590	337	78981	255
75421	474	75653	481	75915	488	76800	273	77608	286	78137	252	78591	337	78982	255
75422	474	75654	481	75916	488	76806	273	77609	286	78138	252	78592	337	78983	256
75423	474	75655	481	75921	489	76807	273	77612	287	78139	252	78620	284	78985	256
75424	474	75662	461	75922	490	76810	273	77618	287	78143	252	78622	284	78986	256
75448	474	75663	461	75923	490	76811	273	77700	287	78151	252	78624	284	78987	256
75449	474	75664	461	75924	490	76814	273	77704	287	78155	253	78626	285	78992	250
75450	474	75665	461	75930	489	76815	273	77705	287	78158	253	78628	285	78995	250
75451	474	75670	469	75931	489	76818	273	77715	301	78180	253	78630	285	78997	250
75455	487	75671	470	75932	489	76819	273	77815	299	78181	253	78632	285	79049	250

No.	Page	No.	Page	No.	Page	No.	Page	No.	Page	No.	Page	No.	Page	No.	Page
79054	250	79800	271	80470	226	81527	212	82206	236	82411	242	83004	238	87301	351
79087	256	79810	262	80471	226	81553	211	82209	236	82412	242	83005	239	87302	351
79088	256	79811	262	80472	226	81556	211	82227	236	82413	242	83009	223	87303	351
79089	256	79812	262	80473	226	81560	211	82231	237	82414	242	83016	238	87305	351
79093	256	79823	275	80474	226	81562	211	82232	236	82415	242	83017	238	87307	351
79135	257	79824	275	80500	226	81570	211	82233	237	82431	237	83018	238	87311	351
79254	257	79861	266	80510	226	81617	209	82234	236	82440	237	83260	240	87312	351
79257	257	79862	266	80520	226	81618	209	82260	244	82445	237	83262	240	87313	351
79309	257	79863	266	80530	226	81631	210	82261	244	82504	237	83280	240	87315	351
79314	260	79865	266	80600	226	81632	210	82262	244	82506	237	83290	240	87317	351
79320	258	79866	266	80601	226	81633	210	82265	243	82520	237	83291	240	87321	351
79324	260	79867	266	80602	226	81634	211	82266	243	82541	233	84400	200	87322	351
79325	260	79869	266	80620	227	81638	210	82267	243	82542	233	85000	243	87323	351
79327	258	79880	262	80640	227	81640	210	82270	243	82543	234	85001	243	87325	351
79328	258	79909	259	80660	228	81643	210	82271	243	82544	234	85002	243	87327	351
79346	271	79911	270	80661	228	81644	210	82272	243	82610	234	85003	243	87331	351
79350	266	79919	270	80751	234	81647	211	82273	243	82611	234	85004	243	87332	351
79354	259	79924	270	80752	234	81650	208	82274	243	82650	234	85005	243	87333	351
79358	266	79926	263	80753	234	81651	208	82275	243	82671	377	85020	346	87335	351
79365	259	79927	263	80901	209	81653	209	82280	243	82673	377	85030	346	87337	351
79366	259	79928	263	80902	209	81661	209	82281	243	82675	377	85040	346	87351	351
79367	259	79929	263	80903	209	81690	229	82282	243	82682	378	85050	346	87352	351
79368	259	79930	263	80970	207	81700	200	82300	240	82684	378	85060	346	87353	351
79386	272	79931	263	81060	208	81711	200	82301	241	82685	378	85080	346	87354	351
79390	274	79932	263	81100	206	81713	200	82305	241	82699	380	85090	346	87361	352
79391	274	79933	263	81101	206	81716	200	82308	241	82706	380	85100	346	87362	352
79398	273	79943	259	81107	206	81719	201	82310	241	82707	382	85112	346	87363	352
79416	257	79944	262	81108	206	81731	229	82315	241	82723	380	85113	346	87364	352
79448	263	79960	399	81109	206	81741	234	82320	241	82724	381	85114	346	87371	352
79468	267	79962	399	81110	206	81751	200	82322	244	82726	382	85115	346	87372	352
79491	257	79963	399	81114	207	81772	54	82331	241	82730	381	85116	346	87373	352
79502	263	79965	399	81115	207	81773	55	82331	241	82731	381	85118	346	87374	352
79503	263	79968	399	81117	207	81775	55	82341	241	82732	382	85119	346	87381	352
79550	266	79971	399	81118	207	81780	54	82343	243	82733	381	85120	346	87382	352
79551	266	79977	275	81119	207	81783	54	82355	72	82734	381	85122	346	87383	352
79552	267	79978	275	81133	208	81784	55	82360	241	82743	381	85123	346	87384	352
79560	267	79979	275	81142	208	81785	199	82370	241	82756	382	85124	346	87391	352
79561	267	79982	275	81370	212	81786	199	82372	242	82771	379	85125	346	87392	352
79562	267	79983	275	81371	212	81791	198	82373	242	82772	379	85126	346	87393	352
79563	267	79984	275	81372	212	81795	198	82374	242	82830	384	85128	346	87401	352
79564	267	80012	231	81373	212	81801	55	82375	242	82831	384	85129	346	87402	352
79565	267	80022	231	81374	212	81822	230	82377	241	82832	384	85130	346	87403	352
79566	268	80032	231	81378	212	81824	230	82378	241	82861	379	85131	346	87411	352
79567	268	80042	231	81379	212	81825	231	82379	241	82863	379	85132	346	87412	352
79570	270	80052	231	81380	212	81827	230	82380	241	82870	379	85133	346	87413	352
79580	270	80062	231	81387	213	81830	218	82384	242	82871	380	85134	346	87431	353
79630	270	80072	231	81390	212	81860	219	82386	242	82881	380	85135	346	87432	353
79639	271	80082	231	81391	212	81863	219	82388	242	82882	380	85170	346	87433	353
79640	271	80107	232	81399	213	82000	299	82390	242	82920	237	85172	346	87435	353
79641	271	80111	231	81400	213	82001	300	82392	242	82941	272	85174	347	87437	353
79675	264	80252	232	81401	213	82005	299	82393	242	82942	260	85177	347	87451	353
79725	264	80271	232	81490	212	82015	300	82395	242	82952	239	85178	347	87452	353
79734	264	80300	232	81491	212	82020	300	82397	243	82953	239	85180	347	87453	353
79771	262	80307	232	81492	212	82021	300	82400	242	82954	239	85190	347	87454	353
79772	262	80308	232	81500	212	82022	300	82401	242	82955	239	85191	347	87455	353
79773	262	80309	232	81501	212	82023	300	82402	242	82967	239	86700	349	87456	353
79774	262	80312	232	81502	212	82031	299	82403	242	82970	240	86701	349	87457	353
79775	262	80320	233	81519	212	82032	299	82404	242	82971	240	86750	126	88422	384
79781	259	80330	233	81520	212	82100	235	82405	242	82991	444	86751	126	88555	382
79782	259	80340	233	81521	212	82107	235	82406	242	82992	444	86760	126	88560	382
79783	259	80350	233	81522	212	82120	235	82407	242	83000	238	86761	126	88672	383
79790	262	80402	232	81523	212	82200	236	82408	242	83001	238	86770	126	88674	383
79791	262	80412	233	81524	212	82201	236	82409	242	83002	238	86771	126	88675	383
79792	262	80450	233	81525	212	82205	236	82410	242	83003	238	87245	351	88676	383

No.	Page	No.	Page	No.	Page	No.	Page	No.	Page	No.	Page	No.	Page	No.	Page
88677	383	88903	406	89101	390	89246	392	89405	268	89552	400	99037	417	99419	430
88680	383	88904	406	89102	390	89247	393	89406	268	89553	400	99038	417	99420	430
88681	383	88905	406	89103	390	89248	393	89411	268	89560	441	99039	417	99421	430
88700	435	88906	406	89104	391	89251	392	89412	268	89561	441	99040	417	99425	431
88701	435	88907	405	89105	391	89252	392	89413	268	89562	441	99047	415	99426	431
88702	435	88908	405	89106	392	89253	391	89414	268	89563	441	99048	415	99427	431
88703	435	88909	407	89107	392	89257	397	89415	268	89564	441	99049	416	99428	431
88704	435	88910	405	89108	392	89259	397	89416	268	89610	432	99050	415	99429	431
88705	435	88911	405	89109	392	89260	397	89421	269	89611	432	99051	415	99430	431
88710	435	88912	405	89110	391	89263	396	89422	269	89700	434	99052	416	99435	431
88713	435	88913	404	89113	393	89269	397	89423	269	89702	434	99053	418	99436	431
88714	435	88914	404	89120	393	89272	396	89424	269	89704	435	99054	418	99438	431
88715	436	88915	404	89162	398	89275	397	89425	269	89715	434	99101	411	99440	431
88716	436	88916	404	89163	398	89277	397	89426	269	89720	434	99103	412	99442	431
88718	436	88917	403	89164	398	89280	397	89441	268	89722	434	99104	412	99443	431
88720	418	88920	403	89165	398	89290	399	89442	268	89750	438	99109	412	99444	431
88740	436	88925	397	89166	398	89291	399	89443	268	89753	438	99110	413	99445	431
88780	400	88926	401	89167	398	89292	399	89444	268	89770	438	99111	412	99446	431
88783	401	88927	401	89187	393	89293	399	89452	268	89860	443	99112	413	99460	66
88784	401	88930	408	89189	394	89294	399	89453	268	89870	443	99113	412	99461	66
88801	436	88931	408	89190	394	89295	399	89454	268	89877	443	99114	412	99462	66
88805	437	88932	408	89191	395	89298	398	89456	269	89880	417	99115	413	99463	66
88806	437	88933	409	89192	395	89299	398	89457	269	89890	417	99116	412	99464	66
88809	437	88935	409	89193	394	89300	398	89458	269	89891	418	99119	412	99472	65
88811	437	88936	409	89195	395	89302	398	89459	269	89896	442	99180	411	99528	456
88812	437	88938	409	89200	393	89303	398	89462	269	89950	443	99181	411	99568	456
88820	437	88939	409	89201	393	89305	398	89463	269	89990	443	99182	411	99575	456
88830	437	88960	407	89202	393	89307	398	89464	269	90000	438	99190	410	99576	457
88831	437	88961	407	89203	395	89308	398	89465	269	90001	438	99191	411	99584	450
88832	438	88962	407	89204	395	89310	398	89466	269	90002	439	99193	409	99642	446
88840	402	88963	407	89206	395	89311	399	89467	269	90003	439	99194	409	99643	446
88841	402	88964	407	89207	395	89312	399	89470	269	90030	439	99195	411	99644	444
88842	402	88965	407	89208	396	89313	399	89471	269	90031	439	99202	410	99645	445
88849	402	88966	408	89209	394	89314	399	89472	269	90150	440	99203	410	99646	445
88850	401	88967	408	89210	394	89315	399	89473	269	90200	441	99204	410	99647	446
88851	401	88968	408	89211	395	89316	399	89474	269	90204	441	99206	410	99649	446
88853	403	88969	408	89213	394	89318	399	89475	269	90205	442	99207	410	99654	447
88855	406	88970	408	89214	394	89319	399	89478	270	90240	441	99208	410	99655	447
88856	405	88980	408	89215	394	89320	399	89479	270	90350	439	99209	410	99656	447
88857	404	88981	408	89218	396	89330	400	89480	270	90360	439	99230	409	99657	445
88858	403	88982	408	89220	395	89331	400	89481	270	91000	435	99240	411	99658	445
88859	403	88983	408	89221	390	89335	400	89482	270	91003	435	99250	411	99659	447
88860	405	88984	408	89222	390	89336	400	89483	269	91046	436	99300	414	99670	447
88861	406	88985	408	89223	390	89345	400	89484	269	91047	436	99301	414	99671	447
88862	406	88986	408	89224	390	89351	396	89485	269	91048	436	99310	413	99702	453
88863	406	88987	408	89225	390	89360	399	89486	269	91049	436	99315	413	99704	454
88864	407	88988	408	89226	390	89361	399	89507	431	91050	436	99390	426	99705	454
88865	407	88989	408	89227	390	89370	399	89508	431	91052	436	99391	427	99706	455
88869	404	89000	440	89228	390	89371	399	89509	431	91060	436	99400	425	99707	454
88870	403	89001	390	89229	390	89372	399	89515	432	91061	436	99401	427	99708	455
88871	404	89002	390	89230	390	89373	399	89518	432	92100	440	99402	429	99711	454
88872	405	89003	390	89231	390	89380	399	89520	432	92105	440	99403	429	99715	453
88874	404	89004	390	89232	390	89381	399	89526	432	92110	440	99404	429	99716	454
88890	403	89007	391	89233	391	89382	399	89528	432	92115	440	99405	431	99760	455
88891	402	89008	391	89234	391	89383	399	89536	432	99001	413	99406	431	99761	455
88892	402	89011	391	89235	392	89384	399	89537	433	99005	413	99407	430	99762	455
88893	402	89013	392	89236	392	89385	399	89538	433	99006	413	99408	429	99782	455
88894	402	89015	391	89239	391	89386	399	89539	433	99007	414	99409	430	99783	456
88895	401	89017	392	89240	391	89387	399	89540	433	99008	414	99410	429	99800	456
88896	401	89018	392	89241	392	89390	396	89541	433	99009	414	99412	430	99805	456
88897	401	89020	392	89242	392	89401	268	89542	433	99033	417	99413	431	99820	456
88899	403	89022	393	89243	393	89402	268	89543	433	99034	416	99415	429	99900	451
88900	407	89081	435	89244	393	89403	268	89545	434	99035	416	99416	430	99901	450
88902	407	89100	390	89245	392	89404	268	89547	434	99036	416	99418	430	99902	450

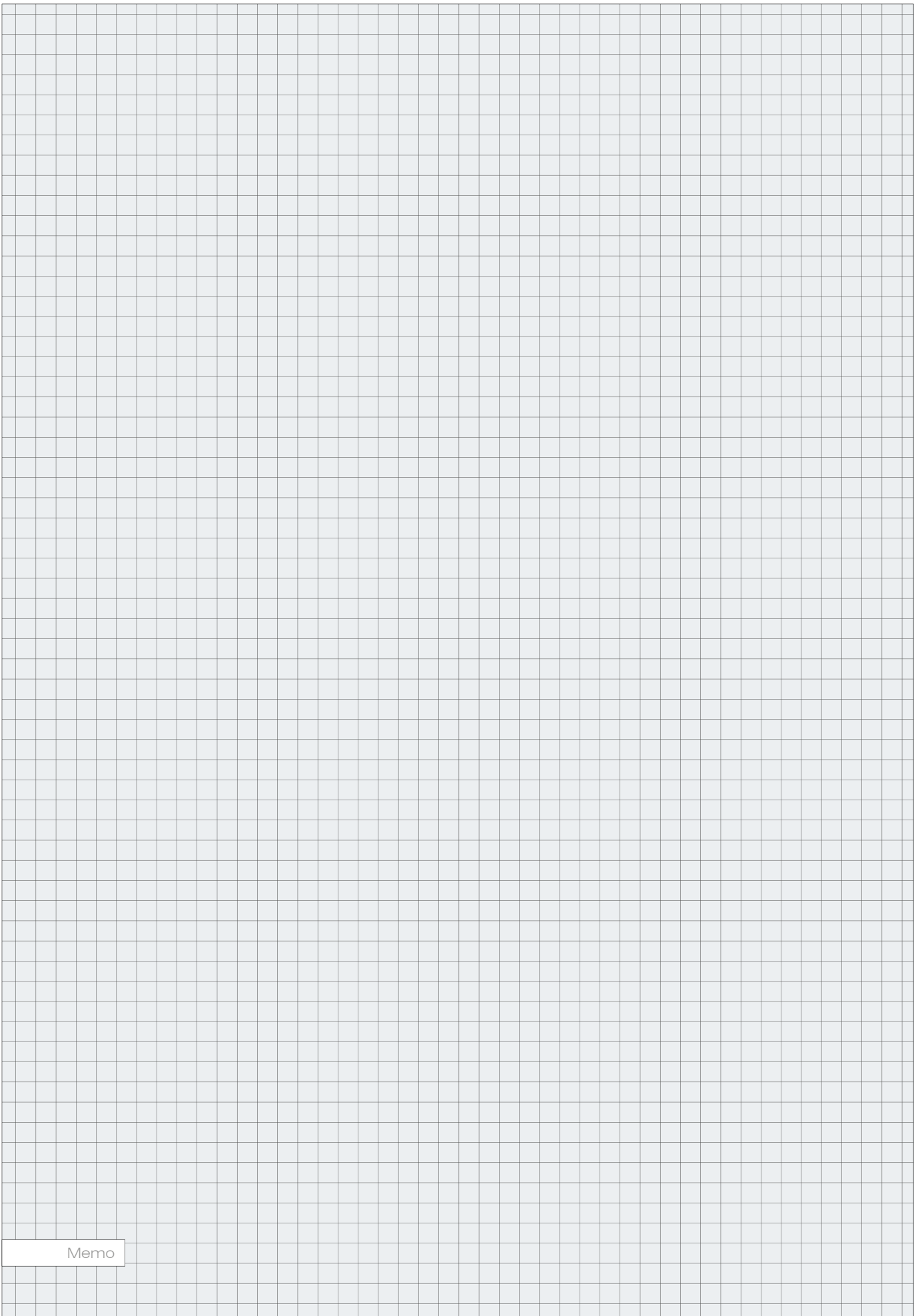

Memo

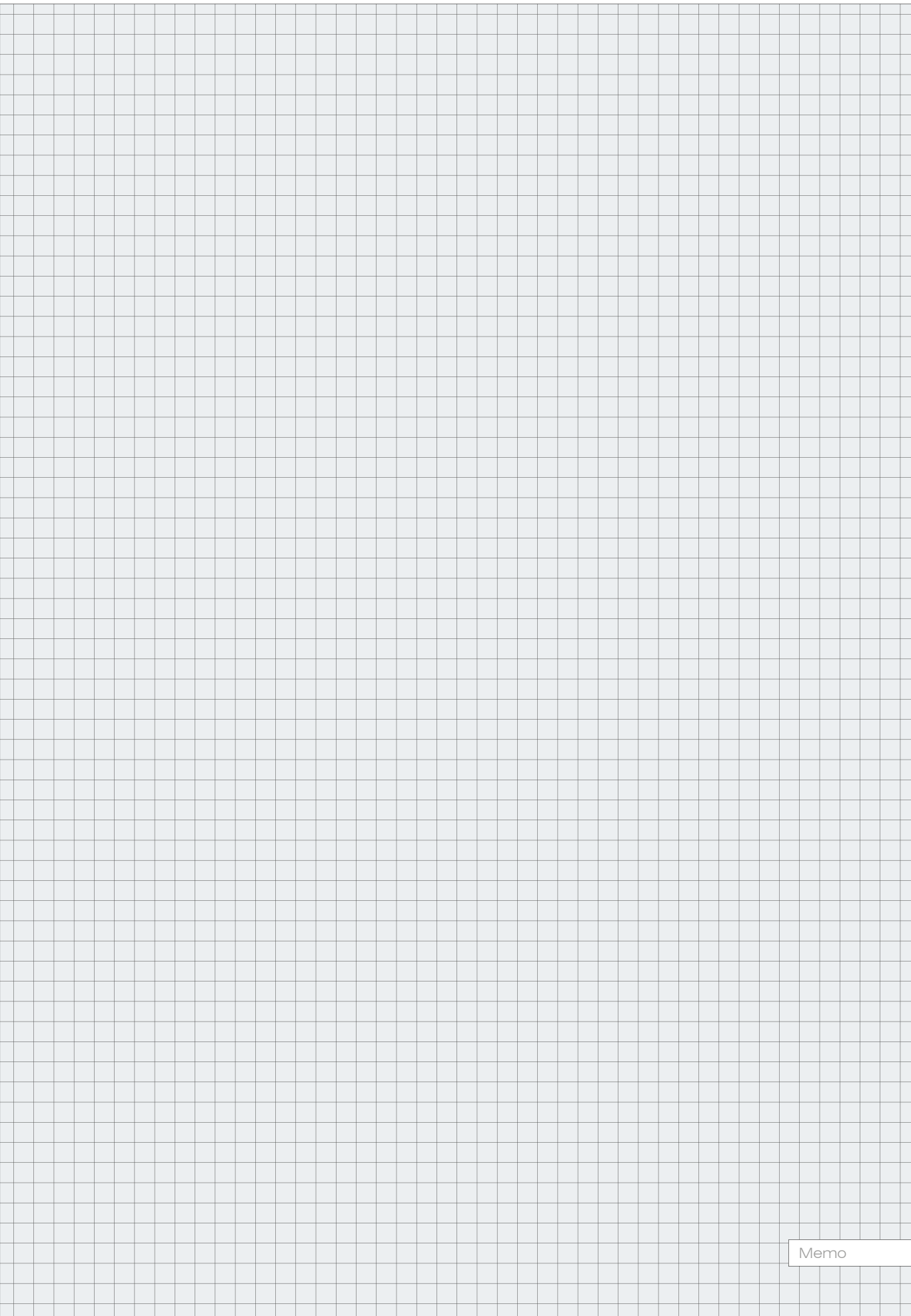

Memo

PL

I. TOYA S.A. informuje, iż:

- 1) niniejszy katalog nie stanowi oferty w rozumieniu prawa cywilnego;
- 2) prezentowane w niniejszym katalogu artykuły mogą w rzeczywistości odbiegać od wskazanego na zdjęciach wzoru, w szczególności jeżeli chodzi o cechy zewnętrzne, tj. wielkość, kolor, sposób opakowania, ilość przedmiotów w opakowaniu;
- 3) nie ponosi odpowiedzialności za drobne różnice w sposobie pakowania czy właściwościach artykułów pozostających bez wpływu na jego przeznaczony cel lub sposób użytkowania;
- 4) nie ponosi odpowiedzialności wynikającej z jakichkolwiek niedokładności lub nieścisłości, co do informacji zawartych w przedmiotowym katalogu;
- 5) nie ponosi odpowiedzialności za ewentualną szkodę powstałą w wyniku otrzymania towaru o innych właściwościach niż prezentowany na zdjęciach.

II. Pomimo najlepszych starań poczynionych przez TOYA S.A. nie może ona zagwarantować, iż informacje zawarte w niniejszym katalogu w pełni odpowiadają rzeczywistości.

III. Wszelkie decyzje podjęte na podstawie informacji zawartych w przedmiotowym katalogu podejmowane są na własne ryzyko osoby, która korzysta z tych informacji.

GB

I. TOYA S.A. informs that:

- 1) the present catalogue does not constitute an offer as construed in the civil law;
- 2) the goods presented in the present catalogue may in fact differ from the models shown in the pictures, particularly as far as external properties are concerned, namely size, colour, packaging, number of items in the package;
- 3) the company will not be held responsible for small differences in packaging or properties of the goods, which do not affect the purpose or the exploitation of the tools;
- 4) the company will not be held responsible for any inaccuracies or imprecision regarding the information presented in the catalogue;
- 5) the company will not be held responsible for any damage caused by goods whose properties differ from those of the tools presented in the photographs.

II. In spite of all the efforts made by TOYA S.A., the company cannot guarantee the information contained in the present catalogue fully correspond to the reality.

III. Any decisions made on the basis of the information contained in the present catalogue will be made at the risk of the person who makes them using the aforementioned information.

D

I. TOYA S.A. informiert, dass:

- 1) der vorliegende Katalog kein Angebot im zivilrechtlichen Sinne darstellt;
- 2) die im vorliegenden Katalog präsentierten Artikel in der Realität von den auf den Musterfotos gezeigten abweichen können, und zwar besonders dann, wenn es um äußere Eigenschaften geht, wie z.B. Größe, Farbe, Art der Verpackung, Anzahl der Gegenstände in der Verpackung;
- 3) sie keine Verantwortung für geringfügige Unterschiede bei der Verpackungsart oder den Eigenschaften der Artikel übernimmt, die ohne Auswirkungen auf seinen Bestimmungszweck oder die Art der Nutzung bleiben;
- 4) sie keine Verantwortung für irgendwelche Oberflächlichkeiten und Ungenauigkeiten bzgl. der im Sachkatalogkatalog enthaltenen Informationen übernimmt;
- 5) sie keine Verantwortung für eventuelle Schäden, die im Ergebnis des Erhalts der Ware mit anderen als auf den Fotos dargestellten Eigenschaften entstanden sind, übernimmt.

II. Trotz großer Bemühungen seitens TOYA S.A. kann die Firma nicht garantieren, dass die im vorliegenden Katalog enthaltenen Informationen voll der Realität entsprechen.

III. Sämtliche Entscheidungen, die auf der Grundlage der im Sachkatalog enthaltenen Informationen getroffen wurden, gehen auf das Risiko der Person, die diese Informationen benutzt.

RUS

I. TOYA S.A. заявляет:

- 1) настоящий каталог не является торговым предложением с точки зрения гражданского законодательства;
- 2) изделия, представленные в настоящем каталоге, могут отличаться от образцов на снимках, особенно внешним видом, то есть размером, цветом, способом упаковки, количеством предметов в упаковке;
- 3) производитель не отвечает за мелкие отличия в способе упаковки или свойствах изделий, которые не влияют на предназначение или способ пользования изделиями;
- 4) производитель не отвечает за мелкие неточности в сведениях из предметного каталога;
- 5) производитель не отвечает за ущерб, нанесенный вследствие поставки товара, отличающегося параметрами от указанного на снимках.

II. Несмотря на все усилия в данном направлении, компания TOYA S.A. не гарантирует, что информация, метящаяся в настоящем каталоге, полностью отвечает действительности.

III. Риск, связанный с любыми решениями, принятыми на основании информации из предметного каталога, берут на себя лица, пользующиеся указанной информацией.

UA

I. Інформація від виробника, TOYA S.A.:

- 1) цей каталог не є комерційною пропозицією з точки зору цивільного законодавства;
- 2) вироби, представлені у цьому каталозі, можуть відрізнятися від зображень на фотографіях, особливо зовнішнім виглядом, тобто розміром, кольором, способом упаковки, кількістю предметів в упаковці;
- 3) виробник не несе відповідальність за дрібні відмінності у способі упаковки чи властивостях виробів, які не мають впливу на їх призначення чи спосіб користування ними;
- 4) виробник не несе відповідальність за дрібні неточності у інформації, включеної у цей каталог;
- 5) виробник не несе відповідальність за можливі збитки, нанесені внаслідок отримання виробів, що своїми параметрами відрізняються від зображень на фотографіях.

II. Незважаючи на зусилля у даному напрямку, фірма TOYA S.A. не гарантує, що інформація, включена у цей каталог, повністю відповідає дійсності.

III. Приймаючи будь-які рішення на підставі інформації, включеної у цей каталог, не забувайте, що пов'язаний з ними ризик беруть на себе особи, що використовують включену у каталог інформацію.

LT

I. TOYA S.A. informuoja, kad:

- 1) šis katalogas nėra civilinės teisės supratimu pasiūlymas;
- 2) rodomos šame kataloge prekės gali tikrumoje skirtis nuo parodyto nuotraukose pavyzdžio, ypač jų išorine išvaizda ir požymiais, t.y. dydžiu, spalva, įpakavimo būdu, elementų kiekiu pakuotėje;
- 3) gamintojas neneša atsakomybės už nereikšmingus skirtumus įpakavime arba gaminiu savybėse, kurios neturi įtakos jo paskirčiai arba jo varojimo būdui.
- 4) neneša taip pat atsakomybės dėl bet kokių netikslumų arba nepakankamai preciziškų apibrėžimų pateiktoje kataloge informacijoje.
- 5) neneša atsakomybės už galimai patirtus nuostolius gavus prekę su savybėmis, kurios nėra tapačios su pateiktomis nuotraukose.

II. Nežiūrint geriausių TOYA S.A. pastangų, bendrovė negali garantuoti, kad pateikta šiame kataloge informacija pilnai atitinka tikrovę.

III. Bet kokie sprendimai priimami šiame kataloge pateiktą informaciją pagrindu yra besinaudojančio šia informacija asmens priimami savo paties rizika.

LV

I. A/S „TOYA” informē, ka:

- 1) šis katalogs nav piedāvājums civillikuma izpratnē;
- 2) piedāvāti šī katalogā produkti realitātē var atšķirties no rādīta uz fotogrāfijas parauga, sevišķi ārēju īpašību sfērā, t.i. ar lielumu, krāsu, pakošanas veidu, priekšmetu skaitu iepakojumā;
- 3) nav atbildīga par smalkām atšķirībām iepakošanas veidā vai produktu īpašībām, ja tie neietekmē ierīces paredzētu mērķu vai lietošanas veidu;
- 4) nav atbildīga par kaut kādām neprecizitātēm informācijās, kas ir norādītas šī katalogā;
- 5) nav atbildīga par iespējamam zaudējumiem, savienotiem ar produkta saņemšanu ar citām īpašībām, nekā rādītas uz fotogrāfijas.

II. Neskatoties uz visaugstāko rūpību, ar kuru A/S „TOYA” sagatavoja savu katalogu, tā nevar garantēt, ka informācijas šī katalogā pilnīgi atbild realitātei.

III. Visi lēmumi, pieņemti pamatojoties uz informācijas no kataloga - ir pieņemti uz personas, kura lieto šo informāciju, risku.

CZ

I. TOYA S.A. informuje že:

- 1) tento katalog nepředstavuje nabídku ve smyslu občanského práva;
- 2) výrobky prezentované v tomto katalogu se mohou ve skutečnosti lišit od modelů uvedených na obrázcích, zejména co se týká vnějších znaků, tj. velikosti, barvy, způsobu balení, počtu předmětů v balení;
- 3) nenesé odpovědnost za drobné rozdíly ve způsobu balení nebo ve vlastnostech výrobků, které nemají zásadní vliv na jejich určený účel nebo způsob používání;
- 4) nenesé odpovědnost vyplývající z jakýchkoli nepřesností co do informací uvedených v předmětném katalogu;
- 5) nenesé odpovědnost za případné škody vzniklé v důsledku obdržení zboží s jinými vlastnostmi, než je uvedeno na obrázcích.

II. Navzdory mimořádnému úsilí vynaloženému firmou TOYA S.A. tato nemůže garantovat, zda informace uvedené v tomto katalogu zcela odpovídají skutečnosti.

III. Veškerá rozhodnutí přijatá na základě informací uvedených v předmětném katalogu jsou přijímána na vlastní riziko osoby, která tyto informace využívá.

SK

I. TOYA S.A. informuje že:

- 1) tento katalóg nepredstavuje ponuku v zmysle občianskeho práva;

- 2) výrobky prezentované v tomto katalógu sa v skutočnosti môžu líšiť od modelov zobrazených na obrázkoch, najmä pokiaľ sa jedná o vonkajšie znaky, t.j. veľkosť, farbu, spôsob balenia, počet predmetov v balení;
- 3) nenesie zodpovednosť za drobné rozdiely v spôsobe balenia či vlastnostiach výrobkov, ktoré nemajú zásadný vplyv na ich určený účel alebo spôsob používania;
- 4) nenesie zodpovednosť vyplývajúcu z akejkoľvek nepresnosti týkajúcej sa informácií uvedených v predmetnom katalógu;
- 5) nenesie zodpovednosť za prípadné škody vzniknuté v dôsledku obdržania tovaru s inými vlastnosťami, než je uvedené na obrázkoch.

II. Aj napriek mimoriadnemu úsilíu zo strany firmy TOYA S.A. táto nemôže garantovať, či informácie uvedené v tomto katalógu plne zodpovedajú skutočnosti.

III. Všetky rozhodnutia prijaté na základe informácií uvedených v predmetnom katalógu sú prijímané na vlastné riziko osoby, ktorá tieto informácie využíva.

H

I. A TOYA S.A. tájékoztatja, hogy:

- 1) a jelen katalógus a polgári jog szerinti nem kereskedelmi ajánlat;
 - 2) a jelen katalógusban bemutatott árucikkek a valóságban eltérhetnek a képeken látható mintától, különösen a külső tulajdonságok, mint a méret, szín, csomagolási mód, a csomagban lévő tárgyak száma tekintetében;
 - 3) nem vállal felelősséget a csomagolás módjában vagy az árucikkek olyan tulajdonságaiban történt változtatásokért, amelyek nem befolyásolják lényeges módon annak rendeltetését vagy a felhasználás módját;
 - 4) nem vállal felelősséget a jelen katalógusban lévő információk pontatlanságáért;
 - 5) nem vállal felelősséget azokért az esetleges károkért, amik az árucikkek a fényképeken látható tulajdonságoktól eltérő tulajdonságokkal történő leszállításából erednek.
- II. A TOYA S.A. minden igyekezete ellenére nem tudja garantálni, hogy a jelen katalógusban

található információk teljes egészében megfelelnek a valóságnak.

III. A tárgyi katalógusban található információk alapján meghozott bármilyen döntés annak a személynek a rizikója, aki ezeket az információkat felhasználja.

RO

I. TOYA S.A. informează că:

- 1) prezentul catalog nu constituie ofertă în înțelesul dreptului civil;
- 2) articolele prezentate în prezentul catalog se pot diferi față de mostrele din fotografiile, în special aspectul exterior, adică mărimea, culoarea, modul de ambalare, cantitatea obiectelor în ambalaj;
- 3) nu-și asumă răspunderea referitor la mici diferențe la modul de ambalare sau la articole al căror proprietăți nu au influență referitor la destinația sau modul lor de utilizare;
- 4) nu-și asumă răspunderea referitor la orice inexactitate sau imprecizie, datorită informațiilor cuprinse în catalogul respectiv;
- 5) nu-și asumă răspunderea referitor la o eventuală pagubă ca urmare primirii marfei cu alte proprietăți decât cele prezentate pe fotografii;

II. Cu toate strădanile TOYA S.A., firma nu poate garanta că, informațiile din prezentul catalog corespund realității;

III. Orice decizie preluată în baza informațiilor cuprinse în catalogul respectiv, sunt preluate pe riscul și răspunderea persoanei care a făcut folos de aceste informații.

E

I. TOYA S.A. comunica lo siguiente:

- 1) el presente catálogo no constituye una oferta, en el sentido que la noción adquiere en la ley civil;
- 2) los artículos presentados en el presente catálogo pueden en realidad diferir de los modelos indicados en las fotografías, especialmente en cuanto a sus propiedades externas, es decir el tamaño, el color, el empaque o la cantidad de los objetos en el empaque;
- 3) la empresa no se hace responsable por pequeñas diferencias en cuanto al empaque o las propiedades de los artículos, siempre y cuando estas diferencias no afectan el propósito o el modo de operación de las herramientas;
- 4) la empresa no se hace responsable por ninguna imprecisión en cuanto a la información presentada en el presente catálogo;
- 5) la empresa no se hace responsable por ningún daño que surja del hecho de que los artículos recibidos difieran de los artículos presentados en las fotografías en cuanto a sus propiedades.

II. A pesar de los mejores intentos de parte TOYA S.A. la empresa no puede garantizar que la información presentada en el presente catálogo corresponda completamente a la realidad.

III. Todas las decisiones tomadas en base a la información presentada en el presente son responsabilidad de la persona que recurra a la dicha información.

Memo



REG-707
Branded rack YATO 100 cm /
Regał firmowy YATO 100 cm



REG-777
Hangers set for power tools YATO /
Zestaw zawieszni na elektronarzędzia YATO



Hangers set for power tools YATO 18 V /
Zestaw zawieszni na elektronarzędzia YATO 18 V



REG-918
Display for sanding paper YATO in rolls /
Ekspozytor na papier ścierny YATO w rolkach



REG-919
Display for sanding paper YATO in sheets /
Ekspozytor na papier ścierny YATO w arkuszach



REG-908
Standing display for YATO rectifiers /
Ekspozytor stojący na prostowniki YATO



REG-925
Display for YATO work clothes /
Ekspozytor na ubrania robocze YATO



REG-603
Rotary display rack YATO /
Ekspozytor obrotowy YATO



Standing triangular display
for YATO sets /
Trójstronny ekspozytor stojący
na zestawy YATO



REG-763
Standing display for YATO shoes /
Ekspozytor stojący na buty YATO



REG-977
Chrome tube mannequin /
Manekin z rury chromowej



REG-764
Standing display
for YATO levels /
Ekspozytor stojący
na poziomice YATO



REG-708
Branded rack VOREL 100 cm /
Regał firmowy VOREL 100 cm



Standing display for window seals VOREL /
Ekspozytor stojący na uszczelki do okien VOREL



REG-954
Display for ropes /
Ekspozytor na liny



REG-706
Branded rack STHOR 100 cm /
Regał firmowy STHOR 100 cm



REG-709
Branded rack FLO 100 cm /
Regał firmowy FLO 100 cm



REG-715
Mesh display rack FLO 230 cm /
Regał siatkowy FLO 230 cm



REG-147
Kitchen faucet display rack FALA /
Ekspozytor na baterie kuchenne FALA



REG-146
Bath faucet display rack FALA /
Ekspozytor na baterie łazienkowe FALA



REG-149
Stand for linear drains FALA /
Ekspozytor na odpływy liniowe FALA



REG-808
Display for wave toilet seats FALA /
Ekspozytor na deski toaletowe FALA



REG-992
Display rack for REG-707 for pipe wrenches YATO /
Ekspozytor do REG-707 na klucze do rur YATO



REG-994
Display rack for REG-707 for YATO bits /
Ekspozytor do REG-707 na nasadki YATO



REG-994P
Display rack with the lid for REG-707 for YATO bits /
Ekspozytor z pokrywą do REG-707 na nasadki YATO



REG-998
Display rack for REG-707 for YATO hammers /
Ekspozytor do REG-707 na młotki YATO



REG-993
Display rack for REG-707 for YATO pneumatic tools /
Ekspozytor do REG-707 na narzędzia pneumatyczne YATO



REG-951
Display for carpentry clamps /
Ekspozytor na ściski stolarskie



REG-804
Tag for YATO shoes / Zawieszka na buty YATO



REG-991
Display rack for REG-707 for YATO disc saws /
Ekspozytor do REG-707 na piły tarczowe YATO



REG-952
Display for the disc for disc cutters /
Ekspozytor na tarcze do szlifierek kątowych



REG-761
Hook for axes / Wieszak na siekiery



REG-930
Display for YATO buck saws /
Ekspozytor na piły kabłąkowe YATO



REG-909
Display stand for FLO garden tools /
Ekspozytor na narzędzia ogrodowe FLO



REG-868
Hook 30 cm for trowels / Hak 30 cm na kielnie



REG-144
Pendant for wall mounted faucet FALA /
Zawieszka na baterię ścienną FALA



REG-145
Pendant for deck mounted faucet FALA /
Zawieszka na baterię stojącą FALA



REG-911
Pallet display for garden tools /
Ekspozytor paletowy na narzędzia ogrodnicze



REG-799
Display stand VOREL /
Display ekspozycyjny VOREL



REG-902
Standing display for YATO sockets /
Ekspozytor stojący na nasadki YATO



REG-807
Display box for STHOR drill bits /
Ekspozytor skrzynka na wiertła STHOR



REG-604
Wall-stand display rack YATO /
Ekspozytor stojąco-wiszący YATO



REG-605
Waterfall display rack YATO /
Ekspozytor kaskadowy YATO









































REG-705
Advertising wobler YATO /
Wobler reklamowy YATO



REG-803
YATO wrench tester /
Tester kluczy YATO



REG-711
Rack shelf for REG-707 YATO /
Półka do REG-707 YATO

	Colour box		Sleeve
	Box with colour label		White sleeve with label
	PVC colour box		Carton envelope
	Box		Bulk
	Display colour box		Plastic holder
	Hanging colour box		Flag tied on card
	Blister card		Metal box
	Double blister card		Metal box with colour label
	Double blister transparent		Metal box with sleeve
	Half double blister card		Plastic box
	Sliding card		Plastic box with colour sleeve
	Plastic hanger		Plastic case with colour label
	Hanging card		Plastic case with label
	Header card		Plastic case with colour sleeve
	Tied on card		Plastic tube with colour label
	Skin card		Metal clip
	Polybag with header card		Wooden box with sleeve
	Polybag		Pouch
	Printed polybag		Shrink card / Plastic tray
	Polybag with hanger		Nylon case

LED RECHARGEABLE FLOODLIGHTS AKUMULATOROWE REFLEKTORY LED



82870
10 W
1000 lm



82871
20 W
2000 lm



82881
10 W
1000 lm



82882
20 W
2000 lm

STHOR floodlights are a reliable source of light. They perform excellently in all conditions, whether for professional tasks or everyday use. Offering efficient lighting of up to 2000 lm, they also ensure user comfort with numerous additional features,

such as a power bank, built-in magnets, and hooks.

In the workshop, on construction sites, or outdoors, the durable and waterproof STHOR floodlights are ready to tackle any challenge.

Reflektory marki STHOR to niezawodne źródła światła. Doskonale sprawdzą się w każdych warunkach, zarówno przy profesjonalnych zadaniach, jak i na co dzień. Zapewniają nie tylko wydajne oświetlenie o mocy do 2000 lm,

ale też komfort użytkowania dzięki wielu dodatkowym funkcjom, takim jak power bank, magnesy w obudowie i haczyki.

W warsztacie, na budowie i w plenerze - trwałe i wodoodporne reflektory STHOR sprostają każdemu wyzwaniu.





MANUFACTURER / PRODUCENT

TOYA S.A.
ul. Sołtysowicka 13-15
51-168 Wrocław
☎ (+48 71) 32 46 200
fax: (+48 71) 32 46 370
sales@yato.pl (sale)
export@yato.pl (export)
import@yato.pl (import)

ODDZIAŁ WARSZAWSKI
Teren Mapletree Park Nadarzyn
al. Kasztanowa 160
05-831 Młochów k. Warszawy
☎ (+48 22) 73 82 800
☎ (+48 22) 73 82 828
sales@yato.pl (sale)
export@yato.pl (export)

TOYA ROMANIA S.A.
Șos. Stefănești, 8-8A
Stefăneștii De Jos, Ilfov
☎ (+40 031) 710 8692
office@yato.ro

YATO TOOLS (SHANGHAI) CO., LTD.
No. 1, Lane 1300, East Kangqiao Road
Shanghai, China 201315
☎ (+86 21) 681 829 50
fax: (+86 21) 681 829 51
yato@yato-sh.com

YATO TOOLS (JIAXING) CO., LTD.
No. 1033 Huyuan Road, Baibu Town
Haiyan County, Jiaxing City, Zhejiang Province, China
☎ (+86 21) 681 829 50
yato@yato-sh.com

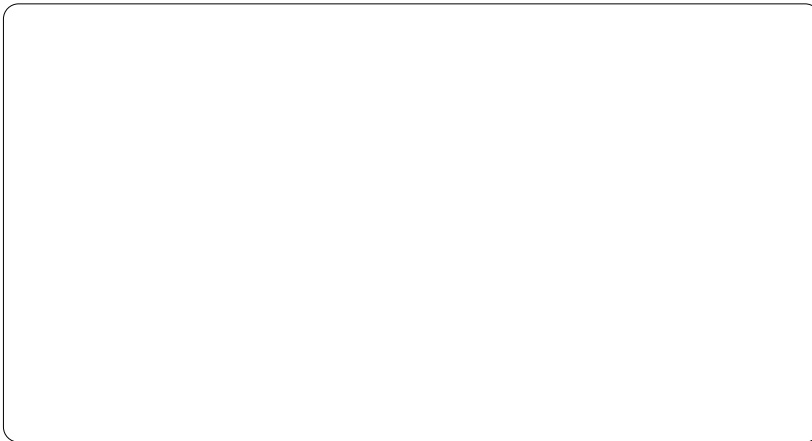

YOUR TRUSTED SUPPLIER / TWÓJ ZAUFANY DOSTAWCA



GET ACQUAINTED WITH OUR WIDE OFFER /
ZOBACZ NASZĄ BOGATĄ OFERTĘ

Copyright © TOYA S.A.

