

YATO  [®]

AUTOMOTIVE TOOLS
NARZĘDZIA
MOTORYZACYJNE



www.yato.com

YT-09514

One of the smallest
pneumatic wrenches on the market!

Jeden z najmniejszych
kluczy pneumatycznych na rynku!

- High power: 470 Nm
- Air consumption: 380 l/min
- Adjustment of tightening torque
- Length: 115 mm
- Weight: 1.6 kg
- Duża moc: 470 Nm
- Zużycie powietrza: 380 l/min
- Regulacja momentu obrotowego
- Długość: 115 mm
- Waga: 1,6 kg

NEW!



SEE ALSO THE OTHER IMPACT WRENCHES FROM YATO:
POZNAJ TAKŻE INNE KLUCZE UDAROWE YATO:



NEW!

YT-09531

Pneumatic impact wrench
Udarowy klucz pneumatyczny

High power in the 1/2" class
of wrenches – 850 Nm

O dużej mocy w klasie
kluczy 1/2" – 850 Nm



NEW!

YT-09506

Pneumatic impact wrench
Udarowy klucz pneumatyczny

Very effective, thanks to the Twin Hammer
mechanism and the power of 600 Nm

Bardzo skuteczny dzięki mechanizmowi
Twin Hammer i mocy 600 Nm



YT-82020

Electric impact wrench
Elektryczny klucz udarowy

High power and compact
with durable impact mechanism

Mocny i kompaktowy klucz
z wytrzymałym mechanizmem udarowym



Cabinets Szafki serwisowe 2-15 	Automotive pliers Szczypce motoryzacyjne 78-84 
Tool boxes Skrzynki narzędziowe 15-18 	Engine handling tools Narzędzia do obsługi silnika 84-106 
Impact sockets Udarowe klucze nasadowe 19-24 	Brake system tools Narzędzia do układu hamulcowego 106-113 
Pneumatic tools Narzędzia pneumatyczne 25-45 	Suspension spring tools Narzędzia do sprężyn zawieszenia 113-114 
Special wrenches Klucze specjalne 46 	Wheel tools Narzędzia do kół 115-117 
Tool sets Zestawy narzędziowe 47 	Inspection tools Narzędzia inspekcyjne 118 
Dynamometric tools and torque amplifiers Narzędzia dynamometryczne i wzmacniacze momentu 48-51 	Accessories Akcesoria 119-125 
Welding & tinner's tools Narzędzia spawalniczo-blaharskie 51-55 	Power tools Elektronarzędzia 126-128 
Tools for oil filters Narzędzia do filtrów oleju 56-59 	Lighting and electricity Oświetlenie i elektryka 128-134 
Lubrication tools Narzędzia do smarowania 59-62 	Rectifiers, cables, testers Prostowniki, kable, testery 135-138 
Oil and fuel pumps Pompy do oleju i paliwa 63 	Hoists Wciągarki 138-139 
Automotive pullers Ściągacze motoryzacyjne 64-66 	Cranes, presses, girders Żurawie, prasy, belki 140-141 
Special pullers Ściągacze specjalne 66-72 	Car lifts Podnośniki samochodowe 142-144 
Reamers and extractors Rozwiertaki i wykrętaki 72-73 	Standardized parts Normalia 145-155 
Disassembly tools Narzędzia do demontażu 74-78 	Measurement tools Narzędzia pomiarowe 155-159 

CREATE YOUR WORKPLACE - STWÓRZ SWOJE MIEJSCE PRACY



YT-08931
High workshop cabinet
Szafka warsztatowa wysoka

YT-08935
Wall cabinet
Szafka podwieszana

YT-08936
Hook panel
Panel perforowany

YT-08938
YT-08939
Worktop
Blat roboczy

YT-08934
Workshop cabinet
Szafka warsztatowa

YT-08933
Workshop cabinet
Szafka warsztatowa

- GB** High workshop cabinet
- D** Hoher Werkstattschrank
- PL** Szafka warsztatowa wysoka
- RUS** Шкаф для мастерской - высокий
- CZ** Skříňka pro ukládání nástrojů
- H** Szekrény szerszámok tárolására
- RO** Dulap depozitare

- F** Armoire de rangement
- I** Armadio da officina alto
- E** Gabinete de almacenamiento
- CN** 高柜

660x457
x2000mm

3x
SHELF
PÓŁKA

ADJUSTABLE
FEET
REGULOWANE
STOPY

2x
KEY



GREY
CARTON BOX
& COLOR LABEL

YATO  
YT-08931 1

- GB** Working cabinet
- D** Werkzeugkasten
- PL** Szafka warsztatowa
- RUS** Портативный ящик для инструментов
- CZ** Přenosná skříňka na nářadí
- H** Hordozható szerszámok láda
- RO** Dulap pt. scule
- F** Servante d'atelier
- I** Banco da lavoro armadio
- E** Cajonera portátil
- CN** 驮檢箱

660x457
x863mm

4x
SHELF
PÓŁKA

ADJUSTABLE
FEET
REGULOWANE
STOPY

BALL BEARING
ŁOŻYSKA KULKOWE

2x
KEY



GREY
CARTON BOX
& COLOR LABEL

YATO  drawers / szuflady 
YT-08933 4 1

- GB** Working cabinet
- D** Werkzeugkasten
- PL** Szafka warsztatowa
- RUS** Портативный ящик для инструментов
- CZ** Přenosná skříňka na nářadí
- H** Hordozható szerszámok láda
- RO** Dulap pt. scule
- F** Servante d'atelier
- I** Banco da lavoro armadio
- E** Cajonera portátil
- CN** 驮檢箱

660x457
x863mm

SHELF
PÓŁKA

ADJUSTABLE
FEET
REGULOWANE
STOPY

2x
KEY



GREY
CARTON BOX
& COLOR LABEL

YATO  
YT-08934 1

- GB** Wall cabinet
D Hängeschrank
PL Szafka podwieszana
RUS Настенный инструментальный шкаф
CZ Nástěnná skříň
H Fali szekrény
RO Dulap de perete
F Armoire murale
I Armadio sospeso
E Gabinete de pared
CN 小墙柜

660x305
x410mm



GREY
CARTON BOX
& COLOR LABEL

YATO
YT-08935 1

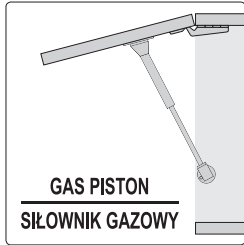

GAS PISTON

SIŁOWNIK GAZOWY

- GB** Shelf
D Regal
PL Półka
RUS Полка
CZ Polica
H Polc
RO Raft
F Étagère
I Scaffale
E Estante
CN 层板

656x426
x22mm



for / dla: YT-08931, YT-08934

POLYBAG

YATO
YT-08932 5

- GB** Worktop
D Werkstatt Tischplatte
PL Blat roboczy
RUS Столешница
для мастерской
CZ Pracovní deska
H Munkalap
RO Blat de lucru
F Plan de travail
I Piano di lavoro
E Encimera
CN 木质工作台面

1320x457
x 22mm

RUBBERWOOD
WORKTOP
BLAT Z DREWNA
KAUCZUKOWEGO

FOR 2
MODULES
DO 2
MODUŁÓW

GREY
CARTON BOX
& COLOR LABEL

YATO
YT-08938 1



- GB** Worktop
D Werkstatt Tischplatte
PL Blat roboczy
RUS Столешница
для мастерской
CZ Pracovní deska
H Munkalap
RO Blat de lucru
F Plan de travail
I Piano di lavoro
E Encimera
CN 木质工作台面

1980x457
x22mm

RUBBERWOOD
WORKTOP
BLAT Z DREWNA
KAUCZUKOWEGO

FOR 3
MODULES
DO 3
MODUŁÓW

GREY
CARTON BOX
& COLOR LABEL

YATO
YT-08939 1



- GB** Strengthening element
D Verstärkungselement
PL Wzmocnienie blatu
RUS Укрепление столешницы
CZ Podpůrný prvek
H Asztali támogatás
RO Tabla
F Support de table
I Rinforzo del piano di lavoro
E Soporte
de mesa
CN 工作台挂板

660x457
x 54mm



POLYBAG

YATO
YT-08940 5

for / dla: YT-08939

- GB** Hook panel
D Perforierte Wand
PL Panel perforowany
RUS Стенка с перфорацией
CZ Děrovaná stěna
H Perforált fal
RO Perete perforat
F Mur perforé
I Pannello forato
E Pared perforada
CN 网孔板

660x700
x20mm

5x
HOOK
HACZYK

10x10mm
MESH SIZE
ROZMIAR
PERFORACJI

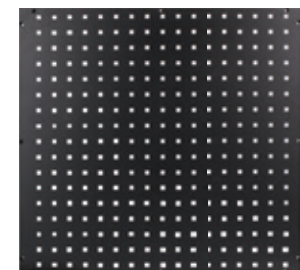

GREY
CARTON BOX
& COLOR LABEL

YATO
YT-08936 1

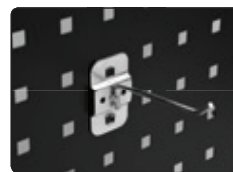

- GB** Hook panel support
D Verstärkungselement
Perforierte Wand
PL Stelaż do paneli
perforowanych
RUS Каркас для стенки
с перфорацией
CZ Podpůrný prvek
děrovaná stěna
H Asztali támogatás
perforált fal
RO Cadru de metal
F Panneaux muraux
perforés pour
le soutien
I Telaio per pannelli forati
E Paneles de pared
perforados de soporte
CN 工具柜



for / dla: YT-08936 x 3

GREY
CARTON BOX
& COLOR LABEL

YATO
YT-08941 1

- GB** Hook panel support
D Verstärkungselement
Perforierte Wand
PL Stelaż do paneli
perforowanych
RUS Каркас для стенки
с перфорацией
CZ Podpůrný prvek
děrovaná stěna
H Asztali támogatás
perforált fal
RO Cadru de metal
F Panneaux muraux
perforés pour
le soutien
I Telaio per pannelli forati
E Paneles de pared
perforados de soporte
CN 工具柜

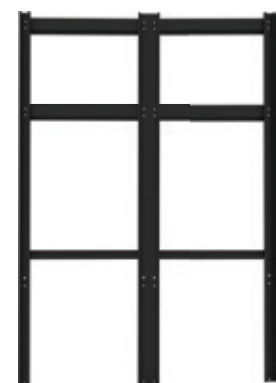

for / dla: YT-08936 x 2

GREY
CARTON BOX
& COLOR LABEL

YATO
YT-08942 1

GB Service tool cabinet with tools
D Serviceschrank mit Werkzeugen
PL Szafka serwisowa z narzędziami
RUS Сервисный шкаф с инструментами
CZ Servisní skříňka s nářadím
H Szervizszekrény szerszámmal

RO Dulap echipat cu scule
F Servante d'atelier - set d'outils
I Armadio per utensili
E Armario para herramientas de servicio
CN 工具车托盘组套

GREY
 CARTON BOX
 & COLOR LABEL



162 PCS 3 TRAY WKŁAD	905x680 x455 mm	3x	BALL BEARING ŁOŻYSKA KULKOWE	25kg
DRAWERS LOCKING BŁOKADA SZUFLAD	CENTRAL LOCK CENTRALNY ZAMEK	WHEELS 125 mm	2x BRAKE HAMULCE	NON SLIP BAMBOO WORKTOP ANTIPOŚLĘGOWY BAMBUSOWY BLAT
310x200 mm FOLDING SHELF ROZKŁADANA POLKA	UNIVERSAL PERFORATION UNIWERSALNA PERFORACJA	2x1		



DRAWER / SZUFLADA 1



- 8, 9, 10, 11, 12, 13, 14, 15, 16, 17, 18, 19, 21 mm; CrV;
- 8x10, 11x12, 13x14, 15x17 mm; CrV 6140;
- 1/2" (12.7 mm) (F) x 3/8" (9.5 mm) (M); CrV 50BV30;
- 3/8" (9.5 mm); 63-120 mm; CrV;
- 200 mm; 140 mm;
- 190-770 mm; 100 mm;
- 6-24 V; 1.5 V; 9 LED

DRAWER / SZUFLADA 2



- 1/2" (12.7 mm): 20, 22, 24 mm (L=38 mm); 27, 30, 32 mm (L=42 mm); 3/8" (9.5 mm): 9, 10, 11, 12, 13, 14, 15, 16 mm (L=28 mm); 17, 18, 19 mm (L=30 mm); 1/4" (6.3 mm): 4, 5, 6, 7, 8, 9, 10, 11, 12, 13 mm (L=25 mm); CrV 50BV30; 1/4" (6.3 mm): 8, 10, 11, 12 (L=50 mm); CrV 50BV30; 1/2" (12.7 mm): 10, 12, 13, 14, 17, 19 mm (L=78 mm); 12 pt. CrV 50BV30; 1/2" (12.7 mm): 17, 19, 21 mm (L=39 mm); CrMo SCM-440; 3/8" (9.5 mm): E10, E12, E14, E16, E18 (L=28 mm); 1/4" (6.3 mm): E4, E5, E6, E7, E8 (25 mm); CrV 6150; 1/2" (12.7 mm): (127, 254 mm); 3/8" (9.5 mm): (76, 152.4 mm); 1/4" (6.3 mm): (50.8 mm); CrV 50BV30; 3/8" (9.5 mm) (F) x 1/2" (12.7 mm) (M); CrV 50BV30; 1/2" (12.7 mm); 3/8" (9.5 mm); 1/4" (6.3 mm); CrV 50BV30; 3/8" (9.5 mm): 16, 21 mm; CrV 50BV30; 3/8" (9.5 mm): 14 mm; 12 pt. CrV; 1/2" (12.7 mm); (255 mm); 3/8" (9.5 mm); (200 mm); 1/4" (6.3 mm); (155 mm); 72T; CrV 6140; 1/4" (6.3 mm); (150 mm); CrV 50BV30; 3/8" (9.5 mm) x 5/16" (7.9 mm); CrV 6140; 1/4" (6.3 mm) x 1/4" (6.3 mm); CrV 6140; 5/16" (7.9 mm): 5.5, 6.5 mm (L=70 mm); 1/4" (6.3 mm): 4, 5, 6 mm (L=25 mm); AISI S2; 5/16" (7.9 mm): PH1 x2, PH2 x2, PH3 (L=70 mm); 1/4" (6.3 mm): PH1x2, PH2x2, PH3 (L=25 mm); AISI S2; 1/4" (6.3 mm): T10, T15, T20, T25, T27, T30, T40 (L=70 mm); AISI S2; 5/16" (7.9 mm): T20, T30, T40, T45, T50, T55, T60 (L=70 mm); AISI S2; 5/16" (7.9 mm): 4, 5, 6, 7, 8 mm (L=70 mm); 1/4" (6.3 mm): 3, 4, 5, 6, 7 mm (L=25 mm); AISI S2; 5/16" (7.9 mm): M5, M6, M8, M10, M12 (L=70 mm); AISI S2

DRAWER / SZUFLADA 3



- 6x38, 3x75 mm; S2; PH0x75, PH2x38 mm; S2;
- 6x100 mm; CrV 6150; PH2x100 mm; CrV 6150;
- 180 mm; CrV 50; 160 mm; CrV 50; 150 mm;
- 160 mm LONG NOSE; CrV 6150;
- 180 mm; CrV 50; EXTERNAL STRAIGHT / PROSTE ZEWNĘTRZNE;
- 180 mm; CrV 50; INTERNAL STRAIGHT / PROSTE WEWNĘTRZNE;
- 180 mm; CrV 50; EXTERNAL BENT / WYGIĘTE ZEWNĘTRZNE;
- 180 mm; CrV 50; INTERNAL BENT / WYGIĘTE WEWNĘTRZNE;
- 180; CrMo;
- 1.5, 2, 2.5, 3, 4, 5, 6, 8, 10 mm; CrV 6150

YATO	drawers / szuflady	
YT-55280	3	1

GB Service tool cabinet with tools
D Serviceschrank mit Werkzeugen
PL Szafka serwisowa z narzędziami
RUS Сервисный шкаф с инструментами
CZ Servisní skříňka s nářadím
H Szervizszekrény szerszámmal

RO Dulap echipat cu scule
F Servante d'atelier - set d'outils
I Armadio per utensili
E Armario para herramientas de servicio
CN 工具车托盘组套

WHITE
CARTON BOX
& COLOR LABEL



165 PCS
13 TRAY
WKŁAD

958x766
x465 mm

7x

BALL BEARING
ŁOŻYSKA
KULKOWE

25kg
35kg
35kg

DRAWERS
LOCKING
BŁOKADA
SZUFLAD

CENTRAL
LOCK
CENTRALNY
ZAMEK

NON SLIP
WORKTOP
BLAT
ANTIPOŚLIZGOWY

WHEEL Ø
125 mm

BRAKE
HAMULEC

3x

UNIVERSAL
PERFORATION
UNIERSALNA
PERFORACJA

DOUBLE
WALLS
PODWÓJNE
SCIANY

CORNER BUMPERS
NARÓŻNE ODBOJNIKI



13 interchangeable trays with YATO tools
13 wymiennych modułów z narzędziami YATO

DRAWER / SZUFLADA 1

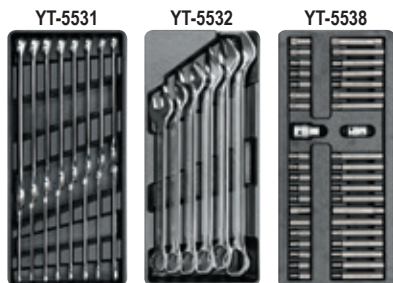

DRAWER / SZUFLADA 2

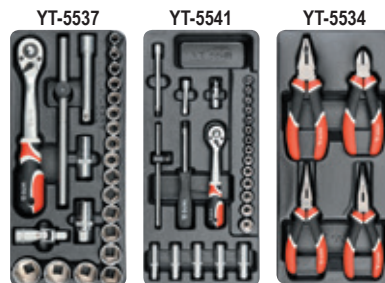

DRAWER / SZUFLADA 3

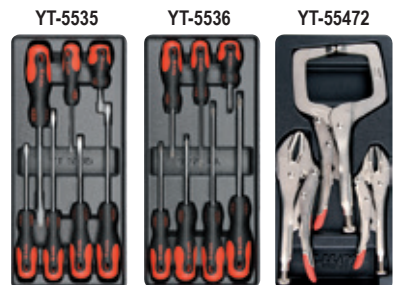

DRAWER / SZUFLADA 4



DRAWER / SZUFLADA 5



DRAWER / SZUFLADA 1

○ □ □ H4, H5, H6, H7, H8, H10, H12 (L=30 mm); H4, H5, H6, H7, H8, H10, H12 (L=75 mm); AISI S2; ○ □ □ M5, M6, M8, M10, M12 (L=30 mm); M5, M6, M8, M10, M12 (L=75 mm); AISI S2; ○ □ □ T20, T25, T30, T40, T45, T50, T55 (L=30 mm); T20, T25, T30, T40, T45, T50, T55 (L=75 mm); AISI S2; □ □ □ 1/2" (12.7 mm), 3/8" (9.5 mm); ○ □ □ 6, 7, 8, 9, 10, 11, 12, 13, 14, 15, 16, 17, 18, 19, 20, 21 mm; CrV; ○ □ □ 22, 24, 27, 28, 30, 32 mm; CrV

DRAWER / SZUFLADA 2

□ □ □ 1/2" (12.7 mm); 10, 11, 12, 13, 14, 15, 16, 17, 18, 19, 20, 21, 22, 23, 24, 27, 30, 32 mm; CrV 50BV30; ○ □ □ 1/2" (12.7 mm); (255 mm); 72T; CrV 6140; ○ □ □ 1/2" (12.7 mm); (255 mm); CrV 50BV30; ○ □ □ 1/2" (12.7 mm); 16; 21 mm; CrV 50BV30; ○ □ □ 1/2" (12.7 mm); (127 mm); CrV 50BV30; ○ □ □ 1/2" (12.7 mm); CrV 50BV30; ○ □ □ 1/4" (6.3 mm); 3.5, 4.0, 4.5, 5.0, 5.5, 6.0, 7.0, 8.0, 9.0, 10.0, 11.0, 12.0, 13.0, 14.0 mm; CrV 50BV30; ○ □ □ 1/4" (6.3 mm); 8, 10, 11, 12, 13 mm; CrV 50BV30; ○ □ □ 1/4" (6.3 mm); (50.8, 101.6 mm); CrV 6140; ○ □ □ 1/4" (6.3 mm); CrV 50BV30; ○ □ □ 1/4" (6.3 mm); (155 mm); 72T; CrV 6140; ○ □ □ 1/4" (6.3 mm); (150 mm); CrV 50BV30; ○ □ □ 180 mm; 160 mm; 160 mm LONG NOSE; ○ □ □ 160 mm BENT NOSE

DRAWER / SZUFLADA 3

○ □ □ 3x75, 5x100, 5x150, 6x38, 6x100, 6x150, 8x150 mm; CrMo; ○ □ □ PH0x100, PH1x75, PH1x100, PH2x38, PH2x100, PH2x150, PH3x150 mm; CrMo; ○ □ □ 180, 250 mm; ○ □ □ 280 mm

DRAWER / SZUFLADA 4

□ □ □ 3/4" (19.0 mm); 21, 22, 24, 27, 28, 29, 30, 32, 34, 36, 41, 46, 50, 55 mm; CrV 50BV30; ○ □ □ 3/4" (19.0 mm); (200 mm); CrV 6140; ○ □ □ 3/4" (19.0 mm); CrV 50BV30; ○ □ □ 3/4" (19.0 mm); (500 mm); 72T; CrV 6140; ○ □ □ 3/4" (19.0 mm); (500 mm); CrV 50BV30

DRAWER / SZUFLADA 5

○ □ □ 1/2" (12.7 mm) x 5/16" (7.9 mm); ○ □ □ PH3 (L=35 mm); PH1, PH2, PH3 (L=75 mm); ○ □ □ 8 mm (L=35 mm); 8 mm (L=75 mm); ○ □ □ 12-38 mm; ○ □ □ 3" (75 mm); ○ □ □ 82 mm; ○ □ □ 200 mm; ○ □ □ 135 mm; ○ □ □ 300, 400, 500 mm

YATO	drawers / szuflady	
YT-55293	7	1

GB Service tool cabinet with tools
D Serviceschrank mit Werkzeugen
PL Szafka serwisowa z narzędziami
RUS Сервисный шкаф с инструментами
CZ Servisní skříňka s nářadím
H Szervizszekrény szerszámmal

RO Dulap echipat cu scule
F Servante d'atelier - set d'outils
I Armadio per utensili
E Armario para herramientas de servicio
CN 工具车托盘组套

WHITE
CARTON BOX
& COLOR LABEL



177 PCS
12 TRAY
WKŁAD

958x766
x465 mm

6x

BALL BEARING
ŁOŻYSKA KULKOWE

25kg
35kg
35kg

DRAWERS LOCKING
BLOKADA SZUFLAD

NON SLIP
POLYPROPYLENE
WORKTOP
ANTYPOŚLIZGOWY
POLIPROPYLENOWY
BLAT

WHEEL Ø
125 mm

BRAKE
HAMULEC

UNIVERSAL PERFORATION
UNIWERSALNA PERFORACJA

DOUBLE WALLS
PODWÓJNE ŚCIANY

2xT

CORNER BUMPERS
NAROŻNE ODBOJNIKI



12 interchangeable trays with YATO tools
12 wymiennych modułów z narzędziami YATO

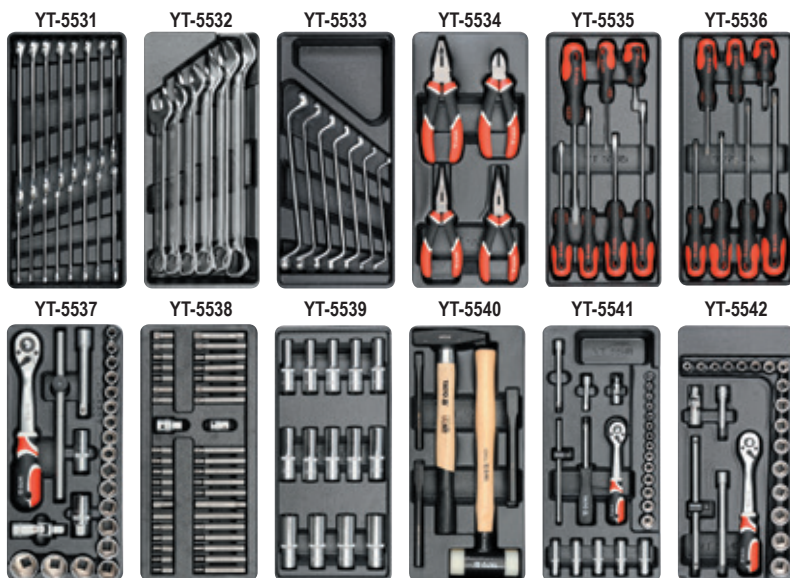

DRAWER / SZUFLADA 1

22, 24, 27, 28, 30, 32 mm; CrV; 6, 7, 8, 9, 10, 11, 12, 13, 14, 15, 16, 17, 18, 19, 20, 21 mm; CrV; 6x7, 8x9, 10x11, 12x13, 14x15, 16x17, 18x19 mm; CrV

DRAWER / SZUFLADA 2

3x75, 5x100, 5x150, 6x38, 6x100, 6x150, 8x150 mm; CrMo; PH0x100, PH1x75, PH1x100, PH2x38, PH2x100, PH2x150, PH3x150 mm; CrMo; 180 mm; 160 mm; 160 mm LONG NOSE; 160 mm BENT NOSE

DRAWER / SZUFLADA 3

1/2" (12.7 mm): 10, 11, 12, 13, 14, 15, 16, 17, 18, 19, 20, 21, 22, 23, 24, 27, 30, 32 mm; CrV 50BV30; 1/2" (12.7 mm); 127 mm; CrV 50BV30; 1/2" (12.7 mm); CrV 50BV30; 1/2" (12.7 mm); (255 mm); 72T; CrV 6140; 1/2" (12.7 mm); (255 mm); CrV 50BV30; 1/2" (12.7 mm); 16; 21 mm; CrV 50BV30; H4, H5, H6, H7, H8, H10, H12 (L=30 mm); H4, H5, H6, H7, H8, H10, H12 (L=75 mm); AISI S2; M5, M6, M8, M10, M12 (L=30 mm); M5, M6, M8, M10, M12 (L=75 mm); AISI S2; T20, T25, T30, T40, T45, T50, T55 (L=30 mm); T20, T25, T30, T40, T45, T50, T55 (L=75 mm); AISI S2; 1/2" (12.7 mm); 3/8" (9.5 mm); 1/2" (12.7 mm); 8, 9, 10, 11, 12, 13, 14, 15, 16, 17, 18, 19, 20, 21 mm (L=76 mm); CrV 50BV30

DRAWER / SZUFLADA 4

300 g (L=300 mm); 40 mm (L=350 mm); 10x8x142 mm; 12x10x152 mm; 16x13x172 mm; 3/8" (9.5 mm): 6, 7, 8, 9, 10, 11, 12, 13, 14, 15, 16, 17, 18, 19, 20, 21, 22 mm; CrV 50BV30; 3/8" (9.5 mm); (76, 152.4 mm); CrV 50BV30; 3/8" (9.5 mm); 3/8" (9.5 mm); (200 mm); 72T; CrV 6140; 3/8" (9.5 mm); (198 mm); CrV 50BV30; 1/4" (6.3 mm): 3.5, 4, 4.5, 5, 5.5, 6, 7, 8, 9, 10, 11, 12, 13, 14 mm; CrV 50BV30; 1/4" (6.3 mm); 8, 10, 11, 12, 13 mm; CrV 50BV30; 1/4" (6.3 mm); (50.8, 101.6 mm); CrV 6140; 1/4" (6.3 mm); CrV 50BV30; 1/4" (6.3 mm); (155 mm); 72T; CrV 6140; 1/4" (6.3 mm); (150 mm); CrV 50BV30; 1/4" (6.3 mm); (152.4 mm); CrV 50BV30

YATO	drawers / szuflady	
YT-5530	6	1

GB Service tool cabinet with tools
D Serviceschrank mit Werkzeugen
PL Szafka serwisowa z narzędziami
RUS Сервисный шкаф с инструментами
CZ Servisní skříňka s nářadím
H Szervizszekrény szerszámmal

RO Dulap echipat cu scule
F Servante d'atelier - set d'outils
I Armadio per utensili
E Armario para herramientas de servicio
CN 工具车托盘组套

WHITE
CARTON BOX
& COLOR LABEL



177 PCS
12 TRAY
WKŁAD

975x765
x465 mm

6x

BALL BEARING
ŁOŻYSKA
KULKOWE

25kg
35kg

DRAWERS
LOCKING
BLOKADA
SZUFLAD

NON SLIP
POLYPROPYLENE
WORKTOP
ANTYPOŚLIZGOWY
POLIPROPYLENOWY
BLAT

WHEEL Ø
125 mm

2x
BRAKE
HAMULCE

UNIVERSAL
PERFORATION
UNIWERSALNA
PERFORACJA

DOUBLE
WALLS
PODWÓJNE
SCIANY

2x

CORNER BUMPERS
NARÓŻNE ODBOJNIKI

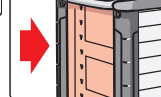

12 interchangeable trays with YATO tools
12 wymiennych modułów z narzędziami YATO

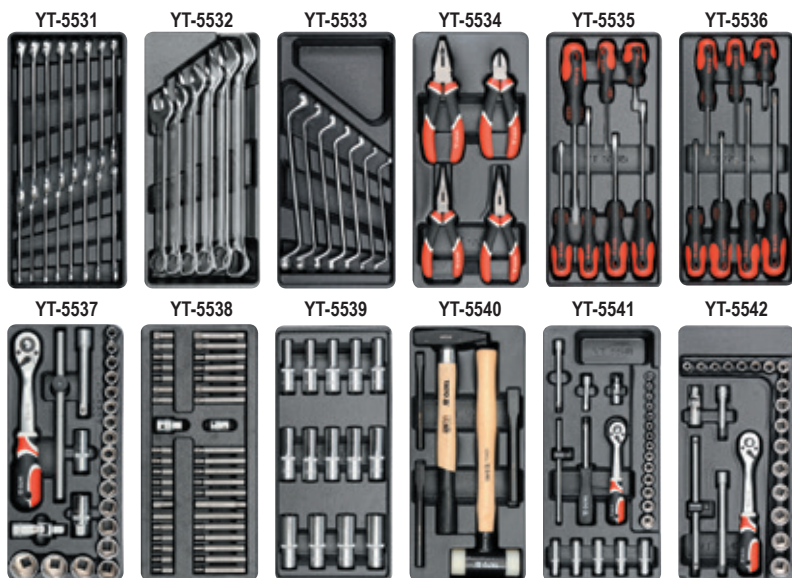

DRAWER / SZUFLADA 1

22, 24, 27, 28, 30, 32 mm; CrV; 6, 7, 8, 9, 10, 11, 12, 13, 14, 15, 16, 17, 18, 19, 20, 21 mm; CrV; 6x7, 8x9, 10x11, 12x13, 14x15, 16x17, 18x19 mm; CrV

DRAWER / SZUFLADA 2

3x75, 5x100, 5x150, 6x38, 6x100, 6x150, 8x150 mm; CrMo; PH0x100, PH1x75, PH1x100, PH2x38, PH2x100, PH2x150, PH3x150 mm; CrMo; 180 mm; 160 mm; 160 mm LONG NOSE; 160 mm BENT NOSE

DRAWER / SZUFLADA 3

1/2" (12.7 mm): 10, 11, 12, 13, 14, 15, 16, 17, 18, 19, 20, 21, 22, 23, 24, 27, 30, 32 mm; CrV 50BV30; 1/2" (12.7 mm): (127 mm); CrV 50BV30; 1/2" (12.7 mm); CrV 50BV30; 1/2" (12.7 mm); (255 mm); 7/2T; CrV 6140; 1/2" (12.7 mm); (255 mm); CrV 50BV30; 1/2" (12.7 mm): 16, 21 mm; CrV 50BV30; H4, H5, H6, H7, H8, H10, H12 (L=30 mm); H4, H5, H6, H7, H8, H10, H12 (L=75 mm); AISI S2; M5, M6, M8, M10, M12 (L=30 mm); M5, M6, M8, M10, M12 (L=75 mm); AISI S2; T20, T25, T30, T40, T45, T50, T55 (L=30 mm); T20, T25, T30, T40, T45, T50, T55 (L=75 mm); AISI S2; 1/2" (12.7 mm), 3/8" (9.5 mm); 1/2" (12.7 mm): 8, 9, 10, 11, 12, 13, 14, 15, 16, 17, 18, 19, 20, 21 mm (L=76 mm); CrV 50BV30

DRAWER / SZUFLADA 4

300 g (L=300 mm); 40 mm (L=350 mm); 10x8x142 mm, 12x10x152 mm, 16x13x172 mm; 3/8" (9.5 mm): 6, 7, 8, 9, 10, 11, 12, 13, 14, 15, 16, 17, 18, 19, 20, 21, 22 mm; CrV 50BV30; 3/8" (9.5 mm): (76, 152.4 mm); CrV 50BV30; 3/8" (9.5 mm); CrV 50BV30; 3/8" (9.5 mm): (200 mm); 7/2T; CrV 6140; 3/8" (9.5 mm): (198 mm); CrV 50BV30; 1/4" (6.3 mm): 3.5, 4, 4.5, 5, 5.5, 6, 7, 8, 9, 10, 11, 12, 13, 14 mm; CrV 50BV30; 1/4" (6.3 mm): 8, 10, 11, 12, 13 mm; CrV 50BV30; 1/4" (6.3 mm): (50.8, 101.6 mm); CrV 6140; 1/4" (6.3 mm); CrV 50BV30; 1/4" (6.3 mm): (155 mm); 7/2T; CrV 6140; 1/4" (6.3 mm): (150 mm); CrV 50BV30; 1/4" (6.3 mm): (152.4 mm); CrV 50BV30

YATO	drawers / szuflady	
YT-55300	6	1

GB Service tool cabinet with tools
D Serviceschrank mit Werkzeugen
PL Szafka serwisowa z narzędziami
RUS Сервисный шкаф с инструментами
CZ Servisní skříňka s nářadím
H Szervizszekrény szerszámmal

RO Dulap echipat cu scule
F Servante d'atelier - set d'outils
I Armadio per utensili
E Armario para herramientas de servicio
CN 工具车托盘组套

WHITE
CARTON BOX
& COLOR LABEL



185 PCS
12 TRAYS
WKLADOW

970x770
x470 mm

6x

BALL BEARING
ŁOŻYSKA KULKOWE

DRAWERS LOCKING
BLOKADA SZUFLAD

NON SLIP
POLYPROPYLENE WORKTOP
ANTYPOŚLIZGOWY
POLIPROPILENOWY
BLAT

UNIVERSAL PERFORMANCE
UNIWERSALNA PERFORACJA

DOUBLE WALLS
PODWÓJNE ŚCIANY

2x1

CORNER BUMPERS
NARÓŻNE ODBOJNIKI



12 interchangeable trays with YATO tools
12 wymiennych modułów z narzędziami YATO

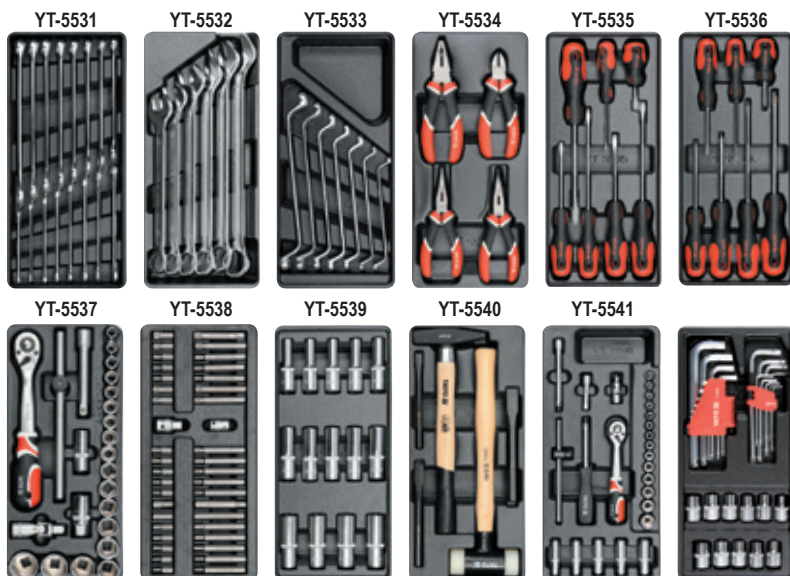

DRAWER / SZUFLADA 1

22, 24, 27, 28, 30, 32 mm; CrV; 6, 7, 8, 9, 10, 11, 12, 13, 14, 15, 16, 17, 18, 19, 20, 21 mm; CrV; 6x7, 8x9, 10x11, 12x13, 14x15, 16x17, 18x19 mm; CrV

DRAWER / SZUFLADA 2

3x75, 5x100, 5x150, 6x38, 6x100, 6x150, 8x150 mm; CrMo; PH0x100, PH1x75, PH1x100, PH2x38, PH2x100, PH2x150, PH3x150 mm; CrMo; 180mm; 160mm; 160 mm LONG NOSE; 160 mm BENT NOSE

DRAWER / SZUFLADA 3

1/2" (12.7 mm): 10, 11, 12, 13, 14, 15, 16, 17, 18, 19, 20, 21, 22, 23, 24, 27, 30, 32 mm; CrV 50BV30; 1/2" (12.7 mm); (127 mm); CrV 50BV30; 1/2" (12.7 mm); CrV 50BV30; 1/2" (12.7 mm); (255 mm); (255 mm); CrV 50BV30; 7/2"; CrV 6140; 1/2" (12.7 mm); 16; 21 mm; CrV 50BV30; H4, H5, H6, H7, H8, H10, H12 (L=30 mm); H4, H5, H6, H7, H8, H10, H12 (L=75 mm); AISI S2; M5, M6, M8, M10, M12 (L=30 mm); M5, M6, M8, M10, M12 (L=75 mm); AISI S2; T20, T25, T30, T40, T45, T50, T55 (L=30 mm); T20, T25, T30, T40, T45, T50, T55 (L=75 mm); AISI S2; 1/2" (12.7 mm); 3/8" (9.5 mm); 1/2" (12.7 mm); 8, 9, 10, 11, 12, 13, 14, 15, 16, 17, 18, 19, 20, 21 mm (L=76 mm); CrV 50BV30

DRAWER / SZUFLADA 4

300 g (L=300 mm); Ø 40 mm (L=350 mm); 10x8x142 mm; 12x10x152 mm; 16x13x170 mm; 1/4" (6.3 mm): 3.5, 4, 4.5, 5, 5.5, 6, 7, 8, 9, 10, 11, 12, 13, 14 mm; CrV 50BV30; 1/4" (6.3 mm); 8, 10, 11, 12, 13 mm; CrV 50BV30; 1/4" (6.3 mm); (50.8, 101.6 mm); CrV 6140; 1/4" (6.3 mm); CrV 50BV30; 1/4" (6.3 mm); (155 mm); 7/2"; CrV 6140; 1/4" (6.3 mm); (150 mm); CrV 50BV30; 1/4" (6.3 mm); (152.4 mm); CrV 50BV30; 1/2" (12.5 mm); E10, E12, E14, E16, E18, E20; 1/4" (6.3 mm); E4, E5, E6, E7, E8; 2, 2.5, 3, 4, 5, 6, 7, 8, 10, 12 mm; T10, T15, T20, T25, T27, T30, T40, T45, T50

YATO	drawers / szuflady	
YT-55307	6	1

GB Service tool cabinet with tools
D Serviceschrank mit Werkzeugen
PL Szafka serwisowa z narzędziami
RUS Сервисный шкаф с инструментами
CZ Servisní skříňka s nářadím
H Szervizszekrény szerszámmal

RO Dulap echipat cu scule
F Servante d'atelier - set d'outils
I Armadio per utensili
E Armario para herramientas de servicio
CN 工具车托盘组套

WHITE
CARTON BOX
& COLOR LABEL



211 PCS
5 TRAY
WKŁAD

980x770
x465 mm

7x

BALL BEARING
ŁOŻYSKA
KULKOWE

25kg
35kg
35kg

DRAWERS
LOCKING
BLOKADA
SZUFLAD

NON SLIP
PODPROPILENE
WORKTOP
ANTYPOŚLIZGOWY
POLIPROPILENOWY
BLAT

WHEEL Ø
125 mm

BRAKE
HAMULEC

3x

UNIVERSAL PERFORATION
UNIWERSALNA
PERFORACJA

DOUBLE WALLS
PODWÓJNE
SCIANY

CORNER BUMPERS
NARÓŻNE ODBOJNIKI

DOUBLE WALLS
PODWÓJNE
SCIANY

CORNER BUMPERS
NARÓŻNE ODBOJNIKI

DOUBLE WALLS
PODWÓJNE
SCIANY



DRAWER / SZUFLADA 1

1/2" (12.7 mm): 8, 9, 10, 11, 12, 13, 14, 15, 16, 17, 18, 19, 20, 21, 22, 24 (L=38 mm); 27, 30, 32 mm (L=42 mm); 1/4" (6.3 mm): 4, 4.5, 5, 5.5, 6, 7, 8, 9, 10, 11, 12, 13 (L=25 mm); CrV 50BV30; 1/2" (12.7 mm): 10, 13, 14, 15, 17, 19, 21 mm (L=76 mm); 1/4" (6.3 mm): 6, 7, 8, 9, 10, 11, 12, 13 (L=50 mm); CrV 50BV30; 1/2" (12.7 mm): E10, E11, E12, E14, E16, 1/4" (6.3 mm): E4, E5, E6, E7, E8; CrV 50BV30; 1/2" (12.7 mm): (127, 254 mm); 1/4" (6.3 mm): (50.8, 101.6 mm); CrV 50BV30; 1/2" (12.7 mm): CrV 50BV30; 1/2" (12.7 mm): 16, 21 mm; CrV 50BV30; 1/2" (12.7 mm): (255 mm); 1/4" (6.3 mm): (152.4 mm); CrV 50BV30; 1/2" (12.7 mm): (255 mm); 1/4" (6.3 mm): (155 mm); CrV 6140; 1/4" (6.3 mm): (150 mm); CrV 50BV30; 1/4" (6.3 mm): 4, 5.5, 6.5 mm; AISI S2 / CrV 6150; 1/4" (6.3 mm): PH1 (x2), PH2 (x2), PH3; AISI S2 / CrV 6150; 1/4" (6.3 mm): PZ1, PZ2, PZ3; AISI S2 / CrV 6150; 1/4" (6.3 mm): T8, T10, T15, T20, T25, T30, T40; AISI S2 / CrV 6150; 1/4" (6.3 mm): 3, 4, 5, 6, 7, 8 mm; AISI S2 / CrV 6150

DRAWER / SZUFLADA 2

200 mm; CrV; Ø 3-6 mm (L=52 mm); Ø 6-8 (L=58 mm); Ø 8-11 (L=66 mm); Ø 11-14 (L=75 mm); Ø 14-18 (L=80 mm); Ø 18-25 (L=88 mm); 8, 9, 10, 11, 12, 13, 14, 15, 16, 17, 18, 19, 21, 22, 24 mm; CrV; T10, T15, T20, T25, T27, T30, T40, T45, T50; CrV 6150; 2, 2.5, 3, 4, 5, 6, 7, 8, 10, 12 mm; CrV 6150

DRAWER / SZUFLADA 3

6.0x38, 2.0x75, 3.0x75, 4.0x100, 5.0x100, 6.0x100 mm; PH0x100, PH1x100, PH2x38, PH2x150, PH3x150 mm; T7x75, T8x75, T9x75, T10x100, T15x100, T20x100, T25x100, T27x100 mm; S2; 6.0x150 mm; PH2x150 mm; CrV 6150

DRAWER / SZUFLADA 4

180 mm; 160 mm; 200 mm; 250 mm; 400 g; 340 g; 12.5x152, 16.0x172 mm; CrV 6150; 3.0x150, 4.0x150, 5.0x150, 6.0x150, 8.0x150 mm; CrV 6150; 8.0x112 mm; CrV 6150

DRAWER / SZUFLADA 5

M3x0.5 (x3), M4x0.7 (x3), M5x0.8 (x3), M6x1.0 (x3), M7x1.0 (x3), M8x1.25 (x3), M10x1.5 (x3), M12x1.75 (x3); HSS M2; M3, M4x0.7, M5x0.8, M6x1.0, M7x1.0, M8x1.25, M10x1.5, M12x1.75; HSS M2; M7-M9; M3-M12; #2, 200 mm; #2, 200 mm; #2, 200 mm; LED; 3 m x 16 mm; 300 mm; 0-150 mm

DRAWER / SZUFLADA 1



DRAWER / SZUFLADA 2



DRAWER / SZUFLADA 3

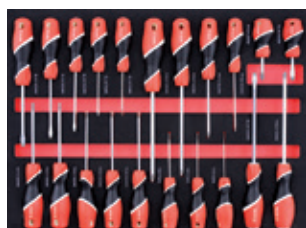

DRAWER / SZUFLADA 4



DRAWER / SZUFLADA 5

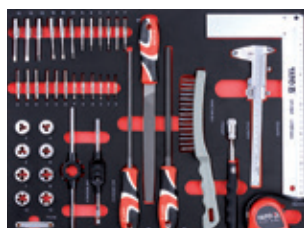

YATO	drawers / szuflady	
YT-55290	7	1

CREATE YOUR WORKPLACE - STWÓRZ SWOJE MIEJSCE PRACY

YT-09061



YT-08921

YT-09152



YT-08922



YT-08920

- GB Tool chest
- D Werkzeugkasten
- PL Szafka warsztatowa
- RUS Портативный ящик для инструментов
- CZ Přenosná skříňka na nářadí
- H Hordozható szerszámok láda
- RO Cabinet pt. scule
- F Servante d'atelier
- I Banco da lavoro armadio
- E Cajonera portátil
- CN 駁接箱



690x465
x400 mm



CORNER BUMPERS
NAROŻNE ODBOJNIKI

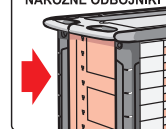

YATO	drawers / szuflady	
YT-09152	4	1

- GB Tool chest
- D Werkzeugkasten
- PL Szafka warsztatowa
- RUS Портативный ящик для инструментов
- CZ Přenosná skříňka na nářadí
- H Hordozható szerszámok láda
- RO Cabinet pt. scule
- F Servante d'atelier
- I Banco da lavoro armadio
- E Cajonera portátil
- CN 駁接箱



690x465
x535 mm



CORNER BUMPERS
NAROŻNE ODBOJNIKI

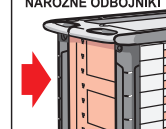

YATO	drawers / szuflady	
YT-09155	6	1

GB Roller cabinet
D Werkstattrollwagen
PL Szafka serwisowa
RUS Инструментальный кабинет
CZ Dílenská skříňka
H Szerviz - szekrény
RO Dulap de scule
F Servante d'atelier
I Armadio per utensili
E Armario en ruedas
CN 工具车

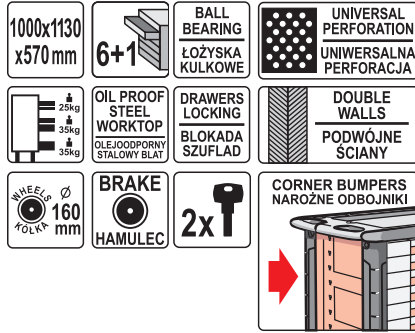

WHITE
CARTON BOX
& COLOR LABEL

YATO	drawers / szuflady	
YT-09002	6+1	1

GB Roller cabinet
D Werkstattrollwagen
PL Szafka serwisowa
RUS Инструментальный кабинет
CZ Dílenská skříňka
H Szerviz - szekrény
RO Dulap de scule
F Servante d'atelier
I Armadio per utensili
E Armario en ruedas
CN 工具车

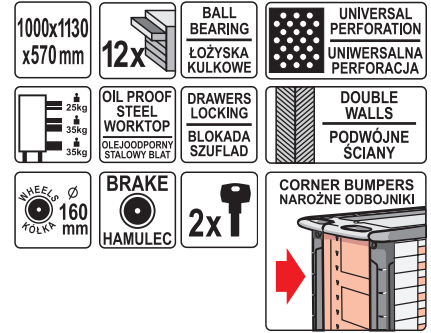

WHITE
CARTON BOX
& COLOR LABEL

YATO	drawers / szuflady	
YT-09003	12	1

GB Roller cabinet
D Werkstattrollwagen
PL Szafka serwisowa
RUS Инструментальный кабинет
CZ Dílenská skříňka
H Szerviz - szekrény
RO Dulap de scule
F Servante d'atelier
I Armadio per utensili
E Armario en ruedas
CN 工具车



WHITE
CARTON BOX
& COLOR LABEL

YATO	drawers / szuflady	
YT-0913	6	1

GB Roller cabinet
D Werkstattrollwagen
PL Szafka serwisowa
RUS Инструментальный кабинет
CZ Dílenská skříňka
H Szerviz - szekrény
RO Dulap de scule
F Servante d'atelier
I Armadio per utensili
E Armario en ruedas
CN 工具车



WHITE
CARTON BOX
& COLOR LABEL

YATO	drawers / szuflady	
YT-0914	7	1

GB Roller cabinet
D Werkstattrollwagen
PL Szafka serwisowa
RUS Инструментальный кабинет
CZ Dilenská skříňka
H Szerviz - szekrény
RO Dulap de scule
F Servante d'atelier
I Armadio per utensili
E Armario en ruedas
CN 工具车

958x766
x465 mm

6x

NON SLIP
POLYPROPYLENE
WORKTOP
ANTYPOŚLIZGOWY
POLIPROPYLENOWY
BLAT

25kg
35kg
35kg

CORNER BUMPERS
NAROŻNE ODBOJNIKI

DRAWERS
LOCKING
BLOKADA
SZUFLAD

UNIVERSAL
PERFORATION
UNIWERSALNA
PERFORACJA

DOUBLE
WALLS
PODWÓJNE
SCIANY

WHEEL
125
mm

BRAKE
HAMULEC

BALL
BEARING
ŁOŻYSKA
KULKOWE

DOUBLE
WALLS
PODWÓJNE
SCIANY

DOUBLE
WALLS
PODWÓJNE
SCIANY

WHEEL
125
mm

BRAKE
HAMULEC



WHITE
CARTON BOX
& COLOR LABEL



YATO drawers / szuflady
YT-0902 6 1

GB Roller cabinet
D Werkstattrollwagen
PL Szafka serwisowa
RUS Инструментальный кабинет
CZ Dilenská skříňka
H Szerviz - szekrény
RO Dulap de scule
F Servante d'atelier
I Armadio per utensili
E Armario en ruedas
CN 工具车

975x765
x465 mm

6x

NON SLIP
POLYPROPYLENE
WORKTOP
ANTYPOŚLIZGOWY
POLIPROPYLENOWY
BLAT

CORNER BUMPERS
NAROŻNE ODBOJNIKI

25kg
35kg

2x

DRAWERS
LOCKING
BLOKADA
SZUFLAD

UNIVERSAL
PERFORATION
UNIWERSALNA
PERFORACJA

BALL
BEARING
ŁOŻYSKA
KULKOWE

UNIVERSAL
PERFORATION
UNIWERSALNA
PERFORACJA

DOUBLE
WALLS
PODWÓJNE
SCIANY

WHEEL
125
mm

2x
BRAKE
HAMULEC



WHITE
CARTON BOX
& COLOR LABEL



YATO drawers / szuflady
YT-55299 6 1

GB Roller cabinet
D Werkstattrollwagen
PL Szafka serwisowa
RUS Инструментальный кабинет
CZ Dilenská skříňka
H Szerviz - szekrény
RO Dulap de scule
F Servante d'atelier
I Armadio per utensili
E Armario en ruedas
CN 工具车

932x665
x453 mm

7x

25kg
35kg
35kg

BALL
BEARING
ŁOŻYSKA
KULKOWE

CENTRAL
LOCK
CENTRALNY
ZAMEK

NON SLIP
POLYPROPYLENE
WORKTOP
ANTYPOŚLIZGOWY
POLIPROPYLENOWY
BLAT

WHEEL
125
mm

2x
BRAKE
HAMULEC

2x

UNIVERSAL
PERFORATION
UNIWERSALNA
PERFORACJA



WHITE
CARTON BOX
& COLOR LABEL



YATO drawers / szuflady
YT-09000 7 1

GB Workshop trolley
D Werkstatt-
Servicewagen
PL Wózek warsztatowy
RUS Сервисная тележка
CZ Dilenský policový vozík

H Műhelykocsi
RO Carucior pt. scule
F Chariot d'atelier
I Carrello da officina
E Carro para taller
CN 3抽屉工具车

795x790
x370 mm

3x
TRAY
PÓLKA

130
kg (max)

BALL
BEARING
ŁOŻYSKA
KULKOWE

WHEEL
100
mm

2x
BRAKE
HAMULEC



WHITE
CARTON BOX
& COLOR LABEL



YATO trays / półki
YT-55210 3 1

- GB** Shutter cabinet
D Werkstatt Hängeschrank
PL Szafka wisząca
RUS Шкафчик для инструмента настенный
CZ Zavěsná skříňka
- H** Szerszámtároló
RO Raft de scule
F Placard d'atelier
I Scaffale
E Armario colgante
CN 橙整揣



WHITE
CARTON BOX
& COLOR LABEL



YATO	size / rozmiar (mm)	
YT-09061	1500x605x185	1

- GB** Workbench
D Werkbank
PL Stół warsztatowy
RUS Верстак
- CZ** Pracovní stůl
H Munkapad
RO Banc de lucru
F Table d'atelier
- I** Banco da lavoro
E Banco de trabajo
CN 工作台

1500x780
x830 mm

NON SLIP
ABS
WORKTOP
ANTIPOŚLIZGOWY
BLAT
Z TWORZYWA ABS



WHITE
CARTON BOX
& COLOR LABEL



YATO	size / rozmiar (mm)	
YT-08920	1500x780x830	1

- GB** Legs for workbench, long
D Beine für Werkbank, lange
PL Nogi do stołu warsztatowego, długie
RUS Ножи для верстака, длинные
CZ Nohy k pracovnímu stolu, dlouhé
H Lábak munkapadhoz
RO Picioare pt. banc de lucru, lungi
F Jambes pour table d'atelier
I Gambe del tavolo piedi del banco da lavoro
E Patas para banco de trabajo, largas
CN 工作台长桌腿



2
PCS

140
cm

WHITE
CARTON BOX
& COLOR LABEL



for / dla: YT-08920

YATO	size / rozmiar (cm)	
YT-08921	140	2

- GB** Holders for workshop box
D Halterungen für die Montage eines Werkstattschranks
PL Uchwyty do montażu szafki warsztatowej
RUS Крепеж для рабочего шкафа
CZ Montážní držáky dílenské skříňky
H Műhelyszekrény tartó
RO Suporturi pt. montarea dulapurii de atelier
F Porte-placard d'atelier
I Staffa di montaggio per armadio portautensili
E Elementos de fijación para instalación de cajón de taller
CN 工具柜安装挂板



2
PCS

500x100
x350 mm

WHITE
CARTON BOX
& COLOR LABEL



for / dla: YT-08920, YT-09152

YATO	size / rozmiar (mm)	
YT-08922	500x100x350	2

- GB** Connection steel pipes set
D Anschluss Stahlrohre Gesetzt
PL Rury montażowe
RUS Стальная труба монтаж
CZ Ocelové trubky
H Acélsövek
RO Tevi din oțel
F Tuyaux en acier
I Set di montaggio per tabella utensili
E Tubos de acero
CN 工具柜连接杆



POLYBAG

2
PCS

45
x 2.8 cm

for / dla:
YT-09152
YT-09155
+
YT-0902
YT-0903
YT-0904



YATO	size / rozmiar (cm)	
YT-09071	45 x Ø 2.8	20

- GB** Double project center backwall
D Werkzeugwand
PL Tablica narzędziowa
RUS Доска инструмент
CZ Držáky na nářadí
H Szerszámtartó fal akasztókkal
RO Suport perete scule
F Mur d'outil
I La tabella utensili
E Panel de herramientas
CN 工具车双挂板

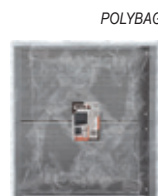

POLYBAG

2
PCS

65.2 x 61
x 5.5 cm

for / dla:
YT-0902 YT-55290
YT-0903 YT-55292
YT-09031 YT-55293
YT-0904 YT-5530

YATO	size / rozmiar (cm)	
YT-09072	65.2x61x5.5	1

- GB** Compartmented shelf and paper roll holder
D Werkstattwagenab-lage mit Papierrollehalter
PL Półka z uchwytem na papier
RUS Полка с держателем для бумаги
CZ Police s úchytem na papír
H Kiegészítő polc és papírrolni tartó funkcióval
RO Compartiment pt. dulap si suport hartie
F Support rouleau papier
I Mensola portarotoli carta
E Estante con sujetapapel
CN 托架



for / dla: YT-0902, YT-0903, YT-0904, YT-0905

YATO	size / rozmiar (mm)	
YT-0907	305x305x145	4

- GB** Dustbin
D Abfalleimer
PL Pojemnik na odpady
RUS Мусорный ящик
CZ Zásobník na odpad
H Szemetkosár
RO Lada de gunoi
F Poubelle
I Contenitore di rifiuti
E Cubo de basura
CN 废品箱



for / dla: YT-0902, YT-0903, YT-0904, YT-0905

YATO	size / rozmiar (mm)	
YT-0908	300x300x190	4

- GB** Separate board for drawer
D Trennsteg für Werkstatt-Wagen-Schublade
PL Przegroda do szafki
RUS Перегородки для ящика
CZ Půlhrádka do police
H Több rekeszes tálcá
RO Sertar separat de masura mica
F Cloison tiroir court
I Separatore per armadio
E Separador para armario
CN 抽屉分隔板



for / dla: YT-0902, YT-0903, YT-0904, YT-0905

YATO	size / rozmiar (mm)	
YT-0910	391x58x4	24
YT-0911	391x128x4	72

- GB** Magnetic towel holder
D Rollenhalter Magnetisch
PL Magnetyczny uchwyty na ręczniki
RUS Магнитная вешалка для бумаги
CZ Držáků magnetických papírových ručníků
H Mágneses papírtörő állvány
RO Suportů magnetici pt. prosoape
F Porte-serviettes en papier magnétique
I Portasciugamani magnetico
E Magnético de papel toallero
CN 磁性纸巾挂架

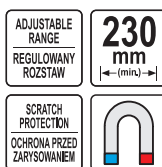

COLOR BOX



YATO	
YT-08680	24

- GB** Magnetic shelf
D Magnetische Ablage
PL Półka magnetyczna
RUS Магнитная полка для тележки
CZ Magnetický regál pro nářadí
H Mágneses polc szerszámkocsikhoz
RO Cutie magnetice pt. depozitare
F Magnétique plat
I Mensola magnetica
E Soporte de almacenamiento magnético
CN 磁性工具盒



COLOR BOX



YATO	
YT-08681	10

- GB** Magnetic tool tray set
D Magnetische Werkzeugablage Set
PL Zestaw półek magnetycznych
RUS Набор магнитных полок для тележки
CZ Sada magnetických polic
H Mágneses polc készlet

- RO** Cutii magnetice pt. depozitare
F Magnétique étagères set
I Set di ripiani magnetici
E Juego de estantes magnéticos
CN 4件套磁性工具盘组套



COLOR BOX

4
PCS

SCRATCH
PROTECTION
OCHRONA PRZED
ZARYSOWANIEM

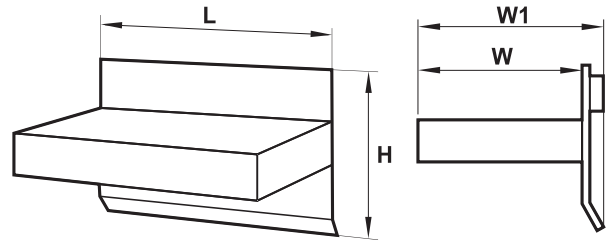
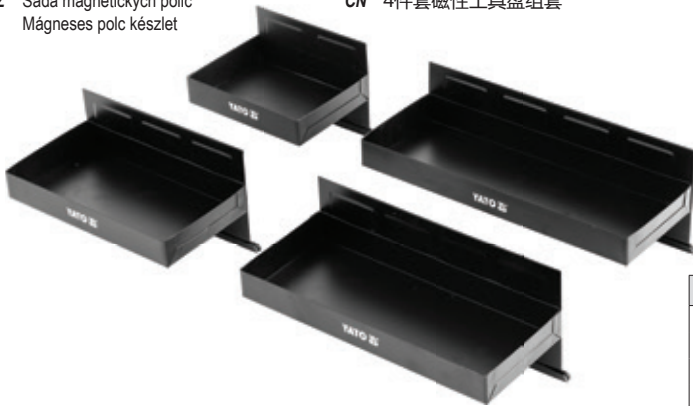

YATO		L (mm)	H (mm)	W (mm)	W1 (mm)	
YT-08682		310	120	115	125	6
		270	120	115	125	
		210	120	115	125	
		155	120	115	125	

- GB** Magnetic hooks set
D Magnetische Haken Set
PL Zestaw haczyków magnetycznych
RUS Набор магнитных крючков для тележки
CZ Sada magnetických háčků
H Mágneses kampók halmaza
RO Set de cârlige magnetice
F Ensemble de crochets magnétiques
I Set di ganci magnetici
E Conjunto de ganchos magnéticos
CN 挂钩

10
PCS

35mm

30mm

SCRATCH
PROTECTION
OCHRONA PRZED
ZARYSOWANIEM



DOUBLE
BLISTER



YATO		
YT-08690		12/48

- GB** Hook for panel
D Haken für perforierte Wände
PL Haczyki do panelu perforowanego
RUS Гачки для стенки с перфорацией
CZ Háčky pro stěnu s perforací
H Horgok perforált panelhez
RO Cârlige pt. panouri perforate
F Crochets pour le mur avec perforation
I Ganci per pannelli forati
E Ganchos para pared con perforación
CN 挂钩

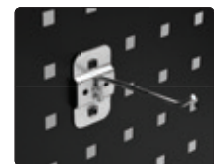

5
PCS



for / dla: YT-08936

POLYBAG

YATO		
YT-08937		20



- GB** Tool box
D Werkzeugkasten
PL Skrzynka narzędziowa
RUS Инструментальный ящик
CZ Skříňka na nářadí
H Szerszámós láda

- RO** Cutie de scule
F Boîte à outils
I Cassetta degli attrezzi
E Caja de herramientas
CN 工具箱

WHITE
CARTON BOX
& COLOR LABEL

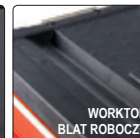

WORKTOP
BLAT ROBOCZY

RUBBER CORNER
GUMOWY NAROŻNIK



390x215x130 mm
max 10 kg



390x215x60 mm
max 5 kg

390x215x60 mm
max 5 kg

YATO	drawers / szuflady	
YT-09108	1	2

YATO	drawers / szuflady	
YT-09107	2	2

- GB Tool trolley
- D Werkzeugkasten
- PL Wózek narzędziowy 3-częściowy
- RUS Тележка инструментальная
- CZ Vozík na nářadí
- H Szerszám kocsi
- RO Troler pt. scule
- F Servante d'atelier
- I Armadio per utensili
- E Herramienta carro
- CN 工具箱



WHITE
CARTON BOX
& COLOR LABEL

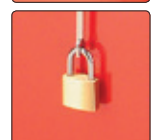
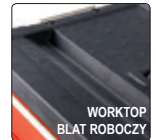

420x220x150 mm
max 20 kg

390x215x130 mm
max 10 kg

410x210x280 mm
max 15 kg

420x220x150 mm
max 20 kg

390x215x60 mm
max 5 kg

390x215x60 mm
max 5 kg

410x210x280 mm
max 15 kg



YATO	
YT-09102	1

YATO	
YT-09101	1

- GB Tool trolley
- D Werkzeugkasten
- PL Wózek narzędziowy 3-częściowy z narzędziami
- RUS Тележка инструментальная
- CZ Vozík na nářadí
- H Szerszám kocsi
- RO Troler cu scule
- F Servante d'atelier
- I Armadio per utensili
- E Herramienta carro
- CN 工具箱

WHITE CARTON BOX
& COLOR LABEL



78PCS
3 YEARS
WEAR

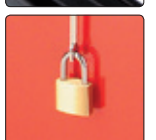
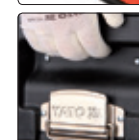
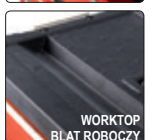

- 1/2" (12.7 mm): 8, 10, 12, 13, 14, 15, 16, 17, 18, 19, 20, 21, 22 mm; CrV 50BV30;
- 1/2" (12.7 mm): (127 mm); CrV 50BV30;
- 1/2" (12.7 mm); (255 mm); 72T; CrV 6140;
- 3x75, 6x100; PH0x75, PH2x100 mm; S2;
- 215 mm;
- 1/4" (6.3 mm): 3.0, 3.5, 4.0, 5.5, 6.5 mm (L=25 mm); S2;
- 1/4" (6.3 mm): PH0, PH1, PH2, PH3 (L=25 mm); S2;
- 1/4" (6.3 mm): P20, P21, P22, P23 (L=25 mm); S2;
- 1/4" (6.3 mm): T10, T15 (L=25 mm); S2;
- 1/4" (6.3 mm): 2.0, 3.0, 4.0, 5.0, 6.0 mm (L=25 mm); S2;
- 1/4" (6.3 mm): 5.0, 6.0, 7.0, 8.0(x2), 9.0, 10.0, 11.0, 12.0, 13.0 mm



- 8, 10, 12, 13, 14, 15, 16, 17, 18, 19, 21 mm; CrV
- 18 mm; SK5; 18 mm; SK5; 3 m x 16 mm



- 180 mm; 160 mm; 200 mm; LONG NOSE;
- 300 mm; 16-38 mm; 12.0, 2.5, 3.0, 4.0, 5.0, 6.0, 7.0, 8.0, 10, 12 mm; CrV 6150



YATO	
YT-09104	1

GB Cantilever tool box
D Werkzeugkoffer
PL Skrzynka narzędziowa
RUS Инструментальный ящик
CZ Nástrojová skříňka
H Szerszámoszláda

RO Cutie pt. scule
F Boîte à outils
I Cassetta degli attrezzi
E Caja de herramientas
CN 工具箱

WHITE
CARTON
BOX
& COLOR
LABEL



YATO	size / rozmiar (mm)	
YT-88880	350x180x160	12

YATO	size / rozmiar (mm)	
YT-88881	420x210x195	9

YATO	size / rozmiar (mm)	
YT-88882	475x230x210	6

GB Cantilever tool box
D Werkzeugkoffer
PL Skrzynka narzędziowa
RUS Инструментальный ящик

CZ Nástrojová skříňka
H Szerszámoszláda
RO Cutie pt. scule
F Boîte à outils

I Cassetta degli attrezzi
E Caja de herramientas
CN 工具箱

WHITE
CARTON
BOX
& COLOR
LABEL



YATO	size / rozmiar (mm)	
YT-0882	360x150x115	4

YATO	size / rozmiar (mm)	
YT-0883	428x180x180	1

YATO	size / rozmiar (mm)	
YT-0884	460x200x180	1



YATO	size / rozmiar (mm)	
YT-0885	460x200x225	1

YATO	size / rozmiar (mm)	
YT-0886	510x220x240	1

GB Cantilever tool box
D Werkzeugkoffer
PL Skrzynka narzędziowa
RUS Инструментальный ящик

CZ Nástrojová skříňka
H Szerszámoszláda
RO Cutie pt. scule
F Boîte à outils

I Cassetta degli attrezzi
E Caja de herramientas
CN 工具箱

WHITE
CARTON
BOX
& COLOR
LABEL



YATO	drawers / szuflady	size / rozmiar (mm)	
YT-08872	2	218x255x520	1

YATO	drawers / szuflady	size / rozmiar (mm)	
YT-08873	3	218x300x520	1

YATO	drawers / szuflady	size / rozmiar (mm)	
YT-08874	4	218x360x520	1

GB Tool box with tools
D Werkzeugkoffer
PL Skrzynka z narzędziami
RUS Инструментальный ящик
CZ Nástrojová skříňka
H Szerszámoszláda

RO Cutie pt. scule
F Boîte d'outils
I Cassetta degli attrezzi
E Caja de herramientas
CN 工具组套

WHITE CARTON BOX
& COLOR LABEL



62 PCS	1/2" 12.5mm	CrV 50BV30	CrV 6150	CrV 6140
72T	AS-DRIVE			



- 1/2" (12.7 mm): 10, 11, 12, 13, 14, 15, 16, 17, 18, 19, 20, 21, 22, 23, 24 mm (L=38 mm); 27, 30, 32 mm (L=42 mm); CrV 50BV30;
- 1/2" (12.7 mm); (76, 127, 254 mm); CrV 50BV30;
- 1/2" (12.7 mm); CrV 50BV30;
- 1/2" (12.7 mm): 21 mm; CrV 50BV30;
- 1/2" (12.7 mm); (255 mm); CrV 50BV30;
- 1/2" (12.7 mm); 72T; CrV 6140;
- 1/2" (12.7 mm); (450 mm); CrV 50BV30;
- 6, 7, 8, 9, 10, 11, 12, 13, 14, 15, 16, 17, 18, 19, 20, 21, 22, 24 mm; CrV;
- 6x100, 6x150, 8x200 mm; CrV 6150;
- PH2x100, PH3x150, PH3x200 mm; CrV 6150;

- 180 mm; CrV;
- 160 mm; CrV;
- 160 mm; CrV;
- 1.5, 2, 2.5, 3, 4, 5, 6, 8, 10 mm; CrV 6150



YATO	size / rozmiar (mm)	
YT-3895	475x230x365	1

GB Tool box with tools
D Werkzeugkoffer
PL Skrzynka z narzędziami

RUS Инструментальный ящик
CZ Nástrojová skříňka
H Szerszámoszláda

RO Cutie pt. scule
F Boîte d'outils
I Cassetta degli attrezzi

E Caja de herramientas
CN 工具组套

80 PCS	1/2" 12.5mm	1/4" 6.3mm	CrV 50BV30	CrV 6140
S2	72T	AS-DRIVE		



- 1/2" (12.7 mm): 10, 11, 12, 13, 14, 15, 17, 19 mm (L=38 mm); 1/4" (6.3 mm): 5, 6, 7, 8, 9, 10, 11, 12, 13 mm (L=25 mm); CrV 50BV30;
- 1/2" (12.7 mm): 21 mm; CrV 50BV30;
- 1/2" (12.7 mm); (255 mm); 72T; CrV 6140;
- 1/4" (6.3 mm); (150 mm); CrV 50BV30;
- 1/4" (6.3 mm) x 1/4" (6.3 mm); CrV 50BV30;
- 1/4" (6.3 mm): 3 (x2), 4 (x2), 5 (x2), 5.5 (x2), 6 (x2) mm (L=25 mm); AISI S2;
- 1/4" (6.3 mm): PH0, PH1 (x2), PH2 (x2), PH3 (L=25 mm); AISI S2;
- 1/4" (6.3 mm): PZ0, PZ1 (x2), PZ2 (L=25 mm); AISI S2;
- 6, 7, 8, 9, 10, 11, 12, 13, 14, 15, 17, 19 mm; CrV;
- 5x75 mm, 6x100 mm, 8x150 mm, PH1x75 mm, PH2x100 mm; S2;
- 180 mm; CrV; 160 mm; CrV; 160 mm; CrV;
- 250 mm; 300 g; 18 mm; SK2; 18x0.5 mm; SK2;
- 1.5, 2, 2.5, 3, 4, 5, 5.5, 6 mm; T10, T15, T20, T25, T27, T30, T40; CrV



WHITE CARTON BOX
& COLOR LABEL



YATO	size / rozmiar (mm)	
YT-38951	460x220x245	1

- GB Impact socket set
D Kraftschrauber-Einsätze
PL Zestaw nasadek udarowych
RUS Набор торцевых ударных головок
CZ Sada nástrčných klíčů pro úderové utahováky
H Dugófej készlet ütvebehajtóhoz
RO Set chei tubulare pt. impact
F Douille profonde à choc
I Chiave a bussola esagonale per percussione
E Juego de boquillas de percusión cortas
CN 风动套筒组套

METAL CASE & COLOR BOX



10 PCS 3/8" 10mm CrMo SCM-440



3/8" (9.5 mm): 10, 12, 13, 14, 15, 16, 17, 18, 19, 22 mm (L=39 mm)

YATO	Ø	
YT-37690	3/8" (9.5 mm)	20

- GB Hexagonal impact socket
D Kraftschrauber-Einsatz
PL Nasadka udarowa sześciokątna
RUS Головка ударная 6-гранная
CZ Šestihranný nástavec
H Hatszögű rátét
RO Cheie tubulară hexagonală de impact
F Douille à choc
I Chiave a bussola esagonale per percussione
E Boquilla de percusión
CN 六角风动套筒

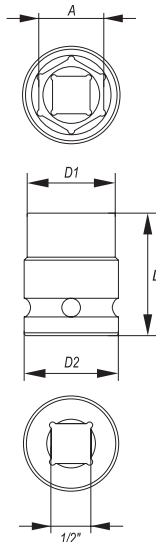

1/2" 12.5mm CrMo SCM-440 AS-DRIVE

YATO	Ø A (mm)	D1 (mm)	D2 (mm)	L (mm)	PCS packing:	
YT-1000	10	17.5	25.0	39	60	240
YT-1001	11	18.5	25.0	39	60	240
YT-1002	12	20.0	25.0	39	60	240
YT-1003	13	21.0	25.0	39	60	240
YT-1004	14	22.5	25.0	39	60	240
YT-1005	15	23.5	30.0	39	40	160
YT-1006	16	24.0	30.0	39	40	160
YT-1007	17	26.0	30.0	39	40	160
YT-1008	18	27.5	30.0	39	40	160
YT-1009	19	28.0	30.0	39	40	160
YT-1010	20	30.0	30.0	39	40	160
YT-1011	21	30.0	30.0	39	40	160
YT-1012	22	32.0	30.0	39	30	120
YT-1013	23	32.0	30.0	39	30	120
YT-1014	24	34.0	30.0	43	30	120
YT-1015	25	35.0	30.0	43	30	120
YT-1016	26	38.0	30.0	43	24	96
YT-1017	27	38.0	30.0	43	24	96
YT-1018	28	40.0	30.0	48	24	96
YT-1019	29	41.0	30.0	48	22	88
YT-1020	30	42.0	30.0	48	24	96
YT-1022	32	44.0	30.0	48	20	80

COLOR BOX



- GB Impact socket set
D Kraftschrauber-Einsätze
PL Zestaw nasadek udarowych
RUS Набор торцевых ударных головок
CZ Sada nástrčných klíčů pro úderové utahováky
H Dugófej készlet ütvebehajtóhoz
RO Set chei tubulare pt. impact
F Douille profonde à choc
I Chiave a bussola esagonale per percussione
E Juego de boquillas de percusión cortas
CN 风动套筒组套

METAL CASE & COLOR BOX



10 PCS 1/2" 12.5mm CrMo SCM-440 AS-DRIVE



1/2" (12.7 mm): 10, 12, 13, 14, 15, 16, 17, 18, 19, 22 mm (L=39 mm)

YATO	Ø	
YT-1025	1/2" (12.7 mm)	20

- GB Hexagonal deep impact socket
D Kraftschrauber-Einsatz, lang
PL Nasadka udarowa sześciokątna długa
RUS Головка ударная 6-гранная глубокая
CZ Šestihranný hluboký nástavec
H Hatszögű rátét mély
RO Cheie tubulară hexagonală de impact adâncă
F Douille profonde à choc
I Chiave a bussola esagonale per percussione
E Boquilla de percusión profunda
CN 六角风动长套筒

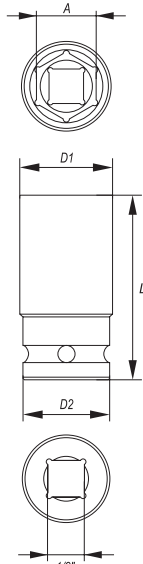

1/2" 12.5mm CrMo SCM-440 AS-DRIVE

YATO	Ø A (mm)	D1 (mm)	D2 (mm)	L (mm)	PCS packing:	
YT-1030	10	17.5	24.0	78	30	120
YT-1031	11	18.5	24.0	78	30	120
YT-1032	12	20.0	24.0	78	30	120
YT-1033	13	21.0	24.0	78	30	120
YT-1034	14	22.0	24.0	78	30	120
YT-1035	15	23.7	24.0	78	30	120
YT-1036	16	24.0	24.0	78	30	120
YT-1037	17	26.0	26.0	78	25	100
YT-1038	18	28.0	28.0	78	24	96
YT-1039	19	28.0	28.0	78	24	96
YT-1040	20	30.0	30.0	78	20	80
YT-1041	21	30.0	30.0	78	20	80
YT-1042	22	32.0	30.0	78	18	72
YT-1043	23	32.0	30.0	78	15	60
YT-1044	24	34.0	30.0	78	15	60
YT-1045	25	35.0	30.0	78	15	60
YT-1046	26	38.0	30.0	78	12	48
YT-1047	27	38.0	30.0	78	12	48
YT-1048	28	40.0	30.0	78	12	48
YT-1049	29	41.0	30.0	78	10	40
YT-1050	30	42.0	30.0	78	10	40
YT-1052	32	44.0	30.0	78	10	40

COLOR BOX



GB Impact socket set
D Kraftschrauber-Einsätze
PL Zestaw nasadek udarowych
RUS Набор торцевых ударных головок
CZ Sada nástrčných klíčů pro úderové utahováky

H Dugófej készlet ütvebehajtóhoz
RO Set chei tubulare pt. impact
F Set de douilles à choc
I Chiave a bussola esagonale per percussione

E Juego de boquillas de percusión cortas
CN 风动套筒组套



1/2"
12.5mm CrMo SCM-440 AS-DRIVE



11
PCS

1/2" (12.7 mm): 10, 12, 13, 14, 15, 16, 17, 18, 19, 22, 24 mm (L=39 mm)

15
PCS

1/2" (12.7 mm): 10, 12, 13, 14, 15, 16, 17, 18, 19, 21, 22, 24, 27, 30, 32 mm (L=39 mm)

YATO	Ø	PCS
YT-1054	1/2" (12.7 mm)	10

YATO	Ø	PCS
YT-1055	1/2" (12.7 mm)	4

GB Impact extension bar
D Verlängerung
PL Przedłużka udarowa
RUS Удлинитель ударный
CZ Prodlužovací příravek
H Toldalék
RO Prelungitor
F Rallonge
I Prolunga per percussione
E Tubo de prolongación
CN 风动接杆

1/2"
12.5mm CrMo SCM-440



YATO	Ø	D1 (mm)	D2 (mm)	L (mm)	PCS packing	PCS
YT-1060	1/2" (12.7 mm)	17.5	25.0	75	40	160
YT-1061	1/2" (12.7 mm)	18.5	25.0	125	28	112
YT-1062	1/2" (12.7 mm)	20.0	25.0	250	30	60

GB Impact adapter
D Reduktion
PL Redukcja udarowa
RUS Переходник
CZ Redukce
H Redukció
RO Reducție
F Réduction
I Prolunga per percussione
E Reducción
CN 风动转换头

1/2"
12.5mm CrMo SCM-440

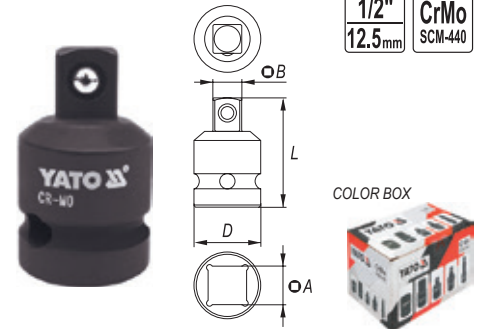

YATO	Ø	Ø	D (mm)	L (mm)	PCS packing	PCS
YT-1067	1/2" (12.7 mm) (F)	3/4" (19.0 mm) (M)	30	48	40	160

GB Impact universal joint
D Gelenkstück
PL Przegub kulisty udarowy
RUS Кардан ударный
CZ Kloub kulový
H Univerzális csuklós csatlakozó
RO Adaptor
F Flector rond
I Prolunga per percussione
E Articulación redonda
CN 风动方向接头

1/2"
12.5mm CrMo SCM-440

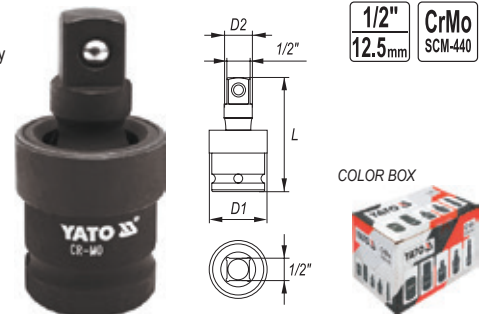

YATO	Ø	D1 (mm)	D2 (mm)	L (mm)	PCS packing	PCS
YT-1064	1/2" (12.7 mm)	31	17	63	25	100

GB Hexagonal impact socket
D Kraftschrauber-Einsatz
PL Nasadka udarowa sześciokątna
RUS Головка ударная 6-гранная
CZ Šestihranný nástavec
H Hatszögű rátét
RO Cheie tubulară hexagonală de impact
F Douille à choc
I Chiave a bussola esagonale per percussione
E Boquilla de percusión
CN 六角风动套筒

3/4"
19mm CrMo SCM-440 AS-DRIVE



YATO	Ø A (mm)	D1 (mm)	D2 (mm)	L (mm)	PCS packing	PCS
YT-1070	19	32	40	50	16	64
YT-1071	21	35	40	50	16	64
YT-1072	22	38	40	50	16	64
YT-1073	23	38	40	50	16	64
YT-1074	24	40	40	50	16	64
YT-1075	25	40	40	50	16	64
YT-1076	26	40	40	50	16	64
YT-1077	27	42	42	53	16	64
YT-1078	28	44	44	53	16	64
YT-1079	29	46	44	53	12	48
YT-1080	30	46	44	53	12	48
YT-1082	32	48	44	56	12	48
YT-1083	33	48	44	56	8	32
YT-1084	34	50	44	56	8	32
YT-1085	35	50	44	56	6	24
YT-1086	36	52	44	56	6	24
YT-1088	38	56	44	57	6	24
YT-1091	41	60	44	57	5	20
YT-1092	42	61	44	57	4	16
YT-1093	43	63	44	57	4	16
YT-1096	46	66	44	62	3	12
YT-1100	50	71	54	72	3	12
YT-1102	52	74	54	72	2	8
YT-1105	55	78	54	74	2	8
YT-1110	60	84	54	74	2	8

GB Impact socket set
D Kraftschrauber-Einsätze
PL Zestaw nasadek udarowych
RUS Набор торцевых ударных головок

CZ Sada nástrčných klíčů pro úderové utahováky
H Dugófej készlet ütvebehajtóhoz
RO Set chei tubulare pt. impact
F Set de douilles à choc

I Chiave a bussola esagonale per percussione
E Juego de boquillas de percusión cortas
CN 风动套筒组套



8 PCS 3/4" 19mm CrMo SCM-440 AS-DRIVE



3/4" (19.0 mm): 22, 24 mm (L=50 mm); 27, 30 mm (L=53 mm); 32, 36 mm (L=55 mm); 38, 41 mm (L=57 mm)

YATO	Ø	PCS packing:
YT-1115	3/4" (19.0 mm)	6

GB Hexagonal deep impact socket
D Kraftschrauber-Einsatz, lang
PL Nasadka udarowa sześciokątna długa
RUS Головка ударная 6-гранная глубокая
CZ Šestihranný hluboký nástavec
H Hatszögű rátét mély
RO Cheie tubulară hexagonală de impact adâncă
F Douille profonde à choc
I Chiave a bussola esagonale per percussione
E Boquilla de percusión profunda
CN 六角风动长套筒

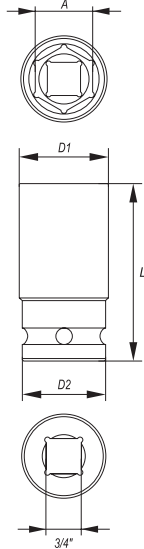

3/4" 19mm CrMo SCM-440 AS-DRIVE

YATO	Ø A (mm)	D1 (mm)	D2 (mm)	L (mm)	PCS packing:
YT-1119	19	32	44	90	9
YT-1121	21	35	44	90	9
YT-1122	22	38	44	90	9
YT-1123	23	38	44	90	9
YT-1124	24	40	44	90	9
YT-1127	27	42	44	90	9
YT-1128	28	44	44	90	8
YT-1129	29	44	44	90	8
YT-1130	30	46	44	90	7
YT-1132	32	48	44	90	7
YT-1133	33	50	44	90	6
YT-1134	34	51	44	90	6
YT-1135	35	52	44	90	6
YT-1136	36	54	44	90	6
YT-1138	38	56	44	90	6
YT-1141	41	60	44	90	5
YT-1142	42	61	44	90	4
YT-1143	43	63	44	90	3
YT-1146	46	66	44	90	3
YT-1148	48	68	44	90	2
YT-1150	50	71	54	90	2

COLOR BOX



GB Impact socket set
D Kraftschrauber-Einsätze
PL Zestaw nasadek udarowych
RUS Набор торцевых ударных головок

CZ Sada nástrčných klíčů pro úderové utahováky
H Dugófej készlet ütvebehajtóhoz
RO Set chei tubulare pt. impact
F Set de douilles à choc

I Chiave a bussola esagonale per percussione
E Juego de boquillas de percusión cortas
CN 风动套筒组套



8 PCS 3/4" 19mm CrMo SCM-440 AS-DRIVE



3/4" (19.0 mm): 22, 24, 27, 30, 32, 36, 38, 41 mm (L=90 mm)

YATO	Ø	PCS packing:
YT-1155	3/4" (19.0 mm)	4

GB Impact extension bar
D Verlängerung
PL Przedłużka udarowa
RUS Удлинитель ударный
CZ Prodlužovací přípravek
H Toldalék
RO Prelungitor
F Rallonge
I Prolunga per percussione
E Tubo de prolongación
CN 风动接杆

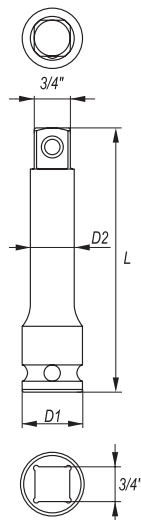

COLOR BOX



3/4" 19mm CrMo SCM-440

YATO	Ø	D1 (mm)	D2 (mm)	L (mm)	PCS packing:
YT-1160	3/4" (19.0 mm)	44	24	100	8
YT-1161	3/4" (19.0 mm)	44	24	175	10
YT-1162	3/4" (19.0 mm)	44	24	250	8
YT-1163	3/4" (19.0 mm)	44	24	330	6

GB Impact adapter
D Reduktion
PL Redukcja udarowa
RUS Переходник
CZ Redukce
H Redukció
RO Reducție
F Réduction
I Prolunga per percussione
E Reducción
CN 风动转换头

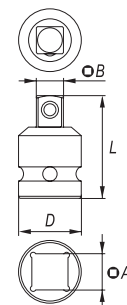

3/4" 19mm CrV 50BV30

COLOR BOX



YATO	Ø	Ø	D (mm)	L (mm)	PCS packing:
YT-11671	3/4" (19.0 mm) (F)	1/2" (12.7 mm) (M)	44	55	12

GB Impact adapter
D Reduktion
PL Redukcja udarowa
RUS Переходник
CZ Redukce
H Redukció
RO Reducție
F Réduction
I Prolunga per percussione
E Reducción
CN 风动转换头

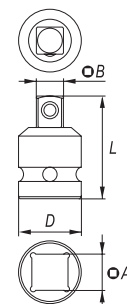

3/4" 19mm CrMo SCM-440

COLOR BOX



YATO	Ø	Ø	D (mm)	L (mm)	PCS packing:
YT-1168	3/4" (19.0 mm) (F)	1" (25.4 mm) (M)	44	63	12

- GB** Impact universal joint
D Gelenkstück
PL Przegub kulisty udarowy
RUS Кардан ударный
CZ Kloub kulový
H Univerzális csuklós csatlakozó
RO Adaptor
F Flector rond
I Prolunga per percussione
E Articulación redonda
CN 风动方向接头

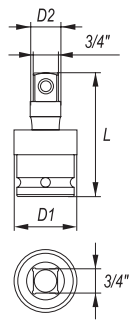

3/4"
19mm
CrMo
SCM-440

COLOR BOX



YATO	Ø	D1 (mm)	D2 (mm)	L (mm)	PCS packing	
YT-1164	3/4" (19.0 mm)	31	44	102	8	32

- GB** Hexagonal deep impact socket
D Kraftschrauber-Einsatz, lang
PL Nasadka udarowa sześciokątna długa
RUS Головка ударная 6-гранная глубокая
CZ Šestihranný hluboký nástavec
H Hatszögű rátét mély
RO Cheie tubulară hexagonală de impact adâncă
F Douille profonde à choc
I Chiave a bussola esagonale per percussione
E Boquilla de percusión profunda
CN 六角风动长套筒

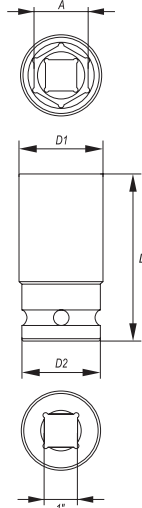

1"
25mm
CrMo
SCM-440
AS-DRIVE

COLOR BOX



YATO	Ø A (mm)	D1 (mm)	D2 (mm)	L (mm)	PCS packing	
YT-1175	27	46	54	90	6	24
YT-1176	30	50	54	90	6	24
YT-1177	32	52	54	90	6	24
YT-1178	33	54	54	90	6	24
YT-1179	36	57	54	90	6	24

- GB** Hexagonal deep impact socket
D Kraftschrauber-Einsatz, lang
PL Nasadka udarowa sześciokątna długa
RUS Головка ударная 6-гранная глубокая
CZ Šestihranný hluboký nástavec
H Hatszögű rátét mély
RO Cheie tubulară hexagonală de impact adâncă
F Douille profonde à choc
I Chiave a bussola esagonale per percussione
E Boquilla de percusión profunda
CN 六角风动长套筒

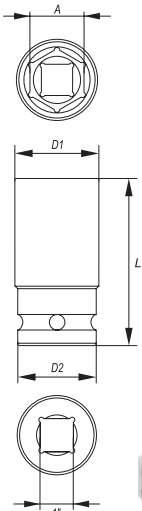

1"
25mm
CrMo
AS-DRIVE

COLOR BOX



YATO	Ø A (mm)	D1 (mm)	D2 (mm)	L (mm)	PCS packing	
YT-11730	24	42	50	80	6	12
YT-11731	27	44	50	80	6	12
YT-11734	30	50	54	80	6	12
YT-11735	32	52	54	80	6	12
YT-11736	33	53	54	80	6	12
YT-11737	34	53	54	80	6	12
YT-11738	36	54	54	80	6	12
YT-11739	38	58	54	80	6	12
YT-11740	41	60	54	80	6	12

- GB** Hexagonal impact socket
D Kraftschrauber-Einsatz
PL Nasadka udarowa sześciokątna
RUS Головка ударная 6-гранная
CZ Šestihranný nástavec
H Hatszögű rátét
RO Cheie tubulară hexagonală de impact
F Douille à choc
I Chiave a bussola esagonale per percussione
E Boquilla de percusión
CN 六角风动套筒

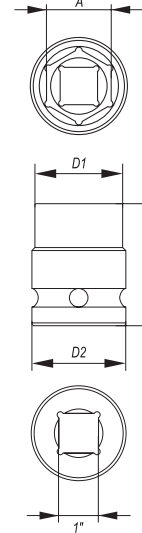

1"
25mm
CrMo
SCM-440
AS-DRIVE

COLOR BOX



YATO	Ø A (mm)	D1 (mm)	D2 (mm)	L (mm)	PCS packing	
YT-1180	24	42	54	59	6	24
YT-1183	27	46	54	59	6	24
YT-1184	28	47	54	59	6	24
YT-1185	29	48	54	60	6	24
YT-1186	30	49	54	60	6	24
YT-1187	32	52	54	61	6	24
YT-1188	33	53	54	61	6	24
YT-1189	34	54	54	61	6	24
YT-1191	36	57	54	65	6	24
YT-1193	38	60	54	65	5	20
YT-1194	41	63	54	65	4	16
YT-1196	46	69	54	73	3	12
YT-1197	48	72	54	73	2	8
YT-1198	50	75	54	73	2	8

- GB** Impact extension bar with adapter
D Verlängerung mit Adapter
PL Przedłużka udarowa z redukcją
RUS Удлинитель с редукцией
CZ Prodloužení s redukcí
H Hosszabbító szár adapterrel
RO Bara extensie cu adaptor
F Rallonge avec reduction
I Prolunga per percussione con riduttore
E Tubo de prolongación con reductor
CN 风动转换接头

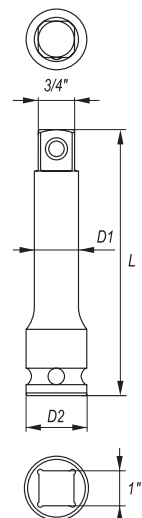

1"
25mm
CrMo
SCM-440

COLOR BOX



YATO	Ø A	Ø B	D1 (mm)	D2 (mm)	L (mm)	PCS packing	
YT-1169	1" (25.4 mm) (F)	3/4" (19.0mm) (M)	53	33	250	6	12

- GB** Hexagonal impact socket
D Kraftrschrauber-Einsatz
PL Nasadka udarowa sześciokątna
RUS Головка ударная 6-гранная
CZ Šestihranný nástavec
H Hatszögű rátét
RO Cheie tubulară hexagonală de impact
F Douille à choc
I Chiave a bussola esagonale per percussione
E Boquilla de percusión
CN 六角风动套筒

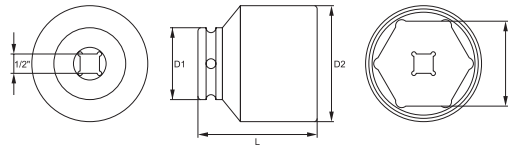

COLOR BOX



1/2"	FOR FRONT HUB NUTS
12.5mm	DO PIAST
CrMo	AS-DRIVE
SCM-440	

YATO	Ø A (mm)	D1 (mm)	D2 (mm)	L (mm)	PCS packing	
YT-1029	52	44	71	72	3	12

- GB** Bi-hexagonal impact socket
D Zwölfkant-Kraftrschrauber-Einsatz
PL Nasadka udarowa dwunastokątna
RUS Головка ударная 12-гранная
CZ Vanáctihřanný nástavec
H Dugófej, 12 lapú
RO Cheie tubulară bihexagonală de impact
F Douille à choc
I Chiave a bussola esagonale per percussione
E Boquilla bihexagonal de percusión
CN 风动套筒

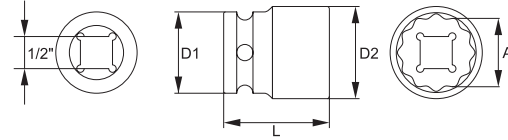

COLOR BOX



1/2"	FOR FRONT HUB NUTS
12.5mm	DO PIAST
CrMo	AS-DRIVE
SCM-440	

YATO	Ø A (mm)	D1 (mm)	D2 (mm)	L (mm)	PCS packing	
YT-1027	24	30	34	39	10	120

- GB** Bi-hexagonal impact socket
D Zwölfkant-Kraftrschrauber-Einsatz
PL Nasadka udarowa dwunastokątna
RUS Головка ударная 12-гранная
CZ Vanáctihřanný nástavec
H Dugófej, 12 lapú
RO Cheie tubulară bihexagonală de impact
F Douille à choc
I Chiave a bussola esagonale per percussione
E Boquilla bihexagonal de percusión
CN 风动套筒

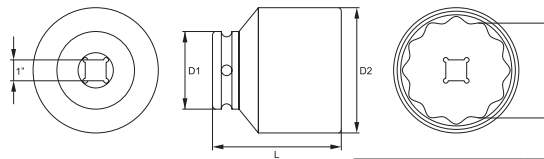

COLOR BOX



1"	FOR FRONT HUB NUTS
25mm	DO PIAST
CrMo	HRC
	38-45

YATO	Ø A (mm)	D1 (mm)	D2 (mm)	L (mm)	
YT-11990	65	54	93	93	4
YT-11995	80	86	112	100	4
YT-11998	85	86	118	102	4

- GB** Impact bit socket set
D Schlagsteckschlüsselsatz
PL Zestaw udarowych kluczy trzpieniowych
RUS Набор ударных торцовых ключей
CZ Souprava rázových zástrčných klíčů
H Üthető dugókulcs bit - készlet
RO Set chei de șoc cu bolt
F Set de douilles à choc
I Set di chiavi a bussola per percussione
E Juego de llaves de mandril de impacto
CN 风动套筒批头组套



6 PCS	1/2"	SPLINE	CrMo
	12.5mm		

M14, M16, M18 (L=43 mm)
M14, M16, M18 (L=78 mm)

BMC & COLOR SLEEVE



YATO	Ø	
YT-10652	1/2" (12.7 mm)	20

- GB** Impact bit socket set
D Schlagsteckschlüsselsatz
PL Zestaw udarowych kluczy trzpieniowych
RUS Набор ударных торцовых ключей

- CZ** Souprava rázových zástrčných klíčů
H Üthető dugókulcs bit - készlet
RO Set chei de șoc cu bolt
F Set de douilles à choc

- I** Set di chiavi a bussola per percussione
E Juego de llaves de mandril de impacto
CN 风动套筒批头组套

BMC & COLOR SLEEVE



9 PCS	1/2"	CrMo
	12.5mm	



T20, T25, T30, T40, T45, T50, T55, T60, T70

YATO	Ø	
YT-10654	1/2" (12.7 mm)	10



RM5, RM6, RM7, RM8, RM9, RM10, RM12, RM13, RM14



M4, M5, M6, M8, M9, M10, M12, M14, M16



YATO	Ø	
YT-10681	1/2" (12.7 mm)	10

YATO	Ø	
YT-10691	1/2" (12.7 mm)	10

GB Impact bit socket set
D Schlagsteckschlüsselsatz
PL Zestaw udarowych kluczy trzpieniowych
RUS Набор ударных торцовых ключей

CZ Souprava rázových zástrčných klíčů
H Ütőthő dugókulcs bit - készlet
RO Set chei de șoc cu bolt
F Set de douilles à choc
I Set di chiavi a bussola per percussione
E Juego de llaves de mandril de impacto
CN 风动套筒批头组套



8 PCS	1/2" 12.5mm	CrMo	HRC 54
-----------------	-----------------------	-------------	---------------



T30, T40, T45, T50, T55, T60, TORX T70, T80

6, 7, 8, 10, 12, 14, 17, 19mm
HEX

YATO		
YT-1065	1/2" (12.7 mm)	15

YATO		
YT-1066	1/2" (12.7 mm)	15



RMS, RM6, RM7, RM8, RM10, RM11, RM12, RM13
RIBE

M5, M6, M8, M10, M12, M14, M16, M18
SPLINE

YATO		
YT-1068	1/2" (12.7 mm)	15

YATO		
YT-1069	1/2" (12.7 mm)	15

GB Spline impact bit set
D Schlagwerkzeugsatz - Spline
PL Zestaw bitów udarowych - Spline
RUS Набор ударных битов - Spline
CZ Souprava bitů pro rázové utahováky - Spline
H Ütő bit készlet - Spline
RO Set tubulare de impact
F Set d'embouts à choc
I Set di chiavi a bussola per percussione
E Juego de las piezas de percusión - Spline
CN 风动花键批头组套



6 PCS	3/4" 19mm		CrMo
-----------------	---------------------	--	-------------

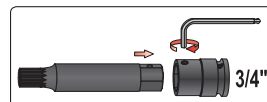

M12, M14, M16, M18 x 22 mm; (L=107 mm); CrMo;
3/4" (19.0 mm) x 22 mm; CrMo;

YATO		
YT-1157	3/4" (19.0 mm)	8

GB Impact bit socket set
D Schlagsteckschlüsselsatz
PL Zestaw udarowych kluczy trzpieniowych
RUS Набор ударных торцовых ключей
CZ Souprava rázových zástrčných klíčů
H Ütőthő dugókulcs bit készlet
RO Set chei de șoc cu bolt
F Set de douilles à choc
I Set di chiavi a bussola per percussione
E Juego de llaves de mandril de impacto
CN 风动套筒批头组套

6 PCS	3/4" 19mm		CrMo
-----------------	---------------------	--	-------------



METAL CASE & COLOR SLEEVE



M16, M18, T70, T80, T90, T100

YATO		
YT-10653	3/4" (19.0 mm)	10

GB Adaptor set
D Reduktionsset
PL Zestaw redukcji
RUS Редукционный комплект
CZ Redukční sada
H Adapter készlet
RO Set adaptoare
F Ensemble de réducteurs
I Riduttore per percussione
E Set de reductores
CN 件套 气动转换接头



6 PCS	CrV
-----------------	------------



3/8" (9.5 mm) (M) x 1/4" (6.3 mm) (F), 1/4" (6.3 mm) (M) x 3/8" (9.5 mm) (F), 3/8" (9.5 mm) (F) x 1/2" (12.7 mm) (M), 1/2" (12.7 mm) (F) x 3/8" (9.5 mm) (M), 3/4" (19.0 mm) (M) x 1/2" (12.7 mm) (F), 1/2" (12.7 mm) (M) x 3/4" (19.0 mm) (F)

YATO		
YT-10671		20

GB Impact universal joint set
D Kraft Kugelgelenk-Satz
PL Zestaw przegubów udarowych
RUS Кардан шарнирный ударный
CZ Univerzální závěsný konektor
H Univerzális csuklós csatlakozó
RO Set adaptoare
F Jeu de joints universels pour douilles pour clés à chocs
I Set di giunti a impatto
E Junta de impacto universal con encaje
CN 3件套 气动万向组套



3 PCS	1/2" 12.5mm	3/8" 10mm	1/4" 6.3mm	CrMo
-----------------	-----------------------	---------------------	----------------------	-------------

YATO				
YT-10643	1/2" (12.7 mm)	3/8" (9.5 mm)	1/4" (6.3 mm)	10/60

GB Impact wrench
D Druckluft-Schlagschrauber
PL Klucz pneumatyczny
RUS Ударный пневматический гайковерт
CZ Klíč pneumatický
H Pneumatikus ütvecsavarozó
RO Pistol pneumatic
F Clé à choc pneumatique
I Chiave ad impulsi pneumatica
E Llave neumática de percusión
CN 气动扳手

COLOR BOX





1/2" 12.5mm	TWIN HAMMER TYPE	0.63 MPa
119 l/min	550 Nm	7500 min ⁻¹
 STANDARD		

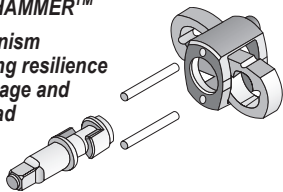

TWIN HAMMER™
mechanism
ensuring resilience
to damage and
overload



$L_{pa} = 92 \pm 3$ dB;
 $L_{wa} = 103 \pm 3$ dB;
 $a_p = 5,47 \pm 1,5$ m/s²

YATO 	Nm	
YT-09511	550	6

GB Impact wrench
D Druckluft-Schlagschrauber
PL Klucz pneumatyczny
RUS Ударный пневматический гайковерт
CZ Klíč pneumatický
H Pneumatikus ütvecsavarozó
RO Pistol pneumatic
F Clé à choc pneumatique
I Chiave ad impulsi pneumatica
E Llave neumática de percusión
CN 气动扳手

COLOR BOX





1/2" 12.5mm	TWIN HAMMER TYPE	0.63 MPa
142 l/min	570 Nm	10000 min ⁻¹
 STANDARD		

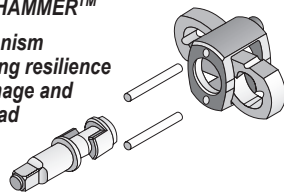

TWIN HAMMER™
mechanism
ensuring resilience
to damage and
overload



$L_{pa} = 90,7 \pm 3,0$ dB;
 $L_{wa} = 101,7 \pm 3,0$ dB;
 $a_p = 3,0 \pm 1,5$ m/s²

YATO 	Nm	
YT-09505	570	10

GB Impact wrench
D Druckluft-Schlagschrauber
PL Klucz pneumatyczny
RUS Ударный пневматический гайковерт
CZ Klíč pneumatický
H Pneumatikus ütvecsavarozó
RO Pistol pneumatic
F Clé à choc pneumatique
I Chiave ad impulsi pneumatica
E Llave neumática de percusión
CN 气动扳手

COLOR BOX





1/2" 12.5mm	SINGLE HAMMER TYPE	0.63 MPa
380 l/min	470 Nm	8500 min ⁻¹
 STANDARD		

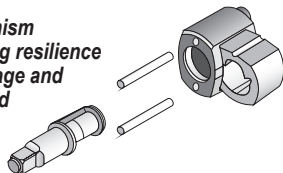

SINGLE HAMMER
mechanism
ensuring resilience
to damage and
overload



$L_{pa} = 92,5 \pm 3,0$ dB;
 $L_{wa} = 103,5 \pm 3,0$ dB;
 $a_p = 6,51 \pm 1,5$ m/s²

YATO 	Nm	
YT-09514	470	10

GB Impact wrench
D Druckluft-Schlagschrauber
PL Klucz pneumatyczny
RUS Ударный пневматический гайковерт
CZ Klíč pneumatický
H Pneumatikus ütvecsavarozó
RO Pistol pneumatic
F Clé à choc pneumatique
I Chiave ad impulsi pneumatica
E Llave neumática de percusión
CN 气动扳手

COLOR BOX





1/2" 12.5mm	SINGLE HAMMER TYPE	0.63 MPa
100 l/min	678 Nm	10000 min ⁻¹
 STANDARD		

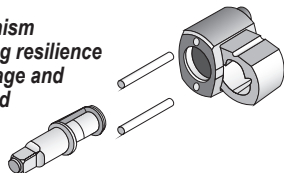

SINGLE HAMMER
mechanism
ensuring resilience
to damage and
overload



$L_{pa} = 97,4 \pm 3,0$ dB;
 $L_{wa} = 103,0 \pm 3,0$ dB;
 $a_p = 7,3 \pm 1,21$ m/s²

YATO 	Nm	
YT-09512	678	10

GB Impact wrench
D Druckluft-Schlagschrauber
PL Klucz pneumatyczny
RUS Ударный пневматический гайковерт
CZ Klíč pneumatický
H Pneumatikus ütvecsavarozó
RO Pistol pneumatic
F Clé à choc pneumatique
I Chiave ad impulsi pneumatica
E Llave neumática de percusión
CN 气动扳手

COLOR BOX



1/2"	TWIN HAMMER TYPE	0.63 MPa
12.5mm		
165 l/min	680 Nm	10000 min ⁻¹
STANDARD		



TWIN HAMMER™
mechanism
ensuring resilience
to damage and
overload

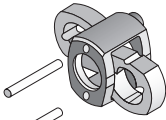

$L_{pA} = 94,0 \pm 3,0$ dB;
 $L_{pM} = 105,0 \pm 3,0$ dB;
 $a_p = 9,0 \pm 0,4$ m/s²

YATO	Nm	
YT-09513	680	10

GB Impact wrench
D Druckluft-Schlagschrauber
PL Klucz pneumatyczny
RUS Ударный пневматический гайковерт
CZ Klíč pneumatický
H Pneumatikus ütvecsavarozó
RO Pistol pneumatic
F Clé à choc pneumatique
I Chiave ad impulsi pneumatica
E Llave neumática de percusión
CN 气动扳手

COLOR BOX



1/2"	TWIN HAMMER TYPE	0.63 MPa
12.5mm		
184 l/min	680 Nm	7000 min ⁻¹
COMPOSITE BODY KOMPOZYTNIA OBUDOWA		
STANDARD		



TWIN HAMMER™
mechanism
ensuring resilience
to damage and
overload

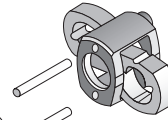

$L_{pA} = 95,0 \pm 3,0$ dB;
 $L_{pM} = 106,0 \pm 3,0$ dB;
 $a_p = 9,1 \pm 1,5$ m/s²

YATO	Nm	
YT-09524	680	5

GB Impact wrench
D Druckluft-Schlagschrauber
PL Klucz pneumatyczny
RUS Ударный пневматический гайковерт
CZ Klíč pneumatický
H Pneumatikus ütvecsavarozó
RO Pistol pneumatic
F Clé à choc pneumatique
I Chiave ad impulsi pneumatica
E Llave neumática de percusión
CN 气动扳手

COLOR BOX



1/2"	TWIN HAMMER TYPE	0.63 MPa
12.5mm		
350 l/min	600 Nm	9800 min ⁻¹
COMPOSITE BODY KOMPOZYTNIA OBUDOWA		
STANDARD		



TWIN HAMMER™
mechanism
ensuring resilience
to damage and
overload

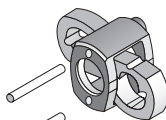

$L_{pA} = 93,1 \pm 3,0$ dB;
 $L_{pM} = 104,1 \pm 3,0$ dB;
 $a_p = 6,23 \pm 1,5$ m/s²

YATO	Nm	
YT-09506	600	10

GB Impact wrench
D Druckluft-Schlagschrauber
PL Klucz pneumatyczny
RUS Ударный пневматический гайковерт
CZ Klíč pneumatický
H Pneumatikus ütvecsavarozó
RO Pistol pneumatic
F Clé à choc pneumatique
I Chiave ad impulsi pneumatica
E Llave neumática de percusión
CN 气动扳手

COLOR BOX



1/2"	TWIN HAMMER TYPE	0.6-0.8 MPa
12.5mm		
119 l/min	850 Nm	7000 min ⁻¹
STANDARD		



TWIN HAMMER™
mechanism
ensuring resilience
to damage and
overload

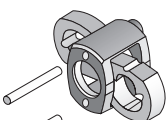

$L_{pA} = 92 \pm 3$ dB;
 $L_{pM} = 103 \pm 3$ dB;
 $a_p = 5,47 \pm 1,5$ m/s²

YATO	Nm	
YT-09525	850	6

GB Impact wrench
D Druckluft-Schlagschrauber
PL Klucz pneumatyczny
RUS Ударный пневматический гайковерт
CZ Klíč pneumatický
H Pneumatikus ütvecsavarozó
RO Pistol pneumatic
F Clé à choc pneumatique
I Chiave ad impulsi pneumatica
E Llave neumática de percusión
CN 气动扳手

COLOR BOX



1/2"
12.5mm

TWIN HAMMER TYPE

0.63 MPa

120 l/min

1000 Nm

6000 min⁻¹



TWIN HAMMER™
mechanism
ensuring resilience
to damage and
overload

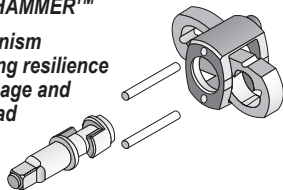

$L_{pa} = 92 \pm 3$ dB;
 $L_{wa} = 103 \pm 3$ dB;
 $a_s = 5,47 \pm 1,5$ m/s²

YATO	Nm	
YT-09528	1000	6

GB Impact wrench
D Druckluft-Schlagschrauber
PL Klucz pneumatyczny
RUS Ударный пневматический гайковерт
CZ Klíč pneumatický
H Pneumatikus ütvecsavarozó
RO Pistol pneumatic
F Clé à choc pneumatique
I Chiave ad impulsi pneumatica
E Llave neumática de percusión
CN 气动扳手

COLOR BOX



1/2"
12.5mm

TWIN HAMMER TYPE

0.63 MPa

500 l/min

850 Nm

6800 min⁻¹

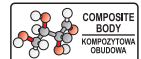

TWIN HAMMER™
mechanism
ensuring resilience
to damage and
overload

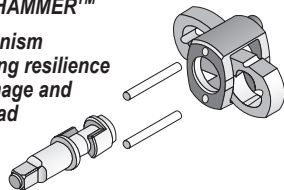

$L_{pa} = 93,1 \pm 3,0$ dB;
 $L_{wa} = 104,1 \pm 3,0$ dB;
 $a_s = 6,23 \pm 1,5$ m/s²

YATO	Nm	
YT-09531	850	10

GB Impact wrench
D Druckluft-Schlagschrauber
PL Klucz pneumatyczny
RUS Ударный пневматический гайковерт
CZ Klíč pneumatický
H Pneumatikus ütvecsavarozó
RO Pistol pneumatic
F Clé à choc pneumatique
I Chiave ad impulsi pneumatica
E Llave neumática de percusión
CN 气动扳手

COLOR BOX



1/2"
12.5mm

TWIN HAMMER TYPE

0.63 MPa

153 l/min

1356 Nm

10000 min⁻¹



TWIN HAMMER™
mechanism
ensuring resilience
to damage and
overload

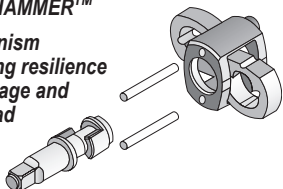

$L_{pa} = 93,7$ dB;
 $L_{wa} = 104,7$ dB;
 $a_s = 4,4 \pm 0,46$ m/s²

YATO	Nm	
YT-0953	1356	10

GB Impact wrench
D Druckluft-Schlagschrauber
PL Klucz pneumatyczny
RUS Ударный пневматический гайковерт
CZ Klíč pneumatický
H Pneumatikus ütvecsavarozó
RO Pistol pneumatic
F Clé à choc pneumatique
I Chiave ad impulsi pneumatica
E Llave neumática de percusión
CN 气动扳手

COLOR BOX



1/2"
12.5mm

TWIN HAMMER TYPE

0.63 MPa

153 l/min

1150 Nm

10000 min⁻¹

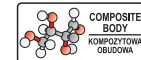

TWIN HAMMER™
mechanism
ensuring resilience
to damage and
overload

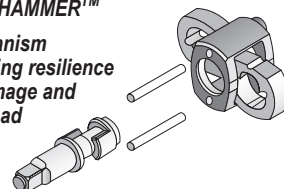

$L_{pa} = 93,7 \pm 3,1$ dB;
 $L_{wa} = 104,7 \pm 3,1$ dB;
 $a_s = 4,4 \pm 0,4$ m/s²

YATO	Nm	
YT-09540	1150	10

GB Impact wrench
D Druckluft-Schlagschrauber
PL Klucz pneumatyczny
RUS Ударный пневматический гайковерт
CZ Klíč pneumatický
H Pneumatikus ütvecsavarozó
RO Pistol pneumatic
F Clé à choc pneumatique
I Chiave ad impulsi pneumatica
E Llave neumática de percusión
CN 气动扳手

COLOR BOX



3/4" 19mm	TWIN HAMMER TYPE	0.63 MPa
660 l/min	1300 Nm	5000 min ⁻¹
		3/8" 10mm



TWIN HAMMER™
mechanism
ensuring resilience
to damage and
overload

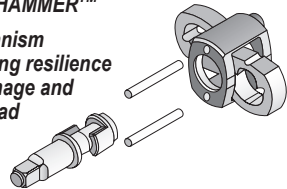

$L_{pA} = 92 \pm 3$ dB;
 $L_{pM} = 103 \pm 3$ dB;
 $a_p = 5,47 \pm 1,5$ m/s²

YATO	Nm	
YT-09564	1300	4

GB Impact wrench
D Druckluft-Schlagschrauber
PL Klucz pneumatyczny
RUS Ударный пневматический гайковерт
CZ Klíč pneumatický
H Pneumatikus ütvecsavarozó
RO Pistol pneumatic
F Clé à choc pneumatique
I Chiave ad impulsi pneumatica
E Llave neumática de percusión
CN 气动扳手

COLOR BOX



3/4" 19mm	TWIN HAMMER TYPE	0.63 MPa
198 l/min	1630 Nm	5500 min ⁻¹
		3/8" 10mm



TWIN HAMMER™
mechanism
ensuring resilience
to damage and
overload

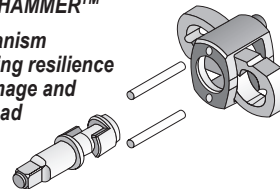

$L_{pA} = 100,6 \pm 3,0$ dB;
 $L_{pM} = 111,6 \pm 3,0$ dB;
 $a_p = 10,21 \pm 1,5$ m/s²

YATO	Nm	
YT-09571	1630	6

GB Pneumatic wrench
D Druckluft-Schlüssel
PL Klucz pneumatyczny
RUS Пневматический ключ
CZ Pneumatický utahovák
H Pneumatikus kulcs
RO Cheie pneumatica

F Clé à choc pneumatique
I Chiave ad impulsi pneumatica
E Llave neumática
CN 气动扳手

PINLESS HAMMER™
closed hammer
cage mechanism
prevents breakage
from hammer
pin damage



- application: automotive service stations, trucks
- strong, uniform impact
- przeznaczenie: serwis, samochody ciężarowe
- silny, jednolity uder



$L_{pA} = 99,7 \pm 1,0$ dB;
 $L_{pM} = 110,4 \pm 1,0$ dB;
 $a_p = 24,16 \pm 1,74$ m/s²

BMC & COLOR SLEEVE

YATO	Nm	
YT-0959	2600	2

GB Pneumatic wrench
D Druckluft-Schlüssel
PL Klucz pneumatyczny
RUS Пневматический ключ
CZ Pneumatický utahovák
H Pneumatikus kulcs

RO Cheie pneumatica
F Clé à choc pneumatique
I Chiave ad impulsi pneumatica
E Llave neumática
CN 气动扳手

PINLESS HAMMER™
closed hammer
cage mechanism
prevents breakage
from hammer
pin damage



- application: automotive service stations, trucks
- strong, uniform impact
- przeznaczenie: serwis, samochody ciężarowe
- silny, jednolity uder



$L_{pA} = 99,7 \pm 1,0$ dB;
 $L_{pM} = 110,4 \pm 1,0$ dB;
 $a_p = 24,16 \pm 1,74$ m/s²

BMC & COLOR SLEEVE

YATO	Nm	
YT-0960	2600	2

- GB Pneumatic wrench
D Druckluft-Schlüssel
PL Klucz pneumatyczny
RUS Пневматический ключ
CZ Pneumatický utahovák
RO Cheie pneumatica
F Clé à choc pneumatique
I Chiave ad impulsi pneumatica
E Llave neumática
CN 气动扳手



COLOR BOX



1" 25mm	TWIN HAMMER TYPE	0.63 MPa	255 l/min
8.3kg ULTRA LIGHT	2700 Nm	4800 min ⁻¹	1/2" 12.5mm
STANDARD		COMPOSITE BODY KOMPOZYTYWNA OBUDOWA	

- application: industry, service stations, tire service stations, truck service
- the lightest 1" impact wrench with torque of 2700 Nm
- magnesium alloy and composite housing
- low vibration
- low air consumption

- przeznaczenie: przemysł, serwisy mobilne i stacjonarne, serwisy opon oraz pojazdów ciężarowych
- najlżejszy klucz pneumatyczny w klasie 1" o mocy 2700 Nm
- obudowa ze stopów magnezu i kompozytu
- niski poziom vibracji
- małe zużycie powietrza

L_{pa} = 93,6 ± 3,0 dB;
L_{wa} = 104,6 ± 3,0 dB;
a_{wa} = 5,0 / 1,5 / 8,6 ± 1,5 m/s²

YATO	Nm	
YT-09611	2700	2

- GB Pneumatic wrench
D Druckluft-Schlüssel
PL Klucz pneumatyczny
RUS Пневматический ключ
CZ Pneumatický utahovák
H Pneumatikus kulcs
- RO Cheie pneumatica
F Clé à choc pneumatique
I Chiave ad impulsi pneumatica
E Llave neumática
CN 气动扳手



PINLESS HAMMER™

closed hammer
cage mechanism
prevents breakage
from hammer
pin damage



BMC
& COLOR
SLEEVE



L_{pa} = 97,1 ± 3,0 dB;
L_{wa} = 108,1 ± 3,0 dB;
a_{wa} = 13,750 ± 1,5 m/s²

YATO	Nm	
YT-09615	3200	1

- GB 3 in 1 air combo kit
D Druckluft-Satz 3 in 1
PL Zestaw pneumatyczny 3 w 1
RUS Пневматический набор 3 в 1
CZ Pneumatická sada 3 v 1
H 3 az 1-ben pneumatikus készlet
RO Kit aer comprimtat, 3 in 1
F Ensemble pneumatique 3 en 1
I Kit di utensili pneumatici 3 in 1
E Set neumático 3 en 1
CN 棘板风磨三合一工具

L_{pa} = 88 ± 3 dB;
L_{wa} = 99 ± 3 dB;
a_{wa} = 3,95 ± 1,5 m/s²



3 in 1



1/2" 12.5mm	0.63 MPa	113 l/min	85 Nm
180 min ⁻¹	15000 min ⁻¹	18000 min ⁻¹	Ø 6mm
STANDARD		STANDARD	

BMC
& COLOR
SLEEVE



YATO	Nm	
YT-09860	85	10

- GB Ratchet air wrench
D Druckluft-Ratschenschrauber
PL Grzechotka pneumatyczna
RUS Пневмотрещотка
CZ Utahovák vzduchový
H Préslevegős behajtó szerszám
RO Antrenor pneumatic
F Clé à cliquet pneumatique
- I Chiave a cricchetto pneumatica
E Carraca neumática
CN 气动棘轮扳手

1/4" 6.3mm	0.63 MPa	113 l/min	27 Nm
180 min ⁻¹	360° ROTOR MOTOR OBROTOWY WYKONCZY POMIĘDZY	SPEED REGULATOR REGULACJA PRĘDKOŚCI	0.5kg ULTRA LIGHT ULTRALEKKA
STANDARD		COMPOSITE BODY KOMPOZYTYWNA OBUDOWA	



L_{pa} = 96 ± 3 dB;
L_{wa} = 107 ± 3 dB;
a_{wa} = 3,1 ± 1,5 m/s²

COLOR
BOX



YATO	Nm	
YT-09795	27	20

ULTRA LIGHT

- GB Ratchet air wrench
D Druckluft-Ratschenschrauber
PL Grzechotka pneumatyczna
RUS Пневмотрещотка
CZ Utahovák vzduchový
H Préslevegős behajtó szerszám
RO Antrenor pneumatic
F Clé à cliquet pneumatique
- I Chiave a cricchetto pneumatica
E Carraca neumática
CN 气动棘轮扳手

1/2" 12.5mm	0.63 MPa	142 l/min	80 Nm
160 min ⁻¹	360° ROTOR MOTOR OBROTOWY WYKONCZY POMIĘDZY	SPEED REGULATOR REGULACJA PRĘDKOŚCI	1.4kg ULTRA LIGHT ULTRALEKKA
STANDARD		COMPOSITE BODY KOMPOZYTYWNA OBUDOWA	



L_{pa} = 94 ± 3 dB;
L_{wa} = 105 ± 3 dB;
a_{wa} = 2,6 ± 1,5 m/s²

COLOR
BOX



YATO	Nm	
YT-09803	80	12

ULTRA LIGHT

GB Ratchet air wrench
D Druckluft-Ratschenschrauber
PL Grzechotka pneumatyczna
RUS Пневмотрещотка
CZ Utahovák vzduchový
H Préslevegős behajtó szerszám
RO Antrenor pneumatic

F Clé à cliquet pneumatique
I Chiave a cricchetto pneumatica
E Carraca neumática
CN 气动棘轮扳手

1/2"	0.63 MPa	85 l/min
12.5mm		
80 Nm	200 min ⁻¹	STANDARD



COLOR BOX

YATO	Nm	
YT-0980	80	12

L_{pa} = 84,5 ± 3,0 dB;
L_{wa} = 95,5 ± 3,0 dB;
a₁ = 4,711 ± 1,5 m/s²

GB Ratchet air wrench
D Druckluft-Ratschenschrauber
PL Grzechotka pneumatyczna
RUS Пневмотрещотка
CZ Utahovák vzduchový
H Préslevegős behajtó szerszám
RO Antrenor pneumatic

F Clé à cliquet pneumatique
I Chiave a cricchetto pneumatica
E Carraca neumática
CN 气动棘轮扳手

1/2"	0.62 MPa	120 l/min
12.5mm		
80 Nm	160 min ⁻¹	STANDARD



COLOR BOX

YATO	Nm	
YT-0981	80	20

L_{pa} = 85,2 ± 0,5 dB;
L_{wa} = 96,2 ± 0,5 dB;
a₁ = 12,78 ± 0,52 m/s²

GB Ratchet air wrench
D Druckluft-Ratschenschrauber
PL Grzechotka pneumatyczna
RUS Пневмотрещотка
CZ Utahovák vzduchový
H Préslevegős behajtó szerszám

RO Antrenor pneumatic
F Clé à cliquet pneumatique
I Chiave a cricchetto pneumatica
E Carraca neumática
CN 气动棘轮扳手

1/2"	0.62 MPa	110 l/min	68 Nm	160 min ⁻¹	STANDARD
12.5mm					



COLOR BOX

YATO	Nm	
YT-0980	68	20

L_{pa} = 85,2 ± 0,5 dB;
L_{wa} = 96,2 ± 0,5 dB;
a₁ = 12,78 ± 0,52 m/s²

GB Ratchet wrench kit
D Druckluft-Ratschenschrauber mit Zubehör
PL Zestaw z grzechotką pneumatyczną
RUS Пневмотрещотка в наборе
CZ Klíč ráčnový pneumatický s příslušenstvom
H Pneumatikus racszükszám készlet
RO Cheie pneumatica cu accesorii
F Clé à cliquet pneumatique
I Chiave a cricchetto pneumatica
E Juego con carraca neumática
CN 气动棘轮扳手套

1/2"	OILER POT	0.62 MPa	110 l/min
12.5mm			
68 Nm	160 min ⁻¹	STANDARD	CrV



L_{pa} = 93,1 ± 1,9 dB;
L_{wa} = 104,4 ± 2,7 dB;
a₁ = 19,98 ± 2,47 m/s²

- 1/2" (12.7 mm), L=75 mm;
- 6 mm x 1/2" (12.7 mm);
- 1/2" (12.7 mm);
- H4, H5, H6, H7, H8;
- T20, T25, T27, T30, T40;
- 5,5, 6,5, 8,0 mm;
- PH2, PH3, PH4;
- 10, 11, 12, 13, 14, 17, 19 mm

BMC & COLOR SLEEVE

YATO	Nm	
YT-0982	68	4

GB Air grinder
D Drucklufterhandschleifer
PL Szlifierka pneumatyczna prosta
RUS Шлифмашинка пневматическая
CZ Bruska přímá pneumatická
H Pneumatikus egyenescsiszoló
RO Polizor pneumatic
F Mini ponçeuse pneumatique
I Smerigliatrice dritta pneumatica
E Lijadora neumática recta
CN 气动修磨机

0.62 MPa	160 l/min	20000 min ⁻¹	3 6 mm	STANDARD
----------	-----------	-------------------------	--------	----------



COLOR BOX

YATO		
YT-0965		25

L_{pa} = 86,3 ± 0,7 dB;
L_{wa} = 97,3 ± 0,7 dB;
a₁ = 0,97 ± 0,19 m/s²

GB Air grinder
D Drucklufterhandschleifer
PL Szlifierka pneumatyczna prosta
RUS Шлифмашинка пневматическая
CZ Bruska přímá pneumatická
H Pneumatikus egyenescsiszoló
RO Polizor pneumatic
F Mini ponçeuse pneumatique
I Smerigliatrice dritta pneumatica
E Lijadora neumática recta
CN 气动修磨机

0.63 MPa	113 l/min	ADJUSTABLE SPEED REGULATOR REGULACJA PRĘDKOŚCI
25000 min ⁻¹	6 mm	
COMPOSITE BODY KOMPOZYTYWNA OBLUDOWA	REAR AIR EXHAUST CAN BE ROTATED 360° MOŻLIWOŚĆ USTAWIENIA WYDMUCHU POWIETRZA O 360°	STANDARD



COLOR BOX

YATO		
YT-09632		20

L_{pa} = 88,0 ± 3,0 dB;
L_{wa} = 99,0 ± 3,0 dB;
a₁ = 2,9 ± 1,5 m/s²

GB Air grinder
D Drucklufterhandschleifer
PL Szlifierka pneumatyczna prosta
RUS Шлифмашинка пневматическая
CZ Bruska přímá pneumatická
H Pneumatikus egyenescsiszoló
RO Polizor pneumatic
F Mini ponçeuse pneumatique
I Smerigliatrice dritta pneumatica
E Lijadora neumática recta
CN 气动修磨机

0.63 MPa	113 l/min	25000 min ⁻¹	6 mm	0.33kg	ULTRA LIGHT ULTRALEKKI	STANDARD
360° ROTATED AIR EXHAUST POWIERZA	SPEED REGULATOR REGULACJA PRĘDKOŚCI	COMPOSITE BODY KOMPOZYTYWNA OBLUDOWA				



COLOR BOX

YATO		
YT-09633		40

L_{pa} = 97,0 ± 3,0 dB;
L_{wa} = 108,0 ± 3,0 dB;
a₁ = 0,9 ± 1,5 m/s²

ULTRA LIGHT

GB Pneumatic angle grinder
D Ruckluft-Winkelschleifer
PL Szlifierka kątowna pneumatyczna
RUS Пневматическая угловая шлифовальная машина
CZ Pneumatiké úhlovou brusku
H Pneumatikus sarokcsiszoló

RO Polizor unghiular pneumatic
F Pneumatique meuleuse d'angle
I Smerglatrice angolare pneumatica
E Amoladora angular neumática
CN 气动角磨

0.63 MPa
141 l/min
11000 min⁻¹
M10







COLOR BOX

YATO 
YT-09675 8

$L_{pa} = 87 \pm 3$ dB;
 $L_{wa} = 98 \pm 3$ dB;
 $a_p = 3,4 \pm 1,5$ m/s²

GB Pneumatic angle grinder
D Ruckluft-Winkelschleifer
PL Szlifierka kątowna pneumatyczna
RUS Пневматическая угловая шлифовальная машина
CZ Pneumatiké úhlovou brusku
H Pneumatikus sarokcsiszoló
RO Polizor unghiular pneumatic
F Pneumatique meuleuse d'angle

I Smerglatrice angolare pneumatica
E Amoladora angular neumática
CN 气动角磨

0.63 MPa
113 l/min
20000 min⁻¹
6 mm
0.48kg ULTRA LIGHT ULTRALEKKI

125mm
360°
SPEED REGULATOR REGULACJA PRĘDKOŚCI
COMPOSITE BODY KOMPOZYTOWA OBLUDOWA



COLOR BOX

YATO 
YT-09676 30

$L_{pa} = 92,9 \pm 3,0$ dB;
 $L_{wa} = 103,9 \pm 3,0$ dB;
 $a_p = 1,4 \pm 1,5$ m/s²

ULTRA LIGHT 

GB Air sander
D Druckluft-Excenterschleifer
PL Szlifierka pneumatyczna mimośrodowa
RUS Шлифмашина эксцентриковая пневматическая
CZ Bruska pneumatická
H Pneumatikus polírozó
RO Masina de slefuit pneumatica
F Ponceuse pneumatique
I Smerglatrice orbitale pneumatica
E Lijadora neumática excéntrica
CN 气动砂磨机

0.63 MPa
113 l/min
20000 min⁻¹
50 mm
2.5 mm
ECCENTRIC MIMOŚRODOWY

SPEED REGULATOR REGULACJA PRĘDKOŚCI
0.65kg ULTRA LIGHT ULTRALEKKI
COMPOSITE BODY KOMPOZYTOWA OBLUDOWA



COLOR BOX

YATO 
YT-09730 20

$L_{pa} = 87 \pm 3$ dB;
 $L_{wa} = 98 \pm 3$ dB;
 $a_p = 2,3 \pm 2,5$ m/s²

ULTRA LIGHT 

GB Air sander
D Druckluft-Excenterschleifer
PL Szlifierka pneumatyczna mimośrodowa
RUS Шлифмашина эксцентриковая пневматическая
CZ Bruska pneumatická
H Pneumatikus polírozó
RO Masina de slefuit pneumatica
F Ponceuse pneumatique
I Smerglatrice orbitale pneumatica
E Lijadora neumática excéntrica
CN 气动砂磨机

0.62 MPa
230 l/min
9000 min⁻¹
150 mm
2.5 mm
ECCENTRIC MIMOŚRODOWY

SPEED REGULATOR REGULACJA PRĘDKOŚCI
0.65kg ULTRA LIGHT ULTRALEKKI
COMPOSITE BODY KOMPOZYTOWA OBLUDOWA



COLOR BOX

YATO 
YT-0967 10

$L_{pa} = 89,9 \pm 0,7$ dB;
 $L_{wa} = 100,9 \pm 0,7$ dB;
 $a_p = 3,31 \pm 1,10$ m/s²

GB Air sander
D Druckluft-Excenterschleifer
PL Szlifierka pneumatyczna mimośrodowa
RUS Шлифмашина эксцентриковая пневматическая
CZ Bruska pneumatická
H Pneumatikus polírozó
RO Masina de slefuit pneumatica
F Ponceuse pneumatique
I Smerglatrice orbitale pneumatica
E Lijadora neumática excéntrica
CN 气动砂磨机

0.63 MPa
84 l/min
10500 min⁻¹
150 mm
2.5 mm
ECCENTRIC MIMOŚRODOWY

VACUUM SYSTEM SYSTEM ODPYLANIA



COLOR BOX

YATO 
YT-09740 10

$L_{pa} = 90 \pm 3$ dB;
 $L_{wa} = 101 \pm 3$ dB;
 $a_p = 4,4 \pm 2,5$ m/s²



GB Air sander
D Druckluft-Excenterschleifer
PL Szlifierka pneumatyczna mimośrodowa
RUS Шлифмашина эксцентриковая пневматическая
CZ Bruska pneumatická
H Pneumatikus polírozó
RO Masina de slefuit pneumatica
F Ponceuse pneumatique
I Smerglatrice orbitale pneumatica
E Lijadora neumática excéntrica
CN 气动砂磨机

0.63 MPa
84 l/min
12000 min⁻¹
150 mm
2.5 mm
ECCENTRIC MIMOŚRODOWY

SPEED REGULATOR REGULACJA PRĘDKOŚCI
0.65kg ULTRA LIGHT ULTRALEKKI
COMPOSITE BODY KOMPOZYTOWA OBLUDOWA



COLOR BOX

YATO 
YT-09739 10

$L_{pa} = 90 \pm 3$ dB;
 $L_{wa} = 101 \pm 3$ dB;
 $a_p = 4,4 \pm 2,5$ m/s²

GB Air belt sander
D Pneumatische Bandschleifer
PL Pneumatyczna szlifierka taśmowa
RUS Пневматический шлифовальный
CZ Pneumatická pásová bruska
H Pneumatikus szalagcsiszoló
RO Polizor pneumatic cu banda
F Ponceuse à bandes pneumatique
I Nastro per levigatrice pneumatica
E Lijadora de banda neumática
CN 气动砂带机



170
l/min

0.63
MPa

20000
min⁻¹

EASY BELT
REPLACEMENT
LATAWA WYMIANA
PASA

STANDARD



includes belts: /
w zestawie pasy:
P60, P80, P120

COLOR BOX

$L_{pa} = 93 \pm 3$ dB;
 $L_{ma} = 104 \pm 3$ dB;
 $a_s = 4,8 \pm 1,5$ m/s²

YATO	belt size / rozmiar pasa (mm)	
YT-09741	10x330	10

GB Air belt sander
D Pneumatische Bandschleifer
PL Pneumatyczna szlifierka taśmowa
RUS Пневматический шлифовальный
CZ Pneumatická pásová bruska
H Pneumatikus szalagcsiszoló
RO Polizor pneumatic cu banda
F Ponceuse à bandes pneumatique
I Nastro per levigatrice pneumatica
E Lijadora de banda neumática
CN 气动砂带机



200
l/min

0.63
MPa

20000
min⁻¹

EASY BELT
REPLACEMENT
LATAWA WYMIANA
PASA

STANDARD



includes belts: /
w zestawie pasy:
P60, P80, P120

COLOR BOX

$L_{pa} = 93 \pm 3$ dB;
 $L_{ma} = 104 \pm 3$ dB;
 $a_s = 4,8 \pm 1,5$ m/s²

YATO	belt size / rozmiar pasa (mm)	
YT-09742	20x520	10

GB Endless sanding belt
D Schleifband
PL Taśma ścierna bezkońcowa

RUS Шлифовальные ленты
CZ Brusný pás
H Csiszoló szalag

RO Bandă de pânză
F Bande abrasive sans fin
I Nastro abrasivo senza fine

E Pano abrasivo cinturón
CN 砂带

HANGING
COLOR BOX

- application: metal, wood
- abrasive: aluminium oxide
- bond: synthetic resin
- coating: close
- zastosowanie: metal, drewno
- ścierniwo: tlenek glinu
- spoiwo: żywica syntetyczna
- nasyp pełny

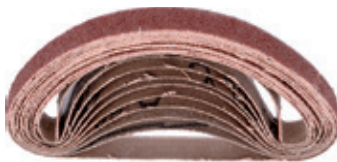

- application: metal, wood
- abrasive: aluminium oxide
- bond: synthetic resin
- coating: close
- zastosowanie: metal, drewno
- ścierniwo: tlenek glinu
- spoiwo: żywica syntetyczna
- nasyp pełny

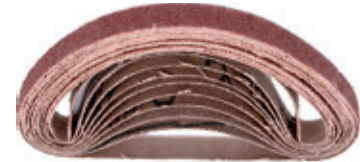

YATO	grit / ziarnistość	size / rozmiar (mm)	PCS packing	
YT-09743	60	10x330	10	100
YT-09744	80	10x330	10	100
YT-09745	100	10x330	10	100
YT-09746	120	10x330	10	100

YATO	grit / ziarnistość	size / rozmiar (mm)	PCS packing	
YT-09747	60	20x520	10	50
YT-09748	80	20x520	10	50
YT-09749	100	20x520	10	50
YT-09750	120	20x520	10	50

GB Air cut-off tool
D Druckluft-Schneidmaschine
PL Przecinarka pneumatyczna
RUS Резак пневматический
CZ Příčná bruska pneumatická
H Pneumatikus sarokcsiszoló

RO Masina de taiat
cu aer comprimat
F Coupeuse pneumatique
I Fresa pneumatica
E Cortadora neumática
CN 气动切割工具

0.62
MPa

480
l/min

18000
min⁻¹

75mm
9.4mm

STANDARD



COLOR
BOX

$L_{pa} = 92,9 \pm 0,9$ dB;
 $L_{ma} = 103,9 \pm 0,9$ dB;
 $a_s = 3,43 \pm 0,25$ m/s²

YATO	
YT-0993	20

GB Air cut-off tool
D Druckluft-Schneidmaschine
PL Przecinarka pneumatyczna
RUS Резак пневматический
CZ Příčná bruska pneumatická
H Pneumatikus sarokcsiszoló

RO Masina de taiat
cu aer comprimat
F Coupeuse pneumatique
I Fresa pneumatica
E Cortadora neumática
CN 气动切割工具

0.63
MPa

127
l/min

20000
min⁻¹

75mm
9.5mm

STANDARD



COLOR
BOX

$L_{pa} = 77,0 \pm 3,0$ dB;
 $L_{ma} = 88,0 \pm 3,0$ dB;
 $a_s = 2,38 \pm 1,5$ m/s²

YATO	
YT-09715	10

GB Air cut-off tool
D Druckluft-Schneidmaschine
PL Przecinarka pneumatyczna
RUS Резак пневматический
CZ Příčná bruska pneumatická
H Pneumatikus sarokcsiszoló
RO Masina de taiat
cu aer comprimat
F Coupeuse pneumatique
I Fresa pneumatica
E Cortadora neumática
CN 气动切割工具



0.63
MPa

481
l/min

20000
min⁻¹

76mm
9.5mm

STANDARD

COLOR
BOX

$L_{pa} = 91,7 \pm 3,0$ dB;
 $L_{ma} = 102,7 \pm 3,0$ dB;
 $a_s = 4,67 \pm 1,5$ m/s²

YATO	
YT-09716	12

- GB** Air cut-off tool
D Druckluft-Schneidmaschine
PL Przecinarka pneumatyczna
RUS Резак пневматический
CZ Příčná bruska pneumatická
H Pneumatikus sarokcsiszoló
RO Masina de taiat cu aer comprimat
F Coupeuse pneumatique
I Fresa pneumatica
E Cortadora neumática
CN 气动切割工具

0.8 MPa	170 l/min	18000 min⁻¹	360° 360° SZERES KÖRNYELV CÍRIGYON HÍZGATÓ FÖRTÉK	SPEED REGULATOR REGULACIJA PREDKOSCI
0.7 kg ULTRA LIGHT ULTRALEKKA	75 mm	9.5 mm	COMPOSITE BODY KOMPÓZITÓVA SZERKEZET	STANDARD



L_{pa} = 90.0 ± 3.0 dB;
L_{wa} = 101.0 ± 3.0 dB;
a_{wa} = 1.2 ± 1.5 m/s²

ULTRA LIGHT

COLOR BOX

YATO	
YT-09717	20

- GB** Metal cutting disc
D Metall-Trennscheibe
PL Tarcza do cięcia metalu
RUS Круги отрезные по металлу
CZ Souprava kotočů pro řezání kovu
H Vágókorong fémhez
RO Set de pânze de taiat metal
F Set de disques
I Disco per taglio metallo
E Disco cortador para metal
CN 金属切割片组套

5 PCS
18000 min⁻¹
75 mm
2 mm
9.5 mm



YATO	
YT-0994	12/48

for / dla: YT-0993

- GB** Air body saw
D Luft Körper Säge
PL Wyrzynarka pneumatyczna
RUS Пила пневматическая сабельная
CZ Pilka pneumatická na plech
H Pneumatikus kardfűrész
RO Fierastrau pneumatic
F Scie sabre pneumatique
I Sega da traforo
E Sierra neumática
CN 气锯

0.63 MPa	170 l/min	9000 min⁻¹	STANDARD
-----------------	------------------	------------------------------	-----------------



L_{pa} = 78 ± 3 dB;
L_{wa} = 89 ± 3 dB;
a_{wa} = 23 ± 1.5 m/s²

COLOR BOX

YATO	
YT-09955	20

- GB** Jig saw blades
D Stichsägeblätter
PL Brzeczoty do wyrzynarki
RUS Полотно для станка
CZ Pilový list do přímoharé pily
H Dekopírlap
RO Lama fierastrau pendular
F Lame pour scie sauteuse
I Lame per seghetti pneumatici
E Recambio sierra de calar
CN 锯片

5 PCS



for / dla: YT-09955

YATO	TPI	
YT-09958	24	50/200
YT-09959	32	50/200

- GB** Air shears pistol type
D Pneumatische Schere
PL Nożyce pneumatyczne kątowe
RUS Пневматические ножницы угловые
CZ Pneumatické nůžky na plech
H Pneumatikus ollók
RO Foarfeca pneumatica
F Cisailles pneumatiques
I Cesoia pneumatica angolare
E Tijera neumática
CN 气动剪刀

0.63 MPa	141 l/min
1800 min⁻¹	5.5 mm
1.2 STEEL STAL	1.4 AL
STANDARD	



L_{pa} = 80 ± 3 dB;
L_{wa} = 91 ± 3 dB;
a_{wa} = 6.5 ± 1.5 m/s²



YATO	
YT-09944	10

- GB** Air shears
D Pneumatische Schere
PL Nożyce pneumatyczne proste
RUS Пневматические ножницы прямые
CZ Pneumatické nůžky na plech
H Pneumatikus ollók
RO Foarfeca pneumatica
F Cisailles pneumatiques
I Cesoia pneumatica dritta
E Tijera neumática
CN 气动剪刀

0.63 MPa	141 l/min
2500 min⁻¹	5.5 mm
1.2 STEEL STAL	1.4 AL
STANDARD	



YATO	
YT-09945	15

L_{pa} = 90 ± 3 dB;
L_{wa} = 101 ± 3 dB;
a_{wa} = 4.6 ± 1.5 m/s²

GB Reversible air drill
D Druckluft-Bohrmaschine mit Stahl-Zahnkranzfutter
PL Wiertarka pneumatyczna
RUS Пневматическая дрель
CZ Vrtačka ruční vzduchová
H Pneumatikus fúró
RO Masina de gaurit pneumatica mandrina

F Perceuse pneumatique
I Fresa pneumatica
E Taladradora neumática
CN 双向气钻

0.62 MPa **180 l/min** **0-1800 min⁻¹**
max. 10mm
STANDARD



COLOR BOX

YATO
YT-0970 20

$L_{pa} = 90.2 \pm 0.8$ dB;
 $L_{wa} = 101.2 \pm 0.8$ dB;
 $a_s = 0.88 \pm 0.04$ m/s²

GB Reversible air drill
D Druckluft-Bohrmaschine mit Stahl-Zahnkranzfutter
PL Wiertarka pneumatyczna
RUS Пневматическая дрель
CZ Vrtačka ruční vzduchová
H Pneumatikus fúró

RO Masina de gaurit pneumatica mandrina
F Perceuse pneumatique
I Fresa pneumatica
E Taladradora neumática
CN 双向气钻

1.7 kg **0.63 MPa** **198 l/min**
700 min⁻¹ **max. 10mm**
STANDARD



$L_{pa} = 89.7 \pm 3.0$ dB;
 $L_{wa} = 100.7 \pm 3.0$ dB;
 $a_s = 0.89 \pm 1.5$ m/s²



COLOR BOX

YATO
YT-09702 12

GB Reversible air drill
D Druckluft-Bohrmaschine mit Stahl-Zahnkranzfutter
PL Wiertarka pneumatyczna
RUS Пневматическая дрель
CZ Vrtačka ruční vzduchová
H Pneumatikus fúró

RO Masina de gaurit pneumatica mandrina
F Perceuse pneumatique
I Fresa pneumatica
E Taladradora neumática
CN 双向气钻

0.63 MPa **141 l/min** **20000 min⁻¹**
max. 10mm **360°** **SPEED REGULATOR REGULACJA PREDKOŚCI**
0.66 kg ULTRA LIGHT ULTRALEKKI **COMPOSITE BODY KOMPONENTOWA OBUDOWA**
STANDARD



$L_{pa} = 92.0 \pm 3.0$ dB;
 $L_{wa} = 103.0 \pm 3.0$ dB;
 $a_s = 6.2 \pm 1.5$ m/s²

COLOR BOX

YATO
YT-09695 20

ULTRA LIGHT

GB Reversible air drill
D Druckluft-Bohrmaschine mit Stahl-Zahnkranzfutter
PL Wiertarka pneumatyczna
RUS Пневматическая дрель
CZ Vrtačka ruční vzduchová
H Pneumatikus fúró

RO Masina de gaurit pneumatica mandrina
F Perceuse pneumatique
I Fresa pneumatica
E Taladradora neumática
CN 双向气钻

0.63 MPa **113 l/min** **1800 min⁻¹**
max. 10mm **0.9 kg ULTRA LIGHT ULTRALEKKI**
COMPOSITE BODY KOMPONENTOWA OBUDOWA
STANDARD



$L_{pa} = 98.0 \pm 3.0$ dB;
 $L_{wa} = 109.0 \pm 3.0$ dB;
 $a_s = 2.8 \pm 1.5$ m/s²

COLOR BOX

YATO
YT-09703 10

ULTRA LIGHT

GB Air hammer
D Druckluft-Schlaghammer
PL Młotek pneumatyczny
RUS Зубило пневматическое
CZ Sekáč vzduchový
H Pneumatikus vésőkészlet pisztollyal

RO Ciocan pneumatic
F Marteau pneumatique
I Martello pneumatica
E Martillo neumático
CN 气锤

0.62 MPa **113 l/min** **3200 min⁻¹**
STANDARD



$L_{pa} = 100.3 \pm 0.4$ dB;
 $L_{wa} = 107.7 \pm 0.4$ dB;
 $a_s = 5.37 \pm 0.12$ m/s²

COLOR BOX

YATO
YT-0990 10

GB Air hammer
D Druckluft-Schlaghammer
PL Młotek pneumatyczny
RUS Зубило пневматическое
CZ Sekáč vzduchový
H Pneumatikus vésőkészlet pisztollyal

RO Ciocan pneumatic
F Marteau pneumatique
I Martello pneumatica
E Martillo neumático
CN 气锤

0.63 MPa **85 l/min**
3500 min⁻¹ **STANDARD**



$L_{pa} = 94.3 \pm 3$ dB;
 $L_{wa} = 105.3 \pm 3$ dB;
 $a_s = 29.67 \pm 1.5$ m/s²

COLOR BOX

YATO
YT-09903 12

GB Air hammer
D Druckluft-Schlaghammer
PL Młotek pneumatyczny
RUS Зубило пневматическое
CZ Sekáč vzduchový
H Pneumatikus vésőkészlet pisztollyal

RO Ciocan pneumatic
F Marteau pneumatique
I Martello pneumatica
E Martillo neumático
CN 气锤

0.63 MPa
113 l/min
4500 min⁻¹
0.95 kg
ULTRA LIGHT
ULTRALEKKI
COMPOSITE BODY
KOMPOZITOWA
CIELODZIA
STANDARD



ULTRA LIGHT

L_{pa} = 95 ± 3 dB;
L_{wa} = 106 ± 3 dB;
a_w = 20 ± 4.5 m/s²

YATO
YT-09904 10

GB Air needle scaler
D Luft-Nadel-Scaler
PL Pneumatyczny młotek igłowy
RUS Пневматический игольчатый отбойник
CZ Vzduchový jehlový škrabák
H Pneumatikus tűs rozsdaleverő pisztollyal
RO Pistol pneumatic de curățat cu ace

F Dérouilleur décapeur pneumatique
I Scrostatore pneumatico ad aghi
E Limpiador de agujas neumáticas
CN 气动除锈器

19 NEEDLES
19 IĞEL
0.63 MPa
113 l/min
4500 min⁻¹
STANDARD



YATO
YT-09910 8

GB Shank chisel for air hammer
D Lufthammer Meißel-set
PL Dłuta do młotka pneumatycznego
RUS Комплект зубил для пневматического молотка
CZ Dláta pro pneumatické kladivo
H Véső készlet pneumatikus véső kalapácsoszl
RO Set dalți pt. ciocan pneumatic

F Ensemble marteau burineur
I Set di scalpelli per martelli pneumatici
E Juego de martillos para martillos neumáticos
CN 气动铲刀

4 PCS
120 mm
ROUND OKRĄGLE



for / dla: YT-0990, 81133

YATO
YT-09901 50

GB Magnetic holder for tools
D Magnethalter für Schlagschrauber
PL Uchwyt magnetyczny na narzędzia
RUS Магнитный держатель для ударного гайковёрта
CZ Magnetický držák nářadí
H Mågneses tartó
RO Suport magnetic pt. scule pneumatice
F Support magnétique pour outils pneumatiques
I Fissaggio magnetico per chiave ad impulsione pneumatica
E Soporte magnético para llave de impacto
CN 磁性喷枪架



15 kg max.
MAGNETIC



YATO
YT-08707 5/10

GB Inflating gun
D Inflatorpistole
PL Pistolet do pompowania
RUS Пистолет для накачивания
CZ Pistole na čerpání z manometrem
H Pumpáló pisztoly nyomásmérővel

RO Pistol cu manometru
F Pistolet pour gonflage de pneus avec manomètre
I Pistola per gonfiaggio
E Pistola de bombeo con manometro
CN 充气枪

0.6 MPa (max.)
440mm HOSE WAZ
360°
STANDARD



L_{pa} = 89 ± 2.5 dB;
L_{wa} = 100 ± 2.5 dB;
a_w = < 2.5 m/s²

YATO
YT-23701 20

GB Inflating gun
D Inflatorpistole
PL Pistolet do pompowania
RUS Пистолет для накачивания
CZ Pistole na čerpání z manometrem
H Pumpáló pisztoly nyomásmérővel
RO Pistol cu manometru
F Pistolet pour gonflage de pneus avec manomètre
I Pistola per gonfiaggio
E Pistola de bombeo con manometro
CN 充气枪

0.8 MPa (max.)
440mm HOSE WAZ
AI
STANDARD



YATO
YT-2370 8/40

L_{pa} = < 70 dB;
a_w = < 2.5 m/s²

- GB** Inflating gun
D Inflatorpistole
PL Pistolet do pompowania
RUS Пистолет для накачивания
CZ Pistole na čerpání z manometrem
H Pumpáló pisztoly nyomásmérővel
RO Pistol cu manometru
F Pistolet pour gonflage de pneus avec manomètre
I Pistola per gonfiaggio
E Pistola de bombeo con manometro
CN 充气枪



0.8 MPa (max.)

440mm HOSE W/AGE



STANDARD

COLOR BOX

YATO
YT-23703 20

$L_{WA} = 89 \pm 2.5$ dB;
 $L_{PA} = 100 \pm 2.5$ dB;
 $a_s = \leq 2.5$ m/s²

- GB** Inflating gun
D Inflatorpistole
PL Pistolet do pompowania
RUS Пистолет для накачивания
CZ Pistole na čerpání z manometrem
H Pumpáló pisztoly nyomásmérővel
RO Pistol cu manometru
F Pistolet pour gonflage de pneus avec manomètre
I Pistola per gonfiaggio
E Pistola de bombeo con manometro
CN 充气枪



0.8 MPa (max.)

440mm HOSE W/AGE



STANDARD

SLIDING CARD



YATO
YT-23702 10/40

$L_{WA} = 89 \pm 2.5$ dB;
 $L_{PA} = 100 \pm 2.5$ dB;
 $a_s = \leq 2.5$ m/s²

- GB** Inflating head
D Klemmnippel (universal)
PL Glowica do pompowania
RUS Универсальная головка
CZ Hlava na čerpání
H Pumpafej
RO Cap pt. pompat
F Mandrin de pompe
I Testa per il pompaggio
E Cabeza de bombeo
CN 充气头

1.0 MPa (max.)

DOUBLE BLISTER



YATO	Ø (mm)	Box
YT-2371	6	50/300
YT-2372	8	50/300

- GB** Air breake bleeder
D Druckluft-Bremsentlüfter
PL Urządzenie pneumatyczne do wymiany płynu hamulcowego
RUS Устройство для замены тормозной жидкости
CZ Sada na odvzdušnění brzdové soustavy a hydraulické spojky
H Pneumatikus eszköz a fékfolyadék cseréjére
RO Aparat de schimbat lichid frână
F Purger de frein et d'embrayage pneumatique
I Strumento per la sostituzione del liquido freni
E Sangrado del freno de aire comprimido
CN 气动刹车油更换机

$L_{WA} = \leq 70$ dB;
 $L_{PA} = \leq 85$ dB;
 $a_s = \leq 2.5$ m/s²



11 ADAPTERS / 11 ADAPTERÓW

GREY CARTON BOX & COLOR LABEL



0.27 MPa

5.0 l

6m



STANDARD



YATO
YT-06845 1

- GB** Spray gun with fluid cup
D Lackierpistole mit Fließbecher
PL Pistolet natryskowy
RUS Пистолет - распылитель с верхним бачком



1.4 mm

410 l/min
0.6 l
0.30 MPa
HVLP

$L_{WA} = < 70$ dB;
 $a_s = < 2.5$ m/s²

YATO
YT-2340 20

- CZ** Pistole na lakování z nádrží
H Festékszóró pisztoly alsó- és felsőtartályos
RO Pistol de vopsit cu rezervor inferior
F Pistolet à peinture



1.5 mm

410 l/min
0.6 l
0.30 MPa
HVLP

$L_{WA} = < 70$ dB;
 $a_s = < 2.5$ m/s²

YATO
YT-2341 20

- I** Pistola vernice
E Pistola de barniz
CN 喷枪

COLOR BOX



1.8 mm

380 l/min
0.40 MPa
1.0 l

$L_{WA} = < 70$ dB;
 $a_s = < 2.5$ m/s²

YATO
YT-2346 10



0.8 mm

220 l/min
0.1 l
0.30 MPa
HVLP

$L_{WA} = < 70$ dB;
 $a_s = < 2.5$ m/s²

YATO
YT-2357 20

GB Air vacuum cleaner
D Druckluftstaubsauger
PL Odkurzacz pneumatyczny
RUS Пневматический пылесос
CZ Pneumatický vysavač

H Pneumatikus porszívó
RO Aspirator cu aer comprimat
F Aspirateur pneumatique

I Aspirapolvere pneumatico
E Aspirador neumático
CN 吹吸尘枪

COLOR BOX



0.62 MPa (max)

25 mm

AI

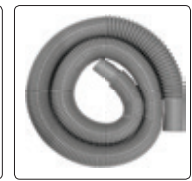

YATO	
YT-09990	10

$L_{pa} = 83.8 \pm 3$ dB;
 $L_{wa} = 94 \pm 3$ dB;
 $a_s = < 2.5$ m/s²

GB Cleaning foam gun
D Schaumpistole
PL Pistolet do wytwarzania piany
RUS Пистолет для образования пены
CZ Pistole pro vytváření pěny
H Habpisztoly
RO Pistol pt. spuma

F Pistolet pour faire de la mousse
I Pistola per erogazione schiuma
E Pistola generadora de espuma de espuma
CN 发动机清洗枪

0.62 MPa (max)
113 l/min
220 mm
1.01 AI STANDARD



COLOR BOX

YATO	
YT-23640	10



$L_{pa} = 85 \pm 3$ dB;
 $L_{wa} = 96 \pm 3$ dB;
 $a_s = < 2.5$ m/s²

GB Cleaning foam gun
D Schaumpistole
PL Pistolet do wytwarzania piany
RUS Пистолет для образования пены
CZ Pistole pro vytváření pěny
H Habpisztoly
RO Pistol pt. spuma

F Pistolet pour faire de la mousse
I Pistola per erogazione schiuma
E Pistola generadora de espuma
CN 发动机清洗枪

0.62 MPa (max)
113 l/min
TURBO NOZZLE DYSA TURBO
1.01 AI STANDARD



COLOR BOX

YATO	
YT-23641	10



$L_{pa} = 85 \pm 3$ dB;
 $L_{wa} = 96 \pm 3$ dB;
 $a_s = < 2.5$ m/s²

GB Blow gun with extension
D Gebläsepistole mit Verlängerung
PL Pistolet do przedmuchiwania z przedłużką
RUS Пистолет для продувки с удлинителем
CZ Pistole na profukování dlouhá
H Rövid előléfűvő pisztoly
RO Pistol lung pt. suflat
F Pistolet pour purger
I Pistola professionale
E Pistola de soplado
CN 长杆充气枪



1/4" 6.3mm
0.8 MPa (max.)
AI
25 mm 215 mm
STANDARD

SLIDING CARD



$L_{pa} = < 70$ dB;
 $L_{wa} = < 100$ dB;
 $a_s = < 2.5$ m/s²

YATO	
YT-2373	20/40

GB Blow gun with extension
D Gebläsepistole mit Verlängerung
PL Pistolet do przedmuchiwania z przedłużką
RUS Пистолет для продувки с удлинителем
CZ Pistole na profukování dlouhá
H Rövid előléfűvő pisztoly

RO Pistol lung pt. suflat
F Pistolet pour purger
I Pistola professionale
E Pistola de soplado
CN 长杆充气枪

0.8 MPa (max.)
BRASS MOSIADZ
PP 110 mm
STANDARD



SLIDING CARD



$L_{pa} = 89$ dB;
 $L_{wa} = 100$ dB;
 $a_s = < 2.5$ m/s²

YATO	
YT-23731	20/40

GB Blow gun with extension
D Gebläsepistole mit Verlängerung
PL Pistolet do przedmuchiwania z przedłużką
RUS Пистолет для продувки с удлинителем
CZ Pistole na profukování dlouhá
H Rövid előléfűvő pisztoly
RO Pistol lung pt. suflat
F Pistolet pour purger
I Pistola professionale
E Pistola de soplado
CN 长杆充气枪



0.8 MPa (max.)
320 mm
PP
BRASS MOSIADZ
STANDARD

$L_{pa} = 89 \pm 2.5$ dB;
 $L_{wa} = 100 \pm 2.5$ dB;
 $a_s = < 2.5$ m/s²

SLIDING CARD



YATO	
YT-23732	30/60

GB Blow gun with extension
D Gebläsepistole mit Verlängerung
PL Pistolet do przedmuchiwania z przedłużką

RUS Пистолет для продувки с удлинителем
CZ Pistole na profukování dlouhá
H Rövid előléfűvő pisztoly
RO Pistol lung pt. suflat

F Pistolet pour purger
I Pistola professionale
E Pistola de soplado
CN 长杆充气枪

0.8 MPa (max.)
520 mm
PP
BRASS MOSIADZ
STANDARD



SLIDING CARD



$L_{pa} = 89 \pm 2.5$ dB;
 $L_{wa} = 100 \pm 2.5$ dB;
 $a_s = < 2.5$ m/s²

YATO	
YT-23733	30/60

- GB** Short air blow gun with turbo
D Turbo-Blaspistole, kurz
PL Pistolet do przedmuchiwania krótki turbo
RUS Короткий турбо пистолет для продувки
CZ Profukovací pistole krátká turbo

- H** Fúvató pisztoly rövid turbó
RO Pistol de suflat scurt, functie turbo
F Soufflette à air comprimée courte turbo
I Pistola per soffiaggio corte turbo
E Pistola de soplado, corta turbo
CN 增压吹尘枪

0.62 MPa (max)
45 mm
TURBO NOZZLE
DYŠKA TURBO
STANDARD



$L_{pa} = 86 \pm 3$ dB;
 $L_{ma} = 97 \pm 3$ dB;
 $a_n < 2.5$ m/s²



YATO
YT-23722 50

- GB** Long air blow gun with turbo
D Turbo-Blaspistole, lang
PL Pistolet do przedmuchiwania długi turbo
RUS Длинный турбо пистолет для продувки
CZ Profukovací pistole dlouhá turbo

- H** Fúvató pisztoly hosszú turbó
RO Pistol de suflat lung, functie turbo
F Soufflette à air comprimée longue turbo
I Pistola per soffiaggio lungo turbo
E Pistola longa para soprar turbo
CN 长嘴增压吹尘枪

0.62 MPa (max)
110 mm
TURBO NOZZLE
DYŠKA TURBO
STANDARD



$L_{pa} = 86 \pm 3$ dB;
 $L_{ma} = 97 \pm 3$ dB;
 $a_n < 2.5$ m/s²



YATO
YT-23723 25

- GB** Washing gun
D Waschpistole
PL Pistolet do ropowania
RUS Пистолет для нефтывания
CZ Pistole na ropování + nádrž
H Olajzópisztoly + tartály

- RO** Pistol (dozator) cu rezervor pt. motorină
F Pistolet à l'huile
I Pistola di lavaggio con nafta
E Pistola de petrolar
CN 喷水枪

0.85 l/min
AI
0.80 MPa



$L_{wa} < 70$ dB;
 $a_n < 2.5$ m/s²

YATO
YT-2374 2/12

- GB** Air sand blaster
D Pistole zum Sandstrahlen
PL Pistolet do piaskowania z węzłem
RUS Пескоструйный пистолет
CZ Pískovací pistole s hadicí
H Homokszóró pisztoly tömlővel
RO Pistol de sablat

- F** Pistolet de sablage avec tuyau
I Pistola sabbiatrica
E Pistola para limpieza con chorro de arena con manguera
CN 吹气枪

1/4" 6.3 mm
1 m HOSE WAZ
AI

160 l/min
0.80 MPa



SLIDING CARD



$L_{wa} \leq 89$ dB;
 $a_n \leq 2.03$ m/s²

YATO
YT-2375 10

- GB** Gun suitable for sand-blasting
D Sandstrahlpistole
PL Pistolet do piaskowania ze zbiornikiem
RUS Пескоструйный пистолет
CZ Pískovací pistole se zásobníkem
H Homokszóró pisztoly tartállyal
RO Pistol de sablat
F Pistolet de sablage avec réservoir
I Pistola sabbiatrica con serbatoio
E Pistola para limpieza con chorro de arena con recip
CN 喷枪



$L_{wa} \leq 89$ dB;
 $a_n \leq 2.03$ m/s²

YATO
YT-2376 20

- GB** Work bench
D Lackierständer, verstellbar
PL Stojak lakierniczy rozstawny
RUS Раздвижная лакировочная стойка
CZ Stojan lakýrnický rozkládací
H Kinyitható lakkozó állvány
RO Suport extensibil pt. lacuit
F Support à peindre
I Supporto pieghevole
E Montante plegable para barnizar
CN 工作台

10 kg max 85 cm 50 cm
150 kg max 45 cm 100 cm



YATO
YT-5555 1

- GB Sandblaster cabinet
- D Sandstrahlkabine
- PL Piaskarka kabinowa
- RUS Пескоструйная камера
- CZ Kabinový pískovací stroj
- H Homokszóró kabin
- RO Masina de sablat
- F Cabine de sablage
- I Sabbiatrica a cabina
- E Cabina de chorro de arena
- CN 喷砂机

230-240V~50Hz
0.82 MPa
90L CAPACITY POŁNOŚĆ
STANDARD



WHITE
CARTON BOX
& COLOR LABEL



YATO	size / rozmiar (mm)	
YT-55840	585x490x490	1



- GB Nozzle for sandblaster cabinet
- D Keramikdüsen für Sandstrahlkabine
- PL Dysze ceramiczne do piaskarki kabinowej
- RUS Керамические насадки для пескоструйной камеры
- CZ Keramické trysky pro kabinový pískovací stroj
- H Kerámia fúvókák homokszóró kabinhoz
- RO Duze pt. aparat de sablat
- F Buses en céramique pour cabine de sablage
- E Boquillas cerámicas para cabinas de chorro de arena
- CN 四件套喷嘴



POLYBAG



for / dla: YT-55840 4, 5, 6, 7 mm

YATO	
YT-55844	20/200

- GB Protective film for sandblaster cabinet
- D Schutzfolien für Sandstrahlkabine
- PL Folie ochronne do piaskarki kabinowej
- RUS Защитные пленки для пескоструйной камеры
- CZ Ochranné fólie pro kabinový pískovací stroj
- H Védőfóliák homokszóró kabinhoz
- RO Folie protectie pt. aparat de sablat
- F Film de protection pour cabine de sablage
- E Películas para cabinas de chorro de arena
- CN 四片装保护膜

4
PCS



POLYBAG



for / dla: YT-55840

YATO	size / rozmiar (mm)	
YT-55845	410x300	50/100

- GB Gloves for sandblaster cabinet
- D Handschuhe für Sandstrahlkabine
- PL Rękawice do piaskarki kabinowej
- RUS Перчатки для пескоструйной камеры
- CZ Rukavice do kabinového pískovacího stroje
- H Kesztyű homokszóró kabinhoz
- RO Manusi pt. masina de sablat
- F Gants pour cabine de sablage
- E Guantes para cabinas de chorro de arena
- CN 手套



POLYBAG



for / dla: YT-55840

YATO	
YT-55846	25

- GB Mini filter
- D Filter
- PL Filtr
- RUS Мини-фильтр
- CZ Filtr
- H Szűrő
- RO Minifiltru
- F Vidange mini
- I Filtro
- E Filtro
- CN 微型过滤器



1.4 MPa (max.)

8 cm³

1/4"

6.3mm

COLOR BOX



YATO	
YT-2380	25/50

- GB Pressure reducing valve with manometer
- D Druckminderer mit Manometer
- PL Reduktor ciśnienia z manometrem
- RUS Клапан уменьшения давления с манометром
- CZ Redukční ventil s manometrem
- H Nyomáscsökkentő szelep nyomásmérővel
- RO Valva cu reductiepresiune + manometru
- F Réducteur avec manomètre
- I Regolatore di pressione con manometro
- E Reductor + manometro
- CN 带表调压减压阀

1.2 MPa (max.)

1/4"

6.3mm

COLOR BOX



YATO	
YT-2381	25/50

- GB Filter - reducer
- D Druckfilter
- PL Filtr - reduktor
- RUS Фильтр - редуктор
- CZ Filtr derukční ventli
- H Szűrő - nyomásszabályzó
- RO Filtru cu reductor
- F Réducteur avec filtre et manomètre
- I Filtro regolatore
- E Reductor + filtro
- CN 过滤器



0.93 MPa (max.)

15 cm³

60°C max.

1/4"

6.3mm

COLOR BOX



YATO	
YT-2382	25/50

- GB Filter - reducer
D Druckfilter - Druckminderer
PL Filtr - reduktor
RUS Фильтр - редуктор
CZ Filtr redukční ventil
H Szűrő - nyomásszabályzó
RO Filtru cu reductor
F Réducteur avec filtre et manomètre
I Filtro regolatore
E Reductor + filtro
CN 过滤器

0.93 MPa (max.)

90 cm³

60°C max.

1/2" 12.5mm



COLOR BOX

YATO YT-2383 25/50

- GB Air filter regulator and lubricator
D Druckfilter - Druckminderer + Entöler
PL Zespół filtrujący reduktor + smarownica
RUS Фильтр-редуктор
CZ Redukční ventil s odlučovačem oleje
H Levegőelőkészítő
RO Filtru cu reductor
F Filtre régulateur lubrificateur pour air comprimé
I Filtro regolatore lubrificatore
E Juego de filtro reductor + engrasador
CN 气动三联件

0.93 MPa (max.)

25 cm³ FILTER

15 cm³ LUBRICANT CUP SMAROWNICA

60°C max.

1/4" 6.3mm



COLOR BOX

YATO YT-2384 25/50

- GB Air filter regulator and lubricator
D Druckfilter - Druckminderer + Entöler
PL Zespół filtrujący reduktor + smarownica
RUS Фильтр-редуктор
CZ Redukční ventil s odlučovačem oleje
H Levegőelőkészítő
RO Filtru cu reductor
F Filtre régulateur lubrificateur pour air comprimé
I Filtro regolatore lubrificatore
E Juego de filtro reductor + engrasador
CN 气动三联件

0.93 MPa (max.)

90 cm³ FILTER

60 cm³ LUBRICANT CUP SMAROWNICA

60°C max.

1/4" 6.3mm



COLOR BOX

YATO YT-2385 25

- GB Air splitter
D Druckluftverteiler mit Regelung
PL Rozdzielacz pneumatyczny z regulacją
RUS Пневмораспределитель с регулированием
CZ Pneumatický rozdělovač s regulací
H Pneumatikus elosztó szabályzóval

- RO Distributor aer comprimat
F Distributeur pneumatique avec régulation
I Distributore pneumatico con regolazione
E Distribuidor neumático ajustable
CN 气路分流器

0.63 MPa

1.3 MPa (max.)

2x OUT WYSCIE

2x ADJUSTABLE OUT REGULOWANE WYSCIE

STANDARD



COLOR BOX

YATO YT-23860 5

- GB Spiral tube with quick coupling
D Spiralschlauch mit Schnellkupplung
PL Wąż spiralny z szybkozłączem
RUS Шланг спиральный с быстрым соединением
CZ Spirálová vzduchová hadice
H Levegős spiráltömlő gyorscsatlakozóval
RO Tub spiralat cu, cuplare rapida

- F Tuyau spirale en polyurethane
I Tubo a spirale con rapido
E Manguera espiral
CN PU气管

1.2 MPa (max.)

PU

STANDARD



YATO	Ø (mm)	L (m)	
YT-24201	5.5x8	5	50
YT-24202	5.5x8	10	25
YT-24203	5.5x8	15	25
YT-24204	6.5x10	5	50
YT-24205	6.5x10	10	25
YT-24206	6.5x10	15	25
YT-24207	8x12	5	50
YT-24208	8x12	10	25
YT-24209	8x12	15	20

- GB Air hose with quick coupler
D Luftschauch mit Schnellkupplung
PL Wąż techniczny zbrojony z szybkozłączami
RUS Шланг пневматический с быстроразъемным соединением
CZ Hadice vzduchová s rychlospojkami
H Levegőtömlő apa csatlakozóval
RO Furtun aer comprimat cuple rapide
F Le tuyau d'air avec raccords rapides
I Rinforzato tecnico tubo flessibile con rapido
E Manguera de aire del con los acopladores rápidos
CN PVC气管

PVC

2.0 MPa (max.)

STANDARD



YATO	Ø (mm)	L (m)	
YT-24220	8	10	10
YT-24221	8	20	8
YT-24224	10	10	10
YT-24225	10	20	8

- GB Hybrid air hose
D Hybrid-Druckluftleitung
PL Przewód pneumatyczny hybrydowy
RUS Пневматический гибридный шланг
CZ Hibrídá pneumatiská šjténe
H Hibríd pneumatikus vezeték
RO Furtun aer, hibríd
F Tuyau pneumatique hybride
I Condotto pneumatico ibrido
E Conducto neumático híbrido
CN 橡胶高弹管

COLOR CARTON SHEET



2.0 MPa (max.)

G 1/4

PVC+NBR HYBRID



YATO	internal diameter / średnica wewnętrzna (mm)	L (m)	
YT-24230	6.5	10	10
YT-24231	6.5	20	5
YT-24232	6.5	30	4

GB Hybrid air hose
D Hybrid-Druckluftleitung
PL Przewód pneumatyczny hybrydowy
RUS Пневматический гибридный шланг
CZ Hybridá pneimatiská šítene
H Hybrid pneumatikus vezetékek
RO Furtun aer, hibrid
F Tuyau pneumatique hybride
I Condotto pneumatico ibrido
E Conducto neumático híbrido
CN 橡胶高弹管

COLOR
CARTON
SHEET



2.0
MPa
(max)



PVC+NBR
HYBRID



YATO	internal diameter / średnica wewnętrzna (mm)	L (m)	
YT-24233	8	10	10
YT-24234	8	20	5
YT-24235	8	30	4

GB Hybrid air hose
D Hybrid-Druckluftleitung
PL Przewód pneumatyczny hybrydowy
RUS Пневматический гибридный шланг
CZ Hybridá pneimatiská šítene
H Hybrid pneumatikus vezetékek
RO Furtun aer, hibrid
F Tuyau pneumatique hybride
I Condotto pneumatico ibrido
E Conducto neumático híbrido
CN 橡胶高弹管

COLOR
CARTON
SHEET



2.0
MPa
(max)



PVC+NBR
HYBRID



YATO	internal diameter / średnica wewnętrzna (mm)	L (m)	
YT-24236	12.5	10	10
YT-24237	12.5	20	5
YT-24238	12.5	30	4

GB Air hose reel
D Luftschnlauch am Haspel
PL Wąż pneumatyczny na zwijaku
RUS Шланг пневматический на катушке
CZ Naviják se vzduchovou hadicí
H Levegő tömlő dob es
RO Furtun de aer tumbur
F Bobine de tuyau d'air et de
I Tubo pneumatico sull'avvolgitore
E Carrete de manguera de aire
CN 气动软管卷盘



2.0
MPa
(max)



COLOR
BOX



YATO	
YT-24240	2

GB Air hose reel
D Luftschnlauch am Haspel
PL Wąż pneumatyczny na zwijaku
RUS Шланг пневматический на катушке
CZ Naviják se vzduchovou hadicí
H Levegő tömlő dob es
RO Furtun de aer tumbur
F Bobine de tuyau d'air et de
I Tubo pneumatico sull'avvolgitore
E Carrete de manguera de aire
CN 气动软管卷盘



2.0
MPa
(max)



COLOR
BOX



YATO	
YT-24241	2

GB Air hose reel
D Luftschnlauch am Haspel
PL Wąż pneumatyczny na zwijaku
RUS Шланг пневматический на катушке
CZ Naviják se vzduchovou hadicí
H Levegő tömlő dob es
RO Furtun de aer tumbur
F Bobine de tuyau d'air et de
I Tubo pneumatico sull'avvolgitore
E Carrete de manguera de aire
CN 气动软管卷盘



2.0
MPa
(max)



COLOR
BOX



YATO	
YT-24242	4

GB Air hose reel
D Luftschnlauch am Haspel
PL Wąż pneumatyczny na zwijaku
RUS Шланг пневматический на катушке
CZ Naviják se vzduchovou hadicí
H Levegő tömlő dob es
RO Furtun de aer tumbur
F Bobine de tuyau d'air et de
I Tubo pneumatico sull'avvolgitore
E Carrete de manguera de aire
CN 气动软管卷盘



2.0
MPa
(max)



COLOR
BOX



YATO	
YT-24243	4

GB Air hose reel
D Luftschauch am Haspel
PL Wąż pneumatyczny na zwijaku
RUS Шланг пневматический на катушке
CZ Naviják se vzduchovou hadicí
H Levegő tömlő dob es
RO Furtun de aer tumbur
F Bobine de tuyau d'air et de

I Tubo pneumatico sull'avvolgitore
E Carrete de manguera de aire
CN 气动软管卷盘

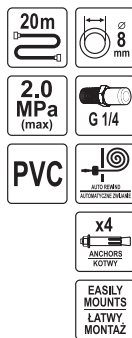

COLOR BOX

YATO	
YT-24244	2

GB Air hose reel
D Luftschauch am Haspel
PL Wąż pneumatyczny na zwijaku
RUS Шланг пневматический на катушке
CZ Naviják se vzduchovou hadicí
H Levegő tömlő dob es
RO Furtun de aer tumbur
F Bobine de tuyau d'air et de

I Tubo pneumatico sull'avvolgitore
E Carrete de manguera de aire
CN 气动软管卷盘

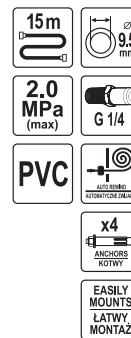

COLOR BOX

YATO	
YT-24245	1

GB Air hose reel
D Luftschauch am Haspel
PL Wąż pneumatyczny na zwijaku
RUS Шланг пневматический на катушке
CZ Naviják se vzduchovou hadicí
H Levegő tömlő dob es
RO Furtun de aer tumbur
F Bobine de tuyau d'air et de

I Tubo pneumatico sull'avvolgitore
E Carrete de manguera de aire
CN 气动软管卷盘



COLOR BOX

YATO	
YT-24246	1

GB Air hose reel
D Luftschauch am Haspel
PL Wąż pneumatyczny na zwijaku
RUS Шланг пневматический на катушке
CZ Naviják se vzduchovou hadicí
H Levegő tömlő dob es
RO Furtun de aer tumbur
F Bobine de tuyau d'air et de
I Tubo pneumatico sull'avvolgitore
E Carrete de manguera de aire
CN 气动软管卷盘

I Tubo pneumatico sull'avvolgitore
E Carrete de manguera de aire
CN 气动软管卷盘

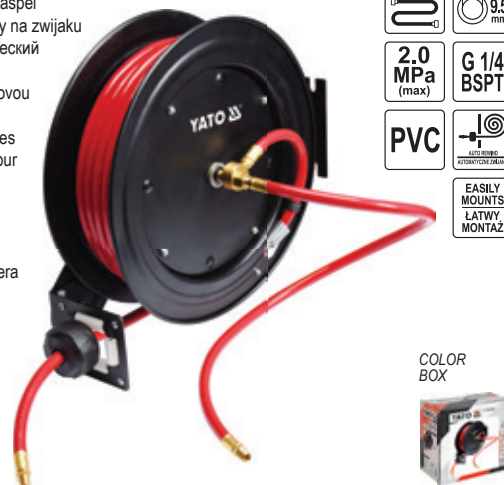
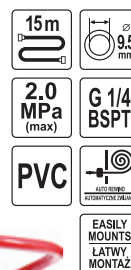

COLOR BOX

YATO	
YT-24250	1

GB Quick coupler
D Schnellkupplung
PL Szybkozłącze

RUS Быстрое соединение
CZ Rychlospojka
H Gyorscsatlakozó

RO Muşa rapidă pt. pistol pneumatic
F Raccord rapide
I Attacco rapido

E Conexión de la entrada de aire
CN 快速接头

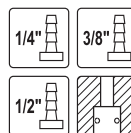
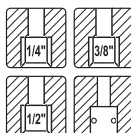
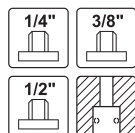

YATO	size / rozmiar	
YT-2390	1/4" (6.3 mm)	50/250
YT-2391	3/8" (10.0 mm)	50/250
YT-2392	1/2" (12.5 mm)	50/250

YATO	size / rozmiar	
YT-2393	1/4" (6.3 mm)	50/250
YT-2394	3/8" (10.0 mm)	50/250
YT-2395	1/2" (12.5 mm)	50/250

YATO	size / rozmiar	
YT-2396	1/4" (6.3 mm)	50/250
YT-2397	3/8" (10.0 mm)	50/250
YT-2398	1/2" (12.5 mm)	50/250

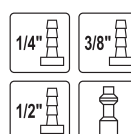
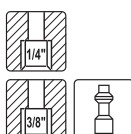
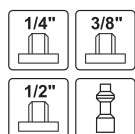

YATO	size / rozmiar	
YT-2399	1/4" (6.3 mm)	50/250
YT-2401	3/8" (10.0 mm)	50/250
YT-2402	1/2" (12.5 mm)	50/250

YATO	size / rozmiar	
YT-2403	1/4" (6.3 mm)	50/250
YT-2404	3/8" (10.0 mm)	50/250

YATO	size / rozmiar	
YT-2405	1/4" (6.3 mm)	50/250
YT-2406	3/8" (10.0 mm)	50/250
YT-2407	1/2" (12.5 mm)	50/250

GB Quick coupler
D Schnellkupplung
PL Szybkozłącze

RUS Быстрое соединение
CZ Rychlospojka
H Gyorscsatlakozó

RO Mufa rapida pt. pistol pneumatic
F Raccord rapide
I Attacco rapido

E Conexión de la entrada de aire
CN 快速接头

DOUBLE BLISTER

2
PCS
STANDARD

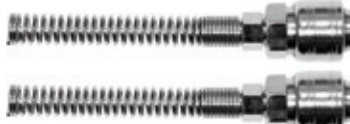

YATO
YT-24100 6/60

YATO
YT-24101 6/60

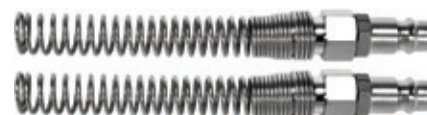

YATO
YT-24102 6/60

YATO
YT-24103 6/60

GB 2 way quick coupler
D Zwei-wege schnellkupplung
PL Szybkozłącze podwójne
RUS Двусторонняя быстросъемные соединения
CZ Two-way rychlospojky
H Levegőelosztó kettős gyorscsat

RO Distribuitoare cuple rapide
F Dérivation type y en cuivre
I Raccordo ottone con vie
E Manera 2 manguera de aire pase de acoplamiento rápido
CN 三通万用插嘴



SLIDING CARD

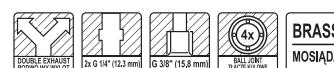

YATO
YT-24091 25/50

GB Quick coupler
D Schnellkupplung
PL Szybkozłącze
RUS Быстрое соединение
CZ Rychlospojka
H Gyorscsatlakozó

RO Mufa rapida pt. pistol pneumatic
F Raccord rapide
I Attacco rapido
E Conexión de la entrada de aire
CN 快速接头



GB Pneumatic grease injector
D Druckluft-Fettpresse
PL Towotnica / smarownica pneumatyczna
RUS Пневматический нагнетатель смазки
CZ Pneumatiké-čerpadlo maziv

H Pneumatikus zsír szivattyú
RO Pompa de unsoare pneumatic
F Pompe a graisse pneumatique
I Pneumatica per ingrassaggio
E Bomba de engrase neumática lubricar
CN 注油器

121
0.6-0.8 MPa
40 MPa (max)
4 m HOSE WAZ
50:1 RATIO SPREZANE
STANDARD

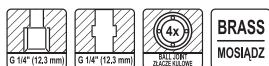

YATO
YT-24092 50/100

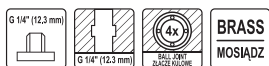

YATO
YT-24094 50/100

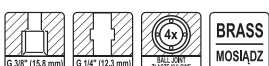

YATO
YT-24093 50/100



YATO
YT-24095 50/100

GB Air hose swivel connector
D Druckluft Gelenk-Kupplung
PL Przegub pneumatyczny
RUS Пневматическое соединение
CZ Pneumatický kloub
H Pneumatikus forgócsukló

RO Conector pivotant pt. furtun de aer
F Raccord pneumatique
I Giunto pneumatico
E Junta neumática
CN 万向接头

1/4\"/>



YATO
YT-24130 25/100



GREY CARTON BOX & COLOR LABEL



YATO
YT-07067 12 1

L_{PA} = 97 ± 3 dB;
L_{WA} = 108 ± 3 dB

GB Pneumatic grease injector
D Druckluft-Fettpresse
PL Smarownica pneumatyczna
RUS Пневматический нагнетатель смазки
CZ Pneumatické-čerpadlo maziv

H Pneumatikus zsír szivattyú
RO Pompa de unsoare pneumatică
F Pompe a graisse pneumatique
I Pneumatica per ingrassaggio
E Bomba de engrase neumática lubricar
CN 注油器

30 l
0.6-0.8 MPa
40 MPa (max)
4 m HOSE WAŻ
50:1 RATIO SPREZANE
STANDARD



GREY
CARTON BOX
& COLOR
LABEL



YATO	I	1
YT-07068	30	1

L_{pa} = 97 ± 3 dB;
L_{wa} = 106 ± 3 dB

GB Pneumatic grease injector
D Druckluft-Fettpresse
PL Smarownica pneumatyczna
RUS Пневматический нагнетатель смазки
CZ Pneumatické-čerpadlo maziv

H Pneumatikus zsír szivattyú
RO Pompa de unsoare pneumatică
F Pompe a graisse pneumatique
I Pneumatica per ingrassaggio
E Bomba de engrase neumática lubricar
CN 注油器

45 l
0.6-0.8 MPa
40 MPa (max)
4 m HOSE WAŻ
50:1 RATIO SPREZANE
STANDARD



GREY
CARTON BOX
& COLOR
LABEL



YATO	I	1
YT-07069	45	1

L_{pa} = 97 ± 3 dB;
L_{wa} = 106 ± 3 dB

GB Air grease gun
D Druckluft-Fettpresse
PL Smarownica pneumatyczna
RUS Шприц для нагнетания густой смазки пневматический
CZ Mazací lis pneumatický

H Pneumatikus zsírzó
RO Pistol pt. gresat pneumatic
F Pistolet de graissage pneumatique
I Pneumatica per ingrassaggio
E Pistola engrasadora neumática
CN 气动黄油枪

400 cm³
28 l/min
STANDARD

OUT: 30-40 MPa



IN: 0.2-0.8 MPa

COLOR
BOX



YATO	I	10
YT-07055		

L_{pa} = 93 ± 3 dB;
L_{wa} = 104 ± 3 dB;
a₁ = ≤ 2,5 m/s²

GB Air grease gun
D Druckluft-Fettpresse
PL Smarownica pneumatyczna
RUS Шприц для нагнетания густой смазки пневматический
CZ Mazací lis pneumatický

H Pneumatikus zsírzó
RO Pistol pt. gresat pneumatic
F Pistolet de graissage pneumatique
I Pneumatica per ingrassaggio
E Pistola engrasadora neumática
CN 气动黄油枪

0.63 MPa
400 cm³
220 l/min
STANDARD

OUT: 6-28 MPa



IN: 0.2-0.63 MPa

COLOR
BOX





YATO	I	10
YT-07057		

L_{pa} = ≤ 70 dB;
L_{wa} = ≤ 90 dB;
a₁ = ≤ 2,5 m/s²

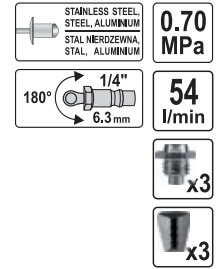
- GB Pneumatic riveting machine
D Pneumatische Nietvorrichtung
PL Nitownica pneumatyczna
RUS Пневматический заклепочник
CZ Pneumatická nýtovačka
H Pneumatikus popszegecshűző
RO Presa pneumatica pt. nituit
F Riveuse pneumatique
I Rivettatrice pneumatica
E Máquina remachadora
CN 气动拉铆枪



COLOR BOX



YATO 	Ø (mm)	L (mm)	F (kg)	F (N)	
YT-36171	2.4; 3.2; 4.0; 4.8; 5.0	18	1060	10400	10

$L_{WA} = 83.6 \pm 1.9$ dB;
 $L_{WA} = 97.4 \pm 2.8$ dB;
 $a_s = 0.66 \pm 0.21$ m/s²

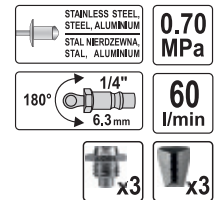
- GB Pneumatic riveting machine
D Pneumatische Nietvorrichtung
PL Nitownica pneumatyczna
RUS Пневматический заклепочник
CZ Pneumatická nýtovačka
H Pneumatikus popszegecshűző
RO Presa pneumatica pt. nituit
F Riveuse pneumatique
I Rivettatrice pneumatica
E Máquina remachadora
CN 气动拉铆枪



COLOR BOX

YATO 	Ø (mm)	L (mm)	F (kg)	F (N)	
YT-36177	4.0; 4.8; 5.0; 6.4	20	1255	12300	10

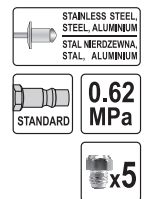

$L_{WA} = 87.2 \pm 2.3$ dB;
 $L_{WA} = 94.5 \pm 3.0$ dB;
 $a_s = 0.54 \pm 0.15$ m/s²

- GB Pneumatic riveting machine
D Pneumatische Nietvorrichtung
PL Nitownica pneumatyczna
RUS Пневматический заклепочник
CZ Pneumatická nýtovačka
H Pneumatikus popszegecshűző
RO Presa pneumatica pt. nituit
F Riveuse pneumatique
I Rivettatrice pneumatica
E Máquina remachadora
CN 气动拉铆枪



COLOR BOX

- application: industry
- przeznaczenie: przemysł

YATO 	Ø (mm)	L (mm)	F (kg)	F (N)	
YT-3618	2.4; 3.2; 4.0; 4.8; 6.4	16	1389	13620	6

$L_{WA} = 81.2 \pm 3.0$ dB;
 $L_{WA} = 92.2 \pm 3.0$ dB;
 $a_s = 0.4 \pm 1.5$ m/s²

- GB** Slotted special socket set
D Spezial-Steckschlüssel-Einsätze, geschlitzt
PL Zestaw nasadek otwartych
RUS Набор головок разрезных
CZ Sada otevřených hlavic
H Crowafej speciális végig nyitott
RO Set de chei tubulare pt. injectoare
F Ensemble de clés creuses avec fenêtre latérale
I Set di attacchi aperti
E Conjunto de teclas huecas con ventana lateral
CN 7件套开槽油管扳手套



7 PCS
1/2" 12.5mm
3/8" 10mm
CrV

SLIDING CARD

10, 11, 12, 13, 14, 17, 19 mm

YATO
YT-17508 6/24

- GB** Flare nut wrench
D Schraubenschlüssel, halboffen
PL Klucz oczkowy półotwarty
RUS Ключ накладной полуоткрытый
CZ Klíč prstencový polootevřený
H Csuklós, nyitott
RO Cheie inelară semideschisă
F Clé mixte à cliquet
I Chiave poligonale semiaperto
E Llave semiabierta
CN 油管扳手

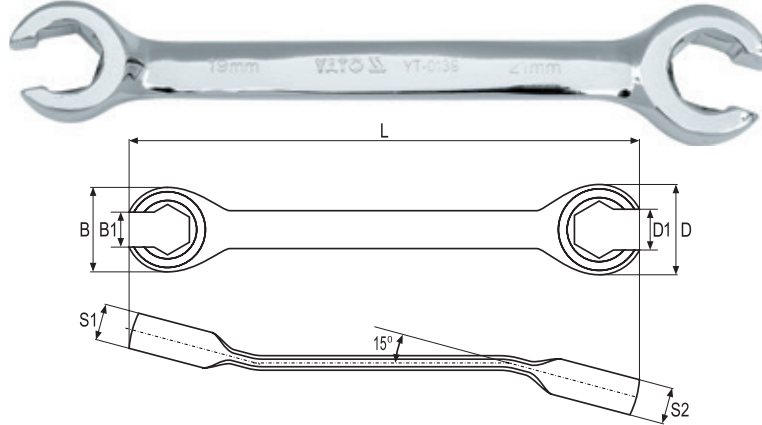

CrV 6140

COLOR BOX



YATO	Ø (mm)	L (mm)	B (mm)	D (mm)	B1 (mm)	D1 (mm)	S1 (mm)	S2 (mm)	PCS packing	
YT-0135	8x10	140	18.7	21.8	6.2	7.2	7.7	8.4	10	200/400
YT-0136	11x12	160	21.2	24.0	8.1	9.2	8.5	9.5	10	100/200
YT-0137	13x14	175	26.3	27.3	9.6	10.7	9.6	10.5	10	100/200
YT-0138	15x17	190	31.2	31.2	11.8	13.0	11.5	10.9	10	50/100

YATO	Ø (mm)	L (mm)	B (mm)	D (mm)	B1 (mm)	D1 (mm)	S1 (mm)	S2 (mm)	PCS packing	
YT-01385	17x19	195	29.0	31.2	14.5	15.0	12.4	12.8	10	50/100
YT-0139	19x21	230	36.3	42.1	14.7	16.7	12.4	12.8	10	50/100
YT-0140	22x24	250	42.7	44.2	17.1	18.6	13.2	13.9	10	50/100

- GB** Torx ring spanner set
D Torx-Ringschlüsselsatz
PL Komplet kluczy oczkowych Torx
RUS Набор накладных ключей
CZ Očkové klíče
H Csillagkulcs készlet
RO Cheie inelare
F Set de clés à œil
I Set chiavi doppie Torx

- E** Llaves de anillo Torx
CN 星型扳手组套



E6xE8, E10xE12, E14xE18, E20xE24

SLIDING CARD



YATO
YT-0530 10/60

- GB** Half-moon spanner
D Starter- und Blockschlüssel
PL Klucz oczkowy typu „C”
RUS Ключ накладной изогнутый „С”
CZ Klíč očkoplochý typ „C”
H Félhold alakú csillagkulcs
RO Cheie inelara semi-luna
F Clé à œil „C”
I Chiave poligonale doppio speciale tipo „C”
E Llave de estrella tipo „C”
CN C型梅花扳手

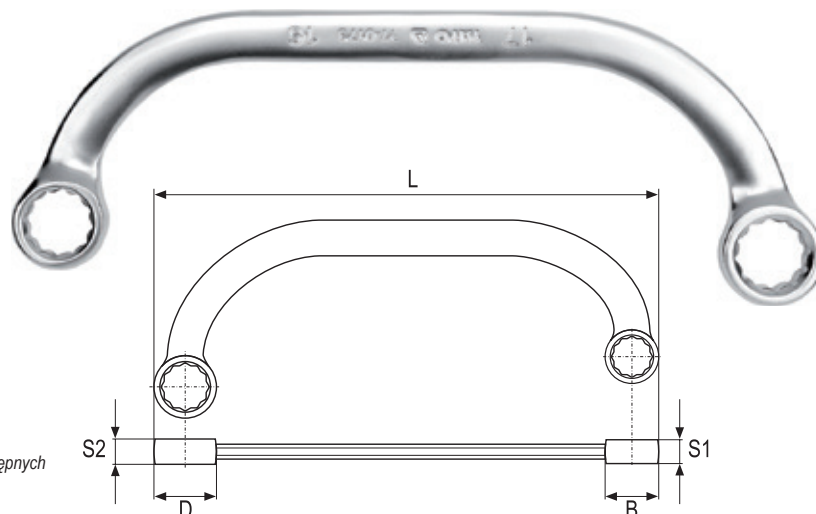

CrV 6140 AS-DRIVE

- application: industry
- excellent for work in tight spaces
- used for dismantling of collector tubes, alternators and starters
- surface finish: chromed, satin
- przeznaczenie: przemysł
- do pracy w miejscach szczególnie trudnodostępnych
- ułatwia odkręcanie kolektorów, alternatorów i rozruszników samochodowych
- wykończenie powierzchni: chromowana, satynowa

YATO	Ø (mm)	L (mm)	B (mm)	D (mm)	S1 (mm)	S2 (mm)	
YT-0170	10x12	145	16.8	19.2	6.8	6.8	10/60
YT-0171	11x13	170	18.5	21.2	8.4	8.6	10/60
YT-0172	14x15	195	22.8	25.8	9.2	9.9	10/60

YATO	Ø (mm)	L (mm)	B (mm)	D (mm)	S1 (mm)	S2 (mm)	
YT-0173	16x17	220	26.2	28.6	9.9	10.5	10/60
YT-0175	19x22	260	28.7	32.9	10.4	10.9	10/60

GB Tool set
D Sechskant-Steckschlüssel-Satz
PL Zestaw narzędziowy
RUS Набор инструмента

CZ Sada nástrčných klíčů a ráčny
H Dugókulcs készlet racsnis hajtókarral
RO Trusa de scule
F Coffret d'outillage

I Set di utensili
E Juego de herramientas
CN 套筒扳手机组套

BMC & COLOR
SLEEVE



1/2" 12.5mm	3/8" 10mm	1/4" 6.3mm
CrV 50BV30	CrV 6150	S2
72T		AS-DRIVE



126
PCS
CrV
6140

1/2" (12.7 mm): 20, 21, 22, 24 mm (L=38 mm); 27, 30, 32 mm (L=42 mm), 3/8" (9.5 mm): 9, 10, 11, 12, 13, 14, 15, 16 mm (L=28 mm); 17, 18, 19 mm (L=30 mm), 1/4" (6.3 mm): 4, 4.5, 5, 5.5, 6, 7, 8, 9, 10, 11, 12, 13 mm (L=25 mm); CrV 50BV30; □ 3/8" (9.5 mm): 13, 14, 15, 17 mm (L=63 mm), 1/4" (6.3 mm): 8, 9, 10, 12 (L=50 mm); CrV 50BV30; □ 3/8" (9.5 mm): E8, E10, E11, E12, E14, E16, E18, E20; CrV 6150; □ 1/2" (12.7 mm): (127, 254 mm), 3/8" (9.5 mm): (76, 152.4 mm), 1/4" (6.3 mm): (50.8 mm); CrV 50BV30; □ 3/8" (9.5 mm) (F) x 1/2" (12.7 mm) (M); CrV 50BV30; 1/2" (12.7 mm), 3/8" (9.5 mm), 1/4" (6.3 mm); CrV 50BV30; □ 3/8" (9.5 mm): 16, 21 mm; CrV 50BV30; □ 1/2" (12.7 mm); (255 mm), 3/8" (9.5 mm); (200 mm), 1/4" (6.3 mm); (155 mm); 72T; CrV 6140; □ 1/4" (6.3 mm); (150 mm); CrV 50BV30; □ 1/2" (12.7 mm) (F) x 3/8" (9.5 mm) (M), 3/8" (9.5 mm) (F) x 1/2" (12.7 mm) (M), 3/8" (9.5 mm) (F) x 1/4" (6.3 mm) (M); CrV 50BV30; □ 1/4" (6.3 mm) x 1/4" (6.3 mm); CrV 6140; □ 1/4" (6.3 mm): 4, 5, 6.5 mm (L=25 mm); AISI S2; □ 1/4" (6.3 mm): PH1, PH3 (L=25 mm); AISI S2; □ 1/4" (6.3 mm): PZ1, PZ2 (L=25 mm); AISI S2; □ 1/4" (6.3 mm): T10, T15, T20, T25, T27, T30, T40 (L=25 mm); AISI S2; □ 1/4" (6.3 mm): 3, 4, 5, 6 mm (L=25 mm); AISI S2; □ 3/8" (9.5 mm): 5.5, 6.5 mm (L=50 mm); AISI S2 / CrV 6150; □ 3/8" (9.5 mm): PH1, 2xPH2 (L=50 mm); AISI S2 / CrV 6150; □ 3/8" (9.5 mm): T20, T30, T40 (L=50 mm); AISI S2 / CrV 6150; □ 3/8" (9.5 mm): T45, T50, T55, T60 (L=50 mm); AISI S2 / CrV 6150; □ 3/8" (9.5 mm): 3, 4, 5, 6, 7 mm (L=50 mm); AISI S2 / CrV 6150; □ 1/2" (12.7 mm): M10 (L=100 mm); AISI S2 / CrV 6150; □ 8, 10, 12, 13, 14, 16, 17, 18, 19 mm; CrV; □ 8x10 mm, 11x12 mm; CrV 6140; □ 6x100 mm, PH2x100 mm; CrV 6150; □ 6-24 V; □ 150 mm; □ 1/2" (12.7 mm), 3/8" (9.5 mm); 63-120 mm; CrV; □ 1.5, 2, 2.5, 3, 4, 5, 6, 8, 10 mm; S2

YATO	□	□	□	□
YT-38875	1/2" (12.7 mm)	3/8" (9.5 mm)	1/4" (6.3 mm)	2

GB Tool set for electricians
D Werkzeug-Set für Elektriker
PL Zestaw narzędziowy dla elektryków
RUS Набор инструментов для электриков
CZ Sada náradí pro elektrikáře

H Szerszámkészlet villanyszerelők
RO Trusa electrician
F Un ensemble d'outils pour les électriciens

I Set per l'elettricista
E Um conjunto de ferramentas para electricistas
CN 件电子绝缘工具组套

BMC & COLOR
SLEEVE



68 PCS	1/4" 6.3mm	CrV 50BV30	CrV 6150
S2		1000 V	DE



1/4" (6.3 mm): 4, 4.5, 5, 5.5, 6, 7, 8, 9, 10, 11, 12, 13 mm (L=25 mm); CrV 50BV30; □ 140 mm; □ 190 mm; 3CRB; □ 150 mm; □ 160 mm; 1000 V; CrV; □ 160 mm; 1000 V; CrV; □ 3 m x 16 mm; □ 175 mm; □ 19.5 x 190 mm;

□ 1.5 V; 9 LED; □ 9 mm; □ 19 mm x 20 mm; □ 1/4" (6.3 mm); (150 mm); CrV 50BV30; □ 1/4" (6.3 mm) x 1/4" (6.3 mm); CrV 6140; □ 10 g; □ 1.4, 2, 2.4 mm; PH00, PH0, PH1; S2; □ 4x100, 5.5x125, PH1x80, PH2x100 mm; 1000V; S2; □ 1/4" (6.3 mm): 3, 4, 5, 5.5, 6 mm (L=25 mm); AISI S2; □ 1/4" (6.3 mm): PH1, PH2, PH3 (L=25 mm); AISI S2; □ 1/4" (6.3 mm): T8, T10, T15, T20, T25, T27 (L=25 mm); AISI S2; □ 1/4" (6.3 mm): 2, 2.5, 3, 4, 5, 6 (L=25 mm); AISI S2; □ 1.5, 2, 2.5, 3, 4, 5, 6, 7, 8, 10 mm; CrV 6150

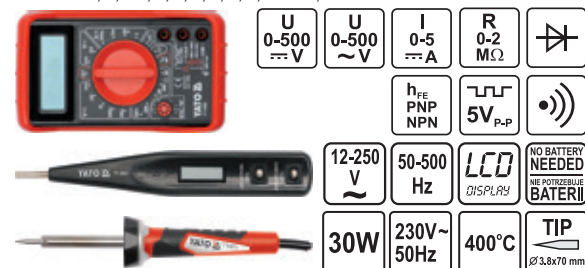

U 0-500 V	U 0-500 ~V	I 0-5 A	R 0-2 MΩ	⚡
hFE PNP NPN		5V P-P	NO BATTERY NEEDED NIE POTRZEBUJE BATERII	
12-250 V	50-500 Hz	LCD DISPLAY	TIP Ø3.8x70 mm	
30W	230V~ 50Hz	400°C		
YATO	□	□	□	□
YT-39009	1/4" (6.3 mm)			2

GB Beam torque wrench
D Beam-Typ-Drehmomentschlüssel
PL Klucz dynamometryczny wychylny
RUS Ключ динамометрический стрелочный

CZ Dynamometrický klíč
H Nyomatékkulcs
RO Cheie cu dinamometru
F Clé dynamométrique inclinée

I Chiave dinamometrica a quadrante
E Llave dinamométrica inclinada
CN 指针式扭力扳手

1/2" 12.5mm
3/4" 19mm
CrV 6140



YATO	Ø	Nm	
YT-07641	1/2" (12.7 mm)	0-300	16
YT-07642	3/4" (19.0 mm)	0-500	9

GB Torque wrench
D Drehmomentschlüssel
PL Klucz dynamometryczny

RUS Ключ динамометрический
CZ Dynamometrický klíč
H Nyomatékkulcs

RO Cheie cu dinamometru
F Clé dynamométrique
I Chiave dinamometrica

E Llave dinamométrica
CN 传统型可调式扭力扳手

1/2" 12.5mm
3/8" 10mm
CrV 6140



YATO	Ø	Nm	L (mm)	
YT-0750	3/8" (9.5 mm)	20-110	342-360	20
YT-0760	1/2" (12.7 mm)	42-210	445-465	12

GB Torque wrench
D Drehmomentschlüssel
PL Klucz dynamometryczny

RUS Ключ динамометрический
CZ Dynamometrický klíč
H Nyomatékkulcs

RO Cheie cu dinamometru
F Clé dynamométrique
I Chiave dinamometrica

E Llave dinamométrica
CN 传统型可调式扭力扳手

3/8" 10mm
TOLERANCE TOLERANȚA CW ++ 4% CCW -- 4%
ALLOY STEEL STAL STOPOWA



YATO	Ø	Nm	L (mm)	
YT-07500	3/8" (9.5 mm)	10-60	378-400	12

GB Torque wrench
D Drehmomentschlüssel
PL Klucz dynamometryczny
RUS Ключ динамометрический

CZ Dynamometrický klíč
H Nyomatékkulcs
RO Cheie cu dinamometru
F Clé dynamométrique

I Chiave dinamometrica
E Llave dinamométrica
CN 传统型可调式扭力扳手

1/4" 6.3mm
1/2" 12.5mm
3/4" 19mm
TOLERANCE TOLERANȚA CW ++ 4% CCW -- 4%
ALLOY STEEL STAL STOPOWA



YATO	Ø	Nm	L (mm)	
YT-07511	1/4" (6.3 mm)	2.5-20	240-250	16
YT-07611	1/2" (12.7 mm)	10-60	378-400	16
YT-07601	1/2" (12.7 mm)	65-335	518-540	10
YT-07712	3/4" (19.0 mm)	80-400	676-697	4

GB Torque wrench
D Drehmomentschlüssel
PL Klucz dynamometryczny

RUS Ключ динамометрический
CZ Dynamometrický klíč
H Nyomatékkulcs

RO Cheie cu dinamometru
F Clé dynamométrique
I Chiave dinamometrica

E Llave dinamométrica
CN 传统型可调式扭力扳手

1/4" 6.3mm
CrV 6140



YATO	Ø	Nm	L (mm)	
YT-0751	1/4" (6.3 mm)	2-10	268-278	24

GB Torque wrench
D Drehmomentschlüssel
PL Klucz dynamometryczny

RUS Ключ динамометрический
CZ Dynamometrický klíč
H Nyomatékkulcs

RO Cheie cu dinamometru
F Clé dynamométrique
I Chiave dinamometrica

E Llave dinamométrica
CN 传统型可调式扭力扳手

1/4" 6.3mm
TOLERANCE TOLERANȚA CW ++ 3% CCW ++ 3%
CrMo42
CrMo30



YATO	Ø	Nm	L (mm)	
YT-07722	1/4" (6.3 mm)	2.5-12	280-305	5
YT-07723	1/4" (6.3 mm)	4-20	280-305	5

GB Torque wrench
D Drehmomentschlüssel
PL Klucz dynamometryczny

RUS Ключ динамометрический
CZ Dynamometrický klíč
H Nyomatékkulcs

RO Cheie cu dinamometru
F Clé dynamométrique
I Chiave dinamometrica

E Llave dinamométrica
CN 传统型可调式扭力扳手

3/8" 10mm
TOLERANCE TOLERANȚA CW ++ 3% CCW ++ 3%
CrMo42
CrMo30



YATO	Ø	Nm	L (mm)	
YT-07730	3/8" (9.5 mm)	6-30	295-316	10
YT-07731	3/8" (9.5 mm)	10-60	362-385	12
YT-07732	3/8" (9.5 mm)	20-100	420-440	12
YT-07733	3/8" (9.5 mm)	25-125	415-440	12

GB Torque wrench
D Drehmomentschlüssel
PL Klucz dynamometryczny

RUS Ключ динамометрический
CZ Dynamometrický klíč
H Nyomatékkulcs

RO Cheie cu dinamometru
F Clé dynamométrique
I Chiave dinamometrica

E Llave dinamométrica
CN 传统型可调式扭力扳手

1/2"
12.5mm

TOLERANCE / TOLERANCIJA
CW +3%
CCW +3%

CrMo42
CrMo30



YATO	Ø	Nm	L (mm)	Box
YAT-07740	1/2" (12.7 mm)	10-60	360-385	12
YAT-07741	1/2" (12.7 mm)	20-100	420-440	15
YAT-07742	1/2" (12.7 mm)	25-125	415-440	12
YAT-07743	1/2" (12.7 mm)	40-200	445-465	12
YAT-07744	1/2" (12.7 mm)	65-335	505-525	9

GB Torque wrench
D Drehmomentschlüssel
PL Klucz dynamometryczny

RUS Ключ динамометрический
CZ Dynamometrický klíč
H Nyomatékkulcs

RO Cheie cu dinamometru
F Clé dynamométrique
I Chiave dinamometrica

E Llave dinamométrica
CN 传统型可调式扭力扳手

3/4"
19mm

TOLERANCE / TOLERANCIJA
CW +3%
CCW +3%

CrMo42
CrMo30



YATO	Ø	Nm	L (mm)	Box
YAT-07750	3/4" (19.0 mm)	80-400	685-704	5
YAT-07751	3/4" (19.0 mm)	100-500	825-845	2

GB Torque wrench
D Drehmomentschlüssel
PL Klucz dynamometryczny

RUS Ключ динамометрический
CZ Dynamometrický klíč
H Nyomatékkulcs

RO Cheie cu dinamometru
F Clé dynamométrique
I Chiave dinamometrica

E Llave dinamométrica
CN 传统型可调式扭力扳手

3/4"
19mm

TOLERANCE / TOLERANCIJA
≤ 500 Nm CW +3%
> 500 Nm CW +4%
CCW +3% CCW +4%

CrMo42
CrMo30



YATO	Ø	Nm	L (mm)	Box
YAT-07752	3/4" (19.0 mm)	160-800	1030-1050	2
YAT-07753	3/4" (19.0 mm)	200-1000	1030-1050	2

GB Torque wrench
D Drehmomentschlüssel
PL Klucz dynamometryczny

RUS Ключ динамометрический
CZ Dynamometrický klíč
H Nyomatékkulcs

RO Cheie cu dinamometru
F Clé dynamométrique
I Chiave dinamometrica

E Llave dinamométrica
CN 传统型可调式扭力扳手

1"
25mm

TOLERANCE / TOLERANCIJA
≤ 500 Nm CW +3%
> 500 Nm CW +4%
CCW +3% CCW +4%

CrMo42
CrMo30



YATO	Ø	Nm	L (mm)	Box
YAT-07760	1" (25.4 mm)	160-800	1030-1050	2
YAT-07761	1" (25.4 mm)	200-1000	1030-1050	2

GB Torque wrench
D Drehmomentschlüssel
PL Klucz dynamometryczny

RUS Ключ динамометрический
CZ Dynamometrický klíč
H Nyomatékkulcs

RO Cheie cu dinamometru
F Clé dynamométrique
I Chiave dinamometrica

E Llave dinamométrica
CN 传统型可调式扭力扳手

1"
25mm

TOLERANCE / TOLERANCIJA
≤ 500 Nm CW +3%
> 500 Nm CW +4%
CCW +3% CCW +4%

CrMo42
CrMo30



YATO	Ø	Nm	L (mm)	Box
YAT-07762	1" (25.4 mm)	300-1500	2160-2190	1

GB Torque wrench
D Drehmomentschlüssel
PL Klucz dynamometryczny

RUS Ключ динамометрический
CZ Dynamometrický klíč
H Nyomatékkulcs

RO Cheie cu dinamometru
F Clé dynamométrique
I Chiave dinamometrica

E Llave dinamométrica
CN 传统型可调式扭力扳手

3/4"
19mm

1/2"
12.5mm

CrV
6140



YATO	Ø	Nm	L (mm)	Box
YAT-0761	1/2" (12.7 mm)	40-210	516-534	10
YAT-0770	3/4" (19.0 mm)	100-500	845-860	4
YAT-0771	3/4" (19.0 mm)	140-980	1215-1230	2

GB Torque wrench
D Drehmomentschlüssel
PL Klucz dynamometryczny

RUS Ключ динамометрический
CZ Dynamometrický klíč
H Nyomatékkulcs

RO Cheie cu dinamometru
F Clé dynamométrique
I Chiave dinamometrica

E Llave dinamométrica
CN 传统型可调式扭力扳手

3/4"
19mm

1/2"
12.5mm

CrV
6140



YATO	Ø	Nm	L (mm)	Box
YAT-0754	1/2" (12.7 mm)	60-340	592-613	10
YAT-0755	3/4" (19.0 mm)	200-1000	1220-1245	2

GB Torque wrench
D Drehmomentschlüssel
PL Klucz dynamometryczny

RUS Ключ динамометрический
CZ Dynamometrický klíč
H Nyomatékkulcs

RO Cheie cu dinamometru
F Clé dynamométrique
I Chiave dinamometrica

E Llave dinamométrica
CN 传统型可调式扭力扳手

3/4"
19mm

TOLERANCE / TOLERANCIJA
CW +3%
CCW +5%

HRC
48-52
CrV
6140



YATO	Ø	Nm	L (mm)	Box
YAT-07711	3/4" (19.0 mm)	150-800	1155-1175	2

- GB** Dial torque wrench
D Drehmomentschlüssel mit Skalenmessuhr
PL Zegarowy klucz dynamometryczny
RUS Стрелочный динамометрический ключ
CZ Momentový klíč s kruhovou stupnicí
H Mérőtárcsás nyomatékkulcs
- RO** Cheie dinamometrica cu ceas
F Clé dynamométrique avec horloge
I Chiave dinamometrica a orologio
E Llave dinamométrica con reloj
CN 扭力扳手

1/4"	3/8"
6.3mm	10mm
1/2"	TOLERANCE TOLERANȚA
12.5mm	+ - 3%

- GB** Dial torque wrench
D Drehmomentschlüssel mit Skalenmessuhr
PL Zegarowy klucz dynamometryczny
RUS Стрелочный динамометрический ключ
CZ Momentový klíč s kruhovou stupnicí
H Mérőtárcsás nyomatékkulcs
- RO** Cheie dinamometrica cu ceas
F Clé dynamométrique avec horloge
I Chiave dinamometrica a orologio
E Llave dinamométrica con reloj
CN 扭力扳手

1/2"
12.5mm
TOLERANCE TOLERANȚA
+ - 3%



YATO	Ø	Nm	L (mm)	
YT-07830	1/4" (6.3 mm)	0.5-5	335	12
YT-07831	1/4" (6.3 mm)	1-10	335	5
YT-07832	3/8" (9.5 mm)	3-30	335	12
YT-07833	3/8" (9.5 mm)	5-50	335	12
YT-07834	1/2" (12.7 mm)	10-100	390	12

YATO	Ø	Nm	L (mm)	
YT-07835	1/2" (12.7 mm)	20-200	490	10
YT-07836	1/2" (12.7 mm)	30-300	590	10

- GB** Interchangeable torque handle
D Handgriff eines dynamometrischen Schlüssels
PL Rekojęść klucza dynamometrycznego
RUS Рукоятка динамометрического ключа
CZ Rukojeť dynamometrického klíče
H Nyomatékkulcs nyél
- RO** Mâner pt. cheie dinamometrică
F Clé dynamométrique sans embouts
I Maniglia per chiave dinamometrica
E Mango de llave dinamométrica
CN 扭力扳手



9x12 mm	14x18 mm	CrMo 30	TOLERANCE TOLERANȚA + - 3%
---------	----------	---------	----------------------------



YATO	Ø	Nm	L (mm)	
YT-07850	9x12	2.5-12	260-282	15
YT-07851	9x12	4-20	262-280	15
YT-07852	9x12	6-30	280-300	12
YT-07853	9x12	10-60	345-370	12
YT-07854	9x12	20-100	405-425	12
YT-07855	9x12	25-125	400-425	3
YT-07856	14x18	40-200	438-458	12
YT-07857	14x18	65-335	495-518	9
YT-07858	14x18	80-400	675-698	4

- GB** Removable head for torque wrench
D Umschaltknarrenkopf
PL Glowica do klucza dynamometrycznego
RUS Трещотчатая головка для динамометрического ключа
CZ Výměnná ráčna k momentovému klíči
H Külső cserélhető irányváltós racsnis
RO Cap cheie inelara interschimbabil pt. cheie dinamometrică
F Tête pour une clé dynamométrique
I Attacchi quadri di manovra
E Cabeza de anillo intercambiable para llave dinamométrica
CN 扭力扳手插件

1/4"	3/8"	1/2"	3/4"
6.3mm	10mm	12.5mm	19mm
9x12 mm	14x18 mm	RATCHET SYSTEM ZAPADKOWY	CrMo 42



YATO	Ø	Ø	
YT-07870	1/4" (6.3 mm)	9x12	40
YT-07871	3/8" (9.5 mm)	9x12	30
YT-07872	1/2" (12.7 mm)	9x12	30
YT-07873	1/2" (12.7 mm)	14x18	30
YT-07874	3/4" (19.0 mm)	14x18	20

- GB** Torque angle gauge
D Winkelmesser zum Anziehen von Schrauben
PL Kałomierz do dokręcania śrub
RUS Угломер для подвёртывания болтов
CZ Úhloměr k utahování šroubů
H Nyomaték szögmérő
RO Raportor pt. inșurubat șuruburi
F Rapporteur à serrer les vis
I Goniometro per il serraggio controllo
E Calibrador para apretar tornillos
CN 扭力角度规

1/2"	360°	CrV
12.5mm		



YATO	
YT-0593	12/48

- GB** Torque multiplier
D Drehmomentverstärker
PL Mechaniczny wzmacniacz momentu
RUS Мультипликатор крутящего момента
- CZ** Mechanicky posilovac momentu
H Nyomaték sokszorozó
RO Antrenor cu amplificator de forta
F Amplificateur de couple mécanique
- I** Moltiplicatore di coppia
E Mecanismo de reforzar el momento
CN 3倍扭力倍增器

3/4" max. 900 Nm	1" max. 2700 Nm	3:1	CrMo 4140
------------------	-----------------	-----	-----------



YATO	Ø (F)	Tmax. (Nm)	Ø (M)	Tmax. (Nm)	L (mm)	
YT-0781	3/4" (19.0 mm)	900	1" (25.4 mm)	2700	500	2

GB Labor save wrench
D Drehmomentverstärker
PL Mechaniczny wzmacniacz momentu
RUS Механический усилитель силы
CZ Mechanický posilovač momentu
H Nyomaték sokszorozó

RO Antrenor cu amplificator de forta
F Amplificateur de couple mécanique
I Moltiplicatore di coppia
E Mecanismo de reforzar el momento
CN 扭力倍增器

1"
25 mm
4200 Nm (max)
I-1:3.8
II-1:5.8
CrV



YATO	Ø	Nm	L (mm)	Box
YT-0782	1" (25.4 mm)	4200	330	1

GB Labor save wrench
D Drehmomentverstärker
PL Mechaniczny wzmacniacz momentu
RUS Механический усилитель силы
CZ Mechanický posilovač momentu
H Nyomaték sokszorozó

RO Antrenor cu amplificator de forta
F Amplificateur de couple mécanique
I Moltiplicatore di coppia
E Mecanismo de reforzar el momento
CN 扭力倍增器

1"
25 mm
5800 Nm (max)
1:66
CrV



YATO	Ø	Nm	L (mm)	Box
YT-07822	1" (25.4 mm)	5800	380	1

GB Auto-darkening welding helmet
D Schweißmaske, selbstverdunkelnd
PL Przyłbica spawalnicza samościemniająca
RUS Маска для сварки, самостоятельно затемняющаяся
CZ Svářečská kukla samostmívací
RO Mască de sudură auto-întunecare
F Masque de soudage
I Oscuramento casco di saldatura
E Casco auto-oscurecedor para soldadura
CN 工具车双挂板



- EN 379
- optical class: 1/1/1/1
- cover lens YT-73924 included
- klasa optyczna: 1/1/1/1
- w zestawie szybki ochronne YT-73924

DARK STATE STAN CIEMNY **9-13**
DIN 4 LIGHT STATE STAN JASNY
1/25000 s REACTION TIME CZAS REAKCJI
0.1 - 1.0 s BRIGHTENING TIME CZAS ROZJASNIANIA
FILTER TEST TEST FILTRA
LOW BATTERY ALARM WSKAZNIK POZIOMU BATERII
2x3V CR2045 BATTERIES NOT INCLUDED BATERII NIE DOŁĄCZONO
-5°C +55°C WORKING TEMPERATURE TEMPERATURA PRACY

4 POINT HEADGEAR
WIĘZBA 4 PUNKTOWA

Lock into a detent when lifted
Blokada w pozycji podniesionej

2-point crown strap adjustment to rise or lower the helmet
2 punktowa regulacja wysokości

3 position slider to adjust the distance from eyes to lens
3 pozycje regulacji odległości od filtra

Regulation at the occipital area
Regulacja pozycji potylicznej

Ratchet with soft rubber grip to adjust size without removing the helmet
Regulacji obwodu za pomocą systemu grzechotkowego

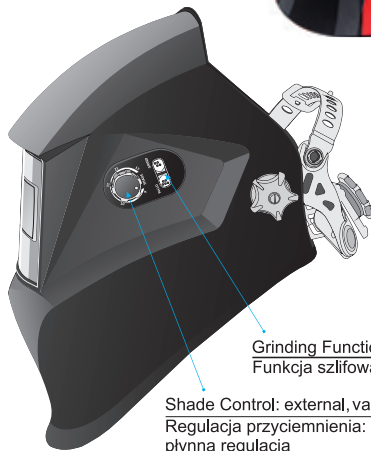
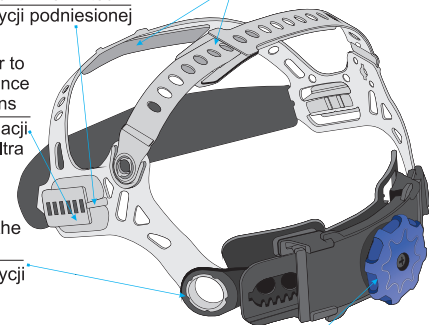

Grinding Function: YES
Funkcja szlifowania: TAK
Shade Control: external, variable
Regulacja przyciemnienia: zewnętrzna, płynna regulacja

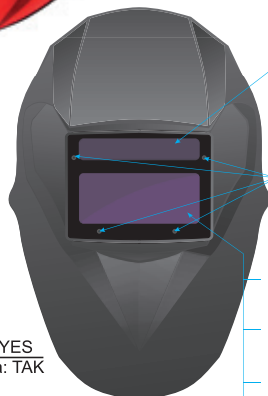

Solar cell filter power supply during welding
Ogniwio słoneczne zasilanie filtra podczas spawania
Arc Sensor: 4
Liczba czujników łuku: 4
Viewing Area: 98x43 mm
Obszar pola widzenia: 98x43 mm
UV/IR Protection
Ochrona przed promieniowaniem UV/IR
Automatic power on / off
Automatyczne włączenie / wyłączenie

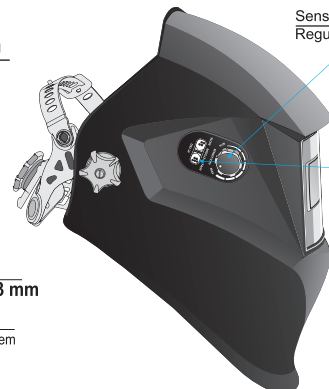

Sensitivity Control
Regulacja czułości
The rate of dimming
Szybkość ściemnienia 0.3 - 1.0 ms

YATO	Box
YT-73921	6

GB Front cover lens
D Außerschutzglas
PL Szybka ochronna do przyłbicy samościemniającej
RUS Стекло защитное наружное
CZ Přední krycí skličko
H Külső védőlemez

RO Protecția exterioră de plastic
F Verres de protection
I Martello per lamiera
E Cubierta de la lente de soldadura
CN 前盖镜片



5 PCS 123x98 mm PC

for / dla: YT-73921

POLYBAG

YATO	mm	Box
YT-73924	123x98	20/160

TYPE FC-11 EN 166:2001 B

GB Auto-darkening welding helmet
D Schweißmaske, selbstverdunkelnd
PL Przyłbica spawalnicza samościemniająca
RUS Маска для сварки, самостоятельно затемняющаяся
CZ Svářečská kukla samostmívací
H Önmagától sötétedő hegesztőpajzs

RO Mască de sudură auto-întunecare
F Masque de soudage
I Oscuramento casco di saldatura
E Casco auto-oscurecedor para soldadura
CN 工具车双挂板

VIEWING AREA
POLE WIDZENIA
100x50
mm

4
ARC SENSOR
LICZBA SENSORÓW

1/25000 s
REACTION TIME
CZAS REAKCJI

5-9 / 9-13
DIN
DARK STATE
STAN CIEMNY

DIN 4
LIGHT STATE
STAN JASNY

DIN 16
UV / IR
PROTECTION
OCHRONA

0.1 - 1.0 s
BRIGHTENING TIME
CZAS ROZJAŚNIANIA

SHADE
ŚCIEMNIANIE

SENSITIVITY
CZUŁOŚĆ

DELAY
OPÓZNIENIE

WELDING
SPAWANIE
MIG / MAG
MMA / TIG

GRINDING
SZLIFOWANIE

CUTTING
CIĘCIE

FILTER TEST
TEST FILTRA

-5°C to +55°C
WORKING TEMPERATURE
TEMPERATURA PRACY

2x3V
CR2032
BATTERIES
NOT INCLUDED
BATERIE
NIE DOŁĄCZONO

LOW BATTERY
ALARM
WSKAZNIK
POZIOMU
BATERII

Welding function: YES Grinding function: YES Cutting function: YES
Funkcja spawania: TAK Funkcja szlifowania: TAK Funkcja cięcia: TAK



Sensitivity control: external, variable
Płynna regulacja czułości

Shade control: external, variable
Płynna regulacja przyciemnienia

Delay control: external, variable
Płynna regulacja opóźnienia



COLOR BOX

- EN 379
- optical class: 1 / 1 / 1 / 2
- klasa optyczna: 1 / 1 / 1 / 2

YATO	
YT-73925	6

GB Auto-darkening welding helmet
D Schweißmaske, selbstverdunkelnd
PL Przyłbica spawalnicza samościemniająca
RUS Маска для сварки, самостоятельно затемняющаяся
CZ Svářečská kukla samostmívací
H Önmagától sötétedő hegesztőpajzs

RO Mască de sudură auto-întunecare
F Masque de soudage
I Oscuramento casco di saldatura
E Casco auto-oscurecedor para soldadura
CN 工具车双挂板

VIEWING AREA
POLE WIDZENIA
100x60
mm

4
ARC SENSOR
LICZBA SENSORÓW

1/25000 s
REACTION TIME
CZAS REAKCJI

5-9 / 9-13
DIN
DARK STATE
STAN CIEMNY

DIN 4
LIGHT STATE
STAN JASNY

DIN 16
UV / IR
PROTECTION
OCHRONA

0.1 - 1.0 s
BRIGHTENING TIME
CZAS ROZJAŚNIANIA

SHADE
ŚCIEMNIANIE

SENSITIVITY
CZUŁOŚĆ

DELAY
OPÓZNIENIE

WELDING
SPAWANIE
MIG / MAG
MMA / TIG

-5°C to +55°C
WORKING TEMPERATURE
TEMPERATURA PRACY

2x3V
CR2032
BATTERIES
NOT INCLUDED
BATERIE
NIE DOŁĄCZONO

FILTER TEST
TEST FILTRA

Delay control: external, variable
Płynna regulacja opóźnienia

Welding function: YES
Funkcja spawania: TAK

Cutting function: YES
Funkcja cięcia: TAK

Grinding function: YES
Funkcja szlifowania: TAK

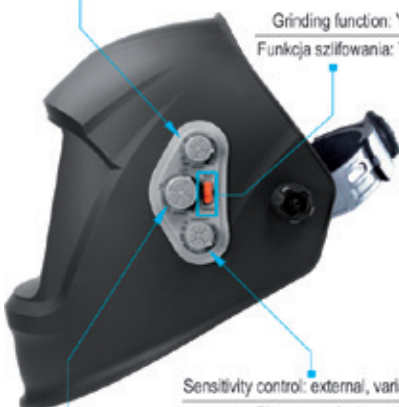

Sensitivity control: external, variable
Płynna regulacja czułości

Shade control: external, variable
Płynna regulacja przyciemnienia



COLOR BOX

- EN 379
- optical class: 1 / 1 / 1 / 2
- klasa optyczna: 1 / 1 / 1 / 2

YATO	
YT-73926	6

GB Front cover lens
D Außerschutzglas
PL Szybka ochronna do przyłbicy samościemniającej
RUS Стекло защитное наружное
CZ Přední krycí sklíčko
H Külső védőlemez

RO Protecția exterioră de plastic
F Verres de protection
I Martello per lamiera
E Cubierta de la lente de soldadura
CN 前盖镜片



5
PCS

137x120
mm

1.0mm
THICKNESS
GRUBOSC

PC

for / dla:
YT-73925, YT-73926, 74484

POLYBAG
WITH
HEADER

YATO	mm	
YT-73929	137x120	20

TYPE EN 166:2001 F

- GB** Auto body fender set
D Karosserie-Ausbausatz
PL Komplet młotków blacharskich
RUS Молотки рихтовочные
CZ Souprava klempířských kladívek
H Bádogos kalapács készlet
RO Set de ciocane de tablă
F Set pour carrossier
I Martello per lamiera
E Juego de mazos de hojalatero
CN 钣金工具组套



7
PCS

DROP FORGED KUTE

GENUINE HICKORY



BMC & COLOR SLEEVE

YATO	m (g)	
YT-4590	4900	4

- GB** Ball pein hammer
D Ausbeulhammer
PL Młotek blacharski
RUS Молоток рихтовочный
- CZ** Klempířské kladívko
H Bádogos kalapács
RO Ciocan pt. tablă
F Marteau à panne ronde
- I** Martello per lamiera
E Martillo de hojalatero
CN 圆头锤

FIBREGLASS
WŁÓKNO
SZKLANE

- GB** Ball pein hammer
D Ausbeulhammer
PL Młotek blacharski
RUS Молоток рихтовочный
- CZ** Klempířské kladívko
H Bádogos kalapács
RO Ciocan pt. tablă
F Marteau à panne ronde
- I** Martello per lamiera
E Martillo de hojalatero
CN 圆头锤



YATO	m (g)	L (mm)	A (mm)	H (mm)	
YT-4515	225	280	26	80	6/36
YT-4516	450	315	34	100	6/24
YT-4518	900	380	40	125	6/12

YATO	m (g)	L (mm)	A (mm)	H (mm)	
YT-4519	225	295	26	80	6/36
YT-4520	450	335	35	100	6/24
YT-4521	680	360	36	115	6/12
YT-4522	900	380	40	125	6/12

- GB** Dead blow mallet
D Rückschlagsfreier Schonhammer
PL Młotek bezodrzutowy
RUS Молоток безинерционный
CZ Palička nárazová plněná celogumová
H Visszarúgás mentes gumikalapács
- RO** Ciocan cu absorbție
F Maillet sans recul
I Martello morto colpo
E Martillo sin reacción
CN 尼龙安装锤

PU

- GB** Dead blow mallet
D Rückschlagsfreier Schonhammer
PL Młotek bezodrzutowy
RUS Молоток безинерционный
CZ Palička nárazová plněná celogumová
- H** Visszarúgás mentes gumikalapács
RO Ciocan cu absorbție
F Maillet sans recul
I Martello morto colpo
E Martillo sin reacción
CN 防震无回弹橡胶锤

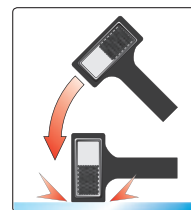

YATO	m (g)	L (mm)	Ø (mm)	H (mm)	
YT-4624	265	318	30.0	94	10/40
YT-4625	430	350	40.0	100	6/36
YT-4626	490	348	45.0	110	6/36

YATO	m (g)	L (mm)	Ø (mm)	H (mm)	
YT-4620	740	300	44.5	100.0	4/24
YT-4622	900	336	53.5	100.0	4/24
YT-4623	1300	350	59.0	118.5	3/12

PU

- GB** Spot weld cutter & drill bit set
D Schweisspunktbohrer
Set Schweißpunktfräser
PL Zestaw rozwiertaków do zgrzewów punktowych
RUS Набор для высверливания точечной сварки
CZ Sada na odvrtání bodových svárů
H Hegesztőpont maró készlet
RO Set de freze pt. suduri în puncte
F Jeu de fraises pour points de soudure
I Set di alesatori per punti di saldatura
E Juego de brocas para puntos de soldadura
CN 点焊刀



9
PCS

Ø 8mm

Ø 10mm

HSS

METAL BOX & COLOR BOX

- GB** Drill welding points set
D Schweisspunkt-Fräasersatz
PL Zestaw wiertel do zgrzewów punktowych
RUS Набор сверл для точечной сварки
CZ Frézy pro bodové sváry
H Pont hegesztés lefúró készlet
RO Set burghiu puncte sudura
F Forets à dépointer les points soudure
I Set di alesatori per punti di saldatura
E Juego de brocas para puntos de soldadura
CN 3件套电焊



3
PCS

COBALT COATED POKRYTE KOBALTEM



YATO		
YT-28920		10/60

YATO	Ø (mm)	
YT-28921	6.5; 8.0; 10.0	50

- GB** Combination edge setter / hole punch pliers
D Kombinierte Absetzange Lochzange
PL Dziurkarko-felcarka
RUS Дырокол, кромогиб
CZ Falcovačka a děrovačka
H Lyukasztó peremező fogó
RO Cleste pt. fasonat si gaurit tabla

- F** Pince spéciale perforatrice carrosserie
I Combinazione: bordo setter / pinza perforare
E Solapadora y ponchadora manual
CN 点焊刀

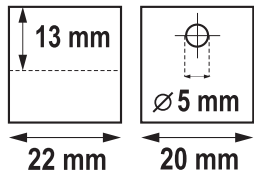

HANGING
COLOR BOX



YATO		
YT-21582		10

- GB** Adjustable angle welding magnet
D Verstellbarer Magnet-Werkstückhalter
PL Wspornik magnetyczny spawalniczy regulowany
RUS Регулируемый магнит заварки угла
CZ Polohovací magnetický držák ke svařování
H Állítható, mágneses, hegesztő támasz
RO Dispozitiv magnetic reglabil pt. sudura
F Support magnétique de soudure
I Supporto della saldatura magnetico
E Soporte magnético de soldadura, ajustable
CN 焊接磁铁



DOUBLE
BLISTER

YATO	⌋ (kg)	mm	
YT-0862	2x22.5	85x65x22	6

- GB** Magnetic welding holder
D Magnet-Werkstückhalter
PL Kątownik magnetyczny spawalniczy
RUS Магнитная струбина заварки

- CZ** Magnetický uhelník ke svařování
H Mágneses, hegesztő szögvas
RO Dispozitiv magnetic fixare pt. sudura
F Support magnétique de soudure

- I** Angolo magnetico da saldatura
E Escuadra magnética de soldadura
CN 焊接磁铁

DOUBLE
BLISTER



YATO	⌋ (kg)	mm	
YT-0863	11.5	82x120x13	6/48

YATO	⌋ (kg)	∅ (mm)	mm	
YT-0864	22.5	18	102x155x17	6/30
YT-0865	34.0	46	122x190x25	6/18

- GB** Magnetic welding holder
D Magnet-Werkstückhalter
PL Kątownik magnetyczny spawalniczy
RUS Магнитная струбина заварки
CZ Magnetický uhelník ke svařování
H Mágneses, hegesztő szögvas

- RO** Dispozitiv magnetic fixare pt. sudura
F Support magnétique de soudure
I Triangolo magnetico da saldatura con interruttore
E Escuadra magnética de soldadura con interruptor
CN 焊接磁铁

- GB** Magnetic welding holder with switch
D Magnet-Werkstückhalter mit Schalter
PL Kątownik magnetyczny spawalniczy z wyłącznikiem
RUS Магнитный держатель заварки с выключателем
CZ Magnetický uhelník ke svařování s vypínačem
H Mágneses, hegesztő szögvas, kapcsolóval

- RO** Dispozitiv magnetic fixare pt. sudura cu intrerupator
F Support magnétique de soudure
I Triangolo magnetico da saldatura con interruttore
E Escuadra magnética de soldadura, con interruptor
CN 焊接磁铁

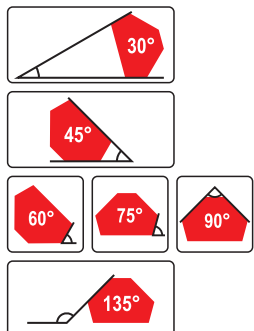

DOUBLE
BLISTER



YATO	⌋ (kg)	mm	
YT-0866	11.5	64x95x14	6/24
YT-0867	34.0	111x136x24	6/18



DOUBLE
BLISTER



YATO	⌋ (kg)	mm	
YT-0870	13.5	107x160x26	6/24

- GB** Magnetic welding holder set
D Magnetschweißhalter-Set
PL Zestaw magnetycznych uchwytów spawalniczych
RUS Комплект магнитных сварочных ручек
CZ Sada magnetických svařovacích úchytů
H Mágneses hegesztő tartó készlet

- RO** Set suporti magnetici sudura
F Kit positionneur magnétique de soudure
I Kit di pinze magnetiche per saldatura
E Set de portaelectrodos magnéticos
CN 焊接磁铁

DOUBLE
BLISTER



2
PCS



60°

90°

120°

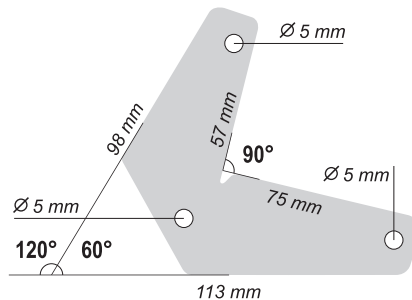

YATO	⤴ (kg)	size / rozmiar (mm)	📦
YT-08721	10	98x113	6/24

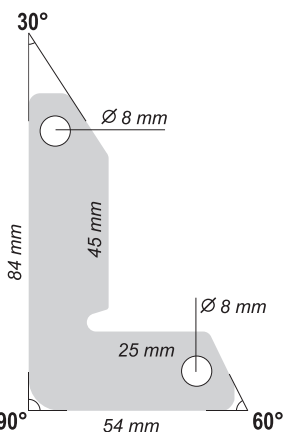
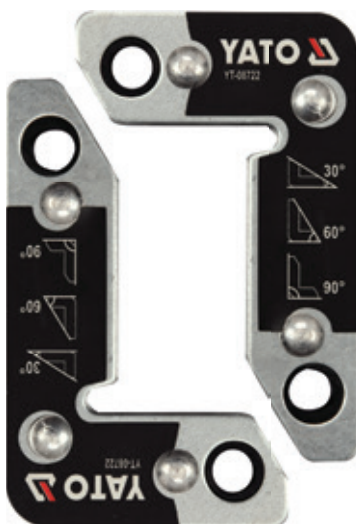

30°

60°

90°

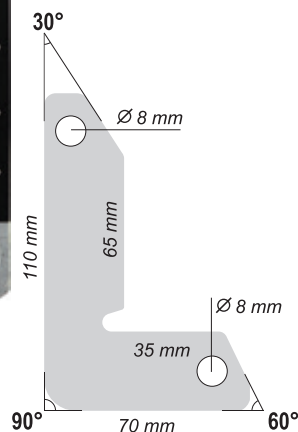

30°

60°

90°

YATO	⤴ (kg)	size / rozmiar (mm)	📦
YT-08722	25	54x84	40
YT-08723	32	70x110	32

- GB** Magnetic welding ground
D Schweißerdungsklemme
PL Spawalniczy zacisk uziemiający
RUS Сварочный зажим заземляющий
CZ Svařovací svorka zemnicí
H Földelő csatlakozó hegesztőhöz
RO Suport sudura magnetic
F Pince de masse pour soudure
I Morsetti di terra per saldatura
E Pinza de tierra para soldadura
CN 磁性焊接接地夹

DOUBLE
BLISTER



7kg

500A
max.

Ø 85mm



YATO	⤴ (kg)	size / rozmiar (mm)	📦
YT-08625	7	85	6/24

- GB Oil-filter wrench with chain
- D Rohrzanze für Ölfilter
- PL Klucz łańcuchowy do filtrów oleju
- RUS Цепной ключ для масляных фильтров
- CZ Řetězový klíč pro olejové filtry
- H Olajszűrő-lánckulcs
- RO Cheie filtru ulei cu lant
- F Clé à chaîne pour filtre à huile
- I Chiave a catena per filtri d'olio
- E Llave de cadena para filtros de aceite
- CN 过滤器链式扳手



1/2"	DOUBLE CHAIN	CrV
12.5mm	PODWÓJNY ŁAŃCUCH	

SLIDING CARD



YATO	Ø (mm)	
YT-08253	60-115	5/30
YT-08254	75-170	5/30

- GB Oil filter wrench
- D Ölfilterschlüssel
- PL Klucz do filtra oleju
- RUS Ключ к масляному фильтру
- CZ Klíč na olejový filtr
- H Olajszűrő leszedő
- RO Cheie pt. filtru de ulei
- F Clé au filtre d'huile
- I Chiave per filtro olio
- E Llave para el filtro de aceite
- CN 滤清器扳手



SLIDING CARD



YATO	Ø (mm)	
YT-0820	60-73	12/48
YT-0821	73-85	12/48
YT-0822	85-95	12/48
YT-0823	95-111	12/48

- GB Belt oil wrench
- D Ölfilterschlüssel mit Riemen
- PL Klucz taśmowy do filtrów oleju
- RUS Ключ тросовый для масляных фильтров
- CZ Klíč na olejové filtry
- H Olajszűrő leszedő
- RO Cheie filtru cu banda
- F Clé au filtre d'huile
- I Chiave a nastro per filtro olio
- E Llave de cinta para filtros de aceite
- CN 皮带钳扳手



BLISTER CARD



YATO	Ø (mm)	
YT-0824	80-160	6/60
YT-0825	100-200	5/20

- GB Oil filter wrench
- D Ölfilterschlüssel
- PL Klucz do filtra oleju
- RUS Съёмник масляных фильтров
- CZ Klíč na filtr oleju řetězový
- H Olajszűrő leszedő, 3 kőrmős
- RO Cheie filtru ulei cu lanț
- F Clé au filtre d'huile
- I Chiave per filtro olio
- E Llave de filtro de cadenta
- CN 滤清器扳手



63-120 mm	3/8"	1/2"
2.5-4"	10.0 mm	12.5 mm

HRC 40-50 CrV

YATO	
YT-0826	12/36

COLOR BOX



- GB Fuel filter socket
- D Aufsatz für Kraftstofffilter
- PL Nasadka do filtra paliwa
- RUS Крышка для топливного фильтра
- CZ Násada do palivového filtru
- H Üzemanyagszűrő fedél kulcs
- RO Cheie pt. filtru combustibil
- F Douille pour filtre à carburant
- I Attacco per filtro del carburante
- E Vaso para filtro de combustible
- CN 燃油过滤器套筒



27 mm	FOR FUEL FILTER DO FILTRA PALIWA	CrV
-------	----------------------------------	-----

PLASTIC HANGER



YATO	Ø	
YT-12000	1/2" (12.7 mm)	20/40

- GB Cap type oil filter wrench set
- D Steckschlüsselsatz für den Ölfilter
- PL Zestaw kluczy nasadowych do filtra oleju
- RUS Набор торцовых ключей к масляному фильтру
- CZ Sada miskovitých klíčů na olejové filtry
- H Dugókulcs készlet olajszűrőhöz
- RO Set de chei tubulare pt. filtru de ulei
- F Set d'embouts aux filtres d'huile
- I Set di chiavi filtro olio
- E Juego de llaves de tubo para el filtro de aceite
- CN 碗型滤清器扳手组套

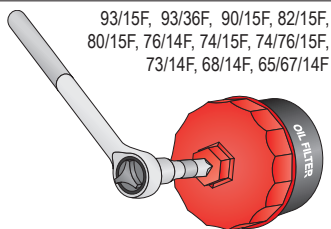

93/15F, 93/36F, 90/15F, 82/15F, 80/15F, 76/14F, 74/15F, 74/76/15F, 73/14F, 68/14F, 65/67/14F



15 PCS	FIBRE REINFORCED POLYMER	3/8"
		10 mm

BMC & COLOR SLEEVE



YATO	Ø	
YT-0595	3/8" (9.5 mm)	5

GB Cap type oil filter wrench set
D Steckschlüsselsatz für den Ölfilter
PL Zestaw kluczy nasadowych do filtra oleju
RUS Набор торцовых ключей к масляному фильтру
CZ Sada miskovitých klíčů na olejové filtry
H Dugókulcs készlet olajsűrőhöz

RO Set de chei tubulare pt. filtru de ulei
F Set d'embouts aux filtres d'huile
I Set di chiavi filtro olio
E Juego de llaves de tubo para el filtro de aceite
CN 碗型滤清器扳手组套

13 PCS
3/8" 10mm
1/2" 12.5mm
65-120 mm

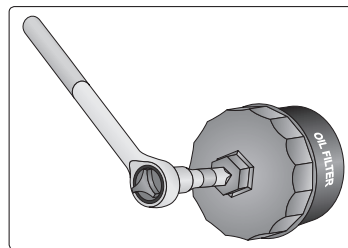

BMC & COLOR SLEEVE



YATO	number	size	layers	grooves	faces	car models
	number	rozmiar	warstwy	bruzdy	powierzchnie	modele samochodu
YT-0594	66/6	SW66	1	6		Fiat Punto 1.2, Renault Clio 1.2, Rapid, Twingo
	76/8	SW76	1	8		Fiat, Lancia
	76/12	SW76	1		12	Fiat, Mercedes, Renault
	86/16	SW86	1		16	Volvo
	86/18	SW86	1		18	VW Golf, Audi A6 TDI, Peugeot, Citroen
	92/10	SW92	1		10	Fiat
	93/45	SW93	1	45		VW, Audi TDI
	96/18	SW96	1	18		Audi A4, A6 TDI, VQ Passat TDI, Renault Laguna
	106/15	SW106	1		15	Fiat Ducato
	108/15	SW108	1		15	Volvo
	108/18	SW108	1	18		Renault Espace, Laguna, Safrane, Traffic

GB Cap type oil filter wrench set
D Steckschlüsselsatz für den Ölfilter
PL Zestaw kluczy nasadowych do filtra oleju
RUS Набор торцовых ключей к масляному фильтру
CZ Sada miskovitých klíčů na olejové filtry
H Dugókulcs készlet olajsűrőhöz

RO Set de chei tubulare pt. filtru de ulei
F Set d'embouts aux filtres d'huile
I Set di chiavi filtro olio
E Juego de llaves de tubo para el filtro de aceite
CN 碗型滤清器扳手组套

30 PCS
3/8" 10mm

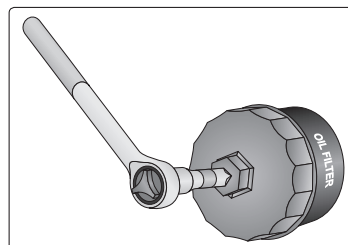

BMC & COLOR SLEEVE



YATO	number	size	layers	grooves	faces	car models
	number	rozmiar	warstwy	bruzdy	powierzchnie	modele samochodu
YT-0596	66/6	SW66	1	6		Fiat Punto 1.2, Renault Clio 1.2, Rapid, Twingo
	65/14	SW65	1		14	Daihatsu, Toyota, Nissan, Fiat
	65/67	SW65-67	1		14	Daihatsu, Toyota
	68/14	SW68	1		14	Mazda, Ford, Subaru
	73/14	SW73	1		14	Toyota, Lexus
	74/15	SW74	1		15	Audi, Rover, Chrysler
	74/76	SW74-76	2		15	Ford, Opel, VW, Audi, Mercedes
	75/77	SW75-77	2		15	VW, Audi, Isuzu, Mercedes
	76/12	SW76	1		12	Fiat, Mercedes, Renault
	76/14	SW76	1		14	VW, Porsche, Mercedes, BMW, Audi, Opel
	76/30	SW76	1	30		Ford
	76/8	SW76	1	8		Fiat, Lancia
	78/15	SW78	1		15	Nissan, Ford, Toyota
	80/15	SW80	1		15	Nissan, Honda, Opel, Mazda
	80/82	SW80-82	2		15	Subaru, Toyota, Honda, Nissan
	86/16	SW86	1		16	Volvo
	86/18	SW86	1		18	VW Golf, Audi A6 TDI, Peugeot, Citroen
	90/15	SW90	1		15	Honda, Mitsubishi, Isuzu
	92/10	SW92	1		10	Fiat
	93/15	SW93	1		15	Mazda, Volvo, Mitsubishi, Nissan, Honda
	93/36	SW93	1	36		Ford
	93/45	SW93	1	45		VW, Audi TDI
	95/15	SW95	1	15		Toyota, Alfa Romeo, Ford
	96/18	SW96	1	18		Audi A4, A6 TDI, VQ Passat TDI, Renault Laguna
	100/15	SW100	1		15	Isuzu, Mitsubishi
	106/15	SW106	1		15	Fiat Ducato
	108/15	SW108	1		15	Volvo
	108/18	SW108	1	18		Renault Espace, Laguna, Safrane, Traffic

- GB** Oil filter sockets
- D** Aufsätze für die Ölfilter
- PL** Zestaw nasadek do filtrów oleju
- RUS** Набор насадок к масляным фильтрам
- CZ** Sada nástavců na olejové filtry
- H** Olajszűrő leszedő készlet
- RO** Set de cartușe pt. filtre de ulei
- F** Set d'embouts aux filtres d'huile
- I** Set di chiavi filtro olio
- E** Juego de tapones para los filtros de aceite
- CN** 滤油器套筒组套



4 PCS	3/8" 10mm	27 32 36 38 mm
		CrV AS-DRIVE
BMC & COLOR SLEEVE		
YATO		
YT-0598	3/8" (9.5 mm)	20

- GB** Square oil drain plug wrench
- D** Schlüssel für Ölablassschraube
- PL** Klucz do korków spustowych oleju
- RUS** Ключ для масляной пробки
- CZ** Klíč do sroustěcích zátek oleje
- H** Olajleeresztő csavar kulcs
- RO** Cheie pt. buson ulei

- F** Clé pour bouchons de vidange d'huile
- I** Chiave per tappo di scarico olio
- E** Llave para tapones de descarga de aceite
- CN** 方形8mmx10mm放油塞扳手

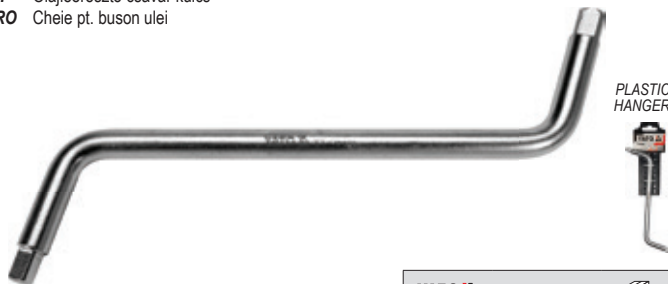

PLASTIC HANGER

for / dla: PEUGEOT, RENAULT, VOLVO

YATO		
YT-05995		6/36

- GB** Oil drain plug set
- D** Ölablassschrauben Schlüsselsatz
- PL** Komplet kluczy do korków oleju
- RUS** Комплект ключей для сливной пробки
- CZ** Klíče nástrčné na zátky olejových van motorů
- H** Olajleeresztő kulcs készlet

- RO** Set bituri pt. bujon ulei
- F** Ensemble de clés de bouchon de vidange d'huile
- I** Set di chiavi a bussola
- E** Juego de llaves para tapones de aceite
- CN** 排油塞旋具组套

6 PCS	3/8" 10mm	CrV
-----------------	---------------------	------------

- 8, 3/8", 10, 12, 1/2", 14 mm
- 3/8" (10 mm), 1/2" (12.5 mm)

YATO		
YT-05997	3/8" (9.5 mm)	10/40



DOUBLE BLISTER

- GB** Oil drain plug set
- D** Ölablassschrauben Schlüsselsatz
- PL** Komplet kluczy do korków oleju
- RUS** Комплект ключей для сливной пробки
- CZ** Klíče nástrčné na zátky olejových van motorů
- H** Olajleeresztő kulcs készlet

- RO** Set bituri pt. bujon ulei
- F** Ensemble de clés de bouchon de vidange d'huile
- I** Set di chiavi a bussola
- E** Juego de llaves para tapones de aceite
- CN** 排油塞旋具组套

18 PCS	3/8" 10mm	7 8 10 11 12 13 14 mm
		8, 10 mm
		8 9 10 12 14 17 mm
		5/16" 3/8"
		10 mm
CrV		

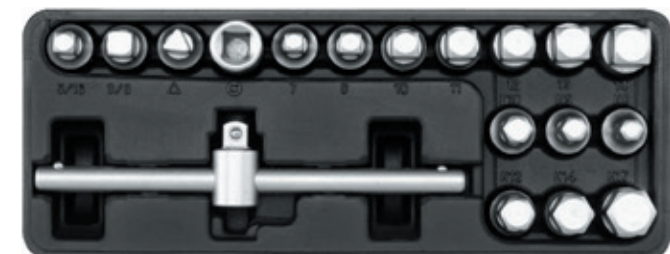

- 7, 8, 10, 11, 12, 13, 14 mm;
- 8, 9, 10, 12, 14, 17 mm;
- 5/16" (8 mm), 3/8" (10 mm);
- 10 mm; 10 mm;
- 160 mm

BMC & COLOR SLEEVE

YATO		
YT-0599	3/8" (9.5 mm)	10

- GB** Oil drain plug set
- D** Ölablassschrauben Schlüsselsatz
- PL** Komplet kluczy do korków oleju
- RUS** Комплект ключей для сливной пробки
- CZ** Klíče nástrčné na zátky olejových van motorů

- H** Olajleeresztő kulcskészlet
- RO** Set bituri pt. bujon ulei
- F** Set de clés à vidange d'huile
- I** Set di chiavi per tappi olio
- E** Juego de llaves para tapones de aceite
- CN** 排油塞旋具组套

12 PCS	3/8" 10mm	(mm) 3/8" 8 9 8 11 13
------------------	---------------------	--------------------------



BMC & COLOR SLEEVE

YATO		
YT-0600		10

- GB** Oil pan thread repair set
- D** Reparatursatz für Verschlußstopfen von Ölwanen
- PL** Zestaw naprawczy korków do miski olejowej
- RUS** Набор для ремонта масляных пробок
- CZ** Souprava na opravu vřroustěcích šřroubů olejových van
- H** Olajteknő-csavar javítőkészlet

- RO** Set pt. reparare dopuri baie de ulei
- F** Kit reparation de bouchons de carter d'huile
- I** Set per riparazione dei tappi della coppa del olio
- E** Juego de reparación para los tapones del cárter de aceite
- CN** 螺纹修复组套

- | | | | | | |
|-----|--|-------|--|--------|--------------------------|
| M13 | | M13 | | 13 mm | <input type="checkbox"/> |
| | | 5 pcs | | 10 pcs | <input type="checkbox"/> |
| M15 | | M15 | | 15 mm | <input type="checkbox"/> |
| | | 5 pcs | | 10 pcs | <input type="checkbox"/> |
| M17 | | M17 | | 17 mm | <input type="checkbox"/> |
| | | 5 pcs | | 10 pcs | <input type="checkbox"/> |
| M20 | | M20 | | 20 mm | <input type="checkbox"/> |
| | | 5 pcs | | 10 pcs | <input type="checkbox"/> |



64 PCS	CrMo
------------------	-------------

BMC & COLOR SLEEVE

YATO		
YT-1757		5

- GB** Oil pan thread repair set
D Reparatursatz für Verschlussstopfen von Ölwannen
PL Zestaw naprawczy korków do miski olejowej
RUS Набор для ремонта масляных пробок
CZ Souprava na opravu vypoustěcích šroubů olejových van
H Olajteknő-csavar javítókészlet
RO Set pt. reparare dopuri baie de ulei
F Carter d'huile fil kit de réparation
E Juego de reparación para los taponés del cárter de aceite
CN 螺纹修复组套



7
PCS

PLASTIC
BOX



YATO	size / rozmiar (mm)	
YT-17571	M13x1.5	10/40
YT-17572	M15x1.5	10/40
YT-17573	M17x1.5	10/40
YT-17574	M20x1.5	10/40
YT-17575	M22x1.5	10/40

- GB** Grease gun
D Handhebel-Fettpresse
PL Smarownica ręczna
RUS Шприц для масляной смазки
CZ Páková maznice
- H** Karos zsírózó
RO Masina de gresat cu furturn rigid
F Pistolet de graissage manuel
- I** Lubrificatore manuale
E Pistola de engrase
CN 大容量黄油枪

COLOR BOX



P_{max.}
70 MPa

P
31 MPa

AI



500
cm³

YATO	
YT-0700	20



120
cm³

YATO	
YT-0701	30



400
cm³

YATO	
YT-0705	20



600
cm³

YATO	
YT-0704	6

- GB Grease gun
D Handhebel-Fettpresse
PL Smarownica ręczna
RUS Шприц для масляной смазки
CZ Páková maznice
H Karos zsírzó
RO Masina de gresat cu furturn rigid

- F Pistolet de graissage manuel
I Lubrificatore manuale
E Pistola de engrase
CN 大容量黄油枪



COLOR BOX



P (MPa)
27-41

AI

600
cm³

YATO
YT-07042 6/12



800
cm³

YATO
YT-07043 4/8

- GB Two-way operation grease gun
D Handhebel-Fettpresse
PL Smarownica ręczna, wzmacniona
RUS Шприц для масляной смазки
CZ Páková maznice
H Karos zsírzó
RO Masina de gresat cu furturn rigid
F Pistolet de graissage manuel
I Lubrificatore manuale
E Pistola de engrase
CN 大容量黄油枪

COLOR BOX



500
cm³

P max.
70 MPa

AI

P
42 MPa

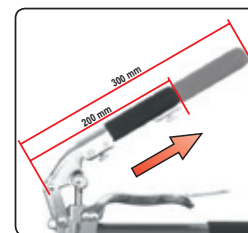

YATO
YT-0704 12

- GB Two-way operation grease gun
D Handhebel-Fettpresse
PL Smarownica ręczna, wzmacniona
RUS Шприц для масляной смазки
CZ Páková maznice
H Karos zsírzó
RO Masina de gresat cu furturn rigid

- F Pistolet de graissage manuel
I Lubrificatore manuale
E Pistola de engrase
CN 大容量黄油枪

HIGH PRESSURE
69 MPa
LOW VOLUME
14 g / 40 STROKE

WYSOKIE CIŚNIENIE
69 MPa
NISKA WYDAJNOŚĆ
14 g / 40 CYKLI

LOW PRESSURE
6.9 MPa
HIGH VOLUME
100 g / 40 STROKE

NISKIE CIŚNIENIE
6.9 MPa
WYSOKA WYDAJNOŚĆ
100 g / 40 CYKLI

500
cm³

P max.
70 MPa

AI

P
42 MPa

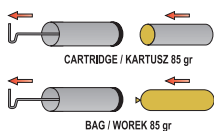

COLOR BOX



YATO
YT-07041 10

- GB Air grease gun
D Druckluft-Fettpresse
PL Smarownica pneumatyczna
RUS Шприц для нагнетания густой смазки пневматический
CZ Mazací lis pneumatický
H Pneumatikus zsírzó
RO Pistol pt. gresat pneumatic
F Pistolet de graissage pneumatique
I Pneumatica per ingrassaggio
E Pistola engrasadora neumática
CN 气动黄油枪



400
cm³

28
l/min

STANDARD

COLOR BOX



YATO
YT-07055 10

L_{PA} = 93 ± 3 dB;
L_{WA} = 104 ± 3 dB;
a_v = 2,5 ml/s²

- GB Air grease gun
D Druckluft-Fettpresse
PL Smarownica pneumatyczna
RUS Шприц для нагнетания густой смазки пневматический
CZ Mazací lis pneumatický
H Pneumatikus zsírzó
RO Pistol pt. gresat pneumatic
F Pistolet de graissage pneumatique
I Pneumatica per ingrassaggio
E Pistola engrasadora neumática
CN 气动黄油枪



0.63
MPa

400
cm³

220
l/min

STANDARD

COLOR BOX



YATO
YT-07057 10

L_{PA} = 70 dB;
L_{WA} = 80 dB;
a_v = 2,5 ml/s²

- GB Oil transfer pump
D Öl-Umfölpumpe
PL Pompa transferowa do oleju
RUS Шприц для перекачки масел
CZ Ruční olejová pumpa
H Olajpumpa
RO Pompa de ulei de mana
F Pompe pour huile
I Lubrificatore manuale per travaso olio
E Bomba manual de trasvase dual
CN 输油泵



500 cm³ P max. 70 MPa P 31 MPa

COLOR BOX



YATO		
YT-0707		20

- GB Oil drainer
D Öl-Absaugpumpe
PL Odsysarka ręczna do oleju
RUS Ручной шприц для откачки масла
CZ Ruční odsávačka oleje
H Kézi olajszivattyú
RO Pompa de ulei
F Seringue à huile
I Lubrificatore manuale per aspirazione olio
E Bomba manual de trasvase
CN 输油泵



500 cm³ P max. 70 MPa P 31 MPa

COLOR BOX



YATO		
YT-0708		20

- GB Pneumatic grease injector
D Druckluft-Fettpresse
PL Towotnica / smarownica pneumatyczna
RUS Пневматический нагнетатель смазки
CZ Pneumatiké-čerpadlo maziv
H Pneumatikus zsír szivattyú
RO Pompa de unsoare pneumatice
F Pompe a graisse pneumatique
I Pneumatica per ingrassaggio
E Bomba de engrase neumática lubricar
CN 注油器

12l 0.6-0.8 MPa 40 MPa (max)
4m HOSE WAZ 50:1 RATIO SPREZANIE STANDARD



GREY CARTON BOX & COLOR LABEL



L_{PA} = 97 ± 3 dB;
L_{WA} = 108 ± 3 dB

YATO		
YT-07067		1

- GB Pneumatic grease injector
D Druckluft-Fettpresse
PL Smarownica pneumatyczna
RUS Пневматический нагнетатель смазки
CZ Pneumatiké-čerpadlo maziv
RO Pompa de unsoare pneumatice

- F Pompe a graisse pneumatique
I Pneumatica per ingrassaggio
E Bomba de engrase neumática lubricar
CN 注油器

30l 0.6-0.8 MPa 40 MPa (max) 4m HOSE WAZ 50:1 RATIO SPREZANIE STANDARD



GREY CARTON BOX & COLOR LABEL



L_{PA} = 97 ± 3 dB;
L_{WA} = 108 ± 3 dB

YATO		
YT-07068	30	1

- GB Pneumatic grease injector
D Druckluft-Fettpresse
PL Smarownica pneumatyczna
RUS Пневматический нагнетатель смазки
CZ Pneumatiké-čerpadlo maziv
H Pneumatikus zsír szivattyú
RO Pompa de unsoare pneumatice
F Pompe a graisse pneumatique
I Pneumatica per ingrassaggio

- E Bomba de engrase neumática lubricar
CN 注油器

45l 0.6-0.8 MPa 40 MPa (max) 4m HOSE WAZ 50:1 RATIO SPREZANIE STANDARD



GREY CARTON BOX & COLOR LABEL



L_{PA} = 97 ± 3 dB;
L_{WA} = 108 ± 3 dB

YATO		
YT-07069	45	1

GB Grease pump
D Manuelle fett pumpen
PL Smarownica ręczna
RUS Шприц для смазки
CZ Maznice ruční
H Kézi zsírzó pumpa
RO Grăsimă manuală
pompa

F Pistolet de graissage manuel
I Pompa manuali per grasso
E Grasa manual de la bomba
CN 黄油泵

GREY CARTON BOX
& COLOR LABEL



1.5m
HOSE
WAZ



13.8
MPa
(max)

4
kg

13.8
MPa
(max)

8
kg



20.5
MPa
(max)

16
kg



YATO	capacity / wydajność (kg)	1
YT-07061	4	1

YATO	capacity / wydajność (kg)	1
YT-07063	8	1

YATO	capacity / wydajność (kg)	1
YT-07065	16	1

GB Flexible tube for grease gun
D Schlauch für Fettpresse
PL Wąż do towotnicy
RUS Шприц для перекачки масел
CZ Hadička na maznice na šmír
H Tömlő a zsírzóhoz

RO Furtun flexibil pt. pistol de gresat
F Tuyau pour pistolet de graissage
I Tubo flessibile per pompa grasso
E Manguera para engrasador
CN 手动黄油枪软管

SLIDING
CARD



YATO	L (mm)	1
YT-0709	300	12/144
YT-0710	500	12/144

GB Flexible tube for grease gun
D Schlauch für Fettpresse
PL Wąż do towotnicy
RUS Шприц для перекачки масел
CZ Hadička na maznice na šmír
H Tömlő a zsírzóhoz
RO Furtun flexibil pt. pistol de gresat
F Tuyau pour pistolet de graissage
I Tubo flessibile per pompa grasso
E Manguera para engrasador
CN 手动黄油枪软管



69
MPa
(max)

44
cm



G26

POLYBAG



YATO	L (mm)	72
YT-07101	440	72

GB Grease coupler
D Fettpressenkopf
PL Glowica do smarownicy
RUS Головка для пресс-масленки
CZ Hlavice do maznice
H Olajozó fej

RO Cupla pt. pistol de gresat
F Tête de graisseur
E Cabezal para engrasador
CN 高压油嘴头



15
mm



G26

POLYBAG



YATO	72
YT-07102	72

GB Oiler with a flexible applicator
D Ölkanne mit elastischem Applikator
PL Oliwiarka z elastycznym aplikatorem
RUS Масленка с гибким аппликатором

CZ Olejnička s ohebným aplikátorem
H Hajlékony csővű olajozó
RO Gresor cu aplicator flexibil
F Burette à huile

I Lubrificante con canna flessibile
E Aceitera con aplicador flexible
CN 油壺



IMPACT
RESISTANT
ODPORNE
NA UDERZENIA

IMPACT
RESISTANT
ODPORNE
NA UDERZENIA

IMPACT
RESISTANT
ODPORNE
NA UDERZENIA

YATO	cm ³	10/120
YT-0690	220	10/120
YT-0691	270	10/120

YATO	cm ³	10/120
YT-06912	200	10/120

YATO	cm ³	10/120
YT-06913	300	10/120

YATO	cm ³	10/80
YT-06914	500	10/80

- GB High value rotary barrel pump
- D Kurbelpumpe für Benzinfässer
- PL Wysokowydajna pompa rotacyjna do paliwa
- RUS Насос топливный ротационный
- CZ Čerpadlo palivové rotační
- H Kézi pumpa hordóhoz (forgatható)
- RO Pompa rotativa pt. combustibil
- F Pompe rotative à combustible
- I Pompa rotativa travaso gasolio
- E Bomba de combustible rotatoria
- CN 手摇泵



15
PCS

 2000 ml

FOR TIGHT SPACES DO MIEJSCE
TRUDNODOSTĘPNE

BMC
& COLOR
SLEEVE



YATO 	
YT-06919	4

- GB Oil pump
- D Öl-Umfüllpumpe
- PL Pompa tłokowa do oleju
- RUS Шприц ручной заливной
- CZ Ruční olejová pumpa
- H Olajpumpa
- RO Pompa de ulei de mana
- F Pompe pour huile
- I Pompa manuale travaso olio
- E Bomba manual para aceite
- CN 手摇泵

16-18
l/min

Δ h
45-90
cm

55
min⁻¹
(max)

0.3 l
CYCLE

FOR OIL DO OLEJU

AI

- GB Aluminium rotary oil pump
- D Aluminium-Kurbelpumpe
- PL Aluminiowa pompa do oleju
- RUS Алюминиевый ручной бочковой насос
- CZ Hliník rotační čerpadlo
- RO Aluminiu rotációs szivattyú
- H Aluminiu pompă rotativă
- F Pompe manuelle pour huile
- I Pompa a mano per olio
- E Aluminio bomba rotary
- CN 铝合金手摇油泵

21
l/min

Δ h
500 cm

Δ h
300 cm

3xPIPE 3xRURA

FOR OIL DO OLEJU

AI



COLOR BOX



YATO 	
YT-0712	10



COLOR BOX



YATO 	
YT-07115	10

- GB High value rotary barrel pump
- D Kurbelpumpe für Benzinfässer
- PL Wysokowydajna pompa rotacyjna do paliwa
- RUS Насос топливный ротационный
- CZ Čerpadlo palivové rotační
- H Kézi pumpa hordóhoz (forgatható)
- RO Pompa rotativa pt. combustibil
- F Pompe rotative à combustible
- I Pompa rotativa travaso gasolio
- E Bomba de combustible rotatoria
- CN 手摇泵

FOR FUEL, DIESEL, OIL
DO PALIW I OLEJU

1.0 l
CYCLE

100
l/min

ANTISTATIC HOSE
HAZ ANTYSTATYCZNY

BRASS FILTER
MOSIĘZNY FILTR

2.4 m
180 µm

Δ h
100 cm

AI



WHITE
CARTON BOX
& COLOR LABEL



YATO 	
YT-0715	4

- GB Two arms jaw puller
D Abzieher-2-armig
PL Ściągacz dwuramienny
RUS Съёмник для подшипников
CZ Stahovák
H Csapágyelhúzó
RO Extractor rulmenti
- F Extracteur
I Estrattore
E Extractor
CN 两爪拉马



CrV

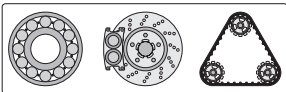

10 mm 4" 100 mm

10 mm 3" 75 mm

YATO	size / rozmiar	max. Ø (mm)	max. force / max. sila nacisku (t)	6/60
YT-2514	4" / 100 mm	60	1.2	6/60

YATO	size / rozmiar	max. Ø (mm)	max. force / max. sila nacisku (t)	6/60
YT-2515	3" / 75 mm	75	1.1	6/60



12 mm 4" 100 mm

17 mm 6" 150 mm



22 mm 8" 200 mm

YATO	size / rozmiar	max. Ø (mm)	max. force / max. sila nacisku (t)	12/48
YT-2516	4" / 100 mm	100	1.4	12/48

YATO	size / rozmiar	max. Ø (mm)	max. force / max. sila nacisku (t)	10/20
YT-2517	6" / 150 mm	120	6	10/20

YATO	size / rozmiar	max. Ø (mm)	max. force / max. sila nacisku (t)	6
YT-2518	8" / 200 mm	180	9	6

- GB Three arms jaw puller
D Abzieher-3-armig
PL Ściągacz trójramienny
RUS Съёмник для подшипников
CZ Stahovák třiramenný
H Csapágyelhúzó
RO Extractor rulmenti cu trei brate
- F Extracteur
I Estrattore
E Extractor detres patas
CN 三爪拉马



CrV

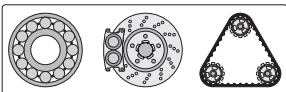

10 mm 3" 75 mm

12 mm 4" 100 mm

YATO	size / rozmiar	max. Ø (mm)	max. force / max. sila nacisku (t)	6/60
YT-2519	3" / 75 mm	80	1.5	6/60

YATO	size / rozmiar	max. Ø (mm)	max. force / max. sila nacisku (t)	6/36
YT-2520	4" / 100 mm	100	2.5	6/36



17 mm 6" 150 mm

22 mm 8" 200 mm



22 mm 12" 300 mm

YATO	size / rozmiar	max. Ø (mm)	max. force / max. sila nacisku (t)	12
YT-2521	6" / 150 mm	130	5	12

YATO	size / rozmiar	max. Ø (mm)	max. force / max. sila nacisku (t)	4
YT-2522	8" / 200 mm	180	9	4

YATO	size / rozmiar	max. Ø (mm)	max. force / max. sila nacisku (t)	2
YT-2523	12" / 300 mm	180	11	2

- GB Three arms jaw puller
D Abzieher-3-armig
PL Ściągacz trójramienny
RUS Съёмник для подшипников
CZ Stahovák třiramenný
H Csapágyelhúzó
RO Extractor rulmenti cu trei brate
- F Extracteur
I Estrattore
E Extractor detres patas
CN 三爪拉马

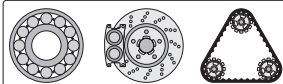

CrV

14 mm 3" 75 mm

15 mm 4" 100 mm

19 mm 6" 150 mm

15 mm 4" 100 mm



YATO	size / rozmiar	Ø (mm)	20
YT-2511	3" / 75 mm	50-150	20

YATO	size / rozmiar	Ø (mm)	20
YT-2512	4" / 100 mm	60-200	20

YATO	size / rozmiar	Ø (mm)	20
YT-2512	4" / 100 mm	60-200	20

YATO	size / rozmiar	Ø (mm)	10
YT-2513	6" / 150 mm	80-300	10

YATO	size / rozmiar	Ø (mm)	48
YT-25145	5-30	5-30	48

- GB Two leg puller for battery terminals and wiperscreen wiper arms
D Abzieher für Scheibenwischer / Wischerarm Spezial-Abzieher Polklemmen
PL Ściągacz dwuramienny do klem i ramion wycieraczek
RUS Съёмник стеклоочистителя терминал батареи дворники
CZ Stahovák na svorky akumulátorů a ramen stěračů
H Akkusaru és ablaktörölkar-lehúzó
RO Extractor brat stergator, cleme baterie
F Extracteur d'essuie glaces et cosse de batterie
I Estrattore 2 griffe
E Extractor tirador exterior para brazo del limpiaparabrisas / terminal de batería
CN 电瓶接头拉马



5-30 mm

ADJUSTABLE NASTAWNY



YATO	Ø (mm)	48
YT-25145	5-30	48

- GB** Universal puller set
D Abziehvorrichtung für Lager
PL Ściągacz do łożysk w miejscach trudnodostępnych
RUS Съёмник подшипников в труднодоступных местах
CZ Sada na stahování ložisek na obtížně dostupných místech
H Csapágyelhúzó
RO Trăgător pt. rulmenți în locuri greu accesibile
F Extracteur aux roulements
I Set di estrattori universali
E Extractor de rodamientos en lugares de difícil acceso
CN 多功能拉拔器

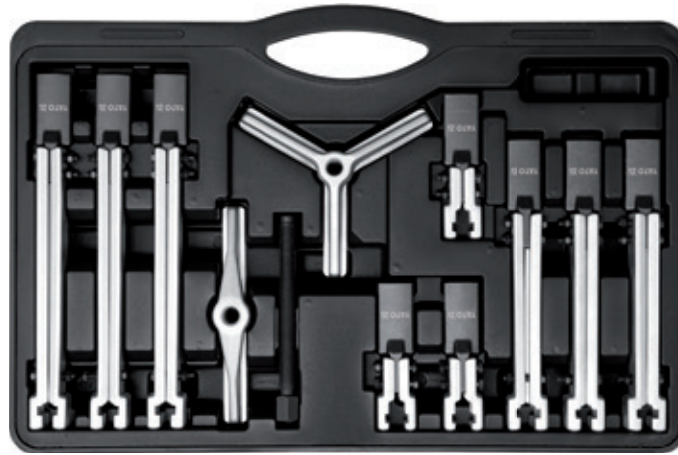

12
PCS
DROP
FORGED
KUTE

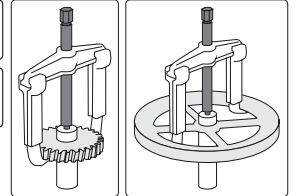

- 3 x 250 mm;
160 mm;
3 x 200 mm;
3 x 100 mm;

BMC
& COLOR
SLEEVE



YATO		
YT-25105		2

- GB** Pilot bearing puller
D Abzieher für Innenlager
PL Ściągacz do łożysk
RUS Съёмник внутренних подшипников
CZ Stahovák na ložiska vnitřní
H Csapágyelhúzó
RO Clește interior pt. extras rulmenți
F Extracteur intérieur aux roulements
I Estrattore cuscinetti
E Extractor de cojinetes inter.
CN 轴承拉马



13-38
mm
CrV
6150

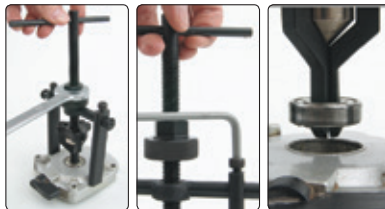

COLOR BOX



YATO	Ø (mm)	
YT-2510	13-38	20

- GB** Universal wheel hub puller
D Scheiben- und Trommelbremsen Abzieher
PL Ściągacz uniwersalny do tarcz i bębnow
RUS Универсальный съёмник ступицы и полуоси
CZ Stahovák na brzdové bubny
H Univerzális féktárcsa és fékdob lehúzó

- RO** Trusa universală pt. transmisie cardanica
F Extracteur universel pour les disques et les tambours
I Estrattore a vite universale
E Extractor universal de discos y tambores
CN 万用轮毂拉马

CrV
90-140 mm
130-180 mm

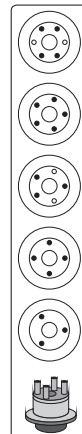

METAL CASE
& COLOR BOX

YATO	L (mm)	
YT-0602	200	6

- GB** Separator and hydraulic cylinder turnbuckle
D Separator und Abziehvorrichtung mit Hydraulikservomotor
PL Separator i ściągacz z silownikiem hydraulicznym
RUS Сепаратор и съёмник с сервомотором
CZ Oddělovač a stahovák s hydraulickým válcem
H Csapágyelhúzó és körmös csapágyelhúzó hidraulikus kézpumpával
RO Separator și ancoră cu servomotor hidraulic
F Séparateur avec actionneur hydraulique
I Separatore frizione cilindro idraulico
E Separador y tensor de tornillo con cilindro hidráulico
CN 液压分离器组合

75-105 mm
80-180 mm
50
kN
HRC
38-45
DROP
FORGED
KUTE
CrV



METAL CASE
& COLOR BOX

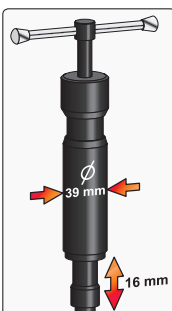

YATO	F (kN)	
YT-0609	50	2

- GB** Twin leg puller with jaw hook
D Doppel Abzieher mit Haken
PL Ściągacz uniwersalny dwuramienny
RUS Съёмник универсальный
CZ Stahovák dvouramenný univerzální
H Csapágyelhúzó készlet
RO Carlig cu falci pt. extras cu picor dublu
F Extracteur universel à deux bras
I Estrattore universale a due bracci
E Extractor de cuatro patas
CN 单边两爪拉马

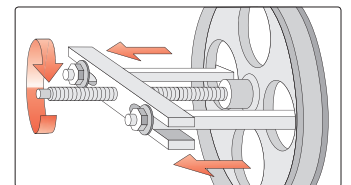

40-220 mm

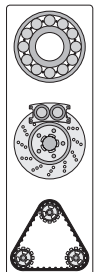

COLOR BOX

YATO		
YT-0640		10

- GB** Gear puller set
- D** Lagerabzieher, Trennmesser
- PL** Ściągacz dwuramienny i separator
- RUS** Съёмник универсальный с сепаратором
- CZ** Stahovák dvouramenný
- H** Csapágyelhúzó készlet
- RO** Set angrenaj pt. extras
- F** Extracteur 2 bras + separateur
- I** Estrattore a due bracci a separatore
- E** Kit de extractor
- CN** 齿轮拉拔器

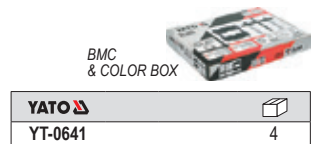
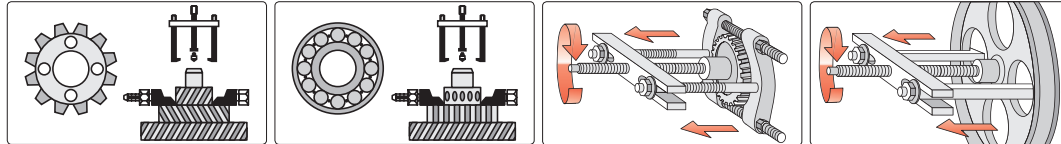
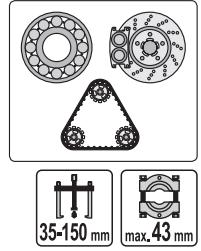

- GB** Gear puller set
- D** Lagerabzieher, Trennmesser
- PL** Ściągacz dwuramienny i separator
- RUS** Съёмник универсальный с сепаратором
- CZ** Stahovák dvouramenný
- H** Csapágyelhúzó készlet
- RO** Set angrenaj pt. extras
- F** Extracteur 2 bras + separateur
- I** Estrattore a due bracci a separatore
- E** Kit de extractor
- CN** 齿轮拉拔器

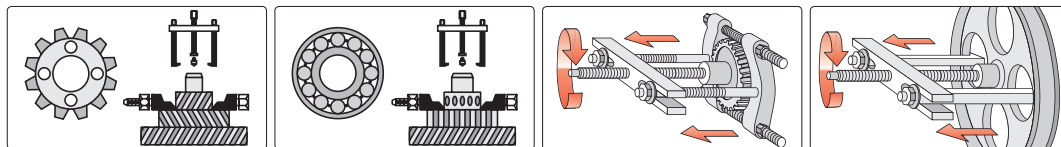
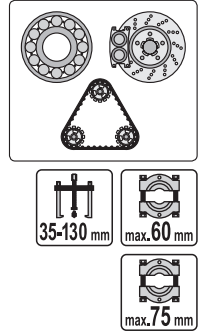
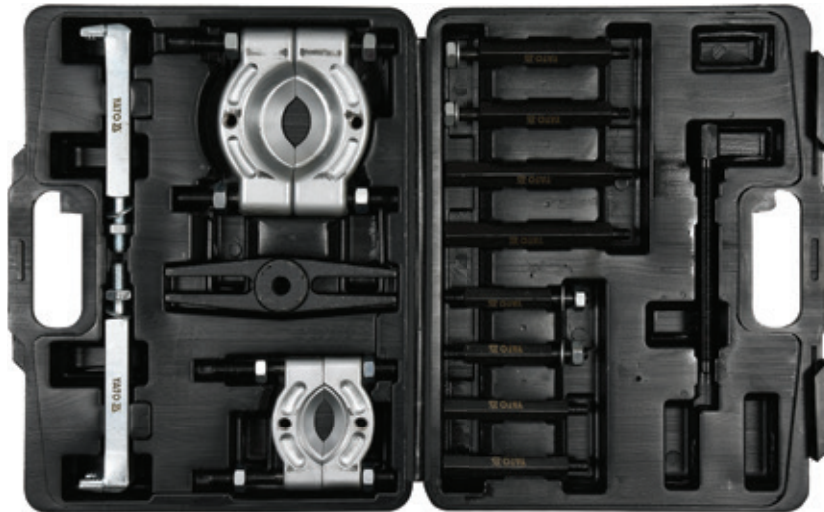

- GB** Slide hammer gear / bearing puller set
- D** Träge Abziehvorrichtung für Lager
- PL** Ściągacz bezwładnościowy do łożysk
- RUS** Набор съёмников с обратным молотком
- CZ** Rázový stahovák s kluzným kladivem na ložiska
- H** Csúszósúlyos csapágyelhúzó készlet
- RO** Set ciocan culisant extractor de rulmenti
- F** Extracteur de roulements à inertie
- I** Set estrattori interni / esterni
- E** Extractor de inercia para cojinetes
- CN** 滑锤轴承拉拔器组套

5
PCS

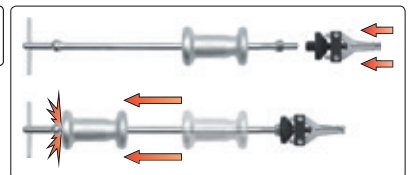

External 3-jaw puller
Ściągacz 3-ramienny zewnętrzny

External 2-jaw puller
Ściągacz 2-ramienny zewnętrzny

Internal 3-jaw puller
Ściągacz 3-ramienny wewnętrzny

Internal 2-jaw puller
Ściągacz 2-ramienny wewnętrzny

- GB** Slide hammer set
D Träge Abziehvorrichtung für Naben und Lager
PL Ściągacz bezwładnościowy do piast i łożysk
RUS Набор съёмников с обратным молотком
CZ Rázový stahovák s kluzným kladivem na náboje a ložiska
H Csúszósúlyos kerékagy - és csapágyelhúzó készlet

- RO** Set ciocan culisant extractor de rulmenti și bușe
F Extracteur de roulements et moyeux à inertie
I Set estrattori per cuscinetti interno
E Extractor de inercia para cubos y cojinetes
CN 滑锤轴承拉拔器组套

16
PCS

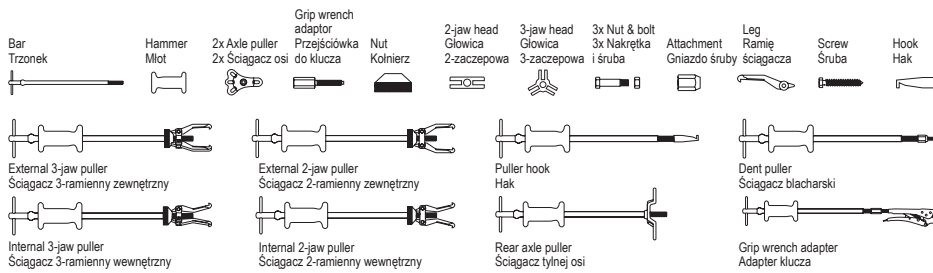
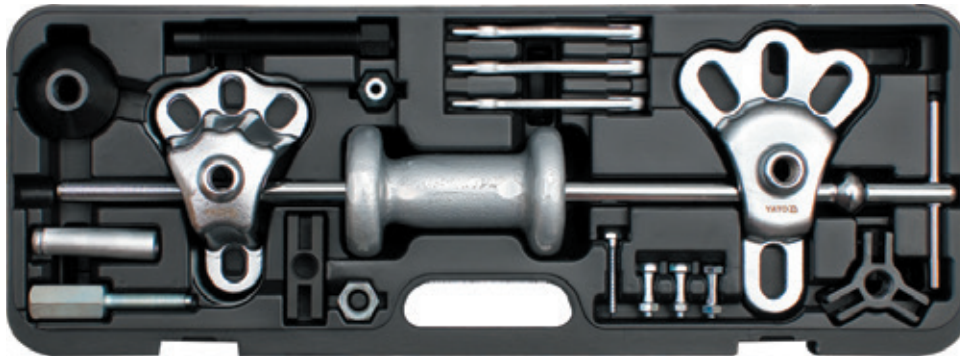
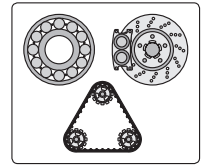
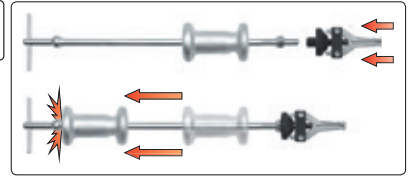

YATO
YT-25391 2

- GB** Front wheel bearing adapter set
D Radlagerabzieher werkzeugsatz vorderachse
PL Ściągacz łożysk piasty przedniej
RUS Набор для снятия переднего подшипника переднеприводных автомобилей
CZ Sada na demontáž ložisek přední nápravy
H Csapágyelhúzó adapter készlet első futóműhöz
RO Set schimbat rulment roata fata
F Extracteur de moyeux
I Set estrattori per cuscinetti ruota anteriore adattatore universale
E Extractor de cojinetes para cubos de rueda delanteros
CN 轴承拆装组套

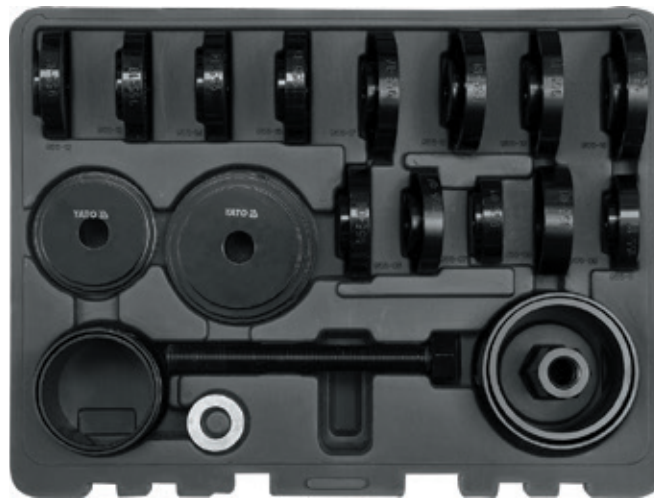

23
PCS

FOR FRONT
WHEEL
BEARING
DO ŁOŻYSK
PIASTY
PRZEDNIEJ

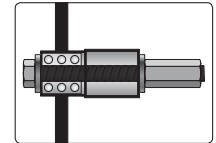

YATO
YT-2541 2

- GB** Wheel bearing bushing tool set
D Radlagerabzieher werkzeugsatz vorderachse
PL Zestaw do obsługi łożysk i tulei
RUS Набор для обслуживания подшипников и втулок
CZ Sada pro údržbu ložisek a pouzder
H Kerékcsapágy persely szerszámkészlet
RO Set extractoare rulmenti
F Kit d'outils pour l'installation et démontage du roulement
I Kit per montaggio / smontaggio dei cuscinetti e manicotti
E Juego de herramientas de cojinete de cojinete de rueda
CN 31件套轴承安装工具

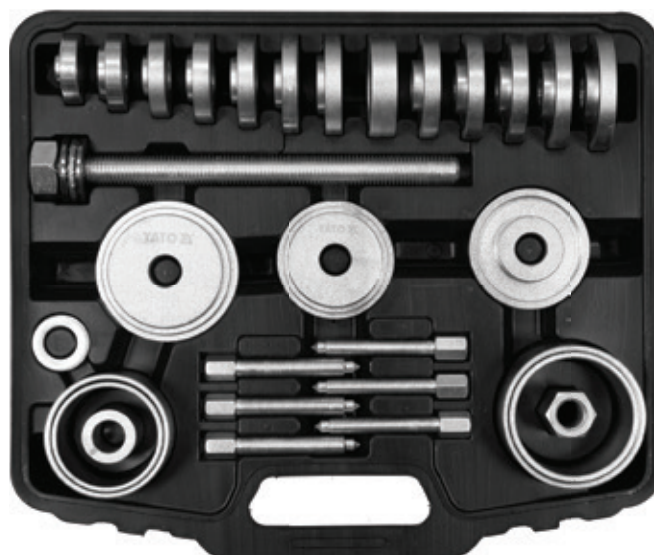

31
PCS

38mm
FOR BEARING
BUSHING
DO ŁOŻYSK
TULEI

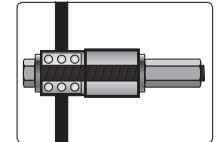

YATO
YT-25412 1

GB Small mouth pull clamp
D Selbstklemmende Blechschele
PL Klamra blacharska samozaciskowa
RUS Скрепa самозажимная для жестяных работ
CZ Karosářská svěrka samosvorná k tahání

H Önszorító húzóató pofa, egyenes
RO Clemă pt. tablă cu strângere automată
F Boucle pour tôle auto-serrant

I Grappa
E Grapa de hojalatería autoprensora
CN 窄型张引夹

5t **125 mm** **42x20 mm JAWS SZCZĘKI** **AUTO-TIGHTEN SAMO-ZACISKOWA**

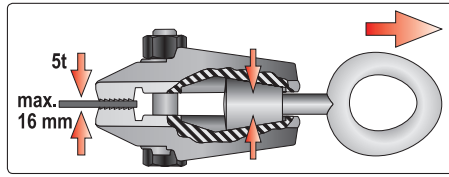

COLOR BOX



YATO	L (mm)	
YT-2542	125	12

GB Box clamp
D Selbstklemmende Blechschele vom Typ „C“
PL Klamra blacharska samozaciskowa typu „C“
RUS Скрепa самозажимная для жестяных работ типа „C“
CZ Karosářská svěrka samosvorná k tahání typ „C“
H Önszorító húzóató pofa, öblös
RO Clemă pt. tablă cu strângere automată de tip „C“
F Boucle pour tôle auto-serrant

I Grappa tipo „C“
E Grapa de hojalatería autoprensora tipo „C“
CN 宽型张引夹

3t **142 mm** **35x15 mm JAWS SZCZĘKI** **TYPE C** **AUTO-TIGHTEN SAMO-ZACISKOWA**

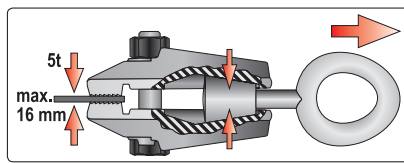

COLOR BOX



YATO	L (mm)	
YT-2543	142	10

GB Stud extractor
D Stehbolzenausdreher
PL Wykręтак do śrub szpilek i nakrętek
RUS Шпильковерт универсальный
CZ Klíč na povolení závrtných šroubů
H Sérülfejtű csavar kiszedő
RO Extractor pt. suruburi
F Extracteur de goujon, écrou ou boulon arrondis
I Stud estratore
E Extractor de esparragos
CN 断螺丝取出器

COLOR BOX **1/2" 12.5mm** **8.5-19 mm**



YATO		
YT-06251		10/30

GB Stud extractor
D Stehbolzenausdreher
PL Wykręтак do śrub szpilek i nakrętek
RUS Шпильковерт универсальный
CZ Klíč na povolení závrtných šroubů
H Sérülfejtű csavar kiszedő
RO Extractor pt. suruburi
F Extracteur de goujon, écrou ou boulon arrondis
I Stud estratore
E Extractor de esparragos
CN 断螺丝取出器

FOR IMPACT TOOLS DO NARZEDZI UDAROWYCH
3 JAWS 3 SZCZĘKI **6-11 mm**
CrMo HRC40-45 **24 mm 3/8"**



DOUBLE BLISTER



YATO		
YT-06255		6/36

GB Stud extractor
D Stehbolzenausdreher
PL Wykręтак do śrub szpilek i nakrętek
RUS Шпильковерт универсальный
CZ Klíč na povolení závrtných šroubů
H Sérülfejtű csavar kiszedő
RO Extractor pt. suruburi
F Extracteur de goujon, écrou ou boulon arrondis
I Stud estratore
E Extractor de esparragos
CN 断螺丝取出器

FOR IMPACT TOOLS DO NARZEDZI UDAROWYCH
3 JAWS 3 SZCZĘKI **6-11 mm**
CrMo HRC40-45 **24 mm 1/2"**



DOUBLE BLISTER



YATO		
YT-06256		6/36

GB Tie rod end lifter
D Universal-Kugelgelenk-Abzieher
PL Ściągacz do sworzni kulistych
RUS Съёмник шаровых опор
CZ Stahovák kulových čepů řízení
H Gömbfej kinyomó
RO Extractor pt. articulatii sferice
F Extracteur de rotue
I Estrattore per snodi sferici
E Extractor de pernos esféricos
CN 球头拉拔器

COLOR BOX



100 mm **20-60 mm**

YATO	⌀ (mm)	L (mm)	⌀ (mm)	
YT-06122	19	100	20	20



135 mm

YATO	⌀ (mm)	L (mm)	⌀ (mm)	
YT-0612	19	135	17.5	9/18

- GB Tie rod end lifter
D Universal-Kugelgelenk-Abzieher
PL Ściągacz do sworzni kulistych
RUS Съёмник шаровых опор
CZ Stahovák kulových čepů řízení
H Gömbfej kinyomó
RO Extractor pt. articulatii sferice
F Extracteur de rotue
I Estrattore per snodi sferici
E Extractor de pernos esféricos
CN 球头拉拔器



265 mm
275 mm

COLOR BOX



YATO	Ø (mm)	L (mm)	Ø (mm)	Box
YT-0613	16	265	17	20
YT-0614	16	275	20	20

- GB Inner tie rod tool
D Spurstangengelenk Lösewerkzeug
PL Klucz do drążków kierowniczych
RUS Ключ для шарнира рулевой рейки
CZ Přípravek na axiální táhla
H Csukló szerelő
RO Cheia de la tija de cravată
F Clé pour pour rotules de direction
I Chiave per il tirante
E Extractor mecanismo de dirección
CN 大机舵扳手

200 mm

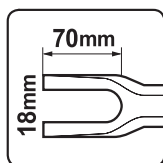

COLOR BOX

YATO	L (mm)	Box
YT-0615	200	18/36

- GB Inner tie rod tool
D Spurstangengelenk Lösewerkzeug
PL Klucz do drążków kierowniczych
RUS Ключ для шарнира рулевой рейки
CZ Přípravek na axiální táhla
H Csukló szerelő
RO Cheie bielete directe
F Clé pour pour rotules de direction
I Chiave per il tirante
E Extractor mecanismo de dirección
CN 大机舵扳手

Ø mm
35-42



COLOR BOX

YATO	Box
YT-0616	25

- GB Inner tie rod tool
D Spurstangengelenk Lösewerkzeug
PL Klucz do drążków kierowniczych
RUS Ключ для шарнира рулевой рейки
CZ Přípravek na axiální táhla
H Csukló szerelő
RO Cheie bielete directe
F Clé pour pour rotules de direction
I Chiave per il tirante
E Extractor mecanismo de dirección
CN 大机舵扳手

1/2"
12.5mm

Ø mm
27-42

CrMo



COLOR BOX

YATO	Box
YT-06162	10/20

- GB Track rod end remover & installer set
D Schlüsselsatz für Zahnstangenlenkung
PL Zestaw kluczy do drążków kierowniczych
RUS Набор ключей для рулевых тяг
CZ Sada klíčů pro hřeben řízení
H Kormányrúd telepítő készlet-eltávolító
RO Set montare-demontare bieleta
F Clé pour rotules de direction
I Set di chiavi suggerimenti smontaggio tiranti sterzo
E Herramienta de llaves para barras de dirección
CN 件套轴接头工具组

4 PCS

Ø mm
30-45



Ø 30-35mm, 35-40mm, 40-45mm

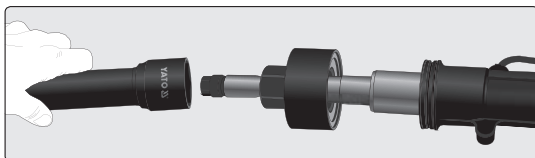

BMC & COLOR SLEEVE



YATO	Box
YT-06155	2

- GB Tie rod / ball joint tool kit
D Werkzeugsatz für Bremssattel
PL Ściągacze do drążków
RUS Съёмник штанг
CZ Stahovák táhel řízení
H Rúdlehúzó
RO Ancore pt. tije
F Set d'extracteurs pour rotules de direction
I Set tiranti per estrattore
E Tensores para palancas
CN 球头拉拔器组套

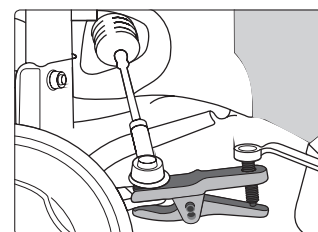

6 PCS

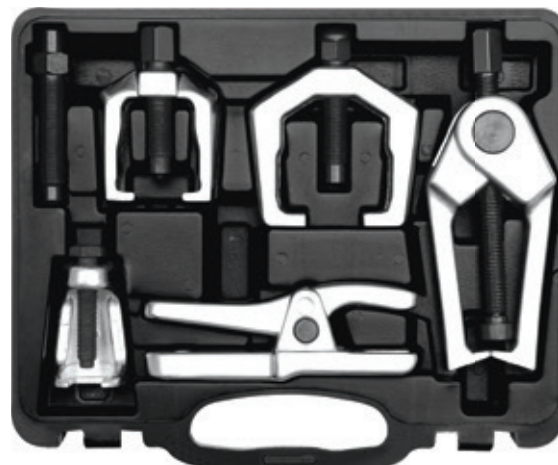

BMC & COLOR SLEEVE



YATO	Box
YT-06157	4

- GB** Tie rod / ball joint tool kit
D Werkzeugsatz für Bremsattel
PL Ściągacze do drążków
RUS Съёмник штанг
CZ Stahováky táhel řízení
H Rúdlehúzó
RO Ancore pt. tije
F Set de leviers à tête réglable
I Set di estrattori perni e tiranti sterzo
E Tensores para palancas
CN 球头拉拔器组套

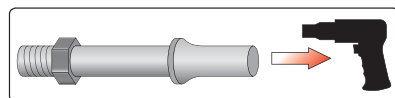
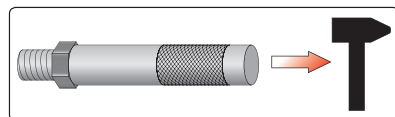
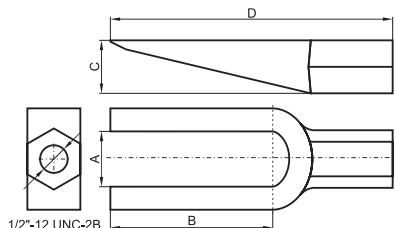

5
PCS

for / dla: YT-0990

BMC
& COLOR
BOX



YATO		A (mm)	B (mm)	C (mm)	D (mm)	
YT-0616	I	18.2	65.0	24.0	123.9	10
	II	25.2	67.8			
	III	30.2	56.3			

- GB** Seal puller
D Dichtungs-Abziehwerkzeug
PL Ściągacz do uszczelek
RUS Съёмник прокладок
CZ Škrabka na těsnění
H Tömítéslehúzó
RO Ancoră pt. garnituri
F Outil pour extraire les joints
I Estrattore per guarnizioni
E Tensor para juntas
CN 密封圈拉拔器

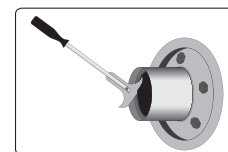

max. Ø
85 mm

SLIDING
CARD

YATO	L (mm)	
YT-0642	200	12/48

- GB** Exhaust pipe remover
D Auspuffgummi-Ziehhaaken
PL Hak do wieszaków gumowych
RUS Крюк для резиновых вешалок
CZ Hák do gumových věšáků
H Karpó gumi akasztókhöz
RO Dispozitiv scos teava esapament
F Extracteur de tuyau d'échappement
E Gancho para perchas de caucho
CN 排气管拉钩



300
mm

6 mm



TIED ON
CARD

YATO		
YT-06390		20/80

- GB** Bearing race and seal driver set
D Presssatz für sicherungsringe, lager, etc.
PL Zestaw do osadzania łożysk i uszczelniaczy
RUS Втулка и набор пальниковых уплотнителей для автомобиля
CZ Sada na montáž gufer
H Csapág, szimering, persely ki- és beütő készlet
RO Set pt. inlocuit rulment, simering
F Set de simerings
I Set di tamponi per cuscinetti e guarnizioni
E Jugeo de conductores del anillo y del sello de rodadura
CN 斜型培令套安装器



10
PCS

AI

BMC
& COLOR
SLEEVE

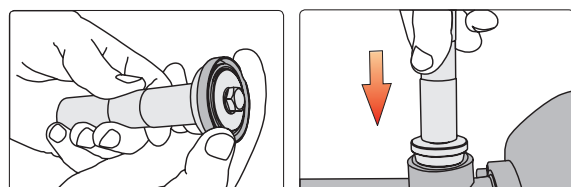

YATO	No.	Ø (mm)	
YT-0638	01	40	5/10
	02	44	
	03	50	
	04	59	
	05	63	
	06	65	
	07	72	
	08	76	
	09	81	

- GB** Windscreen wiper arm removal tool
D Abziehvorrichtung für die Scheibenwischerarme
PL Ściągacz do ramion wycieraczek
RUS Съёмник поводков стеклоочистителя
CZ Stahováč na ramínka stěračů
H Ablaktörökár lehűző
RO Siguranță pt. brațele ștergătoarelor
F Bord aux bras d'essuie-glace
I Estrattore di parabrezza
E Herramienta para desmontaje de las plumas de los limpiaparabrisas
CN 雨刷臂拆卸工具

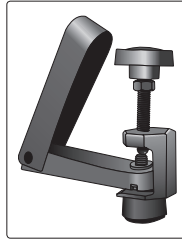

ADJUSTABLE
NASTAWNY



SLIDING
CARD

YATO
YT-0846 12/120

- GB** Two leg puller for wiperscreen wiper arms
D Abzieher für Scheibenwischer
PL Ściągacz dwuramienny do ramion i wycieraczek
RUS Съёмник стеклоочистителя батареи
CZ Dvouúčň stahovač pro ramena stěračů
H Kétkaros húzó az ablaktörölő karokhoz
RO Extractor braț ștergator
F Extracteur d'essuie glaces
I Estrattore, doppio braccio, per bracci tergicristalli
E Extractor tirador exterior para brazo del limpiaparabrisas
CN 雨刷臂拉马



50mm
max.

ADJUSTABLE
NASTAWNY

SLIDING
CARD

YATO
YT-08461 50

- GB** Puller for ribbed drive pulley
D Riemenscheiben Abzieher
PL Ściągacz kół pasowych wielorowkowych
RUS Универсальный съёмник шкива
CZ Staviteľný stahovák drážkových řemenic
H Bordás szíjtárcsa lehűző
RO Tragator de scripete reglabil
F Universel extracteur de poulie d'entraînement cannelé
I Estrattore puleggia motrice a coste
E Extractor de polea acanalada
CN 皮带轮拉马



40-165mm

17mm
3/8"

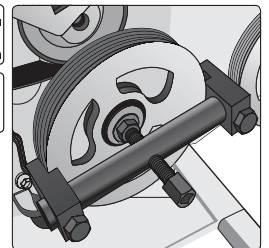

COLOR
BOX

YATO
YT-25480 10

- GB** Universal pulley puller
D Universal-Riemenscheiben-Abzieher
PL Ściągacz uniwersalny do kół rozrządu
RUS Съёмник шкивов универсальный
CZ Stahováč ozubených kol
H Univerzális lehűző vezérműtengely szíjtárcsa
RO Extractor universal pt. roata distributie
F Extracteur de poulie universel
I Estrattore universale per ruote di albero a camme
E Extractor de poleas universal
CN 皮带轮拉马

24mm

8
SETTINGS
USTAWIEN

60-90
mm

3
ARMS
RAMONA



COLOR
BOX

YATO
YT-06340 10

- GB** Universal pulley puller
D Universal-Riemenscheiben-Abzieher
PL Ściągacz uniwersalny do kół rozrządu
RUS Съёмник шкивов универсальный
CZ Stahováč ozubených kol
H Univerzális lehűző vezérműtengely szíjtárcsa
RO Extractor universal pt. roata distributie
F Extracteur de poulie universel
I Estrattore universale per ruote di albero a camme
E Extractor de poleas universal
CN 皮带轮拉马

17mm

6
SETTINGS
USTAWIEN

50-80
mm

3
ARMS
RAMONA



ADJUSTABLE / NASTAWNY



COLOR
BOX

YATO
YT-06341 10

- GB** Fuel tank sender unit spanner
D Tankgeberschlüssel
PL Klucz pazurowy do pompy paliwa
RUS Ключ для крышки топливного насоса
CZ Nastavitelný klíč na šrouby palivových nádrží
H Üzemanyag jeladó kiszedő
RO Cheie reglabila pt. pompa combustibil pe rezervor
F Outil de démontage de pompe
I Chiave smontaggio galleggiante serbatoio
E Llave de tres garras para aforador
CN 油箱盖拆装工具

24mm

75-160
mm

3 REGULATED
ARMS
3 REGULOWANE
RAMONA



COLOR
BOX



YATO
YT-06288 20

- GB** Spring clamp remover V.A.G.
D Auspuff Federklammer entferner / installer für V.A.G.
PL Ściągacz do obejm i sprężyn V.A.G.
RUS Съёмник пружинных, хомутов систем выпуска V.A.G.
CZ Přípravek na montáž a demontáž svorky výfuku V.A.G.
H Kipufogó rugó szerelő V.A.G.
RO Dispozitiv montat / demontat esapament V.A.G.
F Tuyau d'échappement printemps pince outil de suppression pour V.A.G.
I Spring clamp rimozione
E Abrazadera de resorte herramienta de eliminación para V.A.G.
CN 弹簧撑

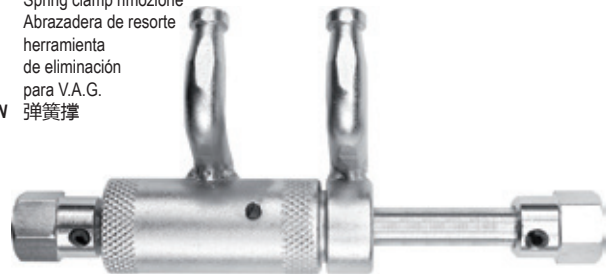

SLIDING
CARD

YATO
YT-25331 12/24

17
mm

FOR / DLA
V.A.G.

SLIDING
CARD

SLIDING
CARD

- GB** Camshaft sprocket pulley puller
D Abzieher-Satz Universal Nockenwellenrad
PL Ściągacz kół rozrządu
RUS Набор съемников для шкива распределителя
CZ Stahovák na řemenice včakové hřídele
H Vezérműtengely ékszíjtárcsa lehúzó
RO Extractor fullii arbore cu camee
F Extracteur de poulie d'arbres à cames
I Estrattore per ruote di albero a camme
E Extractor de poleas universal
CN 5件套凸轮轴链轮拉马组套

5 PCS FOR / DLA V.A.G. 17 mm

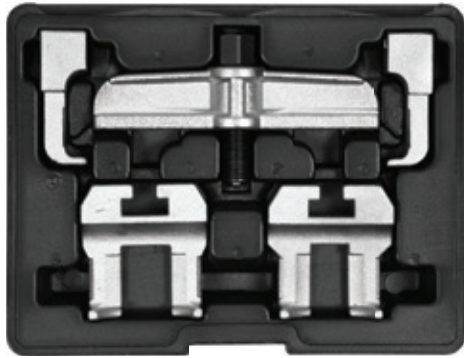

BMC & COLOR SLEEVE

YATO
YT-06342 8

- GB** Twist socket set
D Schraubendrehersatz
PL Zestaw wykręteków do śrub
RUS Инструмент для удаления сломанных винтов
CZ Sada vyťahováku stržených šroubů
H Törtcsavar kiszedő készlet
RO Set de chei pt. șuruburi
F Set d'extracteurs aux vis
I Set estrattori per dadi
E Juego de destornilladores
CN 螺栓取出器组套

BMC & COLOR BOX



10 PCS 3/8" 10mm CrMo HRC 52-55

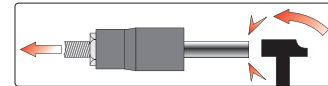

YATO
YT-0603 20

- GB** Twist socket set
D Schraubendrehersatz
PL Zestaw wykręteków do śrub
RUS Инструмент для удаления сломанных винтов
CZ Sada vyťahováku stržených šroubů
H Törtcsavar kiszedő készlet
RO Set de chei pt. șuruburi
F Set d'extracteurs aux vis
I Set estrattori per dadi
E Juego de destornilladores
CN 螺栓取出器组套



3/8" (9.5 mm): 9, 10, 11, 12, 13, 14, 15, 16, 17, 19 mm

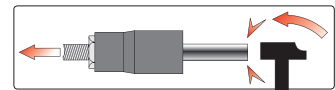

10 PCS 3/8" 10mm



YATO
YT-06031 20

- GB** Twist socket set
D Schraubendrehersatz
PL Zestaw wykręteków do śrub
RUS Инструмент для удаления сломанных винтов
CZ Sada vyťahováku stržených šroubů
H Törtcsavar kiszedő készlet
RO Set de chei pt. șuruburi
F Set d'extracteurs aux vis
I Set estrattori per dadi
E Juego de destornilladores
CN 螺栓取出器组套



1/2" (12.5 mm): 17, 19, 21, 23, 27 mm; Ø12 mm

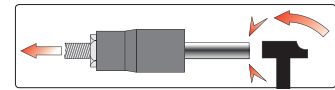

6 PCS 1/2" 12.5mm CrMo



YATO
YT-06032 10

- GB** Screw extractor set & HSS drill bits
D Schraubenausdrehsatz & HSS Bohrer
PL Wykrętaکی do zerwanyh śrub i wiertła do metalu HSS
RUS Экстракторы и сверла по металлу HSS
CZ Vrtáky do přetřzených šroubu & vrtáky na kov HSS
H Törtcsavar kiszedő készlet + fúrószárak fémhez HSS
RO Capete pt. deșurubat șuruburi rupte & burghie pt. metal HSS
F Set d'extracteurs aux vis
I Estrattori di vite HSS
E Destornillador para tornillos arrancados & HSS brocas
CN 断丝取出器组套



12 PCS HSS

M3-M24

YATO	Ø (mm)	M	Ø [mm]	
YT-0591	1.4-3.6	3-6	1.8	40
	2.1-4.9	6-8	2.6	
	3.1-6.5	8-11	3.7	
	4.8-8.8	11-14	5.5	
	6.2-11.0	14-18	7.0	
	9.4-15.0	18-24	10.3	

- GB** Universal extractor set
D Gewindeausdreh-Satz
PL Uniwersalny zestaw do wykręcania
RUS Набор инструментов для поврежденных болтов и гаек
CZ Nástrojová sada pro poškozené šrouby a matice
H Szerszámkészlet sérült csavarokhoz és anyákhoz
RO Set extractoare suruburi si piulite
F Etabléc extractoare suruburi si piulite
I Set universale di cacciaviti
E Extracteurs etabléc vis et écrous
CN 螺丝, 螺杆, 螺母取出器组套



3/8" (9.5 mm): 9, 10, 11, 12, 13, 14, 16 (L=28); 19 mm (L=30) CrMo 42;
1/2" (12.5 mm): 6, 8 (L=60 mm); 10, 12 mm (L=70 mm); CrV 50BV30;
M3-M6, M6-M8, M8-M11, M11-M14, M14-M18; CrMo 42

17 PCS 1/2" 12.5mm 3/8" 10mm CrMo 42 CrV 50BV30

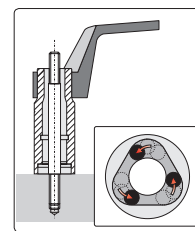

YATO
YT-06033 10

- GB** Screw extractor set
D Schraubenausdrehersatz
PL Wykrętki do zerwanych śrub
RUS Набор для извлечения обломанных болтов
CZ Vrtáky do přetržených šroubu
H Törtcsavar kiszedő készlet
- RO** Capete pt. deșurubat șuruburi rupte
F Set d'extracteurs aux vis
I Estrattori di viti
E Destornillador para tornillos arrancados
CN 断丝取出器组套

5
PCS
1/4"
(6.3mm)
HSS
4241



YATO	Ø (mm)	
YT-06035	0-6; 1-8; 2-10; 3-12; 4-14	40

- GB** Screw extractor set
D Schraubenausdrehersatz
PL Wykrętki do zerwanych śrub
RUS Набор для извлечения обломанных болтов
CZ Vrtáky do přetržených šroubu
H Törtcsavar kiszedő készlet
RO Capete pt. deșurubat șuruburi rupte
- F** Set d'extracteurs aux vis
I Estrattori di viti
E Destornillador para tornillos arrancados
CN 断丝取出器组套

6
PCS



PLASTIC BOX & SLIDING CARD



YATO	Ø (mm)	L (mm)	
YT-0590	3-6	52	12/48
	6-8	58	
	8-11	66	
	11-14	75	
	14-18	80	
	18-25	88	

- GB** Bolt extractor set
D Satz von Ausziehvorrichtungen für Stifte
PL Zestaw wykrętek do szpilek
RUS Набор экстракторов для шпилек
- CZ** Souprava na demontáž závrtných šroubů
H Csavarkihajtó készlet
RO Set de șurubelnițe pt. tije
F Set d'extracteurs aux épingles
- I** Set bussole estrattore per brugola
E Juego de extractores de alfileres
CN 断丝取出器组套



STEEL
8660
HRC
49-52

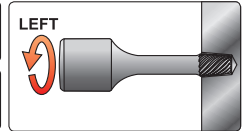

6
PCS
3/8"
10mm

YATO	Ø (mm)	
YT-0623	2; 3; 4; 6; 8; 10	50



5
PCS
1/2"
12.5mm

YATO	Ø (mm)	
YT-0624	8; 10; 12; 14; 16	20

- GB** Heavy duty nut splitter
D Meißelsatz für Schraubenmutter
PL Zestaw przecinaków do nakrętek
RUS Набор зубил для гаек
CZ Souprava sekáčů na matice
H Csavaranya-vágó
RO Set retezatoare capace
F Set de burins
I Set estrattore dado
E Juego de tajaderas para tuercas
CN 螺母破拆组套

4
PCS
CrV
HRC
40-45

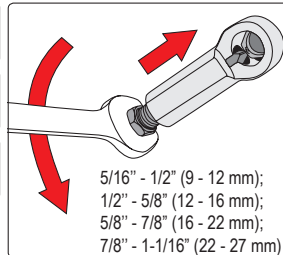

YATO		
YT-0585		10

- GB** Roller stud extractor set
D Stehbolzenlösersatz
PL Komplet wykrętek do szpilek
RUS Набор ключей для снятия шпилек
CZ Sada stahovadel na špendlíky
H Komplet tükkihúzó
RO Set de dispozitive pt. demontat șuruburi rupte
F Set d'extracteurs de goupilles
I Estrattori a rulli per viti prigioniere
E Juego de extractores de agujas
CN 断丝取出器组套

4
PCS
CrV
50BV30

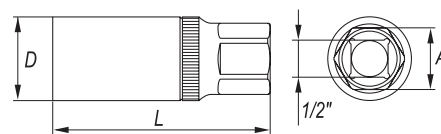
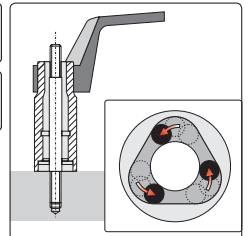

YATO	Ø (mm)	D (mm)	L (mm)	A (mm)	
YT-0620	6	24	60	21	6/24
	8				
	10	28	70		
	12				

- GB** Car radio removal tool set
D Autoradio Demontage Werkzeugsatz
PL Zestaw do demontażu radioodbiorników samochodowych
RUS Набор для разборки авто-ресиверов
CZ Sada k demontáži autorádií
H Autórádió kiszerező készlet
RO Trusa de scule pt. indepartat radio
F Set d'outils pour dépose autoradio
I Set estrattori per autoradio
E Juego para el desmontaje de autorradio
CN 收音机拆卸组套

- 2 radio removal U-hook (Ford, VW, Audi, Grundig, Blaupunkt)
- 1 special pentagon wrench (BMW)
- 4 radio removal keys (VW, Audi, Becker, Mercedes)
- 2 radio removal keys (Mercedes, Porsche, Becker)
- 2 radio removal keys (VW)
- 1 allen hex wrench (BMW, Opel)
- 2 radio removal keys (new Becker)
- 2 radio removal keys (new Skoda)
- 2 radio removal keys U-hook (new Blaupunkt)
- 2 radio removal keys (Fiat Brava)
- 2 radio removal U-hook (Opel Doppel-Kugel-Inbus)
- 6 radio removal keys (Mercedes-Benz, BMW)
- 2 radio removal keys (Kenwood II 1998-2001)
- 2 radio removal keys (Sony II since 2002)
- 2 radio removal keys (Kenwood III since 2002)
- 2 radio removal keys (Pioneer, JVC)
- 2 radio removal keys (Sony I until 2001)
- 2 radio removal keys (Panasonic)
- 2 radio removal keys (Kenwood I until 1998)
- 2 radio removal keys (Kenwood mask)
- 2 radio removal keys (new Clarion)
- 2 radio removal keys (old Clarion)
- 2 radio removal keys (Panasonic 2006)
- 2 radio removal keys (Sony IDIC 2005)

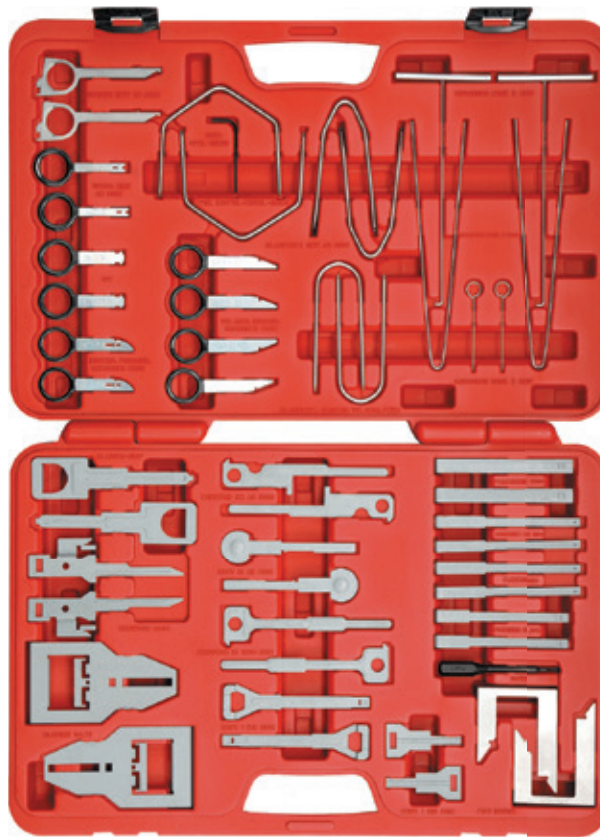

52
PCS

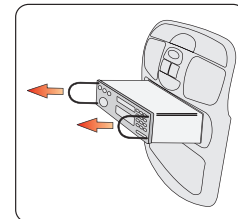
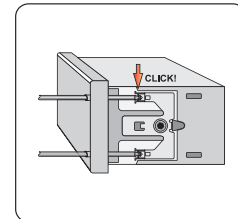
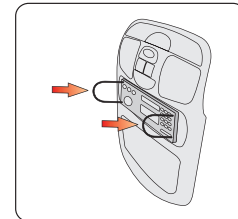

YATO
YT-0838 10

- GB** Panel removal set
D Abziehvorrichtung für Polsterung
PL Ściągacze do tapicerki
RUS Съёмник обивки
CZ Sada k demontáži čalounění
H Kárpitlehúzó
- RO** Ancore pt. tapiterie
F Set d'extracteurs à la tapisserie
I Leve in plastica per la tappezzeria
E Tensores para las vestiduras
CN 面板拆卸组套



IMPACT RESISTANT NYLON
ODPORNE NA UDARZENIA
NO SCRATCH BEZ ZADRAPAN

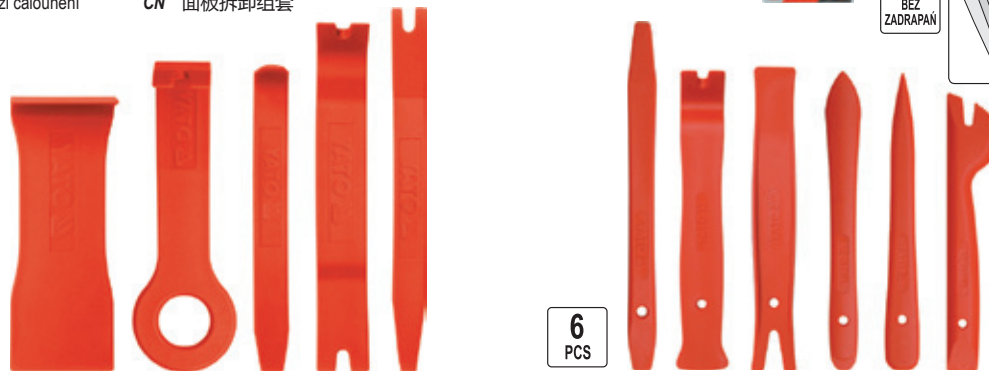
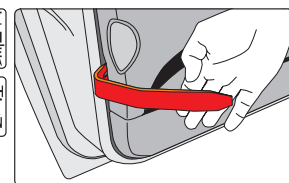

5
PCS

6
PCS

YATO
YT-0836 6/24

YATO
YT-0837 6/24

- GB** Panel removal set
D Abziehvorrichtung für Polsterung
PL Ściągacze do tapicerki
RUS Съёмник обивки
CZ Sada k demontáži čalounění
H Kárpitlehúzó
- RO** Ancore pt. tapiterie
F Set d'extracteurs à la tapisserie
I Leve in plastica per la tappezzeria
E Tensores para las vestiduras
CN 面板拆卸组套



IMPACT RESISTANT NYLON
ODPORNE NA UDARZENIA
NO SCRATCH BEZ ZADRAPAN

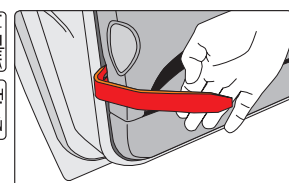

11
PCS

27
PCS

YATO
YT-0844 5/10

YATO
YT-0843 10

- GB** Set of plastic scrapers
D Satz von Kunststoffschabern
PL Zestaw skrobaków plastikowych
RUS Набор пластмассовых шаблонов
CZ Souprava plastových škrabek
H Műanyag vakaró készlet
RO Set de răzuitoare din plastic
F Kit de grattoirs en plastique
I Set di raschietto
E Juego de rascadores de plástico
CN 塑料刮刀



4
PCS

265
mm

IMPACT
RESISTANT
NYLON
ODPORNE
NA UDARZENIA

NO SCRATCH
BEZ
ZADRAPAN

SLIDING
CARD



YATO	L (mm)	
YT-0847	265	6/36

- GB** Plastic chisel set
D Kunststoff Meißel Satz
PL Przciniaki z tworzywa
RUS Съёмники пластиковые панелей облицовки
CZ Plastový kličn pro autoklempě
H Műanyag véső készlet

- RO** Set dalti din plastic
F Outils pour le rembourrage de voiture
I Scalpelli in plastica
E Cinceles plásticos para molduras
CN 6件套塑料撬棍组套

6
PCS

NYLON

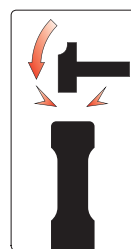

DOUBLE
BLISTER



YATO	
YT-08477	10/60

- GB** Lockout wedge set
D Zierleistenkeil mit Loch
PL Klíny montażowe
RUS Клины удаления монтаровки
CZ Sada montážních klínů
H Szerelőék készlet
RO Set pene de montaj
F Cales de montage
I Cunei di fissaggio
E Cuñas plásticas
CN 塑料刹车块



4
PCS

∅ mm
25

100x50
x25mm

DOUBLE
BLISTER



YATO	
YT-67370	12/48

- GB** Lockout wedge set
D Zierleistenkeil mit Loch
PL Klíny montażowe
RUS Клины удаления монтаровки
CZ Sada montážních klínů
H Szerelőék készlet
RO Set pene de montaj
F Cales de montage
I Cunei di fissaggio
E Cuñas plásticas
CN 塑料刹车块

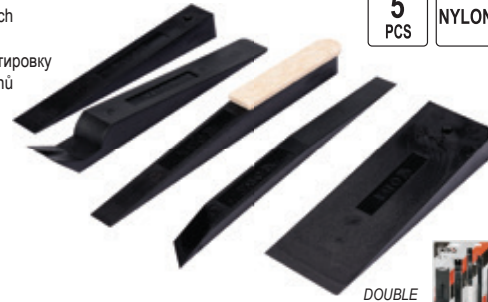

5
PCS

NYLON

DOUBLE
BLISTER



YATO	
YT-67371	6/24

- GB** Quick release cut out tool
D Schneidmesser für Scheiben
PL Nóż do wycinania szyb
RUS Нож для вырезания стекла
CZ Nůž na vyřezávání skel
H Szélvédőkivágó kés
RO Cuțit tăietor de geam
F Kit de découpe pare-brise
I Tagliolo per il vetro
E Cuchilla para cortar cristales
CN 玻璃橡胶刮除器



3x
BLADES
OSTRZA

Alu
HANDLE
UCHWYT

QUICK
RELEASE
SZYBKO-
ZŁĄCZE

K5

SLIDING
CARD



YATO	
YT-0659	20/40

- GB** Spare blades for cut out tool
D Abbrechklingenn
PL Ostrza zapasowe do noża do wycinania szyb
RUS Лезвия для ножей
CZ Ostří náhradní
H Törhető tartalékpenge
RO Rezerve cutter
F Lames
I Lame di ricambio per coltello specialistica per tagliare vetri del auto
E Filo partido de recambio
CN 玻璃橡胶刮除器刀片



3x
BLADES
OSTRZA

K5

for / dla: YT-0659

SLIDING
CARD



YATO	
YT-06590	10/80

- GB** Windshield removal set
D Demontagesatz für Autoscheiben
PL Zestaw do demontażu szyb samochodowych
RUS Набор для демонтажа автостекел
CZ Souprava na demontáž autoskel
H Szélvédőcserélő szett
RO Set pt. demontarea geamurilor de maşină
F Kit pour démontage de vitres de voiture
I Set di strumenti di rimozione parabrezza
E Juego para desmontaje de cristales de coches
CN 风挡玻璃拆卸组套



7
PCS

HRC
38-42



COLOR BOX

YATO	
YT-0845	10

- GB** Windscreen wiper arm removal tool
- D** Abziehvorrichtung für die Scheibenwischerarme
- PL** Ściągacz do ramion wycieraczek
- RUS** Съёмник поводков стеклоочистителя
- CZ** Stahovák na ramínka stěračů
- H** Ablaktörökárhúzó
- RO** Siguranță pt. brațele ștergătoarelor
- F** Bord aux bras d'essuie-glace
- I** Estrattore di parabrezza tergicristallo braccio
- E** Herramienta para desmontaje de las plumas de los limpiaparabrisas
- CN** 雨刷臂拆卸工具

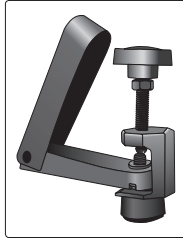

ADJUSTABLE
NASTAWNY



SLIDING
CARD

YATO		
YT-0846		12/120

- GB** Two leg puller for widescreeen wiper arms
- D** Abzieher für Scheibenwischer
- PL** Ściągacz dwuramienny do ramion i wycieraczek
- RUS** Съёмник стеклоочистителя батареи
- CZ** Dvouúčňní stohovač pro ramena stěračů
- H** Kétkaros húzó az ablaktörök karokhoz
- RO** Extractor brat ștergator
- F** Extracteur d'essuie glaces
- I** Estrattore, doppio braccio, per bracci tergicristalli
- E** Extractor tirador exterior para brazo del limpiaparabrisas
- CN** 雨刷臂拉马



50mm
max.
ADJUSTABLE
NASTAWNY

SLIDING
CARD

YATO		
YT-08461		50

- GB** Two leg puller for battery terminals and widescreeen wiper arms
- D** Abzieher für Scheibenwischer / Wischerarm Spezial-Abzieher Polklemmen
- PL** Ściągacz dwuramienny do klem i ramion wycieraczek
- RUS** Съёмник стеклоочистителя терминал батареи дворники
- CZ** Stahovák na svorky akumulátorů a ramen stěračů
- H** Akkusaru és ablaktörökárhúzó
- RO** Extractor brat ștergator, clemă baterie
- F** Extracteur d'essuie glaces et cosse de batterie
- I** Estrattore 2 griffe
- E** Extractor tirador exterior para brazo del limpiaparabrisas / terminal de batería
- CN** 电瓶接头拉马



5-30
mm
ADJUSTABLE
NASTAWNY

YATO	Ø (mm)	
YT-25145	5-30	48

- GB** A/C disconnect tool
- D** Klimaanlage Frühling Lock
- PL** Zestaw do złącz systemów klimatyzacji
- RUS** Клипсы соединителей, фитингов кондиционера
- CZ** Sada na rozpojení trubek klimatizace
- H** Légkondicionáló cső leválasztó készlet
- RO** Set de scule pt. deconectat tuburi de aer conditionat

- F** Climatisation tube raccords démontage et entretien outils
- I** Kit per giunti dell'impianto aria condizionata
- E** Juego para la desconexión de tubos de aire acondicionado
- CN** 卡圈组套



4
PCS
3/8"
10mm
1/2"
5/8"
12.5mm
15.9mm
3/4"
19mm

BLISTER
CARD

YATO		
YT-06303		6/48

- GB** Transmission line disconnect tool set
- D** Werkzeugsatz zum Trennen von Kraftstoffleitungen
- PL** Zestaw do rozłączania przewodów
- RUS** Набор для рассоединения топливopроводов
- CZ** Sada na rozpojení palivového potrubí
- H** Üzemanyagszó-lebontó készlet
- RO** Set pt. deconectarea liniilor de combustibil
- F** Set pour disjoindre des câbles
- I** Set per scollegare i tubi di carburante
- E** Juego para desconectar conductos de combustible
- CN** 油管拆卸组套

8
PCS
**FOR A/C
DO KLIMATYZACJI**
**FOR FUEL LINE
DO PRZEWODÓW PALIWA**

- GB** Conditioning tool set
- D** Ansatz-Set für die Klimaanlage
- PL** Zestaw nasadek do klimatyzacji
- RUS** Набор насадок для системы кондиционирования
- CZ** Sada zásuvek pro klimatizaci
- H** Dugókulcs készlet klíma berendezéshez

- RO** Set unelte aer conditionat
- F** Ensemble de douille pour la climatisation
- I** Kit di attacchi per impianto aria condizionata
- E** Juego de vasos para el aire acondicionado
- CN** 空调修理组套

12
PCS
1/4"
6.3mm
STAR
TAMPERPROOF
CrV



YATO		
YT-0630		20



1/4" (6.3 mm): SW12, SW15 (L=40 mm); CrV;
1/4" (6.3 mm): 2.2, 3.2 mm (L=50 mm); CrV;
1/4" (6.3 mm);
1/4" (6.3 mm): TS10, TS15, TS20, TS25, TS27, TS30, TS40 (L=25 mm); CrV

YATO		
YT-12007		10/20

GB Common cool gas meter
D Steuerungsset für Klimaanlage
PL Zestaw do obsługi systemów klimatyzacji
RUS Комплект для работы систем кондиционирования
CZ Sada pro obsluhu klimatizačních systémů
H Klíma szivárgáskereső készlet

RO Trusa verificare si incarcare instalatii ac
F Kit d'entretien du système de climatisation
I Tester per l'aria condizionata
E Kit de operación de sistemas de aire acondicionado
CN 冷媒表

6
PCS

145
cm

R-134a

0-0.8
MPa

0-3.4
MPa



YATO
YT-72990 6

GB Door upholstery remover
D Abziehvorrichtung für Polstererklammern
PL Ściągacz do spinek tapicerki
RUS Съёмник крепежа обивки

CZ Uvolňovač čalounění dveří
H Kárpitkiszedő
RO Dispozitiv de scos agrafe de tapiterie
F Spatule d'extraction de clips

I Estrattore per la rimozione di graffette tappezzeria
E Extractor de grapas de vestidura
CN 胶扣起子

SLIDING CARD



230
mm

YATO
YT-0841

L (mm)
230

16/64

200
mm

YATO
YT-0842

L (mm)
200

25/100

GB Door upholstery remover
D Abziehvorrichtung für Polstererklammern
PL Ściągacz do spinek tapicerki
RUS Съёмник крепежа обивки

CZ Uvolňovač čalounění dveří
H Kárpitkiszedő
RO Dispozitiv de scos agrafe de tapiterie

F Arrache agrafes
I Estrattore per la rimozione di graffette tappezzeria

E Extractor de grapas de vestidura
CN 胶扣起子

SVCN



YATO
YT-1370

size / rozmiar (mm)
6x100

12/120

YATO
YT-1371

size / rozmiar (mm)
6.2x115

12/120



YATO
YT-1372

size / rozmiar (mm)
10x115

12/120

YATO
YT-1373

size / rozmiar (mm)
9.5x134

6/96

GB Scratch awl
D Einfache Spicknadel
PL Szpikuliec prosty
RUS Прямое острьё

CZ Šídlo rovné
H Spékelőtű, egyenes
RO Dorn perforare drept
F Brochette droite

I Punteruolo piatto
E Punzón recto
CN 锥子

SVCN



YATO
YT-1374

L (mm)
120

12/120

GB Hook bodkin
D Hakenspicknadel
PL Szpikuliec hakowy
RUS Крюковое острьё
CZ Šídlo háčkové
H Spékelőtű, horgos

RO Dorn perforare îndoit
F Brochette coudée
I Gancio punteruolo
E Punzón encorvado
CN 油封拉拔器

SVCN

90°



YATO
YT-1375

L (mm)
125

12/120

- GB** Battery cap tool
D Abziehvorrichtung für Akkuklemmen
PL Ściągacz do klem akumulatora
RUS Стяжка для клемм аккумулятора
CZ Stahovák svorek akumulátoru
H Akkumulátor saru leköz
- RO** Extractor pt. clemă acumulator
F Tournevis plat pour bouchons de batterie
I Batteria clem estrattore
E Extractor para los bornes de la batería
CN 扁铲

SVCM



YATO	size / rozmiar (mm)	
YT-1378	18.5x100	12/120

- GB** Glass scraper
D Scheibenkratzer
PL Skrobak do szyb
RUS Шабера для скла
- CZ** Škrabka na okna
H Jégkaparó
RO Răzuitor geamuri
F Gratteur pour vitres

- I** Raschietto per vetro
E Rascador para los vidrios
CN 刮刀

SVCM



YATO	size / rozmiar (mm)	
YT-1379	39x200	6/72

- GB** Spare blades for glass scraper
D Abbrechklingen
PL Ostrze do skrobaka do szyb
RUS Лезвия для универсальных ножей
CZ Lomené ostří náhradní
H Törhető tartalékpenge
RO Lamă de rezervă rupte
- F** Lames pour gratteur pour vitres
I Lame per raschietto
E Filo partido de recambio
CN 刮刀刀片

10 PCS SK5

for / dla: YT-1379



COLOR BOX

YATO	size / rozmiar (mm)	
YT-13790	19x39	50

- GB** Flexible spinner handle
D Elastischer Dreher
PL Pokrętko elastyczne
RUS Эластичный вороток
- CZ** Šroubovák ohebný
H Hajlékony csavarhúzó
RO Mâner flexibil
- F** Barre élastique
I Chiave flessibile
E Llave flexible
CN 套筒螺丝批

1/4" 6.3mm

SVCM



YATO	size / rozmiar	
YT-1381	1/4" (6.3 mm) x 150 mm	6/96

- GB** Flexible magnetic bit driver
D Elastischer Dreher für Bits
PL Pokrętko elastyczne do bitów
- RUS** Эластичный вороток для разряда битов
CZ Šroubovák ohebný na bity
H Hajlékony csavarhúzó, hosszú

- RO** Mâner flexibil pt. vârf șurubelniță
F Barre élastique
I Chiave flessibile

- E** Mango flexible para desarmadores
CN 批头螺丝批

SVCM



YATO	size / rozmiar	
YT-1382	1/4" (6.3 mm) x 380 mm	6/72

- GB** Flexible magnetic pick up tool
D Elastische Magnethalterung
PL Elastyczny uchwyt magnetyczny
- RUS** Эластичный магнитный держатель
CZ Ohebný magnetický držák
H Hajlékony csavarhúzó, hosszú, mágneses

- RO** Mâner magnetic flexibil
F Capteur magnétique

- I** Chiave flessibile
E Mango magnético flexible
CN 拾拾器

SVCM



YATO	L (mm)	
YT-1385	400	6/72

- GB** Circlip pliers
D Seegeringzange
PL Szczypce Segera
RUS Съёмник стопорных колец
CZ Kleště Segera
H Segerfogó belseő
- RO** Clește Seger
F Pince pour anneau de retenue seeger
I Pinze Seger
E Alicates Seger
CN 5件套卡簧钳

		23 mm max.			20 mm max.
		28 mm max.			23 mm max.
		30 mm max.			27 mm max.



SLIDING CARD



5 PCS

160 mm

10-50 mm



YATO	L (mm)	
YT-2130	160	20/60

- GB** Circlip pliers
D Seegeringzange
PL Szczypce Segera
RUS Съёмник стопорных колец
CZ Kleště Segera
- H** Segerfogó belseő
RO Clește Seger
F Pince pour anneau de retenue seeger

- I** Pinze Seger
E Alicates Seger
CN 直嘴轴用挡圈钳

SLIDING CARD



180 mm

HRC 42-48

CrV 50



YATO	L (mm)	
YT-2136	180	6/24



YATO	L (mm)	
YT-2138	180	6/24



YATO	L (mm)	
YT-2137	180	6/24



YATO	L (mm)	
YT-2139	180	6/24



GB Circlip pliers
D Seegeringgzange
PL Szczypce Segeera
RUS Съёмник стопорных колец
CZ Kleště Segera
H Seegerfogó belső
RO Clește Seger
F Pince pour anneau de retenue seeger
I Pinze Seger
E Alicates Seger
CN 直嘴轴用挡圈钳

SLIDING CARD





150 mm 200 mm
CrV NICKEL IRON FINISH





YATO 	L (mm)	
YT-2140	150	6/120
YT-2144	200	6/60





YATO 	L (mm)	
YT-2141	150	6/120
YT-2145	200	6/60



YATO 	L (mm)	
YT-2142	150	6/60
YT-2146	200	6/60



YATO 	L (mm)	
YT-2143	150	6/120
YT-2147	200	6/60



GB Circlip pliers
D Seegeringgzange
PL Szczypce Segeera
RUS Съёмник стопорных колец
CZ Kleště Segera
H Seegerfogó belső
RO Clește Seger
F Pince pour anneau de retenue seeger
I Pinze Seger
E Alicates Seger
CN 直嘴轴用挡圈钳

SLIDING CARD





225 mm 325 mm
NICKEL FINISH CrV





YATO 	L (mm)	
YT-1988	225	6/60
YT-1992	325	6/48





YATO 	L (mm)	
YT-1989	225	6/60
YT-1993	325	6/48



YATO 	L (mm)	
YT-1990	225	6/60
YT-1994	325	6/48



YATO 	L (mm)	
YT-1991	225	6/60
YT-1995	325	6/48

- GB** CV boot clamp pliers
D Zange für Schellen der Gelenkabdeckung
PL Szczypce do oprasek osłony przegubu
RUS Щипцы для хомутов крепления кожуха шарнира
CZ Kleště na spony manžety kloubu
H Féltengely bilincs húzó fogó
RO Clește sigurantă burduf planetara
F Pince pour collier à recouvrement de joint
I Pinza a morsetto per fascette pinzabili
E Alicates para abrazadera de protección de la junta
CN 夹紧钳

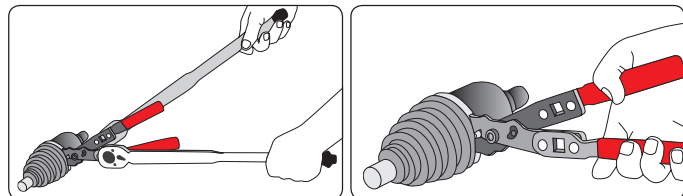

YATO	L (mm)	
YT-0606	235	6/36

- GB** CV boot clamp pliers
D Zange für Schellen der Gelenkabdeckung
PL Szczypce do oprasek osłony przegubu
RUS Щипцы для хомутов крепления кожуха шарнира
CZ Kleště na spony manžety kloubu
H Féltengely bilincs húzó fogó
RO Clește sigurantă burduf planetara
F Pince pour collier à recouvrement de joint
I Pinza a morsetto per fascette pinzabili
E Alicates para abrazadera de protección de la junta
CN 夹紧钳

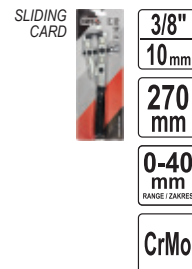

YATO	L (mm)	
YT-06535	270	5/20

- GB** Lock-ring pliers
D Sprezzange für Schellen
PL Szczypce rozporowe do pierścieni osadzczych
RUS Щипцы распорные для стяжных хомутов
CZ Kleště na hadicové spony
H Seeger fogó
RO Clește pt. desfacerea brățarelor de strângere
F Pince tenaille pour les bagues de retenue
I Pinza per rondelle elastiche scanalata
E Alicates para abrazaderas
CN C型扣钳



YATO	L (mm)	
YT-0607	225	12/72

- GB** Fuel fuel pipe pliers
D Zange für Tankverschlüsse
PL Szczypce do złączek paliwowych
RUS Щипцы для топливных соединений
CZ Kleště na spojky palivového systému
H Üzemanyagvezeték fogó
RO Clește pt. conectoare de combustibil
F Pince tenaille pour connecteurs de carburant
I Pinza per tubo carburante
E Alicates para enchufes de combustible
CN 油管钳

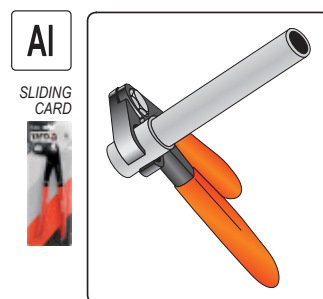

YATO	
YT-0608	10/40

- GB** Hose removing pliers
D Schlauch- und Kabellöseange
PL Szczypce do zdejmowania przewodów
RUS Клещи для снятия изляции
CZ Kleště na demontáž hadic
H Tömlőbilincs fogó
RO Clește pt. indepartat furtune
F Pince pour enlever les fils
I Pinza spelacavi universale
E Alicates de extracción de mangueras
CN 油管分离钳

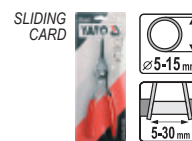

YATO	
YT-0657	6/36

- GB** Double joint long nose pliers
D Kneifzange verlängert gerade 2 Gelenke
PL Szczypce wydłużone proste przegubowe
RUS Плоскогубцы прямые 2 шарнира
CZ Prodloužené kleště rovné se zdvojeným kloubem
H Hosszú egyenes 2 csuklós fogó
RO Clește cu falci lungi
F Pince allongée droite à 2 articulations
I Pinza lunga dritta con 2 giunti
E Alicates de pinzas largas rectas 2 articulaciones
CN 尖嘴钳



YATO	L (mm)	
YT-20400	340	5/50

HALF DOUBLE BLISTER

GB Double joint bent nose pliers
D Kneifzange verlängert gebogen 2 Gelenke
PL Szczypce wydłużone wygięte przegubowe
RUS Плоскогубцы изогнутые 2 шарнира
CZ Prodloužené kleště zahnuté se zdvojeným kloubem

H Hosszú hajlított 2 csuklós fogó
RO Clește cu falci curbate
F Pince allongée coudée à 2 articulations
I Pinza lunga dritta con 2 giunti

E Alicates de pinzas largas curvadas 2 articulaciones
CN 弯嘴钳

45° HRC 50 CrV



YATO	L (mm)	
YT-20401	330	5/50

GB Double joint bent nose pliers
D Kneifzange verlängert gebogen 2 Gelenke
PL Szczypce wydłużone wygięte przegubowe
RUS Плоскогубцы изогнутые 2 шарнира
CZ Prodloužené kleště zahnuté se zdvojeným kloubem

H Hosszú hajlított 2 csuklós fogó
RO Clește cu falci curbate
F Pince allongée coudée à 2 articulations
I Pinza lunga dritta con 2 giunti

E Alicates de pinzas largas curvadas 2 articulaciones
CN 弯嘴钳

90° HRC 50 CrV



YATO	L (mm)	
YT-20402	330	5/50

GB Multi-purpose hose & wire pliers
D Zangensatz für Schellen und Leitungen
PL Komplet szczypiec do opasek i przewodów
RUS Набор щипцов к хомутам и проводам
CZ Souprava kleští na spony a hadice
H Fogókészlet bilincsekhez és vezetékhez
RO Set clește pt. benzii și conducte
F Pince pour collier de serrage
I Set pinze per il morsetto
E Juego de pinzas para abrazaderas y cables
CN 多功能管夹钳



2 PCS
1/4"-3/4"
6.3-19.0 mm
217 mm
254 mm

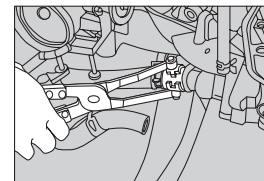
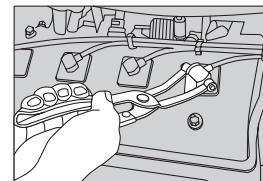
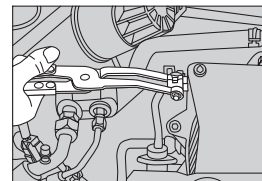
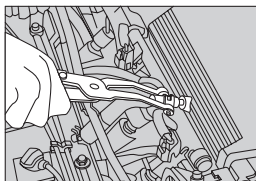

For engine air pipe
Do przewodów powietrznych listwy wtryskowej

For engine intake air pipe
Do przewodów gumowych układu zasilania

For spark plug lead
Do przewodów zapłonowych

For cooling water pipe
Do przewodów gumowych układu chłodzenia



YATO	L (mm)	
YT-0645	217	6/24
	254	

GB Hose clamp pliers
D Zange zum Entspannen der Klemmschellen
PL Szczypce do opasek zaciskowych rozprężnych

RUS Щипцы к хомутам зажимным распорным
CZ Kleště na samosvorné hadicové spony
H Vízcsőbilincs fogó
RO Clește pt. benzile de strângere destindere

F Pince pour collier de serrage
I Set pinze per il morsetto
E Pinzas para las abrazaderas de expansión
CN 管夹钳

SLIDING CARD



215 mm + SLOT 2 mm
LOCK SYSTEM SYSTEM BLOKADY ALLOY STEEL AISI 4130

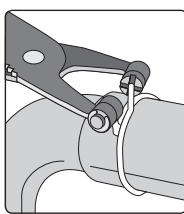

YATO	L (mm)	
YT-0646	215	12/72

GB Hose clamp pliers
D Zange zum Entspannen der Klemmschellen
PL Szczypce do opasek zaciskowych rozprężnych

RUS Щипцы к хомутам зажимным распорным
CZ Kleště na samosvorné hadicové spony
H Vízcsőbilincs fogó
RO Clește pt. benzile de strângere destindere

F Pince pour collier de serrage
I Set pinze per il morsetto
E Pinzas para las abrazaderas de expansión
CN 管夹钳

SLIDING CARD



215 mm V SLOT LOCK SYSTEM SYSTEM BLOKADY 4.5 mm ALLOY STEEL AISI 4130

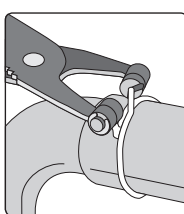

YATO	L (mm)	
YT-0647	215	12/72

- GB** Hose clamp pliers
D Zange zum Entspannen der Klemmschellen
PL Szczypce do opasek zaciskowych rozprężnych
RUS Щипцы к хомутам зажимным распорным
CZ Kleště na samosvorné hadicové spony
H Vizsősíbilincs fogó

- RO** Clește pt. benzile de strângere destindere
F Pince pour collier de serrage
I Set pinze per il morsetto
E Pinzas para las abrazaderas de expansión
CN 管夹钳

SLIDING
CARD

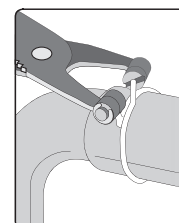

230
mm



215
mm

YATO	L (mm)	
YT-0650	230	6/36

YATO	L (mm)	
YT-0651	215	6/36

- GB** Exhaust pipe clamp pliers
D Auspuffschellen-Sicherungszange
PL Szczypce do opasek wydechu
RUS Щипцы для пружинных зажимов
CZ Kleště na spony výfuku
H Kipufogóbilincs fogó

- RO** Clește pt. coliere teava de esapament
F Pince pour joints de queues de soupapes
I Set pinze per il morsetto
E Pinzas para bridas del tubo de escape
CN 排气管夹钳

SLIDING
CARD



300
mm

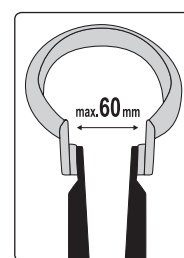

for / dla: Peugeot, Citroën,
Renault, Fiat, Ford

YATO	L (mm)	
YT-0652	300	10/20

- GB** Valve stem seal pliers
D Lange Zange für Ventildichtringe
PL Szczypce do uszczelniaczy zaworowych, długie
RUS Щипцы для замены маслосъемных колпачков
CZ Kleště na těsnění ventilů, dlouhé
H Szelepszár szimering fogó hosszú

- RO** Clește cu picior lung pt. sigilat supape
F Pince pour joints de queues de soupapes
I Pinza per tenuta anello stelo valvola
E Pinzas para juntas de vástago válvula
CN 气门油封钳

SLIDING
CARD



270
mm
FOR VALVE
STEM SEALS
DO USZCZELNIACZY
ZAWOROWYCH

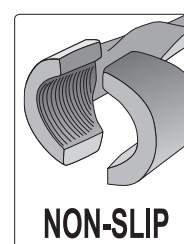

YATO	L (mm)	
YT-0648	270	12/60

- GB** Pliers for band clips with a cord
D Zange für Rohrschellen mit Seil
PL Szczypce z linką do opasek zaciskowych
RUS Щипцы к зажимным хомутам с тросиком
CZ Kleště s lankem na samosvorné hadicové spony
H Flexibilis bowdenes vizsősíbilincs fogó
RO Clește pt. cleme de prindere frânghie
F Pince pour collier de serrage
I Pinza per il montaggio e lo smontaggio delle clips elastiche

- E** Pinzas para bandas de apretadura con cuerda
CN 延长型弹性管夹钳

CrMo
4140

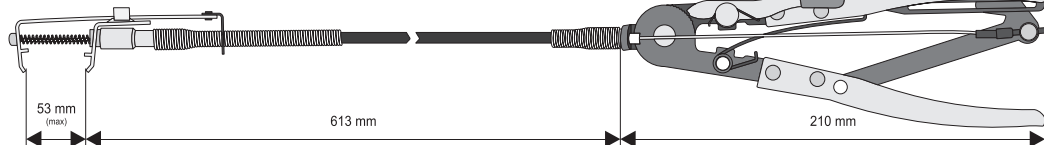
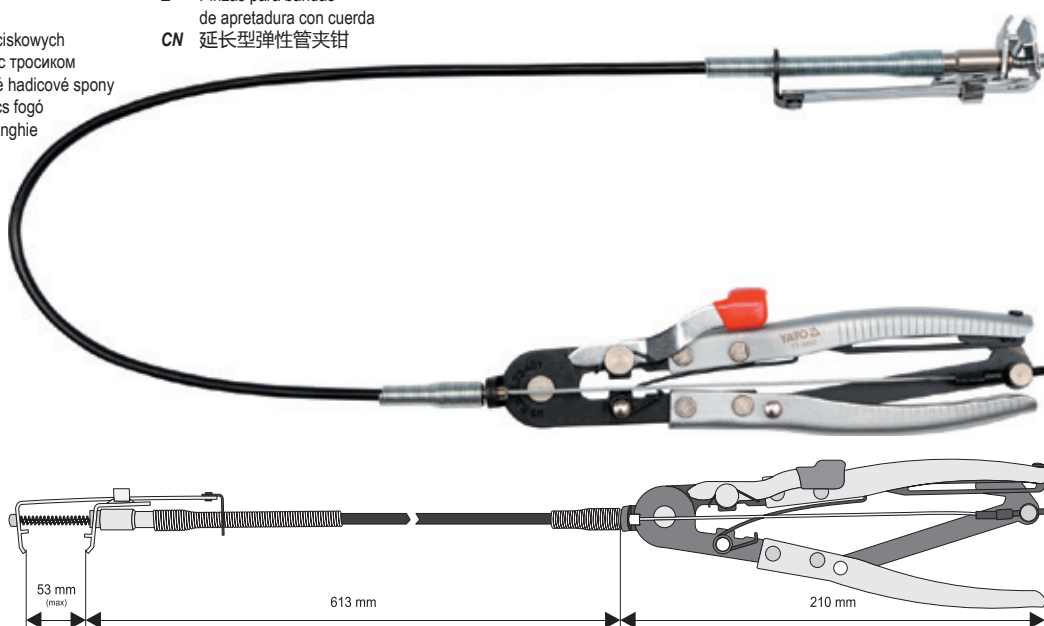

SLIDING
CARD



YATO	L (mm)	
YT-0653	613	12/36

- GB Pliers for band clips with a cord
- D Zange für Rohrschellen mit Seil
- PL Szczypce z linką do opasek zaciskowych
- RUS Щипцы к зажимным хомутам с тросиком
- CZ Kleště s lankem na samosvorné hadicové spony
- H Flexibilis bowdenes vízcsőbilincs fogó
- RO Clește pt. cleme de prindere frânghie
- F Pince pour collier de serrage
- I Pinza per il montaggio e lo smontaggio delle clips elastiche
- E Pinzas para bandas de apretadura con cuerda
- CN 延长型弹性管夹钳

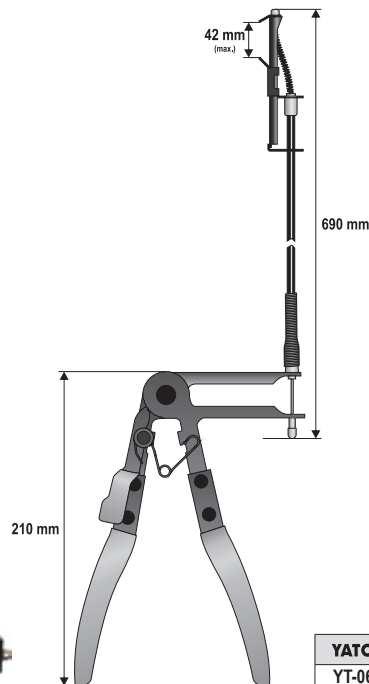

CrMo
4140

SLIDING CARD



YATO	
YT-0677	25

- GB Hose clip pliers
- D Schlauchklemmzange
- PL Szczypce do opasek zaciskowych typu CLIC i CLIC-R
- RUS Плоскогубцы для зажима шлангов хомуты, CLIC-R
- CZ Kleště na hadicové spony
- H Tömlőbilincs fogó
- RO Cleste furtun clip
- F Pince pour collier de serrage
- I Pinza per fascetta a CLIC e CLIC-R
- E Alicates abrazaderas
- CN 压线钳



170
mm

CLIC
CLIC-R

SLIDING CARD



YATO	L (mm)	
YT-06475	170	15/60

- GB Water pump pulley locking wrench
- D Schlüssel für die Wasserpumpe
- PL Klucz do pompy wodnej
- RUS Ключ к водному насосу
- CZ Klíč na vodní čerpadlo
- H Vizpumpafogó
- RO Cheie pt. pompe de apă
- F Clé de blocage pour pompe à eau
- I Chiave per la pompa del acqua
- E Llave para la bomba de agua
- CN 水泵皮带轮扳手

30.5
mm

60
mm

285
mm

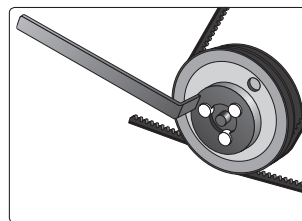

Volkswagen and Audi with air condition
Volkswagen i Audi z klimatyzacją

SLIDING CARD



YATO	L (mm)	
YT-0540	285	6/36

- GB Spark plug puller set VAG
- D Abzieher-Satz Zündspulen VAG
- PL Zestaw ściągaczy do cewek zapłonowych VAG
- RUS Набор съемников для катушек зажигания VAG
- CZ Sada stahováků zapalovací cívkvy
- H Gyújtótekercs lehúzó készlet
- RO Set bobina de aprindere tragator
- F Set d'extracteurs des bobines d'allumage
- I Set per la rimozione rapida bobine di accensione nelle auto VAG
- E Extractores bobinas de encendido grupo VAG
- CN 四件套火花塞维修工具



4
PCS

FOR / DLA
V.A.G.

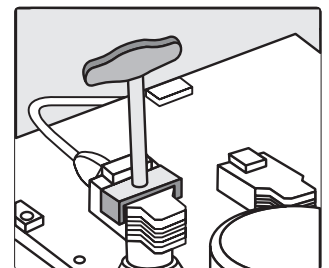
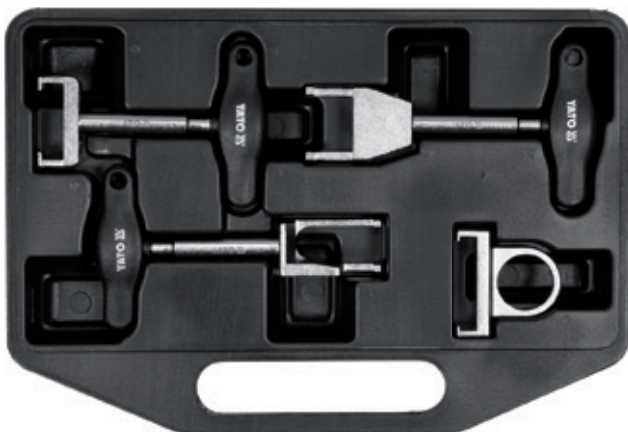

for / dla: VW, Audi, Skoda, Seat

YATO			
YT-06205	T type 1		Volkswagen FSI Golf / Bora 1998, Polo 2002, Touran 2004, New Beetle 2003, Passat 1997, T4+Audi A2 2001
	T type 2		Silniki/engines 6 cyl. 24V, 5 cyl. Golf / Bora 1998, Passat / Touareg 1997, Sharan 1996, Phaeton / Toureg 6 cyl. 2003, T5 z 6 cyl. silnikiem 2004
	T type 3		Volkswagen silnik / engines 2.0 z bezp. wtrysk / direct injection, Touran 2004, Passat 2006, Audi z bezp.wtrysk / direct injection A3 2.0 2004, A6 3.2 2005
	T type 4		Volkswagen z bezp. wtrysk / direct injection 2.0, Golf / Touran 2004, Passat 2006, Audi z bezp. wtrysk / direct injection, A3 2.0 2004, A6 3.2 2005

- GB Tensioner pulley wrench
- D Zahnriemen Spannrollenschlüssel
- PL Klucz do rolki napinającej
- RUS Ключ для регулировки натяжного
- CZ Klíč na napínák
- H Bordás szíj feszítő
- RO Cheie de pretensionare a centurilor
- F Clé pour rouleau de tension
- I Chiave per il rullo tenditore
- E Llave del tensor de la correa dentada
- CN 滑轮定时扳手



SLIDING CARD



32 mm

YATO	
YT-06273	20/100

- GB Universal pulley holder & fan clutch set
- D Schlüssel zum Spannen der Riemenscheibe
- PL Klucz do napinania koła pasowego
- RUS Ключ для натягивания шкива
- CZ Klíč k napínání řemenice

- H Szíjtárcsa feszítő kulcs
- RO Cheie pt. întindere roată de curea
- F Clé universelle pour poulie
- I Blocca puleggia
- E Llave tensadora para polea
- CN 多用途皮带轮扳手



11 PCS

BMC & COLOR SLEEVE

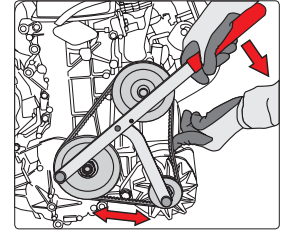

Ø 6-10 mm; Ø 8-11 mm;
Ø 10-12 mm; Ø 11-16 mm

YATO	
YT-0627	8



- GB Piston ring compressor
- D Kolbenring-Spannband
- PL Zaciskacz do pierścieni
- RUS Оправка поршневых колец
- CZ Svěrka na kroužky
- H Gyűrűbepattintó
- RO Clește pt. strâns inele
- F Compresseur de segments de piston
- I Morsetto per anelli
- E Apretador de anillos
- CN 活塞环压缩机

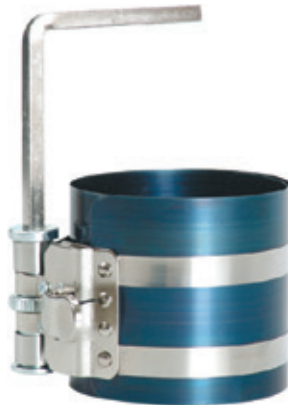

AISI # 301 SK5

COLOR BOX



YATO	Ø (mm)	H (mm)	
YT-0635	50-125	75	30/60
YT-0636	90-175	100	30/60
YT-0637	90-175	150	20/40

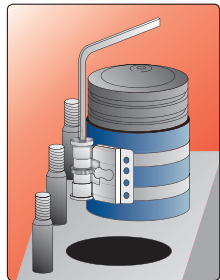

- GB Piston rings pliers
- D Kolbenringe Zange
- PL Szczypce do pierścieni tłokowych
- RUS Клещи для установки поршневых колец
- CZ Kleště na pístní kroužky
- H Dugattyűgyűrű fogók

- RO Clește pt. inelul de piston
- F Pince pour anneau de piston
- I Pinze per anelli di pistoni
- E Alicates de anillo de pistón
- CN 活塞环钳

40-100 mm



SLIDING CARD



YATO	
YT-06377	5/50

- GB Cylinder honing machine
- D Ziehschleifmaschine für Motorenzylinder
- PL Honownica do cylindrów
- RUS Хонинговальный станок

- CZ Valcový honovací stroj
- H Henger hónoló
- RO Mașină de honuit cilindri
- F Machine à roder des cylindres

- I Levigatrice per cilindri
- E Máquina herramienta para afilar los cilindros
- CN 气缸打磨器

SLIDING CARD



X3 HONES KAMENIE

HONING TENSION REGULOWANY NACISK

FLEXIBLE SHAFT ELASTYCZNY WALEK



19-63 mm

205 mm

28x6 mm HONE SIZE ROZMIAR KAMIENIA

32-89 mm

230 mm

51x7 mm HONE SIZE ROZMIAR KAMIENIA



51-177 mm

305 mm

76x10 mm HONE SIZE ROZMIAR KAMIENIA



YATO	Ø L (mm)	L (mm)	
YT-05810	19-63	205	50/100

YATO	Ø L (mm)	L (mm)	
YT-05811	32-89	230	50/100

YATO	Ø L (mm)	L (mm)	
YT-05812	51-177	305	5/20

GB Interchangeable stones for honing machine
D Wechselschleifsteine für die Ziehschleifmaschine
PL Kamienie wymienne do honownicy
RUS Сменный брусок для хонинговального станка

CZ Výměnné kameny do honovacího stroje
H Cserélhető kövek a hónolóhoz
RO Pietre interșanjabile pt. mașina de honuit
F Pierres interchangeable de la machine à roder

I Set di pietre di ricambio per levigatrice
E Piedras intercambiables a la máquina
herramienta para afilar cilindros
CN 磨石

SLIDING
CARD



3
PCS

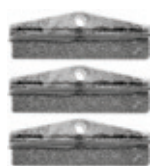

28x6
mm
HONING STONE
RODERKAMEN

for / dla: YT-05810



51x7
mm
HONING STONE
RODERKAMEN

for / dla: YT-05811

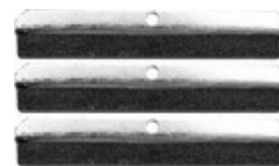

76x10
mm
HONING STONE
RODERKAMEN

for / dla: YT-05812

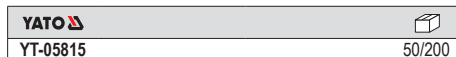

GB Belt gauge
D Werkzeug Spannungsprüfer
PL Przyrząd do kontroli naciągu paska rozrządu
RUS Прибор для проверки натяжения ремней
rozvodového řemene
CZ Přístroj pro kontrolu napnutí
rozvodového řemene
H Méter szíjfeszességet
RO Tester întindere curea
de distributie cu gradatie

F Controleur de tension de courroie
I Strumento per il controllo rapido
della tensione cinghia distribuzione
E Medidor para determinar
la tensión de la correa
CN 皮帶張緊器

GB Special socket antechamber injection pump
D Kerbzahn-Einsatz Für Vorkammer-Muttern
an Dieselmotoren
PL Nasadka do komory wstępnej wirowej
an Dieselmotoren
RUS Сервисный ключ для форкамер
CZ Klíč pro vstřikovací čerpadla
H Dugókulcs befecskendező
szivattyúhoz
RO Tubulara speciala pt. anticamera
pompa de injectie motoare
F Douille spéciale pipe d'admission
I Bussola per precamera
E Llave de vaso con dentado exterior
para cámara de precombustión
CN 奔驰火花塞外齿套筒



COLOR BOX

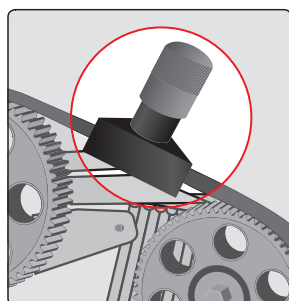

1/2"

12.5mm

Ø
28mm

FOR
MERCEDES
DO
MERCEDESA

PLASTIC
HANGER



GB Twin cam locking tool for petrol & diesel engines
D Universelle Blockade der Steuerwellen
PL Uniwersalna blokada wałków rozrządu
RUS Универсальный набор блокировки распределвала
CZ Univerzální přípravek na zablokování rozvodných hřídelí
H Univerzális vezérműtengely rögzítő

RO Dispozit universal blocare distributie
F Outil de blocage d'arbre à cames
I Universale strumento di bloccaggio a camme
E Bloqueo universal de eje de distribución
CN 双凸齿轮固定器

DOHC

FOR PETROL
& DIESEL ENGINES
DO SILNIKÓW
DIEŚLA
I BENZYNOWYCH

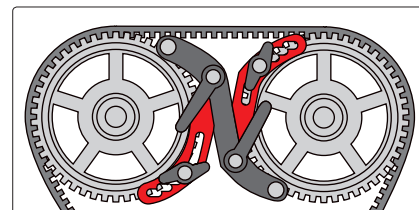

BMC



GB Twin cam locking tool for petrol & diesel engines
D Universelle Blockade der Steuerwellen
PL Uniwersalna blokada wałków rozrządu
RUS Универсальный набор блокировки распределвала
CZ Univerzální přípravek na zablokování rozvodných hřídelí
H Univerzális vezérműtengely rögzítő

RO Dispozit universal blocare distributie
F Outil de blocage d'arbre à cames
I Universale strumento di bloccaggio a camme
E Bloqueo universal de eje de distribución
CN 双凸齿轮固定器

FOR PETROL
& DIESEL ENGINES
DO SILNIKÓW
DIEŚLA
I BENZYNOWYCH

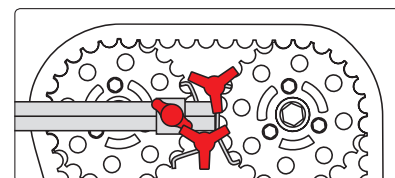

SLIDING
CARD



- GB** Camshaft locking tool
D Nockenwellen-Arretierwerkzeug
PL Przyrząd do blokowania kół rozrzędu
RUS Инструмент для блокирования распределительных механизмов
CZ Přípravek k montáži rozvodových kol
H Vezérlés rögzítő szerszám
RO Arbore cu came
F Outil de blocage d'arbre à cames
I Set di serrature di temporizzazione
E Aparato para bloquear el árbol de levas
CN 正时皮带固定器



48 mm

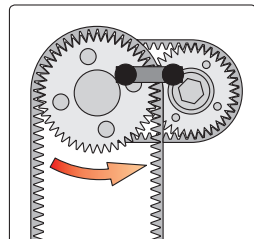

VW Lupo since 1999
VW Polo since 1995
VW Caddy since 1996
VW Polo Classic since 1996

VW Polo Variant since 1996
VW New Beetle 1.4 l
VW Golf 1.4 l, 1.6 l since 1998
VW Bora 1.4 l, 1.6 l since 1999

YATO	
YT-0601	6/36

- GB** Diesel engine locking setting kit
D Blockade für die Steuerräder
PL Blokada do kół rozrzędu
RUS Блокировка к колесам распределительных механизмов
CZ Souprava na fixaci rozvodových kol
H Diesel motor rögzítő készlet

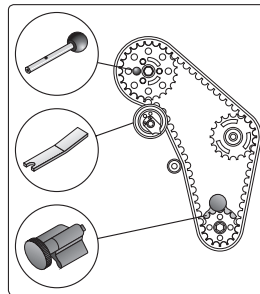

VW: Lupo, Polo, Golf / Bora, Beetle, Caddy, Sharan, Touran, Transporter (1998-2006);
AUDI: A2, A3, A4, A6;
FORD: Galaxy (2000-2006);

- RO** Blocadă roților distributive
F Outil de blocage d'arbre à cames
I Cinghia di distribuzione di bloccaggio
E Bloqueo para las poleas del mecanismo de distribución
CN 正时皮带更换工具

3 PCS



SEAT: Arosa, Ibiza, Cordoba, Leon, Toledo, Alhambra (1999-2005);
SKODA: Fabia, Octavia (2000-2006)
3 i 4 cyl 1.2, 1.4, 1.9 TDI PD
2.0 SDI, 2.0 TDI PD

SLIDING CARD



YATO	
YT-0632	10/50

- GB** Timing locking set
D Arretierwerkzeugsatz für Nockenwellen
PL Zestaw blokad rozrzędu
RUS Набор блокировок к колесам распределительных механизмов
CZ Blokovací sada pro opravy rozvodů
H Vezérműrgyítő szerszámkészlet
- RO** Set blocare distributie auto
F Outil de blocage d'arbre à cames
I Set di bloccaggio distribuzione auto
E Juego de bloqueos de distribución
CN 正时皮带固定器组套

RENAULT: Twingo, Clio, Kangoo, Megane, Scenic, Laguna, Espace 1.2, 1.4, 1.6, 1.8, 2.0 16v (98-06), 1.5dCi;
NISSAN: Micra 1.5dCi, Kubistar 1.6 16v (03-06);
OPEL: Vivaro 2.0 16v (01-06)
ENGINE CODES:
RENAULT: D4F, K4J, K4M, F4P F4R, F4Rt, F5R740, K9K;
NISSAN: K9K, K4M; OPEL: FR4 720

RENAULT: Twingo, Clio, Kangoo, Megane, Scenic, Laguna, Espace 1.2, 1.4, 1.6, 1.8, 2.0 16v (98-06), 1.5dCi;
NISSAN: Micra 1.5dCi, Kubistar 1.6 16v (03-06);
OPEL: Vivaro 2.0 16v (01-06)
SILNIKI O KODZIE:
RENAULT: D4F, K4J, K4M, F4P F4R, F4Rt, F5R740, K9K;
NISSAN: K9K, K4M; OPEL: FR4 720



3 PCS



BMC & COLOR SLEEVE

YATO	
YT-06014	10

- GB** Timing locking set
D Arretierwerkzeugsatz für Nockenwellen
PL Zestaw blokad rozrzędu
RUS Набор блокировок к колесам распределительных механизмов
- CZ** Blokovací sada pro opravy rozvodů
H Vezérműrgyítő szerszámkészlet
RO Set blocare distributie auto
F Outil de blocage d'arbre à cames
- I** Set di bloccaggio distribuzione auto
E Juego de bloqueos de distribución
CN 正时皮带固定器组套

4 PCS

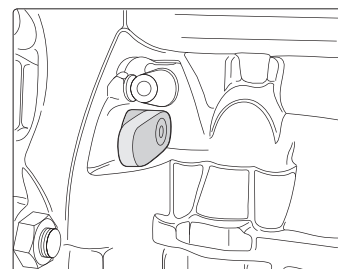
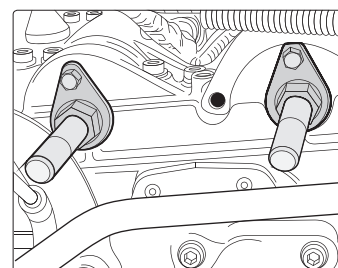

VW, SKODA, SEAT 1.2 12V and 1.2 6V (HTP);
VW: Polo; SEAT: Ibiza, Cordoba; SKODA: Fabia HTP;
Engine codes AZQ, AWY, BMD, BME (02-07).

VW, SKODA, SEAT 1.2 12V i 1.2 6V (HTP);
VW: Polo; SEAT: Ibiza, Cordoba; SKODA: Fabia HTP;
Silniki o kodzie AZQ, AWY, BMD, BME (02-07).

- camshaft locking pin 1 pc
- crankshaft locking pin 1 pc
- camshaft locking clamps 2 pcs

- trzpień blokujący wałek rozrzędu 1 szt.
- trzpień blokujący wał korbowy 1 szt.
- zacisk blokujący walki rozrzędu 2 szt.



BMC & COLOR SLEEVE

YATO	
YT-06012	10

- GB** Timing locking set
D Arretierwerkzeugsatz für Nockenwellen
PL Zestaw blokad rozrządu
RUS Набор блокировок к колесам распределительных механизмов
CZ Blokovací sada pro opravy rozvodů
H Vezérműrgőztető szerszámkészlet
RO Set blocare distributie auto
F Outil de blocage d'arbre à cames
I Set di bloccaggio distribuzione auto
E Juego de bloques de distribución
CN 正时皮带固定器组套

FIAT: 500, Panda, Punto, Grande Punto, Albea, Linea, Bravo, Brava, Palio, Idea, Weekend, Siena, Stilo, Marea (97-10);
LANCIA: Ypsilon, Musa (96-10)
ENGINE CODES / SILNIKI O KODZIE:
1.2 16V - 176B9.000, 182B2.000, 188A5.000,
1.4 16V - 843A1.000, 169A3.000, 192B2.000,
198A1.000, 198A4.000, 199A6.000



5
PCS

FOR VALVETRAIN
DO UKŁADU
ROZRZĄDU

FOR GASOLINE
ENGINES
DO SILNIKÓW
BENZYNOWYCH

BMC
& COLOR
SLEEVE



YATO	
YT-06016	10

- GB** Timing locking set
D Arretierwerkzeugsatz für Nockenwellen
PL Zestaw blokad rozrządu
RUS Набор блокировок к колесам распределительных механизмов
CZ Blokovací sada pro opravy rozvodů
H Vezérműrgőztető szerszámkészlet
RO Set blocare distributie auto
F Outil de blocage d'arbre à cames
I Set di bloccaggio distribuzione auto
E Juego de bloques de distribución
CN 正时皮带固定器组套

OPEL: Agila, Corsa B, Astra G/H
Corsa, Combo C, Meriva, Tigra B
ENGINE CODES / SILNIKI O KODZIE:
1.0 12V, 1.0 16V, 1.2 16V, 1.4 16 V (chain / łańcuch)
X10XE, Z10XE, Z10XEP, X12XE, Z12XE, Z14XEP



5
PCS

FOR VALVETRAIN
DO UKŁADU
ROZRZĄDU

FOR GASOLINE
ENGINES
DO SILNIKÓW
BENZYNOWYCH

BMC
& COLOR
SLEEVE



YATO	
YT-06002	10

- GB** Timing locking set
D Arretierwerkzeugsatz für Nockenwellen
PL Zestaw blokad rozrządu
RUS Набор блокировок к колесам распределительных механизмов
CZ Blokovací sada pro opravy rozvodů
H Vezérműrgőztető szerszámkészlet
RO Set blocare distributie auto
F Outil de blocage d'arbre à cames
I Set di bloccaggio distribuzione auto
E Juego de bloques de distribución
CN 正时皮带固定器组套

BMW: 520i E60 (04-08), Z4 2.0 E85 (04-08), X3 2.0i E83 (05-08), 118i E87 (04-07), 120i E87 (04-07), 316i E46 (01-05), 316 ti COMPACT E46 (04-05), 318i E46 (01-07), 318i COMPACT E46 (01-05), 318i E90 (05-08), 320i E90 (05-08), 116i E81/E87 (03-08), 316i E46/E90 (01-08), 316Ci E46 (01-05), 128i E82 (07-08), 130i E81/E87 (05-08), 135i E82 (07-08), 323i E90/91/92/93 (04-08), 325i/xi E90/91/92/93 (04-08), 328i/xi E90/91/92/93 (04-08), 330i/xi E90/91/92/93 (04-08), 335i/xi E90/91/92/93 (05-08), 523i/Li E60/61 (04-08), 525 i/Li/xi E60/61 (04-08), 528i/xi E60/E61 (06-08), 530i/xi E60/E61 (05-08), 535i/xi E60/E61 (06-08), X5 3.0 E70 (06-08), Z4 2.5/3.0 E85/86 (05-08), 630 E63/E64 (04-08), 730i/Li E65/66 (04-08), X3 2.5/3.0 E83 (06-08)

BMW MINI: R55/R56 COOPER S (06-09), R56 MINI ONE (07-09); PEUGEOT: 207/207 CC/ 308 (07-09); CITROEN: C4/C4 PICASSO (08-09)
ENGINE CODES / SILNIKI O KODZIE:N22/B12: N24-B18A, B20A, B20B; N40/N45/N45T/B16, N51/N52/N52K/N53/N54/N53/N54 (DIRECT INJECTIONS), N12/N14: EP3 (8FS), EP6 (6FW), EP6DT (5FX), EP6DTS (5FY); **OEM:**OEM119280, OEM115140, OEM113340, OEM119330



5
PCS

FOR VALVETRAIN
DO UKŁADU
ROZRZĄDU

FOR BMW DIESEL ENGINES
DO SILNIKÓW
DIELSA BMW

BMC
& COLOR
SLEEVE



YATO	
YT-06004	5

- GB** Timing locking set
D Arretierwerkzeugsatz für Nockenwellen
PL Zestaw blokad rozrządu
RUS Набор блокировок к колесам распределительных механизмов
CZ Blokovací sada pro opravy rozvodů
H Vezérműrgőztető szerszámkészlet
RO Set blocare distributie auto
F Outil de blocage d'arbre à cames
I Set di bloccaggio distribuzione auto
E Juego de bloques de distribución
CN 正时皮带固定器组套

OPEL: Astra, Vectra, Signum, Zafira, 1.9 CDTi (04 - 06);
FIAT: 1.9, 2.4 JTD; 16v, 20v;
ALFA ROMEO: 147, 156, GT 1.9 JTD 16v, 2.4 JTD 20v
ENGINE CODES / SILNIKI O KODZIE:
OPEL: Z19DTH, Z19DT;
ALFA ROMEO : 192 A5.000, 192 B1.000, 937 A4.000, 937 A5.000



6
PCS

FOR VALVETRAIN
DO UKŁADU
ROZRZĄDU

FOR DIESEL ENGINES
DO SILNIKÓW
DIELSA

BMC
& COLOR
SLEEVE



YATO	
YT-06013	10

- GB Timing locking set
D Arretierwerkzeugsatz für Nockenwellen
PL Zestaw blokad rozrządu
RUS Набор блокировок к колесам распределительных механизмов
CZ Blokovací sada pro opravy rozvodů
H Vezérműrgőztető szerszámkészlet
RO Set blocare distributie auto
F Outil de blocage d'arbre à cames
I Set di bloccaggio distribuzione auto
E Juego de bloques de distribución
CN 正时皮带固定器组套

APPLICATION / ZASTOSOWANIE:

BMW: Serie 1 (E81; E82; E87; E88; F20)
Serie 3 (E90; E91; E92; E93; F30)
Serie 5 (E60; E61; F10; F11)
X1 (E84) X3 (E83, F25)
2.0 N47, N47S (2007-2010)



6
PCS

1/2"
12.5mm

FOR VALVETRAIN
DO UKŁADU
ROZRZĄDU

FOR BMW
DIESEL ENGINE
DO SILNIKÓW
DIELA BMW

BMC
& COLOR
SLEEVE



YATO	
YT-06018	10

- GB Timing locking set
D Arretierwerkzeugsatz für Nockenwellen
PL Zestaw blokad rozrządu
RUS Набор блокировок к колесам распределительных механизмов
CZ Blokovací sada pro opravy rozvodů
H Vezérműrgőztető szerszámkészlet
RO Set blocare distributie auto
F Outil de blocage d'arbre à cames
I Set di bloccaggio distribuzione auto
E Juego de bloques de distribución
CN 正时皮带固定器组套

APPLICATION / ZASTOSOWANIE:

OPEL: Adam, Ampera, Astra-J, Corsa-D, Meriva-B, Mokka, Zafira-C Tourer; CHEVROLET Aveo

ENGINE CODES / SILNIKI O KODZIE:

1.0 A10 XEP, 1.2 A12 XEL, 1.2 A12 XER, 1.4 A14 XFL, 1.4 A14 XEL, 1.4 A14 XER, 1.4 A14 NEL, 1.4 A14 NET



7
PCS

FOR VALVETRAIN
DO UKŁADU
ROZRZĄDU

FOR GASOLINE
ENGINES
DO SILNIKÓW
BENZYNOWYCH

BMC
& COLOR
SLEEVE



YATO	
YT-06009	5

- GB Timing locking set
D Arretierwerkzeugsatz für Nockenwellen
PL Zestaw blokad rozrządu
RUS Набор блокировок к колесам распределительных механизмов
CZ Blokovací sada pro opravy rozvodů
H Vezérműrgőztető szerszámkészlet
RO Set blocare distributie auto
F Outil de blocage d'arbre à cames
I Set di bloccaggio distribuzione auto
E Juego de bloques de distribución
CN 正时皮带固定器组套

APPLICATION / ZASTOSOWANIE:

OPEL: ASTRA G,H, CORSA D, MERIVA (06-08), VECTRA (06-08), SIGNUM (06-08), ZAFIRA (03-08); CHEVROLET: CRUZE, ORLANDO 1.4, 1.6, 1.8; FIAT: CROMA; ALFA ROMEO: 159

ENGINE CODES / SILNIKI O KODZIE:

OPEL: 1.6-Z16LEL, Z16LER, Z16LET, Z16XE, Z16XER, 1.8-Z18XER
CHEVROLET; FIAT; ALFA ROMEO: 939A4.000



7
PCS

FOR VALVETRAIN
DO UKŁADU
ROZRZĄDU

FOR GASOLINE
ENGINES
DO SILNIKÓW
BENZYNOWYCH

BMC
& COLOR
SLEEVE



YATO	
YT-06005	10

- GB** Timing locking set
D Arretierwerkzeugsatz für Nockenwellen
PL Zestaw blokad rozrządu
RUS Набор блокировок к колесам распределительных механизмов
CZ Blokovací sada pro opravy rozvodů
H Vezérműrogzító szerszámkészlet
RO Set blocare distributie auto
F Outil de blocage d'arbre à cames
I Set di bloccaggio distribuzione auto
E Juego de bloques de distribución
CN 正时皮带固定器组套



8
PCS

AI

BMC
& COLOR
SLEEVE

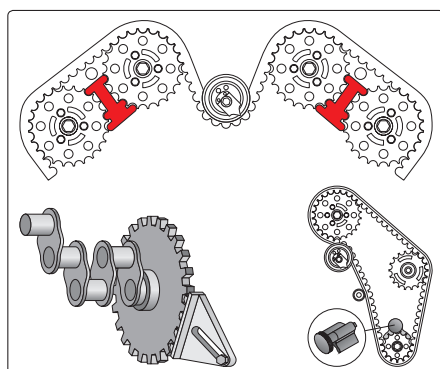

YATO	No.	No.	
YT-0633		Vauxhall/Opel: ASTRA G 1.7 TD, ASTRA G 2.0 16V, VECTRA 1.8/2.0 16V > 1995	
		Vauxhall/Opel: ASTRA G 1.4/1.6/1.8 16V > 1994, VECTRA 1.6/1.8 16V, ZAFIRA 1.6/1.8 16V	
		right hand camshaft Saab: 900-9000 Vauxhall/Opel: CALIBRA 2.5i/2.6 V6, CAVALIER 2.5i V6, OMEGA B 2.5i/2.6/3.0/3.2 V6, SINTRA 3.0 V6, VECTRA A 2.5i/2.6 V6	
		left hand camshaft Saab: 900-9000 Vauxhall/Opel: CALIBRA 2.5i/2.6 V6, CAVALIER 2.5i V6, OMEGA B 2.5i/2.6/3.0/3.2 V6, SINTRA 3.0 V6, VECTRA A 2.5i/2.6 V6	
		Rover: 25 1.4/1.6/1.8/VVC, 45 1.4/1.6/1.8, 75 1.8, 200 VI, 214 16V, 216 16V/CABRIO/COUPE, 218 COUPE, 414 16V, 416 16V, BRM 1.8VVC	
		Volkswagen: BORA 1.9TDI, GOLF 1.9TDI, LUPO 1.2/1.4/3.0 TDI, POLO 1.4TDI PASSAT 1.9TDI	16
		Citroen: BERLINGO 1.9D, DISPATCH 1.9D/TD-FSO 1.9D, RELAY 1.9D/TD, SYNERGIE 1.9/2.0T, SANTIA 1.9/2.0 D/TD/HDI, XSARA 1.9/2.0 D/HDI, ZX 1.9D/TD, most diesels Fiat: DUCATO 2.0D, ULYSSE 1.8/2.0 TURBO Ford: most diesels Peugeot: 205 1.6/1.8/1.9D, 305 1.6/1.8/1.9D, 306 1.8/1.9D/TD, 309 1.6/1.9D-4.5 1.6/1.9D, 406 1.9D, 605 2.0D/TD, 806 1.9TD, BOXER 1.9/2.0 D/TD, EXPERT 1.9D, PARTNER 1.9D Talbot: EXPRESS D, HORIZON D-J5 D, SOLARA D	
		Isuzu: 1.5/1.7 diesel engines Vauxhall/Opel: 1.6/1.7 diesel engines, 1.2/1.4/1.6/1.8/2.0 OHC petrol engines	

- GB** Timing locking set
D Arretierwerkzeugsatz für Nockenwellen
PL Zestaw blokad rozrządu
RUS Набор блокировок к колесам распределительных механизмов
CZ Blokovací sada pro opravy rozvodů
H Vezérműrogzító szerszámkészlet
- RO** Set blocare distributie auto
F Outil de blocage d'arbre à cames
I Set di bloccaggio distribuzione auto
E Juego de bloques de distribución
CN 正时皮带固定器组套

CITROËN: EP3C (8F01), EP6C (5F01), EP3 (8FS), EP6 (5FW), EP6DT (5FX), EP6CDT (5F04);
PEUGEOT: EP3 (8FS), EP6 (5FW), EP6C (5F01), EP6DT (5FX), EP5DTS (5FY), EP3C (8F01), EP6DTX (5FU), EP6DTS (5FY), EP6CDT (5F04), EP6 (5FX), EP6CDTX (5FU);
MINI BMW: N12 1.4 VALVETRONIC (1.4 VTI/1.5 VTI) N14 1.6 DIREKTEINSPRITZER (1.6 THP);
BMW ENGINES / SILNIKI: 1.4 VTI/1.5 VTI, N14 (1.6 THP)

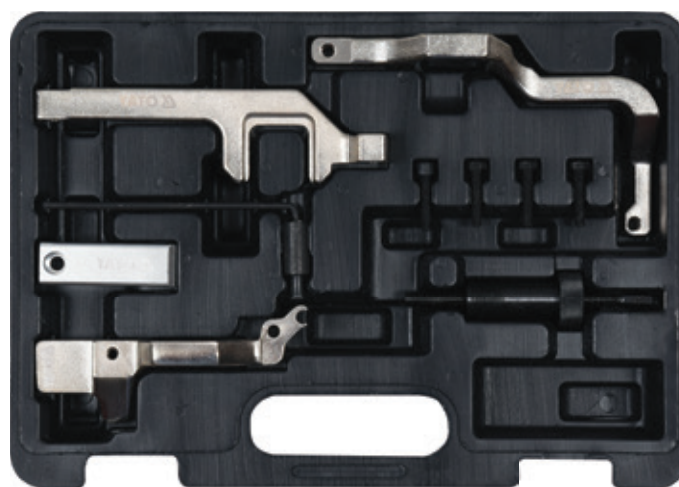

10
PCS

FOR VALVETRAIN
DO UKŁADU ROZRZĄDU

FOR BMW DIESEL ENGINE
DO SILNIKÓW DIESELA BMW

BMC
& COLOR
SLEEVE



YATO	
YT-06001	5

- GB** Timing locking set
D Arretierwerkzeugsatz für Nockenwellen
PL Zestaw blokad rozrządu
RUS Набор блокировок к колесам распределительных механизмов
CZ Blokovací sada pro opravy rozvodů
H Vezérműrogzító szerszámkészlet
- RO** Set blocare distributie auto
F Outil de blocage d'arbre à cames
I Set di bloccaggio distribuzione auto
E Juego de bloques de distribución
CN 正时皮带固定器组套

FORD: 1.3 TDCi
FIAT: Punto: 1.3 JTD Multi-Jet (2003-2007), Panda, Idea, Doblo: 1.3 JTD Multi (2003-2009)
SUZUKI: Ignis, WAgon, Swift: 1.3 CDTI (2003-2010)
OPEL: Corsa C, Combo C, Astra H, Tigra B, Meriva (2003-2009);
ENGINE CODES / SILNIKI O KODZIE:
188A9.000, 169A1.000, 188A8.000, 188A9.000, Z13DT, Z13DTJ



12
PCS

FOR VALVETRAIN
DO UKŁADU ROZRZĄDU

FOR DIESEL ENGINES
DO SILNIKÓW DIESELA

BMC
& COLOR
SLEEVE



YATO	
YT-06003	5

- GB** Timing locking set
D Arretierwerkzeugsatz für Nockenwellen
PL Zestaw blokad rozrządu
RUS Набор блокировок к колесам распределительных механизмов
CZ Blokovací sada pro opravy rozvodů
H Vezérműrogzító szerszámkészlet
RO Set blocare distributie auto
F Outil de blocage d'arbre à cames
I Set di bloccaggio distribuzione auto
E Juego de bloqueos de distribución
CN 正时皮带固定器组套

RENAULT: Avantime (2005-2007), Clio (2001-2008), Espace (2000-2008), Kangoo (2000-2008), Laguna (1999-2001), Laguna II (2004-2007), Master (2000-2006), Megane (1999-2008), Modus (2004-2008), Scenic (1999-2008), Traffic (2001-2008), Twingo (2007-2008);
NISSAN: Almera N16 (2002-2006), Interstar (2002-2006), Kubistar (2003-2008), Micra K12 (2003-2008), Note (2006-2008), Primastar (2002-2007), Primera P12 (2003-2007), Qashqai (2008-2009);
OPEL: Movano (2000-2008), Vivaro (2001-2008),
ENGINE CODES / SILNIKI O KODZIE:
1.5 (K9K), 1.9 (F9Q), 2.2 (G9T), 2.5 (G9U)

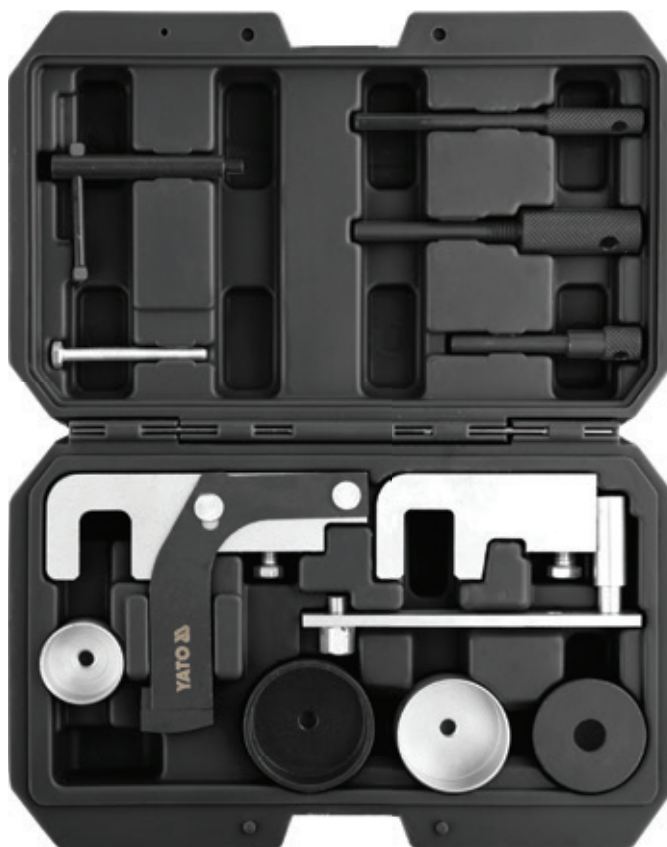

12
PCS

FOR VALVETRAIN
DO UKŁADU
ROZRZĄDU

FOR DIESEL
ENGINES
DO SILNIKÓW
DIELSA

BMC
& COLOR
SLEEVE



YATO
YT-06006

8

- GB** Timing locking set
D Arretierwerkzeugsatz für Nockenwellen
PL Zestaw blokad rozrządu
RUS Набор блокировок к колесам распределительных механизмов
CZ Blokovací sada pro opravy rozvodů
H Vezérműrogzító szerszámkészlet
RO Set blocare distributie auto
F Outil de blocage d'arbre à cames
I Set di bloccaggio distribuzione auto
E Juego de bloqueos de distribución
CN 正时皮带固定器组套

OPEL:
Agila, Combo-C, Corsa, Frontiera,
Omega, Sintra, Tigra, Vectra, Zafira
1.3 CDTI 16v, 1.9 CDTI, 2.0 DTI, 2.2 DTI,
1.0 DTI, 1.0 IZU, 1.2 16v (since / od 1996);
1.4 16v, 1.6 16v, 1.8 16v, 2.0 16v, 2.2 16v (since 1995)



29
PCS

FOR VALVETRAIN
DO UKŁADU
ROZRZĄDU

FOR PETROL
& DIESEL ENGINES
DO SILNIKÓW
DIELSA
I BENZYNOWYCH

BMC
& COLOR
SLEEVE



YATO
YT-06007

2

GB Timing locking set for V.A.G.
D Einstellwerkzeug Zahnriemen nockenwellen
Arretierwerkzeug steuerriemen für V.A.G.
PL Zestaw blokad rozrządu dla V.A.G.
RUS Набор блокировок газораспределения V.A.G.

CZ Sada aretacie rozvodov pro V.A.G.
H Vezérműrgítő készlet, V.A.G. - hoz
RO Set blocare distributie auto pt. V.A.G.
F Outil de blocage d'arbre à cames

I Set di bloccaggio distribuzione auto
E Juego de bloqueos de distribucion para V.A.G.
CN 大众&奥迪正时工具

34
PCS

FOR / DLA
V.A.G.

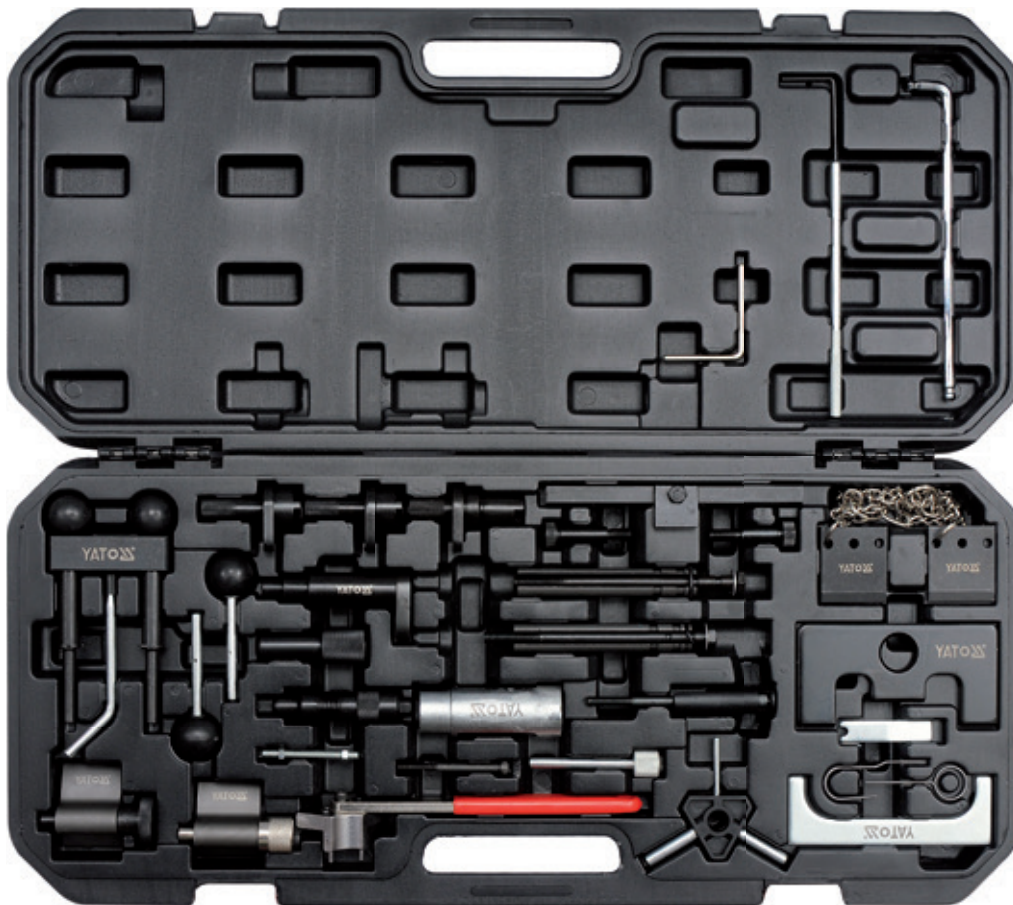

BMC
& COLOR
SLEEVE



YATO
YT-06015 4

GB Timing locking set for V.A.G.
D Einstellwerkzeug Zahnriemen nockenwellen
Arretierwerkzeug steuerriemen für V.A.G.
PL Zestaw blokad rozrządu dla V.A.G.
RUS Набор блокировок газораспределения V.A.G.
CZ Sada aretacie rozvodov pro V.A.G.
H Vezérműrgítő készlet, V.A.G. - hoz
RO Set blocare distributie auto pt. V.A.G.
F Outil de blocage d'arbre à cames
I Set di bloccaggio distribuzione auto
E Juego de bloqueos de distribucion para V.A.G.
CN 大众&奥迪正时工具

AUDI: A3 (03-10); SEAT: Altea, Ibiza, Leon; **SKODA:** Fabia II (07-09), Octavia (04-09), Roomster (06-09), Superb (09-10);
VW: Eos (06-09), Golf (03-09), Golf Plus (05-09), Jetta (06-09), Passat (05-09), Polo (02-08), Scirocco (09-10), Tiguan (07-09), Touran (03-09)

ENGINE CODES / SILNIKI:

1.4 FSI: (AXU, BKG, BLN)
1.4 TFSI: (BLG, BMY, BWK, CAVA, CAVB, CAVC, CAVD, CAVF, CAXA, CAXC, CDGA)
1.6 FSI: (BAG, BLF, BLP, BTS)



BMC
& COLOR
SLEEVE



YATO
YT-06017 10

GB Wire brush set
D Bürsten Sortiment
PL Zestaw szczotek do gniazd wtryskiwaczy
RUS Ерши с наружной резьбой в наборе
CZ Rourové kartáče válcové
H Henger drótkéfe
RO Perii cilindrice pt. curatarea gaurilor
F Brosse cylindrique
I Vetro di protezione
E Cepillos para limpieza interior
CN 件套清洁组



20
PCS

150
mm

1/4"
6.3mm

NYLON

SS
STAINLESS STEEL
STAL NIERDZEWNA

BRASS
MOSIADZ

NYLON CASE
& COLOR BOX



YATO
YT-08195 Ø (mm) 24

- GB Wire brush set
- D Bürsten Sortiment
- PL Zestaw szczotek do gniazd wtryskiwaczy
- RUS Ерши с наружной резьбой в наборе
- CZ Rourové kartáče válcové
- H Henger drótkefe
- RO Perii cilindrice pt. curatarea gaurilor
- F Brosse cylindrique
- I Vetro di protezione
- E Cepillos para limpieza interior
- CN 件套清洁组



38 PCS	150 mm	1/4" 6.3mm
NYLON	SS STAINLESS STEEL STAL NIERDZEWNA	BRASS MOSIADZ

BMC & COLOR SLEEVE



YATO	Ø (mm)	
YT-08196	8; 9; 10; 11; 12; 13; 14; 15; 16; 17; 18; 19	10

- GB Diesel injector puller
- D Stoßabziehvorrichtung für Einspritzdüse
- PL Ściągacz bezwładnościowy do wtryskiwaczy
- RUS Ударный съемник форсунок
- CZ Rázový vytahovač vstřikovačů
- H Diesel porlasztó kiszedő
- RO Dispozitiv de scos injectoare
- F Extracteur à choc d'injecteurs
- I Martello scorrevole per la rimozione degli iniettori
- E Tuerca tensora de impacto para inyectoros
- CN 柴油喷嘴拔取器

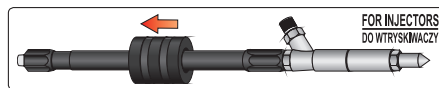

FOR INJECTORS DO WTRYSKIWACZY

BOSCH TYPE

LUCAS TYPE

M8
M12
M14

BMC & COLOR SLEEVE



YATO	
YT-0617	20

- GB Injector removal set
- D Set zum Abmotieren von Einspritzdüsen
- PL Zestaw do demontażu wtryskiwaczy
- RUS Комплект для снятия форсунок
- CZ Souprava pro demontáž vstřikovačů
- H Befecskendező kiserelő készlet
- RO Extractor injectoare
- F Ensemble pour démonter les injecteur
- I Kit per estrazione iniettori
- E Kit de desmontaje de inyectoros
- CN 雪铁龙-标致柴油嘴拆装工具



4
PCS

for/dla:
HDI

for/dla:
BOSCH
SIEMENS

BMC & COLOR SLEEVE



YATO	
YT-05338	4

- GB** Injector puller set CDI
D Diesel-Injektoren-Auszieher-Satz CDI
PL Ściągacz do wtrysków CDI
RUS Съёмник дизельных форсунок CDI
CZ Vytahovák vstříkovačů s úderovým kládívem CDIů
H Porlasztó kihúzó készlet csúszo kalapáccsal CDI motorhoz
RO Set extractor pt. injectoare cu ciocan inertial pt. motoare CDI
F Coffret extracteur d'injecteur diesel CDI
I Estrattore iniettori per Mercedes CDI
E Juego 8 piezas de extracción de inyectoros en CDI
CN 8件套柴油喷嘴拆卸工具

MERCEDES CDI: OM611, OM612, OM613

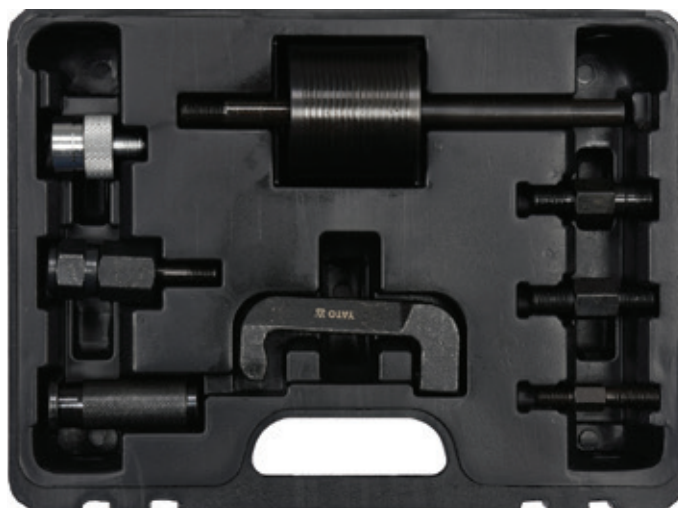
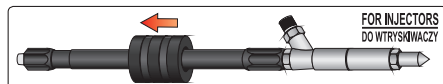

8
PCS

BMC
& COLOR
SLEEVE



YATO
YT-06176 5

- GB** Diesel injector master removal kit
D Injektor Auszieher Abzieher Werkzeug Einspritzdüsen
PL Zestaw ściągaczy bezwładnościowych do wtryskiwaczy
RUS Съёмник форсунок с ударным молотком для дизельных двигателей
CZ Souprava na demontáž vstříkovačů s reverzním kládívem
H Injektor kihúzó készlet, csúszo kalapáccsal
RO Set de extractoare inertiiale pt. injectoare
F Coffret extracteur d'injecteur
I Set di estrattori ad inerzia per iniettori
E Extractor de inyectoros de inyección
CN 24件套柴油喷嘴维修工具

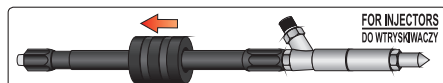

22
PCS

1/2"
12.5mm

BOSCH
DELPHI
DENSO
SIEMENS

PUMP DISE
INJECTORS
POMPY
WTRYSKIWCZY

2
HAMMERS
2
MŁOTY

BMC



YATO
YT-06175 1

- GB** Glow plug reamer set
D Reinigungsset für Glühkerzen
PL Zestaw do czyszczenia gniazd świec żarowych
RUS Набор для чистки свечей накаливания
CZ Sada k čištění otvorů zážehových svíci
H Gyújtógyertya aljzat tisztítókészlet
RO Set de curatat și rectificat filete pt. bujii incandescente
F Kit de nettoyage des puits de bougie de préchauffage
I Kit per pulizia delle bussole delle candele
E Set de limpieza de asientos de bujías incandescentes
CN 3件套热火塞铰刀组



3
PCS

CrV

BMC
& COLOR
SLEEVE



M10x1.0;
M12x1.25;
M12x1.25

YATO
YT-05341 10/20

- GB** Universal extractor broken glow plugs
D Glühkerze Entfernung Reparatur
PL Zestaw do demontażu urwaných świec żarowych
RUS Набор инструментов для демонтажа свечей накаливания
CZ Přípravek pro odvrtání a opravu závitu žhavicích svíček
H Izzító gyertya menetjavítás bállitása
RO Set extractor bujii reparare filete
F Kit extracteur bougie de préchauffage et réparation de filetage
I Kit per l'estrazione delle candele rotte
E Descripción de juego reparación de rosca
CN 热火塞螺纹修复工具组套



16
PCS

3/8"
10mm

CrV

HSS
4241

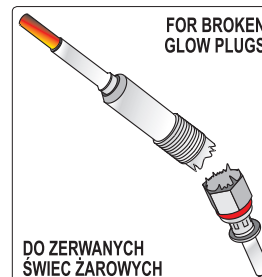

BMC
& COLOR
SLEEVE



YATO
YT-05342 5

- GB** Overhead valve spring compressor
D Vorrichtung zur Demontage von Motorventilen
PL Przyrząd do demontażu zaworów silnikowych
RUS Устройство для демонтажа клапанов двигателя
CZ Přípravek na demontáž ventilů motoru
H Szeleplehűző készülék
RO Dispozitiv pt. demontarea supapelor la motoare
F Outil pour démonter les soupapes de moteur
I Strumento per la rimozione di valvole motore
E Instrumento para desmontaje de válvulas de motor
CN 下压式凡尔钳



SLIDING CARD

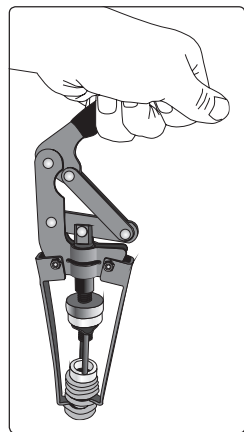

YATO
YT-0618 5/25

- GB** Overhead valve spring compressor
D Vorrichtung zur Demontage von Motorventilen
PL Przyrząd do demontażu zaworów silnikowych
RUS Устройство для демонтажа клапанов двигателя
CZ Přípravek na demontáž ventilů motoru
H Szeleplehűző készülék
RO Dispozitiv pt. demontarea supapelor la motoare
F Outil pour démonter les soupapes de moteur
I Strumento per la rimozione di valvole motore
E Instrumento para desmontaje de válvulas de motor
CN 气门弹簧压缩器

320 mm

OHV

FOR ENGINE VALVE DO ZAWORÓW SILNIKOWYCH



SLIDING CARD



YATO
YT-0618 10/20

- GB** Lambda sensor thread chaser
D Lambdasonde gewinde reparatur-set
PL Zestaw do naprawy gwintów sondy lambda
RUS Набор для ремонта сорванной резьбы винтов
CZ Sada na opravu závitu lambda sondy
H Menetjavító készlet lambda szondához
RO Dispozitiv pt. curatare filete sonda lambda
F Set de réparation filetage de sonde lambda
I Chiavi a bussola per sonda lambda
E Cazador del hilo de rosca para sonda lambda
CN 火星塞丝攻组套

FOR OXYGEN SENSOR DO SONDY LAMBDA

HRC 50

M12 x 1.25

M18 x 1.5



SLIDING CARD



YATO
YT-1756 12/96

- GB** Oxygen sensor crowfoot wrench
D Schlüssel für die Lambdasonde
PL Klucz do sondy lambda
RUS Ключ для зонда лямбда
CZ Klíč na sondu lambda
H Lambda szonda kulcs
- RO** Cheie pt. sonda lambda
F Clé pour sonde lambda
I Chiave per sonda lambda
E Llave para la sonda lambda
CN 氧传感器套筒扳手

SLIDING CARD

22 mm

FOR OXYGEN SENSOR DO SONDY LAMBDA



CrMo SCM440

YATO
YT-1753 15/60



CrV 50BV30

YATO
YT-1754 6/36

- GB** Socket and oxygen sensor set
D Steckschlüssel für die Lambda-Sonde
PL Klucze nasadowe do sondy lambda
RUS Торцевые ключи с внутренним многогранником для зонда лямбда
CZ Nástrčné klíče na sondy lambda
H Dugókulcs lambda szondához
RO Prize pt. sonda slambda
F Douille pour sonde lambda
I Set di riparazione per filetti di sonda lambda
E Llaves de cubo para la sonda lambda
CN 氧传感器套筒扳手组套

22 mm; L= 50 mm; 6PT; CrMo SCM440;

22 mm; L=30 mm; 6PT; CrMo SCM440;

22 mm; L=80 mm; 6PT; CrV 50BV30



3 PCS

22 mm

FOR OXYGEN SENSOR DO SONDY LAMBDA

CrMo SCM440

CrV 50BV30

BMC & COLOR SLEEVE



YATO
YT-1752 20

GB Oxygen sensor crowfoot wrench
D Schlüssel für die Lambdasonde
PL Klucz do sondy lambda extra dlugi
RUS Ключ для зонда лямбда

CZ Klíč na sondu lambda
H Lambda sonda kulcs
RO Cheie pt. sonda lambda
F Clé pour sonde lambda

I Chiave per sonde lambda
E Llave para la sonda lambda
CN 加长含氧感应套筒

PLASTIC HANGER



YATO	Ø	L (mm)	Box
YT-17513	1/2" (12.7 mm)	150	10/60

GB Oxygen flexi head wrench
D Gelenkschlüssel für Lambdasonde
PL Klucz łamany do sondy lambda
RUS Ключ для датчика лямбда зонд на шарнире
CZ Lámaný klíč do lambda sondy
H Lambda sonda kulcs

RO Cheie articulată pt. conducte oxigen
F Clé articulée pour sonde lambda
E Llave articulada para la sonda lambda
CN 氧传感扳手

PLASTIC HANGER

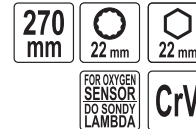

YATO	L (mm)	Box
YT-17515	270	6/36

GB Oxygen sensor and fuel injectors wrench set
D Steckschlüsselsatz für die Lambdasonde und die Einspritzdüsen
PL Zestaw nasadek do sondy lambda i wtryskiwaczy
RUS Набор насадок к лямбда-зондам и форсункам
CZ Sada nástavců na demontáž sondy lambda a vstříkovačů
H Dugókészlet lambda szondákhoz és injektorokhoz
RO Set inelare pt. sonda lambda și injectoare
F Douilles pour sonde lambda et injecteurs
I Set di riparazione per filetti di sonde lambda
E Juego de boquillas para la sonda lambda y para inyectoros
CN 氧传感器套筒扳手组套

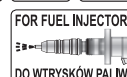

- ⊗ ⊕ ⊙ 1/2" (12.7 mm) x 29 mm; L=90 mm; 6PT;
- ⊗ ⊕ ⊙ 3/8" (9.5 mm) x 22 mm; L=90 mm; 6PT;
- ⊗ ⊕ ⊙ 1/2" (12.7 mm) x 27 mm; L=78 mm; 12PT;
- ⊗ ⊕ ⊙ 3/8" (9.5 mm) x 27 mm; L=74 mm; 6PT;
- ⊗ ⊕ ⊙ 3/8" (9.5 mm) x 22 mm; L=80 mm; 6PT;
- ⊗ ⊕ ⊙ 1/2" (12.7 mm) x 22 mm; L=50 mm; 6PT;
- ⊗ ⊕ ⊙ 3/8" (9.5 mm) x 22 mm; L=30 mm; 6PT

BMC & COLOR SLEEVE

YATO	Ø	Box
YT-1751	1/2" (12.7 mm) 3/8" (9.5 mm)	5

GB Diesel injection socket set
D Aufsätze für die Einspritzungen bei Dieselmotoren
PL Zestaw nasadek do wtrysków w silnikach Diesla
RUS Набор насадок к форсункам в дизельных двигателях
CZ Sada nástavců na trysky diesellových motorů
H Szerszámkészlet Dieselmotor befecskendezőkhöz
RO Set de capete pt. injectoare în motoare Diesel
F Set des douilles pour injecteurs (diesel)
I Set di custodie per i motori diesel
E Juego de tapones para las inyecciones en los motores de Diesel
CN 柴油机油注套筒组套

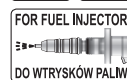

BMC & COLOR SLEEVE

YATO	size / rozmiar	Box
YT-0622	1/2" (12.7 mm)	10

- GB** Diesel injector and cutter set
- D** Fräsersatz für die Buchsen der Einspritzdüsen
- PL** Zestaw frezów do gniazd wtryskiwaczy common rail
- RUS** Комплект фрез для гнезд соплел форсунок
- CZ** Sada fréz na sedla tryskek vstříkovačů
- H** Marókészlet befecskendező fűvókájának fészkéhez
- RO** Set de freze pt. socluri de duze injectoare
- F** Alimentation d'un injecteur de common rail
- I** Set frese per sedi iniettori common rail
- E** Juego de fresas para el asiento de toberas de inyectores
- CN** 7件套气门铰刀

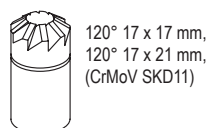
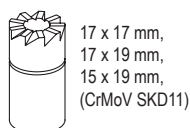
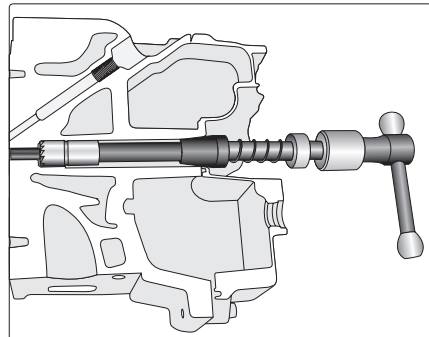

BMC & COLOR SLEEVE



YATO	
YT-17625	10

7
PCS

CrMoV
SKD11

- GB** Tooth socket for injection nozzle
- D** Stifschlüsselsatz für die Einspritzdüse in Lastkraftwagen
- PL** Zestaw kluczy czopowych do wtryskiwaczy w samochodach ciężarowych
- RUS** Набор шиповых ключей к форсунам грузовых автомобилей
- CZ** Sada klíčů na vstříkovače pro nákladní automobily
- H** Csaposkulcs készlet tehergépkocsi befecskendezőjéhez
- RO** Set chei tubulare cu unger pt. camioane
- F** Set de douilles injecteurs
- I** Set di chiavi per iniettori camion
- E** Juego de llaves de muñon para los inyectores en camiones
- CN** 卡车喷油嘴套筒组套

- 1/2" (12.7 mm); L=72 mm; 4T; CrV;
- 32 mm; M14 x 1.5 mm; L=70 mm; 4T; S45C;
- 1/2" (12.7 mm); L=120 mm; 3T; CrMo;
- 32 mm; L=120 mm; 4T; S45C



4
PCS

1/2"
12.5mm

HEX

CrMo S45C CrV

FOR FUEL INJECTORS
DO WTRYSKÓW PALIWA

BMC & COLOR SLEEVE



YATO	size / rozmiar	
YT-1762	1/2" (12.7 mm)	16

- GB** Socket key-attachments for Bosch VE-pumps
- D** Aufsatz-Set für Bosch VE Einspritzpumpen
- PL** Zestaw nasadek do pomp wtryskowych Bosch VE
- RUS** Набор насадок для инжекторных насосов Bosch VE
- CZ** Sada násad pro vstříkovači čerpadla Bosch VE
- H** Dugókulcs készlet Bosch VE befecskendező szivattyúhoz
- RO** Set tubulare speciale pt. pompe injectie Bosch
- F** Jeu de douilles Bosch VE pour pompes d'injection
- I** Kit di attacchi per pompe d'iniezione Bosch VE
- E** Set de accesorios para bombas de inyección Bosch VE
- CN** 博世泵套筒



3
PCS

1/2"
12.5mm

FOR VE PUMPS
DO POMP
TYPU VE

CrV

SLIDING CARD



YATO	size / rozmiar	
YT-17525	1/2" (12.7 mm)	12/48

- GB** Fuel injection test kit
- D** Diagnosesatz für die Prüfung der Kraftstoffeinspritzung
- PL** Zestaw diagnostyczny do wtrysku paliwa
- RUS** Пневматический набор к тормозным зажимам
- CZ** Souprava k diagnostice vstříkování paliva
- H** Diagnosztikai készlet üzemanyag - befecskendezőkhöz
- RO** Ansamblu pt. diagnosticarea injectiei combustibilului
- F** Kit de test de débit d'injecteur
- I** Set diagnostico per iniettori la benzina
- E** Juego de herramientas diagnosticas para la inyección de combustible
- CN** 燃料注射测试组套

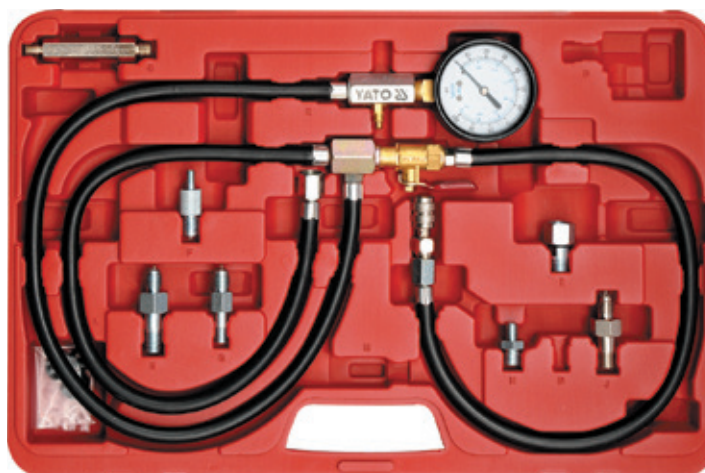

10
PCS

P_{max.}
0.7 MPa

BMC & COLOR SLEEVE



YATO	
YT-0670	10

- GB** Compression pressure gauge in a diesel engine
D Kompressionsdruckmesser in Dieselmotoren
PL Miernik ciśnienia sprężania w silnikach diesla
RUS Измеритель давления компрессии в дизельных двигателях
CZ Souprava k měření kompresních tlaků v dieselových motorech
H Dieselmotorok kompresszióját mérő óra
RO Manometrul presiunii aerului comprimat pt. motoarele diesel
F Testeur de pression cylindrique diesel
I Tester prova compressione motori diesel
E Medidor de presión de la compresión en los motores diesel
CN 柴油机压力测试组套



16
PCS

70 bar
max.

FOR DIESEL ENGINES
DO SILNIKÓW DIELSA

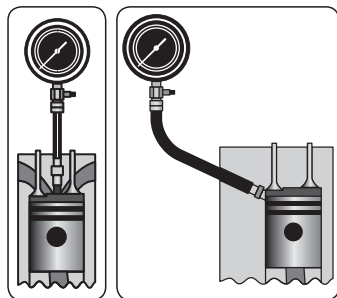

- 70 bar, 500 mm;
 160 mm;
 M20x1.5: 75 mm; M22x1.5: 73 mm; M24x1.5: 88 mm; M24x2: 63 mm;
 M10x1: 83, 91, 102, 113, 119 mm; M10x1.25: 64, 135 mm; M12x1.25: 47 mm; M22x1.5: 118 mm;

BMC
& COLOR
SLEEVE



YATO
YT-7307 5

- GB** Compression pressure gauge in a diesel engine
D Kompressionsdruckmesser in Dieselmotoren
PL Miernik ciśnienia sprężania w silnikach diesla
RUS Измеритель давления компрессии в дизельных двигателях
CZ Souprava k měření kompresních tlaků v dieselových motorech
H Dieselmotorok kompresszióját mérő óra
RO Manometrul presiunii aerului comprimat pt. motoarele diesel
F Testeur de pression cylindrique diesel
I Tester prova compressione motori diesel
E Medidor de presión de la compresión en los motores diesel
CN 柴油机压力测试组套



19
PCS

7
MPa

FOR DIESEL ENGINES
DO SILNIKÓW DIELSA

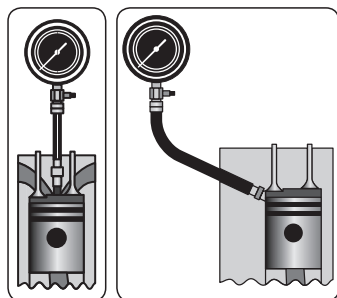

BMC
& COLOR
SLEEVE



YATO
YT-73072 6

- GB** Compression tester kit
D Kompressionsmessgerät Benzin
PL Miernik ciśnienia sprężania benzyna
RUS Манометр давления газа бензин
CZ Měřič komprese benzín
H Benzin kompresszió mérő
RO Tester compresie pt. motoare benzina
F Testeur de compression de moteur à essence
I Set diagnostico per iniettori la benzina
E Medidor de presión de compresión gasolina
CN 汽油压力表

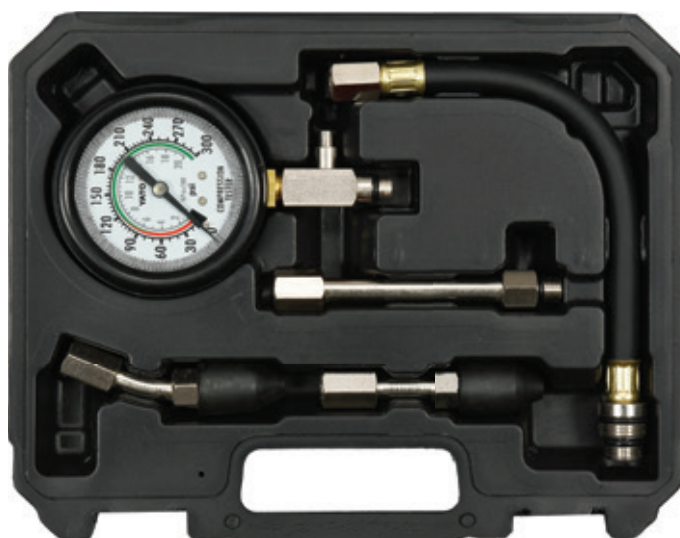

5
PCS

2.1
MPa

M14
M18

FOR SPARK IGNITION
DO ZAPALNIKI SKROWEGO

RUBBER ADAPTOR
ZŁĄCZE GUMOWE

BMC
& COLOR
SLEEVE



YATO
YT-73011 10

FOR ALL TYPES
DO WSZYSTKICH
TYPOW



- GB Compression tester kit
D Kompressionsmessgerät Benzin
PL Miernik ciśnienia sprężania benzyna
RUS Манометр давления газа бензин
CZ Měřič komprese benzin
H Benzin kompresszió mérő
RO Tester compresie pt. motoare benzina
F Testeur de compression de moteur à essence
I Set diagnostico per iniettori la benzina
E Medidor de presión de compresión gasolina
CN 汽油压力表

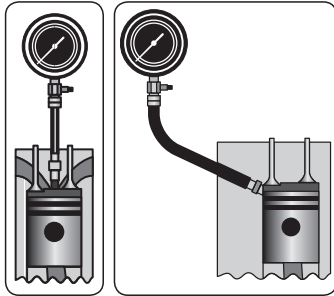

50
PCS

4
MPa

FOR DIESEL
ENGINES
DO SILNIKÓW
DZIEŃIA

FOR GASOLINE
ENGINES
DO SILNIKÓW
BENZYNOWYCH

BMC
& COLOR
SLEEVE



YATO
YT-73012

4

- GB Compression tester kit
D Kompressionsmessgerät Benzin
PL Miernik ciśnienia sprężania benzyna
RUS Манометр давления газа бензин
CZ Měřič komprese benzin
H Benzin kompresszió mérő
RO Tester compresie pt. motoare benzina
F Testeur de compression de moteur à essence
I Set diagnostico per iniettori la benzina
E Medidor de presión de compresión gasolina
CN 汽油压力表



8
PCS

FOR GASOLINE
ENGINES
DO SILNIKÓW
BENZYNOWYCH

0-2
MPa

BMC
& COLOR
SLEEVE



YATO
YT-73022

6

- GB Oil combustion spraying pressure meter
D Kraftstoff-Einspritzdruckmessgerät
PL Miernik ciśnienia wtrysku paliwa
RUS Измеритель давления впрыска топлива
CZ Měřič tlaku vstřikování paliva
H Üzemanyag befecskendező nyomásmérő
RO Kit masurare presiune injectoare
F Manomètre de pression d'injection du carburant
I Set diagnostico per iniettori la benzina
E Medidor de presión de inyección de combustible
CN 汽油压力表



9
PCS

0-0.7
MPa

BMC
& COLOR
SLEEVE



YATO
YT-73024

10

- GB** Vacuum & fuel pump tester
D Vakuummeter - Druck- und Unterdruckmessgerät
PL Wakuometr miernik pomiaru ciśnienia i podciśnienia
RUS Вакуумметр для измерения давления и вакуума
CZ Vakuometr měřič tlaku a podtlaku
H Nyomásmérő és vákuummérő
RO Pompa tester vacuum si compresie
F Vacuomètre de mesure de pression et dépression
I Tester misurazione pressione
E Vacuómetro medidor de presión y presión negativa
CN 真空压力表



9
PCS **0-0.1**
MPa



BMC
& COLOR
SLEEVE

YATO
YT-73050 10

- GB** Oil pressure tester
D Öldruckanzeige
PL Miernik ciśnienia oleju
RUS Тестер давления масла с адаптерами
CZ Tester tlaku oleje
H Olajnyomásmérő készlet
RO Tester presiune ulei
F Set de testeurs de pression d'huile
I Tester misurazione pressione dell'olio
E Manómetro de aceite
CN 自动波箱压力表

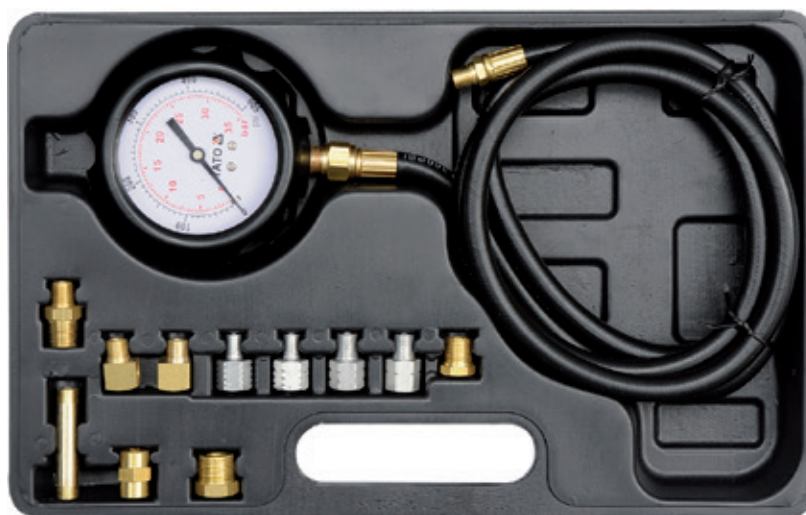

12
PCS **185 cm**
HOSE **WAZ**
FOR ALL TYPES
OF ENGINES
DO WSZYSTKICH
TYPOW SILNIKÓW
0-35 bar **0-500 PSI**



BMC
& COLOR
SLEEVE

YATO
YT-73030 10

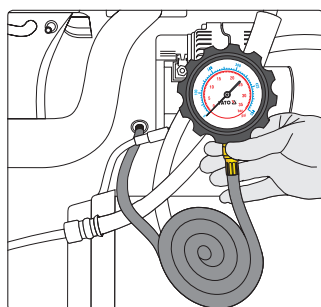

- GB** Cylinder leak detector
D Zylinder-Druckverlust-Tester
PL Zestaw do pomiaru szczelności cylindrów
RUS Набор для измерения герметичности цилиндра
CZ Sada pro měření těsnosti válců
H Kompresszióvnyomás-mérő készlet
RO Dispozitiv detectare pierdere presiune cilindri
F Ensemble de mesure d'étanchéité des vérins
E Kit para medir fugas de cilindros
CN 汽缸测漏表



4
PCS **7**
MPa
FOR GASOLINE
ENGINES
DO SILNIKÓW
BENZYNOWYCH
STANDARD



BMC
& COLOR
SLEEVE

YATO
YT-73055 5

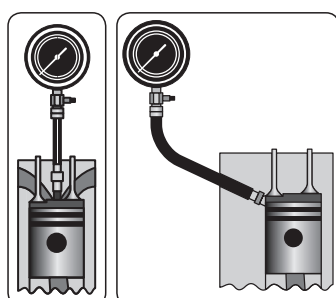

GB Compression tester
D Druckluftmessgerät
PL Miernik ciśnienia sprężania
RUS Тестер компрессии

CZ Měřicí přístroj kompresního tlaku
H Kompresszió mérő
RO Aparat de măsurarea presiunii
F Testeur de pression adaptateur cône

I Monometro pressione
E Medidor de compresión
CN 气缸压力表

FOR ALL TYPES
DO WSZYSTKICH TYPOW



21 bar max.

FOR SPARK IGNITION
DO ZAPALONU ISKROWEGO

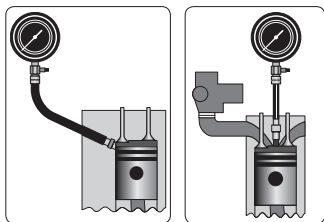

BMC & COLOR SLEEVE

RUBBER ADAPTOR
ZŁĄCZE GUMOWE



THREADED ADAPTOR
ZŁĄCZE GWINTOWANE



RUBBER ADAPTOR
ZŁĄCZE GUMOWE

THREADED ADAPTOR
ZŁĄCZE GWINTOWANE



YATO		YATO		YATO	
YT-7300	24/48	YT-7301	12/24	YT-7302	6/24

GB Flow meter common rail adapter set
D Überlauf-Diagnosesatz für die Einspritzdüse Common rail
PL Przelewowy zestaw diagnostyczny do wtryskiwaczy common rail
RUS Диагностический набор к форсункам common rail; переливной
CZ Souprava na diagnostiku vstříkovačů common rail, průtoková
H Diagnosztikai készlet common rail injektorokhoz, átfolyós
RO Set diagnostic preaplin pt. injectoare common rail
F Kit de test de débit d'injecteur common rail
I Set controllo portata iniettori common rail
E Juego diagnóstico de flujo para inyectoros common rail
CN 柴油燃油喷嘴检测工具

31 PCS

FOR 6 CYLINDERS
DO 6 CYLINDROW

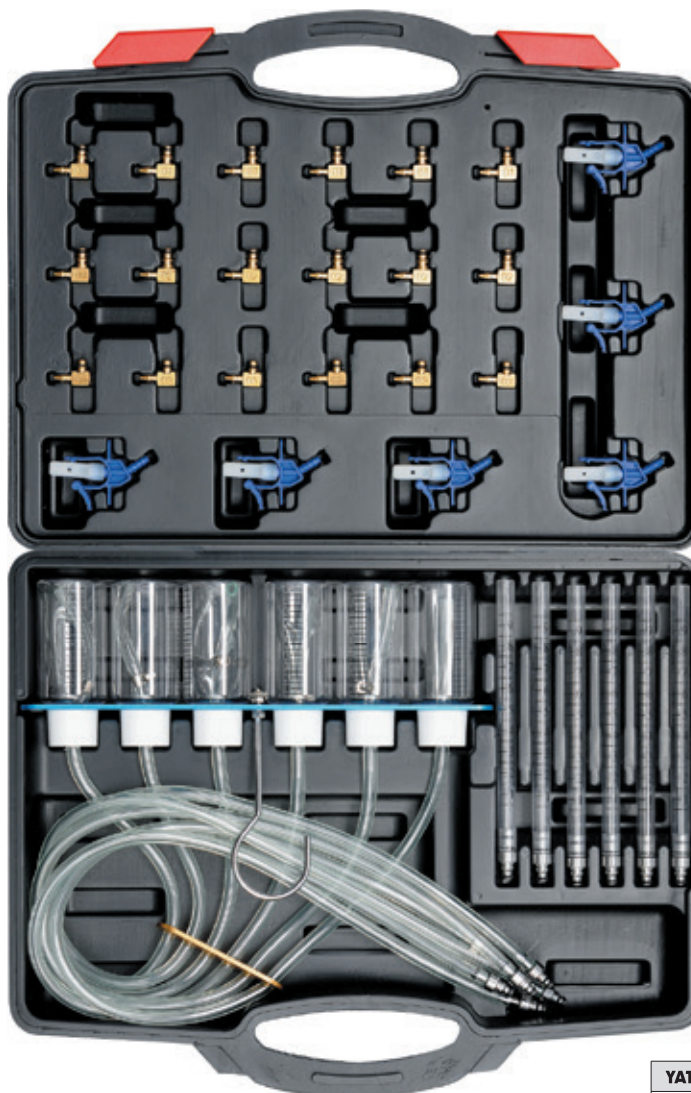

BMC & COLOR SLEEVE

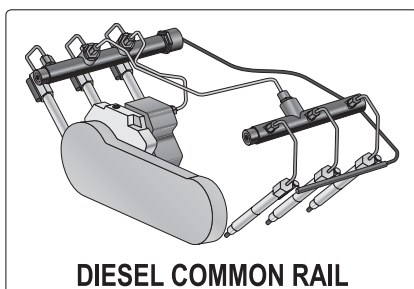

YATO	
YT-7306	5

GB Combined sockets for alternator
D Werkzeugsatz für Lichtmaschine
PL Zestaw do alternatorów ze sprzęgłem
RUS Набор для альтернатора
CZ Souprava na opravu alternátoru
H Generátor szerszámkészlet
RO Garnitură pt. alternator

F Set de clés à l'alternateur avec l'embrayage
I Set di chiavi per smontaggio puleggia e alternatore
E Enchufes combinados para alternador
CN 发动机拆卸组套

13
PCS

1/2"
12.5mm



CrV

HRC
40-44

S45C

HRC
38-42

STEEL
8660

HRC
53-57

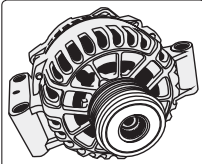

**FOR ALTERNATORS
DO ALTERNATORÓW**

- □ □ □ □ 1/2" (12.7 mm): M10, HBS, 33T, L=110 mm; CrV; HRC 40-44;
- □ □ □ □ 1/2" (12.7 mm): T50, HBS, 33T, L=110 mm; CrV; HRC 40-44;
- □ □ □ □ M8, M10, L=75 mm; 8660; HRC 53-57;
- □ □ □ □ T40, T50, L=75 mm; 8660; HRC 53-57;
- □ □ □ □ H8, H10, L=75 mm; 8660; HRC 53-57;

- □ □ □ □ H15, 33T, L=30 mm; CrV; HRC 40-44;
- □ □ □ □ H22, 33T, L=30 mm; CrV; HRC 40-44;
- □ □ □ □ H22, L=30 mm; S45C; HRC 38-42;
- □ □ □ □ Ø 35 x 30 mm; CrV; HRC 40-44;
- □ □ □ □ 1/2" (12.7 mm) x 10 mm; CrV; HRC 40-44



YATO	○	□
YT-0421	1/2" (12.7 mm)	15

GB Combined sockets for alternator
D Werkzeugsatz für Lichtmaschine
PL Zestaw do alternatorów ze sprzęgłem
RUS Набор для альтернатора
CZ Souprava na opravu alternátoru
H Generátor szerszámkészlet
RO Garnitură pt. alternator

F Set de clés à l'alternateur avec l'embrayage
I Set di chiavi per smontaggio puleggia e alternatore
E Enchufes combinados para alternador
CN 发动机拆卸组套

22
PCS

1/2"
12.5mm



3/8"
10mm

CrV

HRC
40-44

S45C

HRC
38-42

STEEL
8660

HRC
53-57

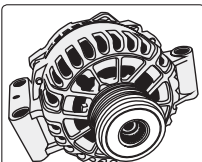
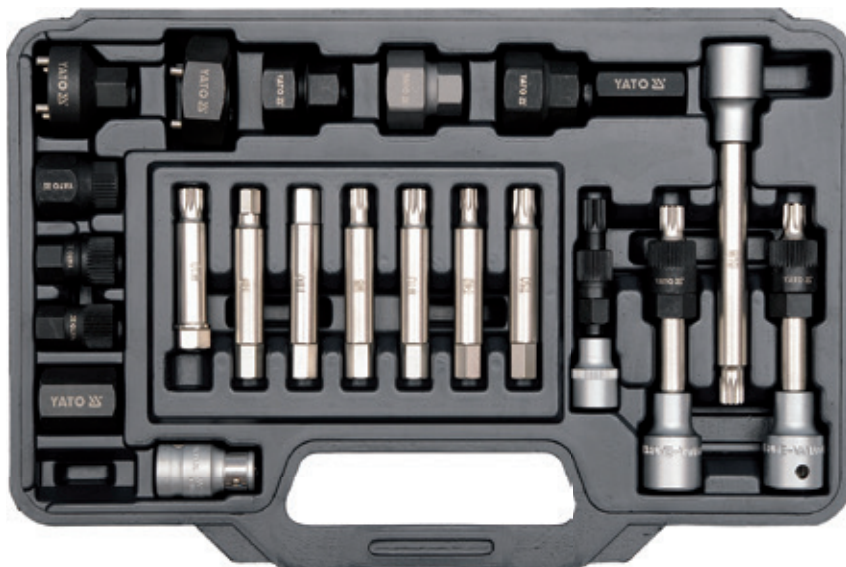

**FOR ALTERNATORS
DO ALTERNATORÓW**

- □ □ □ □ 1/2" (12.7 mm): M10, HBS, 33T, L=113 mm; CrV; HRC 40-44 / 8660; HRC 53-57;
- □ □ □ □ 1/2" (12.7 mm): T50, HBS, 33T, L=113 mm; CrV; HRC 40-44 / 8660; HRC 53-57;
- □ □ □ □ 3/8" (10 mm): M10, HBS, 33T, L=80 mm; CrV; HRC 40-44 / 8660; HRC 53-57;
- □ □ □ □ 1/2" (12.5 mm): M10, HBS, 33T, L=140 mm; CrV; HRC 40-44;
- □ □ □ □ M8, M10, L=75 mm; 8660; HRC 53-57;
- □ □ □ □ T40, T50, L=75 mm; 8660; HRC 53-57;

- □ □ □ □ H8, H10, L=75 mm; 8660; HRC 53-57;
- □ □ □ □ M8xH12, L=64 mm; 8660; HRC 53-57;
- □ □ □ □ H15, 33T, Ø 17 mm, L=30 mm, H15, 33T, Ø 19 mm, L=30 mm, H22, 33T, Ø 19 mm, L=30 mm; CrV; HRC 40-44;
- □ □ □ □ H17, H22, L=30 mm; S45C; HRC 38-42;
- □ □ □ □ Ø 35 x 30 mm; S45C; HRC 38-42;
- □ □ □ □ Ø 38 mm; S45C; HRC 38-42;
- □ □ □ □ H19x28, H21x28, H22x28; S45C; HRC 38-42;
- □ □ □ □ 1/2" (12.5 mm) (F) x H10 mm (F); CrV; HRC 40-44



YATO	○	○	□
YT-04211	1/2" (12.7 mm)	3/8" (9.5 mm)	5

- GB Stroboscopic tube
D Stroboskoplampe
PL Lampa stroboskopowa
RUS Стробоскопная лампа
CZ Stroboskopická lampka
H Stroboszkóp lámpa

- RO Lampă stroboscopică
F Lampe stroboscopique
I Lampada stroboscopica
E Tubo estroboscópico
CN 点火正时灯

DOUBLE
BLISTER



12 V

ENGINE SPEED
PREMIERES OBROTOWA
8000 min⁻¹
MAX.

XENON

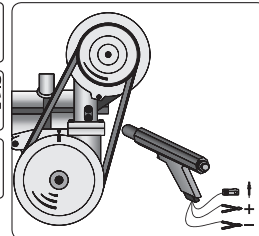

0-60°

YT-7310	6/12

YT-7311	6/12

YT-7312	6/12

- GB Universal radiator pressure kit
D Diagnosekit für Kühler
PL Zestaw diagnostyczny do chłodnicy
RUS Диагностический набор к радиатору
CZ Souprava k diagnostice chladiče

- H Diagnosztikai készlet hűtőkhöz
RO Ansamblu pt. diagnosticarea radiatorului
F Set diagnostique pour radiateur de voiture
I Set universale tester pressione del radiatore

- E Juego de herramientas diagnosticas para el radiador
CN 万用水箱压力测试组套

BMC
& COLOR
SLEEVE



14
PCS

P max.
0.25 MPa

200°C
max.

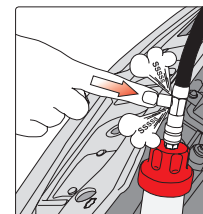
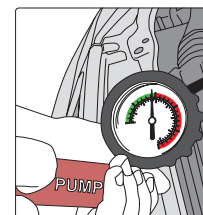
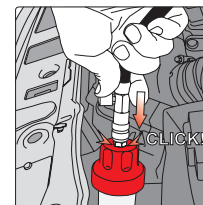

YATO	No.		
	2	General Motors	
	3	Mercedes, General Motors, Jeep	
	4	Peugeot, Subaru, Chrysler, Acura, General Motors, Mitsubishi, Nissan, Mazda, Toyota, Infiniti, GEO, Suzuki, Isuzu, Ford	
	5	Honda, Toyota, Suzuki, Mitsubishi, Chrysler, Acura	
	6	Audi, BMW, Volkswagen, Porsche	
	7	Volvo, Saab, Citroen, Renault, Fiat, Alfa Romeo, Jeep	
YT-0672	8	Volkswagen	4
	9	Mercedes, General Motors, Jeep	
	10	BMW	
	11	Audi, Volkswagen	
	12	Ford, Land Rover, Opel, Jaguar, Mercedes	
	13	Mercedes	

- GB** Hand-held vacuum pump
D Unterdruckpumpe mit Zubehör
PL Pompka podciśnieniowa z akcesoriami
RUS Насос вакуумметрического давления с принадлежностями
CZ Podtlaková-tlaková pumpa s příslušenstvím

- H** Vákuum- és ac-pumpa mérő, tartozékokkal
RO Pompa de vidare cu accesorii
F Pompe à vide avec les accessoires
I Pompa a pressione con accessori
E Bomba de subpresión con accesorios
CN 手持式真空泵

16
PCS
-1-0
bar



YATO	
YT-0673	10

- GB** Hand-held vacuum pump
D Unterdruck-druckpumpe mit Zubehör
PL Pompka ciśnieniowo-podciśnieniowa z akcesoriami
RUS Насос вакуумметрического давления с принадлежностями
CZ Podtlaková-tlaková pumpa s příslušenstvím

- H** Vákuum- és ac-pumpa mérő, tartozékokkal
RO Pompa de vidare cu accesorii
F Pompe à vide avec les accessoires
I Pompa a pressione con accessori
E Bomba de subpresión-presión con accesorios
CN 手持式真空泵

22
PCS
-1-3
bar



YATO	
YT-0674	5

- GB** Spark plug socket
D Steckschlüssel mit Gummihalterung
PL Nasadka do świec
RUS Головка свечная
CZ Nastavec pro svíčky

- H** Gyújtógyertya toldalék
RO Cheie de bujii
F Douille à bougies
I Chiavi a bussola
E Boquilla de bujías
CN 六角火花塞套筒

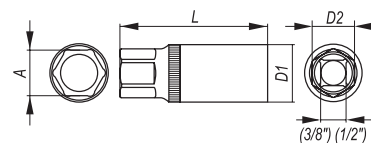

YATO	Ø	A	D1 (mm)	D2 (mm)	L (mm)	PCS packing:	
YT-3851	3/8" (9.5 mm)	16.0	22.0	19.0	64.0	10	50/100
YT-1253	1/2" (12.7 mm)	16.0	22.0	19.0	64.0	10	50/100
YT-1254	1/2" (12.7 mm)	21.0	27.8	24.0	64.0	10	50/100

- GB** Spark plug socket
D Steckschlüssel mit Gummihalterung
PL Nasadka do świec
RUS Головка свечная
CZ Nastavec pro svíčky
H Gyújtógyertya toldalék
RO Cheie de bujii
F Douille à bougies
I Chiavi a bussola
E Boquilla de bujías
CN 六角火花塞套筒

PLASTIC HANGER

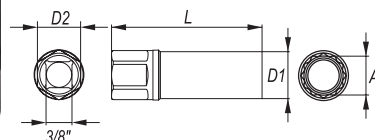
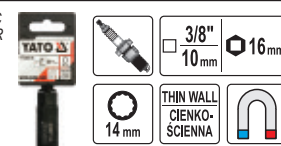

YATO	Ø	A	D1 (mm)	D2 (mm)	L (mm)	
YT-38510	3/8" (9.5 mm)	14	18	16	63	25/100

- GB** Spark plug socket
D Steckschlüssel mit Gummihalterung
PL Nasadka do świec
RUS Головка свечная
CZ Nastavec pro svíčky
H Gyújtógyertya toldalék
RO Cheie de bujii
F Douille à bougies
I Chiavi a bussola
E Boquilla de bujías
CN 六角火花塞套筒

PLASTIC HANGER

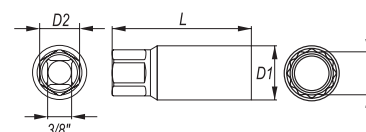
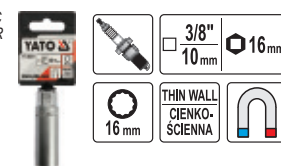

YATO	Ø	A	D1 (mm)	D2 (mm)	L (mm)	
YT-38511	3/8" (9.5 mm)	16	20	16	62	25/100

- GB** Spark plug socket
D Steckschlüssel mit Gummihalterung
PL Nasadka do świec
RUS Головка свечная
CZ Nastavec pro svíčky
H Gyújtógyertya toldalék
RO Cheie de bujii
F Douille à bougies
I Chiavi a bussola
E Boquilla de bujías
CN 六角火花塞套筒



PLASTIC HANGER

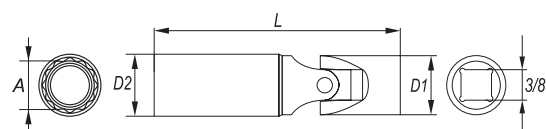

YATO	Ø	A	D1 (mm)	D2 (mm)	L (mm)	
YT-38512	3/8" (9.5 mm)	14	19	20	88	25/100

- GB** Spark plug socket
D Kerzenschlüssel mit Verlängerungshebel
PL Klucz do świece z przedłużką
RUS Ключ к свечам с удлинителем
CZ Klíč na svíčky s prodlužovacím nástavcem
H Gyertyakulcs hosszabbítóval

- RO** Cheie cu prelungitor, pt. bujii
F Douille à bougies
I Chiavi per candele a tubo
E Llave para las bujías con extensión
CN 火花塞套筒

PLASTIC HANGER



3/8" (10 mm)
x 300 mm

CrV
50BV30



YATO	Ø (mm)	
YT-0817	16	10/40
YT-0818	18	10/40

- GB** Extra long spark plug socket
D Zündkerzensteckschlüssel
PL Nasadka do świece extra długa
RUS Головка свечная
CZ Nástavec pro svíčky
H Gyűjtygyertya toldalék

- RO** Cheie de bujii
F Douille à bougies
I Chiavi a bussola
E Boquilla de bujías
CN 十二角加长火花塞磁钢款

PLASTIC HANGER



3/8" 10mm 250 mm



THIN WALL
CIENKOCIENNA

CrV



YATO	Ø	
YT-38521	14	12/48
YT-38522	16	12/48

- GB** Spark plug socket
D Kerzenschlüssel mit Verlängerungshebel
PL Klucz do świece z przedłużką
RUS Ключ к свечам с удлинителем
CZ Klíč na svíčky s prodlužovacím nástavcem
H Gyertyakulcs hosszabbítóval

- RO** Cheie cu prelungitor, pt. bujii
F Douille à bougies
I Chiavi per candele a tubo
E Llave para las bujías con extensión
CN 火花塞套筒

PLASTIC HANGER



3/8" 10mm 310 mm



THIN WALL
CIENKOCIENNA

CrV



YATO	Ø	
YT-08163	14	15/60
YT-08164	16	15/60

- GB** Joined glow plug socket set
D Schlüsselsatz für Glühkerzen
PL Zestaw kluczy do świece żarowych
RUS Набор ключей к калильным свечам
CZ Sada klíčů na žhavicí svíčky
H Gyertyakulcs készlet
RO Set chei pt. bujii incandescente
F Set de douilles à bougies
I Set chiavi a bussola
E Juego de llaves para bujías incandescentes
CN 预热火花塞套筒组套



6 PCS 3/8" 10mm BLOCKING SYSTEM BLOKOWY
8, 9, 10, 12, 14, 16 mm
CrV 50BV30



FOR GLOW PLUGS
DO ŚWIEC ŻAROWYCH

BMC & COLOR SLEEVE



YATO	Ø	
YT-0534	3/8" (9.5 mm)	10

- GB** Joined glow plug socket set
D Schlüsselsatz für Glühkerzen
PL Zestaw kluczy do świece żarowych
RUS Набор ключей к калильным свечам
CZ Sada klíčů na žhavicí svíčky
H Gyertyakulcs készlet
RO Set chei pt. bujii incandescente
F Set de douilles à bougies
I Set chiavi a bussola
E Juego de llaves para bujías incandescentes
CN 预热火花塞套筒组套



6 PCS 3/8" 10mm CrV
8, 9, 10, 12, 14, 16 mm



FOR GLOW PLUGS
DO ŚWIEC ŻAROWYCH



YATO	Ø	
YT-05339	3/8" (9.5 mm)	10

- GB** Universal clutch adjustment set
D Universal-set, um die Kupplungsscheibe einstellen
PL Zestaw do centrowania tarczy sprzęgłowej
RUS Комплект для центровки дисков сцепления
CZ Univerzální sada pro nastavení spojky disk
H Kuplung központositó készlet
RO Trusa pt. centrare ambreiaje
F Centreur d'embrayage
I Set di centraggio frizione
E Herramienta alineación embrague
CN 燭磁動請苐溟



BMC & COLOR SLEEVE

9
PCS

∅ mm
11-25

∅ 11, 15, 16.5, 17, 19, 20, 20.5, 25 mm

YATO
YT-06311 20

- GB** Universal clutch adjustment set
D Universal-set, um die Kupplungsscheibe einstellen
PL Zestaw do centrowania tarczy sprzęgłowej
RUS Комплект для центровки дисков сцепления
CZ Univerzální sada pro nastavení spojky disk
H Kuplung központositó készlet
RO Trusa pt. centrare ambreiaje
F Centreur d'embrayage
I Set di centraggio frizione
E Herramienta alineación embrague
CN 燭磁動請苐溟



BMC & COLOR SLEEVE

2
PCS

∅ mm
15-20

∅ mm
20-27



ADJUSTMENT / REGULACJA

YATO
YT-06312 25

- GB** Universal clutch adjustment set
D Universal-set, um die Kupplungsscheibe einstellen
PL Zestaw do centrowania tarczy sprzęgłowej
RUS Комплект для центровки дисков сцепления
CZ Univerzální sada pro nastavení spojky disk
H Kuplung központositó készlet
RO Trusa pt. centrare ambreiaje
F Centreur d'embrayage
I Set di centraggio frizione
E Herramienta alineación embrague
CN 燭磁動請苐溟



∅ mm
15-28

3
PISTONS SLIDES
TILKJE REGULACJE

FOR PASSENGER CARS
DO AUT OSOBOWYCH



SLIDING CARD

YATO
YT-06313 12/24

- GB** Flexible line clamp
D Schlauchklemmsatz
PL Komplet zacisków do przewodów z cieczą
RUS Набор зажимов с фиксатором
CZ Sada hadicových svěrek
H Flexibilis cső elszorító készlet
RO Clema flexibilă
F Set de pices pour serrer les
I Set pinze per chiudere momentaneamente i manicotti
E Juego de alicates apretadores para conductos de líquidos
CN 油管封口钳组套

SLIDING CARD



3
PCS

WILL NOT CUT HOSES
NIE NSZCZY PRZEWODÓW

NON-CONDUCTIVE
NIEPRZEWODZĄCE

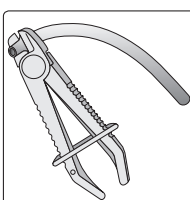

- GB** Flexible line clamp
D Schlauchklemmsatz
PL Komplet zacisków do przewodów z cieczą
RUS Набор зажимов с фиксатором
CZ Sada hadicových svěrek
H Flexibilis cső elszorító készlet
RO Clema flexibilă
F Set de pices pour serrer les
I Set pinze per chiudere momentaneamente i manicotti
E Juego de alicates apretadores para conductos de líquidos
CN 油管封口钳组套

SLIDING CARD



3
PCS

WILL NOT CUT HOSES
NIE NSZCZY PRZEWODÓW

BENT
WYGIĘTE

NON-CONDUCTIVE
NIEPRZEWODZĄCE

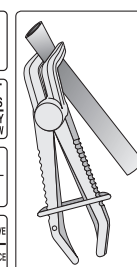

3/4" - 9/4"



1/2" - 5/4"



1/4" - 3/4"



1/4" - 3/4" for brake and fuel lines
6.3 - 19.0 mm do przewodów hamulcowych i paliwowych

1/2" - 5/4" for flexible hose
12.5 - 32.0 mm do przewodów elastycznych

3/4" - 9/4" for radiator hose clamp
19.0 - 57.0 mm do przewodu chłodnicy

YATO
YT-0840 25/50



max. 32 mm

max. 17 mm

max. 13 mm

max. 13 mm for brake and fuel lines
do przewodów hamulcowych i paliwowych

max. 17 mm for flexible hose
do przewodów elastycznych

max. 32 mm for radiator hose clamp
do przewodu chłodnicy

YATO
YT-08403 5/15

GB Metal conduit bender
D Biegevorrichtung für Metallleitungen
PL Giętarka do przewodów metalowych
RUS Гибочный станок для проводов из металла

CZ Ohýbačka kovových trubek
H Hajlító fémvezetékekhez
RO Mașina de îndoit (curbat) pt. cabluri metalice
F Cintreuse au câble de frein

I Piegatrice per fili metallici
E Dobladora de tubos de metal
CN 弯管器

SLIDING CARD



AI

125 mm

max. Ø 6 mm



235 mm

max. Ø 12 mm



YATO	L (mm)	
YT-0813	125	24/96

YATO	L (mm)	
YT-0814	235	6/48

GB Steel line clamp
D Klemmen für Leitungen aus Metall
PL Zaciski do przewodów metalowych
RUS Клеммы для металлических проводов

RO Set pt. blocare conducte de combustibil si conducte de frane
F Pince d'arrêt de conduites métalliques
I Morsetti per conduttori metallici
E Abrazaderas para conductos de metal
CN 4件套油管夹组套

4 PCS



NYLON

CZ Svorky pro kovové vodiče
H Csipesz fém vezetékhez

GB Steel line clamp
D Klemmen für Leitungen aus Metall
PL Zaciski do przewodów metalowych
RUS Клеммы для металлических проводов

RO Set pt. blocare conducte de combustibil si conducte de frane
F Pince d'arrêt de conduites métalliques
I Morsetti per conduttori metallici
E Abrazaderas para conductos de metal
CN 4件套油管夹组套

8 PCS



NYLON



SLIDING CARD



YATO	
YT-08390	10/20



BMC & COLOR SLEEVE



YATO	
YT-08391	10

GB Fuel line clamp and stopper kit
D Satz von Klemmen für flexible Leitungen und Leitungen aus Metall

PL Zestaw zacisków do przewodów metalowych i elastycznych

RUS Набор клемм для металлических и гибких проводов

CZ Sada svorek pro kovové a elastické vodiče

H Csipeszkészlet fém és rugalmas vezetékhez

RO Cleme pt. conducte combustibil si kit opritor

F Ensemble de pinces d'arrêt de conduites métalliques et en plastique

I Morsettiera per conduttori metallici elastici

E Juego de abrazaderas para conductos de metal y flexibles

CN 12件套燃油管夹组套



12 PCS



NYLON

BMC & COLOR SLEEVE



YATO	
YT-08392	5

GB Brake retainer spring tool
D Montagewerkzeug für Bremsfeder

PL Ściągacz sprężynek szczeł hamulcowych

RUS Съемник для тормозных пружин

CZ Stahovač pružin brzdových čelistí

H Fékrugó szerelő szerszám

RO Dispozitiv pt. montat arc pe sabot

F Extracteur de ressorts freins

I Freno scarpa di fissaggio a molla compressori

E Herramienta para resorte retenedor de frenos

CN 刹车弹簧华司拆装器

SLIDING CARD



FOR DRUM BRAKES DO HAMULCOW BERNOWYCH

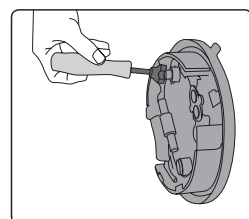

YATO	
YT-0685	12/96

YATO	
YT-0686	12/72

- GB** Brake spring pliers kit
D Bremsbacken-montage set
PL Zestaw do montażu szczęk hamulcowych
RUS Набор инструментов для тормозных пружин
CZ Sada na montáž brzdových čelistí
H Fogókészlet fékrugóhoz
RO Dispozitiv pt. înlocuit garniturii cilindrii receptorii
F Set pour le montage des mâchoires de freins
I Set per montaggio molle freni
E Juego para resortes de frenos
CN 刹车拆卸工具组套

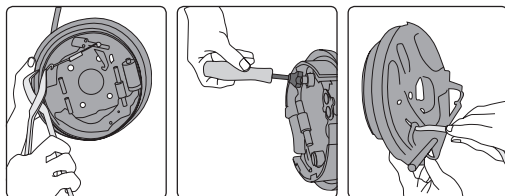

3
PCS

DOUBLE
BLISTER

8
PCS



FOR DRUM
BRAKES
DO HAMULCOW
BEBNOWICH

BMC
& COLOR
SLEEVE



YATO
YT-0684

6/24

YATO
YT-0680

5

- GB** Brake fluid tester
D Bremsflüssigkeitstester
PL Tester płynu hamulcowego
RUS Тестер тормозной жидкости
CZ Tester stavu brzdové kapaliny
H Fékolyadék tesztler
RO Tester lichid frana
F Tester de liquide de frein
I Tester del fluido frenante
E Líquido de frenos tester
CN 刹车油检测器

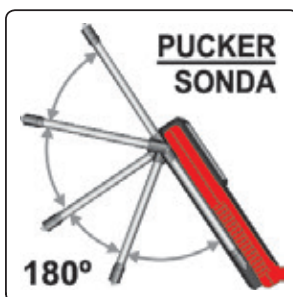
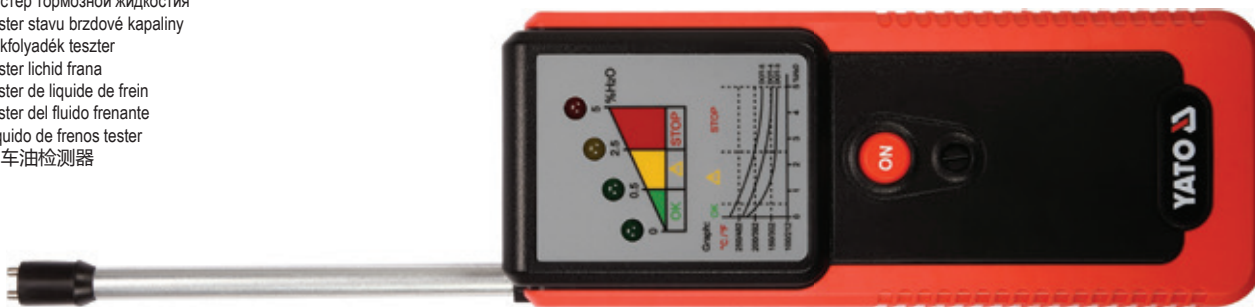

BLISTER
CARD



YATO
YT-72981

28/56

- GB** Brake bleeder wrench set
D Bremsen-Entlüfterschlüssel-Satz
PL Zestaw kluczy do odpowietrzania hamulców
RUS Набор ключей для прокачки тормозов
CZ Sada klíčů na odvzdušnění brzd
H Féklégtelenítő-kulcs készlet
RO Set chei pt. schimbat lichid de frana
F Set de clés pour purge de frein
I Set di chiavi per lo sfiato dei freni
E Juego de llaves para sangrar frenos
CN 7件套刹车制动阀扳手组套

7
PCS

∅ mm
7-12

FOR BRAKE
BLEEDING
DO ODPOWIEZANIE
HAMULCOW



BMC
& COLOR
SLEEVE



YATO
YT-06834

10

- GB** Universal brake tool set
- D** Bremsbacken Montageset
- PL** Zestaw do obsługi układów hamulcowych
- RUS** Набор для обслуживания тормозной системы
- CZ** Sada pro údržbu brzdového systému
- H** Fékrendszer karbantartó készlet
- RO** Set universal pt. frane
- F** Kit de maintenance et de montage
- I** Kit di manutenzione dell'impianto frenante
- E** Kit de mantenimiento del sistema de frenos
- CN** 15件套制动系统调整工具



15 PCS	1/2" 12.5mm	3/8" 10mm	CrV
------------------	-----------------------	---------------------	------------



BMC & COLOR SLEEVE

YATO	
YT-06802	4

- GB** Disc brake spreader
- D** Scheibenbremsen Abscheider
- PL** Separator do hamulców tarczowych
- RUS** Распорка тормозных дисков
- CZ** Přípravek na montáž brzdových prasátek
- H** Fékmunkahenger visszanyomó
- RO** Separator disc ambreiaj
- F** Séparateur des freins à disque
- I** Separatore per pistoncini freno
- E** Separador de frenos de discos
- CN** 刹车片分离器



40-68 mm	1, 2, 4	116x60 mm FOR BRAKE CALIPER PISTONS DO ZACISKŮVNI TĚLÍČKOVINY MINI SIZE ROZMIAR SZCZĘK
--------------------	----------------	--



COLOR BOX

YATO	
YT-06805	20

- GB** Interior bent nose snap ring pliers
- D** Bremssattel- Sprengringzange
- PL** Szczypce Segera do pierścieni zacisków hamulcowych
- RUS** Клещи зерера для тормозных суппортов
- CZ** Kleště na pojsné kroužky brzdových svorek, segerovky
- H** Seeger-gyűrű fogó
- RO** Cleste sigurante interior, indoit
- F** Pince seger pour bagues d'étrier de frein
- E** Alicates Seeger para anillos de las pinzas de freno
- CN** 挡圈钳



190 mm	55 mm	90°
------------------	-----------------	------------



SLIDING CARD

YATO	L (mm)	
YT-06561	190	5/20

- GB** Disc brake spreader
D Scheibenbremsen Abscheider
PL Separator do hamulców tarczowych
RUS Распорка тормозных дисков
CZ Přípravek na montáž brzdových prasátek
H Fékmunkahenger visszanyomó

- RO** Separator disc ambreiaj
F Séparateur des freins à disque
I Separatore per pistoncini freno
E Separador de frenos de discos
CN 刹车片分离器

0-65
mm

1/2" (12,5 mm)
21 mm

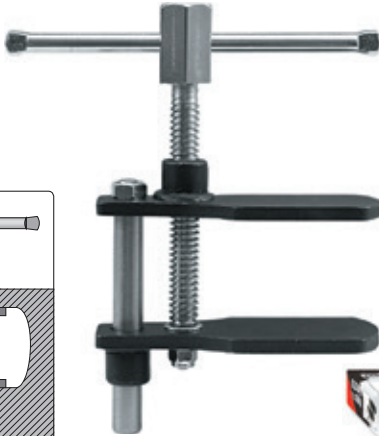
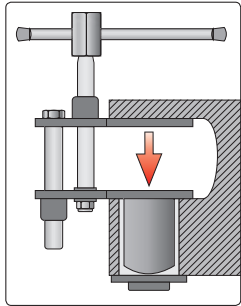

COLOR BOX

YATO
YT-0610

12/24

- GB** Disc brake piston tool
D Bremskolbenrücksteller universal
PL Uniwersalny klucz do wkręcania zacisków hamulcowych
RUS Ключ для тормозного поршня
CZ Univerzální klíč k montáži brzdových třmenů
H Féknyereg összenyomó

- RO** Dispozitiv pt. împins etrier
F Clé universelle pour pinces de frein
I Attrezzo per l'arretamento della pinza dei freni
E Llave para comprimir pistones del freno de disco
CN 刹车分泵拆装器

3/8"
10 mm

CrV



SLIDING CARD



YATO
YT-0683

12/96

for / dla: GM, FORD, Chrysler, VW, Fiat

- GB** Brake socket bit set
D Steckschlüssel-Set für Bremssättel
PL Zestaw nasadek do zacisków hamulcowych
RUS Набор насадок для тормозных суппортов
CZ Sada násadek k čištění brzdových třmenů
H Dugókulcs készlet féknyereg szereléshez
RO Set chei tubulare pt. saboti frana
F Jeux de douilles pour les étriers de frein
I Kit di attacchi per pinze di freni
E Set de vasos para pinzas de freno
CN 3件套 刹车制动器套筒



3
PCS

1/2"
12.5 mm



CrV

BMC
& COLOR
SLEEVE



YATO
YT-06807

10/20

- GB** Disc brake pad & caliper service tool kit
D Werkzeugsatz von manuellen Separatoren für die Bremsklemmen
PL Zestaw ręcznych separatorów do zacisków hamulcowych
RUS Набор ручных сепараторов для тормозных зажимов
CZ Ruční sada na montáž kotoučových brzd
H Fékmunkahenger prés készlet
RO Set de separatoare manuale pt. etrier frâna
F Set de repousse piston de frein
I Kit universale regolazione manuale per pistoncini freni
E Juego de separadores manuales para abrazaderas de freno
CN 刹车片分离器组套

6
PCS

ADJUSTABLE
RANGE
REGULOWANY
ROZSTAN

2
PINS
PINY

3
PINS
PINY



BMC
& COLOR
SLEEVE



YATO
YT-06827

10

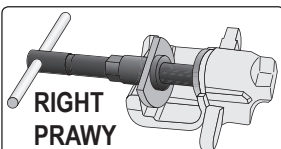
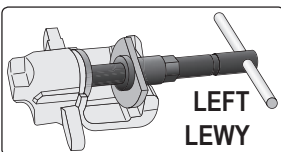

- GB** Disc brake pad & caliper service tool kit
D Werkzeugsatz von manuellen Separatoren für die Bremsklappen
PL Zestaw ręcznych separatorów do zacisków hamulcowych
RUS Набор ручных сепараторов для тормозных зажимов
CZ Ruční sada na montáž kotoučových brzd
H Fékmunkahenger prés készlet
RO Set de separatoare manuale pt. etrier frâna
F Set de repousse piston de frein
I Kit universale regolazione manuale per pistoni freni
E Juego de separadores manuales para abrazaderas de freno
CN 刹车片分离器组套

11
PCS

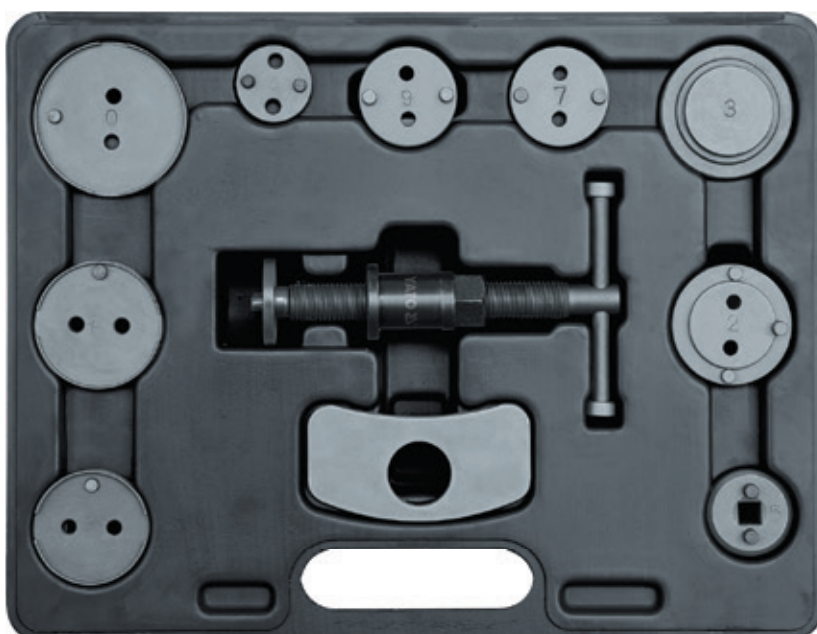

BMC
& COLOR
SLEEVE

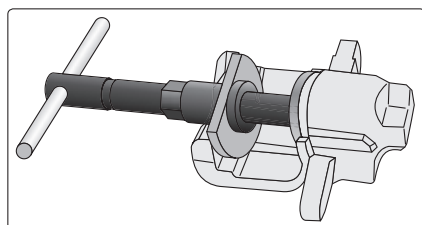

YATO	No.	zacisk przedni (F)	zacisk tylny (R)	
YTO-0681	1-1	silownik		5
	1	plytka oporowa		
	5	adapter z gniazdem		
	2	Citroen: XM, Xantia		
	3	Alfa Romeo, Audi, Austin, BMW, Honda, Jaguar, MB, Mitsubishi, Nissan, Rover, Toyota, VW		
	4		Ford, Mazda, Subaru, Alfa Romeo, Saab	
	6		Nissan	
	7		Audi, Ford, Honda, Nissan, Rover, Saab, Subaru, VW	
	8	General Motors		
9	General Motors			

- GB** Disc brake pad & caliper service tool kit
D Werkzeugsatz von manuellen Separatoren für die Bremsklappen
PL Zestaw ręcznych separatorów do zacisków hamulcowych
RUS Набор ручных сепараторов для тормозных зажимов
CZ Ruční sada na montáž kotoučových brzd
H Fékmunkahenger prés készlet
RO Set de separatoare manuale pt. etrier frâna
F Set de repousse piston de frein
I Kit universale regolazione manuale per pistoni freni
E Juego de separadores manuales para abrazaderas de freno
CN 刹车片分离器组套

12
PCS

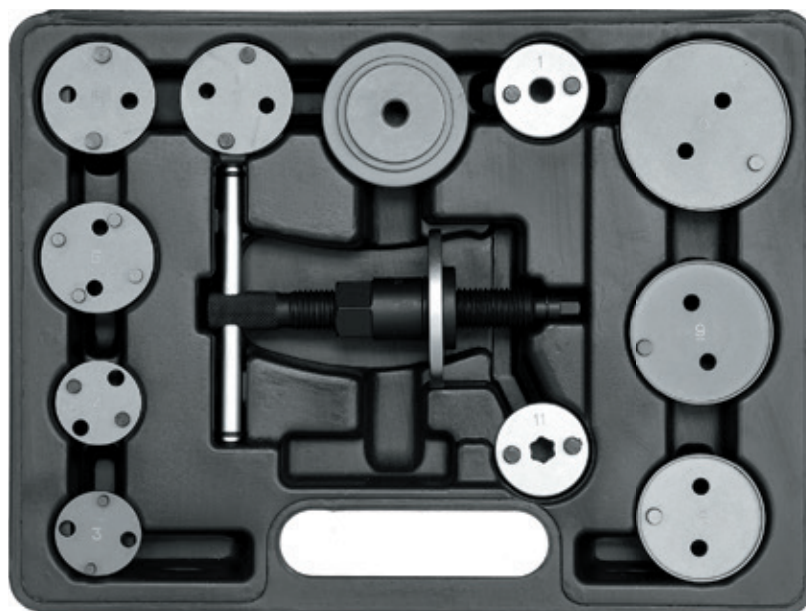

BMC
& COLOR
SLEEVE

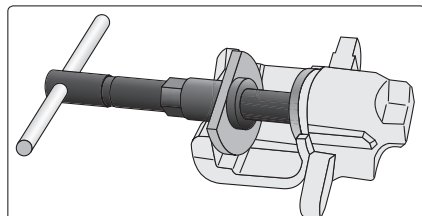

YATO	No.	zacisk przedni (F)	zacisk tylny (R)	
YTO-0611	0	General Motors - zaciski 2 1/2" (63.5 mm)		5
	1	Adapter do przedniego zacisku		
	2	Citroen XM, Xantia (F/R)		
	3		Opel (R)	
	4		Ford (R), Mazda (R), Saab (R), Alfa Romeo 164 2.0 (R), Honda (R), General Motors (R)	
	5	Nissan Maxima		
	6		Nissan Primera, VW Golf IV	
	7	Audi (F), Rover, Subaru (F), Ford (F), Nissan (F), Peugeot (F), Toyota (F), VW (F)		
	8	General Motors - zaciski 1 7/8" (47.6 mm)		
	9	General Motors - zaciski 2 1/8" (54.0 mm)		
	11		Adapter do tylnego zacisku	

- GB** Disk brake pad and caliper
D Pneumatischer Werkzeugsatz für Bremssattelsysteme
PL Pneumatyczny zestaw do zacisków hamulcowych
RUS Пневматический набор к тормозным зажимам
CZ Pneumatická souprava k montáži kotoučových brzd
H Pneumatikus készlet fék-munkahengerekhez
RO Ansamblu pneumatic pt. cilindre de frana
F Set pneumatique aux séparateurs de pinces de frein
I Kit universale regolazione pneumatico per pistoni freni
E Juego de herramientas neumaticas para apretadores de frenos
CN 盘式制动衬块和制动钳

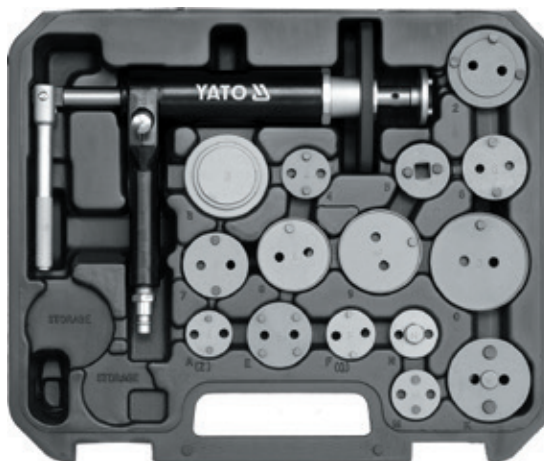
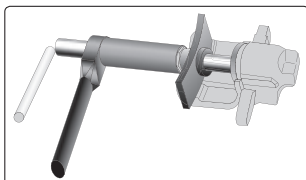

16
PCS

0.75
MPa



BMC
& COLOR
SLEEVE



YATO	No.	zacisk przedni (F)	zacisk tylny (R)
YT-0671	0	General Motors - zaciski 2 1/2" (F) (63.5 mm)	
	2		Citroen XM, Xantia (F/R)
	3	Audi (F), Alfa Romeo (F), Fiat (F), Ford Fiesta (F), Isuzu (F), Honda Concerto (F), Jaguar (F/R), BMW (F), Mercedes-Benz (F), Mitsubishi Colt (F), Nissan: Almera, Stanza, Sunny (F), Rover (F), Toyota Camry (F), Volvo (F), VW (F)	
	4		Ford (R), Mazda (R), Saab (R), Alfa Romeo 164 2.0 (R), Honda (R), General Motors (R)
	5		Adapter z gniazdem 3/8"
	6		Nissan Primera (R), VW Golf IV (R)
	7		Audi (R), Rover, Subaru (R), Ford (R), Nissan (R), Peugeot (R), Toyota (R), VW (R)
	8	General Motors - zaciski 1 7/8" (47.6 mm)	
	9	General Motors - zaciski 2 1/8" (54.0 mm)	
	A		Renault (R)
	E		Nissan Maxima (F/R)
	F		Opel (R)
	K		Citroen (R)
	M		Ford (R), Cooper (R)
N		Saab, Honda (F/R)	

- GB** Disc brake pad & caliper service tool kit
D Werkzeugsatz von manuellen Separatoren für die Bremsklappen
PL Zestaw ręcznych separatorów do zacisków hamulcowych
RUS Набор ручных сепараторов для тормозных зажимов
CZ Ruční sada na montáž kotoučových brzd
H Fékmunkahenger prés készlet
RO Set de separatoare manuale pt. etrier frâna
F Set de repousse piston de frein
I Kit universale regolazione manuale per pistoni freni
E Juego de separadores manuales para abrazaderas de freno
CN 刹车片分离器组套

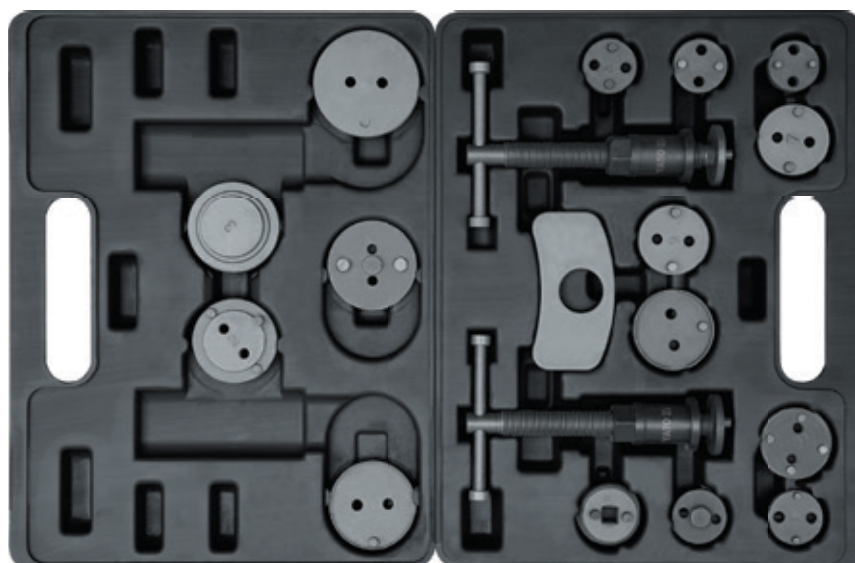
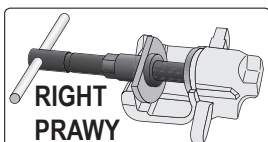
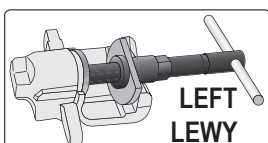

18
PCS

BMC
& COLOR
SLEEVE



YATO	No.	zacisk tylny (R)	zacisk tylny (R)	
YT-0682	1-1		sitowniki z lewym i prawym gwintem	
	1		plytka oporowa	
	5	3/8" (10.0 mm)	adapter z gniazdem	
	0	2 1/2" (63.5 mm)	General Motors	
	2	2 1/64" (51.0 mm)	Citroen XM, Xantia	
	3	2 5/32" (55.0 mm)	Audi, Alfa Romeo, Fiat, Ford Fiesta, Honda, Jaguar, BMW, Mercedes, Mitsubishi Colt, Nissan, Rover, Austin, Toyota Camry, Volvo, VW: Passat, Golf GTI	Jaguar
	4	1 1/4" (32.0 mm)		Ford, Mazda, Saab, Alfa Romeo 164, Honda, General Motors
	6	1 21/32" (42.0 mm)		Nissan Primera, VW Golf IV
	7	1 21/32" (42.0 mm)		Audi, Rover, Subaru, Ford, Nissan, Peugeot, Toyota, VW
	8	1 7/8" (48.0 mm)	General Motors	
	9	2 1/8" (54.0 mm)	General Motors, Cadillac	
	E	1 21/32" (42.0 mm)		Nissan Maxima
	F	1 1/4" (32.0 mm)		Opel
	K	2 1/8" (54.0 mm)		Citroen
M	1 1/4" (32.0 mm)		Ford	
N	1 1/4" (32.0 mm)	Saab, Honda		
A	1 3/16" (30.0 mm)		Renault	

GB Disc brake pad & caliper service tool kit
D Werkzeugsatz von manuellen Separatoren für die Bremmsklemmen
PL Zestaw ręcznych separatorów do zacisków hamulcowych
RUS Набор ручных сепараторов для тормозных зажимов

CZ Ruční sada na montáž kotoučových brzd
H Fék munkahenger prés készlet
RO Set de separatoare manuale pt. etrier frâna
F Set de repousse piston de frein
I Kit universale regolazione manuale per pistoni freni

E Juego de separadores manuales para abrazaderas de freno
CN 刹车片分离器组套

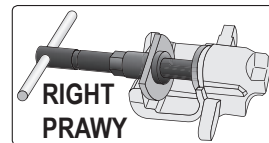
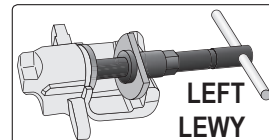

35 PCS
3/8"
10mm

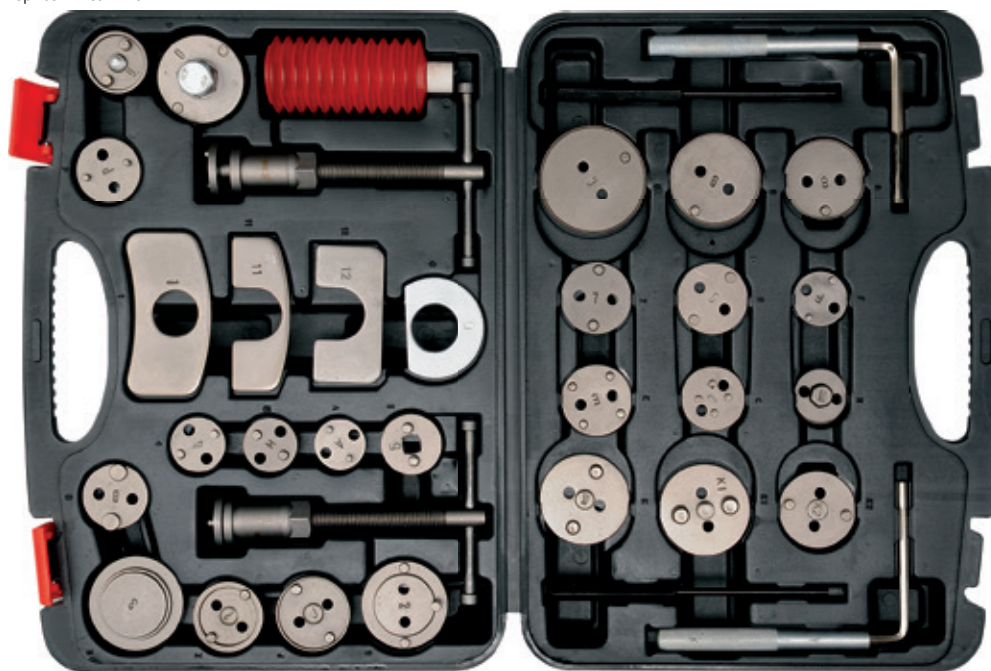

BMC & COLOR SLEEVE



No.	No.	zacisk przedni (F)	zacisk tylny (R)
YT-06822	2	2 1/64" (51.0 mm)	Citroen Xantia, Honda Prelude
	3	2 5/32" (55.0 mm)	Fiat, Alfa Romeo, Isuzu, Mercedes Benz, BMW, Citroen, Ford, Honda, Jaguar, Nissan, Peugeot, Rover, Toyota, VAG, Volvo
	4	1 1/4" (32.0 mm)	Ford, Mazda, Saab, Fiat, Alfa Romeo, General Motors
	5	3/8" (10.0 mm)	adapter z gniazdem
	7	1 21/32" (42.0 mm)	Nissan, VAG, Jaguar S
	6	1 21/32" (42.0 mm)	Audi, Rover, Subaru, Ford, Nissan, Peugeot, Toyota, VAG, Saab, Jaguar, GM
	8	1 7/8" (48.0 mm)	General Motors
	9	2 1/8" (54.0 mm)	General Motors, Cadillac
	0	2 1/2" (63.5 mm)	General Motors
	A	1 1/5" (30.5 mm)	Renault, BMW, Mini
	B	1 19/30" (41.5 mm)	Ford, Lincoln, Subaru
	C	1 19/30" (41.5 mm)	Mini, Nissan, Opel, Toyota
	D	2 1/64" (51.0 mm)	Renault, Citroen
	E	1 21/32" (42.0 mm)	Nissan Maxima
	F	1 1/4" (32.0 mm)	Opel, Fiat
	G	3/8" (10.0 mm)	Peugeot, GM
	J	1 22/33" (42.5 mm)	Fiat, Alfa Romeo, Audi, Citroen, Renault, Peugeot, Ford, Nissan, Saab, VAG, Subaru, Volvo
	K	2 1/8" (54.0 mm)	Citroen, Opel
	K1	2 1/8" (54.0 mm)	Renault, Citroen
	K2	1 22/23" (50.0 mm)	Citroen, Renault, Audi
P	1 19/30" (41.5 mm)	VAG, BMW, Ford, Lancia, Proton, Renault, Rover, Citroen	
M	1 1/4" (32.0 mm)	Ford, Mini, Nissan	
N	1 1/4" (32.0 mm)	Saab, Honda, Alfa Romeo, Ford Mondeo, Lancia, Volkswagen	
Z	1 3/16" (30.0 mm)	Ford, Mazda, Mitsubishi, Toyota Corolla	
1, 11, 12		plytka oporowa	

GB Air brake bleeder
D Druckluft-Bremsenentlüfter
PL Urządzenie pneumatyczne do wymiany płynu hamulcowego
RUS Устройство для замены тормозной жидкости
CZ Sada na odzdušnění brzdové soustavy a hydraulické spojky
H Pneumatikus eszköz a fékfolyadék cseréjére

RO Aparat de schimbat lichid frână
F Purger de frein et d'embrayage pneumatique
I Strumento per la sostituzione del liquido freni
E Sangrado del freno de aire comprimido
CN 气动刹车油更换机

0.27 MPa **5.0 l** **6m** **STANDARD**



$L_A \leq 70$ dB;
 $L_{A,eq} \leq 85$ dB;
 $a_s \leq 2.5$ m/s²

GREY CARTON BOX & COLOR LABEL



YATO
YT-06845 **1**

- GB** CV boot instalation tool
D Montagewerkzeug für Achsmanschetten
PL Urządzenie do montażu osłon przegubów
RUS Съёмник пыльников шруса пневматический
CZ Přípravek na montáž manžet
H Féltegelgy gumiharang felrakó-áthúzó levegős gép
RO Dispozitiv instalare burduf planetare
F Pince à soufflet pour montage de soufflet de cardan universel
I Dispositivo per il montaggio delle cuffie per giunti
E Dispositivo de instalación de fuelles planetarios
CN 气地球笼套扩张工具



0.9 MPa (max.)	Ø mm 20-115
8 ARMS RAMON	STANDARD



COLOR BOX

$L_{WA} < 70$ dB;
 $L_{WA} < 85$ dB;
 $a_p < 2,5$ ml/s*

YATO	
YT-06063	4

- GB** Pneumatic oil drain extractor
D Druckluft Ölabsauggerät / Ölaufanggerät
PL Zlewarko-wysysarka pneumatyczna
RUS Маслосборная установка пневматическая
CZ Pneumatická odsávačka vyjetého oleje
H Pneumatikus fátartolaj gyűjtő / leszívó
RO Rezervor decantare ulei uzat

- F** Récupérateur d'huile par aspiration
I Aspiratore-recuperatore pneumatico
E Recuperador de aceite de succión
CN 抽接油机



150 cm

90 l	0.7-0.8 MPa SUCTION PROBE CONJUNE OROVIVANI
0.18 MPa EJECTION PRESSURE ERŐNYERŐ OROVIVANI	6 SUCTION PROBES SÚVIVY ŐRAC
WHEELS KÖLYEK X4	STANDARD

GREY CARTON BOXES & COLOR LABEL

$L_{WA} = 101,2 \pm 3$ dB;
 $L_{WA} = 119,8 \pm 3$ dB

YATO	I	
YT-07190	90	1

- GB** Coil spring clamp
D Federspanner
PL Ściągacz do sprężyn
RUS Съёмник пружин
CZ Stahovák pružin tlumičů automobilů
H Rugóösszehúzó

- RO** Presa pt. arcuri
F Compresseurs de ressort
I Estrattore per smonta molle
E Extractor de muelles
CN 弹簧夹

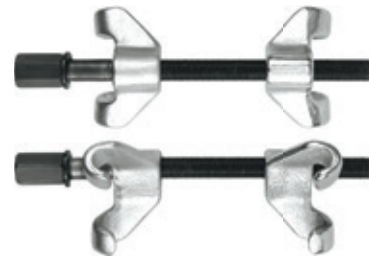

COLOR BOX

2 PCS	1 1/2" (12.5 mm)
	21 mm

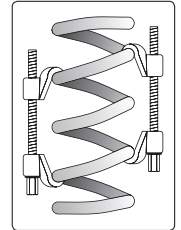

YATO	Ø (mm)	L (mm)	
YT-0605	90	200	5/10

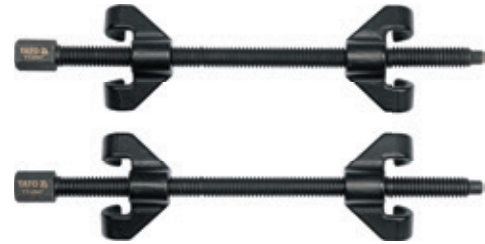

CrV

YATO	Ø (mm)	L (mm)	
YT-2544	82	370	8

COLD FORGED KUTE NA ZIMNO

YATO	Ø (mm)	L (mm)	
YT-2546	82	280	8
YT-2547	82	355	8

- GB** Macpherson spring dumper extractor
D Abziehvorrichtung für Federn von MacPherson
PL Ściągacz do sprężyn MacPhersona
RUS Съёмник пружин подвески Макферсона
CZ Stahovák pružin McPherson
H MacPerson rugó összehúzó
RO Extractor de arcuri MacPherson
F Compresseurs de ressort MacPherson
I Estrattore per molle MacPherson
E Desmontador para los resortes de MacPherson
CN 弹簧压缩器



CrMo SCM-415

max. 2900kg

3 POINTS OF FIXING PUNKTY MOCOWANIA

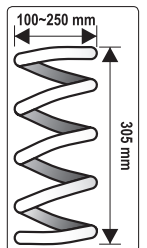

WHITE CARTON BOX & COLOR LABEL



YATO		
YT-2535		2

- GB** Interchangeable fork spring compressor and removal tool
D Abziehvorrichtung für MacPherson-Federn mit austauschbaren Halterungen
PL Ściągacz do sprężyn MacPhersona z wymiennymi uchwytami
RUS Стяжка для снятия пружин Макферсона со сменными полукольцами
CZ Stahovák pružin McPherson s vyměnitelnými čelistmi
H MacPherson rugó összehúzó cserélhető pófákkal
RO Ancoră suspensie MacPherson cu mânere interschimbabile
F Compresseurs de ressort MacPherson
I Smonta ammortizzatori per sospensioni MacPherson
E Extractor de resortes MacPherson con mangos intercambiables
CN 免拆式减震弹簧压缩器

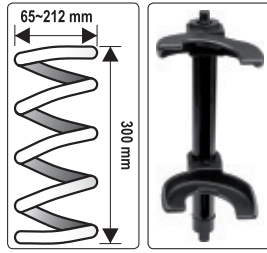

7 PCS 65-125 mm 88-160 mm max. 1500kg 126-212 mm

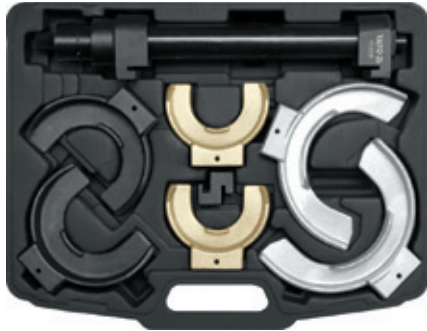

BMC & COLOR SLEEVE

YATO	
YT-2536	1

- GB** Drive nut set
D Stoszdämpfer Nutmutter Einsätze
PL Zestaw nasadek do amortyzatorów
RUS Набор головок для амортизаторов
CZ Sada hlavic na uložení tlumiče
H Lengéscsillapítókszedő szet
RO Set prezoane
F Set des embouts aux amortisseurs
I Set di chiavi per aria condizionata
E Juego de boquillas de amortiguadores
CN 拆装减震器套件组套

5 PCS

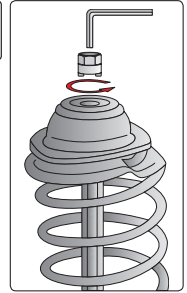

SLIDING CARD



- No. 1 10.5 mm VW Golf rear
 No. 2 12.5 mm VW Golf front
 No. 3 14.5 mm VW Polo, Golf, Passat, Audi 80
 No. 4 14.5 mm Austin Maestro
 No. 5 14.0 mm Mercedes Benz C-Class (W203)

YATO	size / rozmiar (mm)	
YT-0621	10.5; 12.5; 14.5; 14.5; 14.0	12/48

- GB** Turnbuckle for shock absorber's top lid
D Schlüsselsatz zum Befestigen der Stoßdämpfer
PL Zestaw kluczy do mocowania amortyzatorów
RUS Набор ключей для крепления амортизаторов
CZ Sada klíčů k montáži tlumičů
H Kulcskészlet lengéscsillapítók rögzítéséhez
RO Set chei pt. fixare amortizoare
F Set de clés pour amortisseurs

- I** Set chiavi per montare ammortizzatori
E Juego de llaves para la instalación de amortiguadores
CN 避震器拆卸器

39 PCS CrMo SCM415 CrV 6140 CrV 50BV30 STEEL 8660

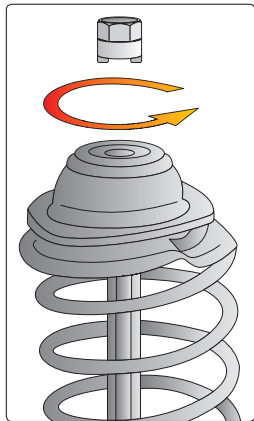

BMC & COLOR SLEEVE



YATO	size / rozmiar (mm)	type of car / model samochodu	size / rozmiar (mm)	type of car / model samochodu	
YT-0628	10.5 x 3.5	VW Golf Rear Axle	CrV 6140	D5	Nissan
	12.5 x 3.5	VW Golf Front Axle		D10	Nissan, Ford
	14.5 x 5	VW Polo, Golf, Passat, Audi 80		8	Mercedes-Benz
	14.5 x 3	Austin Maestro		9	Opel/Vauxhall, Chrysler
	14 x 2.5	Mercedenz Benz W203 (C-class), W209 (CLK)		10	Chrysler, Ford
	14	Honda, Nissan	STEEL 8660	11	Japanese Cars
	16	VW, Audi, Seat, Fiat		5	Honda
	17	Ford, VW, Audi, Seat, Fiat		6	Seat, Fiat, Citroen, Peugeot, Ford, Opel, Renault, Japanese Cars, BMW
	18	Ford, VW, Audi, Seat, Rover, Fiat, Opel, Peugeot, Renault, Japanese Cars		7	VW, Audi, Seat, Fiat, Citroen, Peugeot, Mercedes-Benz (W203), Renault
	19	VW, Audi, Seat, Citroen, Fiat, Opel, Peugeot, Toyota		8	Mercedes-Benz
	21	Mercedenz-Benz W203, Chrysler, VW, Audi, Ford, Japanese Cars		3	Mercedes-Benz, Opel, Renault
	22	VW, Audi, Seat, Citroen, Fiat, Opel, Peugeot, Renault, BMW		3.5	Chrysler, Ford, Citroen, Peugeot
24	Volvo	4		Citroen, Peugeot	
27	VW, Audi, Citroen, Peugeot	STEEL 8660		M12	Opel/Vauxhall
4	Nissan			T50	Nissan, Ford
5.2	VW, Audi, Nissan			T60	Ford
6	VW, Audi, Renault				
6.3	Nissan				
7	VW, Audi, Seat, Fiat				
8	Seat, Fiat				
9	Japanese Cars				
10	Seat, Fiat, Volvo				
12	Seat, Fiat				

GB Electric impact wrench
D Elektro-Schlagschrauber
PL Elektryczny klucz udarowy
RUS Электрический гайковерт
CZ Elektrický rázový utahovák
H Elektromos ütvecsavarozó
RO Pistol de impact electric
F Clé à choc électrique
I Avvitatore elettrico ad impulso
E llave de impacto eléctrica
CN 电动冲击扳手

230V~ 50Hz	450 W	450 Nm	0-3300 min ¹	T 0-3300 min ¹
1/2" 12.5mm	17, 19 21, 22 mm	4m		



L_{pa} = 96 ± 3 dB;
L_{wa} = 107 ± 3 dB;
a_w = 17,648 ± 1,5 m/s²

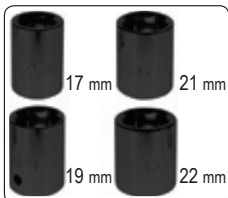

BMC
& COLOR
SLEEVE

YATO	W	
YT-82020	450	4

GB Electric impact wrench
D Elektro-Schlagschrauber
PL Elektryczny klucz udarowy
RUS Электрический гайковерт
CZ Elektrický rázový utahovák
H Elektromos ütvecsavarozó
RO Pistol de impact electric
F Clé à choc électrique
I Avvitatore elettrico ad impulso
E llave de impacto eléctrica
CN 电动冲击扳手

230V~ 50Hz	1020 W	600 Nm	0-2600 min ¹	T 0-2700 min ¹
1/2" 12.5mm	17, 19 21, 22 mm	4m		



L_{pa} = 100 ± 3 dB;
L_{wa} = 111 ± 3 dB;
a_w = 18,9 ± 1,5 m/s²

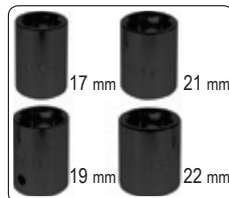

BMC
& COLOR
SLEEVE

YATO	W	
YT-82021	1020	3

GB Tire valve stem inserter
D Abziehvorrichtung für die Gummiventile
PL Przeciagacz do zaworków gumowych
RUS Протяжка к резиновым клапанам

CZ Páka k provlékání bezdušových ventilů
H Szíjfeszesség mérő
RO Broșă pt. supapele cauciucate
F Levier tire-valve

I Brocca valvola di gomma
E Brocha de tracción para las válvulas de goma
CN 气门插入工具

SLIDING
CARD



290
mm

RUBBER
VALVES
ZAWORKY
GUMOWE



YATO	L (mm)	
YT-0619	290	12/72

GB Wheel balance pliers
D Auswuchtgewicht-Zange
PL Szczypce do wyważania kół
RUS Клещи для балансировки колес
CZ Kleště pro vyvažování kol
H Centírsúly szerelő szerszám
RO Cleste pt. cauciuc

F Pincés pour le contrepois à agrafe de roue de voiture
I Pinze per equilibrio ruota
E Tenazas de equilibrar ruedas
CN 平衡钳

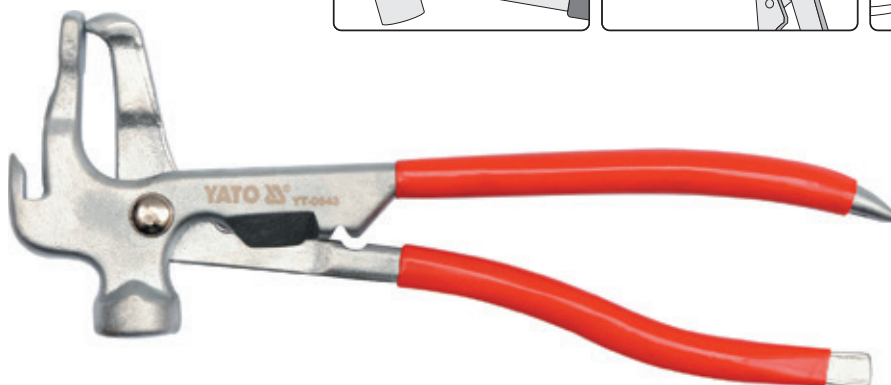
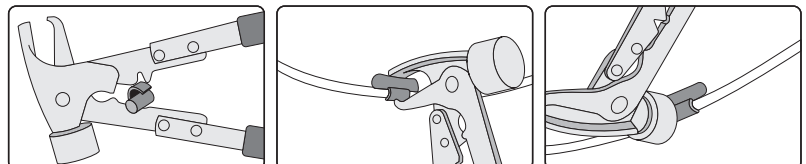

SLIDING
CARD



YATO	
YT-0643	12/48

- GB** Deep thin wall impact sockets
- D** Schon-Kraftschraubereinsatz für Alufelgen
- PL** Zestaw nasadek uderowych do felg aluminiowych
- RUS** Набор головок для алюминиевых дисков
- CZ** Sada nástrčných kľúčů na alu ráfky
- H** Hosszított dugókulcs készlet, könnyűfém felnikhez
- RO** Dibli de impact cu mufare in interior
- F** Set de douilles profondes à choc
- I** Set di chiavi a bussola per dadi ruota di alluminio
- E** Juego de boquillas de percusión para llantas de aluminio
- CN** 风动薄壁长套筒

- for service station and tire workshops
- for maximum impact loads
- drive locks
- ultra thin walls and nylon cover for working with alu rims
- anodised colour finish for fast identification of size
- dla serwisów i warsztatów oponiarskich
- do największych obciążeń uderowych i tętniących
- zamki blokujące
- ultra cienkie ścianki i nylonowe pokrycie do pracy z felgami aluminiowymi
- anodowane kolorowe wykończenie dla szybkiej identyfikacji rozmiaru



3 PCS	1/2" 12.5mm	17 19 21 mm
CrMo SCM-440	26 29 31 mm	AS-DRIVE

BMC & COLOR SLEEVE



YATO	1/2" (12.7 mm)	12/24
YT-1056		

- GB** Deep aluminium wheel nut socket set
- D** Set mit langen Stoßaufsätzen für Alufelgen
- PL** Zestaw nasadek uderowych długich do felg aluminiowych
- RUS** Набор длинных ударных насадок для алюминиевых дисков
- CZ** Sada dlouhých nárazových zásuvek pro hliníkové disky
- H** Hosszú ütve-dugókulcs készlet alumínium felnikhez
- RO** Set chei adanci pt. pilite aluminiu
- F** Jeu de douilles à chocs longues pour jantes en aluminium
- I** Kit di punte a percussione lunghe per cerchi in lega
- E** Juego de vasos de impacto largos para llantas de aluminio
- CN** 加长轮胎保护套筒



6 PCS	1/2" 12.5mm	17 19 21 mm
150 mm	27 29 31 mm	CrMo

BMC & COLOR SLEEVE



YATO	1/2" (12.7 mm)	10
YT-10563		

- GB** Emergency wheel nut remover
- D** Schlag-Steckschlüsselsatz für Selbstsichernde Schrauben
- PL** Nasadki uderowe do wykręcania śrub zabezpieczających
- RUS** Ударные головки для снятия предохранительных винтов
- CZ** Přiklepové násadky k vyjmování zajišťovacích šroubů
- H** Ütve-dugókulcs készlet biztonsági csavarok kihajtásához
- RO** Set tubulare speciale pt. prezoane rotunjite
- F** Embouts pour le dévissage par impact des vis de sécurité
- I** Chiavi ad impatto per estrazione viti di sicurezza
- E** Vasos de impacto para desenroscar tornillos de seguridad
- CN** 4件套 1/2 " 应急螺母组套

4 PCS	1/2" 12.5mm	CrMo
-----------------	-----------------------	-------------



METAL CASE & COLOR SLEEVE



1/2" (12.7 mm): 17.0, 18.5, 21.5, 26.0 mm); CrMo

YATO	1/2" (12.7 mm)	10/20
YT-06030		

- GB** Rubber valve core torque tool
- D** Drehmomentwerkzeug für gummi Dichtende Reifenventileinsätze
- PL** Klucz dynamometryczny do zaworków gumowych
- RUS** Ключ динамометрический для резиновых клапанов
- CZ** Kľúč momentový k montáži gumových ventilů
- H** Szeleptűkiszerelő kulcs gumitömítésű szelephez
- RO** Surubelnita din plastic pt. supapa
- F** Clé dynamométrique pour soupapes
- I** Giravite dinamometrica per valvole
- E** Llave dinamométrica de válvulas de goma
- CN** 定扭橡胶气门芯拆卸工具

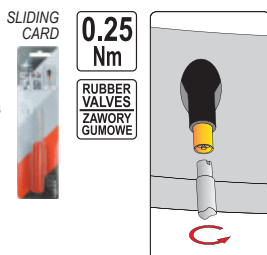

YATO	50/200
YT-0795	

- GB** Metal valve core torque tool
- D** Drehmomentwerkzeug für metallisch Dichtende Reifenventileinsätze
- PL** Klucz dynamometryczny do zaworków metalowych
- RUS** Ключ динамометрический для металлических клапанов
- CZ** Kľúč momentový k montáži kovových ventilů
- H** Szeleptűkiszerelő kulcs fémtömítésű szelephez
- RO** Surubelnita metalica pt. supapa
- F** Clé dynamométrique pour soupapes
- I** Giravite dinamometrica per valvole
- E** Llave dinamométrica de válvulas de metal
- CN** 定扭橡胶气门芯拆卸工具

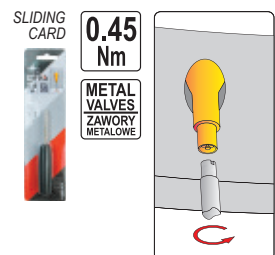

YATO	50/200
YT-0796	



- GB** Cross rim wrench
D Kreuzschlüssel
PL Krzyżakowy klucz do kół
RUS Ключ-крест балонный
CZ Klíč na kola křížový
H Kereszt kerékkulcs
RO Cheie în cruce pt. roți
F Clé en croix aux roues
I Chiavi a croce per auto ruota
E Llave cruz para ruedas
CN 十字套筒扳手



CrV

PLASTIC HANGER



YATO 	size / rozmiar	
YT-0800	17 x 19 x 21 x 22 mm	10
YT-0801	17 x 19 x 21 x 1/2" (12.7 mm)	10
YT-0802	24 x 27 x 32 x 3/4" (19.0 mm)	3

- GB** T-type sleeved ratchet wrench
D Radmutter Schlüssel für Autos
PL Klucz do kół samochodowych
RUS Ключ к автомобильным колесам
CZ Klíč na kola automobilů
H Kerékkulcs
RO Cheie pt. roți de automobile
- F** Clé cliquet aux roues
I Chiavi per ruota auto
E Llave para las ruedas de automóviles
CN T型棘轮扳手组套



PLASTIC HANGER



4
PCS

1/2"
12.5mm

44T

CrV
50BV30

AS-DRIVE

1/2" (12.7 mm): 17, 19, 21, 23 mm

YATO 	
YT-0803	5/10

- GB** Folding cross wrench
D Radmutter Schlüssel
PL Składany klucz do kół w etui
RUS Балонный крестовой разборный ключ с чехлом
CZ Skládací křížový klíč na matice
H Összecsukható kereszt csavarkulcs

- RO** Cheie cruce pt. șuruburi roți
F Clé démonte roue en croix démontable
I Pierevole cress chiave
E llave para las ruedas de automóviles
CN 快速十字扳手

TEXTILE WALLET & COLOR BOX



4 PCS	17 mm	19 mm	21 mm
23 mm	1/2" 12.5mm	CrV	WALLET ETUI

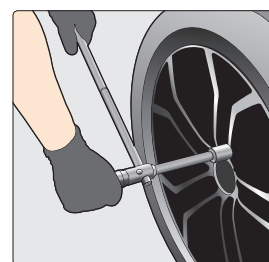



YATO 	size / rozmiar	
YT-08035	1/2" (12.7 mm)	10

- GB** Tire lever
D Reifenmontierhebel
PL Łyzka do opon
RUS Прибор для шиномонтажа
CZ Montážní páka na pneumatiky
- H** Gumiabroncs kar
RO Levier pt. roti
F Cuillère à pneus
I Leva per pneumatici

- E** Desmontable para las llantas
CN 轮胎起子

300 mm	400 mm	500 mm	600 mm	CrV
-----------	-----------	-----------	-----------	-----



YATO 	size / rozmiar (mm)	
YT-0807	300	20
YT-0808	400	20
YT-0809	500	5/20
YT-0810	600	5/20

- GB** Tire lever
D Reifenmontierhebel
PL Łyzka do opon
RUS Прибор для шиномонтажа
- CZ** Montážní páka na pneumatiky
H Gumiabroncs kar
RO Levier pt. roti
F Cuillère à pneus
- I** Leva per pneumatici
E Desmontable para las llantas
CN 撬棒

SLIDING CARD



380
mm

CrMo



YATO 	size / rozmiar (mm)	
YT-0811	380	10/50

GB Rectangular telescopic inspection mirror	RUS Зеркало инспекционное телескопическое	RO Oglinda telescopică pt. inspectie	E Espejo rectangular telescópico de inspección
D Teleskop Inspektionsspiegel	CZ Zrcátko kontrolní teleskopické	F Miroir d'inspection	CN 可伸缩矩形检测镜
PL Lusterko inspekcyjne	H Vizsgáló tükör, teleszkópos nyéllel	I Telescopio ispezione specchio	

50x90 mm

TELESCOPIC HANDLE
285x770 mm



YATO
YT-0660 12/144

GB LED lighted telescopic inspection mirror	RUS Зеркало досмотровое с подсветкой	RO Oglindă pt. inspectie cu lampă	E Espejo de control con lámpara
D Prüf Spiegel mit Beleuchtung	CZ Inspekční zrcadélko s lampou	F Miroir d'inspection avec lampe	CN 带灯检测镜
PL Lusterko inspekcyjne z lampką	H Vizsgáló tükör, lámpával	I Specchio di ispezione con lampada	

265 - 920 mm; ∅54 mm
TELESCOPIC HANDLE
TELESKOPOVY UCHVYT

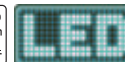

SS
STAINLESS STEEL
STAL NERZŹEWA



YATO
YT-0663 10/100

GB Telescopic magnetic pick up tool	CZ Patka teleskopická magnetická	I Telescopio magnete
D Teleskop magnet Heber	H Felszedő mágnes, teleszkópos nyéllel	E Herramienta levantadora magnética, telescópica
PL Chwytnak teleskopowy z magnesem	RO Telescop magnetic	CN 可伸缩磁性拾拾器
RUS Захват магнитный телескопический	F Capteur magnétique	

2 kg



TELESCOPIC HANDLE
250x750 mm



YATO
YT-0661 12/144

GB Telescopic magnetic pick up tool	CZ Patka teleskopická magnetická	I Telescopio magnete
D Teleskop magnet Heber	H Felszedő mágnes, teleszkópos nyéllel	E Herramienta levantadora magnética, telescópica
PL Chwytnak teleskopowy z magnesem	RO Telescop magnetic	CN 可伸缩磁性拾拾器
RUS Захват магнитный телескопический	F Capteur magnétique avec une diode	



190 - 800mm
TELESCOPIC HANDLE
TELESKOPOVY UCHVYT

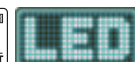

YATO
YT-06611 12/144

GB Telescopic magnetic pick up tool	CZ Patka teleskopická magnetická
D Teleskop magnet Heber	H Felszedő mágnes, teleszkópos nyéllel
PL Chwytnak teleskopowy z magnesem	RO Telescop magnetic
RUS Захват магнитный телескопический	F Capteur magnétique
I Telescopio a specchio	
E Herramienta levantadora magnética, telescópica	
CN 可伸缩磁性拾拾器	

22.5 kg

82 mm

TELESCOPIC HANDLE
UCHVYT TELESKOPOVY
59-99 cm



YATO
YT-0860 L (cm) 6/24

GB Telescopic pick up and mirror set	PL Zestaw inspekcyjny: lusterko + chwytnak
D Inspektionssatz: Spiegel + Greifer	RUS Проверочный набор + держатель и зеркальце
RO Garnitură de control: oglindă + benă	CZ Inspekční souprava: zrcadlo + držák
F Kit miroir + grappin	H Teleszkópos ellenőrző készlet
I Set per ispezione: specchio + supporto	RO Garnitură de control: oglindă + benă
E Juego de inspección: espejo + cuchara de mordazas	F Kit miroir + grappin
CN 检测镜拾拾器组套	I Set per ispezione: specchio + supporto

PLASTIC BOX & DOUBLE BLISTER

4 PCS

0,5 kg (max)
1,5 kg (max)



160 - 620 mm
TELESCOPIC HANDLE
UCHVYT TELESKOPOVY

250 - 930 mm; ∅ 57 mm
TELESCOPIC HANDLE
UCHVYT TELESKOPOVY



YATO
YT-0662 10/40

GB Magnetic parts tray
D Magnetschale
PL Miska magnetyczna
RUS Магнитный поднос
CZ Miska magnetická
H Mágneses tálca

RO Tava magnetica
F Bol magnétique
I Ciotola magnetica

E Bandeja de accesorios magnética
CN 磁盘

COLOR BOX



Ø mm
110

Ø mm
150

YATO 
YT-08295 12/48

YATO 
YT-0830 12/48

GB Magnetic parts tray
D Magnetschale
PL Miska magnetyczna
RUS Магнитный поднос
CZ Miska magnetická
H Mágneses tálca

RO Tava magnetica
F Bol magnétique
I Ciotola magnetica
E Bandeja de accesorios magnética
CN 磁盘

350x150
mm



GB Magnetic parts tray
D Magnetschale
PL Miska magnetyczna
RUS Магнитный поднос
CZ Miska magnetická
H Mágneses tálca

RO Tava magnetica
F Bol magnétique
I Ciotola magnetica
E Bandeja de accesorios magnética
CN 磁盘

152x68
mm



YATO 
YT-0831 6/12

YATO 
YT-08312 48

GB Magnetic parts tray
D Magnetschale
PL Miska magnetyczna
RUS Магнитный поднос
CZ Miska magnetická
H Mágneses tálca
RO Tava magnetica
F Bol magnétique
I Ciotola magnetica
E Bandeja de accesorios magnética
CN 磁盘

0.10-0.12
T
(TESLA)

Ø mm
150



COLOR BOX



GB Magnetic parts tray
D Magnetschale
PL Miska magnetyczna
RUS Магнитный поднос
CZ Miska magnetická
H Mágneses tálca
RO Tava magnetica
F Bol magnétique
I Ciotola magnetica
E Bandeja de accesorios magnética
CN 磁盘

0.10
T
(TESLA)

Ø mm
110



COLOR BOX



YATO 
YT-08305 20

YATO 
YT-08304 24

GB Magnetic parts tray
D Magnetschale
PL Miska magnetyczna
RUS Магнитный поднос
CZ Miska magnetická
H Mágneses tálca
RO Tava magnetica
F Bol magnétique
I Ciotola magnetica
E Bandeja de accesorios magnética
CN 磁盘



2
PCS

0.10
T
(TESLA)

Ø mm
108

Ø mm
150



YATO 
YT-08302 6/24

GB Magnetic parts tray
D Magnet-Sortierbox
PL Sortownik magnetyczny
RUS Сортировщик
CZ Magnetický třídič
H Mágneses rendszerező
RO Tava magnetica pt. piese
F Rangement compartimenté magnétique
E Clasificador magnético
CN 磁力盘



190x120
x34
mm

PVC



COLOR BOX



YATO 
YT-08320 48

- GB** Magnetic tool holder
D Magnet Werkzeughalter
PL Listwa magnetyczna
RUS Магнитная рейка
CZ Magnetický držák nářadí
- H** Mágneses tartó
RO Suport magnetic
F Barre et porte
outil magnétique
I Striscia magnetica

- E** Bandeja de accesorios
magnética
CN 磁性工具架



YATO		
YT-0835		4/16

- GB** Magnetic screwdriver rack
D Magnetische Halterung für Schraubendreher
PL Uchwyt magnetyczny na wkrętaki
RUS Магнитный держатель для отверток
CZ Magnetický držák šroubováků
H Mágneses csavarhúzó tartó

- RO** Raft magnetic pt. surubelnite
F Mandrin magnétique pour tournevis
E Soporte magnético para destornilladores
CN 磁性螺丝刀架

350 mm	x9	ABS	
---------------	-----------	------------	--



DOUBLE BLISTER

YATO	L (mm)	
YT-08353	350	24

- GB** Magnetic pliers rack
D Magnethalter Werkzeughalter
PL Uchwyt magnetyczny na narzędzia
RUS Магнитный держатель для инструментов
CZ Magnetický držák na nářadí

- H** Mágneses szerszámtartó
RO Raft magnetic pt. clesti
F Fixation magnétique pour outils
E Soporte magnético para herramientas
CN 磁性钳子架

350 mm	x9	ABS	
---------------	-----------	------------	--



DOUBLE BLISTER

YATO	L (mm)	
YT-08354	350	24

- GB** Magnetic holder for tools
D Magnethalter für Schlagschrauber
PL Uchwyt magnetyczny na narzędzia
RUS Магнитный держатель для ударного гайковерта
CZ Magnetický držák nářadí
H Mágneses tartó
RO Suport magnetic pt. scule pneumatice
F Support magnétique pour outils pneumatiques
I Fissaggio magnetico per chiave ad impulsi pneumatica
E Soporte magnético para llave de impacto
CN 磁性喷枪架

15 kg max.



COLOR BOX

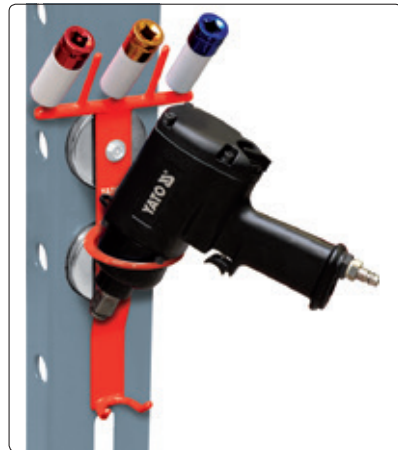

YATO		
YT-08707		5/10

- GB** Tweezer
D Pinzette
PL Peşeta
RUS Пинцет
- CZ** Pinzeta
H Csipesz
RO Pensetă
F Pince
- I** Pinza
E Pinzas
CN 镊子

SLIDING CARD



302
STAINLESS STEEL
STAL NERZŻEWNIA
ANTI MAGNETIC
ANTYMAGNETYCZNA
ANTIACID
KWASO-ODPORNA



140 mm	HRC 30
---------------	---------------

YATO	L (mm)	
YT-6903	140	20/240



115 mm	HRC 30
---------------	---------------

YATO	L (mm)	
YT-6907	115	20/240



140 mm	HRC 40
---------------	---------------

YATO	L (mm)	
YT-6916	140	20/240

- GB Workshop creeper
D Werkstatt-Liege
PL Leżanka warsztatowa
RUS Лежак ремонтный
CZ Lehátko
H Fekpad gurulos
- RO Targa
F Chariot de visite
I Lettino sdraio sotto vettura
E Camilla de taller
CN 汽修躺板

100 cm 





YATO 
YT-0880  1

- GB Workshop creeper
D Werkstatt-Liege
PL Leżanka warsztatowa
RUS Лежак ремонтный
- CZ Lehátko
H Fekpad gurulos
RO Targa
F Chariot de visite

- I Lettino sdraio sotto vettura
E Camilla de taller
CN 汽修躺板



91 cm 
 



YATO 
YT-0880  1

- GB Work bench
D Lackierständer, verstellbar
PL Stojak lakierniczy rozstawny
RUS Раздвижная лакировочная стойка
CZ Stojan lakýrnický rozkládací
H Kinyitható lakkozó állvány
RO Suport extensibil pt. lacuit
F Support à peindre
I Supporto pieghevole
E Montante plegable para barnizar
CN 工作台





10 kg max 
85 cm
150 kg max 
45 cm





YATO 
YT-5555  1

- GB Number stamp
D Nummernstempel
PL Znaczniki cyfrowe
RUS Клейма цифровые
CZ Razidla číselná
H Számbeütők
RO Poansoare cu cifre
F Chiffres à frapper
I Punzoni marcatori
E Marcadores de números
CN 数字冲模





9 PCS 
1045 CARBON STEEL 

PLASTIC BOX & COLOR SLEEVE 



YATO 	No (mm)	PCS packing:	
YT-6854	6	9	20
YT-6855	8	9	18

- GB Letter stamp
D Buchstabenstempel
PL Znaczniki literowe
RUS Клейма буквенные
CZ Razidla písmenová
H Betűbeütők
RO Poansoare cu litere
F Lettres à frapper
I Punzoni marcatori
E Marcadores de letras
CN 字母冲模



27 PCS 
1045 CARBON STEEL 

PLASTIC BOX & COLOR SLEEVE 

YATO 	No (mm)	PCS packing:	
YT-6862	6	27	12
YT-6863	8	27	8

- GB Refractometer
D Refraktometer
PL Refraktometr
- RUS Рефрактометр
CZ Refraktometer
H Fagyálló fokoló
- RO Refractometrul
F Réfractomètre
I Rifrattometro
- E Refractometro
CN 冰点仪



PLASTIC BOX & COLOR SLEEVE 

YATO 
YT-06722  25

- GB Axle spindle rethreading set
- D Gewindereparatur Set Antriebswelle
- PL Zestaw do naprawy gwintów pólasi
- RUS Набор для восстановления резьбы оси шруса
- CZ Souprava k opravě závitů hnacích hřídelí
- H Részecs menetjavító készlet főtengelyekhez
- RO Trusa pt. reparat filetele la planetare
- F Kit réparation filetage cardan
- I Kit di ripristino di filetti dei semiassi
- E Kit de herramienta de la reparación
- CN 传动轴螺杆修复组套



8
PCS 5/4"
32mm

M24x1.50; M24x2.00;
M22x1.00; M22x1.50;
M20x1.25; M20x1.50;
3/4x20 UNEF;
13/16x20 UNEF

BMC
& COLOR
SLEEVE



YATO	
YT-17695	10

- GB Thread repair set
- D Reparatursatz für Gewinde
- PL Zestaw do naprawy gwintów
- RUS Набор для ремонта резьбы
- CZ Souprava na opravu závitů
- H Menetjavító készlet
- RO Set pt. reparare filete

- F Set d'helicoils
- I Kit di riparazione per filettature
- E Juego para reparar roscas
- CN 螺纹修复组套

HSS
4241
4341

SS
STAINLESS STEEL
STAL NIERDZEWNA

- GB Thread repair set
- D Reparatursatz für Gewinde
- PL Zestaw do naprawy gwintów
- RUS Набор для ремонта резьбы
- CZ Souprava na opravu závitů
- H Menetjavító készlet
- RO Set pt. reparare filete

- F Set d'helicoils
- I Kit di riparazione per filettature
- E Juego para reparar roscas
- CN 螺纹修复组套

HSS
4341

SS
STAINLESS STEEL
STAL NIERDZEWNA

METAL BOX
& COLOR BOX



PLASTIC
HANGING
BOX



YATO	size / rozmiar	PCS packing	
YT-17631	M5x0.8	30	20/40
YT-17632	M6x1.0	30	20/40
YT-17633	M8x1.25	30	20/40
YT-17634	M10x1.5	30	20/40
YT-17635	M12x1.75	20	20/40

88
PCS



YATO	size / rozmiar	
YT-1769	M6 x 1.0 x 10.8 mm	5/10
	M8 x 1.25 x 10.8 mm	
	M10 x 1.5 x 13.5 mm	

131
PCS



YATO	size / rozmiar	
YT-1763	M5 x 0.8 x 6.7 mm	5/10
	M6 x 1.0 x 10.8 mm	
	M8 x 1.25 x 10.8 mm	
	M10 x 1.5 x 13.5 mm	
	M12 x 1.75 x 16.3 mm	

- GB Wire threads
- D Spiraleinlagen für Gewindereparatur
- PL Wkłady spiralne do naprawy gwintów
- RUS Метчики и сверла для ремонта резьбы
- CZ Spirálové vložky na opravu závitů
- H Menetjavító betétek

- RO Insertii spirală pt. reparare filete
- F Helicoil
- I Inserti a spirale per riparazione
- E Elementos espirales para reparar roscas
- CN 不锈钢螺纹套

POLYBAG
WITH
HEADER



for / dla: YT-1763, YT-1769

SS
STAINLESS STEEL
STAL NIERDZEWNA



YATO	size / rozmiar	PCS packing	
YT-1764	M5 x 0.8 x 6.7 mm	20	50/250
YT-1765	M6 x 1.0 x 10.8 mm	20	50/250
YT-1766	M8 x 1.25 x 10.8 mm	20	50/200
YT-1767	M10 x 1.5 x 13.5 mm	15	25/100
YT-1768	M12 x 1.75 x 16.3 mm	10	25/100

- GB Pressure gauge
D Druckanzeige
PL Wskaźnik ciśnienia
RUS Манометр
CZ Tlakomer
H Nyomásmérő
- RO Indicator de presiune
F Manomètre
I Manometro
E Manómetro
CN 压力计

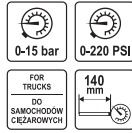

YATO
YT-24301 25/100

- GB Foot pump with gauge
D Fusspumpe
PL Pompka nożna z manometrem
RUS Насос ножный с манометром
CZ Nožní pumpa z manometrem
H Lábpumpa nyomásmérővel
RO Pompă de picior cu manometru
- F Pompe à pied avec manomètre
I Pompa a pedale con manometro
E Bomba de pierna con manometro
CN 打气筒



YATO
YT-7349 10



TWIN PISTON
PODWÓJNY TŁOK

YATO
YT-7350 10

- GB Car air compressor
D Auto-Kompressor
PL Kompresor samochodowy
RUS Автомобильный компрессор
CZ Automobilový kompresor
H Autókompresszor
RO Compresor auto
F Compresseur de voiture
I Compresore d'auto
E Compresor de coche
CN 车用充气泵



COLOR BOX



180 W 12 V 40 l/min
1.0 MPa 1m HOSE / IWAŻ 3m

LED

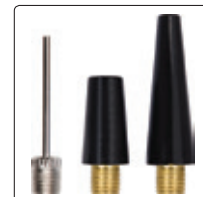

YATO W 8
YT-73460 180

- GB Hand pump with manometer
D Hand-Luftpumpe mit Manometer
PL Pompka słupkowa z manometrem
RUS Насос ручной с манометром
CZ Pumpa z manometrem
H Kézi pumpa manométerrel
RO Pompa de mana cu manometru
F Pompe manuelle avec manomètre
I Pompa verticale con manometro
E Bomba de barrote con manometro
CN 带压力表打气筒



YATO
YT-73521 3



YATO
YT-73530 3

- GB Car air compressor
- D Auto-Kompressor
- PL Kompresor samochodowy
- RUS Автомобильный компрессор
- CZ Automobilový kompresor
- H Autókompresszor
- RO Compresor auto
- F Compresseur de voiture
- I Compresore d'auto
- E Compresor de coche
- CN 车用充气泵



COLOR BOX



250 W	12 V	60 l/min
1.0 MPa	5m HOSE / WAŻ	3m

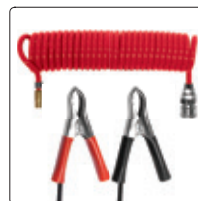
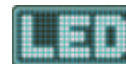

YATO	W	
YT-73462	250	4

- GB Oil jug
- D Ölkanne
- PL Nalewak warsztatowy
- RUS Лейка пластиковая с крышкой для СТО
- CZ Odměrka plastová - konev
- H Olajbetöltő kanna
- RO Recipient ulei
- F Broc verseur avec couvercle
- I Serbatoio
- E Jarra con pitorro de aceite
- CN 塑料油壶



POLYBAG

FOR AUTOMOTIVE FLUIDS DO PLYNÓW EKSPLOATACYJNYCH

FLEXI SPOUT ELASTYCZNY LEJEK

YATO	l	
YT-06980	1	48
YT-06983	3	40
YT-06985	5	16

- GB Oil jug
- D Ölkanne
- PL Nalewak warsztatowy
- RUS Лейка пластиковая с крышкой для СТО
- CZ Odměrka plastová - konev
- H Olajbetöltő kanna
- RO Recipient ulei
- F Broc verseur avec couvercle
- I Serbatoio
- E Jarra con pitorro de aceite
- CN 塑料油壶



POLYBAG

FOR AUTOMOTIVE FLUIDS DO PLYNÓW EKSPLOATACYJNYCH

PE

YATO	l	
YT-06987	10	8

- GB Funnel
- D Trichter
- PL Lejek
- RUS Воронка гибкая
- CZ Nálevka
- H Kétrészes tölcser
- RO Pálnie
- F Entonnoir
- I Imbuto
- E Embudo
- CN 漏斗

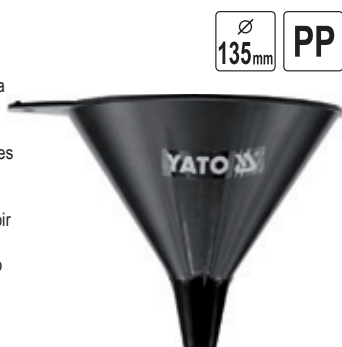

135mm PP

YATO	Ø (mm)	
YT-0694	135	192

- GB Long funnel
- D Trichter
- PL Lejek dlugi
- RUS Воронка гибкая
- CZ Nálevka
- H Kétrészes tölcser
- RO Pálnie
- F Entonnoir
- I Imbuto
- E Embudo
- CN 漏斗



120mm PP

YATO	L (mm)	Ø (mm)	
YT-0693	455	120	48

- GB Operating fluids funnel
- D Trichter
- PL Lejek do płynów eksploatacyjnych
- RUS Воронка гибкая
- CZ Nálevka
- H Kétrészes tölcser
- RO Pálnie
- F Entonnoir
- I Imbuto
- E Embudo
- CN 漏斗



100mm PP

YATO	Ø (mm)	
YT-0695	100	180

- GB Operating fluids funnel
- D Trichter
- PL Lejek do płynów eksploatacyjnych
- RUS Воронка гибкая
- CZ Nálevka
- H Kétrészes tölcser
- RO Pálnie
- F Entonnoir
- I Imbuto
- E Embudo
- CN 漏斗



240mm PP

YATO	Ø (mm)	
YT-0696	240	48

- GB Fuel and oil funnel
- D Trichter
- PL Lejek do paliwa i oleju
- RUS Воронка гибкая
- CZ Nálevka
- H Kétrészes tölcser
- RO Pálnie
- F Entonnoir pour essence et huile
- I Imbuto
- E Embudo
- CN 漏斗



150mm PP

YATO	Ø (mm)	
YT-0692	150	30

- GB Oil funnel
- D Trichter
- PL Lejek do oleju
- RUS Воронка гибкая
- CZ Nálevka
- H Kétrészes tölcser
- RO Pálnie
- F Entonnoir
- I Imbuto
- E Embudo
- CN 漏斗



280mm PP

YATO	Ø (mm)	
YT-0697	280	48

- GB** Pneumatic oil drain extractor
D Druckluft Ölabsauggerät /
Ölauffanggerät
PL Zlewarko-wysysarka
pneumatyczna
RUS Маслосборная
установка
пневматическая
CZ Pneumatická
odsávačka
vyjetého oleje
H Pneumatikus
fáradtolaj
gyűjtő / leszívó
RO Rezervor decantare
ulei uzat
F Récupérateur d'huile
par aspiration
I Aspiratore
-recuperatore
pneumatico

- E** Recuperador de aceite
de succión
CN 抽接油机

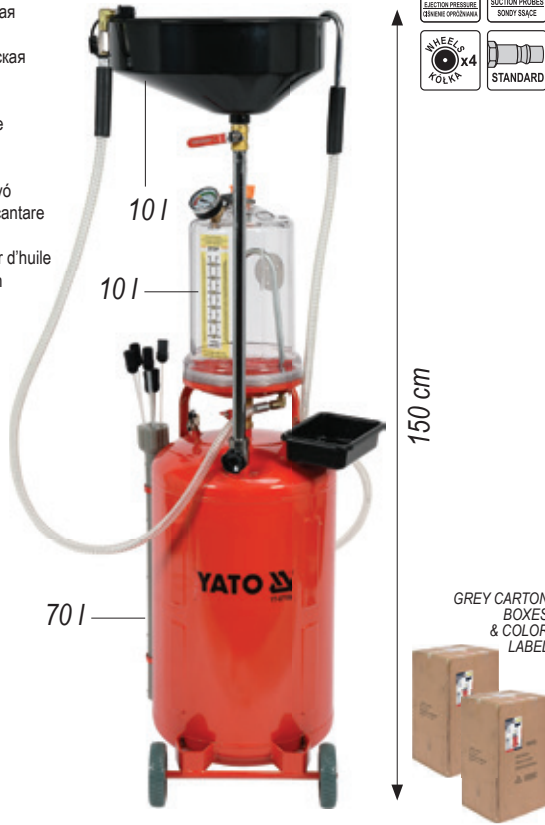

$L_{wA} = 101,2 \pm 3$ dB;
 $L_{wB} = 119,8 \pm 3$ dB

YATO	I	
YT-07190	90	1

- GB** Parts washer
D Teilwaschgerät
PL Myjka warsztatowa
RUS Стенд для очистки деталей
CZ Mycí stůl na součástky
H Alkatrészmosó

- RO** Cuva pt. spalat piese
F Fontaine de nettoyage pièces
I Idropulitrice per officina
E Lavadora piezas mecánicas
CN 零件清洗机

230V~
50Hz
80l
10
l/min
720x480
x260
mm
880
mm
FOR SOLVENT
WATER BASED
DO NOT USE
ON BASE WOOD



WHITE
CARTON BOX
& COLOR
LABEL

YATO	I	
YT-55808	80	1

- GB** Waste oil storage container
D Öl-Auffang-Kanister
PL Pojemnik zlewowy do oleju
RUS Контейнер отработанного масла
CZ Nádoba na použitý olej
H Fáradtolaj gyűjtő
RO Canistra colectare ulei
F Bidon de collecte d'huile

- I** Contenitore per la raccolta dell'olio
E Bidón cambio de aceite
CN 积油壶



YATO	I	size / rozmiar (cm)	
YT-06995	8	60x33x11	4

- GB** Oil drain pan
D Ölwanne
PL Miska do oleju
RUS Миска для масла
CZ Miska na olej
H Fáradtolaj felfogó edény
RO Recipient pt. ulei
F Bol à l'huile
I Vaschetta per cambio olio

- E** Escudilla para aceite
CN 接油盆



YATO	I	Ø (cm)	
YT-0699	7	37	48



YATO	I	Ø (cm)	
YT-0716	10	37	6
YT-0717	15	42	4

- GB** Oil drainer
D Öleinfüllanlage
PL Zlewarka do oleju
RUS Устройство
для слива масла
CZ Olejová nádrž
s odsáváním
H Fáradtolaj leszívó
RO Dispozitiv
pt. schimbat ulei
F Récupérateur d'huile
I Scolapiatti dell'olio
E Decantador
para aceite
CN 泄油器



75-155
cm
PE

WHITE
CARTON BOX
& COLOR
LABEL

YATO	I	Ø (cm)	
YT-0718	20	42	1

- GB Cordless drill / driver
D Akkuschauber-und-bohrer
PL Akumulatorowa wiertarko-wkrętarka
RUS Аккумуляторная дрель с шурупвертом
CZ Akumulátorový vrtací šroubovák
H Akkus fúrócsavarozók
RO Mașina de găurit / înșurubat cu acumulator
F Perceuse-visseuse sans-fil
I Trapano avvitatore a batteria
E Taladro / atornillador a batería
CN 充电式电钻

18 V Li-Ion 40 Nm 0-440 min⁻¹ 0-1650 min⁻¹

2.0 Ah 1h QUICK CHARGING SZYBKE ŁADOWANIE 13mm



18V Li-Ion

YATO	V	
YT-82780	18	5

- GB Cordless impact wrench
D Akku-DrehSchlagschrauber
PL Akumulatorowy klucz udarowy
RUS Аккумуляторный ударный гайковёрт
CZ Akumulátorový rázový utahovák
H Akkus ütvecsavarozó
RO Șurubelniță cu impact cu acumulator
F Boulonneuse sans-fil
I Chiave a percussione a batteria
E Atornillador de impacto a batería
CN 充电式冲击扳手

18 V Li-Ion 300 Nm 0-2200 rpm 0-2700 min⁻¹

1 1/2" 2.0 Ah 1h QUICK CHARGING SZYBKE ŁADOWANIE LED BATTERY INDICATOR WYPOSAŻENIE W WYKAZANĄ AKUMULACJĄ

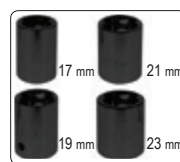

$L_{wz} = 84.0 \pm 3.0$ dB;
 $L_{max} = 95.0 \pm 3.0$ dB;
 $a_s = 9.09 \pm 1.5$ m/s²

18V Li-Ion

YATO	V	
YT-82804	18	4

- GB Cordless angle grinder
D Akku-Winkelschleifer
PL Akumulatorowa szlifierka kątowa
RUS Аккумуляторная угловая шлифмашина
CZ Akumulátorová úhlová bruska
H Akkus sarokcsiszoló
RO Polizor unghiular cu acumulator
F Meuleuse angulaire sans-fil
I Smeraglatrice angolare a batteria
E Amoladora angular a batería
CN 充电式角磨

18 V Li-Ion 10000 rpm 2.0 Ah 1h QUICK CHARGING SZYBKE ŁADOWANIE

125mm M14



$L_{wz} = 88.0 \pm 3.0$ dB;
 $L_{max} = 99.0 \pm 3.0$ dB;
 $a_s = 4.9 \pm 1.5$ m/s²

YATO	V	
YT-82826	18	4

- GB Cordless caulking gun
D Akku-Kartuschenpistole
PL Akumulatorowy wyciskacz do mas
RUS Аккумуляторный пистолет для герметика
CZ Akumulátorový protlačovač součástí na kostrové hmoty
H Akkus kinyomó vázas masszákhoz
RO Pistolet - storcător scheletic pt. mase în tub cu acumulator
F Pistolet a feutrer sans-fil
I Pistola applicatrice a batteria
E Pistola para massa a batería
CN 充电式填缝枪

COLOR BOX



18 V Li-Ion 4.0 Ah 2000 N 0.5-8 mm/s 225mm



$L_{wz} = 80.0 \pm 3.0$ dB;
 $L_{max} = 91.0 \pm 3.0$ dB;
 $a_s = 1.68 \pm 1.5$ m/s²

YATO	V	
YT-82888	18	5

- GB Battery charger
D Ladegerät
PL Ładowarka
RUS Зарядное устройство
CZ Nabíječka
RO Redresor
F Chargeur de batterie
- I Caricabatteria
E Rectificador
CN 充电器



for/dla: 18V Li-Ion

1h CHARGING ŁADOWANIE 2.0 Ah
1.5h CHARGING ŁADOWANIE 3.0 Ah
2h CHARGING ŁADOWANIE 4.0 Ah
3h CHARGING ŁADOWANIE 6.0 Ah

for / dla: YT-82830, YT-82831, YT-82832, YT-82833, YT-82834, YT-82835, YT-82836, YT-82837

YATO	V	
YT-82848	18	10

- GB Battery
D Akkumulator
PL Akumulator
RUS Аккумулятор
CZ Akumulátor
H Akkumulátor
RO Acumulator
F Batterie
I Batteria
E Bateria
CN 锂电池

18 V Li-Ion for/dla: Li-Ion



COLOR BOX



for / dla: YT-82830, YT-82831, YT-82832, YT-82833, YT-82834, YT-82835, YT-82836, YT-82837

YATO	V	capacity / pojemność (Ah)	charging time / czas ładowania (h)	
YT-82844	18	4.0	2.0	20

- GB** Cordless screwdriver
D Akku-schrauber
PL Wkrętak akumulatorowy
RUS Аккумуляторный шурупверт
CZ Akumulátorový utahovák
H Akkus csavarbehajtó
- RO** Șurubelniță cu acumulator
F Tournevis sans fil
I Avvitatore a batteria
E Herramienta de resistencia para soldar
CN 充电式螺丝批



3.6 V 1300 mAh Li-Ion	LED BATTERY INDICATOR MAGNETIC MOUNTING ACCUMULATOR	230 min ¹	3.0 Nm
WORKING AREA LIGHT OSWIEPLENIE OBSZARU PRACY			

COLOR BOX



$L_{PA} = 61.7 \pm 3.0$ dB;
 $L_{WA} = 72.7 \pm 3.0$ dB;
 $a_p = 0.39 \pm 1.5$ m/s²

YATO	V	
YT-82760	3.6	20

- GB** Cordless drill / driver
D Akkuschauber-und-bohrer
PL Akumulatorowa wiertarko-wkrętarka
RUS Аккумуляторная дрель с шурупвертом
CZ Akumulátorový vrtací šroubovák
H Akkus fűrésavarozók
- RO** Mașină de găurit / înșurubat cu acumulator
F Perceuse-visseuse sans-fil
I Trapano avvitatore a batteria
E Taladro / atornillador a batería
CN 充电式电钻

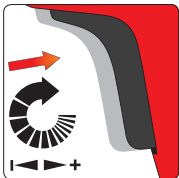

BMC & COLOR SLEEVE



$L_{PA} = 83.14 \pm 3.0$ dB;
 $L_{WA} = 94.14 \pm 3.0$ dB;
 $a_p = 2.390 \pm 1.5 / 1.146 \pm 1.5$ m/s²

YATO	V	
YT-82901	12	5

- GB** Cordless ratchet
D Akku-Ratsche
PL Grzechotka akumulatorowa
RUS Аккумуляторные импульсная трещотка
CZ Akumulátorový rázový utahovák
H Akkus ütvecsavarozó
RO Șurubelniță cu impact cu acumulator
F Clé à cliquet à batterie
I Cricchetto a batteria
E Llave de carraca a batería
CN 充电式扳手

12 V	Li-Ion	3/8" 10 mm	45 Nm
2.0 Ah	0-400 min ¹ / 0-1300 min ¹	0-250 min ¹	IMPACT FUNCTION FUNKCJA UDARU
1h QUICK CHARGING SYSTEM LAGORNIWE	0.8-10 mm	12, 13, 14, 17 mm	



COLOR BOX



$L_{PA} = 78.66 \pm 3.0$ dB;
 $L_{WA} = 89.66 \pm 3.0$ dB;
 $a_p = 2.898 \pm 1.5$ m/s²

YATO	V	
YT-82902	12	10

- GB** Cordless polisher
D Akku-Polierer
PL Polerka akumulatorowa
RUS Аккумуляторная полировальная машина
CZ Akumulátorový leštič
H Vezeték nélküli polírozó
RO Polisher cu acumulator
F Polisseuse sans fil
- I** Lucidatrice a batteria
E Batería pulidor
CN 充电式抛光机

12 V	Li-Ion	5/16" 8 mm	0-2800 min ¹ / 0-8300 min ¹
2.0 Ah	1h QUICK CHARGING SYSTEM LAGORNIWE	80 mm	



COLOR BOX



$L_{PA} = 78.6 \pm 3.0$ dB;
 $L_{WA} = 89.6 \pm 3.0$ dB;
 $a_p = 4.213 \pm 1.5$ m/s²



YATO	V	
YT-82903	12	5

- GB** Cordless sabre saw
D Akku-Säbelsäge
PL Akumulatorowa pila szablasta
RUS Аккумуляторная сабельная пила
CZ Akumulátorová pila oscakač
H Akkus szablyafűrész
RO Ferăstrău sabie cu acumulator
F Scie sabre sans-fil
I Sega a sciabola a batteria
E Sierra sable de batería
CN 充电式往复锯

12 V	Li-Ion	0-3000 min ¹	2.0 Ah	1h QUICK CHARGING SYSTEM LAGORNIWE
WOOD DREWING		STEEL	STAL	PVC



COLOR BOX



$L_{PA} = 83.58 \pm 3.0$ dB;
 $L_{WA} = 94.58 \pm 3.0$ dB;
 $a_p = 12.86 \pm 1.5 / 10.13 \pm 1.5 / 13.78 \pm 1.5 / 11.92 \pm 1.5$ m/s²

YATO	V	
YT-82904	12	6

GB Battery
D Akkumulator
PL Akumulator
RUS Аккумулятор
CZ Akumulátor
H Akkumulátor
RO Acumulatorul
F Batterie
I Batteria
E Bateria
CN 锂电池



12V 2.0 Ah
1h CHARGE CHARGING SZUKAJE ŁADOWANIE
Li-Ion

COLOR BOX



YATO	V	
YT-82909	12	40

GB Auto retract electric cable reel
D Elektro-Kabelaufroller mit automatischem Einzug
PL Przedłużacz elektryczny na zwiłaku automatycznym
RUS Электрический удлинитель на автоматическом барабане
CZ Elektrický prodlužovací kabel na automatickém navijáku
H Elektromos hosszabbító automatikus csévélével
RO Prelungitor electric retractabil
F Câble de rallonge électrique sur enrouleur automatique
I Prolunga elettrica con avvolgicavo automatico
E Prolongador eléctrico en enrollador automático
CN 电卷管器

10 A ~250V
CABLE HO5VV-F KABEL
3G1.5 mm² CABEL / KABEL
E & F TYPE / TYP
E TYPE / TYP
IP34
EASILY MOUNTS LATVY MONTAZ
x4 ANCHORS KOTWY



COLOR BOX



• $P_{max} = 2500 W$ coiled
 $P_{max} = 2500 W$ zwinięty
• $P_{max} = 2500 W$ uncoiled
 $P_{max} = 2500 W$ rozwinięty

YATO	L (m)	
YT-81220	10	4
YT-81221	20	2

GB LED rechargeable floodlight
D Akku-Diodenscheinwerfer
PL Reflektor diodowy akumulatorowy
RUS Светодиодный аккумуляторный прожектор
CZ LED reflektor dobijecí
H LED reflektor újratölthető
RO Reflector cu led dioda pe acumulatori
F Projecteur a LED rechargeable
I Lampada a LED a batteria
E LED reflector recargable
CN 工作灯

10W 3.7V 4400mAh Li-Ion
800 lm 6000 K
Micro USB CHARGING TIME CZAS ŁADOWANIA 5.5 h WORK TIME CZAS PRACY 2.5 h

COB LED



A++
A+
A



COLOR BOX

YATO	
YT-81820*	6/12

GB LED floodlight
D LED-Scheinwerfer
PL Reflektor diodowy
RUS Светодиодный прожектор
CZ LED světlo
H LED svetlomert
RO Reflector LED
F Projecteur a LED
I Lampada a LED
E LED projector
CN 手提式工作灯

10W 6V 4x AAA 680 lm 3 LIGHTING MODES TRYBY ŚWIECENIA
PA6 RESEALABLE WODNIOUSZCZALNE MAGNETIC

COB LED



A++
A+
A



COLOR BOX

• 3 lighting modes: 100%, 30%, strobe
• 3 tryby świecenia: 100%, 30%, pulsowanie

YATO	
YT-81821*	8/16

GB UV LED flashlight and glasses set
D UV LED-Taschenlampe mit UV Schutzbrille
PL Zestaw latarka UV LED i okulary
RUS Комплект для проверки утечек хладагента - УФ фонарь LED
CZ UV LED svítilna + brýle
H UV LED zseblampe + szemüveg
RO Set lanterna UV LED si ochelari
F UV LED lampe de poche avec lunettes
I Set torcia UV LED e occhiali
E UV LED linterna con gafas para
CN 手电筒

UV LED 51 LED UV 395 nm 1.5V 3x AA



COLOR BOX



YATO	
YT-08581	40

GB Workshop LED battery lamp
D LED Akku-handleuchte
PL Diodowa lampa warsztatowa akumulatorowa
RUS Светодиодная беспроводная лампа
CZ Ruční svítidla LED
H LED szerelő lámpák
RO Lampa portabila cu acumulator leduri
F Lampe a LED rechargeable
I Lampada LED per officina
E Linterna LED recargable
CN 可充莫歎鉗腑

CRI 95 **5W** **3.7V 2600mAh Li-Ion** **400 lm** **4500K**
COB LED
CHARGING TIME CZAS ŁADOWANIA 4h **WORK TIME CZAS PRACY 4h** **IP65**
IK07 **HOOK HAK** **2x**



A++
A+
A

HANGING COLOR BOX

YATO
YT-08509* 12



CRI 95
COLOR INSPECTION LAMP LAMPA DO INSPEKCJI LAKIERU

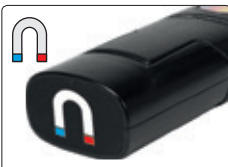
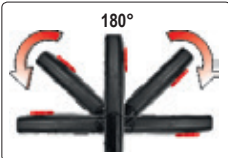

GB Workshop LED battery lamp
D LED Akku-handleuchte
PL Diodowa lampa warsztatowa akumulatorowa
RUS Светодиодная беспроводная лампа
CZ Ruční svítidla LED
H LED szerelő lámpák
RO Lampa portabila cu acumulator leduri
F Lampe a LED rechargeable
I Lampada LED per officina
E Linterna LED recargable
CN 可充莫歎鉗腑

FRONT LIGHTING FUNKCJA LATARNI **1+1 LED** **3.7V 3600mAh Li-Ion** **180 lm**
230V~50Hz BATTERY CHARGER ŁADOWNIKA **12V BATTERY CHARGER ŁADOWNIKA**
CHARGING TIME CZAS ŁADOWANIA 4h **WORK TIME CZAS PRACY 3h 2 LED**
HOOK HAK

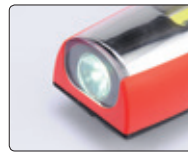

A++
A+
A

HANGING COLOR BOX

YATO
YT-08502* 10

GB Workshop LED battery lamp
D LED Akku-handleuchte
PL Diodowa lampa warsztatowa akumulatorowa
RUS Светодиодная беспроводная лампа
CZ Ruční svítidla LED
H LED szerelő lámpák
RO Lampa portabila cu acumulator leduri
F Lampe a LED rechargeable
I Lampada LED per officina
E Linterna LED recargable
CN 可充莫歎鉗腑

FRONT LIGHTING FUNKCJA LATARNI **2W** **3.7V 1100mAh Li-Ion** **200 lm**
CHARGING TIME CZAS ŁADOWANIA 2.5 h **WORK TIME CZAS PRACY 2.5 h**
USB BATTERY CHARGER ŁADOWNIKA **IP54** **HOOK HAK**
POLYCARBONATE DIFFUSER KULISE Z POLIWĘGLANU **x2**

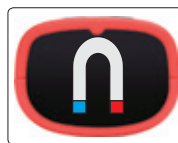

A++
A+
A

HANGING COLOR BOX

YATO
YT-08501* 20

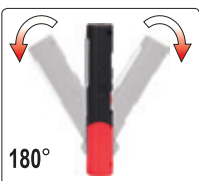

GB Workshop LED battery lamp
D LED Akku-handleuchte
PL Diodowa lampa warsztatowa akumulatorowa
RUS Светодиодная беспроводная лампа
CZ Ruční svítidla LED
H LED szerelő lámpák
RO Lampa portabila cu acumulator leduri
F Lampe a LED rechargeable
I Lampada LED per officina
E Linterna LED recargable
CN 可充莫歎鉗腑

FRONT LIGHTING FUNKCJA LATARNI **3W** **3.7V 2200mAh Li-Ion** **350 lm**
CHARGING TIME CZAS ŁADOWANIA 4h **WORK TIME CZAS PRACY 3.5 h**
USB BATTERY CHARGER ŁADOWNIKA **IP54** **HOOK HAK**
POLYCARBONATE DIFFUSER KULISE Z POLIWĘGLANU **x2**



A++
A+
A

HANGING COLOR BOX

YATO
YT-08560* 12

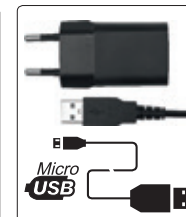
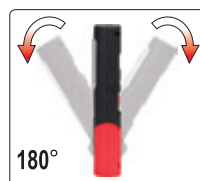

- GB Workshop LED battery lamp
- D LED Akku-handleuchte
- PL Diodowa lampa warsztatowa akumulatorowa
- RUS Светодиодная беспроводная лампа
- CZ Ruční svítidla LED
- H LED szerelő lámpák
- RO Lampa portabila cu acumulator leduri
- F Lampe a LED rechargeable
- I Lampada LED per officina
- E Linterna LED recargable
- CN 可充莫歎釘腑

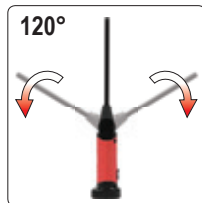

A++
A+
A



FRONT LIGHTING FUNKCJA LATORNI	5+3 W	3.7V 2600mAh Li-Ion	CHARGING TIME CZAS ŁADOWANIA 4h
600/260 lm	6500 K	USB BATTERY CHARGER ŁADOWARKA	WORK TIME CZAS PRACY 2.5/5.5 h
POLYCARBONATE DIFFUSER KŁOSZ Z POLIESTEREM		MAGNETIC	

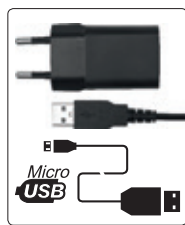

YATO
YT-08518* 12

- GB Workshop LED battery lamp
- D LED Akku-handleuchte
- PL Diodowa lampa warsztatowa akumulatorowa
- RUS Светодиодная беспроводная лампа
- CZ Ruční svítidla LED
- H LED szerelő lámpák
- RO Lampa portabila cu acumulator leduri
- F Lampe a LED rechargeable
- I Lampada LED per officina
- E Linterna LED recargable
- CN 可充莫歎釘腑

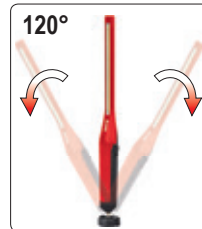
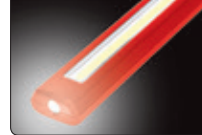
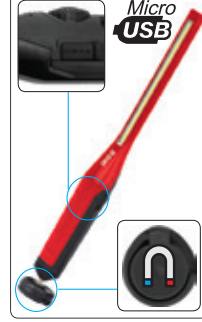

A++
A+
A



FRONT LIGHTING FUNKCJA LATORNI	7+3 W	3.7V 2600mAh Li-Ion	4.5h CHARGING TIME CZAS ŁADOWANIA
60-600 lm	6500 K	USB BATTERY CHARGER ŁADOWARKA	1.5-16.5h WORK TIME CZAS PRACY
LED CHARGE INDICATOR WSKAZNIK NAŁADOWANIA BATERII		POLYCARBONATE DIFFUSER KŁOSZ Z POLIESTEREM	

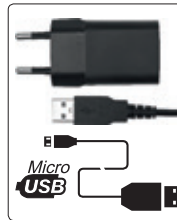

HANGING
COLOR BOX

YATO
YT-08519* 20

- GB Workshop LED battery lamp
- D LED Akku-handleuchte
- PL Diodowa lampa warsztatowa akumulatorowa
- RUS Светодиодная беспроводная лампа
- CZ Ruční svítidla LED
- H LED szerelő lámpák
- RO Lampa portabila cu acumulator leduri
- F Lampe a LED rechargeable
- I Lampada LED per officina
- E Linterna LED recargable
- CN 可充莫歎釘腑



A++
A+
A



FRONT LIGHTING FUNKCJA LATORNI	5+1 W	3.7V 2600mAh Li-Ion	CHARGING TIME CZAS ŁADOWANIA 4h
500/250lm 120lm	6500 K	USB BATTERY CHARGER ŁADOWARKA	WORK TIME CZAS PRACY 2.5-7h
POLYCARBONATE DIFFUSER KŁOSZ Z POLIESTEREM		HOOK HAK	



YATO
YT-08562* 12

- GB Workshop LED battery lamp
- D LED Akku-handleuchte
- PL Diodowa lampa warsztatowa akumulatorowa
- RUS Светодиодная беспроводная лампа
- CZ Ruční svítidla LED
- H LED szerelő lámpák
- RO Lampa portabila cu acumulator leduri
- F Lampe a LED rechargeable
- I Lampada LED per officina
- E Linterna LED recargable
- CN 可充莫歎釘腑

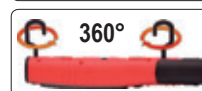
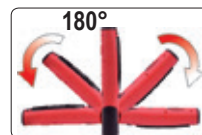

A++
A+
A



FRONT LIGHTING FUNKCJA LATORNI	3.5+3 W	3.7V 2200mAh Li-Ion	CHARGING TIME CZAS ŁADOWANIA 4h
280 lm	6000 K	USB BATTERY CHARGER ŁADOWARKA	WORK TIME CZAS PRACY 3.5 h
POLYCARBONATE DIFFUSER KŁOSZ Z POLIESTEREM		HOOK HAK x2	

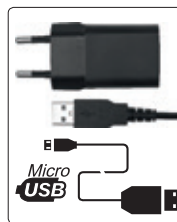

YATO
YT-08508* 12

GB Workshop LED battery lamp
D LED Akku-handleuchte
PL Diodowa lampa warsztatowa akumulatorowa
RUS Светодиодная беспроводная лампа
CZ Ruční svítidla LED
H LED szerelő lámpák
RO Lampa portabila cu acumulator leduri
F Lampe a LED rechargeable
I Lampada LED per officina
E Linterna LED recargable
CN 可充裝款鉗嘴

FRONT LIGHTING
FUNKCJA LATARNI

30+7 LED

140 lm

3.7V 2000mAh Li-Ion

USB BATTERY CHARGER
ŁADOWNIKA

WORK TIME
CZAS PRACY
4h

CHARGING TIME
CZAS ŁADOWNIA
4h

x3

x2 HOOK HAK

POLYCARBONATE DIFFUSER
KŁOSZ Z PC I ACRYLANU

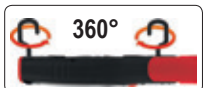
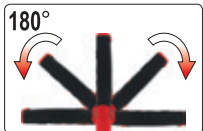

A++
A+
A

YATO
YT-08507* 12

GB Workshop LED battery lamp
D LED Akku-handleuchte
PL Diodowa lampa warsztatowa akumulatorowa
RUS Светодиодная беспроводная лампа
CZ Ruční svítidla LED
H LED szerelő lámpák
RO Lampa portabila cu acumulator leduri
F Lampe a LED rechargeable
I Lampada LED per officina
E Linterna LED recargable
CN 可充裝款鉗嘴

FRONT LIGHTING
FUNKCJA LATARNI

1+7 LED

250 lm

3.7V 1800mAh Li-Ion

12V BATTERY CHARGER
ŁADOWNIKA

CHARGING TIME
CZAS ŁADOWNIA
4h

WORK TIME
CZAS PRACY
4h

x2 HOOK HAK

x2



COB
LED



COLOR BOX



A++
A+
A

YATO
YT-08504* 10

GB Workshop LED battery lamp
D LED Akku-handleuchte
PL Diodowa lampa warsztatowa akumulatorowa
RUS Светодиодная беспроводная лампа
CZ Ruční svítidla LED
H LED szerelő lámpák
RO Lampa portabila cu acumulator leduri
F Lampe a LED rechargeable
I Lampada LED per officina
E Linterna LED recargable
CN 可充裝款鉗嘴

FRONT LIGHTING
FUNKCJA LATARNI

30+7 LED

85 lm

3.7V 1800mAh Li-Ion

12V BATTERY CHARGER
ŁADOWNIKA

230V~50Hz BATTERY CHARGER
ŁADOWNIKA

CHARGING TIME
CZAS ŁADOWNIA
4-5 h

WORK TIME
CZAS PRACY
15h 7LED

WORK TIME
CZAS PRACY
4h 30LED

x2 HOOK HAK

x2



LED



COLOR BOX



A++
A+
A

YATO
YT-08505* 10

GB LED workshop lamp
D LED Werkstattlampe
PL Diodowa lampa warsztatowa
RUS Светодиодная беспроводная лампа
CZ Montážní lampa
H LED lámpa
RO Lampa cu LED
F Lampe d'atelier a LED
I Lampada LED per autofficina
E Lámpara de taller LED
CN 可充裝款鉗嘴

FRONT LIGHTING
FUNKCJA LATARNI

27 LED

13000 MCD

3.6V 1200mAh Ni-MH

12V BATTERY CHARGER
ŁADOWNIKA

230V~50Hz BATTERY CHARGER
ŁADOWNIKA

CHARGING TIME
CZAS ŁADOWNIA
4h

WORK TIME
CZAS PRACY
4h

WATER PROOF
ODPORNA NA WODĘ

CHARGING TIME
CZAS ŁADOWNIA
4h

HOOK HAK

MAGNETIC



LED

DOUBLE BLISTER



A++
A+
A

YATO
YT-08523* 10

GB LED workshop lamp
D LED Werkstattlampe
PL Diodowa lampa warsztatowa
RUS Светодиодная беспроводная лампа
CZ Montážní lampa
H LED szerelő lámpák
RO Lampa cu LED
F Lampe d'atelier a LED
I Lampada LED per autofficina
E Lámpara de taller LED
CN 可充養駁釘脩



60+1 LED	13000 MCD	7.2V 800mAh NEMH	230V~ 50Hz BATTERY CHARGER LADOWARKA
WORK TIME CZAS PRACY 4h	CHARGING TIME CZAS ŁADOWANIA 4h	WATER PROOF ODPORNĄ NA WODĘ	HOOK HAK
12V BATTERY CHARGER ŁADOWARKA	HOOK HAK	MAGNETIC	

LED

DOUBLE
BLISTER



YATO
YT-0852* 5/20

GB LED workshop lamp
D LED Werkstattlampe
PL Diodowa lampa warsztatowa
RUS Светодиодная лампа
CZ Montážní lampa
H LED szerelő lámpák
RO Lampa cu LED
F Lampe d'atelier a LED
I Lampada LED per autofficina
E Lámpara de taller LED
CN 可充養駁釘脩



8+1 LED	280 lm	3 LIGHTING OPTIONS SPECIE ŚWIECZENIA	FRONT LIGHTING FENÉCSÚJÁRÓ
WORK TIME CZAS PRACY 4 h 9 LED	1.5V 3x AA	HOOK HAK	MAGNETIC

SMD
LED



COLOR
BOX



YATO
YT-08513* 50

GB LED workshop lamp
D LED Werkstattlampe
PL Diodowa lampa warsztatowa
RUS Светодиодный светильник для мастерской
CZ Montážní lampa
H LED szerelő lámpák
RO Lampa cu LED
F Lampe d'atelier a LED
I Lampada LED per autofficina
E Lámpara de taller LED
CN 可充養駁釘脩



8 LED	80 lm	1.5V 3x AAA	WORK TIME CZAS PRACY 20 h 8 LED
-----------------	-----------------	---------------------------------	--

SMD
LED

SLIDING
CARD



YATO
YT-08514* 12/72

GB LED workshop lamp
D LED Werkstattlampe
PL Diodowa lampa warsztatowa
RUS Светодиодная лампа LED
CZ Montážní lampa
H LED szerelő lámpák
RO Lampa cu LED
F Lampe d'atelier a LED
I Lampada LED per autofficina
E Lámpara de taller LED
CN 可充養駁釘脩



4 LED	400 lm	IP65	CABLE H05RN-F KABEL
230V~ 50Hz	HOOK HAK	4.9m	

POWER
LED



YATO
YT-08531* 10

GB Workshop LED battery lamp
D LED Akku-handleuchte
PL Diodowa lampa warsztatowa akumulatorowa
RUS Светодиодная лампа LED

CZ Ruční svítlna LED
H LED szerelő lámpák
RO Lampa portabila cu acumulator leduri
F Lampe a LED rechargeable

I Lampada LED trasportabile per illuminazione di vani motore
E Linterna LED recargable
CN 引擎盖检修灯

SMD
LED

100 LED	600 lm	7.4V 2000mAh Li-Ion	230V~50Hz BATTERY CHARGER LADÓVÁRKA
CHARGING TIME CZAS ŁADOWANIA 3-4 h	WORK TIME CZAS PRACY 4 h 100 LED	HOOK HAK	MAGNETIC



A++
A+
A

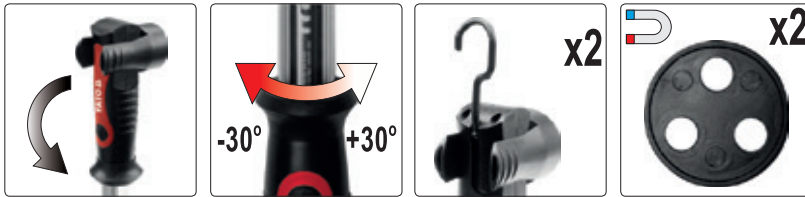

GB Workshop LED battery lamp
D LED Akku-handleuchte
PL Diodowa lampa warsztatowa akumulatorowa
RUS Светодиодная лампа LED

CZ Ruční svítlna LED
H LED szerelő lámpák
RO Lampa portabila cu acumulator leduri
F Lampe a LED rechargeable

I Lampada LED trasportabile per illuminazione di vani motore
E Linterna LED recargable
CN 引擎盖检修灯

LED

350 lm	60 LED	120 LED	7.2V 1800mAh Ni-MH	230V~50Hz BATTERY CHARGER LADÓVÁRKA
120 LED	WORK TIME CZAS PRACY 8 h 60 LED	WORK TIME CZAS PRACY 4h 120LED	CHARGING TIME CZAS ŁADOWANIA 4-5 h	HOOK HAK
MAGNETIC				



A++
A+
A

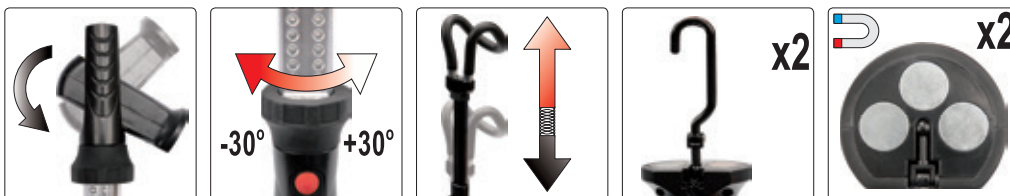

GB Workshop LED battery lamp
D LED Akku-handleuchte
PL Diodowa lampa warsztatowa akumulatorowa
RUS Светодиодная лампа LED

CZ Ruční svítlna LED
H LED szerelő lámpák
RO Lampa portabila cu acumulator leduri
F Lampe a LED rechargeable

I Lampada LED trasportabile per illuminazione di vani motore
E Linterna LED recargable
CN 引擎盖检修灯

SMD
LED

36 LED	18 LED	36 LED	7.4V 2400mAh Li-Ion	230V~50Hz BATTERY CHARGER LADÓVÁRKA
900 lm	CHARGING TIME CZAS ŁADOWANIA 5.5 h	WORK TIME CZAS PRACY 3.5 h	HOOK HAK	MAGNETIC



A++
A+
A

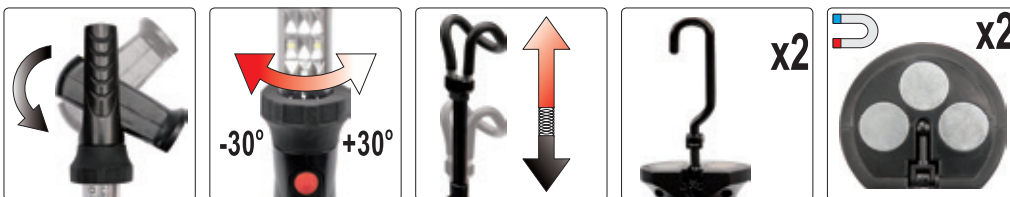

GB Workshop LED battery lamp
D LED Akku-handleuchte
PL Diodowa lampa warsztatowa akumulatorowa
RUS Светодиодная лампа LED

CZ Ruční svítlna LED
H LED szerelő lámpák
RO Lampa portabila cu acumulator leduri
F Lampe a LED rechargeable

I Lampada LED trasportabile per illuminazione di vani motore
E Linterna LED recargable
CN 引擎盖检修灯

SMD
LED

12W	1200 lm	4000 K	230V~50Hz	CABLE H05RN-F KABEL
5m	2x 1.0mm²	POLYCARBONATE DIFFUSER KLÓZSÉ Z POLIKARBONÁTU	HOOK HAK	IP54



A++
A+
A



- GB LED head lamp
- D LED kopflampe
- PL Diodowa lampka czołowa
- RUS Налобный светодиодный фонарь
- CZ LED montážní lampa - čelovka
- H LED fejlámpa
- RO Lampa cu LED
- F Lampe frontale LED
- I Lampada da testa
- E Linterna de diodo
- CN LED头灯

10W **XM-L2** **450 lm** **3x** **6V 4x AAA**



DOUBLE BLISTER

YATO	W	lm	
YT-08591	10	450	6/24

- GB LED head lamp
- D LED kopflampe
- PL Diodowa lampka czołowa
- RUS Налобный светодиодный фонарь
- CZ LED montážní lampa - čelovka
- H LED fejlámpa
- RO Lampa cu LED
- F Lampe frontale LED
- I Lampada da testa
- E Linterna de diodo
- CN LED头灯

3W **100 lm** **3x** **1.5V 3x AAA**

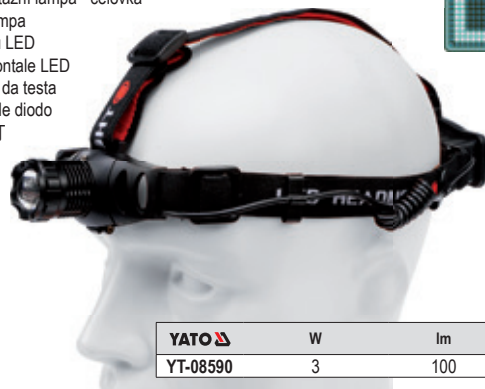

SLIDING CARD

YATO	W	lm	
YT-08590	3	100	50/100

- GB Digital voltage tester
- D Digitaler-Spannungsprüfer
- PL Wskaźnik elektryczny
- RUS Тестер напряжения цифровой
- CZ Zkoušečka napětí digitální
- H Digitális voltmérő
- RO Tester digital pt. tensiune electrica

- F Testeur de tension type tournevis
- I Cerca fase digitale
- E Indicador eléctrico de número
- CN 数显测电笔

SLIDING CARD **12-250 V** **50-500 Hz** **TEST** **LED DISPLAY WYŚWIETLACZ**



NO BATTERY NEEDED
NIE POTRZEBUJE BATERII

YATO		
YT-2861		20/500



LED NO BATTERY NEEDED
NIE POTRZEBUJE BATERII

YATO		
YT-2862		20/500



LED POWER SOURCE: 3x1.5V LR41 BATTERY

YATO		
YT-28630		6/120

- GB Automotive circuit tester
- D KFZ Prüflampe
- PL Wskaźnik elektryczny samochodowy
- RUS Пробник напряжения автомобильный
- CZ Zkoušečka napětí autoelektrikářská
- H Autóvillamosság teszter
- RO Tester pt. circuite auto
- F Testeur de tension de voiture
- I Tester elettrico per auto
- E Indicador eléctrico de coche
- CN 汽车测电笔

SLIDING CARD **CABLE KABEL 90 cm** **LED**



6-24 V

YATO		
YT-2865		25/250



6-12 V

YATO		
YT-2866		10/100



W skład oprawy wchodzi wbudowane lampy LED



LED

Nie można wymieniać lamp LED w oprawie.

874/2012



- YT-81820
- YT-81821
- YT-81812
- YT-81860
- YT-81855
- YT-81856
- YT-81880
- YT-08509
- YT-08502
- YT-08501
- YT-08560
- YT-08518
- YT-08519
- YT-08562
- YT-08508
- YT-08507
- YT-08504
- YT-08505
- YT-08523
- YT-0852
- YT-08513
- YT-08514
- YT-08531
- YT-08503
- YT-08530
- YT-08533
- YT-08532

- GB Electronic battery charger
D Elektronisches Ladegerät
PL Prostownik elektroniczny
RUS Электронное зарядное устройство
CZ Elektronická nabíječka
- H Elektronikus akkumulátortöltő
RO Redresor electric
F Chargeur de batterie voiture
I Avviatore elettronico
E Rectificador electrónico
CN 蓄电池充电器



COLOR BOX

6 V	1 A	200 Ah	220-240V~	WET	MOKRY	MICROPROCESSOR
12 V	4 A	max	50Hz	GEL	ZELOWY	AGM



YATO	
YT-8300	8



12 V	4 A
------	-----

5-120 Ah	220-240V~
	50Hz

WET	MOKRY	MICROPROCESSOR
GEL	ZELOWY	AGM

HANGING
COLOR BOX
WITH WINDOW



6 V	4 A
-----	-----

5-120 Ah	220-240V~
	50Hz

WET	MOKRY	MICROPROCESSOR
GEL	ZELOWY	AGM

HANGING
COLOR BOX
WITH WINDOW



YATO	
YT-83031	30

YATO	
YT-83032	30

- GB Electronic battery charger
D Elektronisches Ladegerät
PL Prostownik elektroniczny
RUS Электронное зарядное устройство
- CZ Elektronická nabíječka
H Elektronikus akkumulátortöltő
RO Redresor electric
F Chargeur de batterie voiture
- I Avviatore elettronico
E Rectificador electrónico
CN 蓄电池充电器

6 V	1 A
12 V	4 A

120 Ah	220-240V~
max	50/60Hz

WET	MOKRY
GEL	ZELOWY
AGM	AGM

MICROPROCESSOR	LCD
	DISPLAY
	WYŚWIETLACZ

ALTERNATOR	STARTER
TEST	TEST
ALTERNATORA	ROZRUSZNIKA



HANGING
COLOR BOX



6 V	8 A
12 V	

5-200 Ah	220-240V~
	50Hz

WET	MOKRY	MICROPROCESSOR
GEL	ZELOWY	AGM

YATO	
YT-83033	20

YATO	
YT-8301	8



COLOR BOX



12 V	12 A
------	------

6-200 Ah	220-240V~
	47-63 Hz

MICROPROCESSOR	WET
	MOKRY

COLOR
BOX



12 V

15 A	6-200 Ah
------	----------

220-240V~	WET
47-63 Hz	GEL
	AGM

MOKRY	MICROPROCESSOR
ZELOWY	
AGM	

YATO	
YT-8302	8

YATO	
YT-8303	8



COLOR
BOX



GB Battery charger with boost function
D Ladegerät mit Boost-Funktion
PL Prstownik z funkcją wspomagania ładowania
RUS Выпрямитель с функцией поддержки зарядки

CZ Nabíječky s funkcií boost
H Akkumulátortöltő boost funkció
RO Redresor baterie cu functie boost
F Chargeur de batterie voiture support boost

I Carica batterie con boost
E Cargador de baterías arrancador boost
CN 充电器

COLOR BOX



230V~50Hz
12V
24V



16 A 120-240 Ah WET MOKRY

25 A 170-350 Ah WET MOKRY

YATO	
YT-8304	2

YATO	
YT-8305	2



15 A 10-300 Ah WET MOKRY AGM BOOST ROZRUCH 12V 75A MICROPROCESSOR

30 A MICROPROCESSOR 50-600 Ah WET MOKRY AGM BOOST ROZRUCH 12V 145A

YATO	
YT-83051	2

YATO	
YT-83052	2

GB Battery charger with engine start-up supporting function
D Ladegerät mit Starthilfe
PL Prstownik z funkcją wspomagania rozruchu
RUS Выпрямитель с функцией поддержки запуска
CZ Nabíječky s funkcií startovani motoru
H Akkumulátortöltő indító

RO Redresor cu functie de pornire de sprijin
F Chargeur de batterie voiture support demarrage
I Carica batterie carrellato con funzione di avviatore rapido
E Cargador de baterías arrancador
CN 充电器启动机

COLOR BOX



230V~50Hz WET MOKRY

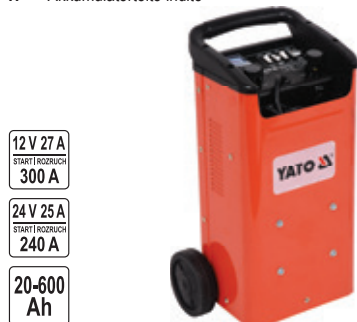

12V 27 A START/ROZRUCH 300 A
24V 25 A START/ROZRUCH 240 A
20-600 Ah

12V 32 A START/ROZRUCH 390 A
24V 31 A START/ROZRUCH 360 A
20-700 Ah

12V 38 A START/ROZRUCH 540 A
24V 35 A START/ROZRUCH 450 A
20-800 Ah

YATO	
YT-83060	1

YATO	
YT-83061	1

YATO	
YT-83062	1

GB Jump starter power bank
D Multifunktions-Startgerät
PL Urządzenie rozruchowe wielofunkcyjne
RUS Портативное пусковое-зарядное устройство
CZ Power banka s možností nastartování auta
H Indító bikázó starter
RO Acumulator extern pt. pornire motor si incarcare
F Portable demarreur batterie voiture booster
I Dispositivo di avviamento multifunzione
E Coche portátil salto de arranque
CN 应急电源



COLOR BOX



200 A 400 A PEAK / SZCZYT
USB 5V / 2A
Li-Po
JUMP START ROZRUCH SILNIKA
FRONT LIGHTS (FUNCCIA LAMPY)



7500 mAh 2h QUICK CHARGING

9000 mAh 12V / 3.5A OUTPUT WYJSCIE 3h QUICK CHARGING

YATO	
YT-83080	20

YATO	
YT-83081	10

GB Power inverter
D Spannungswandler
PL Przetwornica napięcia
RUS Автомобильный инвертор
CZ Měníč napětí
H Feszültség átalakító

RO Convertor de tensiune
F Convertisseur de tension
I Inverter di corrente
E Convertidor de voltaje
CN 逆变器

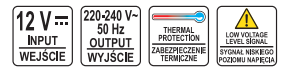
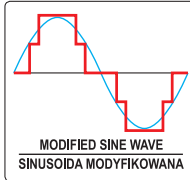

500 W 1000 W PEAK SZCZYT.

800 W 1600 W PEAK SZCZYT.

YATO		
YT-81490	12	

YATO		
YT-81491	12	

GB Jumpstart wires
D Starterkabel
PL Przewody rozruchowe
RUS Пусковые провода
CZ Startovací kabely

H Indító kábelek
RO Cabluri demarare
F Câbles de démarrage

I Cavi carica batteria
E Cables de arranque
CN 输出线

WINDOW BAG WITH ZIPPER

2.5m



YATO	rated load / obciążenie nominalne (A)	
YT-83151	200	12

YATO	rated load / obciążenie nominalne (A)	
YT-83152	400	12

YATO	rated load / obciążenie nominalne (A)	
YT-83153	600	12

GB Analogue battery tester
D Analoges Batterieprüfgerät
PL Tester akumulatorów analogowy
RUS Аналоговый тестер аккумуляторов
CZ Analogový tester akumulátorů
H Analóg akkuszeszter
RO Tester acumulatori analog
F Testeur de charge batterie
I Tester analogico per batteria
E Tester analógico para acumuladores
CN 电池测试器

COLOR BOX



6 V

12 V

CCA 200-1000 A



YATO		
YT-8310	10	

GB Digital battery tester
D Digitales Batterieprüfgerät
PL Tester akumulatorów cyfrowy
RUS Цифровой тестер аккумуляторов
CZ Digitální tester akumulátorů
H Digitális akkuszeszter
RO Tester acumulatori digital
F Testeur digital de charge batterie
I Tester digitale per batteria
E Tester digital para acumuladores
CN 电池测试器

COLOR BOX



12 V

LED DISPLAY WYŚWIETLACZ

CCA 150-1400 A



YATO		
YT-8311	10	

GB Battery tester
D Batterieprüfgerät
PL Tester akumulatorów
RUS Тестер аккумуляторов
CZ Tester akumulátorů
H Akkuszeszter
RO Tester acumulatori
F Testeur électronique de charge batterie et alternateur
I Tester per batteria
E Tester para acumuladores
CN 电池测试器

DOUBLE BLISTER



12 V

BATTERY TEST TEST AKUMULATORA
ALTERNATOR TEST TEST ALTERNATORA



YATO		
YT-83101	12/72	

- GB Digital battery analyzer
- D Elektronischer Batterietester
- PL Elektroniczny tester akumulatorów
- RUS Электронный тестер аккумуляторов
- CZ Elektrický tester autobaterií
- H Elektronikus akkumulátor tesztelő

- RO Tester acumulatori
- F Testeur électronique pour accumulateurs
- I Tester elettronico per batterie
- E Comprobador electrónico de acumuladores
- CN 电池测试仪

12V

CCA 200-1200 A

ALTERNATOR TEST TEST ALTERNATORA

STARTER TEST TEST ROZKURZNIKA

LED DISPLAY WYŚWIETLACZ



DOUBLE BLISTER

YATO		
YT-83113		6/48

- GB OBD II multilingual scan tool
- D OBD II-Diagnosegerät
- PL Tester diagnostyczny OBD II
- RUS Диагностический тестер OBD II
- CZ Diagnostický tester OBD II
- H OBD II hibakód olvasó tesztelő

- RO Tester diagnoza auto OBD II
- F Appareil de diagnostic OBD II
- I Strumento diagnostico OBD2
- E Comprobador de diagnóstico OBD II
- CN 多语言汽车读码卡

OBD II CAN

DTC

LCD DISPLAY WYŚWIETLACZ



DOUBLE BLISTER

YATO		
YT-72977		10/60

- GB Refractometer
- D Refraktometer
- PL Refraktometr
- RUS Рефрактометр
- CZ Refraktometr
- H Fagyálló fokoló
- RO Refractometrul
- F Réfractomètre
- I Rifrattometro
- E Refractometro
- CN 冰点仪



+

~

W

PLASTIC BOX & COLOR SLEEVE



YATO		
YT-06722		25

- GB Chain block
- D Kettenzug Flaschenzug
- PL Wciągarka łańcuchowa
- RUS Таль цепная
- CZ Zvedák řetězový
- H Láncos csigásor emelő
- RO Scripete cu lant
- F Treuil à chaîne
- I Paranco a catena
- E Cabria de cadena
- CN 手拉葫芦

3m



GREY CARTON BOX & COLOR LABEL



YATO	max. load capacity / max. ładowność (kg)	
YT-58950	500	1
YT-58951	1000	1
YT-58953	2000	1
YT-58954	3000	1
YT-58955	5000	1

PLYWOOD BOX & COLOR LABEL



YATO		
YT-58957	10000	1

- GB Lever block
- D Kettenzug Hebelzug
- PL Wciągnik łańcuchowy
- RUS Таль ручная рычажная
- CZ Kladkostroj díl
- H Emelő robusztus
- RO Bloc de pârghie
- F Bloc de levier
- I Paranco a catena
- E Bloque de palanca
- CN 手扳葫芦

1.5m



GREY CARTON BOX & COLOR LABEL



YATO	max. lifting capacity / max. udźwig (kg)	
YT-58962	750	1
YT-58964	1500	1
YT-58966	3000	1
YT-58967	6000	1

PLYWOOD BOX & COLOR LABEL



YATO		
YT-58968	9000	1

- GB Electric hoist
D Elektro-Seilwinde
PL Elektryczny wciągarnik linowy
RUS Электрическая канатная лебедка
CZ Elektrický naviják kladkostroj
H Elektromos csőrő
RO Troliu electric cu cablu
F Treuil électrique à corde
I Verricello elettrico
E Cabria eléctrica de cuerdas
CN 电动葫芦



COLOR BOX



230V~
50Hz



500 W		
$L_{pA} = 52,2 \pm 1,2$ dB; $L_{wA} = 73,6 \pm 2,31$ dB		
YATO W		
YT-5901	500	2

550 W		
$L_{pA} = 52,0 \pm 0,9$ dB; $L_{wA} = 75,4 \pm 4,80$ dB		
YATO W		
YT-5902	550	2

900 W		
$L_{pA} = 54,0 \pm 0,9$ dB; $L_{wA} = 78,0 \pm 6,57$ dB		
YATO W		
YT-5904	900	2

1050 W		
$L_{pA} = 58,9 \pm 1,9$ dB; $L_{wA} = 79,9 \pm 2,79$ dB		
YATO W		
YT-5905	1050	2

- GB Rope winch
D Handseilwinde
PL Wyciągarka linowa

- RUS Канатная лебедка
CZ Lanové vyťahovací zařízení
H Drótkóteles csőrő

- RO Troliu cu cablu orizontal
F Treuil à corde
I Paranco a corda

- E Cabria de cuerdas
CN 繩索拉緊器

COLOR BOX



1000
daN

YATO	daN	L (m)	Ø (mm)	Box
YT-5911	1000	3	5	6



1300
daN

YATO	daN	L (m)	Ø (mm)	Box
YT-5913	1300	3	5	6

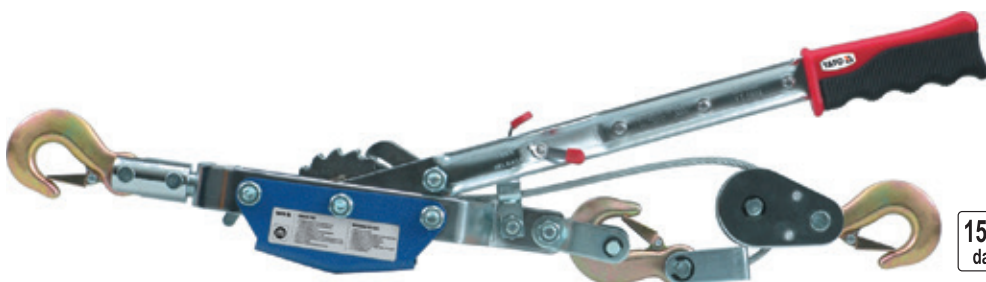

1500
daN

YATO	daN	L (m)	Ø (mm)	Box
YT-5914	1500	3	6	3

- GB Transmission jack
- D Hydraulische Getriebeheber
- PL Podnośnik skrzyni biegów
- RUS Домкрат для коробки передач
- CZ Pojízdný zvedák motorů a převodovek
- H Sebességváltó emelő tartó
- RO Cric cutii de viteza
- F Levage des moteurs et des boîtes de vitesses
- I Sollevatore scatola del cambio
- E Motor de transmisión telescópica
- CN 坡道

500 kg max.

1945 mm
1140 mm

PRECISION VALVE
PRECYZYJNY ZAWÓR



GREY CARTON BOX & COLOR LABEL

YATO
YT-55600 1

- GB Shop crane
- D Werkstattkran
- PL Żuraw warsztatowy
- RUS Кран подкатной гидравлический
- CZ Hydraulický jeřáb
- H Motorkiemelő zsráf

- RO Girafa pt. scos motor
- F Grue d'atelier
- I Gru idraulica
- E Grúa hidráulica para motores
- CN 吊机

GREY CARTON BOX & COLOR LABEL



1000 kg

YATO
YT-55556 1



210cm max



2000 kg

YATO
YT-55557 1



230cm max

- GB Shop press
- D Hydraulische Werkstattpresse
- PL Prasa hydrauliczna
- RUS Гидравлический пресс
- CZ Hydraulický lis
- H Hidraulikus prés
- RO Presa hidraulic
- F Presse hydraulique

- I Pressa idraulica
- E Prensa de hidráulica
- CN 压力机

GREY CARTON BOX & COLOR LABEL

12t

0-695 mm

400 mm



YATO
YT-55580 1

20t

0-695 mm

490 mm



YATO
YT-55581 1

30t

0-795 mm

520 mm



YATO
YT-55582 1

- GB** Engine suspension beam
D Aufnahmeverrichtung des Motors
PL Belka do podwieszenia silnika
RUS Балка для вывешивания двигателя
CZ Nosník k zavěšení motoru
H Motorfelfüggesztő gerenda

- RO** Grindă pt. suspendarea motorului
F Poutre de suspension de moteur
I Fascio sospensione del motore
E La viga para suspender el motor
CN 发动机平衡架

500kg
max.

150
cm

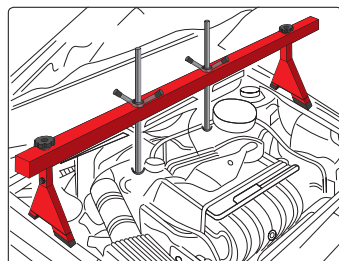
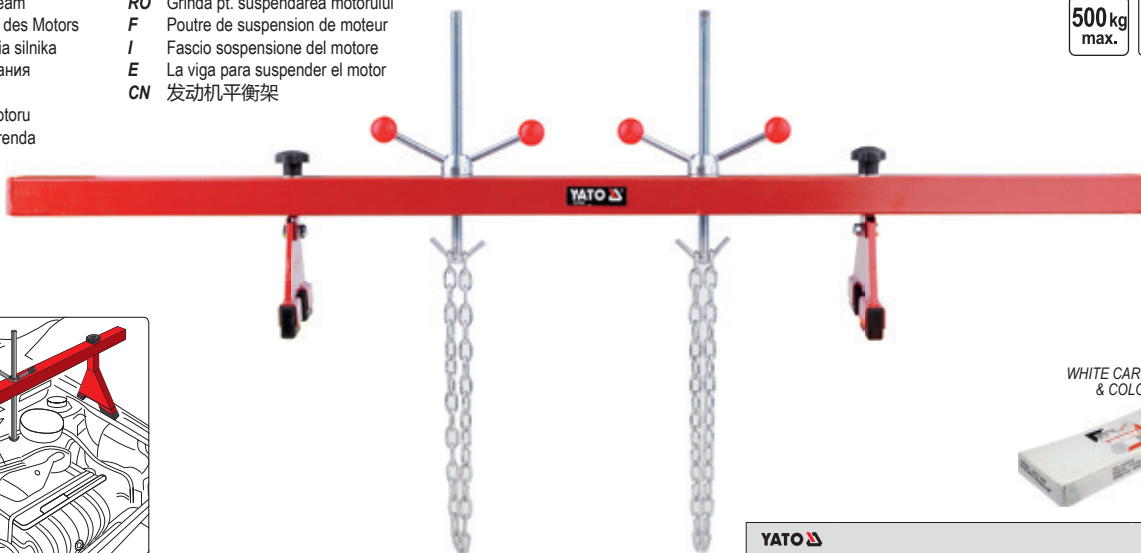

WHITE CARTON BOX
& COLOR LABEL



YATO 	
YT-55568	1

- GB** Crane crossbeam
D Traverse zum Kran
PL Trawers do żurawia
RUS Траверса для крана
CZ Jefábóvá traverza
H Traverz a zsiráf emelőhöz
RO Traversă pt. macara
F Balancier pour grue d'atelier
I Traverse per gru
E Viga transversal para grua
CN 平衡器

680
kg

315
mm

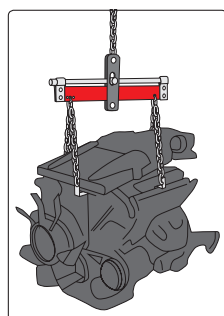

WHITE CARTON BOX
& COLOR LABEL



YATO 	
YT-55565	1

- GB** Engine stand
D Motorständer
PL Stojak do silnika
RUS Стойка для ремонта двигателя
CZ Stojan na motor
H Motorszerelő állvány

- RO** Suport pt. motor
F Support moteur
I Cavalletto per motore
E Soporte de motor
CN 发动机支架

450
kg

STEEL WHEELS
x4

360°



GREY
CARTON BOX
& COLOR LABEL



YATO 	
YT-55570	1

- GB** Air wedge
D Luft Keil
PL Poduszka montażowa
RUS Монтажная подушка для установки окон и дверей
CZ Zvedací vzduchové měchy
H Emelőpárna
RO Perna de aer
F Coussin élévateur
I Cuscino di montaggio
E Cojines elevadores
CN 门窗安装气囊



COLOR BOX



0-50
mm

TPU

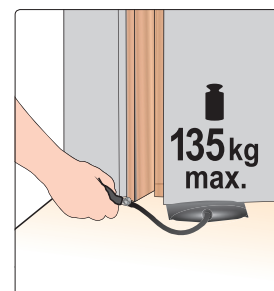

YATO 	
YT-67380	24

GB Hydraulic bottle jack
D Hydraulischer Stempelwagenheber
PL Podnośnik hydrauliczny słupkowy
RUS Домкрат гидравлический
CZ Pístový zvedák hydraulický
H Hidraulikus emelő

RO Cric hidraulic
F Elévateur
I Cric idraulico a bottiglia
E Gato de embolo hidr.
CN 立式液压千斤顶

COLOR BOX

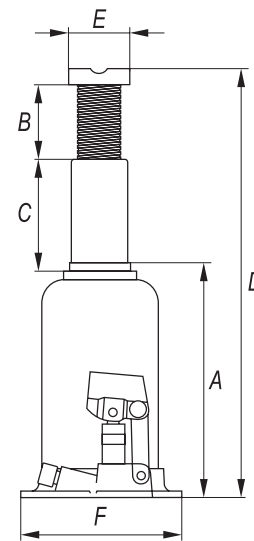
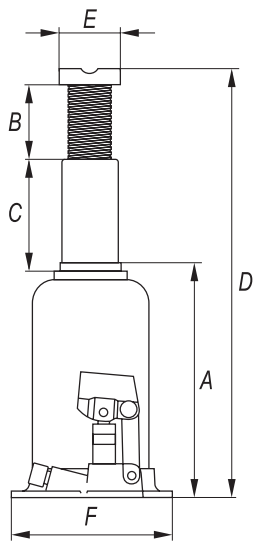

YATO	T	A (mm)	B (mm)	C (mm)	D (mm)	E (mm)	F (mm)	
YT-17000	2	181	48	164	345	25	88x92	6
YT-17001	3	194	60	180	374	27	92x100	6
YT-17002	5	216	60	180	413	29	96x110	4
YT-17003	8	230	80	147	457	32	103x118	2
YT-17004	10	230	80	150	460	36	110x123	2
YT-17005	12	230	80	155	465	40	116x134	2
YT-17006	15	230	82	150	462	43	140x134	2
YT-17007	20	242	60	150	452	45	144x150	2
YT-17008	32	285	-	180	465	69	190x152	1
YT-17009	50	300	-	180	480	83	218x176	1

YATO	T	A (mm)	B (mm)	C (mm)	D (mm)	E (mm)	F (mm)	
YT-17015	2	172	88	112	372	28	103x105	4
YT-1702	5	212	110	146	468	40	110x112	5
YT-17025	8	220	115	153	488	45	124x127.5	2
YT-1704	10	220	115	148	483	48	124x127.5	3
YT-17045	12	230	115	160	505	45	130x136	2
YT-1706	15	231	113	154	498	56	140x142	2
YT-1707	20	241	115	165	521	60	165x161	2
YT-17075	25	240	110	160	510	65	186x174	1
YT-1709	30	244	108	140	492	65	186x174	1

GB Two-piston hydraulic bottle jack
D Hydraulischer Stempelwagenheber
PL Podnośnik hydrauliczny słupkowy dwutłokowy

RUS Домкрат гидравлический
CZ Pístový zvedák hydraulický
H Hidraulikus emelő
RO Cric hidraulic

F Elévateur deux niveaux
I Cric idraulico a bottiglia
E Gato de embolo hidr.
CN 液压双级千斤顶

COLOR BOX

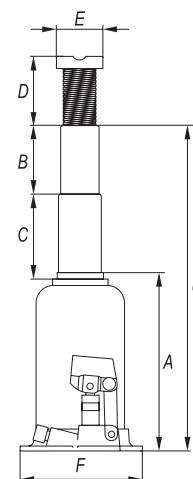
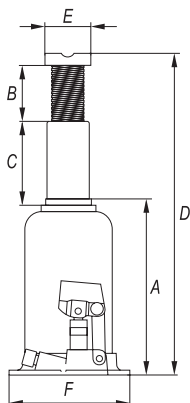

YATO	T	A (mm)	B (mm)	C (mm)	D (mm)	E (mm)	F (mm)	
YT-1711	5	220	146	138	500	41	130x136	2
YT-1713	10	128	63	38	223	47	160x165	2

YATO	T	A (mm)	B (mm)	C (mm)	D (mm)	E (mm)	F (mm)	G (mm)	
YT-1714	10	208	120	118	78	48	165x161	442	1
YT-1715	12	236	138	128	98	56	186x174.5	498	1

GB Hydraulic floor jack
D Hydraulischer Rangierwagenheber
PL Podnośnik hydrauliczny

RUS Домкрат гидравлический
CZ Pístový zvedák hydraulický

H Krokodil emelő
RO Cric tip crocodil
F Elévateur hydraulique
I Sollevatore idraulico

E Gato de embolo hidr.
CN 卧式液压千斤顶



ULTRA LIGHT

2t
359 mm
↑
89 mm

BMC & COLOR SLEEVE



2.5t
465 mm
↑
100 mm
DUAL PUMP
PODWÓJNA POMPA
QUICK LIFT
SZYBKIE PODNOSZENIE
AI



COLOR BOX

YATO	T	
YT-1720	2	1

YATO	T	
YT-17205	2.5	1



LOW PROFILE

2.5t
520 mm
↑
85 mm
DUAL PUMP
PODWÓJNA POMPA
QUICK LIFT
SZYBKIE PODNOSZENIE
LOW PROFILE
NISKI PROFIL



2.5t
457 mm
↑
89 mm



YATO	T	
YT-17207	2.5	1

YATO	T	
YT-1721	2.5	1



3t
465 mm
↑
130 mm
LOW PROFILE
NISKI PROFIL



3t
500 mm
↑
145 mm



YATO	T	
YT-17211	3	1

YATO	T	
YT-17213	3	1

GB Farm jack
D Bauernhof-Jack
PL Podnośnik farmerski
RUS Домкрат механический, реечный

CZ Zvedák farm jack
H Hi-jack fogasléces off-road emelő
RO Cric mecanic tip off-road
F Vérins mécaniques commerciales

I Farm jack - sollevatore di auto
E Elevación mecánicas comerciales
CN 农夫顶



3t



GREY
CARTON BOX
& COLOR LABEL



700 mm
130 mm



1070 mm
130 mm



1350 mm
155 mm

YATO	T	
YT-17260	3	1

YATO	T	
YT-17261	3	1

YATO	T	
YT-17262	3	1

GB Vehicle ramp
D Auffahrrampe
PL Najazd samochodowy
RUS Мини эстакада для автомобиля
CZ Nájezd na auto
H Felhajtó rámpa
RO Rampa auto
F Rampe pour voiture
I Rampa per veicoli
E Rampa para coches
CN 运送顶



1
PC

1000
kg

815x305
x200mm

POLYBAG

YATO	size / rozmiar (mm)	
YT-55670	815x305x200	10

GB Jack stand
D Unterstellböcke
PL Podstawka pod samochód
RUS Подставка под автомобиль
CZ Podstavec pod auto
H Gépkocsi alátét
RO Chituc de metal
F Paire de chandelles
I Coppia cavalletti
E Apoyos de coche
CN 千斤顶支架

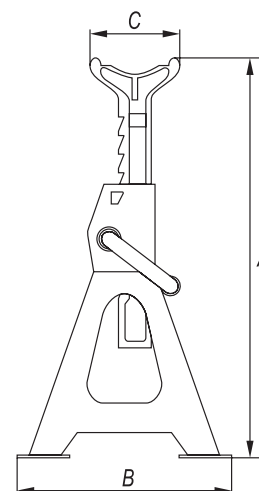

COLOR
BOX



YATO	T	A (mm)	B (mm)	C (mm)	PCS packing:	
YT-17310	2	265-415	190x165	77x40	2	1
YT-17311	3	280-420	182x201	85x29	2	1
YT-17312	6	382-600	258x285	100x29	2	1

- GB** Self locking nuts assortment
D Sortiment Muttern metrisch mit Sicherheit
PL Zestaw nakrętek metrycznych z zabezpieczeniem
RUS Набор гаек самоконтрящиеся, с нейлоновой вставкой
CZ Šestihránné matice s bezpečností
- H** Nuts metrikus menet biztonságí
RO Set piulite autoblocante
F Hex écrou set avec la sécurité
I Set di autobloccanti metrica dadi
E Porcas rosca métrica com a segurança
CN 146件套螺母组套



M4, M5, M6, M8, M10, M12



- GB** Metric nuts assortment
D Sortiment Muttern metrisch
PL Zestaw nakrętek metrycznych
RUS Набор гаек
CZ Šestihránné matice
H Nuts metrikus menet
- RO** Set piulite
F Hex écrou set
I Set di metrica dadi
E Porcas rosca métrica
CN 300件套螺母组套



M3, M4, M5, M6, M8, M10



- GB** Stainless steel nuts assortment
D Sortiment Muttern metrisch rostfrei
PL Zestaw nakrętek metrycznych nierdzewnych
RUS Набор гаек шестигранных нержавеющей
CZ Nerezové oceli šestihránné matice
- H** Nuts metrikus menet rozsdamentes
RO Set piulite inox
F Hex écrou set inoxydable
I Set di acciaio inossidabile metrica dadi
E Rosca métrica tuerca inoxidable
CN 300件套不锈钢螺母组套

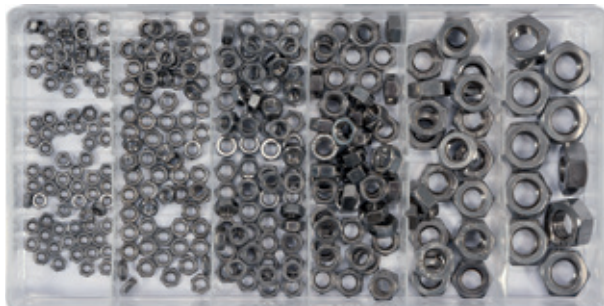

M3, M4, M5, M6, M8, M10



- GB** Hex nut with top assortment
D Sortiment Muttern metrisch geschlossen
PL Zestaw nakrętek metrycznych kołpakowych
RUS Набор гаек колпачковых
CZ Šestihránné matice zavřeno
H Nuts metrikus menet zárt
- RO** Set piulite inchise
F Hex écrou set fermé
I Set di dadi campana-metrica
E Rosca métrica tuercas cerrado
CN 150件套不锈钢螺母组套

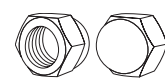
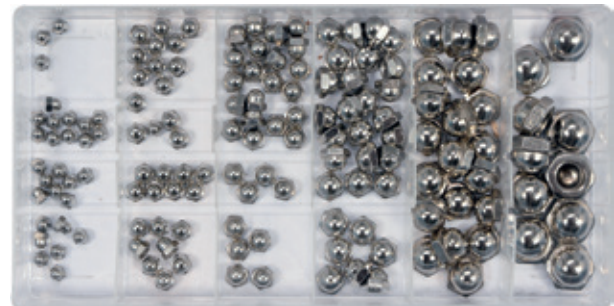

M3, M4, M5, M6, M8, M10



- GB** Metric wing nut assortment
D Sortiment Flügelmuttern
PL Zestaw nakrętek motylkowych
RUS Набор гаек типа «барашек»
CZ Křídlaté matice lisované
H Szárnyas anya
RO Set piulite fluture
F Assortiment d'écrous papillon
I Set di metrica dadi
E Tuercas con orejas
CN 蝶形螺母



PLASTIC HANGING BOX

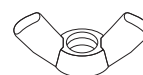

M4, M5, M6, M8, M10



GB Aluminium washer set
D Aluminium Dichtring Sortiment
PL Zestaw podkładek aluminiowych
RUS Набор алюминиевых шайб

CZ Sada hliníkových podložek
H Réz alátét készlet
RO Set saibe aluminiu
F Assortiment de joints en aluminium

I Set di rondelle in alluminio
E Juego de arandelas de aluminio para tapones
CN 300件套铝垫片

PLASTIC BOX



300
PCS

MIX
SIZE
ROZMIARÓW

METRIC
METRYCZNE

Al



 10x 5x9x1.0 mm	 10x 8x14x1.5 mm	 10x 12x16x1.0 mm	 10x 14x20x1.5 mm	 10x 18x24x1.5 mm	 10x 22x29x1.5 mm
 10x 6x10x1.0 mm	 10x 9x14x1.0 mm	 10x 12x16x1.5 mm	 10x 14x20x2.0 mm	 10x 20x24.5x1.5 mm	 10x 24x29x1.5 mm
 10x 6x12x1.0 mm	 10x 10x14x1.0 mm	 10x 12x18x1.5 mm	 10x 16x20x1.5 mm	 10x 20x24.5x0.8 mm	 10x 24x32x2.0 mm
 10x 8x12x1.0 mm	 10x 10x14x1.5 mm	 10x 13x18x1.0 mm	 10x 16x22x1.5 mm	 10x 19x26x2.0 mm	 10x 26x34x2.0 mm
 10x 8x14x1.0 mm	 10x 10x16x1.0 mm	 10x 14x18x1.5 mm	 10x 18x22x1.5 mm	 10x 22x27x1.0 mm	 10x 28x36x2.0 mm

5x9x1.0 mm, 8x14x1.5 mm, 12x16x1.0 mm, 14x20x1.5 mm, 18x24x1.5 mm, 22x29x1.5 mm, 6x10x1.0 mm, 9x14x1.0 mm, 12x16x1.5 mm, 14x20x2.0 mm, 20x24.5x1.5 mm, 24x29x1.5 mm, 6x12x1.0 mm, 10x14x1.0 mm, 12x18x1.5 mm, 16x20x1.5 mm, 20x24.5x0.8 mm, 24x32x2.0 mm, 8x12x1.0 mm, 10x14x1.5 mm, 13x18x1.0 mm, 16x22x1.5 mm, 19x26x2.0 mm, 26x34x2.0 mm, 8x14x1.0 mm, 10x16x1.0 mm, 14x18x1.5 mm, 18x22x1.5 mm, 22x27x1.0 mm, 28x36x2.0 mm

YATO
YT-06865

5/20

GB Copper washer set
D Kupfer Dichtring Sortiment
PL Zestaw podkładek miedzianych
RUS Набор колец медных

CZ Podložky měděné těsnící
H Réz tömítés készlet
RO Saibe din cupru
F Patins en cuivre

I Set di spessori
E Arandelas de cobre
CN 件套紫铜垫片

PLASTIC
HANGING BOX



150
PCS

MIX
SIZE
ROZMIARÓW

Cu



 5x10x1 mm 10 pcs	 8x11x1 mm 10 pcs	 11x17x1.5 mm 10 pcs	 12.5x20x1.5 mm 10 pcs	 15x20x2 mm 10 pcs	 16.5x24x2 mm 10 pcs
 6x10x1 mm 10 pcs	 10x16x1 mm 10 pcs	 14x18x1 mm 10 pcs	 14x20x1.5 mm 10 pcs	 16x22x2 mm 10 pcs	 17.5x24x2 mm 10 pcs
 7x10x1 mm 10 pcs	 10.5x17x1.5 mm 10 pcs	 12x20x1.5 mm 10 pcs	 14x20x1.5 mm 10 pcs	 16x22x2 mm 10 pcs	 17.5x24x2 mm 10 pcs

5x10x1.0 mm, 6x10x1.0 mm, 7x10x1.0 mm, 8x11x1.0 mm, 10x16x1.0 mm, 10.5x17x1.5 mm, 11x17x1.5 mm, 14x18x1.0 mm, 12x20x1.5 mm, 12.5x20x1.5 mm, 14x20x1.5 mm, 15x20x2.0 mm, 16x22x2.0 mm, 16.5x24x2.0 mm, 17.5x24x2.0 mm

YATO
YT-06871

5/20

GB Copper washer set
D Kupfer Dichtring Sortiment
PL Zestaw podkładek miedzianych
RUS Набор колец медных

CZ Podložky měděné těsnící
H Réz tömítés készlet
RO Saibe din cupru
F Patins en cuivre

I Set di spessori
E Arandelas de cobre
CN 件套紫铜垫片

PLASTIC BOX



300
PCS

MIX
SIZE
ROZMIARÓW

METRIC
METRYCZNE

SOFT
TYPE
MIEKKI
MATERIAL

Cu

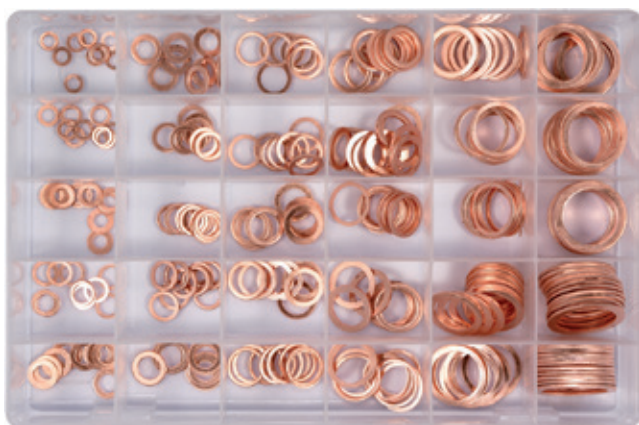

 10x 5x9x1.0 mm	 10x 8x14x1.5 mm	 10x 12x16x1.0 mm	 10x 14x20x1.5 mm	 10x 18x24x1.5 mm	 10x 22x29x1.5 mm
 10x 6x10x1.0 mm	 10x 9x14x1.0 mm	 10x 12x16x1.5 mm	 10x 14x20x2.0 mm	 10x 20x24.5x1.5 mm	 10x 24x29x1.5 mm
 10x 6x12x1.0 mm	 10x 10x14x1.0 mm	 10x 12x18x1.5 mm	 10x 16x20x1.5 mm	 10x 20x24.5x0.8 mm	 10x 24x32x2.0 mm
 10x 8x12x1.0 mm	 10x 10x14x1.5 mm	 10x 13x18x1.0 mm	 10x 16x22x1.5 mm	 10x 19x26x2.0 mm	 10x 26x34x2.0 mm
 10x 8x14x1.0 mm	 10x 10x16x1.0 mm	 10x 14x18x1.5 mm	 10x 18x22x1.5 mm	 10x 22x27x1.0 mm	 10x 28x36x2.0 mm

5x9x1.0 mm, 8x14x1.5 mm, 12x16x1.0 mm, 14x20x1.5 mm, 18x24x1.5 mm, 22x29x1.5 mm, 6x10x1.0 mm, 9x14x1.0 mm, 12x16x1.5 mm, 14x20x2.0 mm, 20x24.5x1.5 mm, 24x29x1.5 mm, 6x12x1.0 mm, 10x14x1.0 mm, 12x18x1.5 mm, 16x20x1.5 mm, 20x24.5x0.8 mm, 24x32x2.0 mm, 8x12x1.0 mm, 10x14x1.5 mm, 13x18x1.0 mm, 16x22x1.5 mm, 19x26x2.0 mm, 26x34x2.0 mm, 8x14x1.0 mm, 10x16x1.0 mm, 14x18x1.5 mm, 18x22x1.5 mm, 22x27x1.0 mm, 28x36x2.0 mm

YATO
YT-06872

5/20

- GB** Anti-vibration washer assortment
D Fächerscheiben, gezahnt
PL Zestaw podkładek koronkowych
RUS Набор корончатых шайб
CZ Sada vějířových podložek
H Koronás alátét készlet
RO Saibe autoblocante
F Jeu de rondelles dentelées
E Juego de arandelas dentadas
CN 防松垫片



200
PCS

MIX
SIZE
ROZMĚRŮV

3-19
mm

PLASTIC
HANGING
BOX



50 PCS x 3mm, 40 PCS x 4mm, 30 PCS x 5mm, 25 PCS x 6mm, 18 PCS x 8mm,
12 PCS x 9.5mm, 13 PCS x 12mm, 7 PCS, x 16mm, 5 PCS x 19mm

YATO
YT-06863 24

- GB** Copper gasket & oil drain plug assortment
D Öllassschraube Kupfer Schrauben und O-Ringe
PL Zestaw podkładek miedzianych i korków spustowych
RUS Набор медных шайб и сливных пробок поддона двигателя
- CZ** Sada měděných podložek a zátek pro olejové vypustě
H Olajteknő csavar és rézalátét készlet
RO Set busoane baie ulei
F Boulons de carter d'huile & assortiment bagues

- I** Set di rondelle in rame a spine
E Tornillos y juntas para tapon de carter
CN 534PC油封

PLASTIC BOX



534
PCS

MIX
SIZE
ROZMĚRŮV

Cu



50x 6 mm	50x 8 mm	50x 10 mm	50x 12 mm	50x 13 mm	50x 14 mm
50x 15 mm	50x 16 mm	50x 18 mm	50x 20 mm	5x M8x1	5x M10x1
5x M12x1.5	5x G1/4	5x M14x1.5	3x M10x1.5	3x M18x1.5	3x M20x1.5

6 mm, 8 mm, 10 mm, 12 mm, 13 mm, 14 mm, 15 mm, 16 mm, 18 mm, 20 mm;
M8x1.0, M10x1.0, M12x1.5, M14x1.5, M16x1.5, M18x1.5, M20x1.5; G1/4

YATO
YT-06864 10

- GB** Bodywork nuts & screws assortment
D Sortiment Karosseriemuttern mit Schrauben
PL Zestaw wkrętów i podkładek do karoserii
RUS Набор саморезов и металлических клипс для кузовных работ
CZ Tělo matice a šroub kit
- H** Karosszéria csavar és anya készlet
RO Set asamblare clema / holsuruburi
F Assortiment de vis et d'écrous cage
I Set viti e rondelle al corpo
E Body kit tornillo
CN 170件套螺丝U型圈组套

PLASTIC
HANGING
BOX

170
PCS

MIX
SIZE
ROZMĚRŮV



- GB** Clevis pin assortment
D Bolzen mit Kopf
PL Zestaw sworzni z łbem i otworem
RUS Набор штифтов с отверстиями под шплинт
- CZ** Čep s hlavou
H Csapszeget kit
RO Set bolturi pt. securizare
F Axe de chape
I Set di perni con testa e il foro
E Kit de pasador de horquilla
CN 60PC销柱

PLASTIC
HANGING
BOX

60
PCS

MIX
SIZE
ROZMĚRŮV

5-12
mm



M3, M4, M5, M6;

M3x8 mm, M4x16 mm,
M5x12 mm, M6x20 mm

YATO
YT-06780 5/20



5x25 mm, 6x25 mm, 6x30 mm, 6x40 mm, 6x45 mm, 6x50 mm, 6x60 mm, 6x65 mm,
8x25 mm, 8x30 mm, 8x40 mm, 8x45 mm, 8x50 mm, 8x60 mm, 8x65 mm, 8x70 mm,
10x25 mm, 10x40 mm, 10x50 mm, 12x40 mm, 12x50 mm

YATO
YT-06786 4/16

GB Metric nuts & bolts assortment
D Metric Mutter und Bolzen Sortiment
PL Zestaw śrub, nakrętek, podkładek i wkretów

RUS Набор винты / гайки / болты / шайбы
CZ Sada šroubů, matic, podložek
H Csavarkészlet
RO Set suruburi / piulite

F Ecrous et boulons métrique assortiment
I Set di viti, dadi, rondelle e viti
E Tuercas y tornillos métrica surtido
CN 347PC机丝自攻

PLASTIC
HANGING BOX



347
PCS

MIX
SIZE
ROZMIARÓW



 32x 3 x 12 mm	 26x 3 x 20 mm	 13x 5 x 24 mm	 43x 2.5 x 12 mm	 32x 3 x 19 mm	 10x 4 x 24 mm
 59x M5	 19x M6	 19x M5 x 25 mm	 24x M5 x 20 mm	 11x M6 x 20 mm	 49x M5

3x12 mm, 3x20 mm, 5x24 mm; 2.5x12 mm, 3x19 mm, 4x24 mm;
M5, M6; M5x20 mm, M5x25 mm, M6x20 mm; M5, M6

YATO
YT-06771 6/24

GB Metal tiller tin pin assortment
D Set Splinte und Bolzen mit Kopf und Löchern
PL Zestaw zawleczek i sworzni z łbem i otworami

RUS Набор шплинтов и болтов с головкой и отверстиями
CZ Sada závlaček a šroubů s hlavou a otvory
H Saszeg és fejes, nyílásos csaszeg készlet
RO Set bolturi cu sigurante
F Jeu de goupilles et d'axes avec têtes et des trous
E Juego de pasadores y pernos con cabeza y aberturas
CN 八孔销



56
PCS

MIX
SIZE
ROZMIARÓW

8-13
mm

PLASTIC
HANGING BOX



5 PCS (8 x 50mm), 15 PCS (9.5 x 50mm), 5 PCS (11 x 64mm),
3 PCS (13 x 50mm), PIN: 5 PCS (2 x 30mm),
15 PCS (2.5 x 40mm), 5 PCS (2.5 x 40mm), 3 PCS (3 x 44mm)

YATO
YT-06874 20

GB Grease nipple set
D Schmiernippel
PL Zestaw smarowniczek
RUS Набор масленок

CZ Sady mazacích hlavíc
H Zsírözögomb (zsírözöfejj) készlet
RO Set gresoare metalice
F Set de graisseurs métriques

I Set grasso capezzoli
E Engrasador
CN 件套黄油嘴组套

PLASTIC
HANGING BOX



110
PCS

METRIC
METRYCZNE



 60 pcs	 5 pcs	 10 pcs	 5 pcs	 5 pcs	 10 pcs
	 5 pcs	 5 pcs	 5 pcs		

M6x1, M6x1 45°, M6x1 90°, M8x1, M8x1 45°, M8x1 90°, M10x1, M10x1 45°, M10x1 90°

YATO
YT-06888 5/20

GB Spring assortment
D Schraubenfeder Sortiment
PL Zestaw sprężynek
RUS Набор пружин оцинкованных

CZ Sada pružin
H Rugó készlet
RO Arcuri tensiune
F Assortiment ressorts

I Set di molle
E Caja surtido de de resortes
CN 件套弹簧组套

PLASTIC
HANGING BOX



200
PCS

MIX
SIZE
ROZMIARÓW



 10 pcs	 6 pcs	 12 pcs	 8 pcs	 10 pcs
 10 pcs	 8 pcs	 12 pcs	 10 pcs	 10 pcs
 10 pcs	 10 pcs	 12 pcs	 10 pcs	 10 pcs
 10 pcs	 10 pcs	 12 pcs		

YATO
YT-06875 5/20

GB Aluminium rivet assortment
D Aluminium Blindnieten
Sortiment
PL Zestaw aluminiowych nitów zrywalnych
RUS Набор заклепок
CZ Sada hliníkových nitů

H Csöves alumínium szegecsék
RO Set popnîtur
F Rivets tubulaires en aluminium
I Set di rivetto alluminio
E Remaches tubulares de aluminio
CN 400件套铆钉组套

PLASTIC
HANGING
BOX

400
PCS

MIX
SIZE
ROZMIAROW

AI

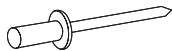

2.4, 3.2, 4.0, 4.8 mm

YATO

YT-36420



5/20

GB Hitch pin assortment set
D Sortiment Federsplinte
PL Zestaw zawleczek sprężystych
RUS Набор шплинтов с фиксацией
CZ Pružinové závlačky
H Rugós csap

RO Set sigurante securizare
F Assortiment goupilles beta
I Set di spine elastiche
E Pasadores surtido beta
CN 150PC R型销

PLASTIC
HANGING
BOX

150
PCS

6
SIZES
ROZMIAROW

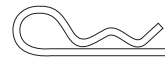

2.4x31 mm, 2x33 mm, 2x40 mm,
2.8x42 mm, 3.5x45 mm, 4x75 mm

YATO

YT-06883



6/24

GB Splint pin assortment
D Splinte Sortiment
PL Zestaw zawleczek prostych
RUS Набор шплинтов
CZ Set závlačky
H Sasszeg készlet

RO Cuie spintecate mici
F Goupilles - goupille fendue
I Set di perni
E Dividir cotter pinos
CN 件套开口销组套

PLASTIC
HANGING
BOX

555
PCS

MIX
SIZE
ROZMIAROW

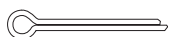

1.6x25 mm, 2.4x25 mm, 2.4x38 mm,
3.2x32 mm, 3.2x50 mm, 4.0x64 mm

YATO

YT-06873



5/10

GB Splint pin assortment
D Splinte Sortiment
PL Zestaw zawleczek prostych
RUS Набор шплинтов
CZ Set závlačky
H Sasszeg készlet

RO Cuie spintecate mici
F Goupilles - goupille fendue
I Set di perni
E Dividir cotter pinos
CN 件套开口销组套

PLASTIC
HANGING
BOX

1000
PCS

MIX
SIZE
ROZMIAROW



1.5x25 mm, 2.4x25 mm, 2.4x38 mm,
3.0x32 mm, 3.0x50 mm, 4.0x60 mm

YATO

YT-06885



12

GB E-ring circlips assortment
D Sortiment E-Sicherungsringe
PL Zestaw zawleczek typu „E”
RUS Набор Э-образных стопорных колец
CZ Otvěření pojistný kroužek
H „E” klip választék készlet

RO Set inele seger alezaj
F „E” clip assortment kit
I Set di spine tipo „E”
E E-ring anillo de retención variedad
CN 卡簧

PLASTIC
HANGING
BOX

300
PCS

Ø
1.5-22
mm



1.5 mm, 3 mm, 5 mm, 6 mm, 10 mm,
12 mm, 15 mm, 19 mm, 22 mm

YATO

YT-06884



25

GB Linch-pins assortment
D Klappsplint Sortiment
PL Zestaw zawleczek z kółkiem
RUS Набор шплинтов с кольцом
CZ Kolík pojistný
H Rugos biztosítoszeg készlet

RO Set pini pt. securizare
F Assortiment goupille clip
I Set di perni dalla ruota
E Pasador clip
CN 50件套弹性销组套

PLASTIC
HANGING
BOX

50
PCS

MIX
SIZE
ROZMIAROW

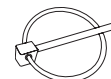

Ø 4.5x36 mm, Ø 6.0x45 mm,
Ø 8.0x45 mm, Ø 11.0x45 mm

YATO

YT-06787



6/12

- GB** Hose clamp assortment
D Schlauchschelle Sortiment
PL Zestaw obejm ślimakowych
RUS Набор хомутов
CZ Spony stahovac na hadice sada
H Tömlőbilincs csőszerelés szett
RO Coliere furtun

- F** Colliers de serrage universels
I Fascetta assortmento
E Manguera helicoidal instalación de tuberías abrazadera conjunto
CN 26件套喉箍

PLASTIC HANGING BOX



**26
PCS**

MIX
SIZE
ROZMIARÓW

Ø
**16-40
mm**



16, 22, 25, 28, 35, 40 mm

YATO
YT-06782 5/20

- GB** External / internal circlip assortment
D Aussen / Innen seegerring sortiment
PL Zestaw pierścieni Segera wewnętrznych / zewnętrznych
RUS Набор стопорных колец
CZ Sada vnitřní / vnější kroužky
H Állítsa belső / külső seeger-gyűrű

- RO** Set inele seeger arbore
F Externe / interne assortiment de circlip
I Set all'esterno / all'interno degli anelli Segera
E Sortimento freio externo / interno
CN 225件套外挡圈

PLASTIC HANGING BOX



**225
PCS**

MIX
SIZE
ROZMIARÓW

EXTERNAL
ZEWNETRZNE

INTERNAL
WEWNETRZNE



INTERNAL / WEWNĘTRZNE: Ø 11, 13, 14, 16, 19, 20 mm
EXTERNAL / ZEWNETRZNE: Ø 6, 8, 9, 11, 13, 14, 16, 19, 20, 22, 25, 32 mm

YATO
YT-06882 5/20

- GB** Internal circlip assortment
D Innen-seegerring-sortiment
PL Zestaw pierścieni Segera wewnętrznych
RUS Кольца стопорные внешние
CZ Sada pojistné kroužky
H Belső seeger-gyűrű készlet

- RO** Set agrafe
F Set de circlips int.
I Set all'interno degli anelli Segera
E Anillos seeger para agujeros interiores
CN 件套内挡圈组套

PLASTIC HANGING BOX



**300
PCS**

INTERNAL
WEWNETRZNE

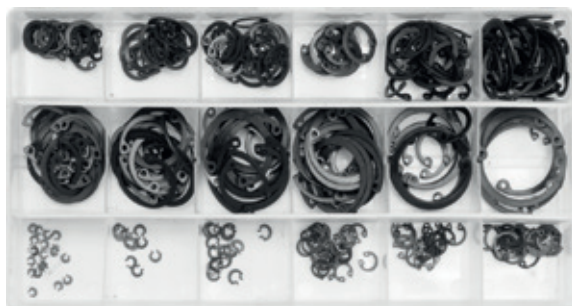

Ø 3, 4, 5, 6, 8, 9, 11, 12, 13, 14, 15, 19, 20, 22, 25, 26, 28, 32 mm

YATO
YT-06881 5/20

- GB** Hose clamp assortment
D Schlauchschelle Sortiment
PL Zestaw obejm skręcanych do przewodów
RUS Набор винтовых зажимов для кабелей
CZ Sada šroubovaných svorek do hadic

- H** Vezetékbilincs készlet
RO Set coliere pt. furtun
F Jeu de supports à visser pour conducteurs
I Fascetta assortmento
E Juego de abrazaderas atornillables para cables
CN 喉箍

PLASTIC HANGING BOX



**30
PCS**

MIX
SIZE
ROZMIARÓW

Ø
**6-16
mm**



7 PCS (6-8mm), 7 PCS (7-9mm), 5 PCS (8-10mm), 5 PCS (9-11mm), 3 PCS (10-12mm), 3 PCS (14-16mm)

YATO
YT-06783 24

- GB** External circlip assortment
D Aussen-seegerring-sortiment
PL Zestaw pierścieni Segera zewnętrznych
RUS Кольца стопорные внешние
CZ Sada pojistné kroužky
H Külső seeger-gyűrű készlet

- RO** Set agrafe
F Set de circlips ext.
I Set all'esterno degli anelli Segera
E Anillos seeger para agujeros exteriores
CN 件套外挡圈组套

PLASTIC HANGING BOX



**300
PCS**

EXTERNAL
ZEWNETRZNE



Ø 3, 4, 5, 6, 8, 9, 11, 12, 13, 14, 15, 19, 20, 22, 25, 26, 28, 32 mm

YATO
YT-06880 5/20

- GB** Feather keys assortment
D Sortiment Federkeile
PL Zestaw klinów półokrągłych
RUS Шпонки полукруглые
CZ Sada klinů polokruhových
H Ives hornyok biztosítására
RO Set pene disc pt. imbinari arbore

- F** Aspérule clés assortment
I Set di cunei semicirculari
E Surtido de chavetas media luna
CN 键销

PLASTIC HANGING BOX



**80
PCS**

MIX
SIZE
ROZMIARÓW



3.0x5.0x13 mm, 3.0x6.5x16 mm, 4.0x5.0x13 mm, 4.0x6.5x16 mm, 4.0x7.5x19 mm, 5.0x7.5x19 mm, 5.0x9.0x22 mm, 6.0x9.0x22 mm

YATO
YT-06790 5/25

- GB** Socket head set screw assortment metric
D Sortiment Madenschrauben, metrisch
PL Zestaw śrub imbusowych bez łba
RUS Набор винтов установочных с плоским концом
CZ Šroub stavěcí, plochý konec, bez úpravy
H Set menetes sasszegekkel
RO Set splituri filetate
F Set clavettes de vis
I Set di viti esagonali senza testa
E Conjunto de tornillo chavetas
CN 160件套无头螺钉组套



3x5 mm, 4x5 mm, 5x6 mm, 6x6 mm, 6x6 mm F, 6x10 mm, 8x10 mm, 8x10 mm F, 8x12 mm, 10x10 mm, 10x10 mm F, 10x12 mm



- GB** Rubber Grommet Assortment
D Gummi-durchgangs-tullen sortiment
PL Zestaw przelotek gumowych
RUS Набор резиновых втулок
CZ Gumové průchodka
H Gumi grommet készlet
RO Presetupa cauciuc pt. cablu
F Coffret passe-cloison caoutchouc
I Gommino angello
E Caja surtido de pasamuros de goma
CN 件套垫圈组套



5 PCS D= 22.0 mm ID= 15.0 mm OD= 26.0 mm	40 PCS D= 9.5 mm ID= 6.0 mm OD= 13.0 mm	5 PCS D= 15.8 mm ID= 12.0 mm OD= 19.0 mm	40 PCS D= 7.9 mm ID= 5.0 mm OD= 10.0 mm	25 PCS D= 11.0 mm ID= 9.0 mm OD= 15.0 mm	5 PCS D= 25.4 mm ID= 17.0 mm OD= 32.0 mm
		40 PCS D= 6.3 mm ID= 3.0 mm OD= 8.0 mm	20 PCS D= 12.7 mm ID= 11.0 mm OD= 15.0 mm		

6.3; 7.9; 9.5; 11.0; 12.7; 15.8; 22.0; 25.4 mm



- GB** Roll pin assortment
D Hohlsplannstifte
Spannstifte Sortiment
PL Zestaw kołków sprężystych
RUS Набор штифтов разрезных пружинных цилиндрических
CZ Pružné válcové kolíky se šterbinou
H Rugalmas hengeres csapok a nyílásba
RO Set splituri elastice
F Rouleau broche / pin assortiment de printemps
I Perno del rullo assortimento
E Acero pasador elástico
CN 315件套热收缩管组套



1.5x5mm, 1.5x8mm, 1.5x20mm, 2x6mm, 2x12mm, 2x25mm, 2.5x16mm, 2.5x25mm, 2.5x30mm, 3x16mm, 3x25mm, 3x30mm, 4x16mm, 4x25mm, 4x40mm, 5x16mm, 5x25mm, 5x30mm, 5.5x16mm, 5.5x30mm, 5.5x45mm, 6x16mm, 6x30mm, 6x45mm, 8x20mm, 8x40mm, 8x50mm, 10x20mm, 10x40mm, 10x50mm



- GB** O-ring assortment
D O-ring Sortiment
PL Zestaw O-ringów gumowych
RUS Набор резиновых прокладок
CZ Gumové „o“ kroužky sada
H O gyűrű készlet
RO Garnituri din cauciuc
F Set d'o-rings en caoutchouc
I Set guarnizioni O-ring
E Kit de junta tórica
CN 件套O型圈组套



3x1 mm 20 pcs	4x1 mm 20 pcs	4.5x2 mm 20 pcs	5x2 mm 20 pcs	6x2 mm 20 pcs	6x2.5 mm 20 pcs
13x3 mm 5 pcs	14x2.5 mm 5 pcs	17x2.5 mm 5 pcs	18x4 mm 5 pcs	20x2 mm 5 pcs	22x2 mm 5 pcs
6x3 mm 20 pcs	7x2 mm 20 pcs	8x2 mm 20 pcs	9x2 mm 5 pcs	10x2 mm 5 pcs	12x3 mm 5 pcs



GB O-Rings assortment for air conditioning
D O-Ringe für die Klimaanlage
PL Zestaw O-ringów HNBR do klimatyzacji
RUS Набор резиновых прокладок для систем кондиционирования воздуха

CZ Gumový kroužek set klimatizace
H Gumi gyűrű készlet légkondicionáló
RO Inele pt. aer conditionat
F Cercle en caoutchouc boîte de kit combinaison

I O-Ring assortimento per l'aria condizionata
E Kit círculo caucho combinación caja
CN 270PC 绿色O型圈

PLASTIC HANGING BOX



270
PCS

MIX
SIZE
ROZMĚRŮV

HNBR
MATERIAL
MATERIAL



 20x ∅ 5,29 x 1,78 mm	 20x ∅ 6,07 x 1,78 mm	 20x ∅ 6,8 x 1,9 mm	 20x ∅ 7,65 x 1,78 mm	 20x ∅ 7,8 x 1,9 mm	 20x ∅ 8 x 2 mm
 20x ∅ 8,8 x 1,9 mm	 15x ∅ 10,82 x 1,78 mm	 15x ∅ 10,77 x 2,62 mm	 15x ∅ 11 x 2 mm	 15x ∅ 12 x 2 mm	 10x ∅ 13,9 x 1,8 mm
 10x ∅ 13,95 x 2,62 mm	 10x ∅ 10 x 2 mm	 10x ∅ 15 x 2 mm	 10x ∅ 17 x 2 mm	 10x ∅ 17,17 x 1,78 mm	 10x ∅ 17,04 x 3,53 mm

∅ 5.29 x 1.78 mm, 6.07 x 1.78 mm, 6.8 x 1.9 mm, 7.65 x 1.78 mm, 7.8 x 1.9 mm, 8 x 2 mm, 8.8 x 1.9 mm, 10.82 x 1.78 mm, 10.77 x 2.62 mm, 11 x 2 mm, 12 x 2 mm, 13.9 x 1.8 mm, 13.95 x 2.62 mm, 10 x 2 mm, 15 x 2 mm, 17 x 2 mm, 17.17 x 1.78 mm, 17.04 x 3.53 mm

YATO
YT-06879

5/24

GB O-ring assortment
D O-ring Sortiment
PL Zestaw O-ringów gumowych
RUS Набор резиновых прокладок
CZ Gumové „o“ kroužky sada
H O gyűrű készlet
RO Garnitură din cauciuc
F Set d'o-rings en caoutchouc
I Set guarnizioni O-ring
E Kit de junta tórica
CN 件套O型圈组套

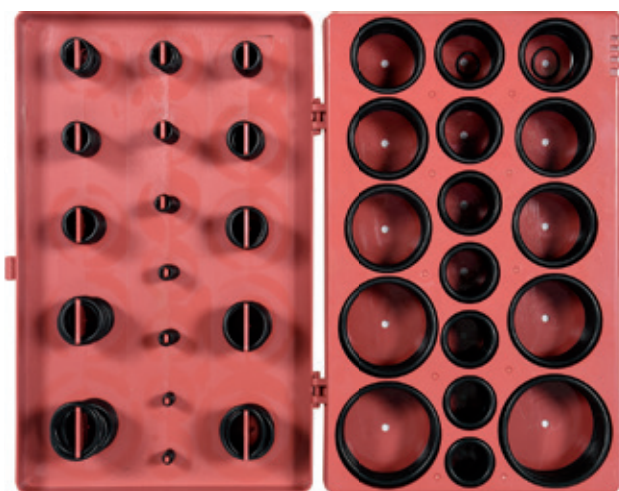

PLASTIC BOX



419
PCS

MIX
SIZE
ROZMĚRŮV

NBR
MATERIAL
MATERIAL

3x1.5 mm, 4.4x2 mm, 5x2 mm, 7x1.5 mm, 10x1.5 mm, 10x2.5 mm, 11x2.5 mm, 13x1.5 mm, 13x2.5 mm, 14x2.5 mm, 16x2.5 mm, 18x2.5 mm, 19x2.5 mm, 21x2.5 mm, 22x2.5 mm, 18x3.5 mm, 20x3.5 mm, 22x3.5 mm, 23.5x3.5 mm, 25x3.5 mm, 26.5x3.5 mm, 28x3.5 mm, 30x3.5 mm, 31x3.5 mm, 33x3.5 mm, 34.5x3.5 mm, 36x3.5 mm, 38x3.5 mm, 41x3.5 mm, 44x3.5 mm, 47x3.5 mm, 50x3.5 mm

YATO
YT-06876

5/20

GB Electrical clip assortment
D Krokodil-Klemmen-Kortiment
PL Zestaw złącz elektrycznych - krokodylki
RUS Набор разъемов - крокодил
CZ Terminal alligator krokodil příchytok
H Krokodil csipesz készlet
RO Sortiment cleme crocodil
F Assortiment pinces crocodile
I Set di perni per misure e prove
E Crocodile clip
CN 件套夹头组套

PLASTIC HANGING BOX



28
PCS

MIX
SIZE
ROZMĚRŮV



50; 55; 60; 65; 70; 80 mm

YATO
YT-06870

5/20

GB Terminal connectors
D Kabelschuhe schnelkupplung kabellemme
PL Zestaw szybkozłącza elektrycznych
RUS Набор экспресс-клемм
CZ Kabelova rychlospojka
H Gyors csatlakozó auto
RO Conector rapid pt. auto
F Connecteur rapide
I Connettori terminali
E Conector rapido electrico
CN 件套连接片组套

PLASTIC HANGING BOX



50
PCS

MIX
SIZE
ROZMĚRŮV



0.5 - 1.5; 1.5 - 2.5 mm²

YATO
YT-06868

5/20

GB Heat-shrink tubing set
D Schrumpfschlauch - sortiment
PL Zestaw koszulek termokurczliwych
RUS Набор термоусадочных трубок
CZ Smršťovací bužírka tepelně
H Hőre zsugorodó cső szettek
RO Set tuburi termocontractabile
F Gaine thermocontractable
I Tubo termoretraibile per isolare
E Surtido tubo de conexión eléctrica cable manga
CN 件套热收缩管

PLASTIC HANGING BOX



127
PCS

MIX
SIZE
ROZMĚRŮV

125°C
max.

600 V
max.



∅ 2.0 x 40, 2.5 x 40, 3.5 x 40, 5.0 x 40, 7.0 x 80, 10.0 x 80, 13.0 x 85 mm

YATO
YT-06866

5/20

GB Terminal assortment
D Kabelschuh-Set
PL Zestaw złącz elektrycznych
RUS Набор электрических соединителей

CZ Sada elektrických konektorů
H Elektromos csatlakozókészlet
RO Set papuci auto
F Jeu de cosses de câbles

I Morsetti di terra per saldatura
E Juego de conectores eléctricos
CN 接线端子

PLASTIC
HANGING BOX



160
PCS
MIX
ROZMIARÓW

12 PCS (0.25 - 1.5 mm²) 18 PCS (1.5 - 2.5 mm²), 12 PCS (4 - 6 mm²), 10 PCS (1.5 - 2.5 mm²), 5 PCS (4 - 6 mm²), 4 PCS (0.25 - 1.5 mm²), 4 (1.5 - 2.5 mm²), 10 PCS (1.5 - 2.5 mm²), 10 PCS (1.5 - 2.5 mm²), 4 PCS x Ø 5 mm, 4 PCS x Ø 8 mm, 4 PCS x Ø 10 mm, 10 PCS x Ø 4 mm, 10 PCS x Ø 5 mm, 10 PCS x Ø 6 mm, 10 PCS x Ø 4 mm, 8 PCS x Ø 4 mm

360
PCS
MIX
ROZMIARÓW

⊖ (5 mm - 2 mm²) x 30 PCS, (6 mm - 2 mm²) x 20 PCS, (9.5 mm - 2 mm²) x 20 PCS, (5 mm - 5.5 mm²) x 20 PCS, (6 mm - 5.5 mm²) x 15 PCS, (9.5 mm - 5.5 mm²) x 15 PCS, ⊖ (1.25 mm²) x 40 PCS, (2 mm²) x 30 PCS, (5.5 mm²) x 15 PCS, ⊖ (5 mm - 2 mm²) x 30 PCS, (5 mm - 5.5 mm²) x 20 PCS, ⊖ (2 mm²) x 25 PCS, ⊖ (2 mm²) x 35 PCS, ⊖ (2 mm²) x 10 PCS, ⊖ (2 mm²) x 35 PCS

YATO
YT-06891 24

YATO
YT-06890 12

GB Superseal connectors wiring assortment
D Hermetischer Elektrostecker Satz
PL Zestaw złącz elektrycznych hermetycznych
RUS Набор герметичных электрических разъемов
CZ Sada hermetických elektrických svorek
H Hermetikus elektromos csatlakozókészlet

RO Mufe auto
F Jeu de connecteurs électriques hermétiques
I Morsetti di terra per saldatura
E Set de herméticos conectores eléctricos
CN 424件套低压电源线束快速接头

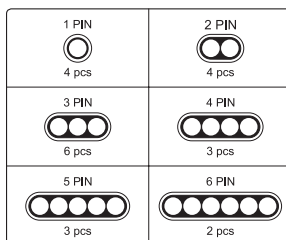

424
PCS
HERMETIC
HERMETYCZNE
1-6
PIN

PLASTIC BOX



YATO
YT-06869 6/12

GB Car fuse assortment
D KFZ-Sicherungs - Set
PL Zestaw bezpieczników

RUS Набор предохранителей
CZ Sada pojistek
H Biztosítékkészlet

RO Set sigurante
F Ensemble de fusible
I Kit di fusibili lamellari

E Conjunto de fusibles
CN 件套车用保险大插件组套



24
PCS

MAXI

(20A, 30A, 40A, 50A, 60A, 70A, 80A, 100A) x3 PCS

YATO
YT-83140 24



92
PCS

STANDARD

FUSE
PULLER
CHWYTAK

(5A, 10A, 15A, 20A, 25A, 30A) x15 PCS / VOLTAGE TESTER 6-24V / TESTER

YATO
YT-83142 24

97
PCS

STANDARD

FUSE
PULLER
CHWYTAK

(3A, 5A, 7.5A, 10A, 15A, 20A, 25A, 30A) x12 PCS

YATO
YT-83141 24



121
PCS

MINI

FUSE
PULLER
CHWYTAK

(5A, 10A, 15A, 20A, 25A, 30A) x20 PCS

YATO
YT-83143 24

GB Car fuse assortment
D KFZ-Sicherungs-Set
PL Zestaw bezpieczników

RUS Набор предохранителей
CZ Sada pojistek
H Biztosítékészlet

RO Set sigurante
F Ensemble de fusible
I Kit di fusibili lamellari

E Conjunto de fusibles
CN 件套车用保险大插片组套

PLASTIC
HANGING BOX

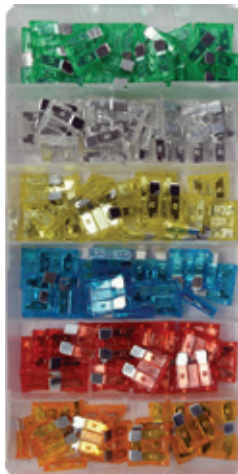

120
PCS

STANDARD 20 PCS x 5A, 20 PCS x 10A, 20 PCS x 15A,
20 PCS x 20A, 20 PCS x 25A, 20 PCS x 30A

YATO **YT-83144** 12/60



100
PCS

MINI 10 PCS x 7.5A, 20 PCS x 10A, 20 PCS x 15A,
20 PCS x 20A, 20 PCS x 25A, 10 PCS x 30A

YATO **YT-83145** 12



120
PCS

MINI 20 PCS x 5A, 20 PCS x 10A, 20 PCS x 15A,
20 PCS x 20A, 20 PCS x 25A, 20 PCS x 30A

YATO **YT-83146** 12/60

GB Trim clips assortment
D Befestigungs-Clip-Satz
PL Komplet spinek samochodowych

RUS Набор автомобильного крепежа
CZ Sada přichytek čalounění
H Kötőelemek szegecsek

RO Clip de plastic asortat
F Ensembles de clips
en plastique auto

I Set di clip per auto
E Clip de plástico surtido
CN 塑料卡扣

PLASTIC
HANGING BOX



360
PCS

18
TYPES
RODZAJÓW for / dla: **TOYOTA / LEXUS**

YATO **YT-06650** 25



300
PCS

6
TYPES
RODZAJÓW for / dla: **RENAULT**

YATO **YT-06651** 25



300
PCS

6
TYPES
RODZAJÓW for / dla: **OPEL**

YATO **YT-06652** 25



345
PCS

12
TYPES
RODZAJÓW for / dla: **PEUGEOT**

YATO **YT-06653** 25



308
PCS

12
TYPES
RODZAJÓW for / dla: **FIAT**

YATO **YT-06654** 25



350
PCS

12
TYPES
RODZAJÓW for / dla: **VOLVO**

YATO **YT-06655** 25



418
PCS

18
TYPES
RODZAJÓW for / dla: **HONDA**

YATO **YT-06656** 25



408
PCS

18
TYPES
RODZAJÓW for / dla: **NISSAN**

YATO **YT-06657** 25



475
PCS

18
TYPES
RODZAJÓW for / dla: **MAZDA**

YATO **YT-06658** 25

GB Trim clips assortment
D Befestigungs-Clip-Satz
PL Komplet spinek samochodowych

RUS Набор автомобильного крепежа
CZ Sada příchytek čalounění
H Kötőelemek szegecsek

RO Clip de plastic asortat
F Ensembles de clips en plastique auto

I Set di clip per auto
E Clip de plástico surtido
CN 塑料卡扣

PLASTIC
HANGING BOX



370
PCS

12
TYPES
RODZAJÓW

for / dla: **MITSUBISHI**

YATO		25
YT-06659		



415
PCS

18
TYPES
RODZAJÓW

for / dla: **FORD**

YATO		25
YT-06660		

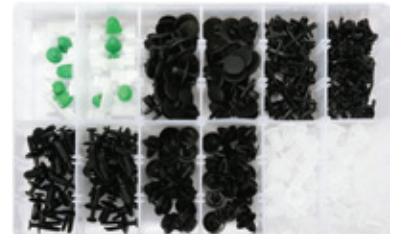

290
PCS

6
TYPES
RODZAJÓW

for / dla: **BMW**

YATO		25
YT-06661		



270
PCS

12
TYPES
RODZAJÓW

for / dla: **MERCEDES**

YATO		25
YT-06662		



255
PCS

12
TYPES
RODZAJÓW

for / dla: **VOLKSWAGEN**

YATO		25
YT-06663		



160
PCS

12
TYPES
RODZAJÓW

for / dla: **AUDI**

YATO		25
YT-06664		

GB Digital universal multimeter
D Universell digital Messgerät
PL Cyfrowy miernik uniwersalny

RUS Универсальный цифровой измеритель
CZ Digitální multimetr univerzální

H Digitális multiméter
RO Multimetru digital universal
F Multimètre numérique

I Universale tester digitale
E Manómetro digital universal
CN 数字万用表

COLOR
BOX



U A.C. 0-500V	U D.C. 0-500V	I D.C. 0-5A	R 0-2 MΩ
	h_{FE} PNP NPN	5V P-P	

YATO		50
YT-73080		



U A.C. 0-600V	U D.C. 0-600V	I D.C. 0-10A	R 0-2 MΩ		h_{FE} PNP NPN
1.5 / 9 V BATTERY TEST TEST BATERII		DATA HOLD	LED BACKLIGHT POŚWIETLENIE	LCD 1999	1.5V 2x AAA

YATO		50
YT-73081		



TRUE RMS	U A.C. 0-600V	U D.C. 0-600V	I A.C. 0-10A	I D.C. 0-10A	R 0-99 MΩ
C 0-99 mF	V A.C. VFC	f 10Hz-60kHz	CONTINUITY TEST TEST CIĄGŁOŚCI		
DATA HOLD	AUTO POWER OFF WYŁĄCZANIE AUTOMATYCZNE	LED BACKLIGHT POŚWIETLENIE	LCD 9999	AUTO RANGE AUTO ZAKRES	3V 2x AAA
	1.5 / 9 V BATTERY TEST TEST BATERII				FRONT LIGHTING FUNKCJA LATARKI

YATO		40
YT-73094		

GB Digital universal multimeter
D Universell digital Messgerät
PL Cyfrowy miernik uniwersalny

RUS Универсальный цифровой измеритель
CZ Digitální multimetr univerzální

H Digitális multiméter
RO Multimetru digital universal
F Multimètre numérique

I Universale tester digitale
E Manômetro digital universal
CN 数字万用表

COLOR BOX



TRUE RMS	U A.C. 0-600V	U D.C. 0-600V	I A.C. 0-20A	I D.C. 0-20A	R 0-20 MΩ
C 0-20 mF	T -40°+1000°C	f 0-60 MHz	h _{FE} PNP NPN	⚡	📶
DATA HOLD	AUTO POWER OFF	LED BACKLIGHT	LCD 1999	9V 6F22	

U A.C. 0-300V	U D.C. 0-300V	I A.C. 0-10A	I D.C. 0-10A	R 0-20 MΩ	C 0-1000 μF
T -20°+1000°C	⚡	h _{FE} PNP NPN	AUTO RANGE	POWER OFF	DATA HOLD
LED BACKLIGHT	MAX VALUE DISPLAY	📶			

TRUE RMS	U A.C. 0-600V	U D.C. 0-600V	I A.C. 0-10A	I D.C. 0-10A	R 0-60 MΩ
C 0-60 mF	0.1%+99%	f 0-60 MHz	T -40°+1370°C	⚡	h _{FE} PNP NPN
📶	DATA HOLD	AUTO POWER OFF	AUTO RANGE	MAX & MIN VALUE DISPLAY	LED BACKLIGHT
				LCD 5999	9V 6F22

for / dla:
YT-73090

YATO
YT-73083 20

YATO
YT-73084 44

YATO
YT-73085 20

GB Digital universal multimeter
D Universell digital Messgerät
PL Cyfrowy miernik uniwersalny
RUS Универсальный цифровой измеритель

CZ Digitální multimetr univerzální
H Digitális multiméter
RO Multimetru digital universal
F Multimètre numérique

I Universale tester digitale
E Manômetro digital universal
CN 数字万用表

NYLON CASE & COLOR BOX



L1 L2 L3	U A.C. 0-600V	U D.C. 0-600V	I A.C. 0-10A	I D.C. 0-10A	R 0-40 MΩ	C 0-100 μF	f 100 kHz	5%+95%	5 in 1	U A.C. 0-300V	U D.C. 0-300V	I A.C. 0-10A	I D.C. 0-10A	R 0-40 MΩ	C 0-100 μF	f 200 kHz	5%+95%	T -20°+1000°C
T -20°+1000°C	⚡	AUTO RANGE	DATA HOLD	AUTO POWER OFF	LED BACKLIGHT	REL RELATIVE VALUE	📶	⚡	%RH 30%+90%	3.5-100dB	40000 lx	AUTO RANGE	AUTO POWER OFF	DATA HOLD	LED BACKLIGHT	REL RELATIVE VALUE	📶	

YATO
YT-73086 24

YATO
YT-73087 24

GB Aluminium ruler
D Alu zeichen-massstab
PL Przymiar aluminiowy
RUS Линейка алюминиевая
CZ Měřicí lat' hliníková
H Asztalos vonalzó, alumínium

RO Riglă tâmplară din aluminiu
F Règle aluminium
I Righello di alluminio
E Regla de aluminio
CN 铝合金直尺

AI



YATO	L (mm)	
YT-7070	300	25/100
YT-7071	600	10/50

GB Steel set square
D Anschlagwinkeldreieck
PL Ekierka metalowa
RUS Угольник для плотника и столяра
CZ Úhelník
H Fém derékszög
RO Echer tamplarie

F Équerre de menuisier
I Squadra metallica
E Escuadra metálica
CN 铝合金三角尺

INOX
STAINLESS STEEL
STAL NIERDZEWNA

AI

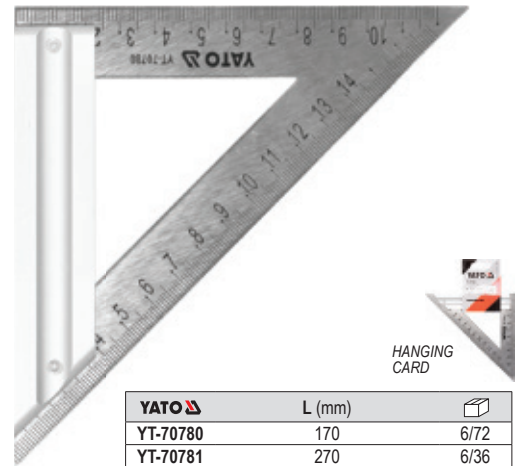

YATO	L (mm)	
YT-70780	170	6/72
YT-70781	270	6/36

HANGING CARD

GB Aluminium alloy triangle
D Anschlagwinkeldreieck
PL Kałownik ciesielski do krokwi
RUS Угольник для плотника и столяра
CZ Úhelník na meranie
H Fém derékszög
RO Echer aluminiu pt. dulgherie
F Équerre triangle règle
I Squadra da carpentiere
E Escuadra metálica
CN 铝合金三角尺

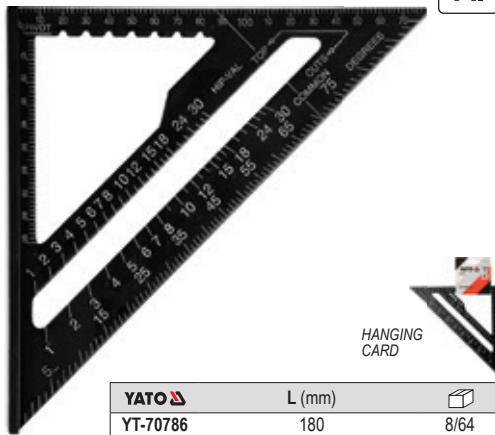

YATO	L (mm)	
YT-70786	180	8/64
YT-70787	300	6/24

HANGING CARD

AI

GB Folding builder's square
D Bauwinkel Klappbar
PL Kałownik budowlany składany
RUS Угольник складной строительный
CZ Skládací stávkový úhelník
H Összecsukható derékszög
RO Echer pliabil din aluminiu
F Équerre pliante
I Squadra da muratore pieghevole
E Escuadra plegable construcción
CN 折叠铝合金角尺

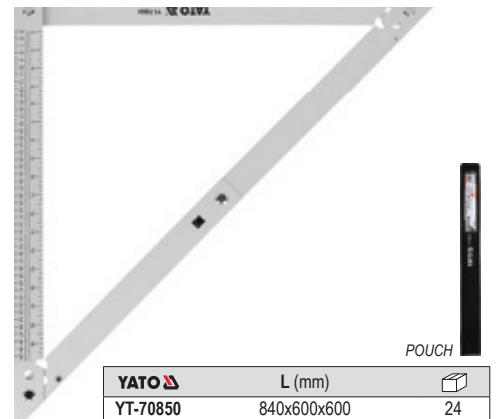

YATO	L (mm)	
YT-70850	840x600x600	24
YT-70851	1720x1220x1220	10

POUCH

SCALE
SKALA
mm
inch

AI

GB Aluminium try square
D Anschlagwinkel
PL Kałownik do płyt gipsowo-kartonowych
RUS Угольник столярный
CZ Truhlářský úhelník černý
H Asztalos derékszög, fekete

RO Echer de tâmplărie negru
F Équerre
I Squadra per pannelli in gesso
E Escuadra de aluminio
CN T型角尺

1200 mm

+/- 0.03 mm

AI

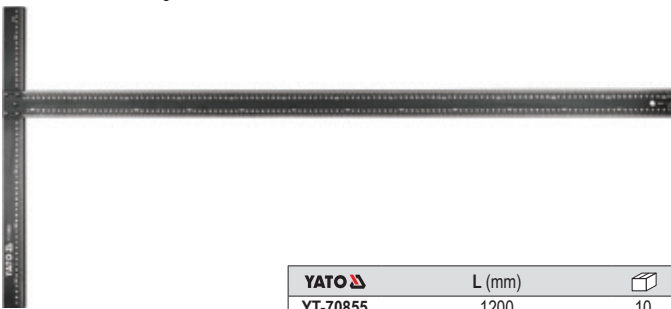

YATO	L (mm)	
YT-70855	1200	10

GB Aluminium try square
D Anschlagwinkel
PL Kałownik aluminiowy
RUS Угольник столярный
CZ Truhlářský úhelník
H Asztalos derékszög

RO Echer de tâmplărie
F Equerre en aluminium
I Angolo di alluminio
E Escuadra de aluminio
CN 铝合金角尺

AI

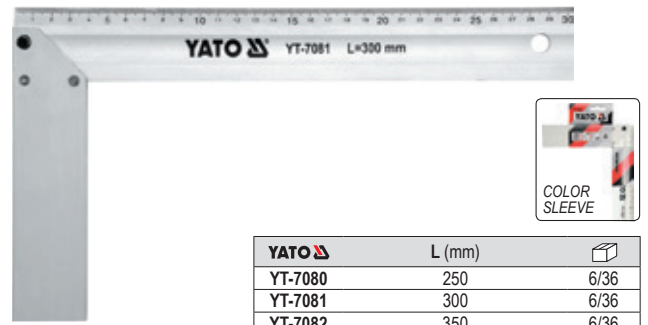

YATO	L (mm)	
YT-7080	250	6/36
YT-7081	300	6/36
YT-7082	350	6/36

COLOR SLEEVE

GB Try square
D Anschlagwinkel
PL Kałownik stalowy
RUS Угольник столярный
CZ Truhlářský úhelník
H Asztalos derékszög
RO Echer de tâmplărie
F Equerre
I Angolo di acciaio
E Escuadra
CN 不锈钢角尺



SS
STAINLESS STEEL
STAL NIERDZEWNA



YATO	size / rozmiar (mm)	
YT-7083	150 x 300	25/100
YT-7084	250 x 500	10/50

COLOR SLEEVE

- GB Vernier caliper
- D Messschieber
- PL Suwmiarka
- RUS Штангенциркуль
- CZ Posuvné měřtko
- H Tolómérő
- RO Şubler
- F Pied à coulisse
- I Calibro
- E Calibre
- CN 游标卡尺

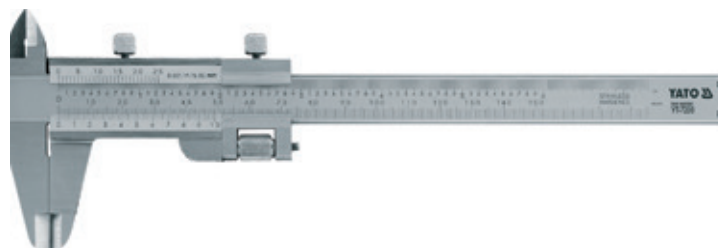

+/- 0.02 mm
SCALE SKALA mm inch
SS STAINLESS STEEL STAL NERDZEJĄCA

PLASTIC CASE & COLOR BOX



YATO	range / zakres (mm)	
YT-7200	0-150	50

- GB Digital caliper
- D Digital Messschieber
- PL Suwmiarka elektroniczna
- RUS Штангенциркуль электронный
- CZ Posuvné měřtko elektronické
- H Digitális tolómérő
- RO Şubler electronic
- F Pied à coulisse électronique
- I Calibro
- E Calibre electrónico
- CN 数显卡尺



+/- 0.03 mm
SCALE SKALA mm inch
SS STAINLESS STEEL STAL NERDZEJĄCA
BATTERY SR44 1.55V

PLASTIC CASE & COLOR BOX



YATO	range / zakres (mm)	
YT-7201	0-150	10/50

- GB Vernier caliper
- D Messschieber
- PL Suwmiarka
- RUS Штангенциркуль
- CZ Posuvné měřtko
- H Tolómérő
- RO Şubler
- F Pied à coulisse
- I Calibro
- E Calibre
- CN 游标卡尺



+/- 0.02 mm
SCALE SKALA mm inch
SS STAINLESS STEEL STAL NERDZEJĄCA

PLASTIC CASE & COLOR BOX



YATO	range / zakres (mm)	
YT-72003	0-200	30
YT-72004	0-300	20

- GB Vernier caliper
- D Messschieber
- PL Suwmiarka
- RUS Штангенциркуль
- CZ Posuvné měřtko
- H Tolómérő
- RO Şubler
- F Pied à coulisse
- I Calibro
- E Calibre
- CN 游标卡尺



+/- 0.05 mm
SCALE SKALA mm inch
AI



YATO	range / zakres (mm)	
YT-70740	0-600	12/24

- GB Disc brake vernier caliper
- D Scheibenbremse noniusschieber
- PL Suwmiarka do tarcz hamulcowych
- RUS Штангенциркуль для тормозных листов
- CZ Digitální posuvné měřtko na brzdové kotouče
- H Tárcafék tolómérő

- RO Subler pt. masurat discuri de frana cu display digital
- F Disque de frein etrier vernier
- I Calibro a corsoio per dischi del freno
- E Freno de disco pie de rey
- CN 制动片卡尺

160 mm
0-60 mm RANGE ZAKRES
+/- 0.01 mm
SS STAINLESS STEEL STAL NERDZEJĄCA

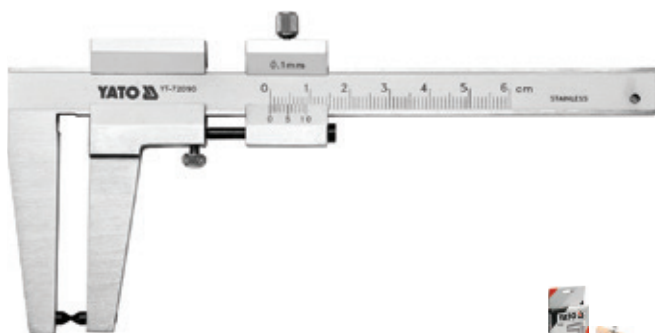

WOODEN BOX & HANGING COLOR BOX



YATO	range / zakres (mm)	
YT-72090	0-60	50

- GB Disc brake digital caliper
- D Digitalen Scheibenbremse
- PL Suwmiarka elektroniczna do tarcz hamulcowych
- RUS Штангенциркуль электронный для тормозных листов
- CZ Elektronicke posuvné měřtko na brzdové kotouče
- H Electronikus tárcsafék tolómérő

- RO Subler pt. masurat discuri de frana cu display digital
- F Disque de frein etrier électronique
- I Calibro a corsoio elettronico per dischi del freno
- E Pie de rey digital para discos de freno
- CN 制动片卡尺

180 mm
0-70 mm RANGE ZAKRES
+/- 0.03 mm
55mm JAWS SZCZĘK
mm inch
LCD DISPLAY WYŚWIETLACZ
CR2032 3V BATTERY BATERIA
SS STAINLESS STEEL STAL NERDZEJĄCA



WOODEN BOX & HANGING COLOR BOX



YATO	range / zakres (mm)	
YT-72093	0-70	50

GB Micrometer
D Mikrometer
PL Mikrometr
RUS Микрометр

CZ Mikrometr
H Mikrométer
RO Micrometru
F Micromètre

I Micrometro
E Micrómetro
CN 外径千分尺

+/-
0.01
mm



PLASTIC CASE & COLOR BOX

YATO	range / zakres (mm)	
YT-72300	0-25	100
YT-72301	25-50	50
YT-72302	50-75	50
YT-72303	75-100	50

GB Micrometer with a digital display
D Mikrometer mit Digitalanzeige
PL Mikrometr z wyświetlaczem cyfrowym
RUS Микрометр с цифровым индикатором
CZ Mikrometr s digitálnim displejem

H Mikrométer digitális kijelzővel
RO Micrometru cu afişaj digital
F Micromètre
I Micrometro con digitale elettronico
E Micrómetro con pantalla digital
CN 籽珩儀數顯

+/-
0.01
mm

SCALE
SKALA
mm
inch

LCD
DISPLAY
WYSWIETLACZ



PLASTIC CASE & COLOR BOX

YATO	range / zakres (mm)	
YT-72305	0-25	50

GB Feeler
D Fühlerlehre
PL Szczelinomierz
RUS Щупы
CZ Spároměr
H Hézagmérő

RO Lere
F Palpeur
I Spessimetro
E Calibre de fisuras
CN 塞尺

DOUBLE
BLISTER



100
mm
10
mm
17
GAUGES
LISTKÓW
TAPER
ZBIĘŻNY

YATO	L (mm)	width / szerokość	size / rozmiar	
YT-7220	100	10	0.02; 0.03; 0.04; 0.05; 0.06; 0.07; 0.08; 0.09; 0.10; 0.15; 0.20; 0.25; 0.30; 0.40; 0.50; 0.75; 1.00	10/200

200
mm
12.8
mm
17
GAUGES
LISTKÓW
PARALLEL
RÓWNOLEGŁY

YATO	L (mm)	width / szerokość	size / rozmiar	
YT-7221	200	12.8	0.02; 0.03; 0.04; 0.05; 0.06; 0.07; 0.08; 0.09; 0.10; 0.15; 0.20; 0.25; 0.30; 0.40; 0.50; 0.75; 1.00	10/100

100
mm
10
mm
10
GAUGES
LISTKÓW
TAPER
ZBIĘŻNY

YATO	L (mm)	width / szerokość	size / rozmiar	
YT-7222	100	10	0.05; 0.06; 0.07; 0.08; 0.09; 0.10; 0.20; 0.30; 0.40; 0.50	10/100

200
mm
12.8
mm
14
GAUGES
LISTKÓW
PARALLEL
RÓWNOLEGŁY

YATO	L (mm)	width / szerokość	size / rozmiar	
YT-7223	200	12.8	0.05; 0.06; 0.07; 0.08; 0.09; 0.10; 0.15; 0.20; 0.25; 0.30; 0.35; 0.40; 0.45; 0.50	10/100

GB Screw pitch gauges
D Gewinde-Messlehre
Lehrenblätter
PL Sprawdzian grzebieniowy do gwintów

RUS Резьбмер
CZ Test hřebel
H Menetsablon
RO Set lere filet

F Manometre pour filetage
I Pettine per filetti
E Galga para roscas
CN 鑽徑真

SLIDING
CARD



METRIC
METRYCZNE
0.25-6.0
mm
60°
24
BLADES
OSTRZA

YATO	thread types / rodzaje gwintów metric / metryczne (mm)	
YT-29980	0.25; 0.3; 0.35; 0.4; 0.45; 0.5; 0.6; 0.7; 0.75; 0.8; 0.9; 1.0; 1.25; 1.5; 1.75; 2.0; 2.5; 3.0; 3.5; 4.0; 4.5; 5.0; 5.5; 6.0	30/300

WHITWORTH
4-62
55°
28
BLADES
OSTRZY

YATO	thread types / rodzaje gwintów Whitworth	
YT-29982	4; 4.5; 5; 6; 7; 8; 9; 10; 11; 12; 13; 14; 15; 16; 18; 20; 22; 24; 25; 26; 28; 30; 32; 36; 40; 48; 60; 62	30/300

METRIC
METRYCZNE
0.25-6.0
mm
60°
WHITWORTH
4-62
55°
52
BLADES
OSTRZA

YATO	thread types / rodzaje gwintów		
	metric / metryczne (mm)	Whitworth	
YT-29984	0.25; 0.3; 0.35; 0.4; 0.45; 0.5; 0.6; 0.7; 0.75; 0.8; 0.9; 1.0; 1.25; 1.5; 1.75; 2.0; 2.5; 3.0; 3.5; 4.0; 4.5; 5.0; 5.5; 6.0	4; 4.5; 5; 6; 7; 8; 9; 10; 11; 12; 13; 14; 15; 16; 18; 20; 22; 24; 25; 26; 28; 30; 32; 36; 40; 48; 60; 62	20/200

PL

I. TOYA S.A. informuje, iż: 1) niniejszy katalog nie stanowi oferty w rozumieniu prawa cywilnego; 2) prezentowane w niniejszym katalogu artykuły mogą w rzeczywistości odbiegać od wskazanego na zdjęciach wzoru, w szczególności jeżeli chodzi o cechy zewnętrzne, tj. wielkość, kolor, sposób opakowania, liczbę przedmiotów w opakowaniu; 3) nie ponosi odpowiedzialności za drobne różnice w sposobie pakowania czy właściwościach artykułów pozostających bez wpływu na jego przeznaczony cel lub sposób użytkowania; 4) nie ponosi odpowiedzialności wynikającej z jakichkolwiek niedokładności lub nieścisłości, co do informacji zawartych w przedmiotowym katalogu; 5) nie ponosi odpowiedzialności za ewentualną szkodę powstałą w wyniku otrzymania towaru o innych właściwościach niż prezentowany na zdjęciach.

II. Pomimo najlepszych starań poczynionych przez TOYA S.A. nie może ona zagwarantować, iż informacje zawarte w niniejszym katalogu w pełni odpowiadają rzeczywistości.

III. Wszelkie decyzje podjęte na podstawie informacji zawartych w przedmiotowym katalogu podejmowane są na własne ryzyko osoby, która korzysta z tych informacji.

GB

I. TOYA S.A. informs that: 1) the present catalogue does not constitute an offer as construed in the civil law; 2) the goods presented in the present catalogue may in fact differ from the models shown in the pictures, particularly as far as external properties are concerned, namely size, colour, packaging, number of items in the package; 3) the company will not be held responsible for small differences in packaging or properties of the goods, which do not affect the purpose or the exploitation of the tools; 4) the company will not be held responsible for any inaccuracies or imprecision regarding the information presented in the catalogue; 5) the company will not be held responsible for any damage caused by goods whose properties differ from those of the tools presented in the photographs.

II. In spite of all the efforts made by TOYA S.A., the company cannot guarantee the information contained in the present catalogue fully correspond to the reality.

III. Any decisions made on the basis of the information contained in the present catalogue will be made at the risk of the person who makes them using the aforementioned information.

D

I. TOYA S.A. informiert, dass: 1) der vorliegende Katalog kein Angebot im zivilrechtlichen Sinne darstellt; 2) die im vorliegenden Katalog präsentierten Artikel in der Realität von den auf den Musterfotos gezeigten abweichen können, und zwar besonders dann, wenn es um äußere Eigenschaften geht, wie z.B. Größe, Farbe, Art der Verpackung, Anzahl der Gegenstände in der Verpackung; 3) sie keine Verantwortung für geringfügige Unterschiede bei der Verpackungsart oder den Eigenschaften der Artikel übernimmt, die ohne Auswirkungen auf seinen Bestimmungszweck oder die Art der Nutzung bleiben; 4) sie keine Verantwortung für irgendwelche Oberflächlichkeiten und Ungenauigkeiten bzgl. der im Sachkatalogkatalog enthaltenen Informationen übernimmt; 5) sie keine Verantwortung für eventuelle Schäden, die im Ergebnis des Erhalts der Ware mit anderen als auf den Fotos dargestellten Eigenschaften entstanden sind, übernimmt.

II. Trotz großer Bemühungen seitens TOYA S.A. kann die Firma nicht garantieren, dass die im vorliegenden Katalog enthaltenen Informationen voll der Realität entsprechen.

III. Sämtliche Entscheidungen, die auf der Grundlage der im Sachkatalog enthaltenen Informationen getroffen wurden, gehen auf das Risiko der Person, die diese Informationen benutzt.

RUS

I. TOYA S.A. заявляет: 1) настоящий каталог не является торговым предложением с точки зрения гражданского законодательства; 2) изделия, представленные в настоящем каталоге, могут отличаться от образцов на снимках, особенно внешним видом, то есть размером, цветом, способом упаковки, количеством предметов в упаковке; 3) производитель не отвечает за мелкие отличия в способе упаковки или свойствах изделий, которые не влияют на предназначение или способ пользования изделиями; 4) производитель не отвечает за мелкие неточности в сведениях из предметного каталога; 5) производитель не отвечает за ущерб, нанесенный вследствие поставки товара, отличающегося параметрами от указанного на снимках.

II. Несмотря на все усилия в данном направлении, компания TOYA S.A. не гарантирует, что информация, метящаяся в настоящем каталоге, полностью отвечает действительности.

III. Риск, связанный с любыми решениями, принятыми на основании информации из предметного каталога, берут на себя лица, пользующиеся указанной информацией.

CZ

I. TOYA S.A. informuje že: 1) tento katalog nepředstavuje nabídku ve smyslu občanského práva; 2) výrobky prezentované v tomto katalogu se mohou ve skutečnosti lišit od modelů uvedených na obrázcích, zejména co se týká vnějších znaků, tj. velikosti, barvy, způsobu balení, počtu předmětů v balení; 3) nenese odpovědnost za drobné rozdíly ve způsobu balení nebo ve vlastnostech výrobků, které nemají zásadní vliv na jejich určený účel nebo způsob používání; 4) nenese odpovědnost vyplývající z jakýchkoli nepřesností co do informací uvedených v předmětném katalogu; 5) nenese odpovědnost za případné škody vzniklé v důsledku obdržení zboží s jinými vlastnostmi, než je uvedeno na obrázcích.

II. Navzdory mimořádnému úsilí vynaloženému firmou TOYA S.A. tato nemůže garantovat, zda informace uvedené v tomto katalogu zcela odpovídají skutečnosti.

III. Veškerá rozhodnutí přijatá na základě informací uvedených v předmětném katalogu jsou přijímána na vlastní riziko osoby, která tyto informace využívá.

H

I. A TOYA S.A. tájékoztatja, hogy: 1) a jelen katalógus a polgári jog szerint nem kereskedelmi ajánlat; 2) a jelen katalógusban bemutatott árucikkek a valóságban elterhetnek a képeken látható mintáktól, különösen a külső tulajdonságok, mint a méret, szín, csomagolási mód, a csomagban lévő tárgyak száma tekintetében; 3) nem vállal felelősséget a csomagolás módjában vagy az árucikkek olyan tulajdonságaiban történt változtatásokért, amelyek nem befolyásolják lényeges módon annak rendeltetését vagy a felhasználás módját; 4) nem vállal felelősséget a jelen katalógusban lévő információk pontatlanságáért; 5) nem vállal felelősséget azokért az esetleges károkért, amik az áruknak a fényképeken látható tulajdonságoktól eltérő tulajdonságokkal történő leszállításából erednek.

II. A TOYA S.A. minden igyekezete ellenére nem tudja garantálni, hogy a jelen katalógusban található információk teljes egészében megfelelnek a valóságnak.

III. A tárgyi katalógusban található információk alapján meghozott bármilyen döntés annak a személynek a rizikója, aki ezeket az információkat felhasználja.

RO

I. TOYA S.A. informează că: 1) prezentul catalog nu constituie ofertă în înțelesul dreptului civil; 2) articolele prezentate în prezentul catalog se pot diferi față de mostrele din fotografiile, în special aspectul exterior, adică mărimea, culoarea, modul de ambalare, cantitatea obiectelor în ambalaj; 3) nu-și asumă răspunderea referitor la mici diferențe la modul de ambalare sau la articole al căror proprietăți nu au influență referitor la destinația sau modul lor de utilizare; 4) nu-și asumă răspunderea referitor la orice inexactitate sau imprecizie, datorită informațiilor cuprinse în catalogul respectiv; 5) nu-și asumă răspunderea referitor la o eventuală pagubă ca urmare a primirii marfei cu alte proprietăți decât cele prezentate pe fotografiile.

II. Cu toate strădanile TOYA S.A., firma nu poate garanta că, informațiile din prezentul catalog corespund realității.

III. Orice decizie preluată în baza informațiilor cuprinse în catalogul respectiv, sunt preluate pe riscul și răspunderea persoanei care a făcut folos de aceste informații.

E

I. TOYA S.A. comunica lo siguiente: 1) el presente catálogo no constituye una oferta, en el sentido que la noción adquiere en la ley civil; 2) los artículos presentados en el presente catálogo pueden en realidad diferir de los modelos indicados en las fotografías, especialmente en cuanto a sus propiedades externas, es decir el tamaño, el color, el empaque o la cantidad de los objetos en el empaque; 3) la empresa no se hace responsable por pequeñas diferencias en cuanto al empaque o las propiedades de los artículos, siempre y cuando estas diferencias no afectan el propósito o el modo de operación de las herramientas; 4) la empresa no se hace responsable por ninguna imprecisión en cuanto a la información presentada en el presente catálogo; 5) la empresa no se hace responsable por ningún daño que surja del hecho de que los artículos recibidos difieran de los artículos presentados en las fotografías en cuanto a sus propiedades.

II. A pesar de los mejores intentos de parte TOYA S.A. la empresa no puede garantizar que la información presentada en el presente catálogo corresponda completamente a la realidad.

III. Todas las decisiones tomadas en base a la información presentada en el presente son responsabilidad de la persona que recurra a la dicha información.

ZNAJDŹ NAS TUTAJ:
FIND US HERE:



[linkedin.com/company/toya-s-a](https://www.linkedin.com/company/toya-s-a)



[instagram.com/yato_polska](https://www.instagram.com/yato_polska)



[facebook.com/yatopolska](https://www.facebook.com/yatopolska)



[youtube.com/yatoteam](https://www.youtube.com/yatoteam)





MANUFACTURER / PRODUCENT

TOYA S.A.
ul. Sołtysowicka 13-15
51-168 Wrocław
Poland
☎ (+48 71) 32 46 200
fax: (+48 71) 32 46 370
sales@yato.pl (domestic)
export@yato.pl (export)
import@yato.pl (import)

ODDZIAŁ WARSZAWSKI
Teren ProLogis Park Nadarzyn
al. Kasztanowa 160
05-831 Młochów k. Warszawy
Poland
☎ (+48 22) 73 82 800
☎ (+48 22) 73 82 828
sales@yato.pl (domestic)
export@yato.pl (export)

YOUR TRUSTED SUPPLIER: / TWÓJ ZAUFANY DOSTAWCA:



www.yato.com

**GET ACQUAINTED WITH OUR WIDE OFFER:
ZOBACZ NASZĄ BOGATĄ OFERTĘ:**

