

PROFESSIONAL
KITCHEN EQUIPMENT



yatogastro.com

YATO



PROFESSIONAL
KITCHEN EQUIPMENT



TABLE OF CONTENTS

Cookware 3-6
Pots and saucepans 3-4
Stainless steel frying pans 5
Aluminium frying pans with teflon coating 6
GN containers 7-8
Stainless steel GN containers 7
Polycarbonate GN containers 8
Containers, jugs, scoops 9-10
Buckets 9
Jugs 9
Cutlery container 9
Food storage containers 9
Kettle paddle 10
Container for bulk products 10
Scoops 10
Kitchen utensils 11-15
Forged steel knives 11
Kitchen scissors 11
Can opener 11
Knife and scissor sharpeners 12
Chopping boards 13
HACCP chopping boards 13
Rods 13
Narrow spatulas 14
Universal tongs 14
Colander spoons 14
Sieves 14
Chef's torch 15
Pizza meshes 15
Sauce dispensers 15
Buffet 16-23
Soup kettle 16
Buffet heaters 17
Water boilers 18-19
Vacuum flasks 19-20
Drink dispenser 20
Jugs 21
Tiered platter for fruit and biscuits 21
Tongs 21
Buffet accessories 22
Banquet trays 23
Waiter trays 23
Bar 24-26
Ice buckets 24
Wine bottle cooler 24
Champagne bucket 24
Cocktail shakers 24
Reception bell 25
Citrus juicer 25
Bartending spoon 25
Bar containers and organisers 25
Additional cup for the blender 25
Bartender mats 26
Drink dispensers 26
Bottle opener 26
Plugs with dispensers 26

Mechanical processing equipment 27-45
Bone saws 27
Meat tenderizers 28
Meat mincer with Unger system 29
Meat mincers 30-33
Sausage stuffers 34
Meat and cheese slicers 35
Tomato slicers 36
French fry cutter 36
Vegetable shredder 37-38
Discs for vegetable shredder 39
Planetary mixers 40-43
Spiral mixers 44-45
Thermal processing equipment 46-61
Induction cookers 46
Grill plates 47
Contact grills 48-49
Gas-fired grills 50-55
Cast iron plate for gas grills 55
Automatic rotisserie for gas grills 56
Barbecue grill protective covers 56
Grill basket 56
Electric grill brush 56
Deep fryers 57-59
Frying machines 60
Pancake maker 61
Rice cookers 61
Thermally insulated containers and cabinets for catering 62-64
Food transport containers 62
Thermally insulated catering containers and cabinets 63-64
Thermally insulated beverage dispenser 64
Transport and storage 65-70
Waiter trolleys 65-66
Service trolleys 66
Transport trolleys 67
Platform trolley 68
Work tables 69
Slatted racks 70
Hanging shelves 70
Vacuum packaging machines 71-73
Adjustable packaging machines 71
Free-standing packaging machines 71
Bags for vacuum packaging machines 72
Insulating spheres for sous vide cooking 72
Industrial vacuum packaging machine 73
Refrigeration 74-92
Cooling and freezing cabinets 74
Cooling and freezing tables 75-78
Freezing cabinet for ice cream cuvettes 79
Glass cooling cabinets and tables 79
Cabinets and tables for bakery 80
Salad cooling tables 81
Pizza cooling tables 82
Accessories for cooling cabinets and tables 83
Cooling extensions 84
Refrigerated display cases for sushi 85
Refrigerated display cases for bottles and accessories 86
Chest freezers 87
Refrigerated display cases 88-92
Sanitation 92
Sink with knee switch 92

Pots and saucepans

- | | |
|------------------------------|--------------------------|
| DE Töpfe und Stielkasserolen | ES Ollas y sartenes |
| RU Кастрюли и сотейники | FR Pots et casseroles |
| UK Каструлі і сковороди | PT Panelas e frigideiras |
| LT Puodai ir prikaistuviai | IT Pentole e tegami |
| LV Katli un kastroļi | BG Тенджери и касероли |
| CS Hrnce a pánve | EL Κατσαρόλες και |
| SK Hrnce a kastroly | κατσαρόλákια |
| HU Edények és serpenyők | ZT 不锈钢带盖汤锅 |
| RO Oale și tigăi pentru sos | |

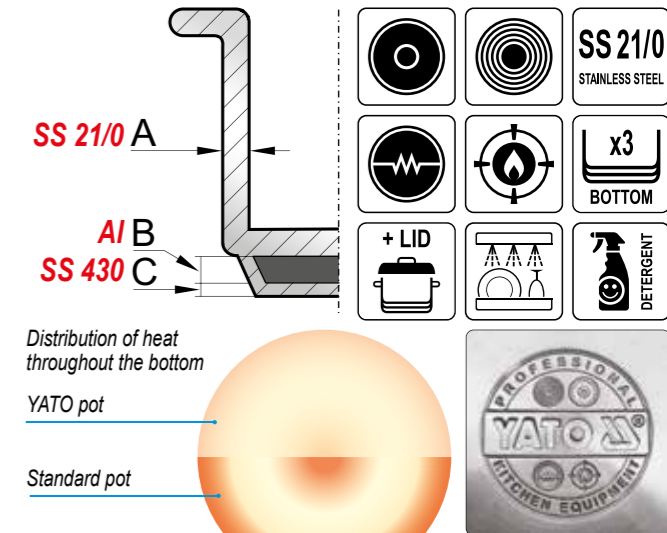

Deep pots with lids

YATO	Ø (cm)	H (cm)	V (l)	A (mm)	B (mm)	C (mm)
YG-00001	16	12	2.4	0.8	4.0	0.8
YG-00002	20	20	6.3	0.8	4.0	0.8
YG-00003	24	20	9.0	0.8	4.0	0.8
YG-00004	28	25	15.4	0.8	4.0	0.8
YG-00005	32	26	20.9	1.0	4.0	0.8
YG-00006	32	32	25.7	1.0	4.0	0.8
YG-00007	36	36	36.6	1.0	4.0	0.8
YG-00008	40	40	50.3	1.0	4.0	1.0
YG-00009	45	45	71.6	1.2	4.0	1.0
YG-00010	50	50	98.2	1.2	4.0	1.0

Medium pots with lids

YATO	Ø (cm)	H (cm)	V (l)	A (mm)	B (mm)	C (mm)
YG-00021	16	9.5	1.9	0.8	4.0	0.8
YG-00022	20	14	4.4	0.8	4.0	0.8
YG-00023	24	16	7.2	0.8	4.0	0.8
YG-00024	28	18	11.1	0.8	4.0	0.8
YG-00025	32	20	16.1	1.0	4.0	0.8
YG-00026	36	22	22.4	1.0	4.0	0.8
YG-00027	40	30	37.7	1.0	4.0	1.0
YG-00028	45	36	57.3	1.2	4.0	1.0
YG-00029	50	32	62.8	1.2	4.0	1.0

Low pots with lids

YATO	Ø (cm)	H (cm)	V (l)	A (mm)	B (mm)	C (mm)
YG-00040	20	10.5	3.3	0.8	4.0	0.8
YG-00041	24	11	5.0	0.8	4.0	0.8
YG-00042	28	13	8.0	0.8	4.0	0.8
YG-00043	32	16	12.9	1.0	4.0	0.8
YG-00044	36	18	18.3	1.0	4.0	0.8
YG-00045	40	25	31.4	1.0	4.0	1.0



Stewing pot with lid

YATO	Ø (cm)	H (cm)	V (l)	A (mm)	B (mm)	C (mm)
YG-00055	36	11	11.2	1.0	4.0	0.8

Pans with lids

YATO	Ø (cm)	H (cm)	V (l)	A (mm)	B (mm)	C (mm)
YG-00060	16	9.5	1.9	0.8	4.0	0.8
YG-00061	20	10.5	3.3	0.8	4.0	0.8
YG-00062	24	11	5	0.8	4.0	0.8
YG-00063	28	13	8	0.8	4.0	0.8

Saucepans

YATO	Ø (cm)	H (cm)	V (l)	A (mm)	B (mm)	C (mm)
YG-00080	20	6.5	2	0.8	4.0	0.8
YG-00081	24	7.5	3.4	0.8	4.0	0.8

Pots with lids

- DE Töpfe mit Deckel
- RU Горшки с крышками
- UK Горщики з кришками
- LT Puodai su dangčiais
- LV Podi ar vākiem
- CS Hrnce s víčky
- SK Hrnce s pokrievkami
- HU Fedeles edények
- RO Ghivece cu capace
- ES Ollas con tapa
- FR Pots avec couvercles
- PT Potes com tampa
- IT Pentole con coperchio
- BG Саксии с капаци
- EL Γλάστρες με καπάκια
- ZT 带盖花盆

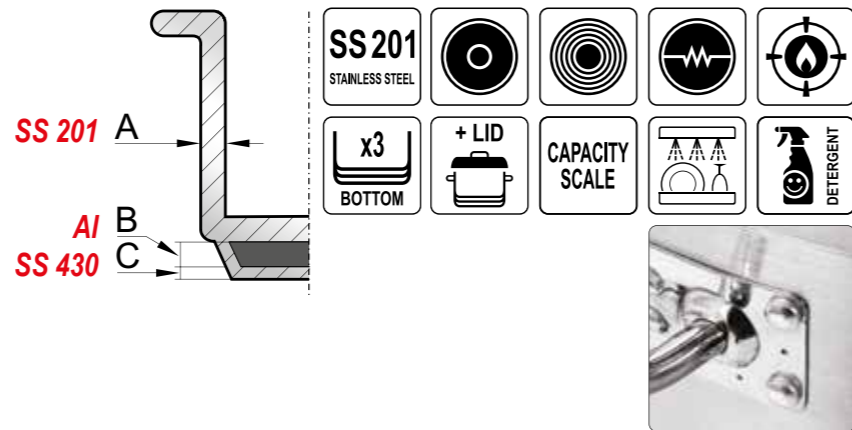

SS 201 STAINLESS STEEL				
x3 BOTTOM	+ LID	CAPACITY SCALE		

Distribution of heat throughout the bottom

YATO pot

Standard pot

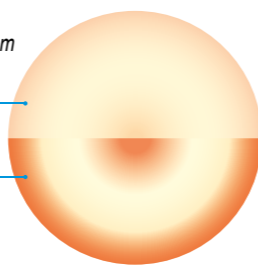

Deep pots with lids

YATO 	∅ (cm)	H (cm)	V (l)	A (mm)	B (mm)	C (mm)
YG-00011	20	20	6	1.0	4.0	0.8
YG-00012	25	25	12	1.0	4.0	0.8
YG-00013	28	28	17	1.0	4.0	0.8
YG-00014	30	30	21	1.0	4.0	0.8
YG-00015	32	32	25	1.0	4.0	0.8
YG-00016	36	36	36	1.0	4.0	0.8
YG-00017	38	38	43	1.0	4.0	0.8
YG-00018	40	40	50	1.0	4.0	0.8
YG-00019	45	45	71	1.2	4.0	1.0
YG-00020	50	50	98	1.2	4.0	1.0

Medium pots with lids

YATO 	∅ (cm)	H (cm)	V (l)	A (mm)	B (mm)	C (mm)
YG-00046	25	18	9	1.0	4.0	0.8
YG-00047	30	20	14	1.0	4.0	0.8
YG-00048	32	22	17	1.0	4.0	0.8
YG-00049	36	24	24	1.0	4.0	0.8
YG-00050	38	24	27	1.0	4.0	0.8
YG-00051	40	26	32	1.0	4.0	0.8
YG-00052	50	30	58	1.2	4.0	1.0

Stainless steel frying pans

- DE Pfannen aus rostfreiem Edelstahl
- RU Стальные сковороды
- UK Каструлі з нержавіючої сталі
- LT Nerūdijančio plieno keptuvės
- LV Nerūsējošā tērauda pannas
- CS Pánve z nerezovací oceli
- SK Panvice z nehrdzavejúcej ocele
- HU Rozsdamentes acélból készült serpenyők
- RO Tigăi din oțel inoxidabil
- ES Sartenes de acero inoxidable
- FR Casseroles en acier inoxydable
- PT Panelas de aço inoxidável
- IT Padelle in acciaio inossidabile
- BG Тигани от неръждаема стомана
- EL Τηγάνια από ανοξείδωτο ατσάλι
- ZH 不锈钢平底煎锅

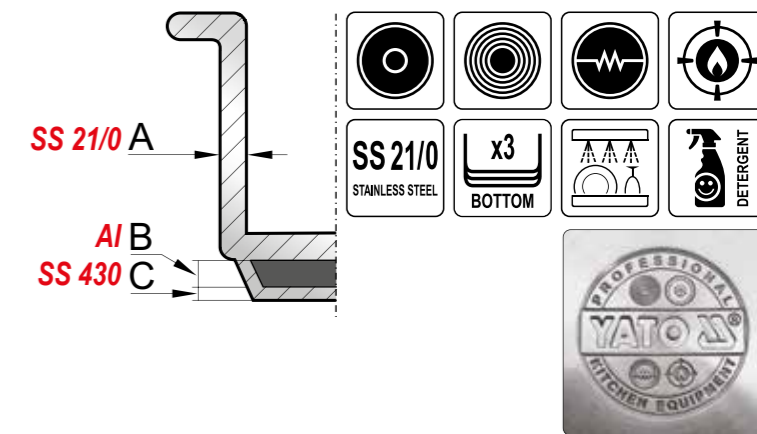

Distribution of heat throughout the bottom

YATO frying pan

Standard frying pan

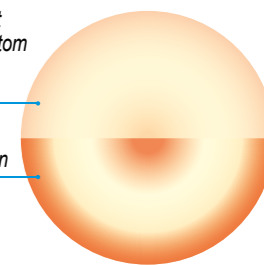

YATO 	∅ (cm)	H (cm)	V (l)	A (mm)	B (mm)	C (mm)
YG-00100	20	4	1.3	0.8	4.0	0.8
YG-00101	24	5	2.3	0.8	4.0	0.8
YG-00102	28	5	3.1	0.8	4.0	0.8



YATO 	∅ (cm)	H (cm)	V (l)	A (mm)	B (mm)	C (mm)
YG-00103	32	5	4	1.0	4.0	0.8
YG-00104	36	6	6.1	1.0	4.0	0.8
YG-00105	40	7	8.8	1.0	4.0	0.8

Aluminium frying pans with Teflon™ Platinum Plus coating

- | | |
|--------------------------|--------------------------|
| DE Aluminiumpfannen | ES Bandejas de aluminio |
| RU Алюминиевые сковороды | FR Plateaux en aluminium |
| UK Алюмінієві каструлі | PT Panelas de alumínio |
| LT Aliuminio keptuvės | IT Padelle in alluminio |
| LV Alumīnija pannas | BG Алюминиеви тигани |
| CS Hliníkové pánve | EL Τηγάνια αλουμινίου |
| SK Hliníkové panvice | ZH 涂层铝制煎锅 |
| HU Alumínium serpenyők | |
| RO Tigăi profesionale | |

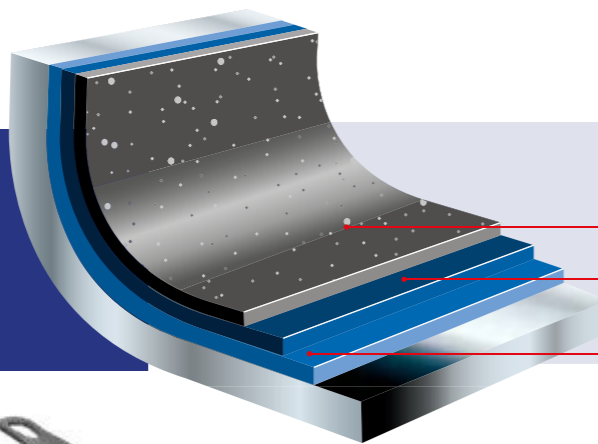
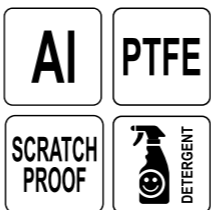

Scratch-resistant top layer

Reinforced intermediate layer

Abrasion-resistant hardened mineral bottom layer

The PTFE coating is capable of withstanding even the hardest challenges in gastronomy. It contains microscopic particles of the hardest minerals that form an extraordinarily resilient structure. It is so durable that you can even use metal spatulas while frying without worrying about any significant scratches. Additionally, the body of the pan is made of cast aluminium, which ensures homogeneous and quick heating.

Universal frying pans

YATO 	∅ (cm)*
YG-00131	24
YG-00132	28
YG-00133	32

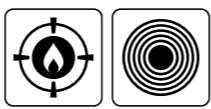

Frying pans for pancakes

YATO 	∅ (cm)*
YG-00152	26
YG-00153	29



Frying pan for fish

YATO 	∅ (cm)*
YG-00155	29 x 40



Frying pans placed on induction hob

YATO 	∅ (cm)*
YG-00160	24
YG-00161	28

* external diameter



Stainless steel GN containers

- | |
|--|
| DE Behälter GN aus rostfreiem Edelstahl |
| RU Гастроёмкости GN из нержавеющей стали |
| UK Контейнери GN з нержавіючої сталі |
| LT Nerūdijančio plieno GN indas |
| LV Nerūsējošā tērauda GN trauki |
| CS Nádobý GN z nerezovací oceli |
| SK GN nádoby z nehrdzavejúcej ocele |
| HU Rozsdamentes acélból készült GN tartályok |
| RO Containere GN din oțel inoxidabil |
| ES Contenedores GN de acero inoxidable |
| FR Récipients GN en acier inoxydable |
| PT Recipientes GN em aço inoxidável |
| IT Contenitore GN di acciaio inossidabile |
| BG GN контейнери от неръждаема стомана |
| EL Δοχεία GN από ανοξείδωτο ασάλι |
| ZH 不锈钢份数盘 |

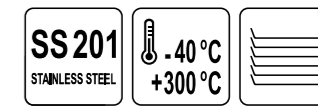

1/1	2/3
1/2	1/3
1/4	1/4
1/9	1/9
1/6	1/6

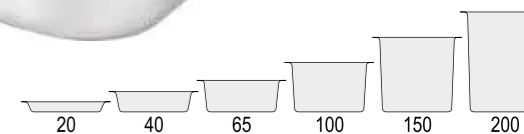

GN 1/1 – 530 x 325 mm

YATO 	H (mm)	V (l)
YG-00250	20	3.0
YG-00251	40	6.0
YG-00252	65	8.5
YG-00253	100	13.5
YG-00254	150	20.5
YG-00255	200	26.0

GN 2/3 – 354 x 325 mm

YATO 	H (mm)	V (l)
YG-00302	65	6.5
YG-00303	100	9.0
YG-00304	150	13.0

GN 1/2 – 325 x 265 mm

YATO 	H (mm)	V (l)
YG-00260	20	2.0
YG-00261	40	4.0
YG-00262	65	4.5
YG-00263	100	7.0
YG-00264	150	10.0
YG-00265	200	12.5

GN 1/3 – 325 x 176 mm

YATO 	H (mm)	V (l)
YG-00270	20	0.8
YG-00271	40	1.5
YG-00272	65	2.5
YG-00273	100	4.0
YG-00274	150	6.0



GN 1/4 – 265 x 162 mm

YATO 	H (mm)	V (l)
YG-00282	65	1.8
YG-00283	100	3.0
YG-00284	150	4.5



GN 1/6 – 176 x 162 mm

YATO 	H (mm)	V (l)
YG-00290	65	1.0
YG-00291	100	1.7
YG-00292	150	2.5
YG-00293	200	3.4



GN 1/9 – 176 x 108 mm

YATO 	H (mm)	V (l)
YG-00295	65	0.6
YG-00296	100	1.0



Container size designation in the corner



GN 1/1 – 530 x 325 mm perforated

YATO 	H (mm)	V (l)
YG-00340	20	3.0
YG-00341	40	6.0
YG-00342	65	8.5
YG-00343	100	13.5
YG-00344	150	20.5
YG-00345	200	26.0



GN 2/3 – 354 x 325 mm perforated

YATO 	H (mm)	V (l)
YG-00360	65	6.5
YG-00361	100	9.0



GN 1/2 – 325 x 265 mm perforated

YATO 	H (mm)	V (l)
YG-00355	65	4.5
YG-00356	100	7.0
YG-00357	150	10.0

Stainless steel lids for GN containers

YATO 	FOR:
YG-00370	GN 1/1
YG-00371	GN 1/2
YG-00372	GN 1/3
YG-00373	GN 1/4
YG-00374	GN 1/6
YG-00375	GN 1/9
YG-00377	GN 2/3

Polycarbonate GN containers

DE Behälter GN aus Polycarbonat
RU Гастроёмкости GN из поликарбоната
UK Контейнери GN з полікарбонату
LT Polikarbonato GN indas
LV Poliarbonāta GN trauki
CS Nádoby GN z polykarbonátu
SK GN nádoby z polykarbonátu
HU Polikarbonát GN tartályok
RO Containere GN din policarbonat
ES Contenedores GN de policarbonato
FR Récipients GN en polycarbonate
PT Recipientes GN em policarbonato
IT Contenitore GN in policarbonato
BG GN контейнери от поликарбонат
EL Δοχεία GN από πολυανθρακικό
ZH 聚碳酸酯份数盆

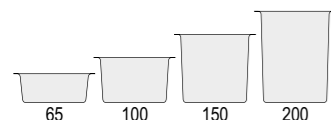
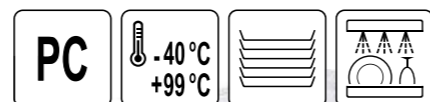

GN 1/1 – 530 x 325 mm

YATO	H (mm)	V (l)
YG-00390	65	8.5
YG-00391	100	13.0
YG-00392	150	19.5
YG-00393	200	25.6



GN 1/2 – 325 x 265 mm

YATO	H (mm)	V (l)
YG-00400	65	3.9
YG-00401	100	5.9
YG-00402	150	8.9
YG-00403	200	11.7



GN 1/3 – 325 x 176 mm

YATO	H (mm)	V (l)
YG-00410	65	2.4
YG-00411	100	3.6
YG-00412	150	5.3
YG-00413	200	6.9



GN 1/4 – 265 x 162 mm

YATO	H (mm)	V (l)
YG-00419	65	1.7
YG-00420	100	2.5
YG-00421	150	3.7



GN 1/6 – 176 x 162 mm

YATO	H (mm)	V (l)
YG-00425	65	1.0
YG-00426	100	1.5
YG-00427	150	2.2



GN 1/9 – 176 x 108 mm

YATO	H (mm)	V (l)
YG-00430	65	0.57
YG-00431	100	0.85

Polycarbonate lids for GN containers

YATO	FOR:
YG-00434	GN 1/1
YG-00435	GN 1/2
YG-00436	GN 1/3
YG-00437	GN 1/4
YG-00438	GN 1/6
YG-00439	GN 1/9



Polycarbonate drain shelves for GN containers

YATO	FOR:
YG-00460	GN 1/1
YG-00461	GN 1/2
YG-00462	GN 1/3
YG-00463	GN 1/4
YG-00464	GN 1/6

Buckets

DE Eimer
RU Ведро
UK Відра
LT Kibirai
LV Kausi
CS Kbelíky
SK Vedrá
HU Vödrök
RO Cupe
ES Cubos
FR Seaux
PT Baldes
IT Secchi
BG Кофи
EL Κουβάδες
ZH 水桶

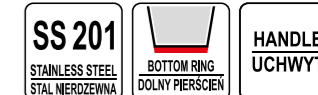

YATO	V (l)	Ø (cm)	H (cm)
YG-00650	12	25/24	27
YG-00651	16	30/25	30
YG-00652	28	35/30	35

Scale jugs

DE Messbecher
RU Мерные кувшины
UK Глечики з мірками
LT Asočiai su matavimo skale
LV Mērkrūzes
CS Džbány s měrkou
SK Džbany s mierkou
HU Mérőkanna
RO Căni de măsură
ES Jarra medidora
FR Cruche à mesurer
PT Jarros de medição
IT Brocca con misurino
BG Кани с деления
EL Κανάτα με μέτρο
ZH 量壶



YATO	V (l)	Ø (mm)	H (mm)
YG-07282	0.5	90	135
YG-07284	1	115	165
YG-07286	2	150	205
YG-07287	3	170	230
YG-07288	5	195	270



Container for cutlery

DE Besteckbehälter
RU Емкость для столовых приборов
UK Контейнер для столових приборів
LT Stalo įrankių padėklas
LV Galda piederumu trauki
CS Nádoby na příbory
SK Nádoby na príbor
HU Evőeszköz tartó
RO Organizator pentru tacâmuri
ES Cubertero
FR Range-couverts
PT Recipiente para talheres
IT Contenitore per posate
BG Контейнер за прибори
EL Δοχείο για μαχαίροπύρωνα
ZH 4格餐具收纳盒



YATO	(mm)
YG-02665	520 x 290 x 95

Food storage containers

DE Behälter zur Aufbewahrung von Lebensmitteln
RU Контейнеры для хранения пищевых продуктов
UK Контейнери для зберігання продуктів харчування
LT Maisto saugojimo indai
LV Pārtikas uzglabāšanas trauki
CS Nádoby k uchování potravin
SK Nádoby na uschovávanie potravín
HU Ételároló tartályok
RO Containere pentru depozitarea alimentelor
ES Contenedores para el almacenamiento de alimentos
FR Récipients pour le stockage des aliments
PT Recipientes para armazenamento de alimentos
IT Contenitore per la conservazione di alimenti
BG Контейнери за съхранение на храни

EL Δοχεία αποθήκευσης τροφίμων
ZH PP圓形食品儲物桶

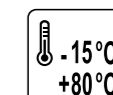

Round containers

YATO	V (l)	Ø (mm)	H (mm)
YG-00510	1	128	120
YG-00511	2	183	110
YG-00512	4	183	210
YG-00513	6	222	200
YG-00514	7.5	222	270
YG-00515	10	310	210
YG-00516	15	310	300
YG-00517	20	310	370



Covers for round containers

YATO	Ø (mm)	FOR:
YG-00518	132	YG-00510
YG-00519	187	YG-00511, YG-00512
YG-00520	226	YG-00513, YG-00514
YG-00521	316	YG-00515, YG-00516, YG-00517

Food storage containers

DE Behälter zur Aufbewahrung von Lebensmitteln
RU Контейнеры для хранения пищевых продуктов
UK Контейнери для зберігання продуктів харчування
LT Maisto saugojimo indai
LV Pārtikas uzglabāšanas trauki
CS Nádoby k uchování potravin
SK Nádoby na uschovávanie potravín
HU Ételtároló tartályok
RO Containere pentru depozitarea alimentelor

ES Contenedores para el almacenamiento de alimentos
FR Récipients pour le stockage des aliments
PT Recipientes para armazenamento de alimentos
IT Contenitore per la conservazione di alimenti
BG Контейнери за съхранение на храни
EL Δοχεία αποθήκευσης τροφίμων
ZH 圆形食品储物桶



-40°C
+99°C

PC

YATO	V (l)	(mm)	H (mm)
YG-00524	22	280 x 280	400

Kettle paddle

DE Rührpaddel für Kessel
RU Мешалка для котла
UK Мішалка для котла
LT Maišytuvas katilui
LV Maisītājs katlam
CS Míchadlo do kotle
SK Miesadlo pre kotol

HU Keverő lapát
RO Paletă pentru amestecat

ES Agitador de caldera
FR Agitateur de chaudière cuisine
PT Agitador para caldeiras
IT Spatola lunga

BG Бъркалка за тенджерата
EL Αναδευτήρας λέβητα
ZH 不锈钢打蛋器

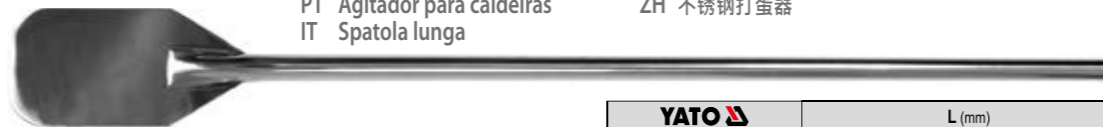

SS18/8
STAINLESS STEEL

YATO	L (mm)
YG-02520	1220

Container for bulk products

DE Behälter für lose Produkte
RU Контейнер для сыпучих продуктов
UK Контейнер для сипучих продуктів
LT Palaidų produktų indas
LV Trauks beramiem produktiem
CS Nádoby na sypké materiály
SK Nádoby na sypké produkty
HU Tartály szórt termékekhez
RO Container pentru produse vrac
ES Contenedor para productos a granel
FR Récipient pour produits en vrac
PT Recipiente para produtos soltos
IT Contenitore per prodotti sfusi
BG Контейнер за насипни продукти
EL Δοχείο για χύμα προϊόντα
ZH 食物配料儲存车



81L
CAPACITY

77kg
SUGAR
63kg
FLOUR
CAPACITY

PP/PC

360°
2x



YATO	V (l)	(mm)
YG-09109	81	760 x 330 x 740

Polycarbonate scoops

DE Schaufeln aus Polycarbonat
RU Совки из поликарбоната
UK Совки з полікарбонату
LT Polikarbonato semtuvėlis šiukšlėms
LV Polikarbonāta lāpstiņas
CS Naběračky z polykarbonátu
SK Lopatky z polykarbonátu

HU Polikarbonát lapát
RO Scafe din policarbonat
ES Paletas de policarbonato
FR Spatule en polycarbonate
PT Colheres de policarbonato
IT Palette in policarbonato
BG Лопатки от поликарбонат

EL Πολυκαρβονικά φαράσια
ZH PC冰铲

PC

-40°C
+99°C

YATO	V (l)	(mm)
YG-02460	0.18	220 x 185
YG-02461	0.95	280 x 210
YG-02462	1.9	280 x 400



YG-02460

YG-02461

YG-02462

Forged steel knives

DE Messer aus Schmiedestahl
RU Ножи из кованой стали
UK Ножі з кованої сталі
LT Kaltinio plieno peiliai
LV Kaltā tērauda naži
CS Nože z kované oceli

SK Nož z kovanej ocele
HU Kovásolt acél kés
RO Cuțite din oțel forjat
ES Cuchillos de acero forjado
FR Couteaux en acier forgé
PT Facas de aço forjado

IT Coltelli in acciaio forgiato
BG Ножове от кована стомана
EL Μαχαίρια από σφυρηλατημένο χάλυβα
ZH 西厨刀



HRC
55-58

GERMAN
STEEL
X50CrMoV15

Smooth handles prevent
residue from accumulation

Ham knife

YATO	L (mm)
YG-02232	290 / 425



Tomato knife

YATO	L (mm)
YG-02227	140 / 245



Paring knife

YATO	L (mm)
YG-02225	90 / 195



Meat fork

YATO	L (mm)
YG-02216	180 / 310

Kitchen scissors

DE Küchenschere
RU Кухонные ножницы
UK Кухонні ножиці
LT Virtuviniai peiliai
LV Virtuves naži
CS Kuchyňské nůžky
SK Kuchynské nožnice
HU Konyhai ollók

RO Foarfeci pentru bucătărie
ES Tijeras de cocina
FR Ciseaux de cuisine
PT Tesouras de cozinha
IT Forbici da cucina
BG Кухненски ножици
EL Ψαλίδια κουζίνας
ZH 厨房剪刀

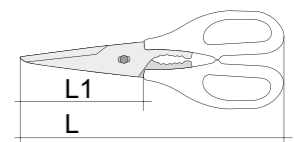

SS2CR13

PP

YATO	L (mm)	L1 (mm)
YG-02365	210	80

Blade thickness: 1,8 mm

ABS

YATO	L (mm)	L1 (mm)
YG-02366	210	70

Blade thickness: 3 mm

ABS x5

YATO	L (mm)	L1 (mm)
YG-02368	200	80

Blade thickness: 1,2 mm



Knife and scissor sharpeners

- | | | | |
|--|--|---|---------------------------------------|
| DE Scheren- und Messerschärfer | CS Ostrůtko na nože a nůžky | ES Afiladoras de cuchillos y tijeras | EL Ακονιστήρια μαχαιριών και ψαλιδιών |
| RU Точилки для ножей и ножниц | SK Nástroje na ostrenie nožov a nožnic | FR Aiguilleurs à couteaux et ciseaux | |
| UK Пристрій для заточування ножів і ножиць | HU Kés- és ollóélező | PT Afiadores de facas e tesouras | ZH 磨刀器 |
| LT Peilių ir žirklių galastuvai | RO Dispozitive pentru ascuțit cuțite și foarfeci | IT Affilatrice per coltelli e forbici | |
| LV Nažu un šķēru asināmie | | BG Точила за заточване на ножове и ножици | |

3-function sharpener for steel and ceramic knives



YATO
YG-02351

EASY CLEAN

3 in 1

DIAMOND BLADE

TUNGSTEN STEEL BLADE



NON-SLIP BASE

2-function sharpener for ceramic and steel knives



YATO
YG-02353

CERAMIC BLADE

FOR CERAMIC KNIVES



NON-SLIP BASE

Can opener

- | | |
|---------------------------|--------------------------|
| DE Dosenöffner | ES Abrelatas |
| RU Консервный нож | FR Ouvre-boîte |
| UK Відкривачка для банок | PT Abridor de latas |
| LT Skardinių atidarytuvas | IT Apriscatole |
| LV Bundžu attaisāmais | BG Отварачка за консерви |
| CS Otvírák na konzervy | EL Ανοιχτήρι κονσερβών |
| SK Otvárač na konzervy | ZH 开罐器 |
| HU Konzervnyitó | |
| RO Desfăcător conserve | |

YATO	∅ (mm)
YG-02430	355



4-function sharpener for scissors, smooth metal knives and ceramic knives



YATO
YG-02352



NON-SLIP BASE

ABS

COARSE

FINE

4 in 1

DIAMOND BLADE

TUNGSTEN STEEL BLADE

FOR METAL KNIVES

2 in 1

FOR METAL KNIVES



NON-SLIP BASE

∅ max
355mm
CAN

H max
310mm
CAN



Chopping boards

- | | | | |
|-----------------------|----------------------|------------------------|--------------------|
| DE Schneidebretter | LV Griešanas dēļi | RO Tocătoare | IT Tagliere |
| RU Разделочные доски | CS Krájecí deska | ES Tablas para cortar | BG Дъски за рязане |
| UK Обробні дошки | SK Dosky na krájanie | FR Planches à découper | EL Σανίδες κοπής |
| LT Pjaustymo lentelės | HU Vágódeszkák | PT Tábuas de cortar | ZH 砧板 |

Chopping boards with a handle



YATO	(mm)
YG-02150	250 x 150 x 10
YG-02153	300 x 220 x 10

Chopping boards compliant with HACCP colour coding

YATO	(mm)	COLOUR
YG-02170	450 x 300 x 13	●
YG-02171	450 x 300 x 13	●
YG-02172	450 x 300 x 13	●
YG-02173	450 x 300 x 13	●
YG-02174	450 x 300 x 13	○
YG-02175	450 x 300 x 13	●
YG-02180	600 x 400 x 20	●
YG-02181	600 x 400 x 20	●
YG-02182	600 x 400 x 20	●
YG-02183	600 x 400 x 20	●
YG-02184	600 x 400 x 20	○
YG-02185	600 x 400 x 20	●

Chopping board scraper

- | | |
|--|------------------------|
| DE Schneidebrett-Schaber | ES Varillas para batir |
| RU Рубанок для очистки разделочных досок | FR Fouets |
| UK Скребок для обробних дощок | PT Batedores |
| LT Pjaustymo lentelių grandiklis | IT Frusta da cucina |
| LV Skrāpis griešanas dēļiem | BG Тел за разбиване |
| CS Škrabka na krájecí desku | EL Αβγοδάρτες |
| SK Škrabka pre dosky na krájanie | ZH 棒 |
| HU Vágódeszka kaparó | |
| RO Răzuitoare pentru tocătoare | |
| ES Rascador para tablas de corte | |
| FR Racleur pour planches à découper | |
| PT Raspador para tábuas de cortar | |
| IT Raschietto per tagliere | |
| BG Ренде за дъски за рязане | |
| EL Ξέστρο για σανίδες κοπής | |
| ZH 砧板刮 | |



YATO	(mm)
YG-02188	220 x 100 x 50

Chopping boards with rubber feet

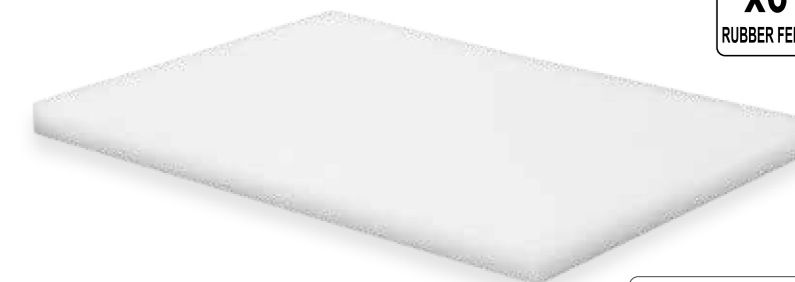

x6
RUBBER FEET

YATO	(mm)
YG-02160	350 x 250 x 20
YG-02163	440 x 290 x 20
YG-02166	500 x 340 x 20
YG-02168	600 x 390 x 20

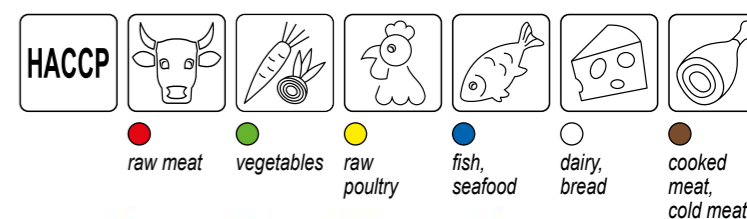

Rods

- | | |
|------------------------|------------------------|
| DE Schneebeesen | ES Varillas para batir |
| RU Шампуры | FR Fouets |
| UK Різки | PT Batedores |
| LT Rankiniai plaktuvai | IT Frusta da cucina |
| LV Putojamās slotiņas | BG Тел за разбиване |
| CS Metly | EL Αβγοδάρτες |
| SK Mietličky | ZH 棒 |
| HU Habverők | |
| RO Teluri | |



YATO	L (mm)
YG-02510	300
YG-02511	400
YG-02512	500
YG-02513	600

Narrow spatulas

DE Schmale Tortenstreichspatel
RU Узкие шпатели
UK Вузькі шпателі
LT Šiaura mentelė
LV Šauras lāpstiņš
CS Úzké špachtle
SK Špachtle úzke
HU Keskeny spatulák
RO Spatule înguste

ES Espátulas de cocina estrechas
FR Spatules de cuisine étroites
PT Espátulas estreitas
IT Spatole strette
BG Тесни шпатули
EL Στενές σπαθίδες
ZH 不锈钢铲



Narrow straight spatulas

YATO	(mm)
YG-02409	205 / 335
YG-02410	255 / 385
YG-02411	310 / 440
YG-02412	355 / 485

Narrow angled spatulas

YATO	(mm)
YG-02415	255 / 385
YG-02416	300 / 430

Colander spoons and sieves

DE Schaumlöffel und Siebe
RU Шумовки и сита
UK Друшляки і сита
LT Kiaurasamčiai ir sieteliai
LV Putu karotes un sieti
CS Dírkované lžíce a síta
SK Zberačky a sitká
HU Csepegtető kanálak és sziták
RO Strecurătoare și site
ES Cucharas coladoras y coladores
FR Araignées et passoires
PT Escumadeiras e peneiras
IT Schiumarola e setaccio
BG Решетъчни лъжици и цедки
EL Τρυπητές κουτάλες και σουρωτήρια
ZH 漏勺和筛子



YATO	Ø (mm)	L (mm)
YG-00600	220	600
YG-00601	260	730

Mesh density: 2 x 2 mm

Mesh density: 5 x 5 mm

YATO	Ø (mm)	L (mm)
YG-00602	155	470
YG-00603	200	510

Sieves for sifting

YATO	Ø (mm)	H (mm)
YG-00615	220	60
YG-00617	280	70

Mesh density: 1 x 1 mm

Thick mesh chinois

YATO	Ø (mm)	L (mm)
YG-00605	120	310
YG-00606	160	350

Mesh density: 0.5 x 0.5 mm



Mesh density: 5 x 5 mm

YATO	Ø (mm)	L (mm)
YG-02593	120	475
YG-02595	140	570
YG-02598	160	580



Mesh density: 5 x 5 mm

YATO	Ø (mm)	L (mm)
YG-02593	120	475
YG-02595	140	570
YG-02598	160	580



Mesh density: 5 x 5 mm

YATO	Ø (mm)	L (mm)
YG-02593	120	475
YG-02595	140	570
YG-02598	160	580



Mesh density: 5 x 5 mm

YATO	Ø (mm)	L (mm)
YG-02593	120	475
YG-02595	140	570
YG-02598	160	580



Mesh density: 5 x 5 mm

YATO	Ø (mm)	L (mm)
YG-02593	120	475
YG-02595	140	570
YG-02598	160	580



Mesh density: 5 x 5 mm

YATO	Ø (mm)	L (mm)
YG-02593	120	475
YG-02595	140	570
YG-02598	160	580



Mesh density: 5 x 5 mm

YATO	Ø (mm)	L (mm)
YG-02593	120	475
YG-02595	140	570
YG-02598	160	580



Mesh density: 5 x 5 mm

YATO	Ø (mm)	L (mm)
YG-02593	120	475
YG-02595	140	570
YG-02598	160	580



Mesh density: 5 x 5 mm

YATO	Ø (mm)	L (mm)
YG-02593	120	475
YG-02595	140	570
YG-02598	160	580



Mesh density: 5 x 5 mm

YATO	Ø (mm)	L (mm)
YG-02593	120	475
YG-02595	140	570
YG-02598	160	580



Mesh density: 5 x 5 mm

YATO	Ø (mm)	L (mm)
YG-02593	120	475
YG-02595	140	570
YG-02598	160	580



Mesh density: 5 x 5 mm

YATO	Ø (mm)	L (mm)
YG-02593	120	475
YG-02595	140	570
YG-02598	160	580



Mesh density: 5 x 5 mm

YATO	Ø (mm)	L (mm)
YG-02593	120	475
YG-02595	140	570
YG-02598	160	580



Mesh density: 5 x 5 mm

YATO	Ø (mm)	L (mm)
YG-02593	120	475
YG-02595	140	570
YG-02598	160	580



Mesh density: 5 x 5 mm

YATO	Ø (mm)	L (mm)
YG-02593	120	475
YG-02595	140	570
YG-02598	160	580



Mesh density: 5 x 5 mm

YATO	Ø (mm)	L (mm)
YG-02593	120	475
YG-02595	140	570
YG-02598	160	580



Mesh density: 5 x 5 mm

YATO	Ø (mm)	L (mm)
YG-02593	120	475
YG-02595	140	570
YG-02598	160	580



Mesh density: 5 x 5 mm

YATO	Ø (mm)	L (mm)
YG-02593	120	475
YG-02595	140	570
YG-02598	160	580



Mesh density: 5 x 5 mm

YATO	Ø (mm)	L (mm)
YG-02593	120	475
YG-02595	140	570
YG-02598	160	580



Mesh density: 5 x 5 mm

YATO	Ø (mm)	L (mm)
YG-02593	120	475
YG-02595	140	570
YG-02598	160	580



Mesh density: 5 x 5 mm

YATO	Ø (mm)	L (mm)
YG-02593	120	475
YG-02595	140	570
YG-02598	160	580



Mesh density: 5 x 5 mm

YATO	Ø (mm)	L (mm)
YG-02593	120	475
YG-02595	140	570
YG-02598	160	580



Mesh density: 5 x 5 mm

YATO	Ø (mm)	L (mm)
YG-02593	120	475
YG-02595	140	570
YG-02598	160	580



Mesh density: 5 x 5 mm

YATO	Ø (mm)	L (mm)
YG-02593	120	475
YG-02595	140	570
YG-02598	160	580



Mesh density: 5 x 5 mm

YATO	Ø (mm)	L (mm)
YG-02593	120	475
YG-02595	140	570
YG-02598	160	580



Mesh density: 5 x 5 mm

YATO	Ø (mm)	L (mm)
YG-02593	120	475
YG-02595	140	570
YG-02598	160	580



Mesh density: 5 x 5 mm

YATO	Ø (mm)	L (mm)
YG-02593	120	475
YG-02595	140	570
YG-02598	160	580



Mesh density: 5 x 5 mm

YATO	Ø (mm)
------	--------

Soup kettle

DE Suppenkessel
RU Мармит электрический для супа
UK Казанок для супів
LT Sriubos marmitas
LV Katls zupām
CS Kotlík na polévku
SK Kotlíky na polievku
HU Levesmelegítő
RO Supieră electrică
ES Olla de sopa
FR Marmite à soupe
PT Chaleira de sopa
IT Bollitore per zuppa
BG Супник
EL Καζάνι για σούπες
ZH 汤壶

400W **9L** **SS 304 BARELL** **35-85 °C** **x4 PLASTIC FEET**

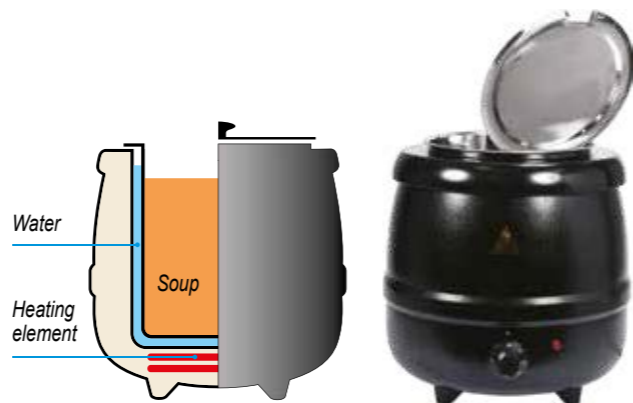

YATO	V (l)	(mm)	(W)
YG-04250	9	340 x 340 x 370	400

Buffet heaters

DE Speisenwärmer
RU Мармиты буфетные
UK Буфетні підігрівачі
LT Maisto šildytuvai
LV Bufešu sildītāji
CS Bufetové ohřivače
SK Bufetové ohrievače
HU Büfé melegítő
RO Chafing dish
ES Calentadores de comida para buffet
FR Buffets chauffants

PT Aquecedores para buffets
IT Scaldavivande per catering
BG Настолни бен марита
EL Θερμάστρα μπουφέ
ZH 自助餐炉

FOR: **GN 1/1**
max 65 mm

90°
COVER
OPEN ANGLE

x2
HANDLES



Roll-top heater GN 1/1

YATO	V (l)	(mm)
YG-04120	9	600 x 350 x 430

FOR: **GN 1/1**
max 65 mm

180°
COVER
OPEN ANGLE



Roll-top heater GN 1/1

YATO	V (l)	(mm)
YG-04140	9	640 x 420 x 440

SEE ALSO
tongs and spoons



p. 22

SS 201
STAINLESS STEEL

HEAT SOURCE:
FUEL / HEATER



x2
HANDLES



Heater with kettles

YATO	V (l)	(mm)
YG-04125	2 x 4.5	600 x 350 x 370

FOR: **GN**
ø 350 mm

180°
COVER
OPEN ANGLE



Round roll-top heater

YATO	V (l)	(mm)
YG-04145	6	470 x 450

Water boilers

DE Wasserkocher
RU Электрокипятильник воды
UK Термопоти
LT Vandens viryklės
LV Tējannas
CS Vaříče na vodu
SK Ohrievače na varenie vody
HU Vízmelegítő
RO Fierbător
ES Hervidores de agua
FR Bouilloires d'eau
PT Dispensadores de água
IT Distributori a termos per acqua
BG Машини за чай
EL Βραστήρας νερού
ZH 开水桶



YATO	V (l)	(W)
YG-04290	8.5	1400-1650
YG-04292	14.1	2100-2600
YG-04293	19.1	2500-3000

Water boilers

DE Wasserkocher
RU Электрокипятильник воды
UK Термопоти
LT Vandens viryklės
LV Tējannas
CS Vaříče na vodu
SK Ohrievače na varenie vody
HU Vízmelegítő
RO Fierbător
ES Hervidores de agua
FR Bouilloires d'eau
PT Dispensadores de água
IT Distributori a termos per acqua
BG Машини за чай
EL Βραστήρας νερού
ZH 开水桶



YATO	V (l)	(W)
YG-04301	8.8	1000
YG-04310	10.0	1650
YG-04315	15.0	1800
YG-04318	16.0	2600
YG-04324	22.0	3000

Collection tray

DE Abtropftablett
RU Поддон для сбора капель
UK Піддон для стоків
LT Nulaušėjimo dėklas
LV Notekparlāte
CS Odtékací táč
SK Odkvapkováacia miska

HU Csepegtető tábla
RO Tavă colectoare
ES Bandeja con rejilla para el goteo
FR Plateau d'égouttement
PT Bandeja de gotejamento

IT Vaschetta raccogliacqua
BG Тавичка за оттичане на вода
EL Δοχείο συλλογής
ZH 滴水盘



YATO	FOR:
YG-04325	YG-04301, YG-04310, YG-04315, YG-04318, YG-04324

Water boilers

DE Wasserkocher
RU Электрокипятильник воды
UK Термопоти
LT Vandens viryklės
LV Tējannas
CS Vaříče na vodu
SK Ohrievače na varenie vody
HU Vízmelegítő
RO Fierbător
ES Hervidores de agua
FR Bouilloires d'eau
PT Dispensadores de água
IT Distributori a termos per acqua
BG Машини за чай
EL Βραστήρας νερού
ZH 开水桶



YATO	V (l)	(W)
YG-04311	9.0	2000
YG-04316	12.0	2500
YG-04319	18.0	2500
YG-04321	25.0	3000

Vacuum flasks

DE Tischthermoskannen
RU Настольные термосы
UK Столові термоси
LT Stalo termosai
LV Galda termosi
CS Stolní termoska
SK Stolové termosky
HU Asztali termosok
RO Termosuri

ES Jarras y termos de mesa
FR Thermos isothermes pour la restauration
PT Garrafa térmica de mesa
IT Thermos in acciaio
BG Настолни термоси
EL Επιτραπέζιες θερμομονωτικές φιάλες
ZH 真空保温壶

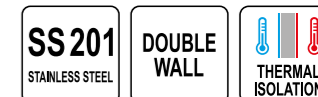

YATO	V (l)
YG-07013	1.5
YG-07014	2.0



YATO	V (l)
YG-07026	1.5
YG-07027	2.0

Vacuum flasks

- DE Tischthermoskannen
RU Настольные термосы
UK Столові термоси
LT Stalo termosai
LV Galda termosī
CS Stolní termoska
- SK Stolové termosky
HU Asztali termosok
RO Termosuri
ES Jarras y termos de mesa
FR Thermos isothermes pour la restauration
PT Garrafa térmica de mesa

- IT Thermos in acciaio
BG Настолни термоси
EL Επιτραπέζιες θερμομονωτικές φιάλες
ZH 真空保温壶



YATO	V (l)
YG-07016	2.2

- DE Getränkespender
RU Диспенсер для напитков
UK Дозатор для напоїв
LT Gėrimų dozatorius
LV Dzērienu dozatori
CS Dávkovač na nápoje
SK Dávkovač na nápoje
HU Italadagoló

- RO Dozator pentru băuturi
ES Dispensador de bebidas
FR Distributeur de boissons
PT Dispensador de bebidas
IT Dispenser di bevande
BG Дозатор за напитки
EL Διανομέας ποτών
ZH 果汁鼎



YATO	V (l)
YG-07001	8



YATO	V (l)
YG-07019	5.0
YG-07020	3.0

8L

**350x260
x600
mm**

**SS 201
STAINLESS STEEL**

PC



**REMOVABLE
BARELL**

Jug for drinks

- DE Krüge für Getränke
RU Кувшины для напитков
UK Глечики для напоїв
LT Gėrimų ąsočiai
LV Dzērienu krūzes
CS Džbánky na nápoje
SK Džbánky na nápoje
HU Italkannák
RO Carafe
ES Jarras para bebidas
FR Pichets à boissons
PT Jarros de bebidas
IT Brocche per acqua
BG Кани за напитки
EL Κανάτες ποτών
ZH 冷水壶



PC

YATO	V (l)	H (mm)	Ø (mm)
YG-07005	0.8	165	105

Tiered platter for fruit and biscuits

- DE Etagerer für Obst und Kekse
RU Этажерка для фруктов и печенья
UK Сервірувальна підставка для фрукти і печиво
LT Vaisių ir pyragų serviravimo stovas
LV Kūku un augļu paliknis
CS Mísa na ovoce a sušenky
SK Mísa na ovocie a zákusky
HU Gyümölcs és sütemény kínálól
RO Suport pentru fructe și prăjituri
ES Bandeja para frutas y pasteles
FR Plateau pour fruits et gâteaux
PT Tigela para frutas e bolos
IT Vassoio per frutta e torte
BG Поставка за сладки и плодове
EL Μπολ φρούτων και μπισκότων
ZH 不锈钢果盘

**SS
STAINLESS STEEL**

**X3
LEVELS**

**165 mm
219 mm
267 mm**



YATO	Ø (mm)	H (mm)
YG-08202	165 / 219 / 267	300

Ice cube tongs

- DE Eiszange
RU Шипцы для льда
UK Щипці для льоду
LT Žnyplės ledui
LV Ledus stangas
CS Kleště na led
SK Kliešte na ľad
HU Jégcsipesz
RO Clește pentru cuburi de gheață
ES Alicates para hielo
FR Pince à glace
PT Pinças de gelo
IT Pinze per ghiaccio
BG Щипки за лед
EL Λαβίδα πάγου
ZH 冰块夹

**SS
STAINLESS STEEL**

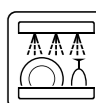

YATO	L (mm)
YG-02735	100
YG-02736	150

Sugar cube tongs

- DE Zuckerzange
RU Шипцы для сахара
UK Щипці для цукру
LT Žnyplės cukrui
LV Cukura stangas
CS Kleště na cukr
SK Kliešte na cukor
HU Cukorcsipesz
RO Clește pentru cuburi de zahăr
ES Alicates para azúcar
FR Pince à sucre
PT Pinças de açúcar
IT Pinze per zucchero
BG Щипки за захар
EL Λαβίδα ζάχαρης
ZH 方糖夹

**SS
STAINLESS STEEL**



YATO	L (mm)
YG-02733	155

Tongs

- DE Zange
- RU Щипцы
- UK Щипці
- LT Žnyplės
- LV Stangas
- CS Kleště
- SK Kliešte
- HU Csipesz
- RO Clești
- ES Alicates
- FR Pince
- PT Pinças
- IT Pinze
- BG Щипки
- EL Λαβίδα
- ZH 不锈钢夹

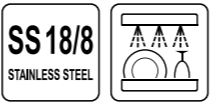

Bread serving tongs

YATO	L (mm)
YG-02731	220

Roast meat serving tongs

YATO	L (mm)
YG-02730	195

Spaghetti serving tongs

YATO	L (mm)
YG-02732	215

Buffet accessories

- DE Buffetzubehör
- RU Буфетные приборы
- UK Буфетні аксесуари
- LT Stalo serviravimo įrankiai
- LV Bufešu piederumi
- CS Bufetové pomůcky
- SK Bufetové výrobky
- HU Büfé termékek
- RO Accesorii buffet
- ES Artículos para buffet
- FR Pince buffet
- PT Artigos de buffet
- IT Articoli da buffet
- BG Артикули за бюфет
- EL Αντικείμενα για μπουφέ
- ZH 自助餐配件

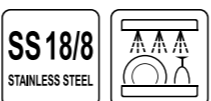

Spaghetti spoon

YATO	L (mm)
YG-02780	340

Salad fork

YATO	L (mm)
YG-02778	300

Serving spoon

YATO	L (mm)
YG-02775	300

Slotted serving spoon

YATO	L (mm)
YG-02774	300

Slotted spoon

YATO	L (mm)
YG-02773	370

Ladle

• 120 ml

YATO	L (mm)
YG-02776	315

Sauce spoon

• 30 ml

YATO	L (mm)
YG-02777	300

Spatula

• 80 x 105 mm

YATO	L (mm)
YG-02772	360

Meat knife

YATO	L (mm)
YG-02771	315

Meat fork

YATO	L (mm)
YG-02770	280

Cake spatula

YATO	L (mm)
YG-02779	275

Non-slip waiter trays

- DE Rutschfeste Kellnertablets
- RU Антискользящие подносы для официантов
- UK Нековзні підноси для офіціантів
- LT Neslidūs padėklai padavėjams
- LV Paplāte viesmilim, neslidoša
- CS Protiskluzové číšnícké tácy
- SK Čašnicke podnosy protišmykové
- HU Csúszásmentes pincértálcák
- RO Tăvi de servit anti-alunecare
- ES Bandejas antideslizantes para camareros

- FR Plateaux antidérapants pour serveurs
- PT Bandejas antiderrapantes para garçons
- IT Vassoio antiscivolo da cameriere
- BG Сервитьорски табли с неплъзгаща горна част
- EL Αντιολισθητικοί δίσκοι σερβιτόρων
- ZH 防滑托盘

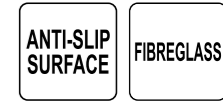

Rectangular trays

YATO	(mm)
YG-02075	460 x 355
YG-02076	515 x 380
YG-02077	560 x 405
YG-02078	650 x 450

Round trays

YATO	∅ (mm)
YG-02079	355
YG-02080	405

Oval trays

YATO	(mm)
YG-02084	590 x 490
YG-02087	600 x 735

Buffet tray made of polypropylene

- DE Buffettablett
- RU Поднос
- UK Підноси
- LT Padėklas
- LV Paplāte
- CS Tácy
- SK Podnosy
- HU Tálca
- RO Tăvi
- ES Expositoria
- FR Plateau
- PT Bandeja
- IT Vassoio
- BG Поднос
- EL Δίσκος
- ZH 托盘



YATO	(mm)
YG-02105	430 x 300

Thermally insulated ice bucket

DE Thermoisolierter Eisbehälter
RU Термомемкость для льда
UK Теплоізоляційний контейнер для льоду
LT Termoizoliacinis indas ledui
LV Ledus termoss
CS Termoizolační nádoba na led
SK Termoizolačná nádoba na ľad
HU Hőszigetelt jégartó
RO Container termoizolant pentru gheața
ES Contenedor de aislamiento térmico para hielo
FR Conteneurs isothermes pour glace
PT Recipiente de gelo com isolamento
IT Contenitore a isolamento termico per il ghiaccio
BG Съд за лед с двойни стени
EL Θερμικώς μονωμένο δοχείο για πάγο
ZH 保温冰桶



YATO	V (l)	H (mm)	Ø (mm)
YG-07143	1.1	200	140

Ice bucket

DE Eisbehälter
RU Емкость для льда
UK Контейнер для льоду
LT Indas ledui
LV Ledus trauks
CS Nádoba na led
SK Nádoba na ľad
HU Jégartó

RO Vas pentru gheață
ES Contenedor para hielo
FR Conteneur à glace
PT Recipiente de gelo
IT Contenitore per il ghiaccio
BG Съд за лед
EL Δοχείο πάγου
ZH 亚克力冰桶



SEE ALSO
ice cube tongs



p. 21

YATO	V (l)	H (mm)	Ø (mm)
YG-07146	1.1	125	125

Wine bottle cooler

DE Thermoisolierter Weinbehälter
RU Термоконтэйнер для вина
UK Теплоізоляційний контейнер для вина
LT Termoizoliacinis indas vynui
LV Vīna termoss
CS Termoizolační nádoba na víno
SK Termoizolačná nádoba na víno
HU Hőszigetelt bortartó
RO Container termoizolant pentru sticle de vin
ES Cubo enfriador de vino con aislamiento
FR Seau à vin isotherme
PT Recipiente de vinho com isolamento
IT Contenitore a isolamento termico per il vino
BG Термоизолиран съд за вино
EL Θερμικώς μονωμένο δοχείο για κρασί
ZH 酒瓶冷藏器



YATO	V (l)	H (mm)	Ø (mm)
YG-07147	1.4	235	125

Champagne bucket

DE Sektkühler
RU Ведро для шампанского
UK Відро для шампанського
LT Dubuo šampano buteliams
LV Šampanieša spainis
CS Nádoba na šampaňské
SK Vedierko na šampanské
HU Pezsgősvödör
RO Frapieră
ES Cubo de champán
FR Vasque à champagne
PT Balde para champanhe
IT Vasca per champagne
BG Кофичка за шампанско
EL Κουβάς σαμπάνιας
ZH 不锈钢香槟桶



YATO	V (l)	Ø (mm)	H (mm)
YG-07141	3.8	80	196

Cocktail shakers

DE Coctail-Shaker
RU Шейкеры для коктейлей
UK Шейкери для коктейлів
LT Kokteilių plaktuvai
LV Kokteilu šeikeri
CS Šejkr na koktejl
SK Shakery na koktaily
HU Koktél shakerek
RO Shaker
ES Cocteleras

FR Shakers
PT Coqueteleiras
IT Agitatore per cocktail
BG Шейкър за коктейли
EL Σέικερ κοκτέιλ
ZH 不锈钢调酒壶



YATO	V (l)	Ø (mm)	H (mm)
YG-07121	0.5	70	178
YG-07123	0.7	80	248

Reception bell

DE Rezeptionsklingel
RU Звонок для рецепции
UK Дзвінок рецепції
LT Registratūros skambutis
LV Recepcijas zvans
CS Recepční zvoněk
SK Recepčný zvonček
HU Recepció csengő
RO Sonerie pentru recepție
ES Timbre de recepción
FR Cloche de réception
PT Sino de recepção
IT Campanello da reception

BG Звънец за рецепция
EL Κουδούνι ρεσεψιόν
ZH 服务铃



YATO	Ø (mm)
YG-02720	85

Citrus juicer

DE Zitruspresse
RU Ручная соковыжималка для цитрусовых
UK Прес для цитрусових
LT Rankinė sulčiaspaudė citrusams
LV Citrusaugļu sulu spiede
CS Lis na citrusy
SK Lis na citrón
HU Citrusfacsaró
RO Storcător de citrice
ES Exprimidor de cítricos
FR Extracteur de jus d'agrumes
PT Espremedor de frutas cítricas
IT Spremiagrumi
BG Цитрус преса
EL Αποχυμωτής εσπεριδοειδών
ZH 不锈钢榨汁器



YATO	Ø (mm)	Ø CONE (mm)
YG-07108	120	65

Bartender container

DE Barkeeper-Behälter
RU Ящик для бармена
UK Барменський контейнер
LT Barmeno indas
LV Bāra trauks
CS Barmanská nádoba
SK Barmanská nádoba
HU Bár doboz
RO Recipient depozitare pentru bar
ES Recipiente de bar
FR Vas à compartiments
PT Recipiente de barman
IT Contenitore per bar
BG Бар органайзер за плодове
EL Δοχείο μπάρμαν
ZH 果盒调味盒



YATO	H (mm)
YG-07080	500 x 160 x 100

Bartending spoon

DE Barlöffel
RU Барная ложка
UK Барменська ложка
LT Barmeno šaukštelis
LV Bāra karote
CS Barmanská lžička
SK Barmanská lyžička
HU Koktélkanál
RO Liguriță pentru barman
ES Cuchara con mango largo

FR Cuillère à cocktail
PT Colher de barman
IT Cucchiario da barista
BG Бар лъжица
EL Κουτάλι μπάρμαν
ZH 不锈钢搅拌勺



YATO	L (mm)
YG-07136	330

Bartender's organiser

DE Behälter für Barkeeper-Zubehör
RU Барный органайзер
UK Контейнер для барменського приладдя
LT Padėklas barmeno įrankiams
LV Trauks bāra piederumiem
CS Nádoba na barmanské příslušenství
SK Nádoba na barmanské príbory
HU Bártartozék tároló
RO Organizator bar
ES Contenedor para accesorios de barman

FR Bac caddy
PT Recipiente para acessórios de barman
IT Contenitore per accessori per bar
BG Бар органайзер
EL Δοχείο για αξεσουάρ μπάρμαν
ZH 纸巾盒



YATO	H (mm)
YG-07134	100

Additional cup for the blender

DE Ersatz-Mixbecher
RU Запасная чаша для блендера
UK Запасна чаша для блендера
LT Papildomas maišytuvo-smulkintuvo ąsotis
LV Blendera rezerves krūze
CS Náhradní nádoba k mixéru
SK Náhradná nádoba pre mixér
HU Tartalék mixertál
RO Cupă pentru blender
ES Vaso de repuesto para la batidora
FR Gobelet de rechange pour le mélangeur
PT Copo de liquidificador sobressalente
IT Bicchiere di ricambio per frullatore
BG Резервна кана за блендър
EL Επιπλέον πλαστική κανάτα για μπλέντερ
ZH 搅拌机备用杯



YATO	V (l)	(mm)	FOR:
YG-07086	2.5	190 x 250 x 335	YG-07085

Bartender mats

- DE Barkeeper-Matten
RU Барные коврики
UK Коврики для барменів
LT Baro kilimėliai
LV Bāra paklāji
CS Barmanské podložky
SK Barmanské rohože
HU Bár alátét
RO Suporturi pentru bar
ES Esteras de goma para la barra
FR Tapis de bar en caoutchouc
PT Tapetes de barman
IT Tappetino da bar
BG Бар подложки

EL Μπάρ ψάθες
ZH 长吧垫



TPR

YATO	H (mm)
YG-07100	590 x 80 x 15
YG-07101	460 x 310 x 10

Drink dispensers

- DE Barkeeper-Spender
RU Диспенсеры для бара
UK Барменські диспенсери
LT Baro buteliukai skysčiams dozuoti
LV Bāra dispenserī
CS Barmanské dávkovače
SK Barmanské dispenzéry
HU Adagoló tubusok
RO Barman dispenser
ES Dispensadores de barman
FR Flacon verseur
PT Distribuidores para barman
IT Dispenser per bar
BG Бар диспенсѐри
EL Διανομείς μάρμαν
ZH 饮料壶



YATO	COLOUR	V (l)	H (mm)	∅ (mm)
YG-07115	Red	1	330	90
YG-07116	Blue	1	330	90
YG-07117	Green	1	330	90
YG-07118	Brown	1	330	90
YG-07119	Yellow	1	330	90

1L

PP/PS



Bottle opener

- DE Flaschenöffner
RU Открывалка для бутылок
UK Відкривачка для пляшок
LT Butelių atidarytuvas
LV Pudeļu attaisāmais
CS Otevírač na láhve
SK Otvárač na fľaše
HU Sörbontó
RO Desfacător de sticle
- ES Abrebotellas
FR Ouvre-bouteille
PT Abridor de garrafas
IT Aprobottiglie
BG Отварачка за бутилки
EL Ανοιχτήρι μπουκαλιών
ZH 开瓶器

SS

STAINLESS STEEL



YATO	H (mm)
YG-07139	175 x 40 x 2

Plugs with dispensers

- DE Ausgießer
RU Пробки с дозаторами
UK Пробки з дозаторами
LT Kamščiai su dozatoriais
LV Korķi ar dozatoriem
CS Korky s dávkovači
SK Zátky s dávkovačmi
HU Adagoló kupak
RO Picurător
ES Tapones con dosificador para botellas
FR Becs verseurs pour les bouteilles
- PT Rolhas com dispensadores
IT Tappi con dosatori
BG Тапи с дозатори
EL Φελλό με διανομείς
ZH 不锈钢瓶头

PP



YATO	COLOUR
YG-07126	Blue
YG-07127	Pink
YG-07128	Red
YG-07129	Black
YG-07130	Green
YG-07131	White

Bone saws

- DE Knochensäge
RU Костяная пила
UK Пилка для кісток
LT Kaulų pjūklas
LV Kaulu zāģis
FR Pila na kosti
- SK Pila na kosti
HU Csontfűrész
RO Fierastrau de oase si carne congelată
ES Sierra para huesos
FR Scie à os
- PT Serra de osso
IT Segatrice
BG Трион за кости
EL Πριόνι κρέατος οστών
ZH 锯骨机

750W

1650 mm

1400 min⁻¹

MAX 245 mm CUTTING HIGH

3-180 mm SLICES

SS STAINLESS STEEL



Al-Mg ANODIZED



YATO	(W)	(mm)	TABLE (mm)
YG-03392	750	870 x 450 x 465	440 x 465

Bone saw blade

- DE Knochensägeblatt
RU Полотно для ленточной пилы для кости
UK Полотно для стрічкової пилки для туш та кісток
LT Ašmuo kaulų pjūklui
LV Griezējnazis kaulu zāģim
SK Čepel' do pily na kosti
HU Vágókés csontfűrészhez
RO Lama fierastrau pt. aparat de taiat oase
ES Hoja de sierra para corte de huesos
- FR Lame pour scie à os
PT Lâmina para serra de osso
IT Lama per segaossa
BG Режеша лента за банциг за месо
EL Λεπίδα πριονιού οστών
ZH 锯条

HSS



YATO	(mm)	FOR:
YG-03396	1650 x 16	YG-03395

• Made of HSS • Length: 1650 mm • Width: 16 mm • 4 teeth per inch

Electric meat tenderizer

DE Elektrischer Fleischklopfert
RU Котлетный аппарат электрический
UK Котлетний апарат електричний
LT Elektrinis mėsos pūrentuvas
LV Elektriskais gaļas mikstinātājs
CS Elektrický naklepávač masa
SK Elektrický lis na mäso
HU Elektromos húsdaraboló
RO Masina electrica fragezit carne
ES Tenderizador de carne eléctrico
FR Trancheuse à viande électrique
PT Máquina elétrica de fazer costeletas
IT Cotolettatrice automatica
BG Електрически уред за окрехкотяване на месо
EL Ηλεκτρικός τρυφεροποιητής κρέατος
ZH 商用自动嫩肉机



450 W
170/200 min⁻¹
SS STAINLESS STEEL

YATO	(W)
YG-03300	450

Meat tenderizer roll

DE Welle für Fleischklopfert
RU Валик для котлетного аппарата
UK Валик для котлетного апарату
LT Mėsos pūrentuvo volas
LV Rullis gaļas mikstinātājam
CS Válek do naklepávače masa
SK Valček do lisu na mäso
HU Tengely húsdarabolóhoz
RO Cutite fragezit carne
ES Rodillo para tenderizador de carne
FR Rouleau de trancheuse à viande
PT Parafuso da máquina de fazer costeletas
IT Elica per cotolettatrice
BG Вал за уред за окрехкотяване на месо
EL Ρολό για τρυφεροποιητή κρέατος
ZH 手动嫩肉机 嫩肉轮组

2 PCS
SS STAINLESS STEEL



• for: YG-03300
• made of stainless steel
• plastic gear
• length: 192 mm

YATO
YG-03301

Meat micer head for tenderizer

DE Kopf für Fleischklopfert
RU Головка измельчителя мяса
UK Головка подрібнювача м'яса
LT Mėsos pūrentuvo galvutė
LV Galva gaļas mikstinātājam
CS Hlava do naklepávače masa
SK Hlavica do listu na mäso
HU Fejegység húsklopfoló géphez
RO Cap pt. masina de tocat carne
ES Cabezal para tenderizador de carne
FR Tête de hachoir à viande
PT Cabeça para formadora de almôndegas
IT Testa per cotolettatrice
BG Глава за уред за окрехкотяване на месо
EL Κεφαλή τρυφεροποιητή κρέατος
ZH 绞肉机机头

SS STAINLESS STEEL



YATO
YG-03302

Manual meat tenderizer

DE Manueller Fleischklopfert
RU Ручной котлетный аппарат
UK Ручний котлетний апарат
LT Rankinis mėsos pūrentuvas
LV Manuālais gaļas mikstinātājs
CS Ruční naklepávač masa
SK Ručný lis na mäso
HU Kézi húsdaraboló
RO Masina manuala fragezit carnee
ES Tenderizador de carne manual

FR Trancheuse à viande manuelles
PT Máquina manual de fazer costeletas
IT Cotolettatrice manuale
BG Ръчен уред за окрехкотяване на месо
EL Τρυφεροποιητής χείροσ
ZH 商用手动嫩肉机

SS STAINLESS STEEL



YATO
YG-03305

Meat tenderizer roll

DE Welle für Fleischklopfert
RU Валик для котлетного аппарата
UK Валик для котлетного апарату
LT Mėsos pūrentuvo volas
LV Rullis gaļas mikstinātājam
CS Válek do naklepávače masa
SK Valček do lisu na mäso
HU Tengely húsdarabolóhoz
RO Cutite fragezit carne
ES Rodillo para tenderizador de carne
FR Rouleau de trancheuse à viande

PT Parafuso da máquina de fazer costeletas
IT Elica per cotolettatrice
BG Вал за уред за окрехкотяване на месо
EL Ρολό για τρυφεροποιητή κρέατος
ZH 手动嫩肉机 嫩肉轮组

2 PCS
SS STAINLESS STEEL

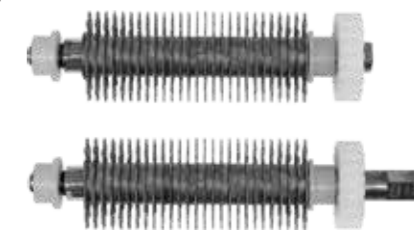

YATO
YG-03306

• for: YG-03305
• made of stainless steel

• integrated nylon gear
• length: 192 mm

Meat mincer with Unger system

DE Fleischwolf
RU Машина для измельчения мяса
UK Машинка для подрібнення м'яса
LT Mėsmale
LV Gaļas maļamā mašina
CS Sroj pro mletí masa
SK Mlynček na mäso
HU Húsdaráló
RO Maşina de tocat carne
ES Picadora de carne
FR Hachoir à viande
PT Moedor de carne
IT Macchina per la macinazione della carne
BG Месомелачка
EL Μηχανή για άλεση κρέατος
ZH 碎肉机

Al-Mg ANODIZED
SS STAINLESS STEEL
PE
EMERGENCY STOP SWITCH
x2 10 mm
6 mm



Unger System



YATO	(kg/h)	(W)	(mm)
YG-03232	220	1100	520 x 390 x 225

Meat mincer

DE Fleischwolf
RU Машина для измельчения мяса
UK Машинка для подрібнення м'яса
LT Mėsmaľė
LV Gaļas maļamā mašina
CS Sroj pro mletí masa
SK Mlynček na mäso
HU Húsdaráló
RO Maşina de tocat carne
ES Picadora de carne
FR Hachoir à viande
PT Moedor de carne
IT Macchina per la macinazione della carne
BG Месомелачка
EL Μηχανή για άλεση κρέατος
ZH 碎肉机



75
kg/h

SS
STAINLESS STEEL

AI

PE



YATO	(kg/h)	(W)	(mm)
YG-03200	75	250	335 x 175 x 325

Crossing knife

DE Fleischwolf-Messer
RU Нож для мясорубки
UK Ніж для м'ясорубки
LT Mėsmaľės peiliukas
LV Nazis gaļas maļamajai mašīnai
CS Nůž do mlynku na maso
SK Nôž do mlynčeka na mäso
HU Húsdaráló kés
RO Cutit masina de tocat
ES Cuchillo para la picadora de carne
FR Outil de coupe pour un hacheur à viande
PT Lâmina para picador de carne
IT Lama per tritacarne

BG Нож за месомелачка
EL Μαχαίρι κρεατομηχανής
ZH 绞肉机十字刀



YATO	
YG-03201	• for: YG-03200

Grinding plates

DE Sieb für Fleischwolf
RU Ситечко для мясорубки
UA Ситечко для м'ясорубки
LT Mėsmaľės sietelis
LV Sietiņš gaļas maļamajai mašīnai
CS Sítko do mlynku na maso
SK Sitko do mlynčeka na mäso
HU Húsdaráló tárcsa
RO Sita masina de tocat
ES Disco perforado para la picadora de carne

FR Passage pour hacheur à viande
PT Grelha para picador de carne
IT Disco forato per tritacarne
BG Решетка за месомелачка
EL Κόσκινο κρεατομηχανής
ZH 绞肉机孔板

YATO	Ø (mm)
YG-03250	3.0

YATO	Ø (mm)
YG-03251	4.5

YATO	Ø (mm)
YG-03202	6.0

YATO	Ø (mm)
YG-03203	8.0

YATO	Ø (mm)
YG-03252	10



• for: YG-03200

SS
STAINLESS STEEL

Worm with square shank

DE Welle für Fleischwolf
RU Валик для мясорубки
UA Валик для м'ясорубки
LT Mėsmaľės sraigtas
LV Gliemezis gaļas maļamajai mašīnai
CS Šnek do mlynku na maso
SK Valček do mlynčeka na mäso
HU Húsdaráló tengely
RO Melc pt. masina de tocat
ES Sinfin para la picadora de carne
FR Vis d'alimentation hachoir à viande

PT Parafuso para picador de carne
IT Elica per tritacarne
BG Вал за месомелачка
EL Σαλίγκαρος κρεατομηχανής
ZH 绞肉机绞龙



YATO	
YG-03204	• for: YG-03200

SS
STAINLESS STEEL

Meat mincer

DE Fleischwolf
RU Машина для измельчения мяса
UK Машинка для подрібнення м'яса
LT Mėsmaľė
LV Gaļas maļamā mašina
CS Sroj pro mletí masa
SK Mlynček na mäso
HU Húsdaráló
RO Maşina de tocat carne
ES Picadora de carne
FR Hachoir à viande
PT Moedor de carne
IT Macchina per la macinazione della carne
BG Месомелачка
EL Μηχανή για άλεση κρέατος
ZH 碎肉机



150
kg/h

SS
STAINLESS STEEL

AI

PE



YATO	(kg/h)	(W)	(mm)
YG-03215	150	650	385 x 240 x 415

Crossing knife

DE Fleischwolf-Messer
RU Нож для мясорубки
UK Ніж для м'ясорубки
LT Mėsmaľės peiliukas
LV Nazis gaļas maļamajai mašīnai
CS Nůž do mlynku na maso
SK Nôž do mlynčeka na mäso
HU Húsdaráló kés
RO Cutit masina de tocat
ES Cuchillo para la picadora de carne
FR Outil de coupe pour un hacheur à viande
PT Lâmina para picador de carne
IT Lama per tritacarne

BG Нож за месомелачка
EL Μαχαίρι κρεατομηχανής
ZH 绞肉机十字刀



YATO	
YG-03216	• for: YG-03215

Grinding plates

DE Sieb für Fleischwolf
RU Ситечко для мясорубки
UA Ситечко для м'ясорубки
LT Mėsmaľės sietelis
LV Sietiņš gaļas maļamajai mašīnai
CS Sítko do mlynku na maso
SK Sitko do mlynčeka na mäso
HU Húsdaráló tárcsa
RO Sita masina de tocat
ES Disco perforado para la picadora de carne

FR Passage pour hacheur à viande
PT Grelha para picador de carne
IT Disco forato per tritacarne
BG Решетка за месомелачка
EL Κόσκινο κρεατομηχανής
ZH 绞肉机孔板

YATO	Ø (mm)
YG-03255	3.0

YATO	Ø (mm)
YG-03256	4.5

YATO	Ø (mm)
YG-03217	6.0

YATO	Ø (mm)
YG-03218	8.0

YATO	Ø (mm)
YG-03257	10



• for: YG-03215

SS
STAINLESS STEEL

Grinding plates

DE Sieb für Fleischwolf
RU Ситечко для мясорубки
UA Ситечко для м'ясорубки
LT Mėsmales sietelis
LV Sietiņš gaļas maļamajai mašīnai
CS Sítko do mlynku na maso
SK Sítko do mlynčka na mäso
HU Húsdaráló tárcsa
RO Sita masina de tocat
ES Disco perforado para la picadora de carne

FR Passage pour hacheur à viande
PT Grelha para picador de carne
IT Disco forato per tritacarne
BG Решетка за месомелачка
EL Κόσκινο κρεατομηχανής
ZH 绞肉机孔板



YATO	Ø (mm)
YG-03262	6.0



YATO	Ø (mm)
YG-03260	3.0



YATO	Ø (mm)
YG-03263	8.0



YATO	Ø (mm)
YG-03261	4.5



YATO	Ø (mm)
YG-03264	10

SS
STAINLESS STEEL

- for : YG-03215

Meat mincer

DE Fleischwolf
RU Машина для измельчения мяса
UK Машинка для подрібнення м'яса
LT Mėsmales
LV Gaļas maļamā mašīna
CS Sroj pro mletí masa
SK Mlynček na mäso
HU Húsdaráló
RO Maşina de tocat carne
ES Picadora de carne
FR Hachoir à viande
PT Moedor de carne
IT Macchina per la macinazione della carne
BG Месомелачка
EL Μηχανή για άλεση κρέατος
ZH 碎肉机



250 kg/h **SS** **AI** **PE**
STAINLESS STEEL



YATO	(kg/h)	(W)	(mm)
YG-03235	250	750	440 x 270 x 385



Crossing knife

DE Fleischwolf-Messer
RU Нож для мясорубки
UK Ніж для м'ясорубки
LT Mėsmales peiliukas
LV Nazis gaļas maļamajai mašīnai
CS Nůž do mlynku na maso
SK Nôž do mlynčka na mäso
HU Húsdaráló kés
RO Cutit masina de tocat
ES Cuchillo para la picadora de carne
FR Outil de coupe pour un hacheur à viande
PT Lâmina para picador de carne
IT Lama per tritacarne
BG Нож за месомелачка
EL Μαχαίρι κρεατομηχανής
ZH 绞肉机十字刀



YATO	- for : YG-03235
YG-03236	

Grinding plates

DE Sieb für Fleischwolf
RU Ситечко для мясорубки
UA Ситечко для м'ясорубки
LT Mėsmales sietelis
LV Sietiņš gaļas maļamajai mašīnai
CS Sítko do mlynku na maso
SK Sítko do mlynčka na mäso
HU Húsdaráló tárcsa
RO Sita masina de tocat
ES Disco perforado para la picadora de carne
FR Passage pour hacheur à viande
PT Grelha para picador de carne
IT Disco forato per tritacarne
BG Решетка за месомелачка
EL Κόσκινο κρεατομηχανής
ZH 绞肉机孔板



YATO	Ø (mm)
YG-03237	6.0

- for : YG-03235

Grinding plates

DE Sieb für Fleischwolf
RU Ситечко для мясорубки
UA Ситечко для м'ясорубки
LT Mėsmales sietelis
LV Sietiņš gaļas maļamajai mašīnai
CS Sítko do mlynku na maso
SK Sítko do mlynčka na mäso
HU Húsdaráló tárcsa
RO Sita masina de tocat
ES Disco perforado para la picadora de carne
FR Passage pour hacheur à viande
PT Grelha para picador de carne
IT Disco forato per tritacarne
BG Решетка за месомелачка
EL Κόσκινο κρεατομηχανής
ZH 绞肉机孔板



YATO	Ø (mm)
YG-03272	6.0

- for : YG-03235

SS
STAINLESS STEEL

Worm with square shank

DE Welle für Fleischwolf
RU Валик для мясорубки
UA Валик для м'ясорубки
LT Mėsmales sraigtas
LV Gliemezis gaļas maļamajai mašīnai
CS Šnek do mlynku na maso
SK Valček do mlynčka na mäso
HU Húsdaráló tengely
RO Melc pt. masina de tocat
ES Sinfin para la picadora de carne

FR Vis d'alimentation hachoir à viande
PT Parafuso para picador de carne
IT Elica per tritacarne
BG Вал за месомелачка
EL Σαλίγκαρος κρεατομηχανής
ZH 绞肉机绞龙



YATO	- for : YG-03235
YG-03239	

SS
STAINLESS STEEL



YATO	Ø (mm)
YG-03265	3.0



YATO	Ø (mm)
YG-03266	4.5



YATO	Ø (mm)
YG-03238	8.0



YATO	Ø (mm)
YG-03267	10



YATO	Ø (mm)
YG-03270	3.0



YATO	Ø (mm)
YG-03271	4.5



YATO	Ø (mm)
YG-03273	8.0



YATO	Ø (mm)
YG-03274	10

SS
STAINLESS STEEL

Sausage stuffers

- DE Wurstfüller
- RU Колбасные шприцы
- UK Шприци для ковбас
- LT Dešrų kimštuvai
- LV Desu pildīšanas ierīces
- CS Nadívače klobás
- SK Plniace stroje na výrobu klobásy
- HU Kolbásztöltő
- RO Aparat de umplut cărnați
- ES Embutidora de salchichas
- FR Remplisseuse de saucisses
- PT Enchedores de linguiças
- IT Riempitrici per salsicce
- BG Пълначка за колбаси
- EL Γεμιστικά για λουκάνικα
- ZH 灌肠机



SS STAINLESS STEEL

x4

16 mm
22 mm
32 mm
38 mm

x2 SPEED

EASY TO CLEAN



YATO	V (l)	(kg/h)	(mm)	CYLINDER (mm)
YG-03350	3	11	300 x 340 x 570	140 x 200
YG-03360	5	12	300 x 340 x 690	140 x 320
YG-03370	7	13	300 x 340 x 830	140 x 460
YG-03380	15	17	370 x 330 x 710	219 x 400

Sausage stuffers

- DE Wurstfüller
- RU Колбасные шприцы
- UK Шприци для ковбас
- LT Dešrų kimštuvai
- LV Desu pildīšanas ierīces
- CS Nadívače klobás
- SK Plniace stroje na výrobu klobásy
- HU Kolbásztöltő
- RO Aparat de umplut cărnați
- ES Embutidora de salchichas
- FR Remplisseuse de saucisses
- PT Enchedores de linguiças
- IT Riempitrici per salsicce
- BG Пълначка за колбаси
- EL Γεμιστικά για λουκάνικα
- ZH 灌肠机



SS STAINLESS STEEL

x4

16 mm
22 mm
32 mm
38 mm

x2 SPEED

EASY TO CLEAN

YATO	V (l)	(kg/h)	(mm)	CYLINDER (mm)
YG-03349	2	24.70	500 x 280 x 238	120 x 200

Meat and cheese slicers

- DE Schneidemaschinen für Wurst und Käse
- RU Ломтерезки для колбас и сыра
- UK Скиборізки для м'яса і сирів
- LT Dešrų, kumprių ir sūrių pjaustyklės
- LV Griezējierīces žāvējumiem un sieriem
- CS Kráječ na uzeniny a sýry
- SK Rezačie stroje na údeniny a syry
- HU Kolbász- és sajtszeletelő
- RO Feliatoare pentru carne și mezeluri
- ES Cortafiambres y loncheadoras para queso
- FR Trancheuses à viande et à fromage
- PT Cortadores de frios e queijos
- IT Affettatrici per salumi e formaggi
- BG Машини за рязане на колбаси и сирена
- EL Κόφτες για λουκάνικα και τυρί
- ZH 肉和奶酪切片机



AI

SEMI-AUTOMATIC SHARPENING

YG-03110
YG-03118
YG-03120

YG-03130

YG-03110

- maximum diameter of sliced products: 150 mm
- slice thickness: 0.2-12 mm



YG-03118

- maximum diameter of sliced products: 180 mm
- slice thickness: 0.2-12 mm



YG-03120

- maximum diameter of sliced products: 180 mm
- slice thickness: 0.2-12 mm



YG-03130

- maximum diameter of sliced products: 200 mm
- slice thickness: 0.2-15 mm



YATO	(W)	Ø (mm)	TABLE (mm)	(mm)
YG-03110	120	220	200 x 230	470 x 340 x 370
YG-03118	150	250	200 x 230	470 x 360 x 410
YG-03120	150	250	200 x 230	470 x 380 x 410
YG-03130	250	300	255 x 275	530 x 450 x 450

Tomato slicers

- DE Schneidemaschinen für Tomaten
RU Слайсеры для томатов
UK Слайсери для томатів
LT Pomidorų pjaustyklės
LV Griezējierīces tomātiem
CS Kráječ na rajčata
SK Krájač paradajok
HU Paradicsom szeletelő
RO Feliatoare pentru roșii
ES Cortadoras de tomate
FR Coupe-tomates
- PT Cortadores de tomate
IT Affettatrici per pomodori
BG Резачки за домати
EL Κόφτες για ντομάτες
ZH 番茄切片机

YATO	PARTS (pcs.)	H (mm)	Ø (mm)
YG-03420	6	480	350
YG-03421	12	480	350



SS
STAINLESS STEEL

French fry cutter

- DE Kartoffelschneider
RU Слайсер для нарезки картофеля
UK Ручний апарат для різання картоплі
CS Ruční kráječ na hranolky
SK Ručný krájač na hranolčeky
HU Kézi burgonya szeletelő
RO Aparat pt. taiat cartofi pai
ES Cortadora manual de patatas fritas
FR Coupe-frites
PT Cortadora de batatas manual
IT Tagliapatate manuale
BG Ръчна резачка за картофи
EL Πατατοκόπτης χειρός
ZH 薯条切条机



6x6 mm
JULIENNE

9x9 mm
JULIENNE

13x13 mm
JULIENNE



SS
STAINLESS STEEL

X4
SUCTION PADS

YATO
YG-03422

Blade with pressing plate for french fry cutter

- DE Klinge mit Presse für Kartoffelschneider
RU Лезвие с прессом для слайсера для картофеля
UA Ніж для слайсера для картоплі
CZ Šepel s přitlačnou deskou pro ruční kráječ na hranolky
SK Nôž pre ručný krájač na hranolčeky
HU Hasáburgonya vágó kés burgonya szeletelő géphez
RO Cutit pt. aparat taiat cartofi
HR Oštrica s presom za rezač krumpira
ES Cuchilla de corte para cortadora manual de patatas fritas
FR Couteau poussoir pour coupe-frites
PT Lâmina de prensagem para cortadora de batatas
IT Ricambio lama per tagliapatate manuale
BG Нож за резачка за картофи
GR Ανταλλακτική λεπίδα κύβος για πατατοκόπτη
CN 刀片

- for : YG-03422

SS
STAINLESS STEEL



YATO
YG-03423

6x6 mm
JULIENNE



YATO
YG-03424

YATO
YG-03425

YATO
YG-03426

Wall mounted plate for french fry cutter

- RU Основание для крепления на стене слайсера для нарезки картофеля
UK Підстава для кріплення на стіні слайсера для картоплі фірі
CS Základna pro montáž kráječe na hranolky na zed'
SK Podstavec na upevnenie krájača na hranolčeky na stene
HU Fali rögzítőkonzol hasáburgonya szeletelőhöz
RO Placa perete pt. montat aparat taiat cartofi
ES Base para fijar la cortadora de patatas fritas en la pared
FR Support mural pour fixer coupe-frites
PT Base para fixar a cortadora de batatas na parede
- IT Supporto per fissaggio a muro del tagliapatate manuale
BG База за стенов монтаж на резачка за картофи
GR Βασή επιτοίχιας τοποθέτησης για κόφτη τηγανιτών πατάτων
CN 墙架板



SS
STAINLESS STEEL

- for : YG-03422

YATO
YG-03428

Suction pads for french fry cutter

- DE Saugnapf-Satz für Kartoffelschneider
RU Набор присосок для слайсера
UK Набор присосок для слайсера
CS Sada přísavok do kráječe na hranolky
SK Súprava prisavok do krájača
HU Tapadókorongok hasáburgonya szeletelőhöz
RO Ventuze pt. aparat taiat
HR Set sisaljki za uređaj za rezanje
ES Set de ventosas para cortadora de patatas fritas
FR Jeu de ventouses pour coupe-frites
PT Kit de ventosas para cortadora de batatas
IT Set di ventose per tagliapatate manuale
BG Комплект вендузи за резачка за картофи
GR Σετ βεντούζες για κοπτική μηχανή
CN 刀片

4
PCS



YATO
YG-03427

- for : YG-03422

Vegetable shredder

- DE Gemüse hobel
RU Овощерезка
UK Нарізний пристрій для овочів
LT Daržovių pjaustyklė
LV Dārzenų smalcinātājs
CS Sekáček na zeleninu
SK Krájač zeleniny
HU Zöldségvágó
RO Tocător pentru legume
ES Trituradora de verduras
FR Broyeur legume
PT Cortador de legumes
IT Trituratore di verdure
BG Резачка за зеленчуци
EL Κόπτης λαχανικών
ZH 蔬菜切碎机

Al-Mg
ANODIZED

550W

300kg/h
EFFICIENCY

x5
CUTTING KNIVES

EMERGENCY STOP SWITCH



YATO	(kg/h)	(W)	(mm)
YG-03100	300	550	560 x 580 x 240

Vegetable shredder

DE Gemüsehobel
RU Овощерезка
UK Нарізний пристрій для овочів
LT Daržovių pjaustyklė
LV Dārzeņu smalcinātājs
CS Sekáček na zeleninu
SK Krájač zeleniny
HU Zöldségvágó
RO Tocător pentru legume
ES Trituradora de verduras
FR Broyeur legume
PT Cortador de legumes
IT Trituratore di verdure
BG Резачка за зеленчуци
EL Κόπτης λαχανικών
ZH 蔬菜切碎机

Al-Mg ANODIZED	550W	300kg/h EFFICIENCY	x5 CUTTING KNIVES	EMERGENCY STOP SWITCH
--------------------------	-------------	------------------------------	-----------------------------	-----------------------------

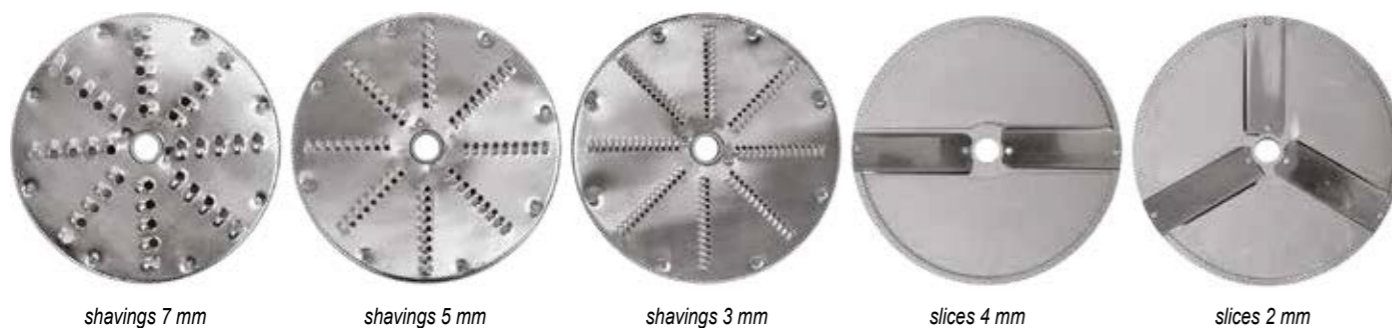

YATO	(kg/h)	(W)	(mm)
YG-03101	300	550	610 x 620 x 270

Accessories for vegetable shredder

DE Zubehör für Gemüseschredder
RU Аксессуары для тоčator de legume
UK Аксесуари для подрібнювача овочів
LT Priedai daržovių smulkintuvui
LV Aksesuāri dārzeņu smalcinātājam
CS Příslušenství pro skartovač zeleniny

SK Príslušenstvo k drviču zeleniny
HU Tartozékok növényi aprítóhoz
RO Accesorii pentru tocător de legume
ES Accesorios para trituradora de verduras
FR Accessoires pour broyeur de légumes
PT Acessórios para trituradora de vegetais

IT Accessori per tritacarne
BG Аксесоари за раздробяване на зеленчуци
EL Αξεσουάρ για τεμαχιστή λαχανικών
ZH 蔬菜切碎机配件

Ø
205
mm

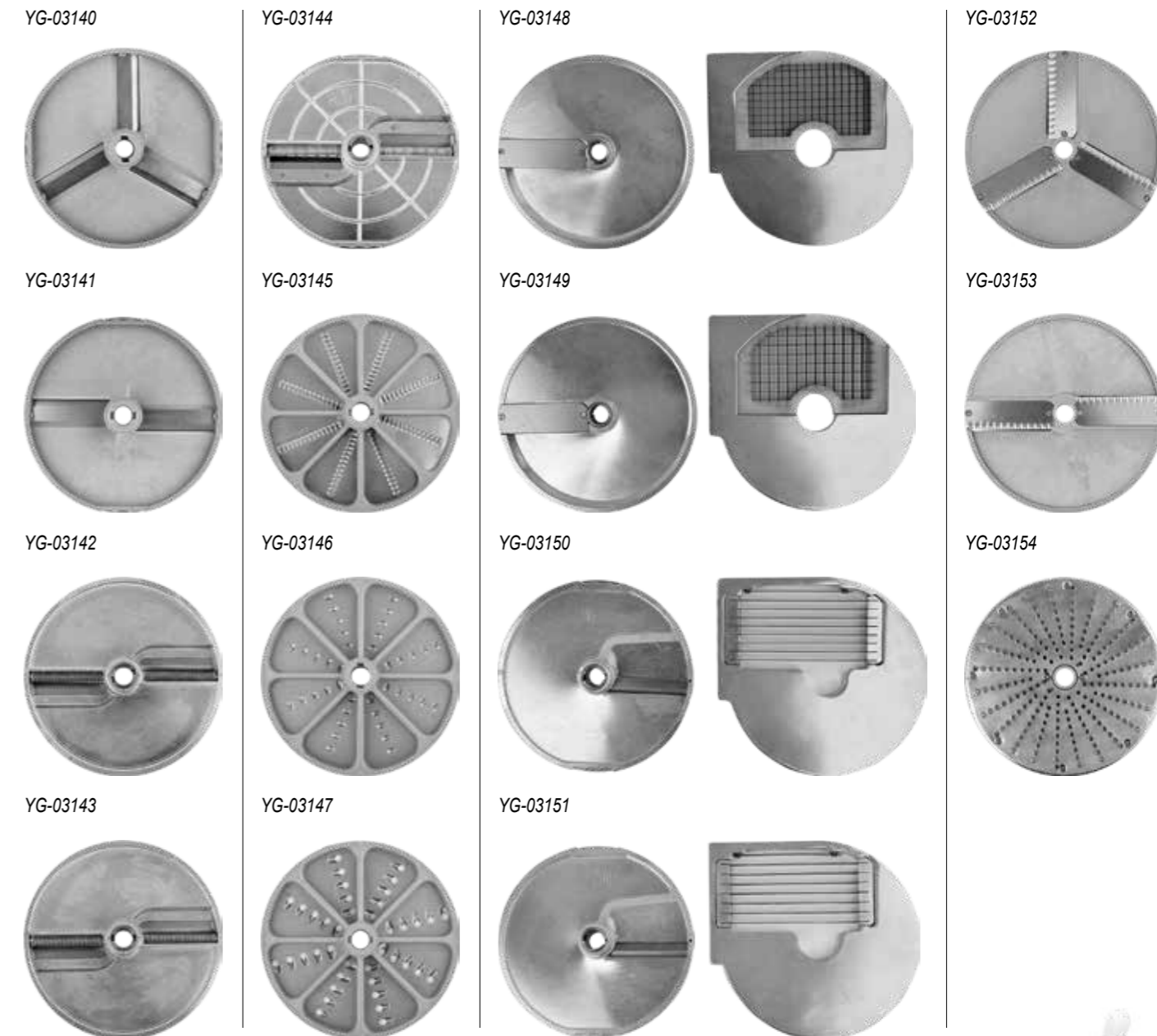

YATO	TYPE	THICKNESS (mm)
YG-03140	SLICES	2
YG-03141	SLICES	4
YG-03142	JULIENNE	2.5 x 2.5
YG-03143	JULIENNE	4 x 4
YG-03144	JULIENNE	10 x 10
YG-03145	SHREDS	3
YG-03146	SHREDS	4
YG-03147	SHREDS	7
YG-03148	CUBES	8 x 8 x 8
YG-03149	CUBES	10 x 10 x 10
YG-03150	CHIPS	8 x 8
YG-03151	CHIPS	10 x 10
YG-03152	WAVY SLICES	2
YG-03153	WAVY SLICES	4
YG-03154	GRATER	-



Planetary mixers

DE Planetenmischer
RU Планетарные миксеры
UK Планетарні міксери
LT Planetariniai maišytuvai
LV Planetārie mikseri
CS Planetární mixéry
SK Planétové miešacky
HU Bolygókeverők
RO Mixere planetare
ES Mezcladores planetarios
FR Mélangeurs planétaires
PT Batedeiras
IT Miscelatori planetari
BG Планетарни миксери
EL Πλανητικός αναδευτήρας
ZH 搅拌机



7L max 0.4kg 220/230 mm
350 W 0-780 min⁻¹

YATO	(W)	V (l)	(min ⁻¹)	(mm)	Ø KNEADING-TROUGH (mm)	(kg)
YG-03012	350	7	0-780	420 x 400 x 230	220/230	17

YG-03020

15L max 3kg 270/300 mm
500 W 110/178/355 min⁻¹



YG-03021

20L max 5kg 320/350 mm
1100 W 104/187/365 min⁻¹

YG-03022

30L max 6kg 340/370 mm
1100 W 104/187/365 min⁻¹

YATO	(W)	V (l)	(min ⁻¹)	(mm)	Ø KNEADING-TROUGH (mm)	(kg)
YG-03020	500	15	110/178/355	680 x 475 x 365	270/300	59
YG-03021	1100	20	104/187/365	780 x 500 x 430	320/350	85
YG-03022	1100	30	104/187/365	850 x 540 x 430	340/370	91



Planetary mixer

DE Planetenmischer
RU Планетарный миксер
UK Планетарний міксер
LT Planetarinis maišytuvas
LV Planetārais mikseris
CS Planetární mixér
SK Planétová miešacka
HU Bolygókeverő

RO Mixer planetar
ES Mezclador planetario
FR Mélangeur planétaire
PT Batedeira
IT Miscelatore planetario
BG Планетарен миксер
EL Πλανητικός αναδευτήρας
ZH 搅拌机

40L max 8kg 400/420 mm **2200 W** 104/206/399 min⁻¹
SS STAINLESS STEEL **CAST IRON** **Al**



YATO	(W)	V (l)	(min ⁻¹)	(mm)	Ø KNEADING-TROUGH (mm)	(kg)
YG-03023	2200	40	104/206/399	990 x 640 x 520	400/420	152

Planetary mixers

DE Planetenmischer
RU Планетарные миксеры
UK Планетарні міксери
LT Planetariniai maišytuvai
LV Planetārie mikseri
CS Planetární mixéry
SK Planétové miešacky
HU Bolygókeverők
RO Mixere planetare
ES Mezcladores planetarios
FR Mélangeurs planétaires
PT Batedeiras
IT Miscelatori planetari
BG Планетарни миксери
EL Πλανητικοί αναδευτήρες
ZH 搅拌机



YG-03025

10 L
max 1.5 kg
245/275 mm
500 W
110/178/355 min⁻¹



YATO	(W)	V (l)	(min ⁻¹)	(mm)	Ø KNEADING-TROUGH (mm)	(kg)
YG-03025	500	10	110/178/355	680 x 460 x 370	245/275	63
YG-03026	750	25	110/200/420	840 x 550 x 435	335/370	82

Kneading-troughs for planetary mixers

DE Bottiche für Planetenmischer
RU Дежи для планетарных миксеров
UK Дежа для планетарних міксерів
LT Planetarinių maišytuvų dubenys
LV Bļodas planetārajiem mikseriem
CS Dž pro planetární mixéry
SK Misy pre planétové miešacky
HU Tál bolygókeverőkhoz
RO Boluri pentru mixer planetar
ES Recipientes para mezcladoras planetarias
FR Récipients pour mélangeurs planétaires
PT Tigelas para batedeiras

IT Sbattitori per i miscelatori planetari
BG Купи за планетарни миксери
EL Κάδοι για πλανητικούς αναδευτήρες
ZH 搅拌机料筒

YATO	FOR:	V (l)
YG-03125	YG-03025	10
YG-03126	YG-03026	25



YG-03125

YG-03126

YG-03026

25 L
max 3 kg
335/370 mm
750 W
110/200/420 min⁻¹

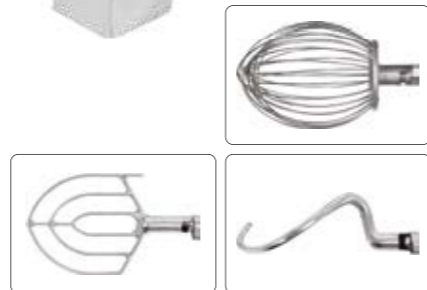

Planetary mixers

DE Planetenmischer
RU Планетарные миксеры
UK Планетарні міксери
LT Planetariniai maišytuvai
LV Planetārie mikseri
CS Planetární mixéry
SK Planétové miešacky
HU Bolygókeverők
RO Mixere planetare
ES Mezcladores planetarios
FR Mélangeurs planétaires
PT Batedeiras
IT Miscelatori planetari
BG Планетарни миксери
EL Πλανητικοί αναδευτήρες
ZH 搅拌机



YG-03027

35 L
max 4.5 kg
375/395 mm
1100 W
80/160/388 min⁻¹

YG-03028

40 L
max 6 kg
400/420 mm
1500 W
80/160/388 min⁻¹

YG-03029

60 L
max 8 kg
460/490 mm
2000 W
74/155/388 min⁻¹

YATO	(W)	V (l)	(min ⁻¹)	(mm)	Ø KNEADING-TROUGH (mm)	(kg)
YG-03027	1100	35	80/160/388	1020 x 640 x 550	375/395	130
YG-03028	1500	40	80/160/388	1020 x 640 x 550	400/420	132
YG-03029	2000	60	74/155/388	1250 x 750 x 570	460/490	218

Kneading-troughs for planetary mixers

DE Bottiche für Planetenmischer
RU Дежи для планетарных миксеров
UK Дежа для планетарних міксерів
LT Planetarinių maišytuvų dubenys
LV Bļodas planetārajiem mikseriem
CS Dž pro planetární mixéry
SK Misy pre planétové miešacky
HU Tál bolygókeverőkhoz

RO Boluri pentru mixer planetar
ES Recipientes para mezcladoras planetarias
FR Récipients pour mélangeurs planétaires
PT Tigelas para batedeiras
IT Sbattitori per i miscelatori planetari
BG Купи за планетарни миксери
EL Κάδοι για πλανητικούς αναδευτήρες
ZH 搅拌机料筒

YATO	FOR:	V (l)
YG-03127	YG-03027	35
YG-03128	YG-03028	40
YG-03129	YG-03029	60



Spiral mixers

- DE Spiralmixer
- RU Спиральные миксеры
- UK Спиральні міксери
- LT Spiraliniai maišytuvai
- LV Spirālie mikseri
- CS Spirálové míxéry
- SK Spirálové miešačky
- HU Spirál keverők
- RO Malaxore pentru aluat
- ES Amasadoras de espiral
- FR Mélangeur à spirale
- PT Batedeiras espirais
- IT Miscelatori a spirale
- BG Спирални миксери
- EL Σπριρκοί αναμκτήρες
- ZH 和面机

YG-03059

20 L max 8 kg 360/390 mm
1100 W 158 min⁻¹

YG-03062

30 L max 12 kg 400/430 mm
1500 W 158 min⁻¹

YATO	(W)	V (l)	(min ⁻¹)	(mm)	Ø DZIEŻY (mm)	(kg)
YG-03059	1100	20	158	690 x 760 x 390	360/390	127
YG-03062	1500	30	158	760 x 800 x 440	400/430	138

Spiral mixers

- DE Spiralmixer
- RU Спиральные миксеры
- UK Спиральні міксери
- LT Spiraliniai maišytuvai
- LV Spirālie mikseri
- CS Spirálové míxéry
- SK Spirálové miešačky
- HU Spirál keverők
- RO Malaxore pentru aluat
- ES Amasadoras de espiral
- FR Mélangeur à spirale
- PT Batedeiras espirais
- IT Miscelatori a spirale
- BG Спирални миксери
- EL Σπριρκοί αναμκτήρες
- ZH 和面机

YG-03060

20 L max 6 kg 360/390 mm
1500 W 247 min⁻¹

YG-03063

30 L max 12.5 kg 400/430 mm
1500 W 247 min⁻¹

YATO	(W)	V (l)	(min ⁻¹)	(mm)	Ø DZIEŻY (mm)	(kg)
YG-03060	1500	20	247	860 x 700 x 390	360/390	85
YG-03063	1500	30	247	890 x 730 x 430	400/430	97



EMERGENCY STOP SWITCH SS STAINLESS STEEL CAST IRON AI

EMERGENCY STOP SWITCH SS STAINLESS STEEL CAST IRON AI

Spiral mixers

- DE Spiralmixer
- RU Спиральные миксеры
- UK Спиральні міксери
- LT Spiraliniai maišytuvai
- LV Spirālie mikseri
- CS Spirálové míxéry
- SK Spirálové miešačky
- HU Spirál keverők
- RO Malaxore pentru aluat
- ES Amasadoras de espiral
- FR Mélangeur à spirale
- PT Batedeiras espirais
- IT Miscelatori a spirale
- BG Спирални миксери
- EL Σπριρκοί αναμκτήρες
- ZH 和面机

YG-03065

40 L max 16 kg 450/480 mm
3100 W 125/250 min⁻¹

YATO	(W)	V (l)	(min ⁻¹)	(mm)	Ø KNEADING-TROUGH (mm)	(kg)
YG-03065	3100	40	125/250	1030 x 730 x 480	450/480	133
YG-03068	3100	50	120/240	1120 x 880 x 530	500/530	189



YG-03068

50 L max 20 kg 500/530 mm
3100 W 120/240 min⁻¹



EMERGENCY STOP SWITCH SS STAINLESS STEEL CAST IRON AI

YG-03065

YG-03068



Induction cookers

- DE Induktionskochplatten
- RU Индукционные плиты
- UK Індукційні плити
- LT Indukcinės viryklės
- LV Indukcijas plītis
- CS Idukční plotny
- SK Indukčné variče
- HU Indukciós főzőlapok
- RO Plite cu inducție
- ES Cocinas de inducción
- FR Cuisinières induction
- PT Fogões por indução
- IT Cucine a induzione
- BG Индукционни котлони
- EL Επαγωγικές κουζίνες
- ZH 电磁炉



500-3500 W
1-10 POWER LEVELS
Ø 140-260 mm

CERAMIC GLASS
OVERHEATING PROTECTION
SS STAINLESS STEEL



- stepless power adjustment within the scope of 500-3500 W (in 100 W steps)
- manual control



MANUAL CONTROL



YATO	(mm)	(W)
YG-04700	325 x 420 x 105	500-3500

- power setting from 1 to 10 (within the scope of 500-3500 W, in 100 W steps)
- temperature setting from 1-10 (60-240°C, in 20°C steps)
- timer setting from 0 to 180 minutes (0-30 min. in 1 min. steps, 30-180 min. in 10 min. steps)
- LED display
- electronic control



DIGITAL CONTROL

0-180min
TIMER LED
DISPLAY



YATO	(mm)	(W)
YG-04701	325 x 420 x 105	500-3500

Grill plates

- DE Grillplatten
- RU Гриль-плиты
- UK Плити з грилем
- LT Grilio plokštės
- LV Grila plāksnes
- CS Grilovací desky
- SK Grilovacie dosky
- HU Grill sütőlapok
- RO Grill electric
- ES Placas de parrilla
- FR Plaque à grillade
- PT Chapas grill
- IT Piastre grill
- BG Грилове
- EL Πλάκες σχάρας
- ZH 电扒炉

SS STAINLESS STEEL
°C 50-300 WORKING TEMPERATURE



• flat surface

YATO	(W)	(mm)	PLATE (mm)	(kg)
YG-04584	2000	365 x 460 x 220	360 x 380 x 6	13.5



• flat surface

YATO	(W)	(mm)	PLATE (mm)	(kg)
YG-04585	3000	555 x 430 x 230	550 x 350 x 9	18.5



• 2/3 flat surface, 1/3 grooved surface

YATO	(W)	(mm)	PLATE (mm)	(kg)
YG-04586	3000	555 x 430 x 230	550 x 350 x 9	18.5



• grooved surface

YATO	(W)	(mm)	PLATE (mm)	(kg)
YG-04587	3000	555 x 430 x 230	550 x 350 x 9	18.5

- flat surface
- two independently controlled heating zones

YATO	(W)	(mm)	PLATE (mm)	(kg)
YG-04588	2200 + 2200	735 x 510 x 230	730 x 420 x 9	26



Contact grills

- DE Kontaktgrills
- RU Контактные грили
- UK Контактні грилі
- LT Kontaktiniai griliai
- LV Kontakta grili
- CS Kontaktní grily
- SK Kontaktné grily
- HU Kontakt grill
- RO Contact grill
- ES Parrillas de contacto
- FR Grilles de contact
- PT Grelhas de contato
- IT Griglie di contatto
- BG Контактни грилове
- EL Τοστιέρες-γκριλιέρες
- ZH 电气烧烤炉



SS
STAINLESS STEEL

50-300
°C
WORKING
TEMPERATURE

YATO	(W)	(mm)	PLATE (mm)	(kg)
YG-04555	1800	310 x 370 x 205	230 x 225	15

YATO	(W)	(mm)	PLATE (mm)	(kg)
YG-04556	1800	310 x 370 x 215	230 x 225	15



YATO	(W)	(mm)	PLATE (mm)	(kg)
YG-04557	2200	440 x 370 x 190	345 x 230	18



YATO	(W)	(mm)	PLATE (mm)	(kg)
YG-04558	2200	440 x 370 x 190	345 x 230	18



YATO	(W)	(mm)	PLATE (mm)	(kg)
YG-04560	3600	580 x 360 x 190	485 x 230	24



Gas-fired grill

- DE Gasgrill
- RU Газовый гриль
- UK Газовий гриль
- LT Dujinis grilis
- LV Gāzes grils
- CS Plynový gril
- SK Plynový gril
- HU Gázgrill
- RO Grătar cu gaz
- ES Barbacoa de gas
- FR Barbecue au gaz
- PT Churrasqueira a gás
- IT Barbecue a gas
- BG Газов грил
- EL Σχάρα αερίου
- ZH 燃气烧烤炉



YG-20018

9+2.2 kW **3+1**



YG-20019

12+2.2 kW **4+1**



YATO	(kW)	(mm)	GRATE (mm)	LATTICE (mm)	(kg)
YG-20018	11.2	1220 x 570 x 1120	600 x 420 (2 pcs)	570 x 120	32
YG-20019	14.2	1330 x 570 x 1120	700 x 420 (3 pcs)	675 x 120	36

SS STAINLESS STEEL **360°** **4x** **4x** BRAKE



Gas-fired grill

- DE Gasgrill
- RU Газовый гриль
- UK Газовий гриль
- LT Dujinis grilis
- LV Gāzes grils
- CS Plynový gril
- SK Plynový gril
- HU Gázgrill
- RO Grătar cu gaz
- ES Barbacoa de gas
- FR Barbecue au gaz
- PT Churrasqueira a gás
- IT Barbecue a gas
- BG Газов грил
- EL Σχάρα αερίου
- ZH 燃气烧烤炉

18+2.2 kW **6+1** **SS** STAINLESS STEEL **360°** **4x** BRAKE



YATO	(kW)	(mm)	GRATE (mm)	LATTICE (mm)	(kg)
YG-20004	20.2	1440 x 570 x 1130	780 x 420 (x2: 225 x 415x1: 335 x 415)	790 x 120	39.5

Gas-fired grill

- | | |
|-------------------|------------------------|
| DE Gasgrill | RO Grătar cu gaz |
| RU Газовый гриль | ES Barbecoa de gas |
| UK Газовий гриль | FR Barbecue au gaz |
| LT Dujinis grilis | PT Churrasqueira a gás |
| LV Gāzes grils | IT Barbecue a gas |
| CS Plynový gril | BG Газов грил |
| SK Plynový gril | EL Σχάρα αερίου |
| HU Gázgrill | ZH 燃气烧烤炉 |



9+2.2 kW

3+1

SS
STAINLESS STEEL

360°
4x

4x
BRAKE



YATO	(kW)	(mm)	GRATE (mm)	LATTICE (mm)	(kg)
YG-20015	11.2	1220 x 570 x 1140	GRATE (mm)	LATTICE (mm)	38

Gas-fired grill

- | | |
|-------------------|------------------------|
| DE Gasgrill | RO Grătar cu gaz |
| RU Газовый гриль | ES Barbecoa de gas |
| UK Газовий гриль | FR Barbecue au gaz |
| LT Dujinis grilis | PT Churrasqueira a gás |
| LV Gāzes grils | IT Barbecue a gas |
| CS Plynový gril | BG Газов грил |
| SK Plynový gril | EL Σχάρα αερίου |
| HU Gázgrill | ZH 燃气烧烤炉 |



12+2.2 kW

4+1

SS
STAINLESS STEEL

360°
4x

4x
BRAKE



YATO	(kW)	(mm)	GRATE (mm)	LATTICE (mm)	(kg)
YG-20003	14.2	1330 x 570 x 1130	700 x 420 (x2: 225 x 410x1: 220 x 415ø300)	675 x 120	41.5

Gas-fired grill

- | | |
|-------------------|------------------------|
| DE Gasgrill | RO Grătar cu gaz |
| RU Газовый гриль | ES Barbecoa de gas |
| UK Газовий гриль | FR Barbecue au gaz |
| LT Dujinis grilis | PT Churrasqueira a gás |
| LV Gāzes grils | IT Barbecue a gas |
| CS Plynový gril | BG Газов грил |
| SK Plynový gril | EL Σχάρα αερίου |
| HU Gázgrill | ZH 燃气烧烤炉 |

18+2.2 kW

6+1

SS
STAINLESS STEEL

360°
4x

4x
BRAKE



YATO	(kW)	(mm)	GRATE (mm)	LATTICE (mm)	(kg)
YG-20016	20.2	1440 x 570 x 1120	800 x 420	820 x 120	46

Gas-fired grills

DE Gasgrills
RU Газовые грили
UK Газові грилі
LT Dujiniai griliai
LV Gāzes grili
CS Plynové grily
SK Plynové grily
HU Gázgrillek
RO Grătare cu gaz
ES Barbacoas de gas
FR Barbécues à gaz
PT Churrasqueiras a gás
IT Barbecue a gas
BG Газови грилове
EL Σχάρες αερίου
ZH 燃气烤架



14+3.5 kW	4+1	SS STAINLESS STEEL	360° 4x	4x BRAKE
-----------	-----	-----------------------	------------	-------------

YATO	(kW)	(mm)	GRATE (mm)	LATTICE (mm)	(kg)
YG-20013	17.5	1470 x 580 x 1270	650 x 460 (2 pcs.)	680 x 170	59.5



Gas-fired grill 2 in 1

DE Gasgrill
RU Газовый гриль
UK Газовий гриль
LT Dujinis grilis
LV Gāzes grils
CS Plynový gril

SK Plynový gril
HU Gázgrill
RO Grătar cu gaz
ES Barbacoa de gas
FR Barbecue au gaz
PT Churrasqueira a gás

IT Barbecue a gas
BG Газов грил
EL Σχάρα αερίου
ZH 燃气烧烤炉

6+2.2 kW	2+1	SS STAINLESS STEEL	360° 4x	4x BRAKE
----------	-----	-----------------------	------------	-------------



YATO	(kW)	(mm)	GRATE (mm)	LATTICE (mm)	(kg)
YG-20030	8.2	1620 x 660 x 1130	900 x 420	900 x 120	54

Cast iron plate for gas grills

DE Gusseisenplatte für Gasgrills
RU Плита чугунная для газовых грилей
UK Чавунна пластина для газових грилів
LT Ketaus plokštė dujinėms kepsninėms
LV Čuguna plāksne gāzes restēm
CS Litinová deska pro plynové grily
SK Litinová platňa pre plynové grily
HU Öntöttvas lemez gázcsokhoz
RO Placă de fontă pentru grătare pe gaz
ES Placa de hierro fundido para parrillas de gas
FR Plaque en fonte pour grils à gaz
PT Placa de ferro fundido para churrasqueiras a gás
IT Piastra in ghisa per grill a gas
BG Чугунена плоча за газови скари
EL Πλάκα από χυτοσίδηρο για γκριλ αερίου
ZH 燃气烧烤炉用铸铁板



220x410 mm

CAST IRON
ZELIWO

2.7 kg

YATO	(mm)	FOR:
YG-20020	220 x 410	YG-20002, YG-20003, YG-20004, YG-20011, YG-20014, YG-20015, YG-20016, YG-20017, YG-20030, YG-20018, YG-20019

Automatic rotisserie for gas grill

DE Automatischer Spieß für Gasgrill
 RU Автоматический вертел для газового гриля
 UK Автоматичний рожен для газового гриля
 CS Automatický rožeň k plynovému grilu
 SK Automatický ražeň na plynový gril
 HU Automatikus nyárs gázgrillhez
 RO Rotisr automat pt. gratare pe gaz
 ES Espetón automático para parrilla de gas
 FR Rôtissoire automatique pour barbecue à gaz
 PT Espeto automático para churrasqueira a gás

IT Girarrosto automatico per barbecue a gas
 BG Автоматичен барбекю-шиш за газова скара
 EL Σούβλα με μοτέρ για ψησταριές υγραερίου
 ZH 烤炉配件



4W
SS
STAINLESS STEEL

YATO	BARBECUE (mm)	HANDLE (mm)	ENGINE (mm)	FOR:
YG-20021	825	110	70	YG-20001, YG-20003, YG-20012, YG-20013, YG-20014, YG-20015, YG-20016

BBQ covers

DE Wetterschutzhaube
 RU Обложка гриля
 UK Чехол гриль
 CS Obal na gril
 SK Obal na gril
 HU Grill takaróponyu
 RO Gratar acoperă
 ES Cubierta de barbacoa
 FR Couverture de grill
 PT Cobertura churrasco grade
 IT Telo per barbecue
 BG Покривало за барбекю
 EL Κάλυμμα ψησταριάς
 ZH 烤炉罩



PVC
COATED
600D
POLYESTER

YATO	(mm)	FOR:
YG-20050	1300 x 600 x 1050	YG-20001, YG-20002, YG-20011, YG-20015, YG-20018, YG-20019
YG-20051	1500 x 650 x 1050	YG-20003, YG-2004, YG-20012, YG-20013, YG-20014, YG-20016, YG-20017, YG-20030

Grill basket

DE Grillkorb
 RU Корзина для барбекю
 UA Кошик для гриля
 CS Grilovací koš
 SK Grilovací kôš
 HU Grillező kosár
 RO Coș pt. grătar
 ES Cesta para barbacoa

FR Panier à griller
 PT Cesto para churrasco
 IT Cestello per barbecue
 BG Кошница за скара
 EL Καλάθι ψησίματος για ψησταριά
 ZH 烧烤盘

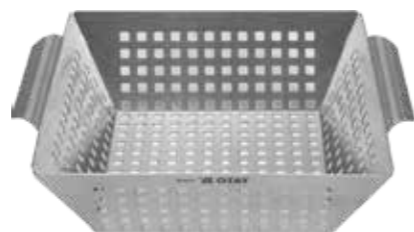

26x22 x7 cm
SS430
STAINLESS STEEL
1.0 mm

YATO	(cm)
YG-20140	26 x 22 x 7

Electric grill brush

DE Elektrische Grillbürste
 RU Аккумуляторная щетка для чистки гриля
 UK Електрична щітка для гриля
 CS Elektrický kartáč na gril
 SK Elektrická kefa na gril
 HU Elektromos grillkefe
 RO Perie electrica pt. gratar
 ES Cepillo eléctrico para parrillas
 FR Brosse électrique pour barbecue
 PT Escova elétrica para limpar grelha
 IT Spazzola elettrica per barbecue
 BG Акумулаторна четка за почистване на скара
 EL Ηλεκτρική βούρτσα καθαρισμού σχάρας
 ZN 电动烧烤刷



7.2 V
2000mAh
Li-Ion
700
min
2h
15-30 min
USB
TYPE C
SS304
STAINLESS STEEL



Replacement grill brush head

DE Ersatz-Bürstenkopf
 RU Сменная щетка
 UK Змінна головка щітки
 CS Výměnná hlavice do kartáče
 SK Vymeniteľná hlava na kefu
 HU Cserélhető kefefej
 RO Rezerva peria electrica pt. gratar
 ES Cabezal sustituible para cepillo
 FR Tête de brosse de rechange
 PT Cabeça amovível para escova
 IT Testina di ricambio per spazzola
 BG Сменяема глава на четката
 EL Αντικαταστάσιμη κεφαλή βούρτσας
 ZN 滾刷

SS304
STAINLESS STEEL



YATO	(mm)
YG-20101	60 x 80

YATO	(V d.c.)	HEAD (mm)
YG-20100	7.2	60 x 80

Single and dual deep fryers

DE Einzel- und Doppelfritteusen
 RU Однoчные и двойные фритюрницы
 UK Одиначні і подвійні фритюрниці
 LT Paviėnės ir dvigubos fritiūrinės
 LV Fri katli vienkārsie un dubultie
 CS Jednotlivé i dvojité fritězy
 SK Jednoduché a dvojité fritězy
 HU Szimpla és dupla olajsütők
 RO Friteuze

ES Freidoras de cuba simple y doble
 FR Friteuses à simple et double cuve
 PT Fritadeiras simples e duplas
 IT Friggitrici singole e doppie
 BG Фритюрници единични и двойни
 EL Μονές και διπλές φριτέζες
 ZH 电炸炉

60-200 °C
SS
STAINLESS STEEL
PC
PANEL COVER
COLD AREA



Single deep fryers

YATO	(W)	MAX. (l)*	BASKET (mm)	(mm)	(kg)
YG-04608	2000	3.5	210 x 125 x 95	430 x 200 x 290	4.5
YG-04609	2000	5	210 x 125 x 135	430 x 200 x 335	5.5
YG-04610	3000	6	210 x 190 x 95	430 x 285 x 285	6
YG-04616	3300	8.5	210 x 190 x 150	430 x 285 x 335	6.5
YG-04617	5000	11	240 x 220 x 120	490 x 285 x 360	8



Dual deep fryers

* separate switches and thermostats for each of the two chambers

YATO	(W)	MAX. (l)*	BASKET (mm)	(mm)	(kg)
YG-04620	2 x 2000	2 x 3.5	215 x 120 x 95	425 x 410 x 290	9
YG-04621	2 x 2000	2 x 5	215 x 120 x 135	425 x 410 x 340	9.5
YG-04622	2 x 3000	2 x 6	215 x 195 x 95	425 x 580 x 305	10.5
YG-04623	2 x 3300	2 x 8	215 x 195 x 150	425 x 580 x 335	12
YG-04624	2 x 5000	2 x 11.5	240 x 220 x 110	490 x 595 x 360	15

* total capacity

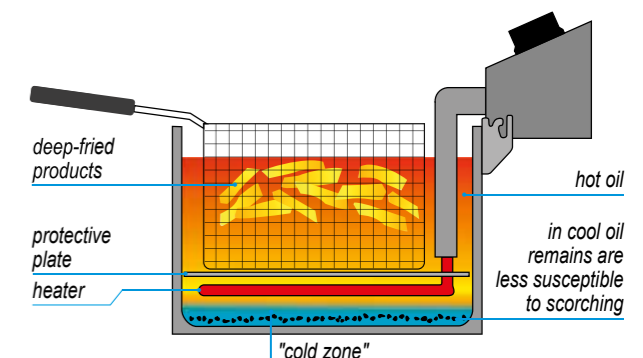

Deep fryers with a faucet

- | | |
|-----------------------------------|--------------------------------------|
| DE Fritteusen mit Hahn | RO Friteuze cu robinet de golire |
| RU Фритюрницы с краном | ES Freidoras con grifo de vaciado |
| UK Фритюрниця з краном | FR Friteuses avec robinet de vidange |
| LT Fritiūrines su čiaupu | PT Fritadeiras com torneira |
| LV Fri katli ar krāniņu | IT Friggitrici con rubinetto |
| CS Fritézy s ventilem | BG Фритюрници с кран |
| SK Fritézy s ventilom | EL Φριτέζες με βρύση |
| HU Olajsütő olajleeresztő csappal | ZH 带龙头的电炸炉 |



Single deep fryer with a faucet

YATO	(W)	MAX. (l)*	BASKET (mm)	(mm)	(kg)
YG-04630	5000	12	240 x 220 x 115	550 x 365 x 400	11



Dual deep fryer with a faucet

YATO	(W)	MAX. (l)*	BASKET (mm)	(mm)	(kg)
YG-04634	2 x 5000	2 x 12	240 x 220 x 120	550 x 730 x 400	18

* total capacity

- °C
60-200
- SS**
STAINLESS STEEL
- PC**
PANEL COVER
- COLD
AREA
- DRAINING
TAP

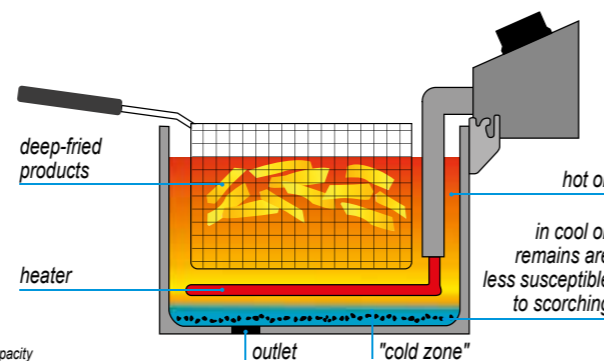

Freestanding deep fryers

- | | |
|-----------------------------------|-----------------------------------|
| DE Freistehende Fritteusen | RO Friteuze adânci |
| RU Автономные фритюрницы | ES Freidoras independientes |
| UK Автономні фритюрниця | FR Friteuses indépendantes |
| LT Laisvai pastatomos fritiūrines | PT Fritadeiras com pés |
| LV Brīvi stāvoši fri katli | IT Friggitrici autoportanti |
| CS Volně stojící fritéza | BG Свободно стоящи фритюрници |
| SK Stojanové fritézy | EL Φριτέζες ελεύθερης τοποθέτησης |
| HU Szabadon álló olajsütő | ZH 立式电炸炉 |

- °C
60-200
- SS**
STAINLESS STEEL
- PC**
PANEL COVER
- COLD
AREA
- DRAINING
TAP

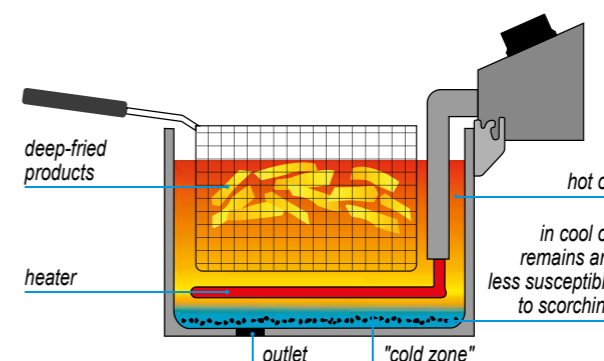

YATO	(W)	MAX. (l)*	BASKET (mm)	CABINET (mm)	(mm)	(kg)
YG-04636	5000	11.5	240 x 225 x 115	315 x 370 x 390	520 x 365 x 935	16
YG-04638	2 x 5000	2 x 11.5	240 x 225 x 115	680 x 370 x 390	520 x 730 x 900	31

* total capacity

Frying machines

- DE Multibräter
- RU Жарительницы
- UK Жаровня
- LT Gruzdintuvės
- LV Cepēji
- CS Smažicí stroje
- SK Zariadenia na vysmážanie
- HU Olajsütők
- RO Maşini de prăjit
- ES Freidoras
- FR Friteuses
- PT Fritadeiras
- IT Friggitrici
- BG Специални фритюрници
- EL Ανατρελόµενα τηγάνια
- ZH 电炸炉

°C 60-200
SS STAINLESS STEEL
PC PANEL COVER
COLD AREA
DRAINING TAP



YG-04640



YG-04641

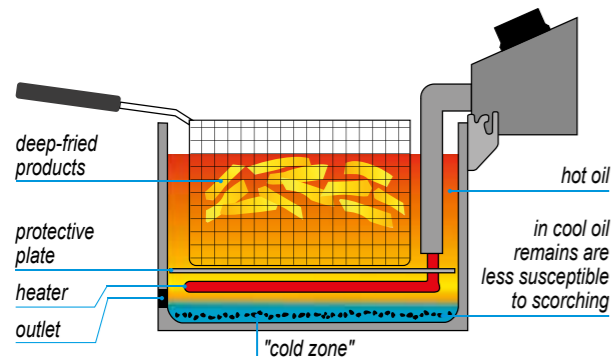
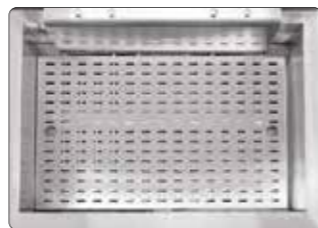
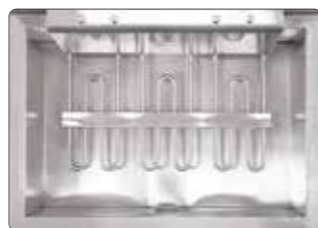

YATO	(W)	MAX. (l)*	BASKET (mm)	(mm)	(kg)
YG-04640	6000	23	270 x 480 x 90	570 x 580 x 340	14
YG-04641	6000	26.5	270 x 480 x 90	600 x 600 x 360	15

* total capacity

Pancake maker

- DE Crepesmaker
- RU Блинная
- UK Млинниця
- LT Lietinių gaminimo aparatas
- LV Pankūku cepšanas iekārta
- CS Palačinkovač
- SK Stroj na smaženie palacinek
- HU Palacsinta készítő
- RO Plită pentru clătite
- ES Crepera
- FR Crêpière
- PT Panquequeira
- IT Macchina per pancake
- BG Уред за палачинки
- EL Τηγάνι για κρέπες
- ZH 煎饼机

400 mm
PTFE
°C 50-300 WORKING TEMPERATURE
3000W
SS STAINLESS STEEL



YATO	(W)	(mm)	PLATE (mm)	(kg)
YG-04680	3000	450 x 470 x 220	Ø 400 x 15	13

Rice cookers

- DE Reiskocher
- RU Рисоварки
- UK Пристрої для приготування рису
- LT Ryžių virimo įrenginys
- LV Rīsu vāritāji
- CS Zařízení k vaření rýže
- SK Zariadenia na varenie ryže
- HU Rizsfőző készülék
- RO Oală pentru gătit orezului
- ES Aparatos para cocinar arroz
- FR Cuiseurs à riz
- PT Panelas de arroz
- IT Macchina per la cottura del riso
- BG Уред за варене на ориз
- EL Συσκευές για μαγειρέμα ριζιού
- ZH 电饭煲

SS STAINLESS STEEL
ABS
ENERGY SAVING MODE
COOKING WARMING DIODES
NON STICK POT



YG-04695

- container capacity: 16.5 l
- maximum amount of dry rice: 5.5 l (30 servings of 180 ml)
- internal dimensions of the container: Ø 320 x 210 mm

YG-04696

- container capacity: 27 l
- maximum amount of dry rice: 9 l (50 servings of 180 ml)
- internal dimensions of the container: Ø 380 x 240 mm

YATO	V (l)	(mm)	(W)
YG-04695	16.5	480 x 380 x 380	1950
YG-04696	27	560 x 490 x 405	2850



Steel food transport containers

DE Transport-Thermobehälter aus Stahl
RU Термосы для транспортировки
UK Сталеві транспортні термоси
LT Plieniniai transportavimo termosai
LV Transportēšanas termosi, tērauda
CS Převážní stylové termosky
SK Prepravné oceľové termosky
HU Acél szállítótermoszok
RO Container etanș pentru transport
ES Contenedores isotérmicos de acero
FR Récipients isothermes en acier
PT Garrafas térmicas de aço para transporte
IT Thermos da trasporto in acciaio
BG Стоманени термоси за транспортиране
EL Θερμομονωτικές φιάλες μεταφοράς από ανοξείδωτο χάλυβα
ZH 保温桶



SS443/201 STAINLESS STEEL	THERMAL ISOLATION	80-68 °C 0-6 °C 8h
DECOMPRESSION VALVE	SILICONE GASKET	RUBBER BOTTOM PAD
x2 HANDLES	x6 CLIPS	DOUBLE WALL

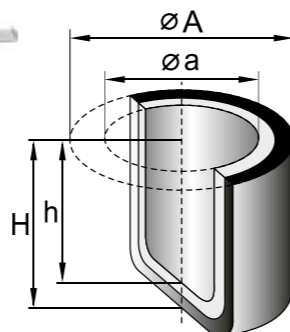

YATO	V (l)	ø A (mm)	ø a (mm)	H (mm)	h (mm)
YG-09200	10	355	300	240	165
YG-09201	15	355	300	300	210
YG-09202	20	355	300	380	300

YATO	V (l)	ø A (mm)	ø a (mm)	H (mm)	h (mm)
YG-09203	25	355	300	450	375
YG-09204	35	355	300	590	510
YG-09205	50	505	450	390	320

Thermally insulated food transport containers

DE Thermobehälter für den Transport von Lebensmitteln
RU Термосы для транспортировки пищи
UK Термос для транспортування їжі
LT Maisto transportavimo termosai
LV Pārtikas transportēšanas termosi
CS Termosky k přepravě potravin
SK Prepravné termosky pre potraviny
HU Ételszállító termoszok
RO Vas izoterm pentru transportul alimentelor
ES Contenedores isotérmicos transporte de alimentos
FR Conteneurs isothermes pour le transport d'aliment
PT Garrafas térmicas para transporte de alimentos

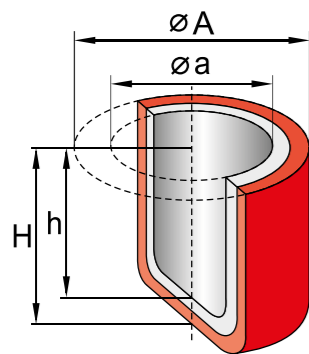

YATO	V (l)	ø A (mm)	ø a (mm)	H (mm)	h (mm)
YG-09225	15	335	280	300	240
YG-09226	30	410	350	380	320
YG-09227	48	465	405	445	380

SS STAINLESS STEEL	PE DECOMPRESSION VALVE	
SILICONE GASKET	THERMAL ISOLATION	85-80 °C -3-0 °C 4h
x2 HANDLES	x4 CLIPS	



Thermally insulated catering container GN 1/1

DE Thermoisolierte Cateringbehälter GN 1/1
RU Контейнер с термоизоляцией GN 1/1
UK Кейтеринговий теплоізоляційний контейнер GN 1/1
LT Termoizoliacinis maisto pervežimo konteineris GN 1/1
LV Kateringā termoss GN 1/1
CS Cateringová termoizolační nádoba GN 1/1
SK Termoizolačná cateringová nádoba GN 1/1
HU GN 1/1 thermo láda
RO Recipient termoizolant GN 1/1

ES Contenedores isotérmicos de hostelería GN 1/1
FR Récipient isotherme pour la restauration GN 1/1
PT Recipiente isolado para restauração GN 1/1
IT Contenitore termoisolante per il catering GN 1/1
BG Изотермичен контейнер GN 1/1
EL Δοχείο θερμομόνωσης GN 1/1 για κέτερινγκ
ZH 保温桶

GN 1/1	THERMAL ISOLATION	85-80 °C -3-0 °C 4h
PE	x4 CLIPS	



YATO	V (l)	(mm)	INTERIOR (mm)
YG-09250	30	610 x 410 x 310	510 x 300 x 200

Thermally insulated catering container GN 1/1

DE Thermoisolierte Cateringbehälter GN 1/1
RU Контейнер с термоизоляцией GN 1/1
UK Кейтеринговий теплоізоляційний контейнер GN 1/1
LT Termoizoliacinis maisto pervežimo konteineris GN 1/1
LV Kateringā termoss GN 1/1
CS Cateringová termoizolační nádoba GN 1/1
SK Termoizolačná cateringová nádoba GN 1/1
HU GN 1/1 thermo láda
RO Recipient termoizolant GN 1/1
ES Contenedores isotérmicos de hostelería GN 1/1
FR Récipient isotherme pour la restauration GN 1/1
PT Recipiente isolado para restauração GN 1/1
IT Contenitore termoisolante per il catering GN 1/1

BG Изотермичен контейнер GN 1/1
EL Δοχείο θερμομόνωσης GN 1/1 για κέτερινγκ
ZH 保温桶



GN 1/1	40L	THERMAL ISOLATION
30mm WALL THICKNESS	PIOCELAN	LID



YATO	V (l)	(mm)	INTERIOR (mm)
YG-09210	40	600 x 400 x 283	540 x 340 x 222

Thermally insulated catering cabinet

DE Thermoisolierte Cateringbehälter
RU Термоконтейнер для перевозки
UK Кейтеринговий теплоізоляційний контейнер
LT Termoizoliacinis maisto pervežimo konteineris
LV Kateringa termoss
CS Cateringová termoizolační nádoba
SK Termoizolačná cateringová nádoba
HU Thermo láda
RO Container termoizolant pentru transport
ES Contenedores isotérmicos para restaurantes
FR Récipients isothermes pour la restauration
PT Recipiente isolado para restauração
IT Contenitore termoisolante per il catering
BG Изотермичен контейнер за кетъринг

EL Δοχείο θερμομόνωσης για κέτερινγκ
ZH 保温餐柜

90L	PE	1/1 GN x6 (65mm) x4 (100mm) x3 (150mm)	1/2 GN x8 (100mm) x4 (150mm)	1/3 GN x12 (100mm) x9 (150mm) x6 (200mm)
------------	-----------	--	---	--

80-68°C 0-6°C 4h	THERMAL ISOLATION
------------------------	-------------------

x2 HANDLES	DECOMPRESSION VALVE
------------	---------------------



YATO	(mm)
YG-09245	477 x 680 x 620

- equipped with 12 guides that make it match the following GN containers:
- 1/1, 65 mm high – 6 pcs.
- 1/1, 100 mm high – 4 pcs.
- 1/1, 150 mm high – 3 pcs.
- 1/2, 100 mm high – 8 pcs.
- 1/2, 150 mm high – 4 pcs.
- 1/3, 100 mm high – 12 pcs.
- 1/3, 150 mm high – 9 pcs.
- 1/3, 200 mm high – 6 pcs.

Cart for thermally insulated cabinet

DE Wagen für thermoisolierte Behälter
RU Подставка для термоконтейнера на колесах
UK Візок для термоізоляційного контейнера
LT Termoizoliacinio konteinerio vežimėlis
LV Ratiņi kateringa termosam
CS Vozík na termoizolační nádobu
SK Vozík pre termoizolačné nádoby
HU Thermo láda szállító kocsik
RO Platformă cu roți
ES Carro portacontenedores isotérmicos
FR Chariot pour conteneurs isothermes
PT Carrinho para recipientes térmicos

IT Carrello per il contenitore termoisolante
BG Количка за изотермичен контейнер
EL Καροτσάκι για δοχεία θερμομόνωσης
ZH 保温柜推车

PP	x2 YG-09245 MAX LOAD	360° 2x BRAKE	FOR: YG-09245
-----------	-------------------------	------------------	------------------



YATO	(mm)	FOR:
YG-09246	710 x 530 x 230	YG-09245

Thermally insulated beverage dispenser

DE Thermoisolierte Transportbehälter
RU Термоконтейнеры для транспортировки
UK Транспортні термоізоляційні ємності
LT Termoizoliaciniai maisto transportavimo konteineriai
LV Transportēšanas termosi
CS Přepavné termoizolační nádoby
SK Prepravné termoizolačné nádoby
HU Thermo szállító ládák
RO Containere termoizolante pentru băuturi
ES Contenedores isotérmicos de transporte
FR Conteneurs isothermes de transport
PT Recipientes térmicos para transporte
IT Contenitori da trasporto termoisolanti
BG Изотермични контейнери за транспортиране
EL Δοχείο θερμομόνωσης μεταφοράς
ZH 饮料保温分配器

x2 HANDLES	80-72°C 0-4°C 4h	THERMAL ISOLATION	PE	
------------	------------------------	-------------------	-----------	--



YATO	V (l)	(mm)	INTERIOR (mm)
YG-09249	9	430 x 230 x 470	330 x 175 x 265

Waiter trolleys

DE Kellnerwagen
RU Тележки для официантов
UK Візки для офіціантів
LT Padavėjo vežimėlis
LV Viesmīju ratiņi
CS Číšnické vozíky
SK Čašnické vozíky
HU Pincérkocsik
RO Cărucioare pentru servire
ES Carros de camarero
FR Table roulante
PT Carrinhos de garçom
IT Carrelli per camerieri

BG Ресторантски колички за сервиране
EL Καροτσάκια σερβιτόρων
ZH 服务车

SS 201 STAINLESS STEEL	max 50kg SHELF	2x BRAKE
----------------------------------	-------------------	----------

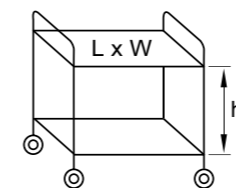

Two-shelf waiter trolley

YATO	L x W x H (mm)	L1 x W1 (mm)	h (mm)
YG-09090	860 x 530 x 950	820 x 500	570

x2 SHELVES

Three-shelf waiter trolley

YATO	L x W x H (mm)	L1 x W1 (mm)	h (mm)
YG-09091	860 x 530 x 950	820 x 500	270

x3 SHELVES

Waiter trolleys

DE Servierwagen
RU Сервировочные тележки
UK Сервісні візки
LT Serviravimo vežimėliai
LV Servēšanas ratiņi
CS Servisní vozíky
SK Vozíky na servírovanie
HU Felszolgáló kocsik
RO Cărucioare din oțel inoxidabil
ES Carros de servicio
FR Chariots de service
PT Carrinhos de serviço
IT Carrelli di servizio
BG Ресторантски колички за съдове
EL Καροτσάκια σέρβις
ZH 服务车

SS 201 STAINLESS STEEL	max 45kg SHELF	2x BRAKE
----------------------------------	-------------------	----------

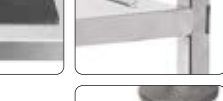

Two-shelf waiter trolley

YATO	L x W x H (mm)	L1 x W1 (mm)	h (mm)
YG-09095	950 x 500 x 950	890 x 495	600

x2 SHELVES

Three-shelf waiter trolley

YATO	L x W x H (mm)	L1 x W1 (mm)	h (mm)
YG-09096	950 x 500 x 950	890 x 495	280

x3 SHELVES

Deep two-shelf waiter trolley

YATO	L x W x H (mm)	L1 x W1 (mm)	h (mm)
YG-09099	950 x 500 x 950	820 x 430	500

x2 SHELVES

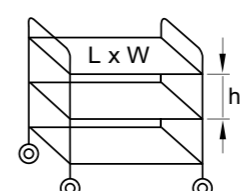
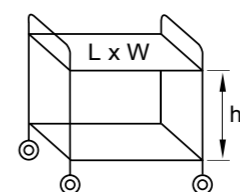

Service trolley

DE Servierwagen
RU Сервисная тележка
UK Сервісний візок
LT Serviravimo vežimėlis
LV Servēšanas ratiņi
CS Servisní vozík
SK Vozík na servírovanie
HU Felszolgáló kocsi
RO Cărucior pentru debarasat cu trei polițe
ES Carro de servicio
FR Chariot de service
PT Carrinho de serviço
IT Carrello di servizio
BG Ресторантска количка за съдове
EL Καροτσάκι σέρβις
ZH 服务车



PE

x3 SHELVES

2x BRAKE

360°

2x

YATO 	(mm)
YG-09100	1040 x 510 x 980

Containers for service trolley

DE Behälter für Servierwagen
RU Контейнеры для сервисной тележки
UK Контейнери для сервісного візка
LT Serviravimo vežimėlio indai
LV Trai servēšanas ratiņiem
CS Nádoby na servisní vozík
SK Nádoby pre vozík na servírovanie
HU Tartályok felszolgáló kocsihoz
RO Containere pentru cărucior de debarasare

ES Recipientes para carro de servicio
FR Conteneurs pour chariot de service
PT Recipientes para carrinho de serviço
IT Contenitori per il carrello di servizio
BG Контейнери за ресторантска количка
EL Δοχείο για καροτσάκι σέρβις
ZH 服务车收集盒



YATO 	(mm)	FOR:
YG-09104	330 x 230 x 175	YG-09100
YG-09105	340 x 225 x 440	YG-09100

Service trolley

DE Servierwagen
RU Сервисная тележка
UK Сервісний візок
LT Serviravimo vežimėlis
LV Servēšanas ratiņi
CS Servisní vozík
SK Vozík na servírovanie
HU Felszolgáló kocsi
RO Cărucior pentru debarasat cu trei polițe
ES Carro de servicio
FR Chariot de service
PT Carrinho de serviço
IT Carrello di servizio
BG Ресторантска количка за съдове
EL Καροτσάκι σέρβις
ZH 服务车



SS
STAINLESS STEEL

PP

x5 CONTAINERS

2x BRAKE

360°

2x

YATO 	(mm)
YG-09101	870 x 435 x 905

Containers for service trolley

DE Behälter für Servierwagen
RU Контейнеры для сервисной тележки
UK Контейнери для сервісного візка
LT Serviravimo vežimėlio indai
LV Trai servēšanas ratiņiem
CS Nádoby na servisní vozík
SK Nádoby pre vozík na servírovanie
HU Tartályok felszolgáló kocsihoz

RO Containere pentru cărucior de debarasare
ES Recipientes para carro de servicio
FR Conteneurs pour chariot de service
PT Recipientes para carrinho de serviço
IT Contenitori per il carrello di servizio
BG Контейнери за ресторантска количка
EL Δοχείο για καροτσάκι σέρβις
ZH 服务车收集盒



YATO 	(mm)	INTERIOR (mm)	FOR:
YG-09102	540 x 380 x 135	460 x 330 x 130	YG-09101
YG-09103	540 x 380 x 205	460 x 330 x 200	YG-09101
YG-09106	275 x 195 x 310	265 x 185 x 305	YG-09101

Transport trolleys

DE Transportwagen
RU Тележки-шпильки
UK Транспортні візки
LT Transportavimo vežimėliai
LV Transportēšanas ratiņi
CS Přepravné vozíky
SK Prepravné vozíky
HU Tálcaszállító kocsi
RO Cărucioare pentru transportul tăvilor și GN-urilor

ES Carro de transporte
FR Chariot de transport
IT Carrelli da trasporto
BG Транспортни колички
EL Καροτσάκια μεταφοράς
PT Carrinhos de transporte
ZH 手推车

SS 201
STAINLESS STEEL

max 40kg
SHELF

80 mm

2x BRAKE

TRANSPORT LOCK



15x 1/1 GN

30x 1/2 GN

Guides M



The guides enables adjusting the spacing between containers



15x BAKERY CONTAINERS

15x TRAY
400x600 mm

Guides L



Transport trolley for GN containers

YATO 	(mm)
YG-09070	380 x 550 x 1700

Gastronomic trolley for waiter's trays and baking trays

YATO 	(mm)
YG-09072	470 x 620 x 1700

Platform trolley

- DE Plattformwagen
- RU Платформенная тележка
- UK Платформний візок
- LT Platforminis vežimėlis
- LV Platformas ratiņi
- CS Platformový vozík
- SK Plošinový vozík
- HU Platform kocsi
- RO Cărucior platformă
- ES Carro de plataforma
- FR Chariot à plate-forme
- PT Carrinho de plataforma
- IT Carrello a pianale
- BG Платформена количка
- EL Καροτσάκι πλατφόρμας
- ZH 折叠手推车

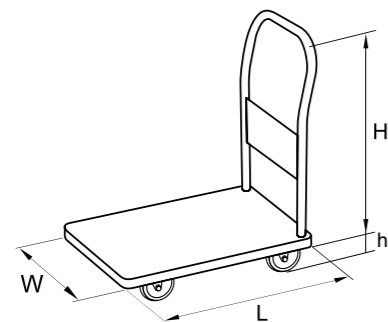

YATO 	L x W (mm)	H (mm)	h (mm)
YG-09080	740 x 440	725	125

SS 201
STAINLESS STEEL

max 
150kg



2x 

FOLDABLE HANDLE

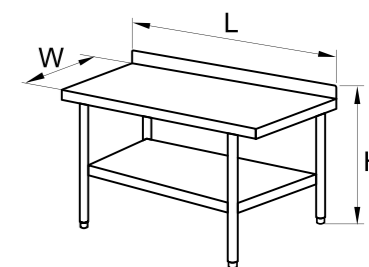
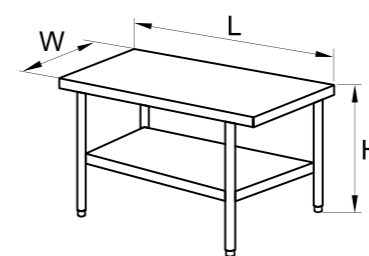

Assemblable work tables

- DE Arbeitstische – zusammengeschraubt
- RU Столы рабочие – сборные
- UK Болтові робочі столи
- LT Susukami darbataliai
- LV Darba galdi, saskrūvējami
- CS Pracovní montované stoly
- SK Pracovné stoly skladacie
- HU Csavarozott munkaasztalok
- RO Mese de lucru
- ES Mesa de trabajo para cocina profesional
- FR Table avec un plan de travail pour cuisine
- PT Mesas de trabalho montadas
- IT Banchi da lavoro avvitati
- BG Сглобяеми работни маси
- EL Περιστρεφόμενα τραπέζια εργασίας
- ZH 不锈钢工作台



SS 201
STAINLESS STEEL

max 
150kg
TABLE

max 
35kg
SHELF

ADJUSTABLE FEET



Central tables with undershelf

YATO 	L (mm)	W (mm)	H (mm)
YG-09000	800	600	850
YG-09001	1000	600	850
YG-09002	1200	600	850
YG-09003	1400	600	850
YG-09004	1500	600	850
YG-09005	1600	600	850
YG-09006	800	700	850
YG-09010	1000	700	850
YG-09011	1200	700	850
YG-09012	1400	700	850
YG-09013	1500	700	850
YG-09014	1600	700	850

Wall tables with undershelf - with a 100 mm back splash

YATO 	L (mm)	W (mm)	H (mm)
YG-09020	800	600	850+100
YG-09021	1000	600	850+100
YG-09022	1200	600	850+100
YG-09023	1400	600	850+100
YG-09024	1500	600	850+100
YG-09025	1600	600	850+100
YG-09030	800	700	850+100
YG-09031	1000	700	850+100
YG-09032	1200	700	850+100
YG-09033	1400	700	850+100
YG-09034	1500	700	850+100
YG-09035	1600	700	850+100

Slatted racks

- DE Lagerregale CS Transparentní regály FR Étagères ajourées EL Διάφανα ράφια
RU Сетчатые стеллажи SK Dierované regály PT Prateleiras vazadas ZH 置物架
UK Ажурні стелажі HU Állványos polc rendszer IT Scaffalature traforate
LT Ažūriniai stelažai RO Rafturi tip plasă BG Ажурни рафтове
LV Ažūra plauktu stelāžas ES Estanterías con baldas



Shelves

max **200 kg**
SHELF
8+2
FIXING
WEDGES

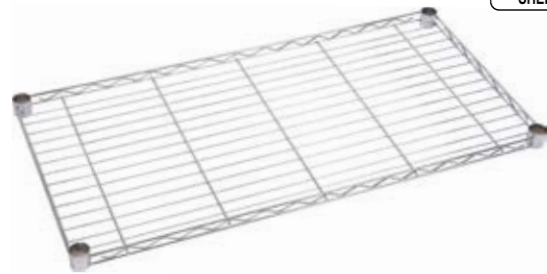

YATO	(mm)	CONFIGURATIONS OF ASSEMBLED RACK	(mm)
YG-09050	600 x 457	4 x YG-09050 + 4 x YG-09065	600 x 457 x 1880
YG-09051	906 x 457	4 x YG-09051 + 4 x YG-09065	906 x 457 x 1880
YG-09052	1210 x 457	4 x YG-09052 + 4 x YG-09065	1210 x 457 x 1880
YG-09053	1520 x 457	4 x YG-09053 + 4 x YG-09065	1520 x 457 x 1880
YG-09054	600 x 610	4 x YG-09054 + 4 x YG-09065	600 x 610 x 1880
YG-09055	906 x 610	4 x YG-09055 + 4 x YG-09065	906 x 610 x 1880
YG-09056	1060 x 610	4 x YG-09056 + 4 x YG-09065	1060 x 610 x 1880
YG-09057	1210 x 610	4 x YG-09057 + 4 x YG-09065	1210 x 610 x 1880
YG-09058	1520 x 610	4 x YG-09058 + 4 x YG-09065	1520 x 610 x 1880
YG-09059	1820 x 610	4 x YG-09059 + 4 x YG-09065	1820 x 610 x 1880

Bars

1880 mm
RUBBER FOOT

FOR:
YG-09050, YG-09051
YG-09052, YG-09053
YG-09054, YG-09055
YG-09056, YG-09057
YG-09058, YG-09059

YATO	L (mm)	∅ (mm)
YG-09065	1880	25.4

Hanging shelves with rim

- DE Hängeregale mit Rand
RU Навесные полки с бортиком
UK Навісні полиці з бортиками
LT Kabančios lentynos su kraštu
LV Piekaramie plaukti ar apmali
CS Visací police se záhybem
SK Závesné police s okrajom
HU Fügő polcok peremmel
RO Polița de perete cu bordură
ES Repisas flotantes con borde elevado
FR Étagères murales avec bord surélevé
PT Prateleiras suspensas com borda
IT Mensole sospese con bordo
BG Стенни рафтове с кант
EL Κρεμαστά ράφια με άκρες
ZH 不锈钢挂墙架

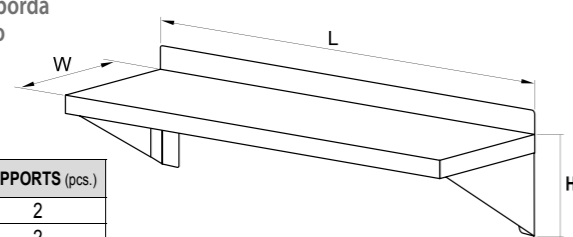

YATO	L x W x H (mm)	SUPPORTS (pcs.)
YG-09040	900 x 300 x 180	2
YG-09041	1200 x 300 x 180	2
YG-09042	1500 x 300 x 180	3
YG-09044	1800 x 300 x 180	3



SS
STAINLESS STEEL

Vacuum packaging machines

- DE Vakuum-Verpackungsmaschinen
RU Машины вакуумной упаковки
UK Вакуумні пакувальні машини
LT Vakuuminio pakavimo aparatas
LV Vakuuma iepakotāji
CS Vakuovací stroje
SK Vákuové baliace stroje
HU Vákuumsomagoló gépek
RO Mașini de ambalare în vid
ES Envasadoras al vacío
FR Machines d'emballage sous vide
PT Embaladoras a vácuo
IT Macchine confezionatrici sottovuoto
BG Вакуум опаковъчни машини
EL Μηχανήματα συσκευασίας κενού
ZH 真空封口机

SS
STAINLESS STEEL



Adjustable packaging machines

YATO	(mm)	CHAMBER (mm)	BAR (mm)	V (l)	(W)	(m³/h)
YG-09303	480 x 330 x 320h	385 x 280 x 50 (100)	260	230	370	10
YG-09304	480 x 370 x 435h	370 x 320 x 135 (185)	300	230	370	10
YG-09305	560 x 425 x 460h	450 x 370 x 170 (220)	350	230	900	20

Free-standing packaging machines

- equipped with 4 wheels with brakes



YATO	(mm)	CHAMBER (mm)	BAR (mm)	V (l)	(W)	(m³/h)
YG-09310	555 x 475 x 1000h	440 x 420 x 75 (125)	2 x 420	230	900	20
YG-09311	555 x 475 x 1050h	440 x 420 x 150 (200)	400	230	900	20
YG-09312	630 x 790 x 960h	720 x 480 x 150 (210)	2 x 460	230	900	20



Bags for vacuum packaging machines

DE Beutel für Vakuum-Verpackungsmaschinen
RU Пакеты для вакуумных упаковочных машин
UK Мішки для вакуумної упаковки
LT Maišeliai vakuuminiam pakavimo aparatui
LV Maisiņi vakuuma iepakotājiem
CS Pytlíky do vakuovacích strojů
SK Vrecká pre vákuové baliace stroje
HU Tasakok vákuumsomagoló géphez
RO Pungi pentru mașinile de ambalare în vid
ES Bolsas para envasadoras al vacío
FR Sacs pour machines d'emballage sous vide
PT Sacos para embaladoras a vácuo
IT Sacchetti per macchine confezionatrici sottovuoto
BG Пликове за вакуум машини
EL Σάκοι για μηχανήματα συσκευασίας κενού
ZH 真空包装袋

x100 70 μm



Bags for chamber packaging machines

YATO 	(mm)
YG-09330	140 x 200
YG-09331	160 x 230
YG-09332	200 x 300
YG-09333	250 x 350
YG-09334	300 x 400

Insulating spheres for sous vide cooking

DE Isolierkugeln zum Sous-Vide-Kochen
RU Изоляционные шарики для вакуумного приготовления
UK Ізоляційні кульки для приготування їжі sous vide
LT Sous vide izoliaciniai virimo rutuliukai
LV Izolācijas lodītes sous vide gatavošanai
CS Izolační kuličky pro vakuované vaření
SK Izolačné guľôčky na varenie sous vide
HU Szigetelő golyók Sous-Vide keringetőhöz
RO Bile izolante pentru gătit sous vide
ES Pelotas para cocina sous vide
FR Billes isolantes pour cuisson sous vide



PA/PE

Bags for sous vide and chamber packaging machines

Recommended for preparing dishes in sous vide technology, marinating and pasteurizing.
- they can be used at temperature from -20°C to +120°C

PA/PE SV 120°C (max)

YATO 	(mm)
YG-09335	140 x 200
YG-09336	160 x 230
YG-09337	200 x 300
YG-09338	250 x 350
YG-09339	300 x 400



YATO 	(pcs.)	Ø (mm)	MAX. TEMPERATURE (°C)
YG-04735	100	20	110

Industrial vacuum packaging machine

DE Industrie-Vakuum-Verpackungsmaschine
RU Промышленная машина вакуумной упаковки
UK Промислова вакуумна пакувальна машина
LT Pramoninis vakuuminio pakavimo aparatas
LV Rūpnieciskais vakuuma iepakotājs
CS Průmyslový vakuovací stroj
SK Priemyselný vákuový baliaci stroj
HU Ipari vákuumsomagoló gép
RO Mașină de ambalare în vid industrială
ES Envasadoras al vacío industrial
FR Machines d'emballage sous vide industrielles
PT Embaladora a vácuo industrial
IT Macchina confezionatrice sottovuoto industriale
BG Индустриална вакуум опаковъчна машина
EL Βιομηχανικό μηχάνημα συσκευασίας κενού
ZH 工业真空封口机



SS
STAINLESS STEEL
2x
720x560
mm
CHAMBER
160
mm
2x20
m³/h
PUMP EFFICIENCY
2x900W



YATO 	(mm)	CHAMBER (mm)	BAR (mm)	V (l)	(W)	(m ³ /h)
YG-09307	720 x 1460 x 980h	720 x 560 x 160	2 x 600	480	2 x 900	2 x 20

Cooling and freezing cabinets

DE Kühl- und Gefrierschränke
RU Холодильные и морозильные шкафы
UK Холодильні та морозильні шафи
LT Vėsavimo ir šaldymo spintos
LV Aukstuma skapji
CS Chladicí a mrazicí boxy
SK Chladné a mraziace skrine
HU Hűtő- és fagyasztószekrények
RO Dulapuri de răcire și congelare
ES Armarios refrigerados y de congelación
FR Armoires réfrigérées et congélateurs
PT Armários de refrigeração e congelamento
IT Armadi frigoriferi e congelatori
BG Хладилни шкафовe и фризерни
EL Θάλαμοι ψύξης και κατάψυξης
ZH 冷藏柜



Cooling and freezing 1-door cabinets

• 3 coated shelves

YATO	(°C)	V (l)	(mm)	(W)	(kg)	(kWh/year)*
YG-05215	-2/+8	600	680 x 810 x 2010	195	110	887
YG-05200	-2/+8	650	740 x 830 x 2010	215	121	1081
YG-05216	-18/-22	600	680 x 810 x 2010	450	117	2738
YG-05201	-18/-22	650	740 x 830 x 2010	480	126	2351



Cooling and freezing 2-door cabinets

• 6 coated shelves

YATO	(°C)	V (l)	(mm)	(W)	(kg)	(kWh/year)*
YG-05220	-2/+8	1200	1340 x 810 x 2010	400	167	1716
YG-05210	-2/+8	1300	1480 x 830 x 2010	440	188	1517
YG-05221	-18/-22	1200	1340 x 810 x 2010	700	177	4238
YG-05211	-18/-22	1300	1480 x 830 x 2010	780	201	3650

* power consumption

- SS 201 STAINLESS STEEL
- FORCED AIR CIRCULATION
- AUTOMATIC DEFROST
- max 40kg SHELF
- SELF CLOSING DOOR
- LOCK
- LED LIGHT
- x4 120-180mm ADJUSTABLE FEET
- R290 REFRIGERANT
- GN 2/1
- HEPA FILTER



Cooling tables – line 600

DE Kühlische – Linie 600
RU Холодильные столы – линия 600
UK Холодильні столи – лінія 600
LT Šaldomi darbastaliai – linija 600
LV Aukstuma galdi – sērija 600
CS Chladicí stoly – řada 600
SK Chladené stoly – linka 600
HU Hűtőasztalok – 600-as sorozat
RO Masă rece – linia 600
ES Mesas frigoríficas – serie 600
FR Tables de réfrigération – série 600
PT Mesas de refrigeração – linha 600
IT Tavoli refrigerati – linea 600
BG Хладилни маси – линия 600
EL Τραπεζία ψύξης – γραμμή 600
ZH 冷冻台 – 600 mm



Cooling 2-door table – line 600

- 2 coated shelves
- tabletop dimensions: 1360 x 600 mm
- adjusted height: 850-910 mm

YATO	(°C)	V (l)	(mm)	(W)	(kg)	(kWh/year)*
YG-05253	-2/+8	228	1360 x 600 x 850	215	83	913



Cooling 3-door table – line 600

- 3 coated shelves
- tabletop dimensions: 1795 x 600 mm
- adjusted height: 845-905 mm

YATO	(°C)	V (l)	(mm)	(W)	(kg)	(kWh/year)*
YG-05258	-2/+8	339	1795 x 600 x 845	230	105	1145

* power consumption

- SS 201 STAINLESS STEEL
- FORCED AIR CIRCULATION
- AUTOMATIC DEFROST
- max 40kg SHELF
- SELF CLOSING DOOR
- x4 140-200mm ADJUSTABLE FEET
- R290 REFRIGERANT



Cooling tables – line 700

DE Kühlische – Linie 700
RU Холодильные столы – линия 700
UK Холодильні столи – лінія 700
LT Šaldomi darbataliai – linija 700
LV Aukstuma galdi – sērija 700
CS Chladicí stoly – řada 700
SK Chladené stoly – linka 700
HU Hűtőasztalok – 700-as sorozat
RO Mesă rece – linia 700
ES Mesas frigoríficas – serie 700
FR Tables de réfrigération – série 700
PT Mesas de refrigeração – linha 700
IT Tavoli refrigerati – linea 700
BG Хладилни маси – линия 700
EL Τραπεζία ψύξης – γραμμή 700
ZH 冷冻台 – 700 mm



SS 201
STAINLESS STEEL

FORCED
AIR
CIRCULATION

AUTOMATIC
DEFROST



max
40kg
SHELF

SELF
CLOSING
DOOR

GN 1/1

HEPA
FILTER



Cooling 2-door table – line 700

- 2 coated shelves
- lower compressor – Zanussi
- cooling agent: R600a
- tabletop dimensions: 900 x 700 mm

R600a
REFRIGERANT

YATO	(°C)	V (l)	(mm)	(W)	(kg)	(kWh/year)*
YG-05270	+2/+8	240	900 x 700 x 870	170	75	830



SEE ALSO
shelves
and guides

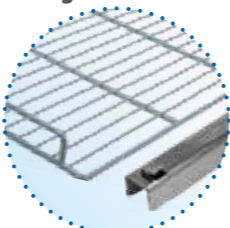

p. 84

Cooling 3-door table – line 700

- 3 coated shelves
- lower compressor – Embraco
- cooling agent: R290
- tabletop dimensions: 1365 x 700 mm

R290
REFRIGERANT

YATO	(°C)	V (l)	(mm)	(W)	(kg)	(kWh/year)*
YG-05300	+2/+8	368	1365 x 700 x 870	240	98	1294

* power consumption



Cooling table with 4 drawers – line 700

DE Kühlisch mit 4 Schubladen – Linie 700
RU Холодильный стол с 4 выдвижными ящиками – линия 700
UK Холодильний стіл з 4 ящиками – лінія 700
LT Šaldomas darbatalis su 4 stalčiais – linija 700
LV Aukstuma galds ar 4 atvilktņēm – sērija 700
CS Chladicí stůl se 4 šuplíky – řada 700
SK Chladený stôl s 4 zásuvkami – linka 700
HU Hűtőasztal 4 fiókkal – 700-as sorozat
RO Masă rece cu 4 sertare – linia 700
ES Mesas frigoríficas con 4 cajones – serie 700
FR Tables de réfrigération avec 4 tiroirs – série 700
PT Mesa de refrigeração com 4 gavetas – linha 700
IT Tavoli refrigerati con 4 cassetti – linea 700
BG Хладилна маса с 4 чекмеджета – линия 700
EL Τραπεζία ψύξης με 4 συρτάρια – γραμμή 700
ZH 4抽屉冷冻台 – 700 mm



SS 201
STAINLESS STEEL

FORCED
AIR
CIRCULATION

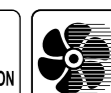

AUTOMATIC
DEFROST

x4
DRAWER

GN 1/1

R600a
REFRIGERANT

HEPA
FILTER



Cooling table with 6 drawers – line 700

DE Kühlisch mit 6 Schubladen – Linie 700
RU Холодильный стол с 6 выдвижными ящиками – линия 700
UK Холодильний стіл з 6 ящиками – лінія 700
LT Šaldomas darbatalis su 6 stalčiais – linija 700
LV Aukstuma galds ar 6 atvilktņēm – sērija 700
CS Chladicí stůl se 6 šuplíky – řada 700
SK Chladený stôl s 6 zásuvkami – linka 700
HU Hűtőasztal 6 fiókkal – 700-as sorozat
RO Masă rece cu 6 sertare – linia 700
ES Mesas frigoríficas con 6 cajones – serie 700

FR Tables de réfrigération avec 6 tiroirs – série 700
PT Mesa de refrigeração com 6 gavetas – linha 700
IT Tavoli refrigerati con 6 cassetti – linea 700
BG Хладилна маса с 6 чекмеджета – линия 700
EL Τραπεζία ψύξης με 6 συρτάρια – γραμμή 700
ZH 6抽屉冷冻台 – 700 mm

SS 201
STAINLESS STEEL

FORCED
AIR
CIRCULATION

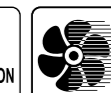

AUTOMATIC
DEFROST

x6
DRAWER

GN 1/1

R290
REFRIGERANT



YATO	(°C)	V (l)	(mm)	(W)	(kg)	(kWh/year)*
YG-05281	+2/+8	368	1365 x 700 x 880	240	104	1294

* power consumption

Cooling and freezing tables with side compressor – line 700

DE Kühl- und Gefrierische mit Seitenaggregat – Linie 700
 RU Холодильные и морозильные столы с боковым агрегатом – линия 700
 UK Холодильні столи та морозильні камери з бічним агрегатом – лінія 700
 LT Šaldomi darbastaliai su šoniniu agregatu – linija 700
 LV Aukstuma galdi ar sānu agregātu – sērija 700
 CS Chladicí a mrazicí stoly s bočným agregátem – řada 700
 SK Chladené a mraziace stoly s bočným agregátom – linka 700
 HU Hűtő- és fagyasztóasztalok oldalsó aggregátummal – 700-as sorozat
 RO Mese reci și de congelare cu compresor lateral – linia 700
 ES Mesas frigoríficas y de congelación con aislamiento lateral – serie 700
 FR Tables de réfrigération et congélateurs avec isolation latérale – série 700
 PT Mesas de refrigeração e congelamento com agregado lateral – linha 700
 IT Tavoli refrigerati e congelatori con aggregato laterale – linea 700
 BG Хладилни маси и фризер маси със страничен агрегат – линия 700
 EL Τραπεζι ψύξης και καταψύξεις με πλευρικό συσσωμάτωμα – γραμμή 700
 ZH 自带侧压缩机制冷冷冻台 – 700 mm



Cooling and freezing 2-door tables with side compressor – line 700

• 2 coated shelves

YATO	(°C)	V (l)	(mm)	(W)	(kg)	(kWh/year)*
YG-05250	-2/+8	282	1360 x 700 x 950	215	102	919
YG-05251	-18/-22	282	1360 x 700 x 950	520	110	2592



Cooling and freezing 3-door tables with side compressor – line 700

• 3 coated shelves

YATO	(°C)	V (l)	(mm)	(W)	(kg)	(kWh/year)*
YG-05255	-2/+8	417	1795 x 700 x 950	230	134	1145
YG-05256	-18/-22	417	1795 x 700 x 950	560	159	3103

* power consumption



SEE ALSO
shelves and guides
p. 84

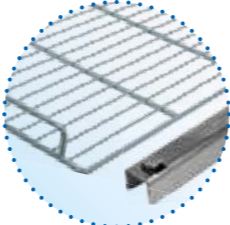

- SS 201 STAINLESS STEEL
- FORCED AIR CIRCULATION
- AUTOMATIC DEFROST
- GN 1/1
- max 40kg SHELF
- SELF CLOSING DOOR
- X4 120-180mm ADJUSTABLE FEET
- R290 REFRIGERANT
- HEPA FILTER



3-door refrigerated base – line 700

DE Unterbaukühlisch 3-türig – Linie 700
 RU Холодильный стол 3-дверный – линия 700
 UK Основа охолодження 3-дверна – лінія 700
 LT Šaldomas pagrindas su 3 durimis – linija 700
 LV Aukstuma galds ar 3 durvīm – sērija 700
 CS Chladicí 3-dveřová základna – řada 700
 SK Chladený základ 3-dverový – linka 700
 HU 3 ajtó hűtőasztal – 700-as sorozat
 RO Masă frigorifică cu 3 uși – linia 700
 ES Mesas frigoríficas con tablero de trabajo – serie 700
 FR Tables de réfrigération avec le plan de travail et à trois portes – série 700
 PT Base de resfriamento de 3 portas – linha 700
 IT Base frigorifera a 3 ante – linea 700
 BG Хладилна основа с 3 врати – линия 700
 EL 3-θύρη βάση ψύξης – γραμμή 700
 ZH 三门冷藏柜 – 700 mm



- SS 201 STAINLESS STEEL
- FORCED AIR CIRCULATION
- AUTOMATIC DEFROST
- max 40kg SHELF
- SELF CLOSING DOOR
- X4 140-200mm ADJUSTABLE FEET
- R290 REFRIGERANT



YATO	(°C)	V (l)	(mm)	(W)	(kg)	(kWh/year)*
YG-05259	-2/+8	317	1795 x 700 x 650	230	107	1132

Freezing cabinet for ice cream cuvettes

DE Gefrierschrank für Eisküvetten
 RU Морозильный шкаф для кювет с мороженым
 UK Морозильна камера для ящиків з морозивом
 LT Šaldymo spintos ledų indams
 LV Aukstumaskapis saldējuma kastēm
 CS Mrazicí box na nádoby na led
 SK Mraziaca skriňa pre nádoby na ľad
 HU Fagylaltfagyasztó szekrény
 RO Dulap de congelare pentru cuve de înghețată
 ES Armarios frigoríficos para la heladería
 FR Armoires de stockage pour bacs à crème glacée
 PT Armário de congelamento para bandejas de sorvete
 IT Congelatore per vaschette per gelati
 BG Фризер шкаф за сладолед
 EL Θάλαμος κατάψυξης για δοχεία πάγου
 ZH 冰淇淋冷藏柜



- SS 201 STAINLESS STEEL
- FORCED AIR CIRCULATION
- AUTOMATIC DEFROST
- max 40kg SHELF
- SELF CLOSING DOOR
- LOCK
- LED LIGHT
- X4 140-200mm ADJUSTABLE FEET
- R290 REFRIGERANT



YATO	(°C)	V (l)	(mm)	(W)	(kg)	(kWh/rok)*
YG-05230	-18/-22	737	740 x 990 x 2010	520	183	3061

* power consumption

Glass cooling cabinet

DE Kühlschrank mit Glastür
RU Холодильный шкаф со стеклянными дверцами
UK Холодильна шафа зі склом
LT Šaldymo spintos su stiklu
LV Aukstuma skapis ar stikla durvīm
CS Prosklený chladicí box
SK Chladená skriňa zasklená
HU Üvegezett hűtőszekrény
RO Dulap de răcire cu ușă din sticlă
ES Armario frigorífico acristalado
FR Armoire réfrigérée avec des portes en verre
PT Armário de vidro de refrigeração
IT Armadio refrigerato vetrato
BG Хладилен шкаф, остъклен
EL Θάλαμος κατάψυξης με τζάμι
ZH 玻璃冷藏柜



SS 201 STAINLESS STEEL	FORCED AIR CIRCULATION	AUTOMATIC DEFROST
GN 2/1	max 40kg SHELF	SELF CLOSING DOOR
LOCK	DOUBLE GLASS	x4 140-200mm ADJUSTABLE FEET
LED LIGHT	R290 REFRIGERANT	

YATO	(°C)	V (l)	(mm)	(W)	(kg)
YG-05225	+2/+8	650	740 x 830 x 2010	215	132

Glass cooling tables – line 700

DE Kühlische mit Glastüren – Linie 700
RU Холодильные столы со стеклянными дверцами – линия 700
UK Холодильні столи зі склом – лінія 700
LT Šaldomi darbastaliai su stiklinimu – linija 700
LV Aukstuma galdi ar stikla durvīm – sērija 700
CS Prosklené chladicí stoly – řada 700
SK Chladené stoly zasklené – linka 700
HU Üvegezett hűtőasztalok – 700-as sorozat
RO Mesă rece cu uși din sticlă – linia 700
ES Mesas de refrigeración con puertas de cristal – serie 700
FR Tables de réfrigération avec portes en verre – série 700
PT Mesas de vidro de refrigeração – linha 700
IT Armadio refrigerato vetrato – linea 700
BG Хладилни маси, остъклени – линия 700
EL Τραπέζι ψύξης με τζάμι – γραμμή 700
ZH 玻璃冷藏柜 – 700 mm

SS 201 STAINLESS STEEL	FORCED AIR CIRCULATION	AUTOMATIC DEFROST	max 40kg SHELF
SELF CLOSING DOOR	LED LIGHT	DOUBLE GLASS	x4 140-200mm ADJUSTABLE FEET
		R290 REFRIGERANT	

YG-05252 Glass cooling 2-door table – line 700

- 2 coated shelves
- tabletop dimensions: 1360 x 700 mm



YATO	(°C)	V (l)	(mm)	(W)	(kg)
YG-05252	+2/+8	282	1360 x 700 x 850	215	108
YG-05257	+2/+8	417	1795 x 700 x 850	230	134

YG-05257 Glass cooling 3-door table – line 700

- 3 coated shelves
- tabletop dimensions: 1795 x 700 mm



A B * power consumption

Cooling and freezing cabinets for bakery

DE Kühl- und Gefrierschränke für Backwaren
RU Холодильные и морозильные шкафы для пекарен
UK Холодильні та морозильні шафи для хлібобулочних виробів
LT Kepimo vėsimo ir šaldymo spintos
LV Maiznieku aukstuma skapji
CS Pekařské chladicí a mrazicí boxy
SK Pekárske, chladené a mraziace skrine
HU Hűtő- és fagyasztószekrény pékségek számára
RO Dulapuri de răcire și congelare pentru panificație
ES Armarios refrigerados pastelería y panadería
FR Armoires réfrigérées pour pâtisserie et boulangerie
PT Armários de refrigeração e congelamento para padarias
IT Armadi da forno refrigerati
BG Хладилни шкафове и фризерни за хлебни изделия
EL Θάλαμοι αρτοποιίας ψύξης και κατάψυξης
ZH 烘焙冷藏柜

YG-05226 Cooling cabinet



YG-05227 Freezing cabinet

YATO	(°C)	V (l)	(mm)	(W)	(kg)	(kWh/year)*
YG-05226	-2/+8	737	740 x 990 x 2010	295	134	1000
YG-05227	-18/-22	737	740 x 990 x 2010	520	183	3061

2-door cooling table for bakery

DE Backwarenkühltisch 2-türig
RU Пекарский 2-дверный холодильный стол
UK Холодильний стіл для хлібобулочних виробів 2-дверний
LT Kepimo šaldomas darbastalis
LV Maiznieku aukstuma galds ar 2 durvīm
CS Chladicí pekařské 2-dvéřové stoly
SK Chladený pekársky stôl 2-dverový
HU 2 ajtós hűtőasztal pékségek számára
RO Masă rece cu 2 uși pentru brutărie
ES Mesas de refrigeración de dos puertas para pastelería y panadería
FR Tables de réfrigération à deux portes pour pâtisserie et boulangerie
PT Mesa de refrigeração para padarias 2 portas
IT Tavolo refrigerato da forno con 2 ante
BG Хладилна маса за хлебни изделия с 2 врати
EL Τραπέζι ψύξης αρτοποιίας 2-θυρών
ZH 烘焙两门冷藏台



SS 201 STAINLESS STEEL	FORCED AIR CIRCULATION	AUTOMATIC DEFROST
max 40kg SHELF	SELF CLOSING DOOR	x4 140-200mm ADJUSTABLE FEET
		R290 REFRIGERANT

YATO	(°C)	V (l)	(mm)	(W)	(kg)	(kWh/year)*
YG-05254	-2/+8	390	1510 x 800 x 845	215	110	1026

* power consumption

Salad cooling tables

- | | |
|----------------------------------|--|
| DE Salatetten | ES Mesas de refrigeración para ensaladas |
| RU Холодильные столы для салата | FR Tables réfrigérées préparation de salades |
| UK Холодильні столи для салатів | PT Mesas de refrigeração de salada |
| LT Šaldomi darbastaliai salatoms | IT Tavolo refrigerato per insalate |
| LV Aukstuma galsi salātiem | BG Хладилни маси за салати |
| CS Chladicí salátové stoly | EL Τραπέζια ψύξης σαλατών |
| SK Chladené stoly pre šalát | ZH 色拉冷藏台 |
| HU Saláta hűtőasztalok | |
| RO Masă rece pentru salate | |



Cooling 2-door table with a glass extension

- 2 coated shelves
- top hole for containers GN (4 x GN 1/2 and 3 x GN 1/6)
- tempered glass extension



YATO	(°C)	V (l)	(mm)	(W)	(kg)
YG-05260	+2/+8	240	900 x 700 x 850	170	76

Cooling 2-door table with a cover

- 2 coated shelves
- top hole for containers GN (4 x GN 1/2 and 3 x GN 1/6)
- swing top cover



YATO	(°C)	V (l)	(mm)	(W)	(kg)
YG-05262	+2/+8	240	900 x 700 x 876	170	70

Cooling 3-door table with a cover

- 3 coated shelves
- top hole for containers GN (4 x GN 1/1)
- swing top cover



YATO	(°C)	V (l)	(mm)	(W)	(kg)
YG-05290	+2/+8	368	1365 x 700 x 876	240	115

SEE ALSO
GN containers



Pizza cooling tables

- | | |
|--------------------------------|---------------------------------------|
| DE Pizzakühlische | RO Masă rece pentru pizza |
| RU Холодильные столы для пиццы | ES Mesas de refrigeración para pizzas |
| UK Холодильні столи для піци | FR Tables réfrigérées pour pizza |
| LT Šaldomi darbastaliai picoms | PT Mesas de refrigeração de pizza |
| LV Aukstuma galdi picai | IT Tavolo refrigerato per pizza |
| CS Chladicí stoly na pizzu | BG Хладилни маси за пици |
| SK Cladené stoly pre pizzu | EL Τραπέζια ψύξης πίτσας |
| HU Pizza hűtőasztalok | ZH 披萨冷藏台 |

- | | |
|---------------------------------------|---------------------------------------|
| RO Masă rece pentru pizza | ES Mesas de refrigeración para pizzas |
| ES Mesas de refrigeración para pizzas | FR Tables réfrigérées pour pizza |
| FR Tables réfrigérées pour pizza | PT Mesas de refrigeração de pizza |
| PT Mesas de refrigeração de pizza | IT Tavolo refrigerato per pizza |
| IT Tavolo refrigerato per pizza | BG Хладилни маси за пици |
| BG Хладилни маси за пици | EL Τραπέζια ψύξης πίτσας |
| EL Τραπέζια ψύξης πίτσας | ZH 披萨冷藏台 |
| ZH 披萨冷藏台 | |

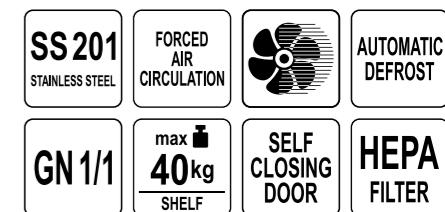

Cooling 2-door table with extension and granite top

- lower compressor – Zanussi
- cooling agent: R600a
- marble work top
- 2 coated shelves with dimensions of 325 x 560 mm
- top hole for GN containers (5 x GN 1/6)



YATO	(°C)	V (l)	(mm)	(W)	(kg)
YG-05275	+2/+8	240	900 x 700 x 1075	170	105

Pizza cooling 3-door table with extension and granite top

- compressors – Embraco (table) and Zanussi (extension)
- cooling agent: R290 (table), R600a (extension)
- granite work top
- 3 coated shelves with dimensions of 325 x 560 mm
- extension for GN containers (6 x GN 1/4)



YATO	(°C)	V (l)	(mm)	(W)	(kg)
YG-05305	+2/+8	368	1400 x 700 x 1020 + 1400 x 335 x 435	240 + 110	170 + 27



Pizza cooling 2-door table with 7 drawers and granite top

- side compressor – Embraco
- cooling agent: R290
- granite work top
- 2 coated shelves with dimensions of 408 x 630 mm
- 7 shelves without cooling
- 6 steering wheels, including 3 wheels with brakes



YATO	(°C)	V (l)	(mm)	(W)	(kg)
YG-05310	-2/+8	580	2025 x 800 x 1000	215	332



Accessories for cooling cabinets and tables

DE Zubehör für Kühlschränke und -Tische
RU Аксессуары для холодильных шкафов и столов
UK Аксесуари для шаф і холодильних столів
LT Šaldomų spintų ir darbastalių priedai
LV Aukstuma skapju un galdu piederumi
CS Přislúšenství pro chladicí boxy a stoly
SK Wybavenie pre chladené skrine a stoly
HU Kiegészítők hűtőszekrényekhez és hűtőasztalokhoz

RO Accesorii pentru dulapuri frigorifice și mese reci
ES Accesorios para armarios y mesas de refrigeración
FR Accessoires pour armoires et tables de réfrigération
PT Acessórios para armários e mesas de refrigeração
IT Accessori per armadi e tavoli refrigerati
BG Аксесоари за хладилни маси и шкафове
EL Αξεσουάρ για θαλάμους και τραπέζια ψύξης
ZH 冷藏柜/冷藏台配件

Coated shelves



YATO	(mm)	FOR:
YG-05400	534 x 650	YG-05200, YG-05201, YG-05210, YG-05211, YG-05225

YATO	(mm)	FOR:
YG-05403	534 x 650	YG-05215, YG-05216, YG-05220, YG-05221



YATO	(mm)	FOR:
YG-05406	333 x 530	YG-05250, YG-05251, YG-05252, YG-05255, YG-05256, YG-05257, YG-05259, YG-05270, YG-05300
YG-05409	325 x 560	YG-05260, YG-05262, YG-05275, YG-05290, YG-05305
YG-05412	408 x 630	YG-05310, YG-05254
YG-05420	333 x 430	YG-05253, YG-05258

Shelf guides



YATO	L/R*	FOR:
YG-05401	L	YG-05200, YG-05201, YG-05210, YG-05211, YG-05225
YG-05402	R	YG-05200, YG-05201, YG-05210, YG-05211, YG-05225
YG-05404	L	YG-05215, YG-05216, YG-05220, YG-05221
YG-05405	R	YG-05215, YG-05216, YG-05220, YG-05221
YG-05407	L	YG-05250, YG-05251, YG-05252, YG-05255, YG-05256, YG-05257, YG-05259, YG-05270, YG-05300
YG-05408	R	YG-05250, YG-05251, YG-05252, YG-05255, YG-05256, YG-05257, YG-05259, YG-05270, YG-05300
YG-05410	L	YG-05260, YG-05262, YG-05275, YG-05290, YG-05305
YG-05411	R	YG-05260, YG-05262, YG-05275, YG-05290, YG-05305
YG-05413	L	YG-05310, YG-05254
YG-05414	R	YG-05310, YG-05254
YG-05421	L	YG-05253, YG-05258
YG-05422	R	YG-05253, YG-05258



YATO	L/R*	FOR:
YG-05423	L	YG-05226
YG-05424	R	YG-05226
YG-05425	L	YG-05227
YG-05426	R	YG-05227



* L - left, R - right
84

Cooling extensions

DE Kühlaufsätze
RU Холодильные витрины
UK Холодильні надставки
LT Aušinimo pratęsimai
LV Aukstuma uzliktrpi
CS Chladicí nástavky
SK Chladiaci nadstavce
HU Hűtő feltétek
RO Extensii pentru mese reci
ES Vitrinas expositoras de comida fría
FR Vitrites réfrigérées pour aliments
PT Extensões de refrigeração
IT Unità di refrigerazione
BG Хладилно надграждане
EL Ψυγείο μπουφέ
ZH 其他冷藏设备



YATO	(°C)	(mm)	(W)	(kg)	
YG-05320	+2/+8	5 x GN 1/4	1200 x 335 x 435	110	25
YG-05321	+2/+8	6 x GN 1/4	1400 x 335 x 435	110	27
YG-05322	+2/+8	7 x GN 1/4	1500 x 335 x 435	110	29
YG-05323	+2/+8	8 x GN 1/4	1800 x 335 x 435	110	32
YG-05330	+2/+8	6 x GN 1/3	1400 x 395 x 435	110	30
YG-05331	+2/+8	7 x GN 1/3	1600 x 395 x 435	110	32
YG-05332	+2/+8	9 x GN 1/3	2000 x 395 x 435	110	36

SS 201 STAINLESS STEEL
AUTOMATIC DEFROST
DIGITAL TEMPERATURE CONTROLLER
HARDENED GLASS
R600a REFRIGERANT
HEPA FILTER



SEE ALSO
GN containers



p. 7

Refrigerated display cases for sushi

DE Sushi und Tapas Belegstation
RU Холодильные витрины для суши
UK Холодильні вітрини для суши
LT Sušių šaldymo vitrina
LV Aukstuma vitrinās suši
CS Chladicí pulty na sushi
SK Chladené výklady pre sushi
HU Sushi hűtővitrin
RO Vitrină frigorifică pentru sushi
ES Vitrinas expositoras de sushi
FR Vitrites réfrigérées pour sushi
PT Vitrinas de refrigeração de sushi
IT Vetrine refrigerate per sushi
BG Хладилни витрини за суши
EL Βιτρίνα ψύξης σουσί
ZH 壽司冷藏展示柜



AUTOMATIC DEFROST
DIGITAL TEMPERATURE CONTROLLER
LED LIGHT
R600a REFRIGERANT



YG-05002
YG-05005
YG-05001

- panoramic, rounded front glass

YATO	(°C)	(mm)	(W)	(kg)	
YG-05000	0/+6	4 x GN 1/3	1177 x 420 x 295	125	34.5
YG-05001	0/+6	5 x GN 1/3	1350 x 420 x 295	135	38.5
YG-05002	0/+6	6 x GN 1/3	1530 x 420 x 295	145	41.5
YG-05005	0/+6	5 x GN 1/2	1800 x 420 x 295	160	45

YG-05007

- glass shelf

YATO	(°C)	(mm)	(W)	(kg)	
YG-05007	0/+6	5 x GN 1/2	1755 x 395 x 375	180	53



Refrigerated display cases for bottles

DE Kühlvitrinen für Flaschen
RU Холодильные витрины для бутылок
UK Холодильні вітрини для пляшок
LT Butelių šaldymo vitrina
LV Aukstuma vitrinas pudelēm
CS Chladicí pulty na láhve
SK Chladené výklady pre fľaše
HU Üveg hűtővitrin
RO Dulap frigorific pentru băuturi
ES Vitrinas refrigeradas para botellas
FR Vitrines réfrigérées pour bouteilles
PT Vitrinas de refrigeração para garrafas
IT Vetrine refrigerate per bottiglie
BG Хладилни витрини за бутилки
EL Βιτρίνες ψύξης μπουκαλιών
ZH 冷藏展示柜



1-door case

• 2 chrome plated shelves
with dimensions of 515 x 350 mm



YATO	(°C)	V (l)	(mm)	(W)	(kg)
YG-05350	+2/+8	142	600 x 515 x 905	180	83

2-door case

• 4 chrome plated shelves
with dimensions of 835 x 350 mm



YATO	(°C)	V (l)	(mm)	(W)	(kg)
YG-05355	+2/+8	227	920 x 515 x 905	200	102

2-door case (sliding doors)

• 4 chrome plated shelves
with dimensions of 835 x 350 mm



YATO	(°C)	V (l)	(mm)	(W)	(kg)
YG-05356	+2/+8	227	920 x 515 x 905	200	102

3-door case

• 6 chrome plated shelves:
middle with dimensions
445 x 350 mm
and side 400 x 350 mm



YATO	(°C)	V (l)	(mm)	(W)	(kg)
YG-05360	+2/+8	341	1350 x 515 x 910	225	130

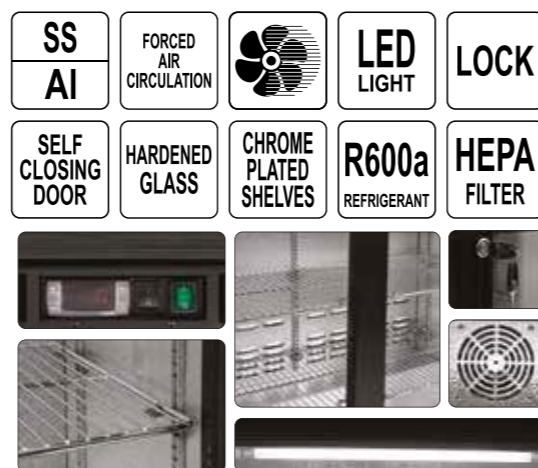

Accessories for refrigerated display cases for bottles

DE Zubehör für Kühlvitrinen für Flaschen
RU Аксессуары для холодильных витрин для бутылок
UK Аксесуари для холодильних установок для пляшок
LT Butelių šaldymo vitrinų priedai
LV Aukstuma vitrinu pudelēm piederumi
CS Příslušenství k chladicím pultům na láhve
SK Výbavenie pre chladené výklady pre fľaše
HU Kiegészítők üveg hűtővitrinekhez

Chrome plated shelves



YATO	(mm)	FOR:
YG-05415	515 x 350	YG-05350



YATO	(mm)	FOR:
YG-05416	835 x 350	YG-05355, YG-05356



• middle shelf

YATO	(mm)	FOR:
YG-05417	445 x 350	YG-05360

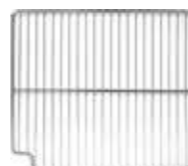

• left/right shelf

YATO	(mm)	FOR:
YG-05418	400 x 350	YG-05360

K-type shelf holder

YATO	(mm)	FOR:
YG-05419	400 x 350	YG-05350, YG-05355, YG-05356, YG-05360



Chest freezer

DE Gefriertruhe
RU Морозильный ларь с глухой крышкой
UK Морозильна скриня
CS Truhlicový mrazák
SK Truhlicová mraznička
HU Fagyasztóláda
RO Congelator ladă
ES Arcón congelador
FR Congélateur coffre
PT Congelador de caixa
IT Congelatore a pozzetto
BG Фризер ракла
EL Καταψύκτης οριζόντιου τύπου
ZH 冷柜

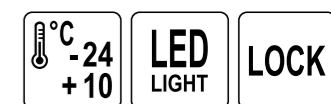

A+ C YG-05171 **A+ D** YG-05174, YG-05177, YG-05179, YG-05180

YATO	(°C)	V (l)	(mm)	(W)	(kg)	(kWh/rok)*
YG-05171	-24/+10	190	950 x 564 x 845	140	35	475
YG-05174	-24/+10	282	1116 x 644 x 845	240	42	836
YG-05177	-24/+10	345	1275 x 740 x 825	190	54	945
YG-05179	-24/+10	435	1535 x 740 x 825	250	58	1077
YG-05180	-24/+10	488	1655 x 740 x 850	275	62	1132

Refrigerated display cases

- DE Kühlvitriren
- RU Холодильные витрины
- UK Холодильні вітрини
- LT Šaldymo vitrinos
- LV Aukstuma vitrinas
- CS Chladicí pulty
- SK Chladené výklady
- HU Hűtővitrinek
- RO Vitrine frigorifice
- ES Vitrinas refrigeradas
- FR Vitrines réfrigérées
- PT Vitrinas de refrigeração
- IT Vetrine refrigerate
- BG Хладилни витрини
- EL Βιτρίνες ψύξης
- ZH 冷藏展示柜



- AUTOMATIC DEFROST
- DIGITAL TEMPERATURE CONTROLLER
- LED LIGHT
- R600a REFRIGERANT
- ADJUSTABLE SHELVES



YATO	(°C)	V (l)	(mm)	(W)	COLOUR	(kg)
YG-05020	0/+12	100	682 x 450 x 675	160	●	39.1
YG-05021	0/+12	100	682 x 450 x 675	160	○	39.1
YG-05022	0/+12	100	682 x 450 x 675	160	○	39.1



YATO	(°C)	V (l)	(mm)	(W)	(kg)
YG-05025	0/+12	120	688 x 568 x 686	160	64



Refrigerated display cases

- DE Kühlvitriren
- RO Vitrine frigorifice
- RU Холодильные витрины
- ES Vitrinas refrigeradas
- UK Холодильні вітрини
- FR Vitrines réfrigérées
- LT Šaldymo vitrinos
- PT Vitrinas de refrigeração
- LV Aukstuma vitrinas
- IT Vetrine refrigerate
- CS Chladicí pulty
- BG Хладилни витрини
- SK Chladené výklady
- EL Βιτρίνες ψύξης
- ZH 冷藏展示柜

- AUTOMATIC DEFROST
- DIGITAL TEMPERATURE CONTROLLER
- LED LIGHT
- ADJUSTABLE SHELVES

- 4 SIDE DOUBLE GLASS
- R290 REFRIGERANT
- 360°
4x



YATO	(°C)	V (l)	(mm)	(W)	(kg)
YG-05040	+2/+8	300	650 x 805 x 1445	450	135
YG-05045	+2/+8	400	900 x 805 x 1445	450	160



Refrigerated display cases

- DE Kühlvitriren
- RU Холодильные витрины
- UK Холодильні вітрини
- LT Šaldymo vitrinos
- LV Aukstuma vitrinas
- CS Chladicí pulty
- SK Chladené výklady
- HU Hűtővitrinek
- RO Vitrine frigorifice
- ES Vitrinas refrigeradas
- FR Vitrines réfrigérées
- PT Vitrinas de refrigeração
- IT Vetrine refrigerate
- BG Хладилни витрини
- EL Βιτρίνες ψύξης
- ZH 冷藏展示柜



A G C

YATO	(°C)	V (l)	(mm)	(W)	COLOUR	(kg)
YG-05055	0/+6	78	428 x 386 x 960	164	○	33.8
YG-05056	0/+6	78	428 x 386 x 960	164	●	33.8
YG-05057	0/+6	78	428 x 386 x 960	164	○	33.8

Refrigerated display case

- DE Kühlvitrine
- RU Холодильная витрина
- UK Холодильна вітрина
- LT Šaldymo vitrina
- LV Aukstuma vitrina
- CS Chladicí pult
- SK Chladený výklad
- HU Hűtővitrin
- RO Vitrine frigorifice
- ES Vitrina refrigerada
- FR Vitrine réfrigérée
- PT Vitrina de refrigeração
- IT Vetrina refrigerata
- BG Хладилна витрина
- EL Βιτρίνα ψύξης
- ZH 冷藏展示柜



A G C

YATO	(°C)	V (l)	(mm)	(W)	(kg)
YG-05060	0/+6	78	430 x 390 x 986	180	42

Refrigerated display cases

- DE Kühlvitriren
- RU Холодильные витрины
- UK Холодильні вітрини
- LT Šaldymo vitrinos
- LV Aukstuma vitrinas
- CS Chladicí pulty
- SK Chladené výklady
- HU Hűtővitrinek
- RO Vitrine frigorifice
- ES Vitrinas refrigeradas
- FR Vitrines réfrigérées
- PT Vitrinas de refrigeração
- IT Vetrine refrigerate
- BG Хладилни витрини
- EL Βιτρίνες ψύξης
- ZH 冷藏展示柜



A G C

YATO	(°C)	V (l)	(mm)	(W)	(kg)
YG-05064	0/+6	270	650 x 650 x 1500	636	140
YG-05068	0/+6	400	650 x 650 x 1908	636	175

Refrigerated display case

- DE Kühlvitrine
- RU Холодильная витрина
- UK Холодильна вітрина
- LT Šaldymo vitrina
- LV Aukstuma vitrina
- CS Chladicí pult
- SK Chladený výklad
- HU Hűtővitrin
- RO Vitrine frigorifice
- ES Vitrina refrigerada
- FR Vitrine réfrigérée
- PT Vitrina de refrigeração
- IT Vetrina refrigerata
- BG Хладилна витрина
- EL Βιτρίνα ψύξης
- ZH 冷藏展示柜



A G C

YATO	(°C)	V (l)	(mm)	(W)	(kg)
YG-05090	+2/+12	73	504 x 504 x 1060	170	45

Refrigerated display cases

- DE Kühlvitrinen
- RU Холодильные витрины
- UK Холодильні вітрини
- LT Šaldymo vitrinos
- LV Aukstuma vitrinas
- CS Chladicí pulty
- SK Chladené výklady
- HU Hűtővitrinek
- RO Vitrine frigorifice
- ES Vitrinas refrigeradas
- FR Vitrines réfrigérées
- PT Vitrinas de refrigeração
- IT Vitrine refrigerate
- BG Хладилни витрини
- EL Βιτρίνες ψύξης
- ZH 冷藏展示柜



- cooling agent: R600a
- 3 adjustable glass shelves with diameter of 390 mm

R600a
REFRIGERANT

YATO	(°C)	V (l)	(mm)	(W)	(kg)
YG-05094	+2/+8	100	480 x 480 x 1030	170	50

Sink with knee switch

- DE Knie-Kontakt-Handwaschbecken
- RU Рукомойник с коленным приводом
- UK Колінна раковина
- LT Bekontaktė virtuvinė plautuvė
- LV Celgalu izlietne
- CS Kolenní umyvadlo
- SK Kolenné umývadlo
- HU Kézmosó
- RO Chiuvetă cu acționare la genunchi
- ES Lavamanos rodilla
- FR Lavabo à commande au genou
- PT Pia com acionamento por joelho
- IT Lavabo con comando a ginocchio
- BG Безконтактна мивка с бутон за коляно
- EL Υγειονομικός νιπτήρας με πλάτη
- ZH 不锈钢洗涤槽



YATO	(mm)
YG-10010	400 x 330 x 570



R290

- cooling agent: R290
- 4 adjustable glass shelves with diameter of 540 mm

YATO	(°C)	V (l)	(mm)	(W)	(kg)
YG-05098	+2/+8	400	680 x 680 x 1750	450	127



R290
360°
4x

SS 304/201
STAINLESS STEEL
40mm
DRAIN HOLE

TEMPERATURE REGULATION
WATER STOP VALVE



EN
I. TOYA S.A. informs that: 1) the present catalogue does not constitute an offer as construed in the civil law; 2) the goods presented in the present catalogue may in fact differ from the models shown in the pictures, particularly as far as external properties are concerned, namely size, colour, packaging; 3) the company will not be held responsible for small differences in properties of the goods, which do not affect the purpose or the exploitation of the tools; 4) the company will not be held responsible for any inaccuracies or imprecision regarding the information presented in the catalogue; 5) the company will not be held responsible for any damage caused by goods whose properties differ from those of the tools presented in the photographs.
II. In spite of all the efforts made by TOYA S.A., the company cannot guarantee the information contained in the present catalogue fully correspond to the reality.
III. Any decisions made on the basis of the information contained in the present catalogue will be made at the risk of the person who makes them using the aforementioned information.

DE
I. TOYA S.A. informiert, dass: 1) der vorliegende Katalog kein Angebot im zivilrechtlichen Sinne darstellt; 2) die im vorliegenden Katalog präsentierten Artikel in der Realität von den auf den Musterfotos gezeigten abweichen können, und zwar besonders dann, wenn es um äußere Eigenschaften geht, wie z.B. Größe, Farbe, Art der Verpackung, Anzahl der Gegenstände in der Verpackung; 3) sie keine Verantwortung für geringfügige Unterschiede bei der Verpackungsart oder den Eigenschaften der Artikel übernimmt, die ohne Auswirkungen auf seinen Bestimmungszweck oder die Art der Nutzung bleiben; 4) sie keine Verantwortung für irgendwelche Oberflächlichkeiten und Ungenauigkeiten bzgl. der im Sachkatalogkatalog enthaltenen Informationen übernimmt; 5) sie keine Verantwortung für eventuelle Schäden, die im Ergebnis des Erhalts der Ware mit anderen als auf den Fotos dargestellten Eigenschaften entstanden sind, übernimmt.
II. Trotz großer Bemühungen seitens TOYA S.A. kann die Firma nicht garantieren, dass die im vorliegenden Katalog enthaltenen Informationen voll der Realität entsprechen.
III. Sämtliche Entscheidungen, die auf der Grundlage der im Sachkatalog enthaltenen Informationen getroffen wurden, gehen auf das Risiko der Person, die diese Informationen benutzt.

RU
I. TOYA S.A. заявляет: 1) настоящий каталог не является торговым предложением с точки зрения гражданского законодательства; 2) изделия, представленные в настоящем каталоге, могут отличаться от образцов на снимках, особенно внешним видом, то есть размером, цветом, способом упаковки, количеством предметов в упаковке; 3) производитель не отвечает за мелкие отличия в способе упаковки или свойствах изделий, которые не влияют на предназначение или способ пользования изделиями; 4) производитель не отвечает за мелкие неточности в сведениях из предметного каталога; 5) производитель не отвечает за ущерб, нанесенный вследствие поставки товара, отличающегося параметрами от указанного на снимках.
II. Несмотря на все усилия в данном направлении, компания TOYA S.A. не гарантирует, что информация, метящаяся в настоящем каталоге, полностью отвечает действительности.
III. Риск, связанный с любыми решениями, принятыми на основании информации из предметного каталога, берут на себя лица, пользующиеся указанной информацией.

UK
I. TOYA S.A. informuje, що: 1) цей каталог не є пропозицією за змістом цивільного права; 2) представлені в цьому каталозі товари фактично можуть відрізнятися від вказаного на фотографіях малюнка, зокрема, зовнішні характеристики, тобто його розмір, колір, спосіб упаковки; 3) не несе відповідальності за незначні відмінності у властивостях виробів, які не впливають на їхнє призначення чи спосіб використання; 4) не несе відповідальності, що виникає за будь-яких неточностей, щодо інформації в цьому каталозі; 5) не несе відповідальності за можливу шкоду, що виникає в результаті отримання товару з іншими властивостями, ніж представлений на фотографіях.
II. Незважаючи на зусилля, TOYA S.A. не може гарантувати, що інформація, яка міститься в даному каталозі, повністю відповідає дійсності.
III. Всі рішення, прийняті на підставі інформації, поданої в цьому каталозі, приймаються на ризик людини, який використовує цю інформацію.

LT
I. TOYA S.A. informuoja, kad: 1) šis katalogas nėra pasiūlymas civilinės teisės prasme; 2) šiam kataloge pateikiami gaminiai iš tikrųjų gali skirtis nuo paveikslėliuose nurodyto modelio, ypač išorinėmis ypatybėmis, t.y. dydžiu, spalva, pakavimo būdu; 3) neatsako už nedidelius gaminių savybių skirtumus, kurie nedaro įtakos jų numatytai paskirtčiai ar naudojimui; 4) neatsako už šiam kataloge pateiktos informacijos netikslumus; 5) neatsako už jokią žalą atsiradusią dėl to, kad gauta prekė turinti kitokias savybes nei nurodytos nuotraukose.
II. Nepaisant didžiuliu, TOYA S.A. pastangų, negali ji garantuoti, kad šiam kataloge esanti informacija visiškai atitinka tikrovę.
III. Visi priimti remiantis šiam kataloge esančia informacija sprendimai priimami asmens, kuris naudoja šia informacija, atsakomybę.

LV
I. Uzņēmums TOYA S.A. informē, ka: 1) šis katalogs nav piedāvājums civiltikumā izpratnē; 2) šajā katalogā attēlotās preces faktiski var atšķirties no parauga, kas parādīts attēlos, jo īpaši attiecībā uz ārējām īpašībām, proti, izmēriem, krāsu, iepakojuma veidu; 3) tas neatbild par sīkām atšķirībām precu īpašībās, kas neietekmē precu paredzēto pielietojumu vai lietošanas veidu; 4) tas neatbild par jebkādam neprecizitātem vai nepilnībām attiecībā uz šajā katalogā ietvertu informāciju; 5) tas neatbild par iespējamiem zaudējumiem, kas radušies preces ar īpašībām, kas atšķiras no fotogrāfijās attēlotajām, saņemšanas rezultātā.
II. Neskatoties uz visiem uzņēmuma TOYA S.A. centieniem, tas nevar garantēt, ka šajā katalogā ietvertā informācija pilnībā atbilst realitātei.
III. Visi lēmumi, kas pieņemti, pamatojoties uz šajā katalogā ietvertu informāciju, tiek pieņemti uz personas, kas izmanto šo informāciju, pašas risku.

CS
I. TOYA S.A. informuje že: 1) tento katalog nepředstavuje nabídku ve smyslu občanského práva; 2) výrobky prezentované v tomto katalogu se mohou ve skutečnosti lišit od modelů uvedených na obrázcích, zejména co se týká vnějších znaků, tj. velikosti, barvy, způsobu balení, počtu předmětů v balení; 3) nenese odpovědnost za drobné rozdíly způsobu balení nebo ve vlastnostech výrobků, které nemají zásadní vliv na jejich určený účel nebo způsob používání; 4) nenese odpovědnost vyplývající z jakýchkoli nepřesností co do informací uvedených v předmětném katalogu; 5) nenese odpovědnost za případné škody vzniklé v důsledku obdržení zboží s jinými vlastnostmi, než je uvedeno na obrázcích.
II. Navzdory mimořádnému úsilí vynaloženému firmou TOYA S.A. tato nemůže garantovat, zda informace uvedené v tomto katalogu zcela odpovídají skutečnosti.
III. Veškerá rozhodnutí přijatá na základě informací uvedených v předmětném katalogu jsou přijímána na vlastní riziko osoby, která tyto informace využívá.

SK
I. TOYA S.A. informuje, že: 1) tento katalóg nie podľa občianskeho práva nie je ponukou; 2) výrobky zobrazené v tomto sa v skutočnosti môžu líšiť od vzorku uvedeného na snímkoch, najmä v oblasti vonkajších znakov, tj. veľkosti, farba, spôsob balenia; 3) nie je zodpovedná za drobné rozdiely vlastností výrobkov, ktoré nemajú vplyv na cieľ a spôsob použitia; 4) nie je zodpovedná zodpovedná akýchkoľvek nepresností alebo odchýlok týkajúcich sa informácií uvedených v predmetnom katalógu; 5) nie je zodpovedná za prípadné škody, ktoré vzniknú v dôsledku dodávky tovaru, ktorý bude mať iné vlastnosti, ako uvedený na snímkoch.
II. Napriek odbornej starostlivosti firmy TOYA S.A., firma nemôže zaručiť, že informácie uvedené v katalógu sú v celku zhodné so skutočným stavom.
III. Všetke rozhodnutia urobené na základe informácií uvedených v tomto katalógu sú učené na vlastné riziko osoby, ktorá tieto informácie používa.

HU
I. A TOYA S.A. tájékoztatja, hogy: 1) a jelen katalógus a polgári jog szerint nem kereskedelmi ajánlat; 2) a jelen katalógusban bemutatott árucikkek a valóságban elérhetnek a képeken látható mintáktól, különösen a külső tulajdonságok, mint a méret, szín, csomagolási mód, a csomagban lévő tárgyak száma tekintetében; 3) nem vállal felelősséget a csomagolás módjában vagy az árucikkek olyan tulajdonságaiban történt változtatásokért, amelyek nem befolyásolják lényeges módon annak rendeltetését vagy a felhasználás módját; 4) nem vállal felelősséget a jelen katalógusban lévő információk pontatlanságáért; 5) nem vállal felelősséget azokért az esetleges károkért, amik az árucikkek a fényképeken látható tulajdonságoktól eltérő tulajdonságokkal történő leszállításából erednek.
II. A TOYA S.A. minden igyekezete ellenére nem tudja garantálni, hogy a jelen katalógusban található információk teljes egészében megfelelnek a valóságnak.
III. A tárgyi katalógusban található információk alapján meghozott bármilyen döntés annak a személynek a rizikója, aki ezeket az információkat felhasználja.

RO
I. TOYA S.A. informează că: 1) prezentul catalog nu constituie ofertă în înțelesul dreptului civil; 2) articolele prezentate în prezentul catalog se pot diferi față de mostrele din fotografiile, în special aspectul exterior, adică mărimea, culoarea, modul de ambalare, cantitatea obiectelor în ambalaj; 3) nu-și asumă răspunderea referitor la mici diferențe la modul de ambalare sau la articole al căror proprietăți nu au influență referitor la destinația sau modul lor de utilizare; 4) nu-și asumă răspunderea referitor la orice inexactități sau imprecizii, datorită informațiilor cuprinse în catalogul respectiv; 5) nu-și asumă răspunderea referitor la o eventuală pagubă ca urmare a primirii marfei cu alte proprietăți decât cele prezentate pe fotografii.
II. Cu toate strădanile TOYA S.A., firma nu poate garanta că, informațiile din prezentul catalog corespund realității.
III. Orice decizie preluată în baza informațiilor cuprinse în catalogul respectiv, sunt preluate pe riscul și răspunderea persoanei care a făcut folos de aceste informații.

BG
I. TOYA S.A. информира, че: 1) настоящият каталог не представлява оферта по смисъла на гражданското право; 2) артикулите, представени в този каталог, в действителност могат да се различават от модела, посочен на снимките, по-специално по отношение на външните характеристики, т.е. размер, цвят, начин на опаковане; 3) не носи отговорност за незначителни разлики в свойствата на изделията, които не засягат предназначението или употребата им; 4) не носи отговорност за неточна информация или неточности по отношение на информацията, съдържаща се в каталога; 5) не носи отговорност за щети, причинени в резултат на получаване на стоки с други свойства, различни от тези, представени на снимките.
II. Въпреки положените най-големи усилия от фирма TOYA S.A. тя не може да гарантира, че информацията, съдържаща се в каталога, напълно отговаря на действителността.
III. Всички решения, взети въз основа на информацията в предметния каталог, са за собствена отговорност на лицето, което ползва тази информация.

FR
I. TOYA S.A. communique : 1) que ce catalogue ne constitue pas une offre au sens du droit civil; 2) que les articles présentés dans ce catalogue peuvent différer du dessin illustré sur les photographies, notamment en ce qui concerne les caractéristiques extérieures, c'est-à-dire les dimensions, la couleur, le mode de conditionnement; 3) qu'elle n'est pas responsable des légères différences dans les propriétés des articles qui n'affectent ni leur utilisation ni leur destination; 4) qu'elle n'est pas responsable des imprécisions et inexactitudes contenues dans les informations du catalogue; 5) qu'elle n'est pas responsable des éventuels dommages découlant de la réception de produits dont les caractéristiques diffèrent des caractéristiques présentées dans les photographies.
II. Malgré tous les efforts déployés par TOYA S.A., elle ne peut garantir que les informations contenues dans ce catalogue correspondent pleinement à la réalité.
III. Toutes les décisions prises sur la base des informations contenues dans ce catalogue le sont aux risques de la personne qui les utilise.

IT
I. TOYA S.p.A. informa che: 1) il presente catalogo non costituisce un'offerta ai sensi del diritto civile; 2) gli articoli presentati in questo catalogo possono infatti differire dalla figura indicata nelle fotografie, in particolare per quanto riguarda le caratteristiche esterne, ovvero dimensioni, colore e modalità di confezionamento; 3) non è responsabile per differenze minime nelle caratteristiche degli articoli che non incidono sull'uso cui sono destinati o sulla modalità di utilizzo; 4) non è responsabile per eventuali inesattezze o imprecisioni nelle informazioni contenute in questo catalogo; 5) non è responsabile per eventuali danni derivanti dal ricevimento di merci con caratteristiche diverse da quelle presentate nelle foto.
II. Nonostante i migliori sforzi compiuti da TOYA S.p.A., essa non può garantire che le informazioni contenute in questo catalogo corrispondano pienamente alla realtà.
III. Qualsiasi decisione presa sulla base delle informazioni contenute in questo catalogo è presa a rischio esclusivo della persona che utilizza tali informazioni.

ES
I. TOYA S.A. comunica lo siguiente: 1) el presente catálogo no constituye una oferta, en el sentido que los nodos adquiere en la ley civil; 2) los artículos presentados en el presente catálogo pueden en realidad diferir de los modelos indicados en las fotografías, especialmente en cuanto a sus propiedades externas, es decir el tamaño, el color, el empaque o la cantidad de los objetos en el empaque; 3) la empresa no se hace responsable por pequeñas diferencias en cuanto al empaque o las propiedades de los artículos, siempre y cuando estas diferencias no afecten el propósito o el modo de operación de las herramientas; 4) la empresa no se hace responsable por ninguna imprecisión en cuanto a la información presentada en el presente catálogo; 5) la empresa no se hace responsable por ningún daño que surja del hecho de que los artículos recibidos difieran de los artículos presentados en las fotografías en cuanto a sus propiedades.
II. A pesar de los mejores intentos de parte TOYA S.A. la empresa no puede garantizar que la información presentada en el presente catálogo corresponda completamente a la realidad.
III. Todas las decisiones tomadas en base a la información presentada en el presente son responsabilidad de la persona que recurra a la dicha información.

EL
I. Η TOYA S.A. ενημερώνει ότι: 1) ο κατάλογος αυτός δεν αποτελεί προσφορά κατά την έννοια του αστικού δικαίου 2) τα αντικείμενα που παρουσιάζονται σε αυτόν τον κατάλογο μπορεί στην πραγματικότητα να διαφέρουν από το σχήμα που υποδεικνύεται στις εικόνες, ιδιαίτερα όσον αφορά τα εξωτερικά χαρακτηριστικά, δηλαδή το μέγεθος, το χρώμα, τη μέθοδο συσκευασίας 3) δεν ευθύνεται για μικρές διαφορές στα χαρακτηριστικά των αντικειμένων που δεν επηρεάζουν τον προορισμό τους ή τη χρήση τους 4) δεν ευθύνεται για οποιοδήποτε ανακριβές ή ασάφειες όσον αφορά τις πληροφορίες που περιέχονται σε αυτόν τον κατάλογο 5) δεν ευθύνεται για τυχόν ζημιές που προκλήθηκαν από την παραλαβή αγαθών με άλλες ιδιότητες από αυτές που παρουσιάζονται στις εικόνες.
II. Παρά τις καλύτερες προσπάθειες της TOYA S.A., δεν μπορεί να εγγυηθεί ότι οι πληροφορίες που περιέχονται σε αυτόν τον κατάλογο ανταποκρίνονται πλήρως στην πραγματικότητα.
III. Όλες οι αποφάσεις που γίνονται με βάση τις πληροφορίες που περιέχονται στον κατάλογο αυτό, λαμβάνονται υπό την ευθύνη του ατόμου που χρησιμοποιεί αυτές τις πληροφορίες.

PT
I. A TOYA S.A. informa que: 1) este catálogo não constitui uma oferta no aceção do direito civil; 2) os artigos apresentados neste catálogo podem de facto diferir do padrão indicado nas figuras, em particular no que diz respeito às características externas, isto é, tamanho, cor e método de embalagem; 3) não se responsabiliza por pequenas diferenças nas propriedades dos artigos que não afetam a finalidade ou o uso pretendidos; 4) não se responsabiliza por imprecisões e divergências quanto às informações contidas no catálogo; 5) não se responsabiliza por nenhum dano causado como resultado do recebimento de mercadorias com outras propriedades do que daquelas apresentadas nas imagens.
II. Apesar dos melhores esforços por parte da TOYA S.A., a empresa não pode garantir que as informações contidas neste catálogo correspondam totalmente à realidade.
III. Todas as decisões tomadas com base nas informações contidas neste catálogo são tomadas por conta e risco da pessoa que usa tais informações.

ZH
一、TOYA S.A. 客户须知: 1) 本目录不构成民事合约; 2) 本目录中的产品图片可能与实际存在差异, 尤其是外观、尺寸、颜色、包装; 3) 对于一些微小的差异, 在不影响产品的使用的情况下, 公司将不承担责任; 4) 对于目录中出现的信息的非准确性, 公司概不负责; 5) 对于因产品属性与目录中工具不精确而造成的任何损坏, 公司概不负责。
二、尽管 TOYA S.A. 做出了所有努力, 但仍不能保证本目录中包含的信息完全符合实际情况。
三、对于根据本目录所包含信息的任何决定, 将由使用上述信息的人承担风险。

TOYA S.A.

ul. Sołtysowicka 13-15
51-168 Wrocław
☎ (+48 71) 32 46 200
fax: (+48 71) 32 46 370
sales@yato.pl (domestic)
export@yato.pl (export)
import@yato.pl (import)

ODDZIAŁ WARSZAWSKI

Teren Mapletree Park Nadarzyn
al. Kasztanowa 160
05-831 Młochów k. Warszawy
☎ (+48 22) 73 82 800
☎ (+48 22) 73 82 828
sales@yato.pl (domestic)
export@yato.pl (eport)

TOYA ROMANIA S.A.

Soseaua Stefanestii 8-8a
077175 Stefanestii De Jos
☎ (+40 031) 710 8692
office@yato.ro

YATO TOOLS (SHANGHAI) Co., Ltd.

No. 1, Lane 1300
East Kangqiao Road
Shanghai, China 201315
☎ (+86 21) 681 829 50
fax: (+86 21) 681 829 51
yato@yato-sh.com

YATO TOOLS (JIAXING) CO., LTD.

No.1033 Huyan Road,
Baibu Town, Haiyan County,
Jiaxing City, Zhejiang Province,
China
☎ (+86 21) 681 829 50
yato@yato-sh.com



V04.24

YOUR TRUSTED SUPPLIER

yatogastro.com